

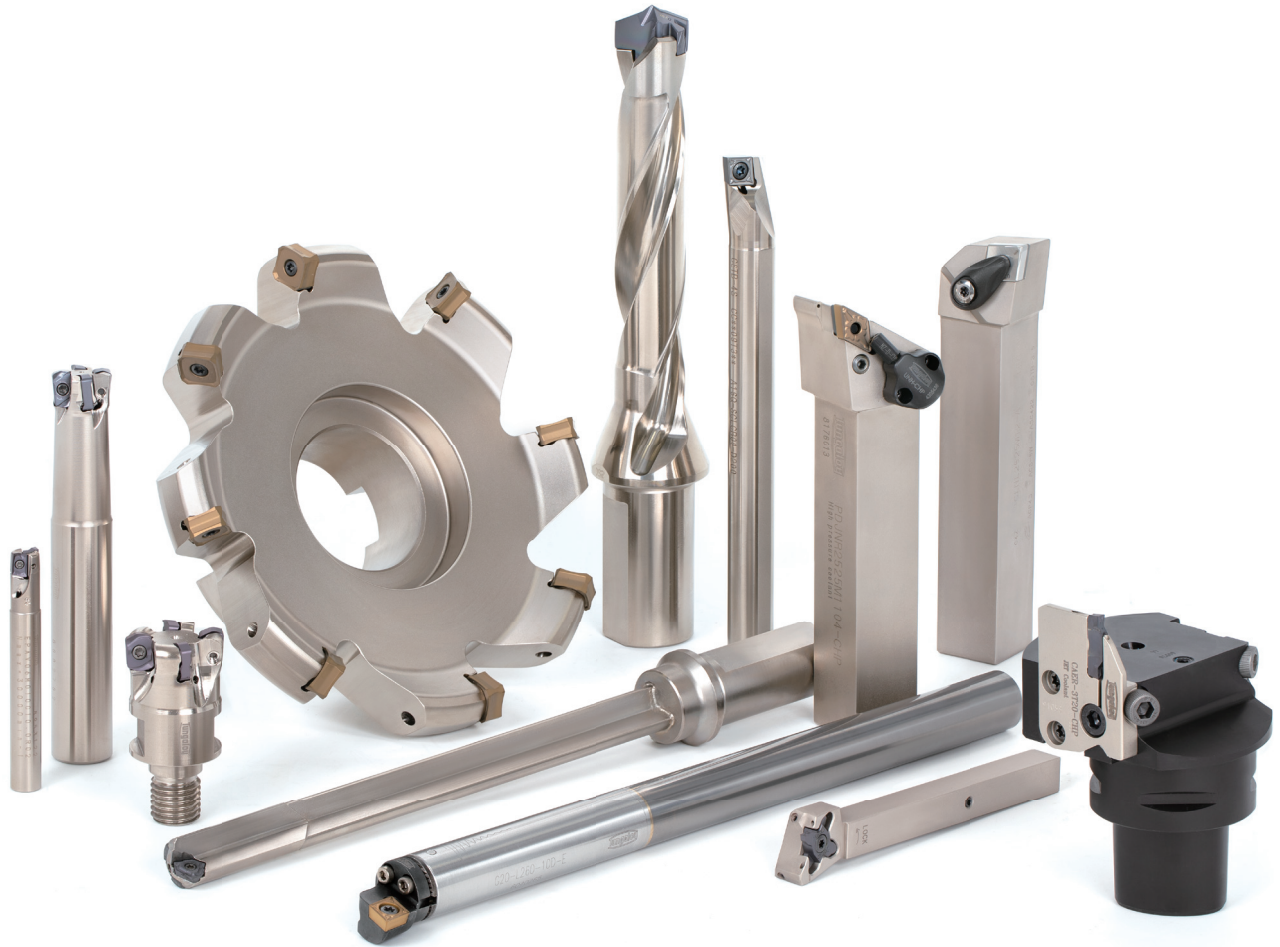

ACCELERATED MACHINING



General Catalog

2021 / 2022

INDUSTRY 4.0
FEED the SPEED!





In an accelerated world, a quick response to market needs is necessary. As a pioneer in innovation, **Tungaloy** leads the market in developing unique and powerful grades and geometries for this new era. TUNGFORCE, our newest line of products is designed for accelerated machining, bringing you the newest and greatest solutions for your machining needs.



2021 / 2022

Full Product Line

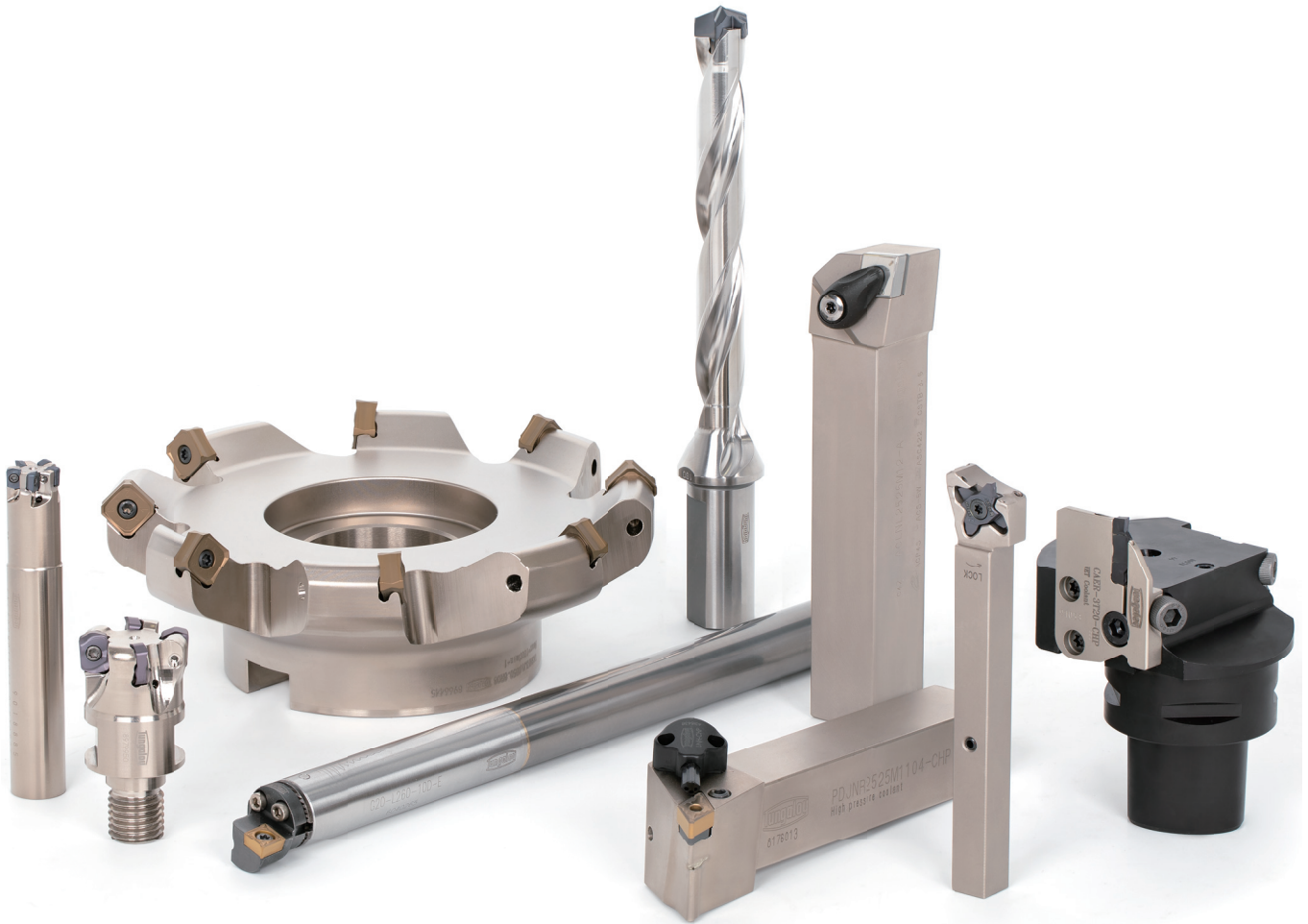

Grade	A
Insert	B
External Toolholder	C
Internal Toolholder	D
Threading Tool	E
Parting, Grooving	F
Miniature Machining	G
Milling Cutter	H
Endmill	I
Drilling Tool	J
Tooling System	K
User's Guide	L
Alphanumeric Index	M

Grade	A
Insert	B
Ext. Toolholder	C
Int. Toolholder	D
Threading	E
Grooving	F
Miniature Tool	G
Milling Cutter	H
Endmill	I
Drilling Tool	J
Tooling System	K
User's Guide	L
Index	M

About Tungaloy Cutting Tool Catalog

Icons at the right / left side of each page

External toolholder (cutting edge shape / angle)

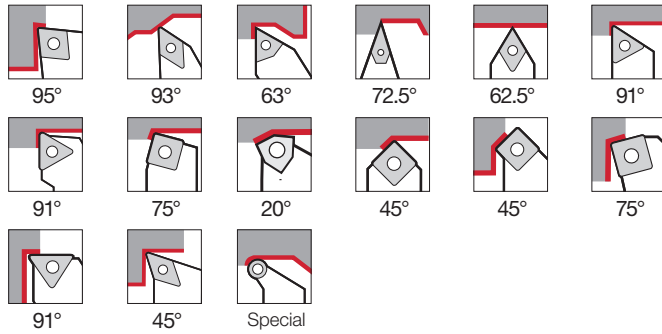

Internal toolholder (cutting edge shape / angle)

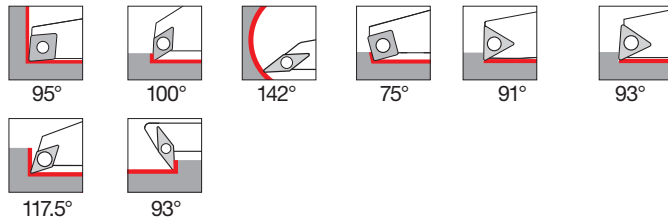

Parting, Grooving

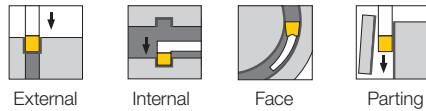

Miniature machining

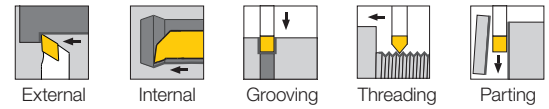

Mill

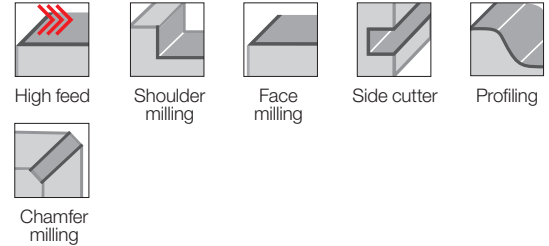

Endmill

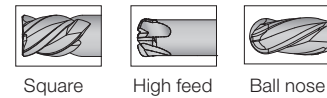

Drill



Icons for applications of each product

Threading

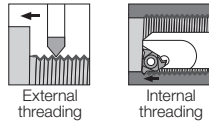

Grooving

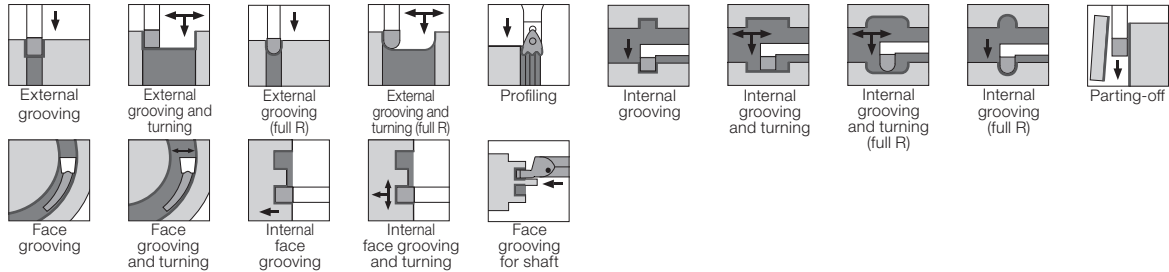

Milling

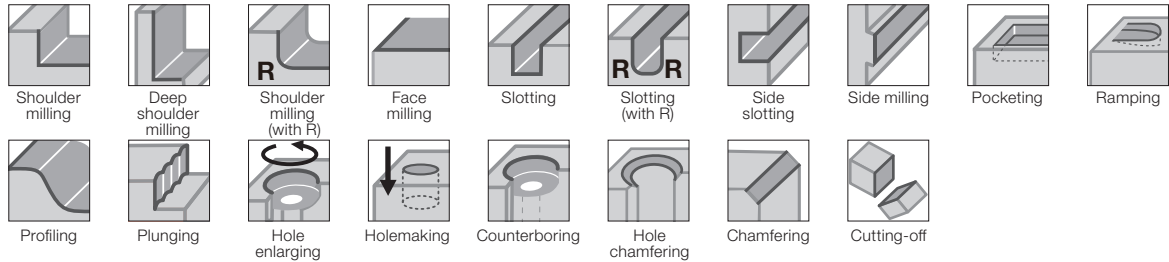

Drilling



About Tunggaloy Cutting Tool Catalog

Note in using this catalog:

- ★ This catalog provides the information of Tunggaloy's cutting tools as of July 2020.
- ★ The specifications are subject to change without prior notice for product improvements. Also, the products may be discontinued in the future due to the development of new products.
- ★ The dimensions of all products are shown in inch (in) and millimeters (mm) where applicable.
- ★ For indexable tools, such as toolholders, cutters, drill bodies, applicable inserts or heads need to be ordered separately.

How to use this catalog:

The diagram illustrates the navigation process in the Tunggaloy catalog:

- 1** Select the tool category at product group index on the right pages.
- 2** Check the tool designation on the page of the tool details.
- 3** Select the tool type at the application index on the left pages.

The left page shows a table of contents with categories A through L. The middle pages show detailed views of two tool types: ISOFLURN ACLNR/L-Eco and ISOFLURN PCLNR/L-CHP-Eco. The right page shows an insert selection interface with various tool options.

- 1 Select the tool category at product group index on the right pages.
 - 2 Check the tool designation on the page of the tool details.
 - 3 Select the tool type at the application index on the left pages.
- *The index is in the alphanumerical order. Use it for your product search.

How to read the list for standard items:

- ★ Designations for indexable tools – toolholders, cutters, drill bodies, etc.
 - Orders are to be received for the tools with the designations in the catalog.
 - For the tool with right- and left-hand options, the designation includes ****R/L**** as shown below.
 - Ex. 1: Designation: A06-SCLCR/L2-D08
You can order both right- and left-hand tools. A06-SCLCR2-D08 (a right-hand tool) and A06-SCLCL2-D08 (a left-hand tool) will be available.
 - Ex. 2: Designation: E05-SEXPR04-D04
You can order only right-hand tools. Please contact us when you need left-hand tools.
- ★ Line up for inserts and solid tools
Blank : Please contact us regarding the product.

About the dimension symbols conforming to ISO13399

What is ISO13399?

ISO13399 is an international standard for the purpose of standardizing the electronic data of tools in the world.

Switching to the dimension symbols conforming to ISO13399

In this catalog, we use the dimension symbols (properties) conforming to ISO13399 international standard. Below are the examples of the change.

Examples of the change:

	Before	After
Insert		
Turning		
Milling		
Drilling		

ISO13399 standardizes not only the format of 2D and 3D CAD data but also the tool dimension symbols (properties) and reference position information. This allows the tool information to be read and combined into NC programs and CAM software, regardless of any tool maker's data. In addition in the General Catalog (paper catalog), we are also updating the symbols in the e-catalog (electronic catalog on our website) to the properties conforming to ISO13399. The e-catalog also provides 2D and 3D CAD data in accordance with ISO13399 standard.

Insert

New symbol	Old symbol	Description
AN	-	Main cutting edge relief angle
APMX	Max. ap	Maximum depth of cut
AS	A	Side cutting edge relief angle
BW	B	Body width
BS	bs	Side cutting edge (wiper) length
CDX	T max	Maximum groove depth
CW	W	Grooving edge width
D1	ød1	Mounting hole diameter
DCONMS	øDs	Mounting part diameter on the machine
DMIN	øDm	Minimum machining diameter
EPSR	-	Nose angle
GAN	-	Rake angle (insert)
IC	ød	Inscribed circle diameter
INSD	A	Insert diameter (round type)
INSL	B	Insert length
KAPR	κ	Approach angle
LBB	-	Chipbreaker width
LE	A	Effective cutting edge length
LF	L1	Standard length
M	m	Distance from inscribed circle to cutting edge (m dimension)
PDX	t	Thread position (X direction)
PDY	ℓ3	Thread position (Y direction)
PNA	θ	Cutting edge angle
PSIRL	θ	Left-hand front cutting edge angle
PSIRR	θ	Right-hand front cutting edge angle
RE	r	Corner radius
S	T	Thickness
W1	-	Insert width

Turning, Grooving

New symbol	Old symbol	Description
B	b	Shank width
BD	øD1, øD2, øD3	Body external diameter
CDX	ar	Maximum groove depth
CND	-	Oil hole diameter
CNT	-	Oil hole plug size
CUTDIA	øDmax	Maximum parting diameter
CW	W	Grooving edge width
CWN	-	Minimum grooving edge width
CWX	-	Maximum grooving edge width
DAXN	øDm	Minimum diameter in face grooving
DAXX	øDmax	Maximum diameter in face grooving
DCONMS	øDs	Mounting part diameter on the machine
DCONWS	øD, ød2	Mounting part diameter on the workpiece
DMIN	øDm	Minimum machining diameter
GAMF	α	Radial rake angle
GAMP	θ	Axial rake angle
H	h	Shank length
HBH	h2	Height of offset on the bottom of head
HBKL	f2	Length of uneven level on the back of head
HBKW	L2	Width of uneven level on the back of head
HBL	L2	Length of offset on the bottom of head
HF	h1	Standard height
KAPR	κ	Approach angle
LB	L	Body length
LF	L1	Standard length
LH	L2	Head length
OAH	h4	Overall height
OAL	L1	Overall length
OAW	L3	Overall width
PSIR	β	Lead angle
WB	-	Body width
WF	f	Standard width
WFS	f2	Standard width (the second corner)

■ Tooling system

New symbol	Old symbol	Description
APMX	Max. ap	Maximum depth of cut
BD	$\varnothing D1, \varnothing D2, \varnothing D3$	Body external diameter
BHTA	α	Neck taper angle (half of nose angle)
BTED	$\varnothing d1$	Taper tip diameter
CRKS	S	Mounting screw size
DBC	$\varnothing d3$	Bolt hole pitch diameter
DCONMS	$\varnothing Ds$	Mounting part diameter on the machine
DCONWS	$\varnothing D, \varnothing d2$	Mounting part diameter on the workpiece
DMIN	$\varnothing Dm$	Minimum machining diameter
GAMF	$\alpha, R.R.$	Radial rake angle
GAMP	$\theta, A.R.$	Axial rake angle
KAPR	κ	Cutting edge angle
LB	L2, L3	Body length
LF	L	Standard length
LPR	L1	Parting length
LS	ls	Shank length
LSC	Lmin	Clamp length
LSCX	Lmax	Maximum clamp length
OAH	H4	Overall height
OAL	L	Overall length
OAW	W	Overall width
THID	-	Mounting screw size
WB	W	Body width
WF	f	Standard width

■ Drilling

New symbol	Old symbol	Description
BD	$\varnothing D1, \varnothing D2, \varnothing D3$	Body external diameter
CND	-	Oil hole diameter
CNT	-	Oil hole plug size
CRKS	S	Mounting screw size
DC	$\varnothing Dc$	Machining diameter
DCONMS	$\varnothing Ds$	Mounting part diameter on the machine
DCONWS	$\varnothing D, \varnothing d2$	Mounting part diameter on the workpiece
DCSFMS	$\varnothing D$	Connecting part diameter
KAPR	κ	Cutting edge angle
LCF	l	Flute length
LF	Lf	Standard length (from the drill shoulder)
LPR	-	Parting length (from flange to tip)
LS	ls	Shank length
LU	l	Machinable depth
NOF	z	Number of flutes
OAL	L	Overall length (from tip)
PL	PL	Distance from drill tip to shoulder
ZEPF	Z eff	Number of effective cutting edges on periphery

■ CAD data provided in e-catalog

● 2D data (DXF format file)

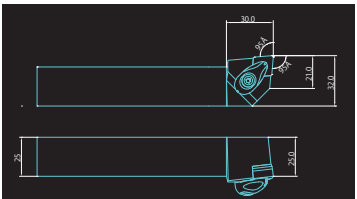

Turning:
Shows the insert with standard corner radius.

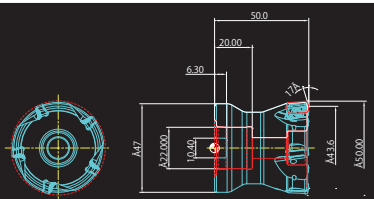

Milling:
Includes actual cutting edge curve (CUT layer) and body cross section (NOCUT layer).

● 3D data Light type (STP format file): Can be used to check tool path and interference.

Turning: Equipped with an insert with a standard corner radius.

Milling: A rotating body model of an actual cutting edge curve and a body cross section.

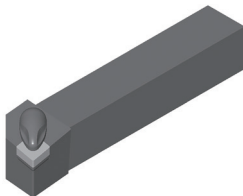

● 3D data Detail type (STP format file): Can be used to create a new tool layout chart. (Can be combined with any insert model on a CAD software.)

Turning

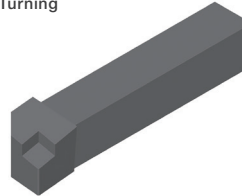

Milling

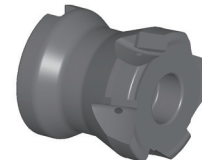

■ Milling

New symbol	Old symbol	Description
APMX	Max. ap	Maximum depth of cut
BD	$\varnothing D1, \varnothing D2, \varnothing D3$	Body external diameter
BHTA	α	Neck taper angle (half of nose angle)
CBDP	l	Mounting hole depth
CDX	Max. ae	Maximum slot width
CHW	k	Chamfer width on the corner
CICT	z	Number of inserts
CRKS	S	Mounting screw size
CW	W	Slotting edge width
CWN	-	Minimum slotting edge width
CWX	-	Maximum slotting edge width
DBC	$\varnothing d3$	Bolt hole pitch diameter
DC	$\varnothing Dc$	Machining diameter
DCONMS	$\varnothing d$	Mounting part diameter on the machine
DCONWS	$\varnothing D, \varnothing d2$	Mounting part diameter on the workpiece
DCSFMS	$\varnothing Db$	Mounting surface diameter on the machine
DCX	$\varnothing Dc1$	Maximum machining diameter
GAMF	R.R.	Radial rake angle
GAMP	A.R.	Axial rake angle
H	T	Width across flat
KAPR	κ	Cutting edge angle
KWW	a	Drive key width
LF	Lf	Standard length
LH	Lf	Neck length
LS	ls	Shank length
NOF	z	Number of flutes
OAL	L, L6	Overall length
PDX	t	Thread position (X direction)
PNA	θ	Cutting edge angle
PSIR	β	Lead angle
RMPX	θ	Maximum ramping angle
THUB	T	Hub height (slot mill)
WT	Kg	Weight
ZEPF	Z eff	Number of effective cutting edges on the periphery

Note:

- Symbols unspecified in ISO13399 standard and Tungaloy's original symbols are not included.
- The symbols still under discussion are included. Please note any change or addition may occur.

Grade

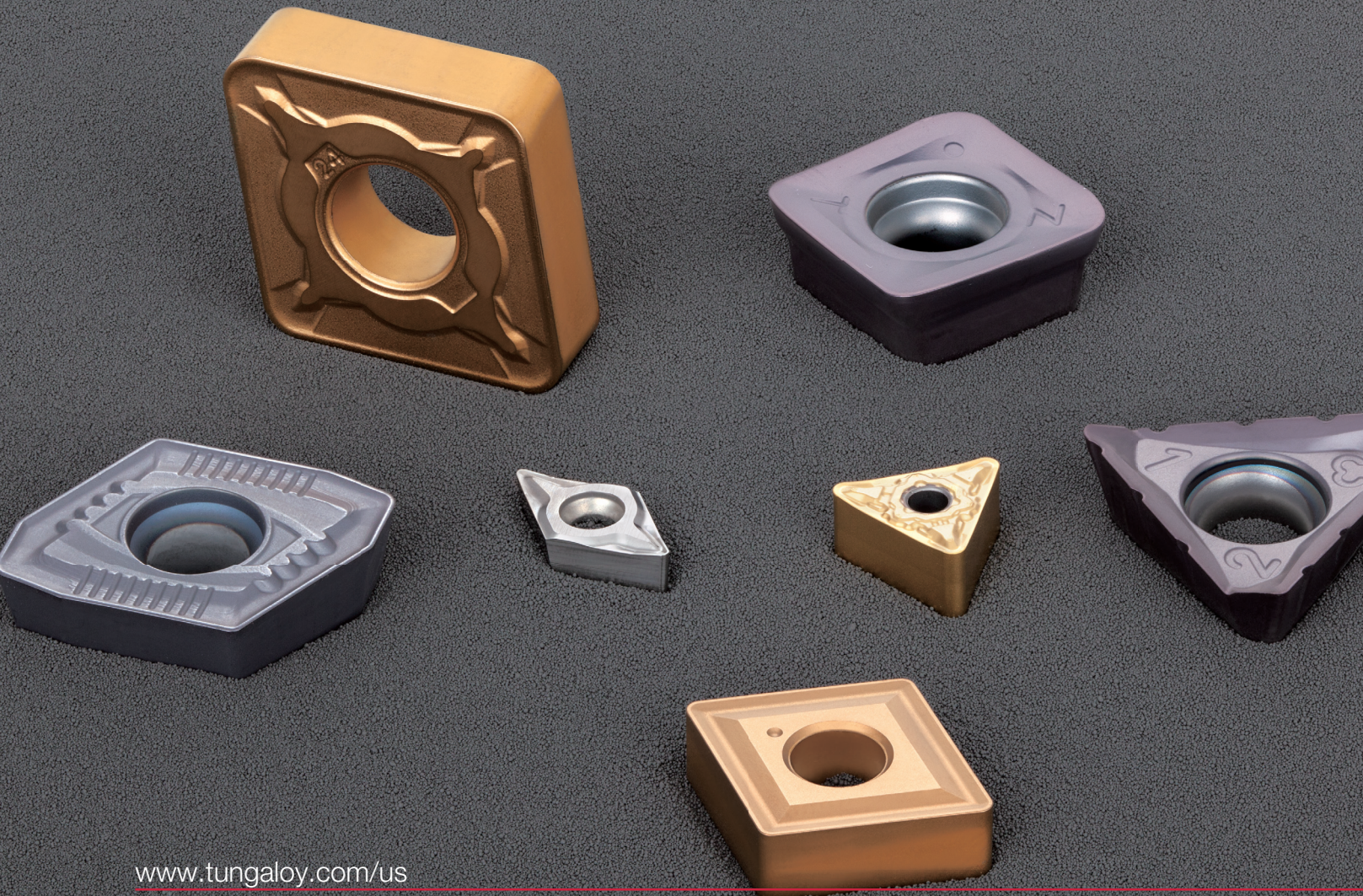

Grade

Coated Grade CVD

A002

Coated Grade PVD

A003

Ceramic

A005

Cermet

A005

CBN (T-CBN)

A006

PCD (T-DIA)

A007

Uncoated Cemented Carbide

A007

Product comparison by workpiece material

A008

Product comparison by chipbreaker

A020

CVD - Coated Grade

Grade	Coating		Application	Feature	Turning	Grooving	Milling	Drilling
	Main composition	Thickness / μm						
New T9205 P01 - P10 K10 - K20	Ti compound +Al ₂ O ₃	18	P K	- High wear resistance - Excellent performance in high-speed cutting				
New T9215 P10 - P20	Ti compound +Al ₂ O ₃	18	P M K	- Well-balanced between wear and chipping resistance - First choice for steel - High versatility for a wide range of applications				
New T9225 P15 - P25	Ti compound +Al ₂ O ₃	18	P	- First choice for roughing to medium cutting - High fracture resistance				
New T9235 P30 - P40	Ti compound +Al ₂ O ₃	18	P	- High fracture resistance in heavy interrupted cutting				
T9105 P01 - P10 K10 - K20	TiCN-Al ₂ O ₃	16	P K	- High wear resistance - Excellent performance in high-speed cutting				
T9115 P10 - P20 K15 - K30	TiCN-Al ₂ O ₃	16	P K	- Good balance between wear and chipping resistance - Suitable for a wide range of applications				
T9125 P20 - P30	TiCN-Al ₂ O ₃	16	P	- High chipping resistance in light to medium interrupted cutting				
T9135 P30 - P40	TiCN-Al ₂ O ₃	16	P	- High fracture resistance in heavy interrupted cutting				
T6120 P10 - P20 M10 - M20	TiCN	6	M	- Excellent wear resistance in high-speed continuous cutting				
T6130 P15 - P30 M15 - M30	TiCN	6	M	- High wear resistance in cutting at medium to high speed - First choice for stainless steel				
T515 K10 - K20	TiCN-Al ₂ O ₃	16	K	- High wear resistance even in high-speed machining - First choice for roughing cast iron				
T5105 K05 - K15	TiCN-Al ₂ O ₃	16	K	- High resistance to wear and plastic deformation in high-speed continuous cutting				
T5115 K10 - K20	TiCN-Al ₂ O ₃	16	K	- Stable machining in a wide range of applications from continuous to interrupted cutting				
T5125 K15 - K30	TiCN-Al ₂ O ₃	16	K	- Toughness to prevent sudden fracture - Ideal for heavy interrupted cutting				
T313V -	TiCN-Al ₂ O ₃	3	Threading	- High resistance to plastic deformation				
New T3225 P20 - P35 M20 - M35	TiCN-Al ₂ O ₃	10	P M	- High chipping and fracture resistance - Suitable for milling steel and stainless steel				
T3130 P20 - P40 M20 - M40	TiCN-Al ₂ O ₃	6	P M	- Good balance between wear and chipping resistance - Suitable for milling steel and stainless steel				
New T1215 K10 - K25	TiCN-Al ₂ O ₃	10	K	- Good balance between wear and chipping resistance - Suitable for milling cast iron				
T1115 K10 - K25	TiCN-Al ₂ O ₃	11	K	- High wear resistance - Suitable for milling cast iron				

PVD - Coated Grade

Grade	Coating		Application	Feature	Turning	Grooving	Milling	Drilling
	Main composition	Thickness / μm						
AH110 P05 - P15 M05 - M15 K10 - K25 S05 - S15	(Ti, Al)N	3	P M K S	- High wear resistance - Suitable for finishing steel, cast iron, and difficult-to-cut material				
AH120 P15 - P25 M15 - M25 K15 - K30 S10 - S25	(Ti, Al)N	3	P M K S	- Good balance between wear and fracture resistance - Suitable for machining steel, stainless steel, and cast iron under general cutting conditions				
AH130 P25 - P40 M25 - M40	(Ti, Al)N	3	P M	- High chipping and fracture resistance - Designed for machining austenitic stainless steel under general cutting conditions				
AH140 M30 - M45	(Ti, Al)N	3	M	- High fracture resistance - Suitable for milling stainless steel				
AH170 P20 - P35 M20 - M35 K15 - K30	(Ti, Al)N	3	P M K	- High wear resistance - Designed for drilling carbon steel and cast iron				
AH180 P20 - P35 M20 - M35 K15 - K30	(Ti, Al)N	3	P M K	- High wear resistance - Designed for drilling carbon steel, cast iron, and stainless steel				
AH330 P15 - P30	(Ti, Al)N	3	P	- Excellent wear resistance				
AH630 P15 - P30 M15 - M30	(Ti, Al)N	5	M P	- Good resistance to wear and fracture in machining stainless steel at low to medium cutting speed				
AH645 P30 - P40 M30 - M40	(Ti, Al)N	5	M P	- High fracture resistance in machining stainless steel				
AH710 P05 - P15 K05 - K15 H05 - H15	(Ti, Al)N	3	P K H	- High wear resistance - Suitable for finishing cast iron and high-hardened steel				
AH725 P15 - P30 M15 - M30 K25 - K30 S15 - S25	(Ti, Al)N	2	P M K S	- Good balance between wear and chipping resistance - Suitable for machining steel and stainless steel under general cutting conditions				
New AH7025 P20 - P30 M20 - M30 S15 - S25	(Ti, Al)N	3.5	P M S	- Excellent wear resistance and high rigidity - First choice for grooving of various materials				
AH730 P15 - P30	(Ti, Al)N	3	P	- Good balance between wear and fracture resistance				
AH740 P25 - P40	(Ti, Al)N	3	P	- Excellent chipping resistance in machining steel				
AH750 H15 - H30	(Ti, Al)N	3	H	- High wear resistance - Designed for milling high-hardened material				
AH8005 M01 - M10 S01 - S10	(Al,Ti)N	3.5	M S H	- Good resistance to wear and adhesion - Excellent performance in machining heat-resistant alloy at high speed				
AH8015 M10 - M20 S10 - S20	(Al,Ti)N	3.5	S M H P K	- Good balance between wear and fracture resistance - First choice for machining heat-resistant alloy under general cutting conditions				
AH905 S01 - S10	(Al, Ti)N	1.5	S	- High resistance to wear and built-up edge				

Grade
Insert
Ext. Toolholder
Int. Toolholder
Threading
Grooving
Miniature Tool
Milling Cutter
Endmill
Drilling Tool
Tooling System
User's Guide
Index



PVD - Coated Grade

Grade	Coating		Application	Feature	Turning	Grooving	Milling	Drilling
	Main composition	Thickness / μm						
AH3225 P20 - P35 M20 - M35 New	(Ti, Al)N	5	P M	- Good balance between wear and fracture resistance - Suitable for steel and stainless steel				
AH3035 P20 - P45 H20 - H30	(Ti, Al)N	5	P H	- Good balance between wear and chipping resistance - Suitable for machining high-hardened steel at high feed				
AH3135 P30 - P40 M30 - M40	(Ti, Al)N	4	P M	- High fracture resistance - Suitable for machining steel and stainless steel under general cutting conditions				
AH4035 M30 - M45	(Ti, Al)N	5	M	- Good balance between wear and fracture resistance - Suitable for difficult-to-cut stainless steel				
AH6030 M25 - M35 S15 - S30	(Ti, Al)N	5	M S	- High fracture resistance - Suitable for drilling stainless steel and heat-resistant alloy under general cutting conditions				
AH9030 P15 - P35 K10 - K25	(Ti, Al)N	5	P K	- High wear resistance - Suitable for drilling steel and cast iron at high speed				
AH9130 P15 - P35 M25 - M35 K10 - K25 S15 - S30 New	(Ti, Al)N	4.5	P M K S	- High wear resistance - Designed for drilling various materials				
SH725 P20 - P30 M20 - M30	(Ti, Al)N	2	P M	- High wear resistance - Designed for machining steel and stainless steel				
SH730 P20 - P35 M20 - M35 S05 - S15	(Ti, Al)N	1	P M S	- High wear resistance - Designed for machining steel, stainless steel, and difficult-to-cut material				
GH110 K10 - K25 N05 - N15	Ti(C, N, O)	3	P M K N S	- High wear resistance				
GH130 P25 - P40 M25 - M40 K25 - K40	Ti(C, N, O)	3	P M K	- High chipping and fracture resistance - Suitable for steel, stainless steel, and cast iron				
GH330 P15 - P30 M15 - M30 K05 - K30	Ti(C, N, O)	3	P M K	- High resistance to wear and fracture - Suitable for continuous to medium interrupted cutting				
GH730 P20 - P35 M20 - M35 K20 - K30	Ti(C, N, O)	3	P M K	- High wear resistance - Suitable for turning and grooving at low speed				
J740 -	TiN	1	For small lathes	- Ultra-fine-grain cemented carbide coated with TiN-based compound				
YH170 P20 - P35 M20 - M35	Ti(C, N)	1.5	P M	- High resistance to wear and fracture - Designed for drilling carbon steel and stainless steel				
YH180 P20 - P35 M20 - M35	Ti(C, N)	1.5	P M	- High wear resistance - Designed for drilling carbon steel and stainless steel				
JM10 P20 - P35 M20 - M35	TiN	1	P M	- High wear resistance - Designed for drilling carbon steel and stainless steel				
DS1100 N05 - N20	DLC coating	Thin layer	N	- High wear resistance - Suitable for finishing aluminum				
DS1200 N10 - N25	DLC coating	Thin layer	N	- Good balance between wear and chipping resistance - Suitable for semi-finishing to finishing of aluminum				

Ceramic

Grade	Hardness (HRA)	Application	Feature	Grade			
				Turning	Grooving	Milling	Drilling
LX11	94.0	H - Alumina base - Excellent chipping resistance in continuous cutting of cast iron					
New TZ120	93.0	K - Alumina zirconia based - Excellent wear resistance for high-speed machining of cast iron					
LX21	94.0	K - Alumina base - Suitable for continuous cutting of high-hardened material					
FX105	93.0	K - Silicon nitride base - Suitable for high-speed machining of cast iron					
CX710	92.9	K - Silicon nitride base - Suitable for high-speed machining of cast iron					
TW43	94.0	S - Whisker-reinforced Al ₂ O ₃ ceramic for super alloy machining.					
New TS200	93.1	S - SiAlON ceramic for super alloy semi finish machining					
New TS300	94.3	S - SiAlON ceramic for super alloy rough machining					
New FX510	94.0	S K N - Sialon base - Suitable for heat-resistant alloy, such as nickel-based alloy					

Cermet

Grade	Coating		Application	Feature	Grade			
	Main composition	Thickness / μm			Turning	Grooving	Milling	Drilling
New AT9530	(Ti,Al)N laminated coating	3	P - High wear resistance - First choice for machining alloy steel					
GT9530	Ti(C, N, O)	3	P K - High wear resistance - Excellent surface quality in finishing					
J9530	TiN	1	For Swiss lathes - Suitable for small-part machining					
NS9530	Uncoated	-	P K - High fracture resistance - Suitable for finishing to medium cutting of steel					
NS740	Uncoated	-	P - High resistance to fracture and thermal crack - High-rigidity grade for milling					
NS520	Uncoated	-	P K - High wear resistance					
GT720	Ti(C, N, O)	3	P K - High wear resistance in face milling at high speed					
X407	Uncoated	-	P - High wear resistance in finishing with dry cutting					
N308	Uncoated	-	P - High wear resistance					

Grade
Insert
Toolholder
Ext. Toolholder
Int. Toolholder
Threading
Grooving
Miniature Tool
Milling Cutter
Endmill
Drilling Tool
System
Tooling System
User's Guide
Index



Grade	Hardness (Hv)	T.R.S. (GPa)	Applica-tion	Feature	Turning	Grooving	Milling	Drilling
New BXA10	3200 ~ 3400	1.00 ~ 1.10	H	- Coated T-CBN for excellent performance in continuous cutting of hardened steel	█			
BXA20	3300 ~ 3500	1.30 ~ 1.50	H	- Coated T-CBN for excellent performance in machining hardened steel	█			
BXM10	2700 ~ 2900	0.80 ~ 0.90	H	- Coated T-CBN for excellent performance in high-speed continuous cutting of hardened steel	█			
BXM20	3500 ~ 3700	1.35 ~ 1.50	H	- Coated T-CBN for machining hardened steel in a wide range of application area	█			
BXC50	3500 ~ 3700	1.15 ~ 1.30	H	- Coated T-CBN with high fracture resistance in continuous to interrupted cutting	█			
BX310	2700 ~ 2900	0.80 ~ 0.90	H	- High wear resistance - Designed for high-speed continuous cutting of hardened steel	█			
BX330	2800 ~ 3000	0.85 ~ 0.95	H	- Excellent sharpness - Designed for finishing hardened steel	█			
BX360	3200 ~ 3400	1.00 ~ 1.10	H	- Suitable for general machining of hardened steel	█	█		
BX380	3500 ~ 3700	1.15 ~ 1.30	H	- High fracture resistance - Designed for heavy interrupted cutting of hardened steel	█			
BX530	2800 ~ 3000	0.85 ~ 0.95	H	- Designed for finishing hardened steel with good surface quality	█			
BXC90 (BX90S)	3900 ~ 4100	1.80 ~ 1.90	K	- Coated T-CBN for high-speed machining of cast iron	█		█	
BX910	2600 ~ 2800	0.80 ~ 0.90	K	- Excellent wear resistance in high-speed machining - Designed for centrifugally cast iron	█		█	
BX930	3000 ~ 3200	0.95 ~ 1.20	K	- Designed for ductile cast iron	█			
BX850	3300 ~ 3500	0.75 ~ 0.85	H	- High fracture resistance - Good performance in high-speed face milling			█	
BX870	3000 ~ 3200	0.95 ~ 1.20	K	- High wear resistance - Designed for centrifugally cast iron	█		█	
BX470	4100 ~ 4300	1.90 ~ 2.10	Sintered metal K	- Excellent sharpness - Suitable for ferrous sintered metal	█			
BX480	4100 ~ 4300	1.90 ~ 2.10	Sintered metal K	- Hardest T-CBN - Ideal for ferrous sintered metal - Suitable for high-speed face milling of cast iron	█		█	
New BX815	3000 ~ 3200	1.00 ~ 1.10	S	- High wear resistance and thermo stability - Suitable for high-speed machining of Inconel	█			

PCD (T-DIA)

Grades	Grain size (µm)	Hardness (Hv)	T.R.S. (GPa)	Application	Feature	Turning	Grooving	Milling	Drilling
New DX110	< 1	8500	1.8	N - Excellent sharpness for high surface quality - Suitable for finishing non-ferrous metal and nonmetal					
DX120	4.5	9000	1.8	N - Suitable for finishing non-ferrous metal and nonmetal					
DX140	12.5	10000	1.7	N - High wear resistance - Designed for non-ferrous metal and nonmetal					
DX160	28	11000	1.6	N - Designed for ceramic, cemented carbide, and nonmetal					
DX180	45	12000	1.5	N - High wear resistance - Designed for ceramic, cemented carbide, and nonmetal					

Uncoated Cemented Carbide

Grades	Hardness (HRA)	T.R.S. (GPa)	Application	Turning	Grooving	Milling	Drilling
UX30 P30 M30	91.1	2.3	P M				
TH10 P10 M10 K10 N10	92.0	2.4	P M K N				
KS05F K05 S05 N05	93.0	2.9	K S N				
KS15F N15	91.5	3.0	N				
KS20 K20 N20 S20	90.8	2.8	K S N				
TH03 P05 M05 K05 N05	93.8	1.9	P M K N				
F	93.4	2.5	P K				
EM10 P10 - P25 K10 - K25	91.5	3.4	P K				

Grades	Hardness (HRA)	T.R.S. (GPa)	Application	Turning	Grooving	Milling	Drilling
UM K10 - K25 N10 - N25	90.9	3.5	K N				
G2 K10 - K25 N10 - N25	90.8	2.7	K N				
G1F P10 - P25 K10 - K25	92	2.6	P K				
MD10 P10 - P25 M10 - M25	92.8	3.4	P M				
MD20 P20 - P35 M20 - M35	91.5	3.9	P M				

Grade
Insert
Toolholder
Ext. Toolholder
Int. Toolholder
Threading
Grooving
Miniature Tool
Milling Cutter
Endmill
Drilling Tool
Tooling System
User's Guide
Index



User's Guide- Grade Comparison Chart

●CVD Coated Grades for Turning

ISO		Tungaloy	Mitsubishi Carbide	Sumitomo Electric	Sandvik	Kyocera	Mitsubishi Hitachi Tool	Dijet	NTK	Seco Tools	Kennametal	Iscar	TaeguTec	Widia	Walter	Ceratizit
Classification	Symbol															
P	P01	T9205 T9105	UE6105	AC810P	GC4305	CA510	HG8010	JC110V		TP0500 TP0501	KCP05	IC8150 IC9150 IC9015	TT8115	TN10P TN20K	WPP01 WPP05 WPP05S	
	P10	T9205 T9105 T9225 T9115	UE6105 MC6015	AC810P AC8015P	GC4305 GC4315	CA515	HG8010 GM8020	JC110V JC215V	CP7 CP5	TP0500 TP1500 TP0501 TP1501	KCP10	IC8150 IC9150 IC8080 IC9080 IC9015	TT8115	TN10P TN20K WP15CT	WPP05 WPP10 WAK20 WPP05S WPP10S	CTC3110 CTCK120
	P20	T9215 T9115 T9225 T9125	MC6015 MC6025	AC8015P AC8025P	GC4315 GC4325	CA515 CA525 CA025P	HG8025 GM8020 GM25	JC110V JC215V	CP7 CP5	TP1500 TP2500 TP1501 TP2501	KCP25	IC8150 IC9150 IC9015 IC8250 IC9250	TT8125 TT5100	TN10P TN15M WP25CT	WPP20 WPP20S	CTCP115 CTCP125 CTC1425
	P30	T9225 T9125 T9235 T9135 T6130	MC6025 MC6035	AC8025P AC8035P	GC4325 GC4335	CA530 CA025P	HG8025 GM8035 GM25	JC215V JC325V		TP2500 TP3500 TP2501 TP3501	KCP30	IC8080 IC656 IC9350	TT8125 TT5100 TT8135	TN30P TN30M WP35CT	WPP30 WAK30 WPP30S	CTCP125 CTC1425 CTC1135 CTC1435 CTC2135
	P40	T9235 T9135 T6130	MC6035	AC8035P AC630M	GC4335	CA530	GM8035 GX30	JC325V		TP3500 TP3501	KC9140 KC9240 KCP40	IC9350 IC635	TT8135 TT7100	TN30P TN30M	WPP30 WAK30 WPP30S	CTC1135 CTC1435 CTC2135
M	M10	T9215 T9115	MC7015	AC6020M	GC2015	CA6515		JC110V			KCM15	IC9250 IC520M	TT9215	TN15M WM15CT		CTCP115
	M20	T6120 T9215 T9115	MC7015 MC7025	AC6020M	GC2015 GC2025	CA6525	HG8025 GM25	JC110V		TM2000	KCM15 KCM25	IC9025 IC9350 IC4050	TT9215 TT9225	TN15M WM25CT		CTC1425 CTCP125 CTC1135
	M30	T6130	MC7025	AC6030M	GC2025	CA6525	GM8035 GM25 GX30	JC215V		TM2000 TM4000	KCM25 KCM35	IC9350 IC4050 IC635	TT9225 TT9235	TN30M WM35CT		CTC1435 CTC2135
	M40						GX30			TM4000	KCM35	IC635	TT9235			
K	K01	T5105	MC5005		GC3205	CA310	HX3505	JC050W JC105V	CP1	TK0501	KCK05	IC8080		WK05CT		
	K10	T5105 T515 T5115 T9215	MC5015	AC4010K	GC3210	CA315	HX3515 GM10 HG8010	JC105V JC110V	CP1	TK1501	KCK05 KCK15	IC9150 IC5100 IC4100	TT7005	WK05CT	WKK10S	CTC3110 CTC1425
	K20	T515 T5115 T5125 T9215	MC5015	AC4015K AC420K	GC3225	CA320	HX3515 GM8020	JC110V JC215V	CP1	TK2001	KCK15 KCK20	IC9150 IC5100 IC4100 IC9080	TT7310	WK20CT	WKK20S	CTC1435 CTCK120 CTCP115
	K30	T5125					HG8025	JC215V				IC520M IC4050		WKP30S	CTCP125	

Note: The above table is selected from a publication. We have not obtained approval from each company.

User's Guide- Grade Comparison Chart

Grade

A

Insert

B

Toolholder

C

Ext. Toolholder

D

Int. Toolholder

E

Threading

F

Grooving

G

Miniature Tool

H

Milling Cutter

I

Endmill

J

Drilling Tool

K

Tooling System

L

Index

M

●PVD Coated Grade for Turning

ISO		Tungaloy	Mitsubishi Carbide	Sumitomo Electric	Sandvik	Kyocera	Mitsubishi Hitachi Tool	Dijet	NTK	Seco Tools	Kennametal	Iscar	TaeguTec	Widia	Walter	Ceratizit
Classification	Symbol															
P	P01					PR1005									WXN10	
	P10	AH710	VP10RT		GC1525	PR930 PR1005 PR1115 PR1215 PR1425	IP2000	JC5003 JC5030	VM1 DT4 DM4	TS2000 CP200	KC5010 KC5510 KCU10	IC507 IC807 IC907		WS10PT	WSM10 WSM21	
	P20	AH120 AH725 AH730 SH725 SH730 J740	VP10RT VP15TF VP20MF VP20RT UP20M	AC520U	GC1525 GC1125	PR930 PR1025 PR1115 PR1215 PR1425 PR1225	IP2000 IP3000	JC5030 JC5040	VM1 DT4 DM4	TS2500 CP200	KC5025 KC5525 KCU25	IC507 IC807 IC907	TT9030	WS10PT WS25PT	WSM20 WSM21	
	P30	AH120 AH725 AH7025 SH725 AH730 SH730 GH730 GH330 J740	VP15TF VP20MF VP20RT UP20M	AC530U	GC1125	PR1025 PR1225	IP3000	JC5040	DT4 DM4 QM3	CP500	KC5025 KC5525 KCU25	IC328 IC928 IC3028	TT9030 TT8020	WS25PT	WSM30	CTP1235 CTP1625 CTP2235
	P40	AH120 AH725 AH645		AC530U						CP500		IC328 IC3028	TT8020			CTP1235 CTP2235
M	M01											IC520			WXM10	
	M10	AH8005 AH630	VP10RT		GC1105 GC1115 GC1525	PR1025 PR1215	IP100S IP050S	JC5003 JC8015	TM4 ZM3	TS2000 TS2500 CP200	KC5010 KC5510 KCU10	IC520 IC507 IC807 IC907		WS10PT	WSM10 WSM10S	
	M20	AH8015 AH630 AH120 AH7025 AH725 SH725 SH730	VP10RT VP15TF VP20MF VP20RT UP20M	AC520U	GC1115 GC1125 GC1525	PR930 PR1025 PR1125 PR1215 PR1425 PR1225	IP100S IP050S	JC5015 JC5030 JC8015	TM4 ZM3 DT4 DM4	TS2500 CP200 CP500	KC5025 KC5525 KCU25	IC520 IC507 IC807 IC907 IC308 IC3028	TT9030 TT8010	WS10PT WS25PT	WSM20 WSM21 WSM20S	CTP1235 CTP2120
	M30	AH645 AH120 AH725 SH725 SH730 J740	VP15TF VP20MF VP20RT UP20M MP7035	AC530U AC1030U AC1030U	GC1125 GC2035	PR1125	IP100S	JC5015 JC5030 JC5040	TM4 ZM3 DT4 DM4	CP500	KC5025 KC5525 KCU25	IC3028 IC308 IC908 IC928	TT8020	WS25PT	WSM30 WSM30S	CTP1235 CTP2120 CTP2235 CTP1625
	M40	AH645	MP7035	AC530U AC6040M	GC2035							IC228 IC328				
K	K01	AH110										IC910				
	K10	AH110 GH110 AH110	VP10RT	AC510U		PR905 PR1215		JC5003 JC5015		TS2000 CP200	KC5010 KC5510 KCU10	IC910 IC308 IC508	TT9030	WS10PT		CTP6215
	K20	AH120 AH7025	VP10RT VP20RT VP15TF			PR905 PR1215		JC5015		TS2500 CP200 CP250	KC5025 KC5525 KCU25	IC910 IC308 IC508 IC928 IC1008	TT9030	WS10PT WS25PT		CTP6215
	K30	AH120 GH130	VP20RT VP15TF							CP500		IC928 IC1008	TT9030	WS25PT		CTP1625
S	S01	AH8005	VP05RT MP9005					JC8003							WSM10	
	S10	AH8005 AH8015	VP10RT MP9015	AC510U AC520U AC5015S	GC1105	PR1305 PR1310		JC8015 JC5015	DT4 DM4	TS2000 TS2500 CP200 CP500	KC5010 KC5510 KCU10	IC507 IC807 IC808 IC907 IC908	TT8010	WS10PT	WSM10 WSM10S	CTP2235
	S20	AH8015 AH7025	VP15TF MP9015 VP20RT	AC520U AC1030U AC5025S	GC1115 GC1125	PR1310		JC8015 JC5015	DT4 DM4	TS2000 TS2500 CP200 CP500	KC5025 KC5525 KCU25	IC507 IC807 IC808 IC907 IC908	TT8020	WS10PT WS25PT	WSM20 WSM21 WSM20S	CTP2235
	S30	AH630 AH7025	VP15TF VP20RT	AC520U AC5025S	GC1125	PR1325						IC830 IC928		WS25PT	WSM30 WSM30S	

Note: The above table is selected from a publication. We have not obtained approval from each company.

User's Guide- Grade Comparison Chart

●Cermet for Turning

ISO		Tungaloy	Mitsubishi Carbide	Sumitomo Electric	Sandvik	Kyocera	Mitsubishi Hitachi Tool	Dijet	NTK	Seco Tools	Kennametal	Iscar	TaeguTec	Widia	Walter	Ceratizit	
Classification	Symbol																
P	P01	NS520	AP25N VP25N	T110A T1000A		TN30 PV30 TN6010 PV7010		LN10	Q15 C7Z		KT1120		PV3010 CT3000				
	P10	AT9530 GT9530 J9530	AP25N VP25N NX2525	T1500Z T2000Z T1200A T1500A	CT5015	TN60 TN6010 PV7010 TN610 PV710	CZ25	CX50 PX75	C7Z Z15	TP1020 C15M	KT315	IC30N IC530N	PV3010 CT3000	TTI15	WCE10	TCC410 TCM10 TCM407	
	P20	AT9530 GT9530 NS9530 J9530	AP25N VP25N VP45N NX2525 NX3025	T1200A T1500A T1500Z T2000Z	CT5015 GC1525	TN90 TN6020 PV7020 PV7025 TN620 PV720	CZ25 CH550	CX75 PX75 PX90	C7Z T15	TP1020 TP1030 C15M	KT5020	IC30N IC530N	PV3010 CT3000	TTI15	WCE10	TCC410 TCM10	
	P30	NS9530	VP45N NX4545	T3000Z	GC1525			PX90	N40 C7X								
M	M10	NS520	AP25N VP25N NX2525	T1000A T2000Z	CT5015	TN60 TN6020 PV7020 PV7025		LN10 CX50	C7Z C7X	TP1020 TP1030	KT315 KT5020		PV3010 CT3000	TTI15		TCC410 TCM10 TCM407	
	M20	AT9530 GT9530 NS9530 J9530	NX2525 AP25N VP25N	T1500A T2000Z	GC1525	TN90 TN6020 PV7020 PV7025	CZ25 CH550	CX75	C7Z C7X	C15M	KT5020	IC30N IC530N	PV3010 CT3000				
	M30	NS9530	NX4545	T3000Z													
K	K01	NS520	AP25N VP25N	T1000A		TN30 PV30 PV7005		LN10					PV3010 CT3000			TCC410	
	K10	AT9530 GT9530 NS9530 J9530	AP25N VP25N NX2525	T1500A T2000Z	CT5015	TN60 TN6010 PV7005 PV7010	CZ25 CH550	LN10 CX75				KT315 KT5020	IC30N IC530N	CT3000	TTI15		TCC410 TCM10 TCM407
	K20	NS9530	AP25N VP25N NX2525	T3000Z				CX75			KT5020					TCM407	

Note: The above table is selected from a publication. We have not obtained approval from each company.

User's Guide- Grade Comparison Chart

●Cemented Carbide for Turning

ISO		Tungaloy	Mitsubishi Carbide	Sumitomo Electric	Sandvik	Kyocera	Mitsubishi Hitachi Tool	Dijet	NTK	Seco Tools	Kennametal	Iscar	Ingersoll	TaeguTec	Widia	Walter	Ceratizit
Classification	Symbol																
P	P01																
	P10	TH10		ST10P			WS10	SRT			P10	IC70		P10	TN15U		
	P20	KS20	UTi20T	ST20E	SMA H10F		EX35	SRT SR20	KM1	S10M	K125M TTM	IC70	P40	P20	TN15U		
	P30	KS15F UX30	UTi20T	A30 A30N	SM30 H10F	PW30	EX40	DX30 SR30	KM3	S25M	GK K600 TTR	IC28 IC54	P40	P30			S40T
	P40	TX40		ST40E			EX45	SR30		S60M	G13	IC28 IC54		P40			S40T
M	M01																
	M10	TH10		U10E EH510	H10A		WA10B	UMN	KM1	890	K313	IC20		M10	TN15U WU10HT		
	M20	KS20	UTi20T	U2 EH520	H13A		EX35	DX25 UMS		HX 883	K68 KMF K125M TTM	IC20	IN30M	M20	TN15U WU10HT		CTW7120 H210T
	M30	UX30	UTi20T	A30 A30N	H10F SM30		EX45	UMS			GK K600 TTR	IC28	IN30M				
	M40	TU40						UM40			G13	IC28	IN30M	M40			S40T
K	K01	KS05F	HTi05T	H2 H1			WH01 WH05	KG03			K605			UF1	TN15U WU10HT		
	K10	TH10	HTi10	H1 EH10 EH510	H10	KW10	WH10	KG10 KT9 CR1	KM1	890	K313 K110M THM THM-U	IC20 IC09T	IN05S	K10	TN15U WU10HT		H210T H216T H10T
	K20	KS15F KS20	UTi20T	G10E EH20 EH520	H13A H10F	KW10 GW15	WH20	KT9 CR1 KG20 FB15		890 HX 883	K715 KMF K600	IC20 IC09T	IN05S IN10K IN15K IN30M	K20	TN15U WU10HT		CTW7120 H210T H216T H10T
	K30		UTi20T	G10E	H13A H10F	GW25		KG30		883	THR	IC28	IN10K IN15K IN30M	K30			
	K40										G13		IN30M				
N	N01	KS05F		H1	H10	KW10					K605	IC20					
	N10	TH10	HTi10	H1	H10 H10F	GW15	WH10	KT9 CR1	KM1	890 HX KX H15	K313 K110M THM THM-U	IC20 IC28	IN05S IN10K	K10	TN15U WU10HT	WK1 WK10	H210T H216T H10T
	N20	KS15F			H10F H13A		WH20	KT9 CR1	KM1	890 HX KX 883	K715 KMF K600	IC20 IC28	IN10K IN15K	K20	TN15U WU10HT	WK1 WK10	CTW7120 H210T H216T H10T
	N30									883 H25	G13 THR		IN15K IN30M			WK40 WMG40	
S	S01		RT9005									IC20					
	S10	KS05F TH10	RT9005 RT9010	EH510	H10 H10A	KW10	WH10	KG10	KM1	890 883	K10 K313 THM	IC20	IN05S IN10K	K10	TN15U WU10HT	WK1	H210T H216T H10T
	S20	KS15F KS20	RT9010 TF15	EH520	H10F H13A	GW25	WH20	KG20	KM1	890 883 H25	K715 KMF	IC20 IC28	IN10K IN15K	K20	TN15U WU10HT	WK1 WMG40	CTW7120 H210T H216T H10T
	S30		TF15							883	G13 K600 THR		IN15K IN30M			WMG40	
H	H01							KG03				IC20					
	H10	TH10			H13A			FZ05				IC20	IN10K	K10			
	H20							FZ15		890 HX 883			IN15K				

Note: The above table is selected from a publication. We have not obtained approval from each company.



User's Guide- Grade Comparison Chart

●PCBN and PCD for Turning

ISO		Tungaloy	Mitsubishi Carbide	Sumitomo Electric	Sandvik	Kyocera	Dijet	NTK	Seco Tools	Kennametal	Iscar	Ingersoll	TaeguTec	Widia	Walter	Ceratizit	
Classification	Symbol																
K	K01	BX930 BX910 BX870	MB710 MB5015	BN500 BNC500	CB7525 CB7050 CB50	KBN60M		B52		KB9610 KD120 KB1630	IB10K		KB90	WBH10C	WCB80	TA100 CTL3215	
	K10	BX470 BX480	MB730 MB4020	BN7000 BN7500	CB7050 CB7925 CB50	KBN60M	JBN795	B23 B30 B52	CBN200 CBN300 CBN400C CBN010	KB9640 KD120 KB1630	IB05S IB10S		KB90A	WBK40U	WCB80 WCB50	TA120 TA201 CTL3215	
	K20	BX480	MB730 MB4020	BN700 BN7000	CB7050	KBN60M		B23 B30 B52	CBN300 CBN500 CBN600 CBN010	KB1340 KB1345	IB90 IB25KD			WBK45U	WCB80	CTL3215	
	K30	BXC90 BX90S	BC8130	BNS800		KBN900		B16	CBN500 CBN600	KB1340 KB1345							
S	S01	BX815	MB730	BN350			JBN795	JP2	CBN170				KB90				
	S10	BX470 BX480		BN7500	CB7050	KBN65B KBN65M		B23 B30	CBN200	KB1630	IB05S IB10S		KB90A	WBK45U	WCB80	TA201	
H	H01	BXM10 BXA10 BX310	BC8110 MBC010 MB810 BC8105	BNC100 BNC160 BNC2010 BNX10 BN1000	CB20 CB7105	KBN510 KBN05M KBN10M		B52 B5K	CBN10 CBN100 CBN160C CBN050C	KB1610 KB5610	IB05H IB10HC		KB50	WBH10C	WCB30		
	H10	BXM10 BXA10 BX330 BX530	BC8110 MBC020 MB8025 BC8020 BC8120	BNC160 BNC200 BNC2020 BN250 BN1000	CB7015 CB20 CB50 CB7115	KBN525 KBN05M KBN25M	JBN245	B36 B52 B6K	CBN150 CBN200 CBN300 CBN060K CBN050C CBN160C CBN300P CBN400C	KB9610 KB1610 KB5610	IB50 IB55 IB10H IB10HC IB20H IB25HA		KB50 TB650	WBH10C WBH10P WBH10U	WCB30 WCB50	CTL3215 TA100	
	H20	BXM20 BXA20 BX360	MBC020 BC8120 MB8025 BC8020	BNC200 BNC2020 BN250 BNX20 BNX25 BN2000	CB7025 CB20 CB7035 CB7125	KBN525 KBN05M KBN10M KBN25M	JBN300 JBN330	B22 B36 B40 B6K	CBN150 CBN200 CBN300 CBN060K CBN160C CBN300P CBN400C	KB5625 KB1625	IB20H IB20HC IB25HA IB25HC		TB650	WBH25P	WCB50 WCB80	CTL3215 TA120	
	H30	BXC50 BX380	BC8130 MB835	BNC300 BN350 BNX25	CB7525 CB7135	KBN35M KBN900	JBN300 JBN330	B22 B40	CBN500	KB1630 KB9640	IB25HC			WBH40C			TA201
N	N01	DX160 DX180	MD205	DA90	CD10		JDA30 JDA735			KD1400 KD1405 KD100	ID5				WCD10	CTD4125	
	N10	DX140	MD220	DA150	CD10	KPD230	JDA715	PD1	PCD05 PCD10	KD100 KD1400 KD1425	ID5	IN90D	KP500	WDN25U	WCD10	CTD4125 CTD4110	
	N20	DX120	MD220	DA2200	CD10	KPD010	JDA715	PD1	PCD05 PCD20	KD1425		IN90D	KP300	WDN25U	WCD10	CTD4205	
	N30	DX110	MD230	DA1000		KPD001	JDA10		OVD20 PCD30 PCD30M				KP100				

Note: The above table is selected from a publication. We have not obtained approval from each company.

User's Guide- Grade Comparison Chart

●Ceramics for Turning

ISO		Tungaloy	Mitsubishi Carbide	Sumitomo Electric	Sandvik	Kyocera	Mitsubishi Hitachi Tool	Dijet	NTK	Seco Tools	Kennametal	Iscar	Ingersoll	TaeguTec	Widia	Walter	Ceratizit
Classification	Symbol																
K	K01	TZ120 LX11 LX21		NB90S NB90M	CC6190 CC650	KA30 A65 KT66 PT600M			HC1 HW2 SE1 HC2		KY1310 KY1615			AW20 AB30 AS10	CW2015		CTN3105 CTS3105
	K10	CX710 FX105			CC6190 CC650	A65 KT66 A66N PT600M			HC1 HW2 SE1 WA1 WA5		KY1310 KY1320 KY1615 KY3400		IN70N	AB30 AS10	CW2015 CW5025	WSN10	CTN3105 CTM3110 CTI3105 CTN3110 CTS3105
	K20	FX105 CX710			CC6190	KS6000			SP9 SX1 SX8 SX9		KY1320 KY3400 KY3500 KY4300		IN70N	AS10	CW5025	WSN10	CTM3110 CTN3110
S	S01								JX1		KY1525 KY2100						
	S10	TW43 TS200 TS300		WX120	CC670 CC6060 CC6065	CF1			WA1 WA5 SX9		KY1525 KY1540 KY2100 KY4300			AS20 TC430	CW3020		
H	H01	LX11		NB100C	CC6050 CC650	A65 KT66 A66N PT600M			ZC4 ZC7		KY4300			AW20	CW2015		CTS3105
	H10			NB100C	CC6050 CC670 CC6190	A65 KT66 A66N PT600M			HC4 HC7 WA1		KY1615 KY4400			AB2010 AB20 AB30	CW2015		CTS3105

Note: The above table is selected from a publication. We have not obtained approval from each company.



User's Guide- Grade Comparison Chart

●CVD Coated Grade for Milling

ISO		Tungaloy	Mitsubishi Carbide	Sumitomo Electric	Sandvik	Kyocera	Mitsubishi Hitachi Tool	Dijet	NTK	Seco Tools	Kennametal	Iscar	Ingersoll	TaeguTec	Widia	Walter	Ceratzit
Classification	Symbol																
P	P01											IC9015 IC5400 IC8080 IC9080			TN2510		
	P10		FH7020	ACP100	GC4220 GC4230			JC730U		MP1500	KCPM20	IC9015 IC5400 IC8080 IC9080 IC4100 IC5100			TN2510 TN7525	WKP25	GM226+
	P20	T3225	FH7020 F7030	ACP100	GC4220 GC4230		GX2140 GX2160	JC730U		MP1500 MP2500 T25M	KCPM20 KCPK30 KCPM30 KC927M	IC8080 IC9080 IC4100 IC5100 IC9250 IC520M	IN6530	TT7800	TN7525 TN7535	WKP25 WKP35 WKP35S	GM226+
	P30	T3130 T3225	F7030	ACP100	GC4230 GC4240 GC2040		GX2140 GX2160			MP1500 MP2500 T350M T25M	KCPK30 KCPM30 KC927M	IC9250 IC520M IC4050 IC635	IN6530	TT7800	TN7525 TN7535	WKP25 WKP35 WKP35S	GM226+ GM246 GM43+
	P40				GC4230 GC4240 GC2040		GX2160			MM4500 T350M	KCPK30 KCPM30	IC4050 IC635	IN6530	TT7800	TN7535	WKP35 WKP35S	GM246 GM43+
M	M10			ACM200	GC2015			JC730U			KCPM20	IC9250 IC520M IC9350			TN7525		
	M20	T3225	F7030	ACM200	GC4230	CA6535		JC730U		MP2500 T350M T25M	KCPM20 KCPM30 KC927M	IC9250 IC520M IC9350 IC4050 IC635	IN6530	TT7800	TN7525 TN7535		CTC5235 GM226+
	M30	T3225 T3130	F7030	ACM200	GC2040 GC4230 GC4240 S40T	CA6535	GX2160	JC730U		MP2500 T350M T25M	KCPM30 KC927M	IC9350 IC4050 IC635	IN6530	TT7800	TN7525 TN7535		CTC5235 CTC5240 GM226+ GM246 GM43+
	M40				GC2040 GC4240 S40T	CA6535	GX2160			MM4500 T350M		IC635	IN6530		TN7535		CTC5235 CTC5240 GM246 GM43+
K	K01		MC5020	ACK200		CA420M		JC605W			KC907M	IC8080 IC4100 IC5100 IC9150			TN2510 TN5505	WKP15	CTC3215
	K10	T1215 T1115	MC5020	ACK200	GC3220	CA420M	GX2120	JC605W JC608X JC610		MK1500	KC907M KC914M KC917M KC924M KCK15	IC8080 IC4100 IC5100 IC9150 IC9080 IC520M		TT6800	TN2510 TN5505 TN5515 TN5520	WKP15 WKP25	CTC3215 SR216 SR226+
	K20	T1215	MC5020	ACK200	GC3220 GC3330 GC3040 GC4220 GC4230	CA420M	GX2120 GX2140	JC605W JC608X JC610		MK1500 MP1500	KC917M KC924M KCK15 KCPM20 KCPK30 KC927M	IC5100 IC9150 IC9080 IC520M IC4050	IN6515 IN6530	TT6800	TN5515 TN5520	WKP15 WKP25 WKP35 WKP35S	SR216 SR226+
	K30		MC5020		GC3330 GC3040 GC4220 GC4230 GC4240		GX2140	JC610		MK1500 MP1500	KCPM20 KCPK30 KC927M	IC520M IC4050	IN6515 IN6530			WKP25 WKP35 WKP35S	

Note: The above table is selected from a publication. We have not obtained approval from each company.

User's Guide- Grade Comparison Chart

●PVD Coated Grade for Milling

ISO		Tungaloy	Mitsubishi Carbide	Sumitomo Electric	Sandvik	Kyocera	Mitsubishi Hitachi Tool	Dijet	NTK	Seco Tools	Kennametal	Iscar	Ingersoll	TaeguTec	Widia	Walter	Ceratizit	
Classification	Symbol																	
P	P01	AH710 AH110			GC1010		ATH80D JP4105	JC8003			KC505M KC510M KC515M	IC903		TT2510 TT5505	TN2505 TN6505			
	P10	AH120 AH725	MP6120 VP15TF	ACP200	GC1010 GC1025	PR830 PR1225 PR1230 PR1525	ATH80D PN08M ATH10E PN15M JP4105 JP4115 JP4120	JC8003 JC8015 JC5015 JC5118	DM4		KC505M KC510M KC515M KC610M KC715M	IC903 IC907 IC950 IC908 IC910 IC380 IC900	IN2505	TT2510 TT5505 TT5515 TT7080	TN2505 TN2525 TN6425 TN6505	WHH15 WXM15		
	P20	AH120 AH725 AH3135 AH9030 AH3225 AH9130	MP6120 VP15TF MP6130 UP20M VP20RT	ACP200 ACP300	GC1025 GC1030 GC2030	PR830 PR1225 PR1230 PR1525	JP4120 JS4045 CY250	JC8015 JC5015 JC5118 JC5040			MP3000 F25M	KC522M KC525M KC527M KC530M KC610M KC620M KC635M KC715M KC720M KC730M	IC907 IC950 IC908 IC910 IC380 IC900 IC830 IC928 IC1008	IN2040 IN2505 IN4005 IN4030	TT2510 TT5505 TT5525 TT7080 TT9030 TT9080	TN2525 TN6425 TN6430 TN6525	WHH15 WXM15	CTP1235 CTP1625
	P30	AH120 AH725 AH3135 AH130 AH6030 AH3225 AH9130	MP6120 VP15TF MP6130 UP20M VP20RT VP30RT	ACP200 ACP300	GC1025 GC1030 GC2030	PR830 PR1225 PR1230 PR1525	JS4045 CY250 JM4160	JC5118 JC5040 JC8050 JC7560			MP3000 F25M F30M F40M	KC525M KC527M KC530M KC537M KC610M KC620M KC720M KC725M KC730M KC735M	IC907 IC950 IC908 IC910 IC380 IC900 IC830 IC928 IC1008	IN2040 IN2505 IN2530 IN4005 IN4030	TT5525 TT7080 TT8020 TT8080 TT9030 TT9080	TN6430 TN6525 TN6540	WSP45 WSP46	CTP1235 CTP1625 CTP2235
	P40	AH140	VP30RT	ACP300	GC1030 GC2030		JM4160	JC5118 JC5040 JC8050 JC7560			MP3000 F40M T60M	KC537M KC720M KC725M KC735M	IC830 IC928 IC1008	IN2040 IN2530 IN4005 IN4030	TT8020	TN6540	WSP45 WSP46	CTP1235 CTP2235
	M	M01			ACM100 ACK300	GC1010		PCS08M		DM4			IC907 IC903					
M10		AH725	VP15TF	ACM100 ACK300 ACP300	GC1010 GC1025 GC1030 GC2030	PR830 PR1225 PR1525 PR1535	PCS08M CY150		DM4		KC515M KC610M KC635M KC720M	IC907 IC903	IN2505	TT5525 TT9030 TT9080	TN6425 TN6525	WXM15		
M20		AH725 AH3135 AH130 AH6030 AH3225 AH9130	VP15TF MP7130 MP7030 UP20M VP20RT	ACM300 ACP300	GC1025 GC1030 GC1040 GC2030	PR830 PR1225 PR1525 PR1535	CY150 CY250	JC8015 JC5015 JC5118	DM4	MP3000 MS2050 F25M F30M	KC522M KC525M KC530M KC610M KC635M KC720M KC730M	IC380 IC900 IC908 IC928 IC1008	IN2005 IN2505 IN2530 IN4005	TT8020 TT8080	TN6425 TN6525	WXM15 WSM35 WSM36	CTP1235 CTP1625	
M30		AH3135 AH130 AH9130	VP15TF MP7130 MP7030 UP20M VP20RT MP7140 VP30RT	ACM300	GC1040 GC2030	PR830 PR1225 PR1525 PR1535	CY250 JM4160	JC8015 JC5015 JC5118 JC8050 JC7560		MP3000 MS2050 F30M F40M	KC522M KC525M KC530M KC537M KC725M KC730M KC735M	IC380 IC900 IC908 IC928 IC1008 IC328 IC330	IN2005 IN2505 IN2530 IN4005 IN4030	TT8020 TT8080	TN6540	WSM35 WSM36 WSP45 WSP46	CTP1235 CTP2235	
M40		AH140	MP7140 VP30RT	ACM300	GC1040	PR1225 PR1525 PR1535	JM4160	JC5015 JC5118 JC8050 JC7560		MS2050 F40M	KC725M	IC1008 IC328 IC330	IN2005 IN2530 IN4005 IN4030	TT8020	TN6540	WSM35 WSM36 WSP45 WSP46	CTP2235	
K		K01	AH110	MP8010		GC1010	PR1510	ATH80D JP4105	JC8003				IC380 IC900		TT6080	TN2505 TN6405 TN6505		AMZ
	K10	AH110 AH120	MP8010 VP15TF		GC1010 GC1020	PR1210 PR1510	ATH80D JP4105 JP4120 CY150	JC8015		MK2050	KC514M KC515M KC520M KC620M	IC380 IC900 IC810 IC910	IN2015 IN2505 IN4015	TT6080	TN2505 TN6405 TN6505 TN6510	WHH15 WXM15 WKK25	AMZ CTP3220 CTP6215	
	K20	AH120 AH9030 AH9130	MP8010 VP15TF VP20RT	ACK300	GC1020	PR1210 PR1510	JP4120 CY150 CY250	JC8015 JC5015		MK2050	KC514M KC520M KC522M KC524M KC527M KC610M KC620M KC635M	IC810 IC910 IC950 IC350 IC830 IC928	IN2015 IN2505 IN4015 IN4030		TN2525 TN6510 TN6520 TN6525	WHH15 WXM15 WKK25	CTP3220 CTP1625	
	K30	AH120	VP15TF VP20RT	ACK300		PR1510	CY250	JC8015 JC5015		MK2050	KC522M KC524M KC527M KC537M KC610M KC620M KC635M	IC830 IC928 IC1008 IC808 IC908	IN2015 IN2505 IN4015 IN4030		TN6430 TN6525 TN6540	WKK25		

Note: The above table is selected from a publication. We have not obtained approval from each company.



User's Guide- Grade Comparison Chart

●PVD Coated Grade for Milling

ISO		Tungaloy	Mitsubishi Carbide	Sumitomo Electric	Sandvik	Kyocera	Mitsubishi Hitachi Tool	Dijet	NTK	Seco Tools	Kennametal	Iscar	Ingersoll	TaeguTec	Widia	Walter	Ceratizif
Classification	Symbol																
N	N01										KC410M KC510M KC5410			TT6080	TN6501		AMZ
	N10	DS1100		DL1000	GC1025 GC1030		SD5010 HD7010				KC410M KC510M KC5410 KC620M			TT6080 TT8020	TN6501 TN6502	WXN15	AMZ
	N20	DS1200	LC15TF	DL1000	GC1025 GC1030		SD5010 HD7010			F15M	KC422M KC620M			TT8020		WXN15	
S	S01	AH110 AH710		ACM100 ACK300	GC1010	PR905 PR1210 PR1535		JC8003 JC8015			KC510M	IC808 IC907 IC908			TN6405		AMZ
	S10	AH120 AH725	MP9120 VP15TF MP9130 MP9030	ACM100 ACK300	S30T GC1010 GC1030 GC2030	PR905 PR1210 PR1535	PTH13S JS1025	JC8003 JC8015 JC5015 JC5118		MS2050	KC510M KC610M	IC808 IC907 IC908 IC903	IN2505 IN2530	TT9030 TT9080 TT8080	TN6405 TN6425		AMZ CTP1625
	S20	AH725 AH130 AH6030	MP9120 VP15TF MP9130 MP9030	ACM300	S30T GC1030 GC1040 GC2030 GC2040	PR905 PR1210 PR1535	PTH13S JS1025	JC8015 JC5015 JC5118 JC8050 JC7560		MS2050 F40M	KC522M KC525M KC610M	IC300 IC900 IC830 IC928	IN2505 IN2530	TT8080 TT8020	TN6425	WSM35 WSM36	CTP1235 CTP1625
	S30	AH130	MP9130 MP9030	ACM300	S30T GC1040 GC2040	PR1535		JC5118 JC8050 JC7560		MS2050 F40M	KC522M KC525M KC725M	IC830 IC928	IN2530	TT8020	TN6540	WSM35 WSM36 WSP45 WSP46	CTP1235 CTP2235
H	H01	AH110 AH710 AH8005	MP8010		GC1010			DH102 JC6102 JC8003 JC8008			KC510M	IC903		TT2510 TT5505	TN2505		
	H10	AH110 AH120 AH710 AH8015	MP8010 VP15TF		GC1010 GC1025 GC1030		PTH08M JP4105	JC6102 JC8003 JC8008 JC8015 JC5118		MH1000 F15M	KC505M KC510M KC635M	IC903 IC808 IC907 IC908		TT5515 TT6080	TN2505 TN2525	WHH15	CTP6215
	H20	AH120 AH725 AH9030	VP15TF		GC1025 GC1030		JP4105	JC8015 JC5118		F15M	KC635M	IC808 IC907 IC908 IC380 IC900		TT5515 TT6080	TN2525	WHH15	CTP6215
	H30									MP3000 F30M		IC380 IC900 IC1008					

Note: The above table is selected from a publication. We have not obtained approval from each company.

User's Guide- Grade Comparison Chart

●Cermet for Milling

ISO		Tungaloy	Mitsubishi Carbide	Sumitomo Electric	Sandvik	Kyocera	Mitsubishi Hitachi Tool	Dijet	NTK	Seco Tools	Kennametal	Iscar	Ingersoll	TaeguTec	Widia	Walter	Ceratzit
Classification	Symbol																
P	P01			T250A	CT530	TN60 TN100M	MZ1000						IN0560	CT3000			TCC410
	P10	NS740	NX2525	T250A	CT530	TN60 TN100M TC60M	MZ1000 MZ2000 CH550	NIT CX75 CX90		MP1020	KTPK20	IC30N	IN0560 IN60C	CT3000 CT7000	TTI25		TCC410 TCM10
	P20	NS740	NX2525 NX4545	T250A T4500A		TN60 TN100M TC60M	MZ2000 MZ3000 CH500 CH7030	NIT CX75 CX90 SC30		MP1020	KTPK20	IC30N	IN60C	CT3000 CT7000	TTI25		TCM10
	P30		NX4545	T4500A			MZ3000 CH7035		C7X			IC30N	IN0545	CT7000			
M	M10	NS740	NX2525	T250A	CT530	TN60 TN100M TC60M	MZ1000 CH550	NIT CX75			KTPK20	IC30N	IN0560	CT3000 CT7000	TTI25		TCC410
	M20	NS740	NX2525 NX4545	T250A T4500A		TN60 TN100M TC60M	MZ2000 MZ3000 CH500 CH7030	NIT CX75 SC30	C7X	MP1020	KTPK20	IC30N		CT7000	TTI25		TCC410 TCM10
	M30		NX4545	T4500A			MZ3000 CH7035	SC30									
K	K01						MZ1000 CH550	NIT									TCC410
	K10	NS740	NX2525				MZ2000 MZ3000 CH500 CH7030	NIT CX75			KTPK20			CT7000			TCC410 TCM10
	K20						MZ2000 MZ3000 CH500 CH7030 CH7035	CX75			KTPK20						

Note: The above table is selected from a publication. We have not obtained approval from each company.

Grade

Insert

Toolholder

Ext. Toolholder

Int. Toolholder

Threading

Grooving

Miniature Tool

Milling Cutter

Endmill

Drilling Tool

Tooling System

User's Guide

Index



User's Guide- Grade Comparison Chart

●Uncoated Carbide for Milling

ISO		Tungaloy	Mitsubishi Carbide	Sumitomo Electric	Sandvik	Kyocera	Mitsubishi Hitachi Tool	Dijet	NTK	Seco Tools	Kennametal	Iscar	Ingersoll	TaeguTec	Widia	Walter	Ceratizit	
Classification	Symbol																	
P	P01																	
	P10																	S26T
	P20		UTi20T	A30N			EX35				K125M	IC50M		P30	TTM			S26T
	P30	UX30	UTi20T	A30N	SM30		EX40				K125M	IC50M IC28		P30	TTM TTR			S26T
	P40				SM30							IC28			TTR			
M	M01																	
	M10											IC20 IC07 IC08						S26T
	M20		UTi20T		SM30							IC07 IC08			TTM			S26T
	M30		UTi20T	A30N	SM30							IC28			TTM TTR			S26T
	M40			A30N								IC28			TTR			
K	K01					KW10					K115M K313			K10	THM-F			
	K10	TH10	HTi10	G10E	H13A	KW10 GW25	WH10				K115M K313 K110M	IC20		K10	THM-F THM			CTW4615 H216T
	K20		HTi10 UTi20T	G10E	H13A	KW10 GW25				HX	KMF	IC20	IN10K		THM THR			CTW4615 H216T
	K30		UTi20T										IN10K		THR			
	K40												IN10K					
N	N01	KS05F	HTi10		H10	KW10					K115M				THM-U	WK10		
	N10	TH10	HTi10		H10 H13A H10F	KW10 GW25	WH10			H15	K115M K313 K110M	IC20 IC08		K10 UF10	THM-U THM-F THR-S	WK10		CTW4615 H216T
	N20	KS15F	HTi10 TF15	H1	H13A H10F	KW10 GW25				HX H15 H25	KMF K313 K110M	IC20 IC08 IC28		K10 UF10	THM-F THR-S THM	WMG40		CTW4615 H216T
	N30		TF15	H1							KMF	IC28					WMG40	
S	S01					KW10					K313	IC20						
	S10			EH520	H13A	KW10 GW25		FZ15			K313 K110M	IC20 IC07 IC08			THM-F			
	S20	KS20		EH520	H10F H13A	KW10 GW25		FZ15		HX H25	KMF	IC20 IC07 IC08 IC28			THM			
	S30				H10F							IC07 IC08						
H	H01				H1P			FZ05										
	H10				H1P			FZ05 FZ15				IC20			THM-F			
	H20							FZ15										

Note: The above table is selected from a publication. We have not obtained approval from each company.

User's Guide- Grade Comparison Chart

Grade

A

Insert

B

Toolholder

C

Ext. Toolholder

D

Int. Toolholder

E

Threading

F

Grooving

G

Miniature Tool

H

Milling Cutter

I

Endmill

J

Drilling Tool

K

Tooling System

L

User's Guide

M

●PCBN and PCD for Milling

ISO		Tungaloy	Mitsubishi Carbide	Sumitomo Electric	Sandvik	Kyocera	Dijet	NTK	Seco Tools	Kennametal	Iscar	Ingersoll	TaeguTec	Widia	Walter	Ceratizit
Classification	Symbol															
K	K10	BX480	MB710 MB730	BN700 BN7000 BN500	CB50	KBN475	JBN795 JBN500	B30 B52	CBN200		IB85	IN80B	KB90	WBK40U	WCB80	TA201
	K20	BXC90 BX90S	MBS140	BNS800					CBN300 CBN400C	KB1340						
H	H20	BX850					JBN245		CBN100							
	H30	BX940		BNX25	CB50					KB1340		IN80B			WCB80	TA201
N	N10	DX140	MD220		CD10	KPD230	JDA30 JDA735	PD1	PCD20 PCD30M	KD1415	ID5	IN90D		WDN25U	WCD10	CTD4205
	N20			DA2200		KPD010	JDA10			KD1425	ID8					
	N30	DX110		DA1000		KPD001			PCD05	KD1420						

Note: The above table is selected from a publication. We have not obtained approval from each company.

●Ceramics for Milling

ISO		Tungaloy	Mitsubishi Carbide	Sumitomo Electric	Sandvik	Kyocera	Mitsubishi Hitachi Tool	Dijet	NTK	Seco Tools	Kennametal	Iscar	Ingersoll	TaeguTec	Widia	Walter	Ceratizit
Classification	Symbol																
K	K01	LX11 LX21		NB90S NB90M	CC6190 CC650	KA30 A65 KT66 PT600M			HC1 HW2 SE1 HC2		KY1310 KY1615			AW20 AB30 AS10	CW2015		CTN3105 CTS3105
	K10	CX710 FX105			CC6190 CC650	A65 KT66 A66N PT600M			HC1 HW2 SE1 WA1 WA5		KY1310 KY1320 KY1615 KY3400		IN70N	AB30 AS10	CW2015 CW5025	WSN10	CTN3105 CTM3110 CTI3105 CTN3110 CTS3105
	K20	FX105 CX710			CC6190	KS6000			SP9 SX1 SX8 SX9		KY1320 KY3400 KY3500 KY4300		IN70N	AS10	CW5025	WSN10	CTM3110 CTN3110
S	S01								JX1		KY1525 KY2100						
	S10	FX510 TS200		WX120	CC670 CC6060 CC6065	CF1			WA1 WA5 SX9		KY1525 KY1540 KY2100 KY4300			AS20 TC430 TC3020	CW3020		
	S20	TS300												TC3030			
H	H01	LX11		NB100C	CC6050 CC650	A65 KT66 A66N PT600M			ZC4 ZC7		KY4300			AW20	CW2015		CTS3105
	H10			NB100C	CC6050 CC670 CC6190	A65 KT66 A66N PT600M			HC4 HC7 WA1		KY1615 KY4400			AB2010 AB20 AB30	CW2015		CTS3105

Note: The above table is selected from a publication. We have not obtained approval from each company.

User's Guide- Chipbreaker Comparison Chart

● Negative insert type

ISO Classification	Cutting Mode	Tungaloy	Mitsubishi Carbide	Sumitomo Electric	Kyocera	Sandvik	Mitsubishi Hitachi Tool	Kennametal	Dijet	Iscar	TaeguTec	Widia	Walter	Ceratizit	
P	Precision finishing	01 TF	PK FH	FA	DP	QF	FE	FS , LF	PF	SF , PP , TF	FA				
	Finishing and light cutting	TS , TSF ZF 11 , NS AS TQ NM CB C	SA FY C SH MP	SU FL SE , SX	PQ , VF CJ PQ GP , PP HQ GS CQ	PF , QF LC MF R/L-K	BE , BH AB , CT CE	FF , FN	UA , FT UR , UT	F3P NF , SF	FG VF , EA FC MC ML , MP	4 AP	NF3 NS6	CF , TF	
		Finishing and light cutting (With Wiper)	AFW , FW ASW , SW	SW	LUW SEW GUW	WP WQ	WL , WF WMX WM , WR		FW MW RW		WF WG	WS WT	FW MW	NF NM	TFQ TMQ
		Medium cutting	TM , AM DM , ZM All-round , TA	MA MH , MP	GU GE , UX	HS , PT , GT CS , PS	PM , QM XM , XRM	AH AE , AY , B	P MN	PG , UB GN GNP	M3P , M3M PP , TF , GN	PC , MT MC , MG-	48	NMT , NM4	TMF , TMM M50
		Medium to heavy cutting	TH THS	RP , GH HZ , HL	MU , ME HG	PH All-round	HM , PR MR	RE	RN , RP MR	GG , UD	NR MR	RT	49	NM5 , NM6 NM9	TM TRM
Heavy cutting	TU TRS TUS	HM , HX HV	HG , HP HU , HW HF	PX	PR , MR HR , QR	TE , UE HX , HE H	RM RH	UC	R3P NM	HT , HD RX , RH HY , HZ		NR6 NRF NRR	TRR , TR R28 , R58 R88		
M	Finishing and light cutting	SF , SA SS	GM , MS SH , LM	EX , EG SU , EF	GU MQ	MF , XF LC , R/L-K	MP BH , AB	FP	SF	TF , VL	EA , SF , SU FG		NF4 NMS	CF , F30 , M34 F32 , TF	
	Medium cutting	SM S , TA	MM , MA ES	GU HM	TK MU	MM , QM XM , XRM	PV , SE DE	MP , P	SZ	M3M , PP	EM , ET		NM4	TMF , M42 M30 , M52	
	Heavy cutting	TH , SH TU	GH , RM , HZ	EM , MU	MS	MR HM , PR	AH , AE	UP , RP	SG	MR , MH		SR	NR4 NRT , NRS	TM , M60 TRM , TMR , TRR R80	
K	Finishing	CF , TA	LK , MA	UZ	C	KF , XF	Y , AH	FN		GN	FG			CF	
	Medium cutting	CM All-round	MK GK	GZ	ZS All-round	KM , QM XM , XRM	V , AE VA	RP , UN	PG		MT MG		NM5	M50	
	Heavy cutting	CH Flat-top	RK Flat-top	Flat-top	Flat-top	Flat-top	Flat-top	Flat-top	GG , UD Flat-top		RT		Flat-top	TMR , TR R28 R58 , R88	
N	Cutting of non-ferrous metals	P		AX	AH , A3	MF QM	Flat-top	MS , MP MG		PP	ML			F32	
S	Finishing	HRF	FJ , LS	EF EX	MQ	SF 01		FS , LS MS			SF		NFT NF4		
	Medium cutting	HRM HMM SA	MS RS , GJ	EG MU	TK , MS , MU	MM , QM SMR		UP , P , NGP RP		PP	SU	SM	NMS NM4 , NRS , NR4	M34 , M52	

Note: Above charts are based on published data and not authorized by each manufacturer.

User's Guide- Chipbreaker Comparison Chart

Grade

Insert

Toolholder

Ext. Toolholder

Int. Toolholder

Threading

Grooving

Miniature Tool

Cutter

Milling

Endmill

Drilling Tool

Tooling System

User's Guide

Index

M



●Positive insert type

ISO Classification	Cutting Mode	Tungaloy	Mitsubishi Carbide	Sumitomo Electric	Kyocera	Sandvik	Mitsubishi Hitachi Tool	Kennametal	Dijet	Iscar	TaeguTec	Widia	Walter	Ceratizit	
P	Precision finishing	01	FV, SMG	FC, FW	CF CK		No sign MP	UF		SF		2	PF2	F32	
	Finishing and light cutting	PSF, PF, SS PS, PSS, TS TSF	FP, FV, SV LP	FP, FZ, LU FK, SS, SC SU, SK, SF US	GQ, GK GP, HQ XP, XQ	R/L-K PF, XF UF, PM	JQ	11, GM LF	FT	PF SM, 14, 17 19, XL	FA FG	41	PF5 PF4 PS5	SF SMF	
		TSW W08~20	SW, MW R/L, R/L-FD R/L-FS R/L-MV R/L-F, R/L-L	LUW, SDW W, SD FX, FY	WF, WK, WM					R/L RF, LF	GF		PF, PM	SMQ, 25Q	
		No sign													
	Medium cutting	PM TM 23 24 All-round RS	MP MV No sign	SU, MU UJ SC (except for G-class inserts) RP	All-round VF, MF	PM, XM UM, PR, XR UR	JE	GM, MP, MR		DT, HQ	MT		PM5	SM	
High-feed, small depth of cut cutting	61	No sign			No mark		WE		No sign 14	No sign	MT	43	No sign		
M	Finishing	PSF, SS	FM, FV, SV	FC		R/L-K UF, MF	MP	GM, LF			FG	41			
	Finishing to Medium cutting	PSS PS	LM SV		MQ	MM, XM UM	JQ	MF					PF4	SF, SMF	
	Medium cutting	PM	MM, MV	MU		MR, XR UR	JE						PM5	F23, F43 SM	
K	Cutting of cast irons	CM Flat-top	MK Flat-top	Flat-top	Flat-top	KF, XF KM, XM UM, KR, XR	JQ, JE	Flat-top	Flat-top	19	MT Flat-top		PS5, PM5 Flat-top	SF 25P 27, 29	
N	Cutting of non-ferrous metals	AL PP	AZ	AG AX, AY	AH, A3	AL		GT-HP		AS	FL	AL1, AL2, AL3	PF2 PM2	23P 25P 27, 29	
		Ground	R/L-F R/L												
S	Finishing	PSF	FJ	FC	MQ	MF, UF, R/L-K								SF	
	Finishing to Medium cutting	PSS PS		FX, FY		MM, XM								F23	
	Medium cutting	All-round		SI		UM, MR, UR, XR					FG		PF2, PF4	SM, 25P, 29	
P M N S	Turning on small lathes	01 W08, W15, W20 J10	R/L-SR R/L-SN R/L-SS FS, F	W, SD FX, FY	R/L-F, R/L-FSF ER/L-U FR/L-U R/L-U FR/L-U, R/L-USF	F, M	No sign		MF, MM ALU, MM1 ASF FT, ACB		GF, GW		PM5		
		JRP, JSP, JPP TS, JTS TSW SS, JSS	SW, MW	LUW, SDW											
		JS		LU, FP, FK, SU FB, LB FC, SI, SC	GK E-GK										
		SMG													

Note: The above table is selected from a publication. We have not obtained approval from each company.

MEMO

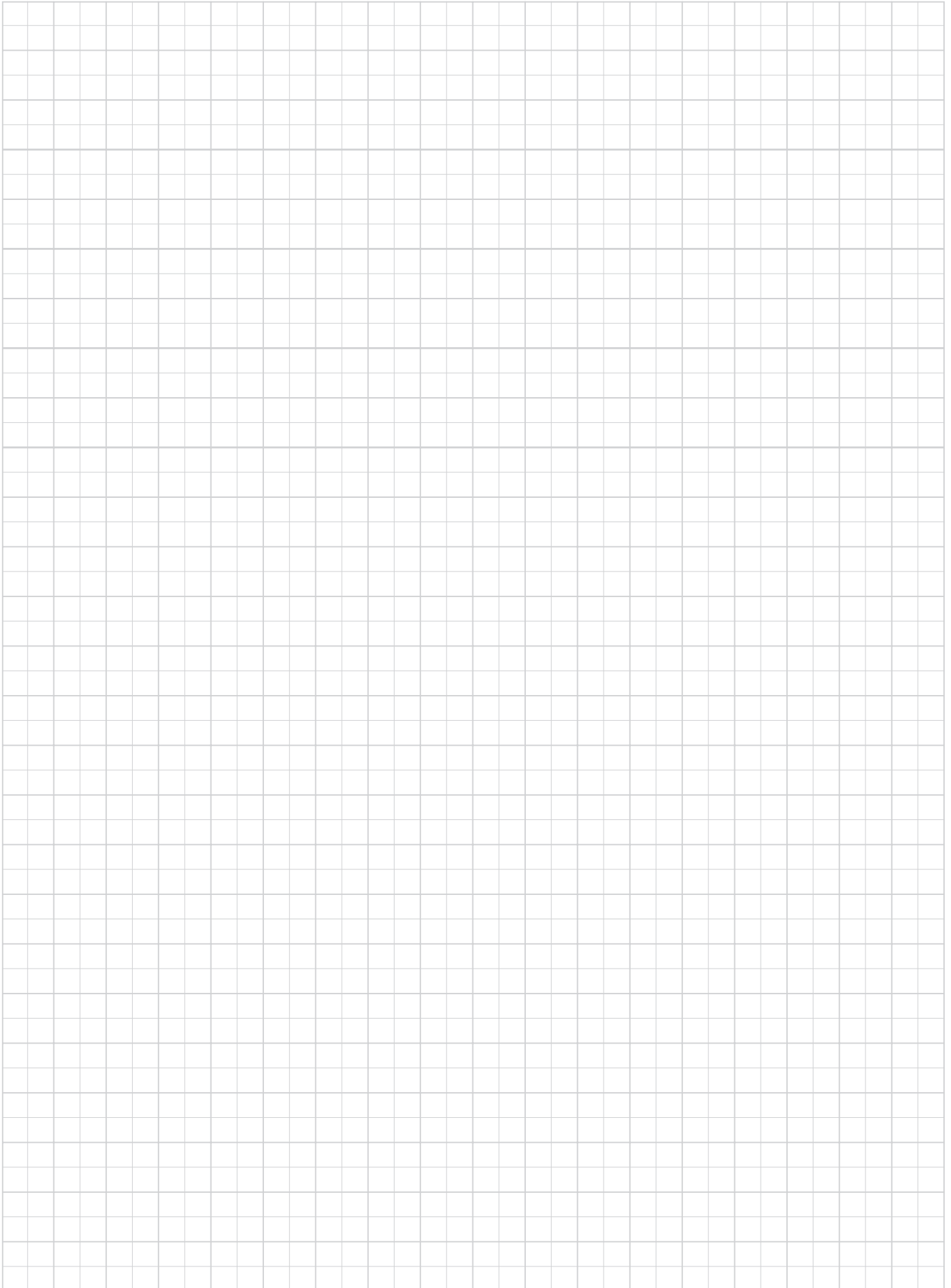

Insert

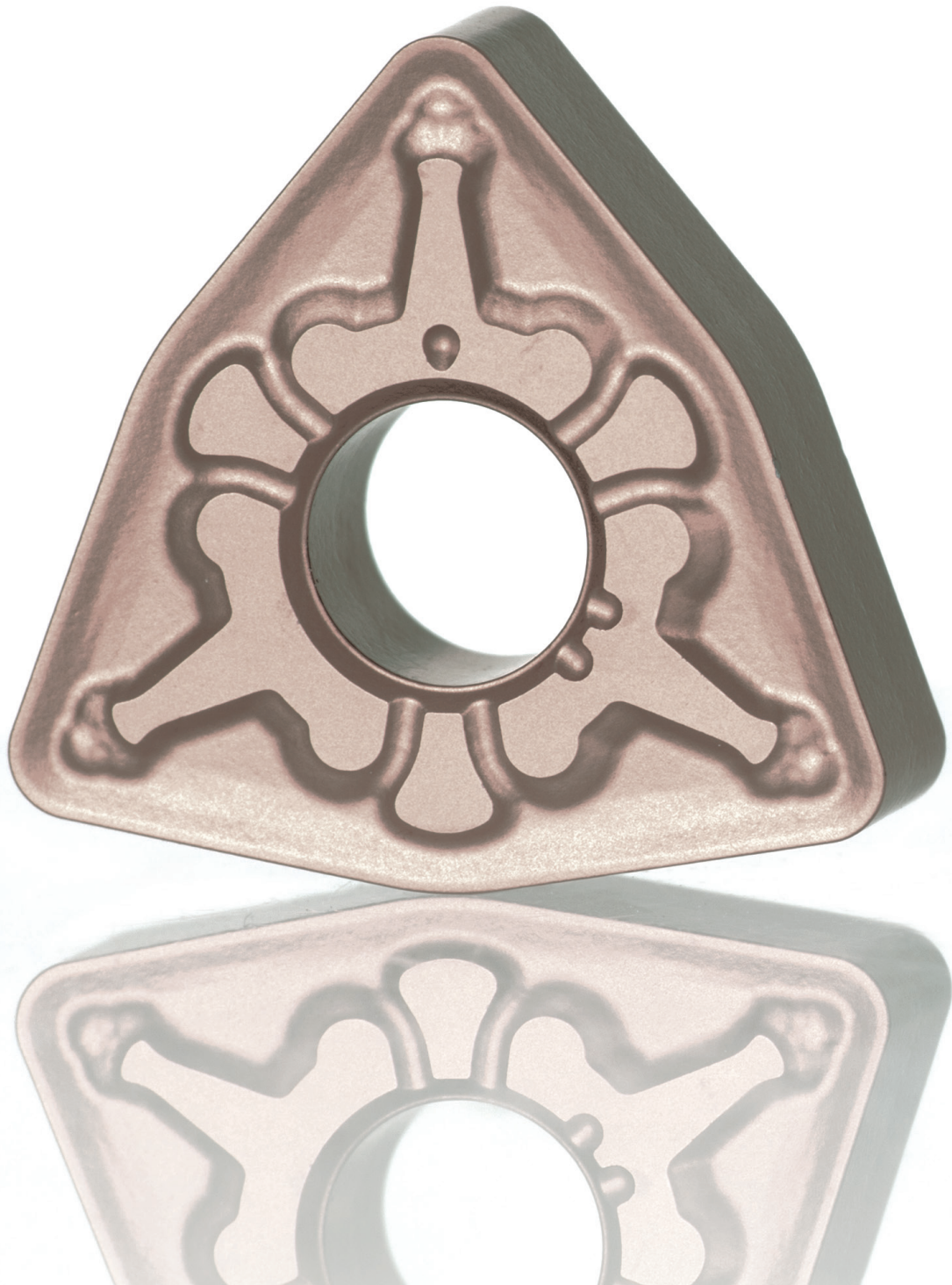

Insert - Content structure

- Inserts grouped in Negative type, Positive type and CBN/PCD.
- The list is in alphabetical order.
- The order of the list: C (80°) → D (55°) → R (360°) → S (90°) → T (60°) → V (35°) → W (80°) → Y (25°) → Other shapes
- The order of inserts:
 - Negative type (each shape with hole → without hole)
 - Positive type (each shape with hole → without hole)
- The order of chipbreakers:
 - From precision finishing to heavy cutting, in the order of the values of cutting depth and feed rate.
- Insert without chipbreaker is on the last page of each shape.
- Introduces the proposed inserts according to the workpiece materials and the shape of workpiece materials.
- The standard cutting conditions for typical chipbreakers are at the bottom of the pages.
- ● in the catalog describes our standard stock items, and ▲ means the item to be discontinued in the future.

How to use the page

Method ①

Select an insert at the right end, and choose the information page by the insert type (1) and the outer shape of the insert (2) at the left end.

Method ②

Check the page of each insert type from the index on B003 (1), and choose the page of the setting information according to the outer shape of the insert (2).

Method ③

Select an insert at the chipbreaker introduction and the selection guide on B006 - B029 and check the details on the product page.

Method ④

Select an insert from the list of chipbreaker shapes on B030-B053 and check the details on each page.

When ordering

- Please specify the designation, grade, and quantity.
- e.g. **CNMG 432 TM T9225 ... 10 pieces** (10 inserts per package)
- *You will find a note if the number per package is not 10.



Negative type

Coated CVD/PVD, Cermet, Uncoated cemented carbide, Ceramic

B056



Positive type

Coated CVD/PVD, Cermet, Uncoated cemented carbide, Ceramic

B111

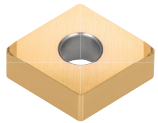

CBN / PCD Insert

CBN (T-CBN), PCD (T-DIA)

B167

Designation system for Insert

Symbol	Shape	Nose angle (degree)	Figure
H	Hexagonal	120°	
O	Octagonal	135°	
P	Pentagonal	108°	
S	Square	90°	
T	Triangular	60°	
C	Rhombic	80°	
D		55°	
E		75°	
F		50°	
G	G-shape (Tungaloy's symbol)	70°	
M	Rhombic	86°	
V		35°	
Y	Y-shape (Tungaloy's symbol)	25°	
W	Trigon	80°	
L	Rectangular	90°	
A	Parallelogram	85°	
B		82°	
K		55°	
R	Round	-	

1 Shape

Note: For rhombic and parallelogram inserts, use the smaller nose angle.

Symbol	Relief angle
A	3°
B	5°
C	7°
D	15°
E	20°
F	25°
G	30°
N	0°
P	11°
O	Others
X	Special



2 Relief angle

Symbol (class)	Tolerance (inch)		
	Cutting point	Thickness (S)	I.C. dia. (IC)
A	±0.0002	±0.0001	±0.0001
F	±0.0002	±0.0001	±0.0005
C	±0.0005	±0.0001	±0.0001
H	±0.0005	±0.0001	±0.0005
E	±0.001	±0.001	±0.001
G	±0.001	±0.005	±0.001
J	±0.0002	±0.001	±0.002 ~ ±0.005
K	±0.0005	±0.001	±0.002 ~ ±0.005
L	±0.001	±0.001	±0.002 ~ ±0.005
M	±0.003 ~ ±0.007	±0.005	±0.002 ~ ±0.005
N	±0.003 ~ ±0.007	±0.001	±0.002 ~ ±0.005
U	±0.005 ~ ±0.015	±0.005	±0.003 ~ ±0.01

3 Accuracy

1	2	3	4	5
T	N	M	G	3
C	C	G	T	3
1	2	3	4	5

4 Groove and hole					
Symbol	Hole	Shape of hole	Chip-breaker	Shape	
N	Without	-	Without		
R			Single-sided		
F			Double-sided		
A	With	Cylindrical hole	Without		
M			Single-sided		
G			Double-sided		
W			Partly cylindrical hole, single-side 40° ~ 60° Counter sink	Without	
T			Single-sided		
Q			Partly cylindrical hole, double-side 40° ~ 60° Counter sink	Without	
U	Double-sided				
B	With	Partly cylindrical hole, single-side 70° ~ 90° Counter sink	Without		
H			Single-sided		
C			Without		
J					
X		Partly cylindrical hole, double-side 70° ~ 90° Counter sink			

5 Size (I.C.)			
Symbol		Dimensions (in)	
Normal series	Small series	I.C.	Fraction
(1.2)	5	0.156	5/32
(1.5)	6	0.187	3/16
(1.8)	7	0.219	7/32
2	(8)	0.250	1/4
(2.5)	0	0.313	5/16
3		0.375	3/8
4		0.500	1/2
5		0.625	5/8
6		0.750	3/4
7		0.875	7/8
8		1.000	1
(10)		1.250	1-1/4

ANSI Designation

● Detailed accuracy

Corner angles larger than 55°

Inscribed circle	Tolerance on inscribed circle dia. (IC)		Tolerance on corner height (M)		Shape
	J,K,M,N (class)	U (class)	J,K,M,N (class)	U (class)	
0.250	±0.002	±0.003	±0.003	±0.005	H W
0.375					O R
0.500	±0.003	±0.005	±0.005	±0.008	P
0.625					S
0.750					T
1.000	±0.005	±0.010	±0.007	±0.015	C,E,M

● Note on insert thickness

Thickness of insert with chipbreaker grooves is defined as shown to the right.

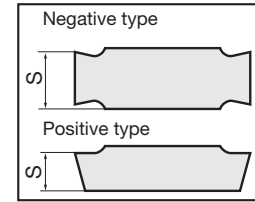

For angles at 55° (M-Class)

Inscribed circle	Tolerance on inscribed circle dia. (IC)	Tolerance on corner height (M)	Applicable insert shape
0.250	±0.002	±0.004	D
0.375			
0.500	±0.003	±0.006	
0.625	±0.004	±0.007	
0.750			

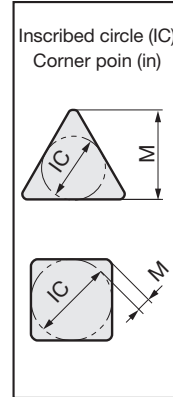

Symbol		Thickness (in)	
Normal series	Small series		
-	2	0.062	1/16
1.5	3	0.094	3/32
2	4	0.125	1/8
2.5	5	0.156	5/32
3	6	0.187	3/16
3.5	-	0.219	7/32
4	-	0.250	1/4
5	-	0.313	5/16
6	-	0.375	3/8

Thickness

[Example]

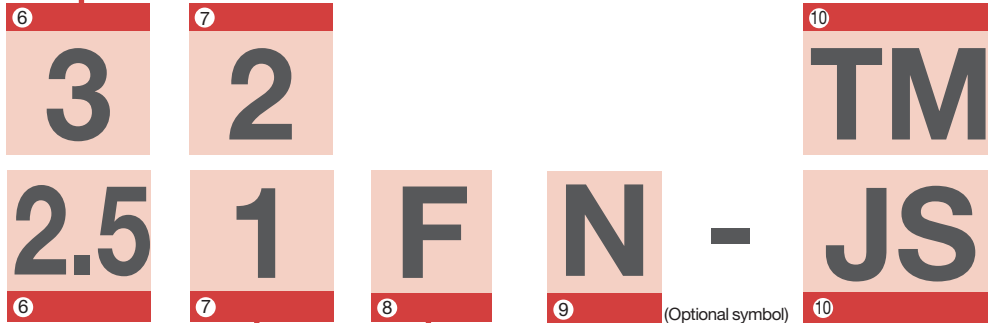

7 Corner radius

Symbol	Corner radius RE (in)	
V	0.001	-
0	0.004	1/256
0.5	0.008	1/128
1	0.016	1/64
2	0.031	1/32
3	0.047	3/64
4	0.062	1/16
5	0.078	5/64
6	0.094	3/32
7	0.109	7/64
8	0.125	1/8

8 Major cutting edge

Symbol	Cutting edge	Shape
F	Sharp	

9 Hand of insert

Symbol	Hand
R	Right
L	Left
N	Neutral

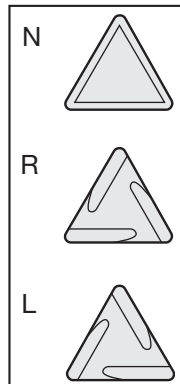

10 Our company's own symbols showing cutting edge conditions. For details, refer to page B007.

Insert hole size chart

Insert hole size		
	I.C.	Diameter
Negatives	1/4	0.089
	3/8	0.150
	1/2	0.203
	5/8	0.250
	3/4	0.312
	1	0.359
Positives	1 1/4	0.346
	5/32	0.087
	3/16	0.087
	13/64	0.110
	7/32	0.094
	1/4	0.110
	5/16	0.134
	3/8	0.173
1/2	0.217	
5/8	0.217	



Designation system for Insert

● How to decide the insert designation (conforms to JIS B4120-1998, ISO 1832 / AM1:1998)

Symbol	Shape	Nose angle (degree)	Figure
H	Hexagonal	120°	
O	Octagonal	135°	
P	Pentagonal	108°	
S	Square	90°	
T	Triangular	60°	
C	Rhombic	80°	
D		55°	
E		75°	
F		50°	
G	G-shape (Tungaloy's symbol)	70°	
M	Rhombic	86°	
V		35°	
Y	Y-shape (Tungaloy's symbol)	25°	
W	Trigon	80°	
L	Rectangular	90°	
A	Parallelogram	85°	
B		82°	
K		55°	
R	Round	-	

1 Shape

Note: For rhombic and parallelogram inserts, use the smaller nose angle.

Symbol	Relief angle
A	3°
B	5°
C	7°
D	15°
E	20°
F	25°
G	30°
N	0°
P	11°
O	Others
X	Special

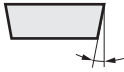

2 Relief angle

Symbol (class)	Tolerance (mm)		
	Corner height (M)	Thickness (S)	I.C. dia. (IC)
A	±0.005	±0.025	±0.025
F	±0.005	±0.025	±0.013
C	±0.013	±0.025	±0.025
H	±0.013	±0.025	±0.013
E	±0.025	±0.025	±0.025
G	±0.025	±0.13	±0.025
J	±0.005	±0.025	±0.005 ~ ±0.13
K	±0.013	±0.025	±0.05 ~ ±0.13
L	±0.025	±0.025	±0.05 ~ ±0.13
M	±0.08 ~ ±0.18	±0.13	±0.05 ~ ±0.13
N	±0.08 ~ ±0.18	±0.025	±0.05 ~ ±0.13
U	±0.13 ~ ±0.38	±0.13	±0.08 ~ ±0.25

3 Accuracy

[Example] T N M G 16

[Example] C C G T 09

4 Groove and hole				
Symbol	Hole	Shape of hole	Chip-breaker	Shape
N	Without	-	Without	
R			Single-sided	
F			Double-sided	
A	Cylindrical hole	-	Without	
M			Single-sided	
G			Double-sided	
W			Partly cylindrical hole, single-side 40° ~ 60° Counter sink	
T	With	-	Single-sided	
Q			Partly cylindrical hole, double-side 40° ~ 60° Counter sink	
U			Double-sided	
B			Partly cylindrical hole, single-side 70° ~ 90° Counter sink	
H	Cylindrical hole, double-side 70° ~ 90° Counter sink	-	Single-sided	
C			Without	
J			Double-sided	
X	Special			

5 Cutting edge length and I.C. symbol																
* (R)	(S)	(C)	(W)	(T)	(D)	(V)	(K)	I.C. dia.								
Symbol	Length	Symbol	Length	Symbol	Length	Symbol	Length	Symbol	Length	Symbol	Length	Symbol	Length	Symbol	Length	
	03	3.97	03	4.0			06	6.9	04	4.8					3.97	
	04	4.76	04	4.8			08	8.2	05	5.8	08	8.3			4.76	
05	5	-	-	-	-	-	-	-	-	-	-	-	-	-	5	
	05	5.56	05	5.6	03	3.8	09	9.6	06	6.8					5.56	
06	6	-	-	-	-	-	-	-	-	-	-	-	-	-	6	
	06	6.35	06	6.5	04	4.3	11	11	07	7.8	11	11.2			6.35	
	07	7.94	08	8.1	05	5.4	13	13.8	09	9.7					7.94	
08	8	-	-	-	-	-	-	-	-	-	-	-	-	-	8	
09	9.525	09	9.525	09	9.7	06	6.5	16	16.5	11	11.6	16	16.6	16	19.7	9.525
10	10	-	-	-	-	-	-	-	-	-	-	-	-	-	10	
12	12	-	-	-	-	-	-	-	-	-	-	-	-	-	12	
12	12.7	12	12.7	12	12.9	08	8.7	22	22	15	15.5	22	22.1			12.7
15	15.875	15	15.875	16	16.1	10	10.9	27	27.5	19	19.4					15.875
16	16	-	-	-	-	-	-	-	-	-	-	-	-	-	16	
19	19.05	19	19.05	19	19.3	13	13	33	33	23	23.3					19.05
20	20	-	-	-	-	-	-	-	-	-	-	-	-	-	20	
		22	22.225	22	22.6			38	38.5	27	27.1					22.225
25	25	-	-	-	-	-	-	-	-	-	-	-	-	-	25	
25	25.4	25	25.4	25	25.8			44	44	31	31					25.4
31	31.75	31	31.75	32	32.2			55	55	38	38.8					31.75
32	32	-	-	-	-	-	-	-	-	-	-	-	-	-	32	

ISO Designation

● Detailed accuracy for J,K,L,M,N and U classes

For inserts with nose corner angles larger than 55° (mm)

Inscribed circle	Tolerance on inscribed circle dia. (IC)		Tolerance on corner height (M)		Applicable insert shape
	J,K,L,M,N (class)	U (class)	J,K,L,M,N (class)	U (class)	
6.35	±0.05	±0.08	±0.08	±0.13	H W O R P S T C,E,M
9.525					
12.7	±0.08	±0.13	±0.13	±0.2	
15.875	±0.1	±0.18	±0.15	±0.27	
19.05					
25.4	±0.13	±0.25	±0.18	±0.38	
31.75	±0.15	±0.25	±0.2	±0.38	
32					

For M-type inserts with nose corner angles of 55° (Shape: D), 35° (Shape: V), 25° (Shape: Y) (mm)

Inscribed circle	Tolerance on inscribed circle dia. (IC)		Tolerance on corner height (M)	Applicable insert shape
	J,K,L,M,N (class)	U (class)		
6.35	±0.05	±0.11	±0.11	D
9.525				
12.7				
15.875	±0.1	±0.18	±0.18	
19.05				
6.35	±0.05	±0.16	±0.16	V Y
9.525				

● Insert thickness

For many of the inserts with chipbreaker, the insert height of the cutting edge is lower. In that case, the insert thickness outlined in the drawing of external dimensions is equivalent of "S" in the figure on the right.

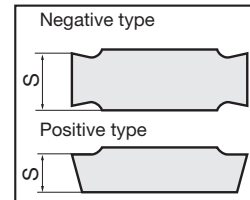

Symbol	Thickness (mm)
X1	1.39
01	1.59
T1	1.98(1.79)
02	2.38
T2	2.78
03	3.18
T3	3.97
04	4.76
05	5.56
06	6.35
07	7.94
09	9.52

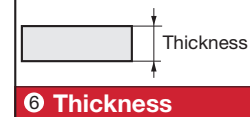

6 Thickness

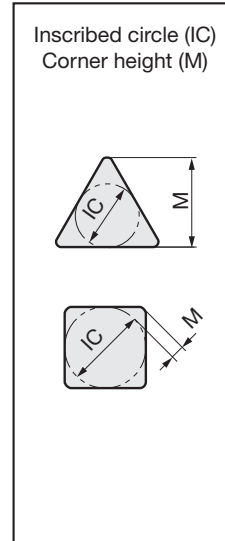

[Example]

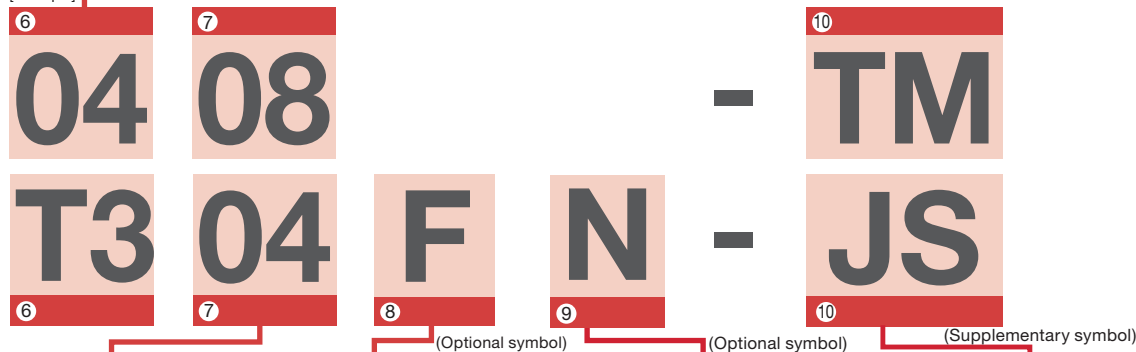

7 Corner radius	
Symbol	Corner radius RE (mm)
00	0.03
02	0.2
04	0.4
08	0.8
12	1.2
16	1.6
20	2.0
24	2.4
28	2.8
32	3.2

8 Major cutting edge		
Symbol	Cutting edge	Shape
F	Sharp	

9 Hand of insert	
Symbol	Hand
R	Right
L	Left
N	Neutral

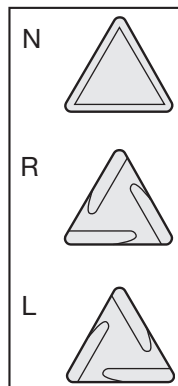

10 Chipbreaker			
Symbol	Applications	Symbol	Applications
01(TF)	Precision finishing (Basic selection)	AFW	Small depth of cut and high feed (Wiper type Inserts)
TS	Finishing (Basic selection)	ASW	Small depth of cut and high feed (Wiper type Inserts)
TSF	Finishing (Basic selection)	CB	Medium cutting
TM	Medium cutting (Basic selection)	CM	Medium cutting of cast irons
THS	Medium to heavy cutting (Basic selection)	All-round	Medium cutting
TRS	Medium to heavy cutting	A	Finishing (Right and left hand)
TUS	Heavy cutting	B	Finishing (Right and left hand)
DM	Medium cutting	D	Finishing (Right and left hand)
HRF	Finishing	C	Finishing (Right and left hand)
HRM	Finishing to medium cutting	P	Finishing of Aluminium alloys
HMM	Finishing to medium cutting	W	Finishing (Angular type)
SF	Finishing of stainless steels	PSF	Finishing (Positive type)
SS	Finishing of stainless and mild steels	PSS	Finishing to light cutting (Positive insert)
SM	Medium cutting of stainless steels	PS	Finishing to medium cutting (Positive type Basic selection)
S	Medium cutting of stainless steels	PM	Medium cutting (Positive type)
SH	Medium to heavy cutting of stainless steels	AL	Finishing to medium cutting of aluminium alloys
SA	For heat-resisting alloys and stainless steels	RS	Medium cutting (For round inserts)
ZF	Finishing and profiling	W□□	Finishing (Angular type)
ZM	Finishing to medium cutting and profiling	H□□	Finishing to medium cutting (Parallel)
NS	Finishing and profiling	11	Finishing
NM	Finishing to medium cutting and profiling	61	Small depth of cut and high feed (For round inserts)
AS	Small depth of cut and high feed	S1	Finishing (For KNMX type)
TA	Medium cutting	Job, J10	For small lathes
TQ	Medium cutting	JS	For small lathes
AM	Small depth of cut and high feed	JRP	For small lathes
FW	Finishing (Wiper type)	JPP	For small lathes
SW	Finishing to medium cutting (Wiper type)	JSP	For small lathes

Chipbreaker Guide

BASIC CHIPBREAKER: NEGATIVE TYPE

P Steel

Chipbreaker System for Turning (Negative type)

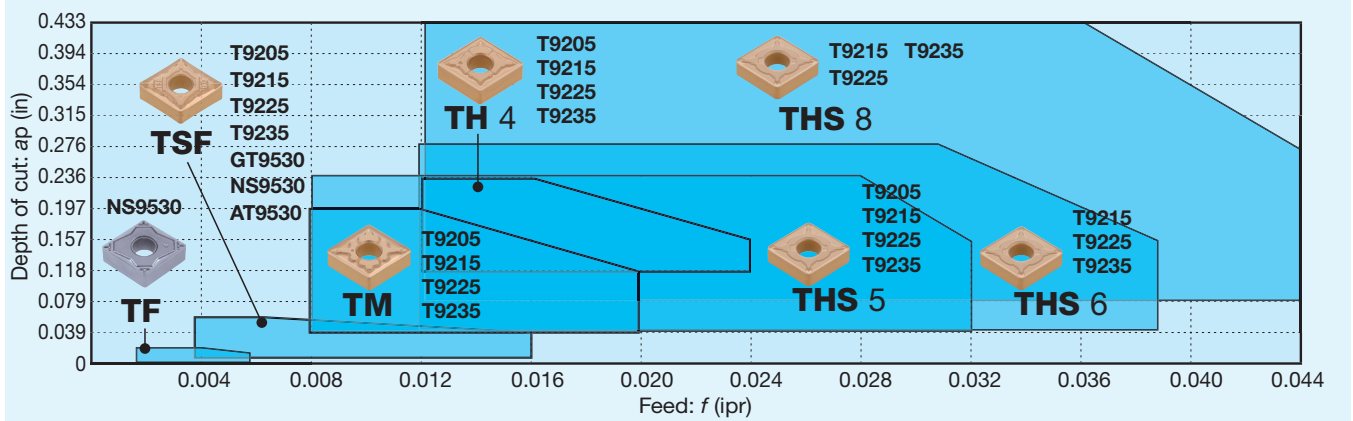

CVD coated grade

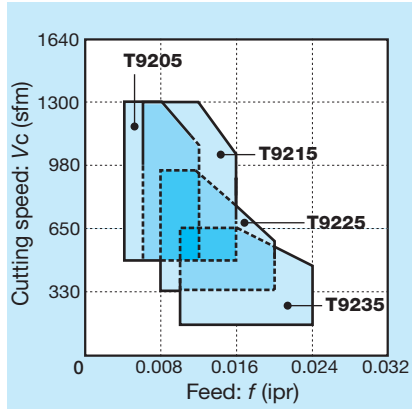

Coated cermet / Cermet

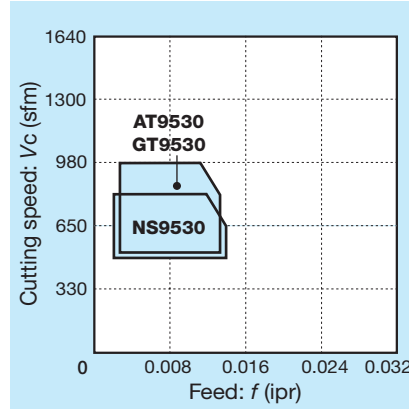

Chipbreaker	Shape	Feature
TF		Excellent chip control at very small depth of cut and low feed with the sharp cutting edge and protrusion. Economical M-class insert contributes to cost reduction.
TSF		First choice for finishing. The sharp cutting edge and arc-shaped protrusion near the corner ensure excellent chip control.

Chipbreaker	Shape	Feature
TM		General-purpose chipbreaker with extensive chip control area. The protrusion in unique shape near the corner and large rake angle provide sharp cutting edge with low cutting force.
TH		Double-sided 3D chipbreaker with tough cutting edge and excellent chip control. Even suitable for high-feed machining.
THS		Suitable for varying depth of cut and excellent chip control in a broad range of depths of cut. Ideal for interrupted cutting and high-feed cutting with its tough cutting edge.

STANDARD CUTTING CONDITIONS

ISO	Operation	Work condition	Chip-breaker	Grade	Depth of cut ap (in)	Feed f (ipr)	Cutting speed: Vc (sfm)		
							Low carbon steels, Alloy steels	Medium carbon steels, Alloy steels	High carbon steels, Alloy steels
P	Precision finishing	Continuous to light interrupted	TF	NS9530	0.002 - 0.020	0.001 - 0.006	500 - 820	330 - 820	330 - 660
			TSF	GT9530	0.008 - 0.060	0.003 - 0.016	500 - 980	260 - 660	260 - 660
	Finishing	Continuous to light interrupted	TSF	AT9530	0.008 - 0.060	0.003 - 0.016	500 - 980	260 - 660	260 - 660
			TSF	T9225	0.008 - 0.060	0.003 - 0.016	400 - 980	400 - 980	330 - 820
	Medium cutting	Continuous to heavy interrupted	TM	T9205	0.040 - 0.200	0.008 - 0.020	590 - 1312	590 - 1312	500 - 1150
			TM	T9215	0.040 - 0.200	0.008 - 0.020	500 - 1312	500 - 1312	400 - 980
			TM	T9225	0.040 - 0.200	0.008 - 0.020	400 - 980	400 - 980	330 - 820
			TM	T9235	0.040 - 0.200	0.008 - 0.020	160 - 660	160 - 660	160 - 500
	Medium to heavy cutting	Continuous to heavy interrupted	TH	T9205	0.120 - 0.240	0.012 - 0.024	590 - 1312	590 - 1312	500 - 1150
			TH	T9215	0.120 - 0.240	0.012 - 0.024	500 - 1312	500 - 1312	400 - 980
TH			T9225	0.120 - 0.240	0.012 - 0.024	400 - 980	400 - 980	330 - 820	
TH			T9235	0.120 - 0.240	0.012 - 0.024	160 - 660	160 - 660	160 - 500	

Low carbon steels, Alloy steels: 1018, 1020, etc. Medium carbon steels, Alloy steels: 1045, 4140, etc. High carbon steels, Alloy steels: 8620, etc.

Selection System

SELECTION SYSTEM: NEGATIVE TYPE

P Steel

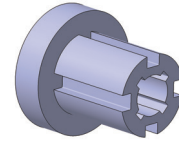
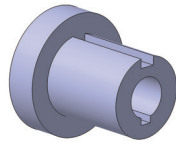
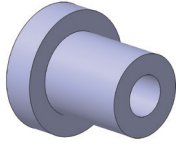

Continuous

Light interrupted

Heavy interrupted

	Continuous	Light interrupted	Heavy interrupted
Precision finishing [$a_p = \sim 0.020$ in]	<p>Basic</p>  <p>TF NS9530</p> <p>B032</p> <p>Fracture →</p> <p>TSF GT9530</p> <p>B032</p>	<p>Basic</p>  <p>TF NS9530</p> <p>B032</p> <p>Fracture →</p> <p>TSF GT9530</p> <p>B032</p>	
Finishing [$a_p = 0.012 \sim 0.060$ in]	<p>Basic</p>  <p>TSF GT9530</p> <p>B032</p> <p>Chip control →</p> <p>ZF GT9530</p> <p>B033</p>	<p>Basic</p>  <p>TSF GT9530</p> <p>B032</p> <p>Fracture →</p> <p>TSF T9215</p> <p>B032</p>	<p>Basic</p>  <p>TSF T9225</p> <p>B032</p> <p>Fracture →</p> <p>TSF T9235</p> <p>B032</p>
Medium cutting [$a_p = 0.039 \sim 0.157$ in]	<p>Basic</p>  <p>TM T9215</p> <p>B034</p> <p>Wear →</p> <p>TM T9205</p> <p>B034</p> <p>Chip control →</p> <p>ZM T9215</p> <p>B035</p>	<p>Basic</p>  <p>TM T9225</p> <p>B034</p> <p>Fracture →</p> <p>TM T9235</p> <p>B034</p> <p>Wear →</p> <p>TM T9215</p> <p>B034</p>	<p>Basic</p>  <p>TM T9235</p> <p>B034</p> <p>Fracture →</p> <p>DM T9235</p> <p>B035</p>
Medium to heavy cutting [$a_p = 0.118 \sim 0.236$ in]	<p>Basic</p>  <p>TH T9215</p> <p>B038</p> <p>Wear →</p> <p>TH T9205</p> <p>B038</p> <p>Chip control →</p> <p>TM T9215</p> <p>B034</p>	<p>Basic</p>  <p>TH T9225</p> <p>B038</p> <p>Fracture →</p> <p>TH T9235</p> <p>B038</p> <p>Wear →</p> <p>TH T9215</p> <p>B038</p>	<p>Basic</p>  <p>TH T9235</p> <p>B038</p> <p>Fracture →</p> <p>TUS T9235</p> <p>B039</p>

Please see the page B*** for the details.



Chipbreaker Guide

BASIC CHIPBREAKER: NEGATIVE TYPE

M Stainless Steel

Chipbreaker System for Turning (Negative type)

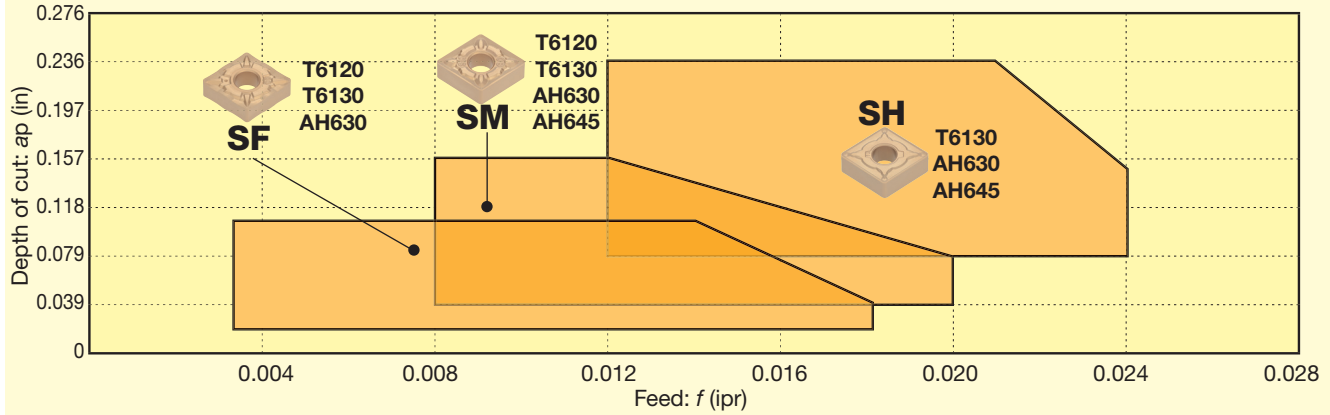

Austenitic stainless steel

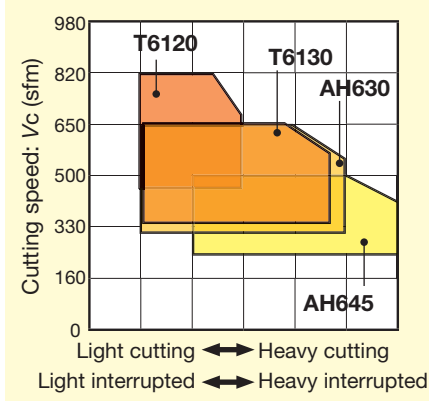

Ferritic / martensite stainless steel

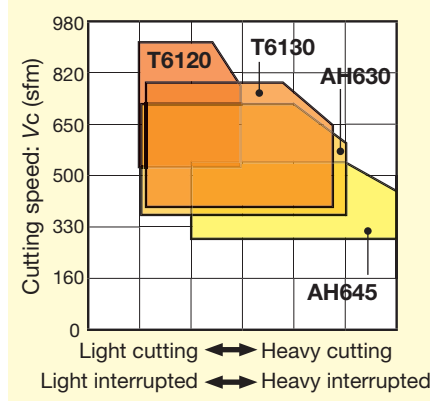

Precipitation hardened stainless steel

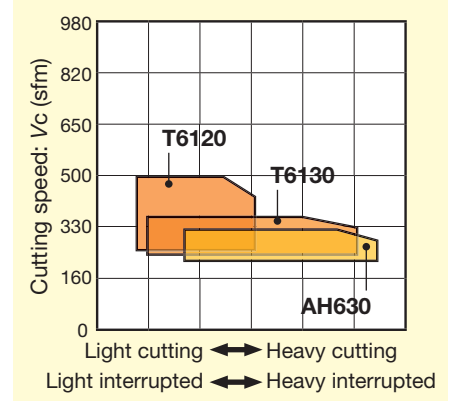

Chipbreaker	Shape	Feature
SF		Excellent chip control with small depth of cut at high feed. Suitable for finishing stainless steel.
SH		Suitable for medium to heavy cutting. High fracture resistance with specially reinforced cutting edge. Ideal for machining that requires cutting edge strength, such as roughing and interrupted cutting.

Chipbreaker	Shape	Feature
SM		General-purpose chipbreaker with sharpness and good chip control. First choice for stainless steel.

STANDARD CUTTING CONDITIONS

ISO	Operation	Work condition	Chipbreaker	Grade	Depth of cut ap (in)	Feed f (ipr)	Cutting speed Vc (sfm)
M	Finishing	Continuous	SF	T6120	0.020 - 0.098	0.003 - 0.018	460 - 790
		Continuous to light interrupted	SF	T6130	0.020 - 0.098	0.003 - 0.018	330 - 660
		Heavy interrupted	SF	AH630	0.020 - 0.098	0.003 - 0.018	300 - 620
	Medium cutting	Continuous	SM	T6120	0.040 - 0.160	0.008 - 0.020	460 - 790
		Continuous to light interrupted	SM	T6130	0.040 - 0.160	0.008 - 0.020	330 - 660
		Light interrupted	SM	AH630	0.040 - 0.160	0.008 - 0.020	300 - 620
		Heavy interrupted	SM	AH645	0.040 - 0.160	0.008 - 0.020	230 - 500
		Continuous to light interrupted	SH	T6130	0.080 - 0.240	0.012 - 0.024	330 - 660
		Light interrupted	SH	AH630	0.080 - 0.240	0.012 - 0.024	300 - 620
Medium to heavy cutting	Heavy interrupted	SH	AH645	0.080 - 0.240	0.012 - 0.024	230 - 500	

Stainless steels: 304SS, 316SS, etc.

Selection System

SELECTION SYSTEM: NEGATIVE TYPE

M Stainless Steel

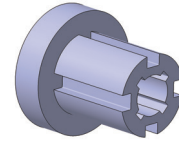
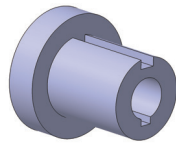
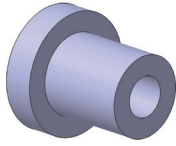

Continuous

Light interrupted

Heavy interrupted

	Continuous	Light interrupted	Heavy interrupted
Finishing $[a_p = 0.020 \sim 0.060 \text{ in}]$	<p>Basic</p> <p>Fracture → SF T6130 B033</p> <p>Wear → SF T6120 B033</p>	<p>Basic</p> <p>Fracture → SF AH630 B033</p> <p>Wear → SF T6120 B033</p>	<p>Basic</p> <p>Fracture → SF AH645 B033</p> <p>Wear → SF T6130 B033</p>
Medium cutting $[a_p = 0.039 \sim 0.157 \text{ in}]$	<p>Basic</p> <p>Wear → SM T6120 B037</p> <p>Chip control → SF T6130 B033</p>	<p>Basic</p> <p>Fracture → SM AH645 B037</p> <p>Wear → SM T6130 B037</p>	<p>Basic</p> <p>Fracture → SH AH645 B039</p>
Medium to heavy cutting $[a_p = 0.079 \sim 0.236 \text{ in}]$	<p>Basic</p> <p>Fracture → SH AH630 B039</p> <p>Wear → SH T6120 B039</p> <p>Chip control → SM T6130 B037</p>	<p>Basic</p> <p>Fracture → SH AH645 B039</p> <p>Wear → SH T6130 B039</p>	<p>Basic</p> <p>Wear → SH AH630 B039</p>

Please see the page B*** for the details.

Grade
Insert
Ext. Toolholder
Int. Toolholder
Threading
Grooving
Milling Cutter
Miniature Tool
Endmill
Drilling Tool
Tooling System
User's Guide
Index



Chipbreaker Guide

BASIC CHIPBREAKER: NEGATIVE TYPE

K Cast Iron

Chipbreaker System for Turning (Negative type)

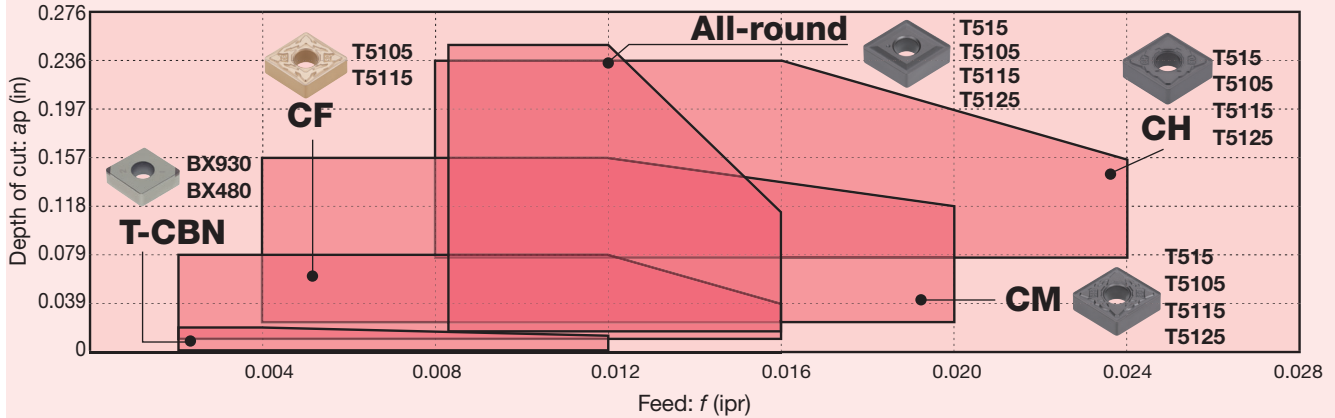

Grey cast iron

Ductile cast iron

Grey cast iron (high speed cutting)

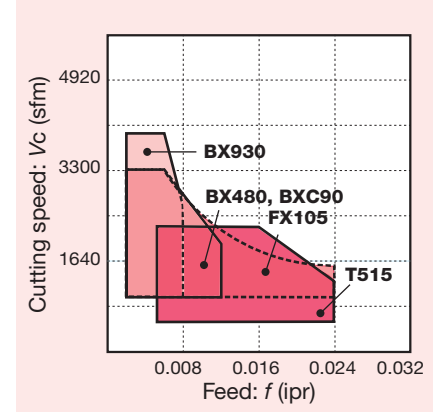
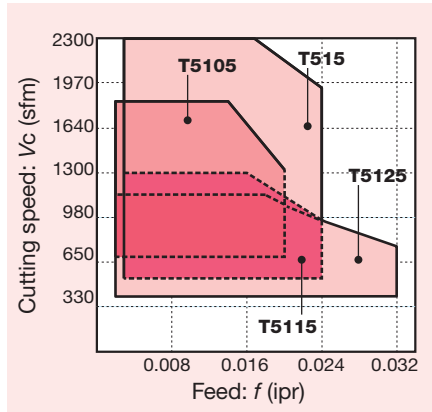

Chipbreaker	Shape	Feature
No chip-breaker (T-CBN)		Excellent performance in high-speed finishing of cast iron with CBN sintered body on the cutting edge.
CF		Low cutting force chipbreaker for cast iron. Combined with an arc-shaped high rake angle (substantially 20°) drastically reduces cutting force and prevents the deformation and burr of thin-walled components.
All-round		Excellent performance in interrupted cutting. Highly reliable chipbreaker with great stability.

Chip-breaker	Shape	Feature
CM		First choice for cast iron. Versatile chipbreaker for a wide range of applications from continuous to interrupted cutting thanks to the positive land and wide chip pocket.
CH		Chipbreaker with reinforced cutting edge. The negative land and the land support provide stable insert seating and increase cutting edge strength, resulting in no fracture even in heavy cutting.

STANDARD CUTTING CONDITIONS

ISO	Operation	Work condition	Chip-breaker	Grade	Depth of cut ap (in)	Feed f (ipr)	Cutting speed: Vc (sfm)	
							Grey cast iron	Ductile cast iron
K	High speed cutting	Continuous	Without	BX930	0.002 - 0.020	0.002 - 0.008	984 - 3937	328 - 1640
		Light interrupted	Without	BX480	0.002 - 0.020	0.002 - 0.012	984 - 3281	328 - 984
		Continuous	Without	BXC90	0.003 - 0.118	0.002 - 0.016	984 - 3281	328 - 984
	Finishing	Continuous	All-round	T515	0.039 - 0.197	0.004 - 0.020	490 - 2297	459 - 1214
		Light interrupted	All-round	T515	0.039 - 0.197	0.004 - 0.020	490 - 2297	459 - 1214
		Heavy interrupted	All-round	T515	0.039 - 0.197	0.004 - 0.020	490 - 2297	459 - 1214
Medium cutting	Continuous	All-round	T515	0.039 - 0.197	0.004 - 0.020	490 - 2297	459 - 1214	
	Light interrupted	All-round	T515	0.039 - 0.197	0.004 - 0.020	490 - 2297	459 - 1214	
	Heavy interrupted	CH	T515	0.118 - 0.236	0.008 - 0.024	490 - 2297	459 - 1214	
Medium to heavy cutting	Continuous	All-round	T515	0.039 - 0.197	0.004 - 0.020	490 - 2297	459 - 1214	
	Light interrupted	All-round	T515	0.039 - 0.197	0.004 - 0.020	490 - 2297	459 - 1214	
	Heavy interrupted	CH	T515	0.118 - 0.236	0.008 - 0.024	490 - 2297	459 - 1214	

Grey cast iron: Class 25, etc. Ductile cast irons: 65-45-12, etc.

Selection System

SELECTION SYSTEM: NEGATIVE TYPE

K Cast Iron

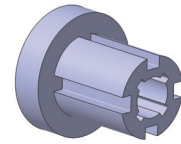
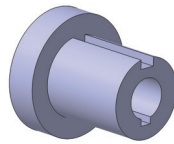
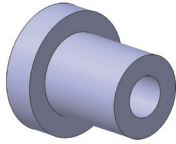

	Continuous	Light interrupted	Heavy interrupted
Finishing [$a_p = 0.020 \sim 0.079$ in.]	<p>Basic → Wear → All-round T5105 (B035)</p> <p>All-round T515 (B035) → Burr occurrence → CF T5105 (B033)</p>	<p>Basic → Wear → All-round T5105 (B035)</p> <p>All-round T515 (B035) → Fracture → CH T515 (B039)</p> <p>All-round T515 (B035) → Burr occurrence → CF T5115 (B033)</p>	<p>Basic → Wear → CH T5105 (B039)</p> <p>CH T515 (B039) → Fracture → CH T5125 (B039)</p> <p>CH T515 (B039) → Burr occurrence → All-round T515 (B035)</p>
Medium cutting [$a_p = 0.039 \sim 0.197$ in.]	<p>Basic → Wear → All-round T5105 (B035)</p> <p>All-round T515 (B035) → Burr occurrence → CF T5105 (B033)</p>	<p>Basic → Wear → All-round T5105 (B035)</p> <p>All-round T515 (B035) → Fracture → CH T515 (B039)</p> <p>All-round T515 (B035) → Burr occurrence → CF T5115 (B033)</p>	<p>Basic → Wear → CH T5105 (B039)</p> <p>CH T515 (B039) → Fracture → CH T5125 (B039)</p> <p>CH T515 (B039) → Burr occurrence → All-round T515 (B035)</p>
Medium to heavy cutting [$a_p = 0.118 \sim 0.236$ in.]	<p>Basic → Wear → All-round T5105 (B035)</p> <p>All-round T515 (B035) → Burr occurrence → CF T5105 (B033)</p>	<p>Basic → Wear → All-round T5105 (B035)</p> <p>All-round T515 (B035) → Fracture → CH T515 (B039)</p> <p>All-round T515 (B035) → Burr occurrence → CF T5115 (B033)</p>	<p>Basic → Wear → CH T5105 (B039)</p> <p>CH T515 (B039) → Fracture → CH T5125 (B039)</p> <p>CH T515 (B039) → Burr occurrence → All-round T515 (B035)</p>

Please see the page B*** for the details.

Grade
Insert
Ext. Toolholder
Int. Toolholder
Threading
Grooving
Milling Cutter
Miniature Tool
Endmill
Drilling Tool
Tooling System
User's Guide
Index



Chipbreaker Guide

BASIC CHIPBREAKER: NEGATIVE TYPE

N Non-ferrous Metal

Chipbreaker System for Turning (Negative type)

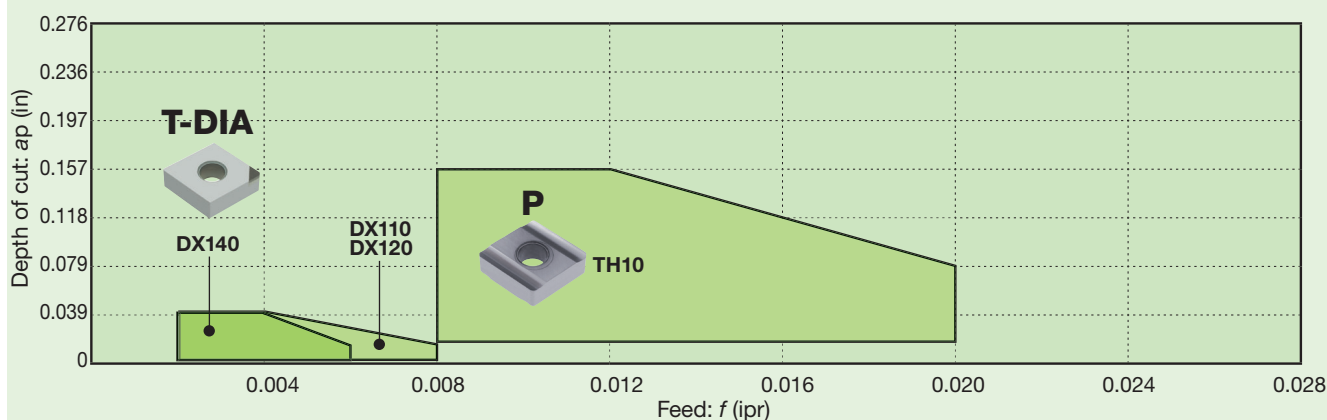

Aluminum alloy (Si < 12%)

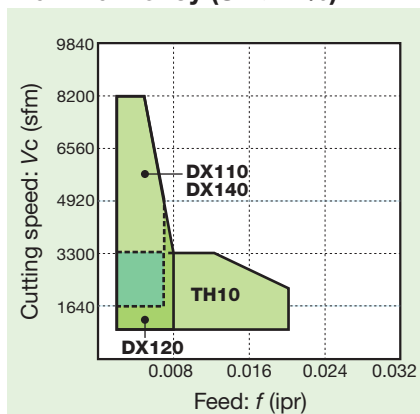

Aluminum alloy (Si ≥ 12%)

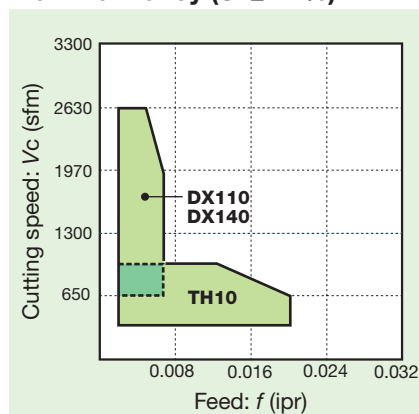

Copper alloy

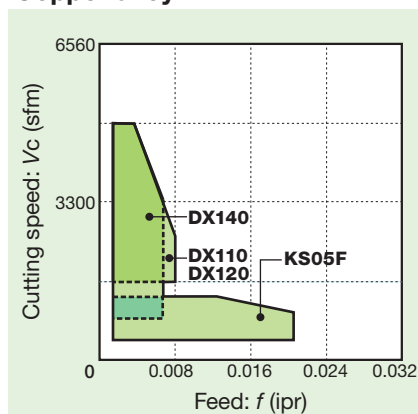

Chipbreaker	Shape	Feature
No chip-breaker (T-DIA)		Excellent performance in high-speed finishing of non-ferrous metal, such as aluminum and copper alloy, with diamond sintered body on the cutting edge.
P		Excellent sharpness for non-ferrous metal, such as aluminum and copper alloy.

Chipbreaker	Shape	Feature
With chip-breaker (T-DIA)		Wide chipbreaker for excellent chip control.

STANDARD CUTTING CONDITIONS

ISO	Operation	Work condition	Chip-breaker	Grade	Depth of cut ap (in)	Feed f (ipr)	Cutting speed: Vc (sfm)		
							Aluminum alloy (Si < 12%)	Aluminum alloy (Si ≥ 12%)	Copper alloy
N	Precision finishing	Continuous	With	DX110	0.002 - 0.040	0.002 - 0.006	1640 - 8200	1310 - 2630	1640 - 4920
		Light interrupted	Without	DX140	0.002 - 0.040	0.002 - 0.008	980 - 8200	-	1640 - 4920
	Finishing	Continuous	Without	DX140	0.002 - 0.040	0.002 - 0.006	1640 - 8200	1310 - 2630	1640 - 4920
		Light interrupted	Without	DX140	0.002 - 0.040	0.002 - 0.006	980 - 5900	1310 - 1970	1310 - 3940
		Heavy interrupted	P	TH10	0.020 - 0.160	0.008 - 0.020	330 - 1640	330 - 660	330 - 660
	Medium cutting	Continuous	P	TH10	0.020 - 0.160	0.008 - 0.020	330 - 3280	330 - 980	330 - 980
		Light interrupted	P	TH10	0.020 - 0.160	0.008 - 0.020	330 - 2630	330 - 660	330 - 660
		Heavy interrupted	P	TH10	0.020 - 0.160	0.008 - 0.020	330 - 1640	330 - 660	330 - 660

Selection System

SELECTION SYSTEM: NEGATIVE TYPE

N Non-ferrous Metal

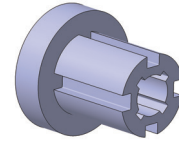
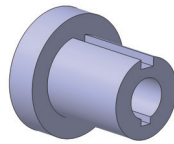
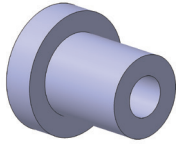

Continuous

Light interrupted

Heavy interrupted

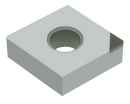
	Continuous	Light interrupted	Heavy interrupted
Precision finishing $[a_p \sim 0.020 \text{ in}]$	<p>Basic</p>  <p>With chipbreaker DX110</p> <p>B194, B196</p> <p>Wear → T-DIA DX140</p> <p>B195, B197, B198</p>	<p>Basic</p>  <p>Surface quality → With chipbreaker T-DIA DX110</p> <p>B194, B196</p> <p>Wear → T-DIA DX160</p> <p>B195, B197</p>	
Finishing $[a_p = 0.020 \sim 0.079 \text{ in}]$	<p>Basic</p>  <p>Surface quality → With chipbreaker T-DIA DX110</p> <p>B194, B196</p> <p>Wear → T-DIA DX160</p> <p>B195, B197</p>	<p>Basic</p>  <p>Fracture → P TH10</p> <p>B037</p> <p>Wear → T-DIA DX160</p> <p>B195, B197</p>	<p>Basic</p>  <p>P TH10</p> <p>B037</p>
Medium cutting $[a_p = 0.039 \sim 0.157 \text{ in}]$	<p>Basic</p>  <p>P TH10</p> <p>B037</p> <p>Wear → T-DIA DX140</p> <p>B195, B197, B198</p>	<p>Basic</p>  <p>P TH10</p> <p>B037</p> <p>Wear → T-DIA DX140</p> <p>B195, B197, B198</p>	<p>Basic</p>  <p>P TH10</p> <p>B037</p>

Please see the page B*** for the details.

Grade
Insert
Ext. Toolholder
Int. Toolholder
Threading
Grooving
Milling Cutter
Miniature Tool
Endmill
Drilling Tool
Tooling System
User's Guide
Index



Chipbreaker Guide

BASIC CHIPBREAKER: NEGATIVE TYPE

S Superalloys and titanium

Chipbreaker System for Turning (Negative type)

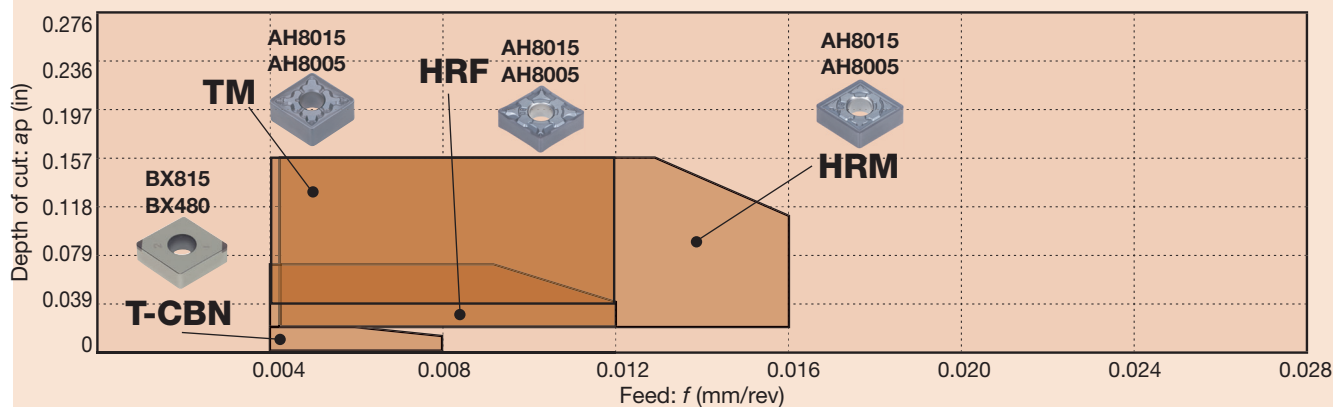

Titanium alloy

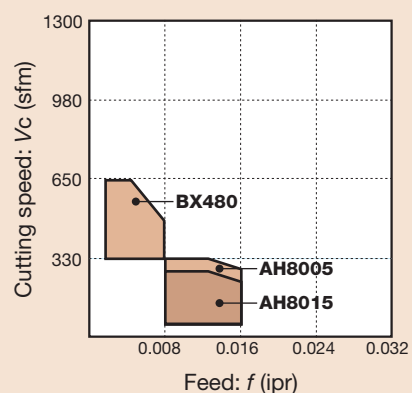

Ni-base alloy

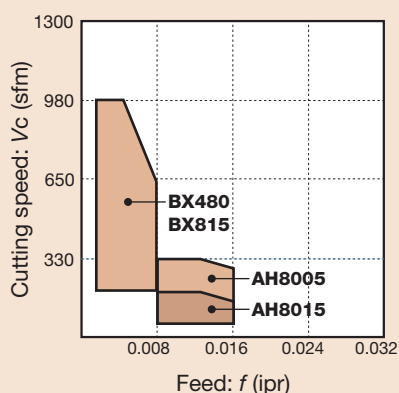

Chipbreaker	Shape	Feature	Chipbreaker	Shape	Feature
HRF		Suitable for finishing superalloy. Unique protrusion improves chip control in cutting low depth.	No chip-breaker (T-CBN)		Excellent performance in finishing of heat-resistant alloy and titanium alloy with CBN sintered body on the cutting edge.
HRM		First choice for heat-resistant alloy. The geometry optimized for a wide range of depths of cut.	TM		General-purpose chipbreaker with extensive chip control area. The protrusion in unique shape near the corner and large rake angle provide sharp cutting edge with low cutting force.

STANDARD CUTTING CONDITIONS

ISO	Operation	Work condition	Chip-breaker	Grade	Depth of cut a_p (in)	Feed f (ipr)	Cutting speed: V_c (sfm)	
							Titanium alloy	Ni-base alloy
S	Precision finishing	Continuous	Without	BX480	0.004 - 0.020	0.002 - 0.008	330 - 660	230 - 980
		Light interrupted	Without	BX815	0.004 - 0.020	0.002 - 0.008	-	230 - 1310
		Light interrupted	Without	BX480	0.004 - 0.020	0.002 - 0.008	330 - 660	-
S	Finishing to medium cutting	Continuous	HRF	AH8005	0.020 - 0.060	0.002 - 0.010	66 - 330	66 - 330
		Light interrupted	HRF	AH8015	0.020 - 0.060	0.002 - 0.010	66 - 260	66 - 160
		Heavy interrupted	HRF	AH8015	0.020 - 0.060	0.002 - 0.010	33 - 200	33 - 130
S	Medium cutting	Continuous	HRM	AH8005	0.020 - 0.160	0.004 - 0.016	66 - 330	66 - 330
		Light interrupted	HRM	AH8015	0.020 - 0.160	0.004 - 0.016	66 - 260	66 - 160
		Heavy interrupted	HRM	AH8015	0.020 - 0.160	0.004 - 0.016	33 - 200	33 - 130

Selection System

SELECTION SYSTEM: NEGATIVE TYPE

S Superalloys and titanium

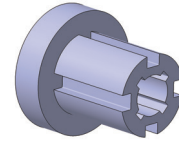
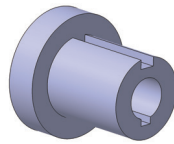
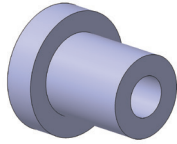

Continuous

Light interrupted

Heavy interrupted

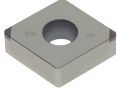
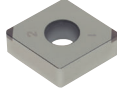
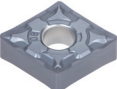
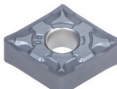
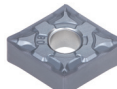
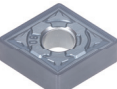
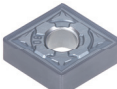
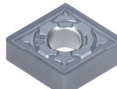
	Continuous	Light interrupted	Heavy interrupted
Precision finishing [$a_p = \sim 0.020$ in]	<p>Basic</p>  <p>T-CBN BX470 BX815</p> <p>B170 - B188</p>	<p>Basic</p>  <p>T-CBN BX470</p> <p>B170 - B188</p> <p>Fracture → No chipbreaker TH10 B038</p>	
Finishing [$a_p = 0.020 \sim 0.060$ in]	<p>Basic</p>  <p>HRF AH8005</p> <p>B033</p> <p>Fracture → HRF AH8015 B033</p> <p>Chip control → 28 AH8005 B036</p>	<p>Basic</p>  <p>HRF AH8015</p> <p>B033</p> <p>Fracture → HRM AH8015 B037</p> <p>Wear → HRF AH8005 B033</p> <p>Chip control → 28 AH8015 B036</p>	<p>Basic</p>  <p>HRF AH8015</p> <p>B033</p> <p>Fracture → HRM AH8015 B037</p> <p>Wear → HRF AH8005 B033</p>
Medium cutting [$a_p = 0.020 \sim 0.157$ in]	<p>Basic</p>  <p>HRM AH8005</p> <p>B037</p> <p>Fracture → HRM AH8015 B037</p> <p>Burr occurrence → HRF AH8015 B033</p> <p>Chip control → 28 AH8005 B036</p>	<p>Basic</p>  <p>HRM AH8015</p> <p>B037</p> <p>Fracture → TM AH8015 B034</p> <p>Wear → HRM AH8005 B037</p> <p>Chip control → 28 AH8015 B036</p>	<p>Basic</p>  <p>HRM AH8015</p> <p>B037</p> <p>Fracture → TM AH8015 B034</p> <p>Wear → HRM AH8005 B037</p>

Please see the page B*** for the details.

Chipbreaker Guide

BASIC CHIPBREAKER: NEGATIVE TYPE

H Hard Materials

Chipbreaker System for Turning (Negative type)

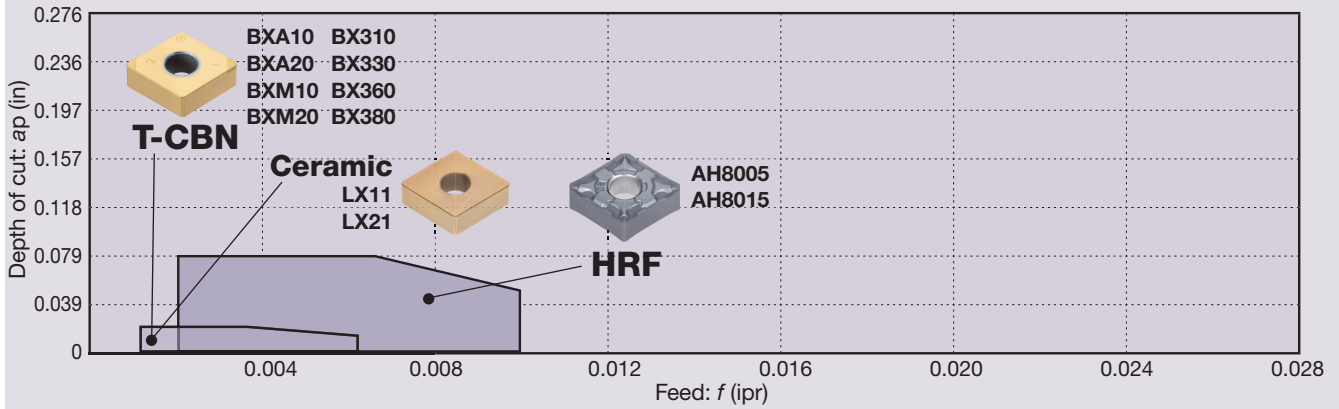

Coated T-CBN

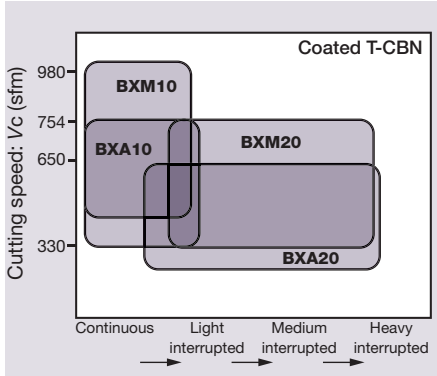

T-CBN

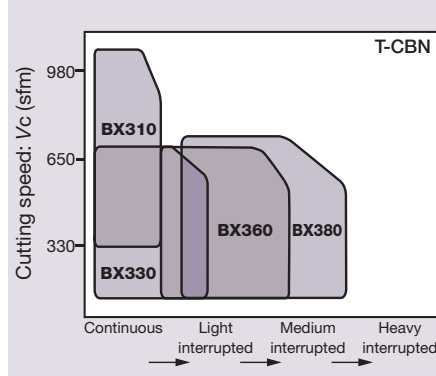

Ceramic, PVD coating

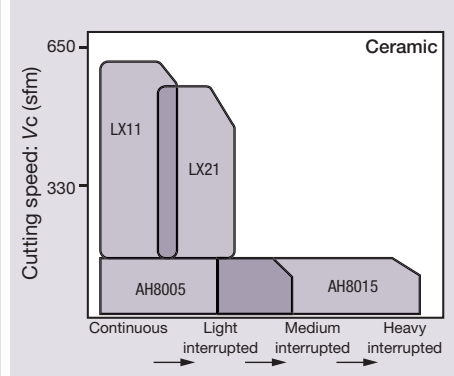

Chipbreaker	Shape	Feature
No chip-breaker (T-CBN)		Excellent performance in finishing of hard material with CBN sintered body on the cutting edge.
No chip-breaker (Ceramic)		Realizes economical hardened steel medium speed finishing.

Chipbreaker	Shape	Feature
HF		Excellent chip control in removing carburized layer at small depth of cut.
HM		Excellent chip control in removing carburized layer at large depth of cut.
HP		Excellent chip control in precision finishing.
HRF		Excellent chip control in Hardent steel medium finishing.

STANDARD CUTTING CONDITIONS

ISO	Operation	Work condition	Chipbreaker	Grade	Depth of cut ap (in)	Feed f (ipr)	Cutting speed Vc (sfm)	
H	Precision finishing	Continuous to light interrupted	HP	BXA10 BXA20 BXM10	0.002 - 0.008	0.001 - 0.007	500 - 1150	
	Finishing	Continuous to heavy interrupted	Without	BXA10 BXA20 BXM10	0.002 - 0.020	0.002 - 0.010	230 - 720	
	Finishing (Economical)	Continuous to light interrupted	Without	LX11 LX21	0.002 - 0.020	0.002 - 0.010	197 - 590	
	Removing of carburized layer	Continuous		HF	BXM20	0.008 - 0.030	0.002 - 0.008	230 - 660
				HM	BXA20 BXM20	0.020 - 0.040	0.002 - 0.008	230 - 660
	Medium cutting	Continuous to medium interrupted	HRF	AH8005 AH8015	0.002 - 0.080	0.002 - 0.010	33 - 164	

Hardened steels, Pre-hardened steels: D2, H13, etc.

Selection System

SELECTION SYSTEM: NEGATIVE TYPE



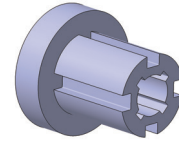
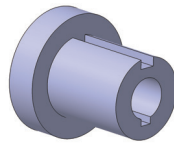
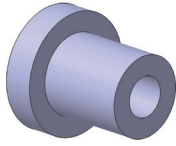

H Hard Materials



Continuous

Light interrupted

Heavy interrupted

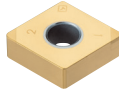
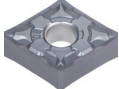
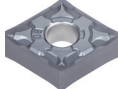
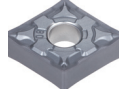
	Continuous	Light interrupted	Heavy interrupted
Precision finishing [$a_p \sim 0.008$ in.]	<p>Basic</p>  <p>T-CBN HP BXA10</p> <p>B173, B176, B182</p>	<p>Basic</p>  <p>T-CBN BXA20</p> <p>B172 - B181</p> <p>Fracture → -H BXM20 B172 - B180</p> <p>High-speed wear → T-CBN BXA10 B172 - B181</p>	
Finishing [$a_p \sim 0.020$ in.]	<p>Basic</p>  <p>T-CBN BXA10</p> <p>B172 - B181</p> <p>Eco-nomizing → LX11 B065</p>	<p>Basic</p>  <p>T-CBN BXA20</p> <p>B172 - B181</p> <p>Fracture → -H BXM20 B172 - B180</p> <p>High-speed wear → T-CBN BXA10 B172 - B181</p> <p>Eco-nomizing → LX21 B065</p>	<p>Basic</p>  <p>T-CBN BXM20</p> <p>B172 - B181</p> <p>Fracture → -H BXM20 B172 - B180</p>
Medium cutting [$a_p \sim 0.020$ in.]	<p>Basic</p>  <p>HRF AH8005</p> <p>B058</p> <p>Fracture → HRF AH8015 B172 - B180</p>	<p>Basic</p>  <p>HRF AH8015</p> <p>B058</p> <p>Fracture → HRM AH8015 B058</p>	<p>Basic</p>  <p>HRF AH8015</p> <p>B058</p> <p>Fracture → HRM AH8015 B058</p>

Please see the page B*** for the details.

Grade
Insert
Ext. Toolholder
Int. Toolholder
Threading
Grooving
Milling Cutter
Miniature Tool
Endmill
Drilling Tool
Tooling System
User's Guide
Index



Chipbreaker Guide

BASIC CHIPBREAKER: POSITIVE TYPE

P Steel

Chipbreaker System for Turning (Positive Type)

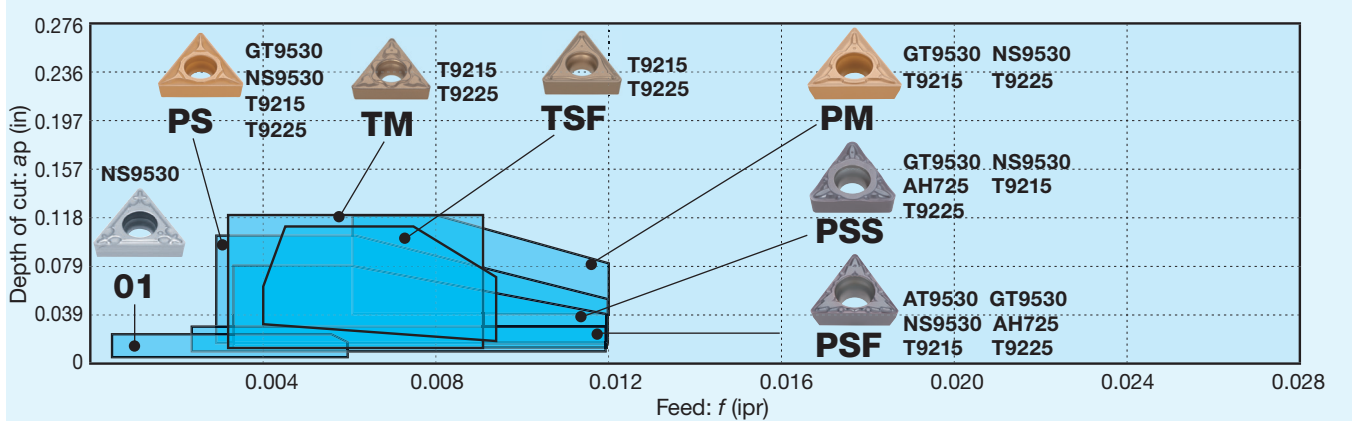

CVD / PVD coated grade

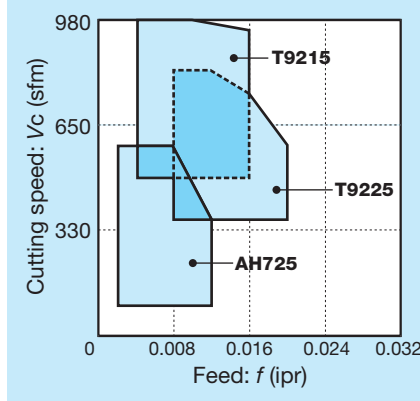

Coated cermet / Cermet

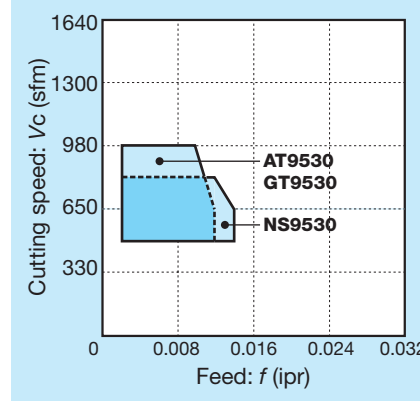

Chipbreaker	Shape	Feature
01		Excellent chip control in machining very small depth of cut thanks to the sharp cutting edge and protrusion.
PSF		Low cutting force and high wear resistance. First choice for finishing. Excellent chip control in finishing prevents chip entanglement in internal machining.
PSS		3D chipbreaker for finishing to medium cutting with excellent chip control and low cutting force.

Chipbreaker	Shape	Feature
PS		3D chipbreaker for finishing to medium cutting with excellent chip control and sharpness. M-class insert delivers cost reduction and highly efficient boring in a wide range of applications.
PM		First choice for medium cutting with excellent sharpness and good chip control. Delivers stable machining of stainless steel.

Chipbreaker	Shape	Feature
TSF		Optimal chipbreaker geometry ensures smooth chip control in a high feed range.
TM		Optimal cutting edge and chipbreaker geometry provides effective chip evacuation at greater depths of cut.

STANDARD CUTTING CONDITIONS

ISO	Operation	Work condition	Chip-breaker	Grade	Depth of cut ap (in)	Feed f (ipr)	Cutting speed: Vc (sfm)		
							Low carbon steels, Alloy steels	Medium carbon steels, Alloy steels	High carbon steels, Alloy steels
P	Precision finishing	Continuous	01	NS9530	0.002 - 0.020	0.001 - 0.006	500 - 820	260 - 720	260 - 590
		Light interrupted	01	NS9530	0.002 - 0.020	0.001 - 0.006	500 - 820	260 - 720	260 - 590
	Finishing	Continuous	PSS	NS9530	0.004 - 0.020	0.002 - 0.012	500 - 820	260 - 720	260 - 590
		Light interrupted	PSS	NS9530	0.004 - 0.020	0.002 - 0.012	500 - 820	260 - 720	260 - 590
		Heavy interrupted	PSS	NS9530	0.004 - 0.020	0.002 - 0.012	500 - 820	260 - 720	260 - 590
		Continuous	PS	NS9530	0.012 - 0.079	0.003 - 0.012	500 - 820	260 - 720	260 - 590
	Finishing to light cutting	Light interrupted	PS	NS9530	0.012 - 0.079	0.003 - 0.012	500 - 820	260 - 720	260 - 590
		Heavy interrupted	PS	NS9530	0.012 - 0.079	0.003 - 0.012	500 - 820	260 - 720	260 - 590
			Continuous to Heavy interrupted	PS	T9215	0.020 - 0.098	0.003 - 0.012	400 - 1148	330 - 1148
	Finishing to Medium cutting	Heavy interrupted	PS	T9225	0.020 - 0.098	0.003 - 0.012	330 - 660	260 - 980	260 - 820
Continuous to Heavy interrupted		PM	-	0.040 - 0.120	0.006 - 0.012	500 - 980	330 - 660	260 - 590	
Medium cutting	Continuous to Heavy interrupted	PM	-	0.040 - 0.120	0.006 - 0.012	400 - 820	260 - 590	260 - 400	

Low carbon steels, Alloy steels: 1018, 1020, etc. Medium carbon steels, Alloy steels: 1045, 4140, etc. Hi carbon steels, Alloy steels: 8620, etc.

Selection System

SELECTION SYSTEM: POSITIVE TYPE

P Steel

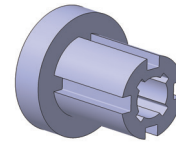
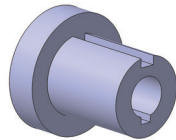
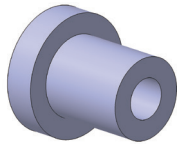

Continuous

Light interrupted

Heavy interrupted

	Continuous	Light interrupted	Heavy interrupted
Precision finishing [$a_p \sim 0.020$ in.]	<p>Basic</p>  <p>01 NS9530</p> <p>B042, B047</p>	<p>Basic</p>  <p>01 NS9530</p> <p>B042, B047</p> <p>Fracture → PSF NS9530 B042, B047, B051</p>	
Finishing [$a_p = 0.004 \sim 0.020$ in.]	<p>Basic</p>  <p>PSS NS9530</p> <p>B042, B047, B051</p> <p>Wear → PSS GT9530 B042, B047, B051</p> <p>Fracture → PS NS9530 B042, B047, B051</p> <p>Chip control → PSF NS9530 B042, B047, B051</p>	<p>Basic</p>  <p>PSS NS9530</p> <p>B042, B047, B051</p> <p>Wear → PSS GT9530 B042, B047, B051</p> <p>Fracture → PS NS9530 B042, B047, B051</p> <p>Chip control → PSF NS9530 B042, B047, B051</p>	<p>Basic</p>  <p>PSS NS9530</p> <p>B042, B047, B051</p> <p>Wear → PSS GT9530 B042, B047, B051</p> <p>Fracture → PS NS9530 B042, B047, B051</p> <p>Chip control → PSF NS9530 B042, B047, B051</p>
Finishing to medium cutting [$a_p = 0.020 \sim 0.098$ in.]	<p>Basic</p>  <p>PS T9215</p> <p>B042, B047, B051</p> <p>Fracture → PS T9225 B042, B047, B051</p> <p>Wear → PS NS9530 B042, B047, B051</p>	<p>Basic</p>  <p>PS T9215</p> <p>B042, B047, B051</p> <p>Fracture → PS T9225 B042, B047, B051</p> <p>Wear → PS NS9530 B042, B047, B051</p>	<p>Basic</p>  <p>PS T9215</p> <p>B042, B047, B051</p> <p>Fracture → PM T9225 B044, B048</p> <p>Chip control → TSF T9215 B042, B047</p>
Medium cutting [$a_p = 0.039 \sim 0.118$ in.]	<p>Basic</p>  <p>PM T9215</p> <p>B044, B048</p> <p>Wear → PM NS9530 B044, B048</p>	<p>Basic</p>  <p>PM T9215</p> <p>B044, B048</p> <p>Fracture → PM T9255 B044, B048</p>	<p>Basic</p>  <p>PM T9215</p> <p>B044, B048</p> <p>Chip control → TM T9215 B043, B047</p>

Please find the details on the pages: B***/7° relief angle, B***/11° relief angle, B***/5° relief angle.



Chipbreaker Guide

BASIC CHIPBREAKER: POSITIVE TYPE

M Stainless Steel

Chipbreaker System for Turning (Positive Type)

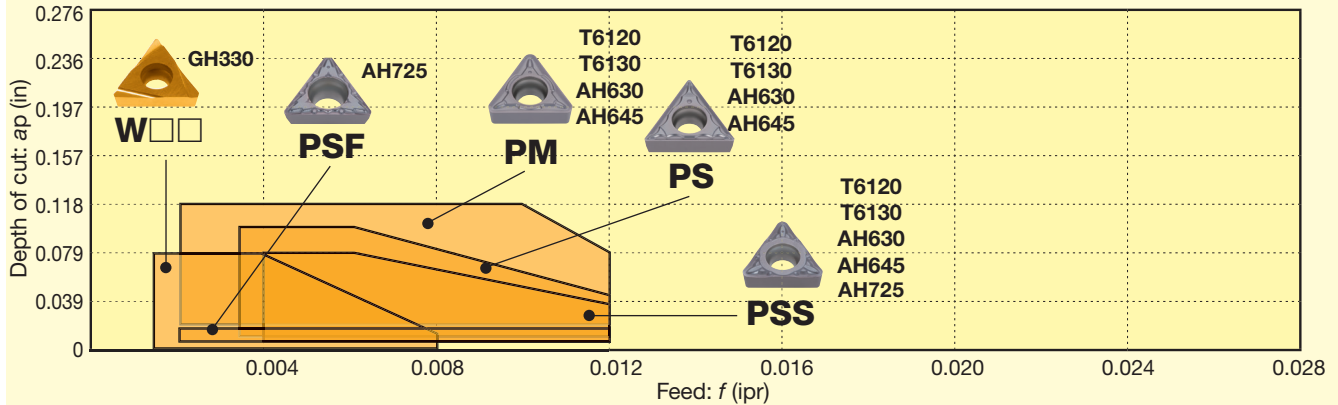

CVD coated grade

PVD coated grade

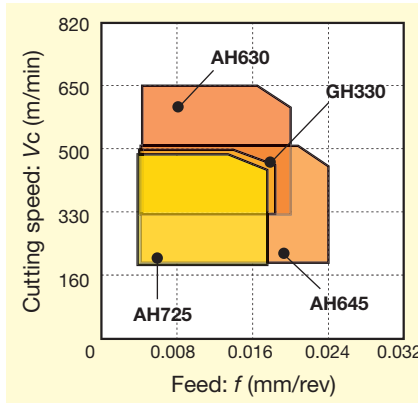
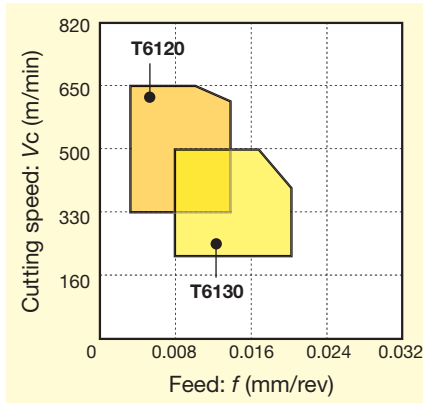

Chipbreaker	Shape	Feature
W□□		Designed to control the direction of chip flow in precision finishing. Smooth chip evacuation in boring.
PSF		Low cutting force and high wear resistance. First choice for finishing. Excellent chip control in finishing prevents chip entanglement in internal machining.

Chipbreaker	Shape	Feature
PSS		3D chipbreaker for finishing to medium cutting with excellent chip control and low cutting force.
PS		3D chipbreaker for finishing to medium cutting with excellent chip control and sharpness. M-class insert delivers cost reduction and highly efficient boring in a wide range of applications.
PM		First choice for medium cutting with excellent sharpness and good chip control. Delivers stable machining of stainless steel.

STANDARD CUTTING CONDITIONS

ISO	Operation	Work condition	Chipbreaker	Grade	Depth of cut ap (in)	Feed f (ipr)	Cutting speed Vc (sfm)
M	Precision finishing	Continuous	W□□	GH330	0.002 - 0.079	0.001 - 0.008	330 - 500
		Continuous	PSF	AH725	0.004 - 0.020	0.002 - 0.012	160 - 500
	Finishing	Light interrupted	PSF	AH725	0.004 - 0.020	0.002 - 0.012	160 - 500
		Heavy interrupted	PSF	AH725	0.004 - 0.020	0.002 - 0.012	160 - 400
	Finishing to light cutting	Continuous	PSS	AH630	0.012 - 0.079	0.003 - 0.012	300 - 620
		Light interrupted	PSS	AH630	0.012 - 0.079	0.003 - 0.012	300 - 620
		Heavy interrupted	PSS	AH630	0.012 - 0.079	0.003 - 0.012	300 - 620
	Finishing to medium cutting	Continuous	PS	T6130	0.020 - 0.098	0.003 - 0.012	330 - 660
		Light interrupted	PS	AH630	0.020 - 0.098	0.003 - 0.012	300 - 620
		Heavy interrupted	PS	AH630	0.020 - 0.098	0.003 - 0.012	300 - 620
	Medium cutting	Continuous	PM	T6130	0.040 - 0.120*	0.006 - 0.012	330 - 660
		Light interrupted	PM	AH630	0.040 - 0.120*	0.006 - 0.012	300 - 620
		Heavy interrupted	PM	AH630	0.040 - 0.120*	0.006 - 0.012	300 - 620

* For CCMT0602 and DCMT0702 type inserts, ap = 0.020 - 0.098, Stainless steels: 304SS, 316SS, etc.

Selection System

SELECTION SYSTEM: POSITIVE TYPE

M Stainless Steel

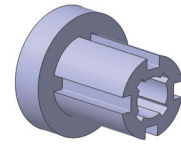
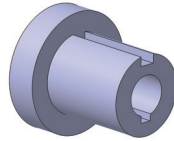
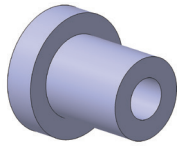

Continuous

Light interrupted

Heavy interrupted

	Continuous	Light interrupted	Heavy interrupted
Precision finishing [$a_p = \sim 0.020$ in.]	<p>Basic</p>  <p>W GH330</p> <p>B043, B048, B051</p>	<p>Basic</p>  <p>W GH330</p> <p>B043, B048, B051</p>	
Finishing [$a_p = 0.012 \sim 0.060$ in.]	<p>Basic</p>  <p>PSF AH725</p> <p>B042, B047, B051</p> <p>Wear → PSS T6130 B042, B047, B051</p>	<p>Basic</p>  <p>PSF AH725</p> <p>B042, B047, B051</p> <p>Fracture → PSS AH630 B042, B047, B051</p> <p>Wear → PSS T6130 B042, B047, B051</p>	<p>Basic</p>  <p>PSF AH725</p> <p>B042, B047, B051</p> <p>Fracture → PSS AH630 B042, B047, B051</p>
Finishing to medium cutting [$a_p = 0.020 \sim 0.098$ in.]	<p>Basic</p>  <p>PSS AH630</p> <p>B042, B047, B051</p> <p>Wear → PS T6130 B042, B047, B051</p>	<p>Basic</p>  <p>PS AH630</p> <p>B042, B047, B051</p> <p>Fracture → PM AH645 B044, B048</p> <p>Wear → PS T6130 B042, B047, B051</p>	<p>Basic</p>  <p>PS AH630</p> <p>B042, B047, B051</p> <p>Fracture → PM AH645 B044, B048</p> <p>Wear → PS T6130 B042, B047, B051</p>
Medium cutting [$a_p = 0.039 \sim 0.118$ in.]	<p>Basic</p>  <p>PM T6130</p> <p>B044, B048</p>	<p>Basic</p>  <p>PM AH630</p> <p>B044, B048</p> <p>Fracture → PM AH645 B044, B048</p> <p>Wear → PM T6130 B044, B048</p>	<p>Basic</p>  <p>PM AH630</p> <p>B044, B048</p> <p>Fracture → PM AH645 B044, B048</p>

Please find the details on the pages: B***/7° relief angle, B***/11° relief angle, B***/5° relief angle.



Chipbreaker Guide

BASIC CHIPBREAKER: POSITIVE TYPE

K Cast Iron

Chipbreaker System for Turning (Positive Type)

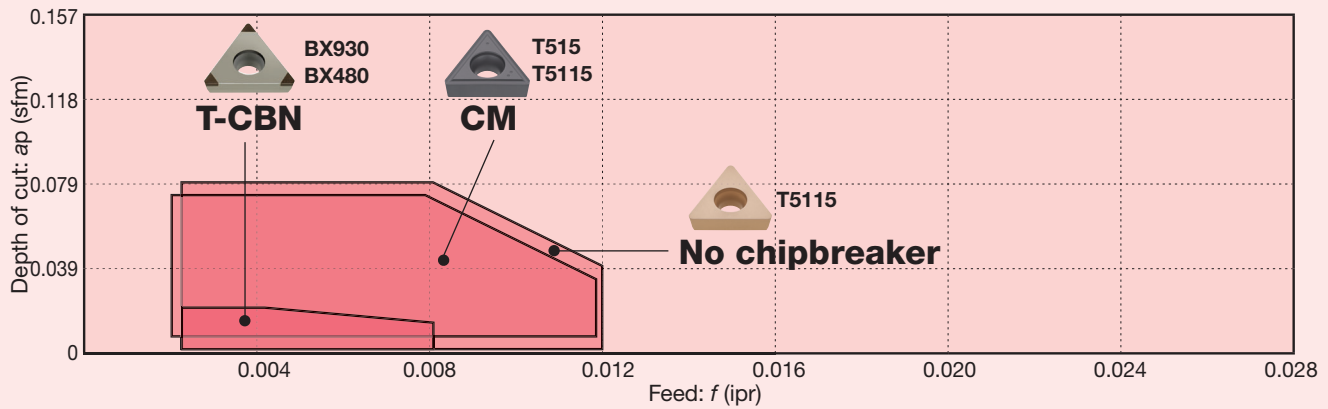

Grey cast iron

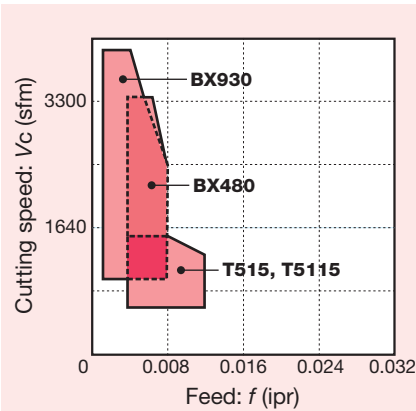

Ductile cast iron

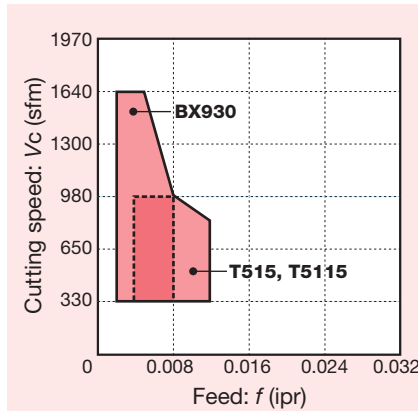

Chipbreaker	Shape	Feature
No chip-breaker (T-CBN)		Excellent performance in high-speed finishing of cast iron with CBN sintered body on the cutting edge.
No chip-breaker		Suitable for a wide range of applications from finishing to roughing cast iron. Excellent performance with high cutting edge strength.

Chipbreaker	Shape	Feature
CM		Highly versatile all-round chipbreaker with low cutting force. Suitable for finishing to medium cutting.

STANDARD CUTTING CONDITIONS

ISO	Operation	Work condition	Chip-breaker	Grade	Depth of cut ap (in)	Feed f (ipr)	Cutting speed: Vc (sfm)	
							Grey cast iron	Ductile cast iron
K	Precision finishing	Continuous	Without	BX930	0.002 - 0.020	0.002 - 0.008	980 - 3940	330 - 1640
		Light interrupted	Without	BX480	0.002 - 0.020	0.002 - 0.008	980 - 2630	330 - 980
		Light interrupted	Without	BX470	0.002 - 0.020	0.002 - 0.008	980 - 2630	330 - 980
	Finishing	Continuous	CM	T515	0.002 - 0.079	0.002 - 0.012	500 - 2300	500 - 980
		Heavy interrupted	CM	T515	0.002 - 0.079	0.002 - 0.012	330 - 660	330 - 660
	Medium cutting	Light interrupted	CM	T515	0.002 - 0.079	0.002 - 0.012	330 - 980	330 - 820

Grey cast irons: Class 25, etc. , Ductile cast irons: 65-45-12, etc.

Selection System

SELECTION SYSTEM: POSITIVE TYPE

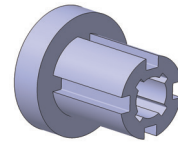
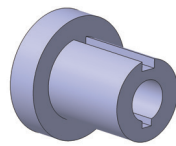
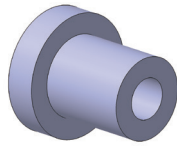

K Cast Iron



Continuous

Light interrupted

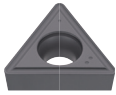
Heavy interrupted

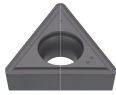
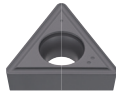
Finishing to Medium cutting [$a_p = 0.020 \sim 0.118$ in]	<p>Basic</p>  <p>CM T515</p> <p>B044, B048, B051</p>	<p>Wear</p>  <p>T-CBN BX930</p> <p>B183 -</p>
	<p>Basic</p>  <p>CM T515</p> <p>B044, B048, B051</p>	
	<p>Basic</p>  <p>CM T515</p> <p>B044, B048, B051</p>	

Please find the details on the pages: **B**/7° relief angle**, **B**/11° relief angle**, **B**/5° relief angle**.

Grade
Insert
Ext. Toolholder
Int. Toolholder
Threading
Grooving
Milling Cutter
Miniature Tool
Endmill
Drilling Tool
Tooling System
User's Guide
Index



Chipbreaker Guide

BASIC CHIPBREAKER: POSITIVE TYPE

N Non-ferrous Metal

Chipbreaker System for Turning (Positive Type)

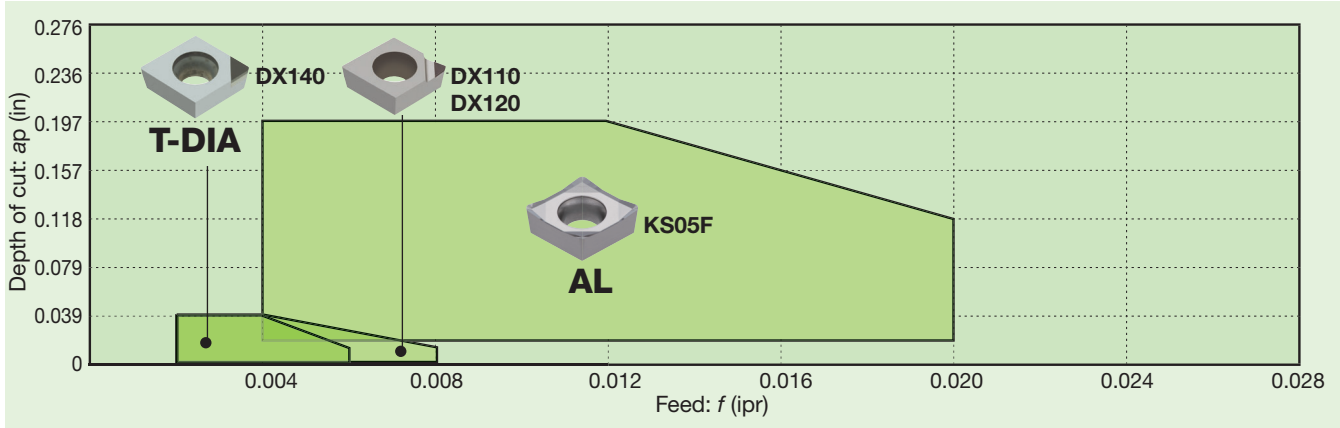

Aluminum alloy (Si < 12%)

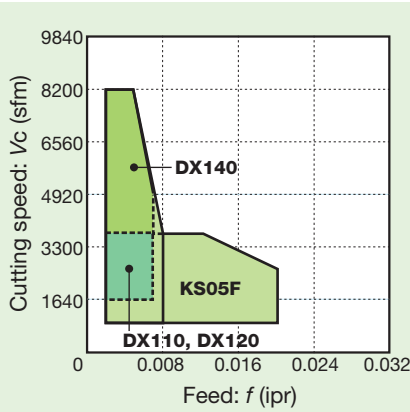

Aluminum alloy (Si ≥ 12%)

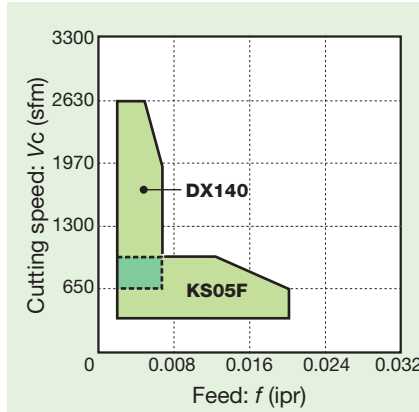

Copper alloy

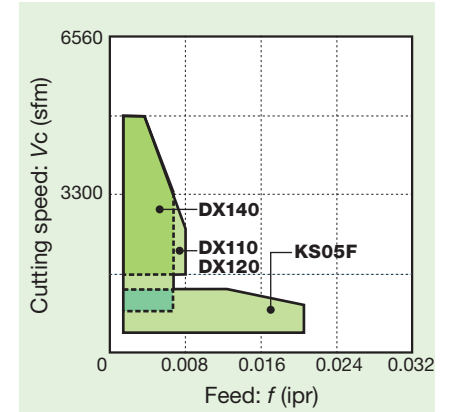

Chipbreaker	Shape	Feature
No chip-breaker (T-DIA)		Excellent performance in high-speed finishing of non-ferrous metal with diamond sintered body on the cutting edge.
AL		Large rake angle and sharp cutting edge reduce cutting force. Lapped rake face prevents adhesion. Large inclination on the cutting edge (wavy cutting edge) for more stable chip control.

Chipbreaker	Shape	Feature
With chip-breaker (T-DIA)		Wide chipbreaker for smooth chip evacuation. Large rake face reduces cutting force. DIA on the cutting edge delivers high-speed machining and long tool life.

STANDARD CUTTING CONDITIONS

ISO	Operation	Work condition	Chip-breaker	Grade	Depth of cut ap (in)	Feed f (ipr)	Cutting speed: Vc (sfm)		
							Aluminum alloy (Si < 12%)	Aluminum alloy (Si ≥ 12%)	Copper alloy
N	Precision finishing	Continuous	With	DX110	0.002 - 0.040	0.002 - 0.006	1640 - 8200	1310 - 2630	1640 - 4920
		Light interrupted	Without	DX140	0.002 - 0.040	0.002 - 0.008	980 - 8200	-	1640 - 4920
	Finishing	Continuous	Without	DX140	0.002 - 0.040	0.002 - 0.006	1640 - 8200	1310 - 2630	1640 - 4920
		Light interrupted	Without	DX140	0.002 - 0.040	0.002 - 0.006	980 - 5900	1310 - 1970	1310 - 3940
		Heavy interrupted	AL	KS05F	0.020 - 0.197	0.004 - 0.020	330 - 1970	330 - 660	-
	Medium cutting	Continuous	AL	KS05F	0.020 - 0.197	0.004 - 0.020	330 - 3940	330 - 980	330 - 980
Light interrupted		AL	KS05F	0.020 - 0.197	0.004 - 0.020	330 - 2950	330 - 660	330 - 660	
Heavy interrupted		AL	KS05F	0.020 - 0.197	0.004 - 0.020	330 - 1970	330 - 660	-	

Selection System

SELECTION SYSTEM: POSITIVE TYPE

N Non-ferrous Metal

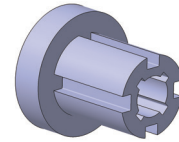
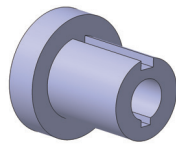
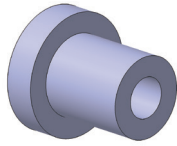

Continuous

Light interrupted

Heavy interrupted

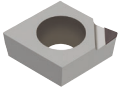
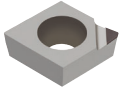
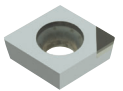
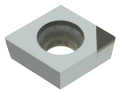
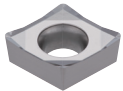
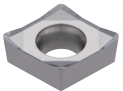
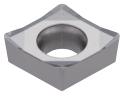
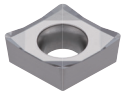
	Continuous	Light interrupted	Heavy interrupted
Precision finishing [$a_p \sim 0.020$ in.]	<p>Basic</p>  <p>With chipbreaker DX110</p> <p>B194, B196</p> <p>Wear → T-DIA DX140 B195, B197, B198</p>	<p>Basic</p>  <p>With chipbreaker DX110</p> <p>B194, B196</p> <p>Wear → T-DIA DX140 B195, B197, B198</p>	
Finishing [$a_p = 0.020 \sim 0.079$ in.]	<p>Basic</p>  <p>T-DIA DX140</p> <p>B195, B197, B198</p> <p>Wear → T-DIA DX160 B195, B197</p> <p>Chip control → With chipbreaker T-DIA DX110 B194, B196</p>	<p>Basic</p>  <p>T-DIA DX140</p> <p>B195, B197, B198</p> <p>Fracture → AL KS05F B044</p> <p>Wear → T-DIA DX160 B195, B197</p>	<p>Basic</p>  <p>AL KS05F</p> <p>B044</p>
Medium cutting [$a_p = 0.039 \sim 0.197$ in.]	<p>Basic</p>  <p>AL KS05F</p> <p>B044</p> <p>Wear → With chipbreaker T-DIA DX120 B194, B196</p>	<p>Basic</p>  <p>AL KS05F</p> <p>B044</p> <p>Wear → T-DIA DX140 B195, B197, B198</p>	<p>Basic</p>  <p>AL KS05F</p> <p>B044</p>

Please find the details on the pages: B***/7° relief angle, B***/11° relief angle, B***/5° relief angle.

Grade
Insert
Ext. Toolholder
Int. Toolholder
Threading
Grooving
Milling Cutter
Miniature Tool
Endmill
Drilling Tool
Tooling System
User's Guide
Index



Chipbreaker Guide

BASIC CHIPBREAKER: POSITIVE TYPE

S Superalloys and titanium

Chipbreaker System for Turning (Positive Type)

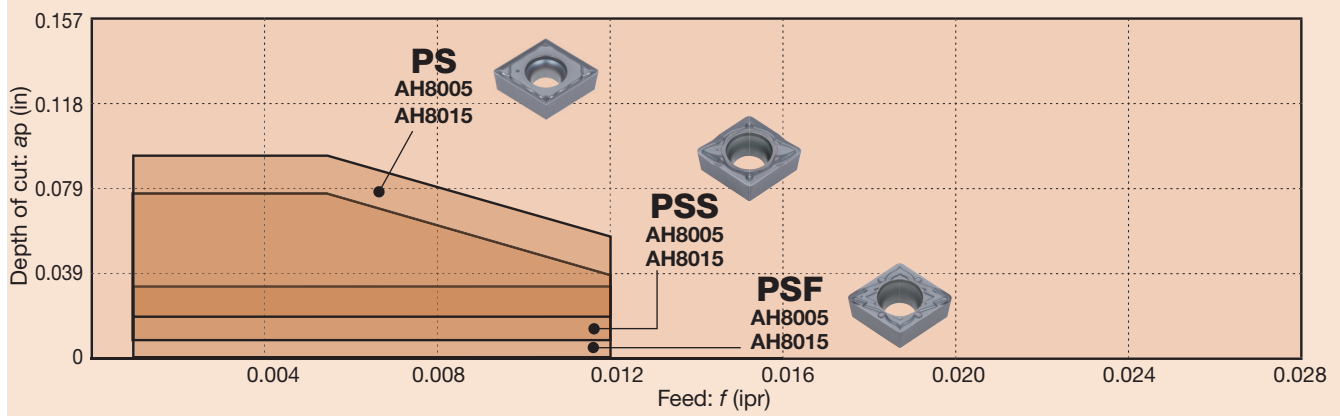

Titanium alloy

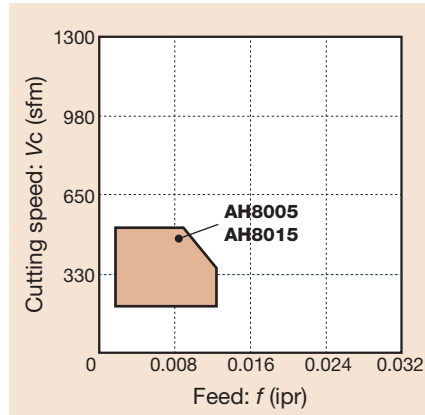

Ni-base alloy

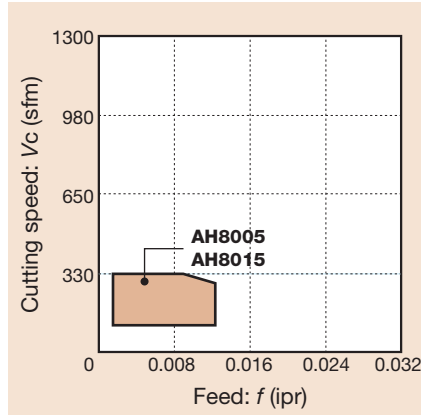

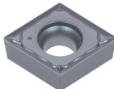
Chipbreaker	Shape	Feature
PS		3D chipbreaker for finishing to medium cutting with excellent chip control and sharpness. M-class insert delivers cost reduction and highly efficient boring in a wide range of applications.

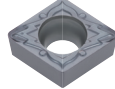
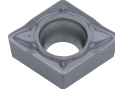
Chipbreaker	Shape	Feature
PSF		Low cutting force and high wear resistance. First choice for finishing. Excellent chip control in finishing prevents chip entanglement in internal machining.
PSS		3D chipbreaker for finishing to medium cutting with excellent chip control and low cutting force.

STANDARD CUTTING CONDITIONS

ISO	Operation	Work condition	Chip-breaker	Grade	Depth of cut ap (in)	Feed f (ipr)	Cutting speed: Vc (sfm)	
							Titanium alloy	Ni-base alloy
S	Finishing	Continuous	PSS	AH8015	0.012 - 0.079	0.001 - 0.012	66 - 500	66 - 330
		Light interrupted	PSS	AH8015	0.012 - 0.079	0.001 - 0.012	66 - 500	66 - 330
	Finishing to medium cutting	Continuous	PS	AH8015	0.020 - 0.098	0.001 - 0.012	66 - 500	66 - 330
		Light interrupted	PS	AH8015	0.020 - 0.098	0.001 - 0.012	66 - 500	66 - 330

Ni-base alloy: INCONEL718, etc.

Titanium alloy: Ti-6Al-4V, etc.

Selection System

SELECTION SYSTEM: POSITIVE TYPE

S Superalloys and titanium

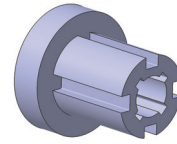
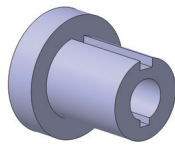
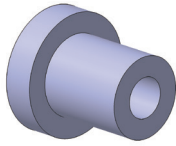

Continuous

Light interrupted

Heavy interrupted

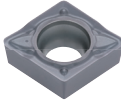
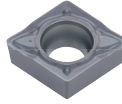
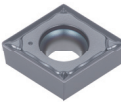
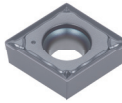
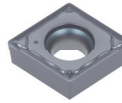
	Continuous	Light interrupted	Heavy interrupted
Finishing $[a_p = 0.012 \sim 0.079 \text{ in}]$	<p>Basic</p>  <p>PSS AH8015</p> <p>B042, B047, B051</p> <p>Wear → PSS AH8005 B044, B047, B051</p>	<p>Basic</p>  <p>PSS AH8015</p> <p>B042, B047, B051</p> <p>Wear → PSS AH8005 B042, B047, B051</p> <p>Fracture → PS AH8015 B042, B047, B051</p>	
Finishing to medium cutting $[a_p = 0.020 \sim 0.098 \text{ in}]$	<p>Basic</p>  <p>PS AH8015</p> <p>B042, B047, B051</p> <p>Wear → PSS AH8005 B042, B047, B051</p>	<p>Basic</p>  <p>PS AH8015</p> <p>B042, B047, B051</p> <p>Fracture → All-round AH8015 B044, B049</p>	<p>Basic</p>  <p>PS AH8015</p> <p>B042, B047, B051</p> <p>Fracture → All-round AH8015 B044, B049</p>

Please find the details on the pages: B***/7° relief angle, B***/11° relief angle, B***/5° relief angle.

Grade
Insert
Ext. Toolholder
Int. Toolholder
Threading
Grooving
Milling Cutter
Miniature Tool
Endmill
Drilling Tool
Tooling System
User's Guide
Index



Chipbreaker Guide

BASIC CHIPBREAKER: POSITIVE TYPE

H Hard Materials

Chipbreaker System for Turning (Positive Type)

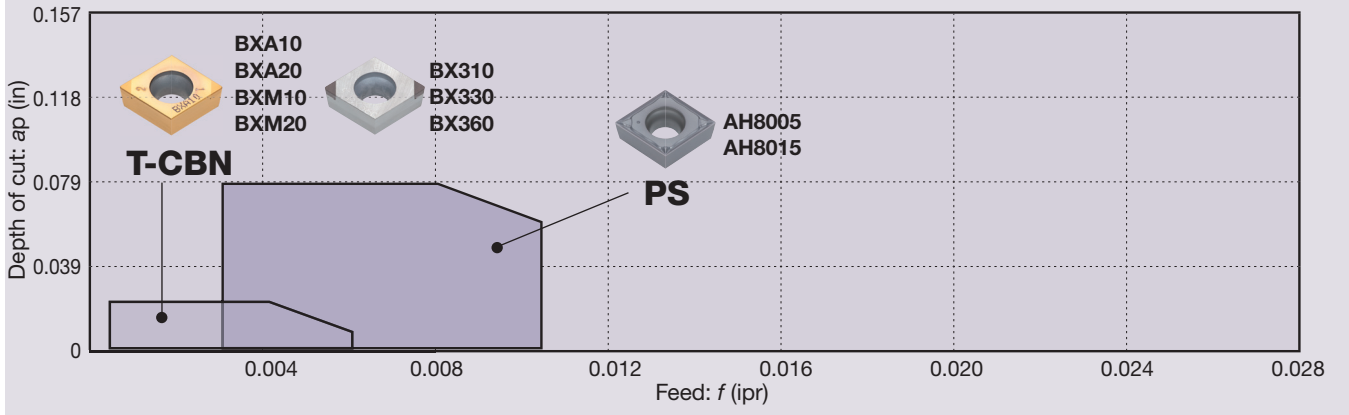

Coated T-CBN

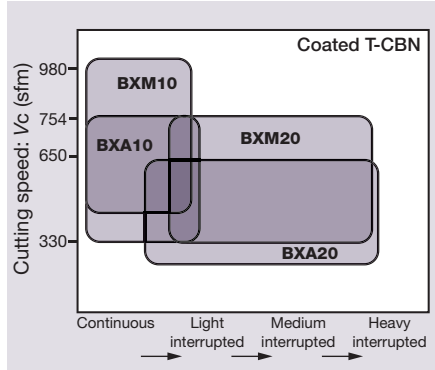

T-CBN

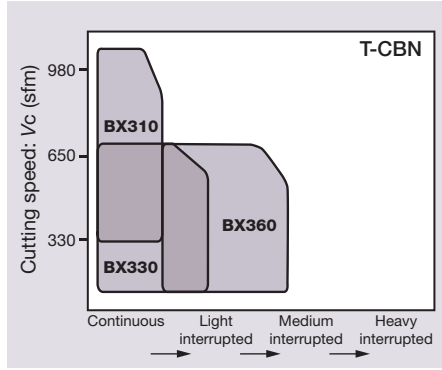

PVD coating

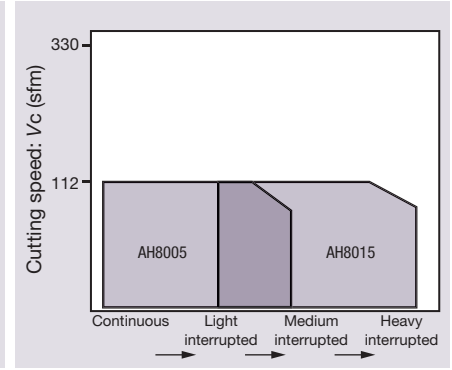

Chipbreaker	Shape	Feature
No chip-breaker (T-CBN)		Excellent performance in high-speed finishing of hard material with CBN sintered body on the cutting edge.

Chipbreaker	Shape	Feature
HP (T-CBN)		Excellent chip control in precision finishing.
PS		Excellent chip control in hardened steel medium finishing.

STANDARD CUTTING CONDITIONS

ISO	Operation	Work condition	Chipbreaker	Grade	Depth of cut a_p (in)	Feed f (ipr)	Cutting speed V_c (sfm)
H	Precision finishing	Continuous	HP	BXA10 BXA20 BXM10	0.002 - 0.080	0.001 - 0.006	500 - 1150
		Light interrupted	Without	BXA20 BXM20	0.002 - 0.080	0.001 - 0.006	230 - 720
	Finishing	Continuous to heavy interrupted	Without	BXA10 BXA20 BXM10	0.003 - 0.020	0.002 - 0.012	230 - 720
		Medium cutting	Continuous to medium interrupted	PS	AH8005 AH8015	0.002 - 0.080	0.002 - 0.010

Hardened steels, Pre-hardened steels: D2, H13, etc.

Selection System

SELECTION SYSTEM: POSITIVE TYPE

H Hard Materials

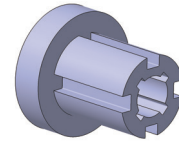
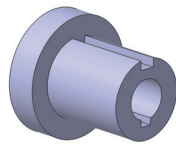
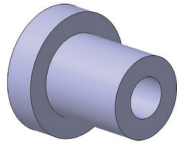

Continuous

Light interrupted

Heavy interrupted

Precision finishing
[$a_p \sim 0.012$ in.]

Basic



**T-CBN
HP
BXA10**

B173, B176, B182

Basic

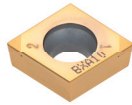

**T-CBN
BXA10**

B173, B176, B182

Fracture

**T-CBN
BXA20**

B172 - B184
B188 - B189
B191 - B192

Finishing
[$a_p \sim 0.020$ in.]

Basic

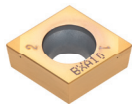

**T-CBN
BXA10**

B173, B176, B182

Basic

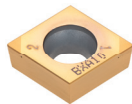

**T-CBN
BXA10**

B173, B176, B182

Fracture

**T-CBN
BXM20**

B182 - B192

Basic

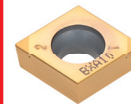

**T-CBN
BXA20**

B173, B176, B182

Fracture

**T-CBN
BXA20-H**

B172 - B184
B188 - B189
B191 - B192

Medium cutting
[$a_p \sim 0.020$ in.]

Basic

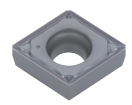

**PS
AH8005**

B112, B118, B153

Fracture

**PS
AH8015**

B112, B118, B153

Basic

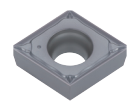

**PS
AH8015**

B112, B118, B153

Fracture

**All-round
AH8015**

B120

Basic

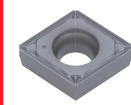

**PS
AH8015**

B112, B118, B153

Fracture

**All-round
AH8015**

B120

Please find the details on the pages: B***/7° relief angle, B***/11° relief angle, B***/5° relief angle.

Grade

Insert

Ext. Toolholder

Int. Toolholder

Threading

Grooving

Milling Cutter

Miniature Tool

Endmill

Drilling Tool











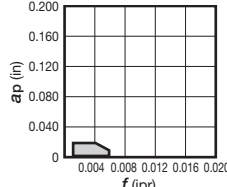
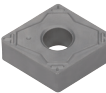
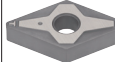

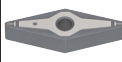
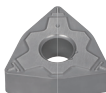
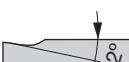
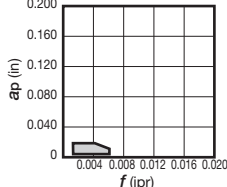
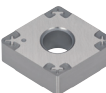
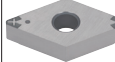

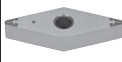

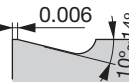
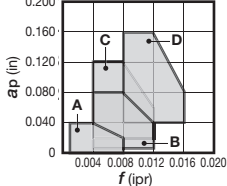
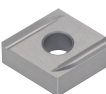



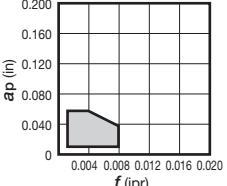
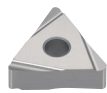
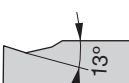
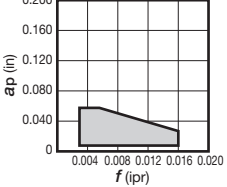

Tooling System

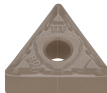
User's Guide

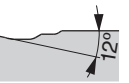
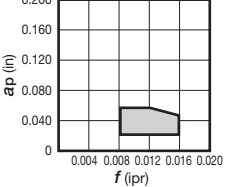
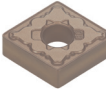
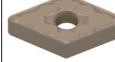
Index

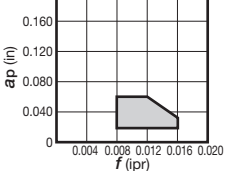
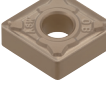

Chipbreaker Overview







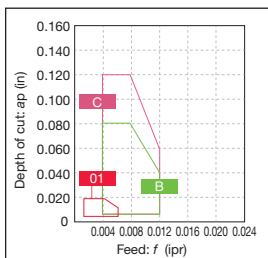
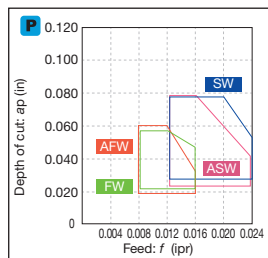
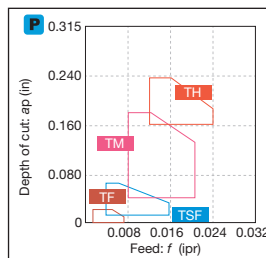



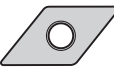

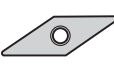

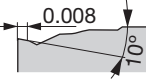

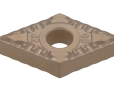

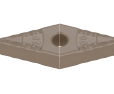

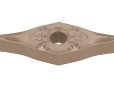

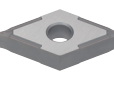

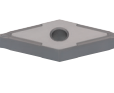







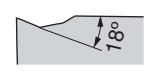

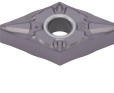

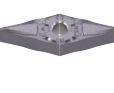

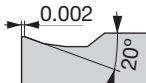

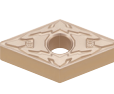

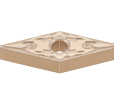

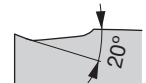

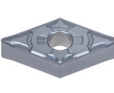
Application	Negative type with hole	C	D	S	T	V	W	Y
		80°	55°	90°	60°	35°	80°	25°
Precision finishing	TF  	 B056	 B067	 B077	 B086	 B096	 B101	
	01  	 B056	 B067	 B077	 B086	 B096	 B101	
	A~D  	 B056		 B077	 B086			
	W  				 B087			
Finishing	TSF  	 B056	 B067	 B077	 B087	 B097	 B102	
	Finishing (wiper)	FW  	 B056	 B067		 B087		 B102
AFW  		 B056						 B102

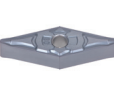
Please see the page B*** for the product details.

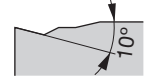
Chip control range

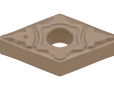

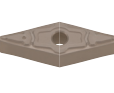
Chipbreaker Overview

Application	Negative type with hole	C	D	S	T	V	W	Y
								
		80°	55°	90°	60°	35°	80°	25°
Finishing	ZF  ap (in) vs f (ipr) graph							
	11  ap (in) vs f (ipr) graph							
Finishing (for mild steel)	17  ap (in) vs f (ipr) graph							
	SF  ap (in) vs f (ipr) graph							
Finishing	CF  ap (in) vs f (ipr) graph							
	HRF  ap (in) vs f (ipr) graph							
	TS  ap (in) vs f (ipr) graph							
		B057	B068	B078	B088	B097	B102	B109

Please see the page B*** for the product details.

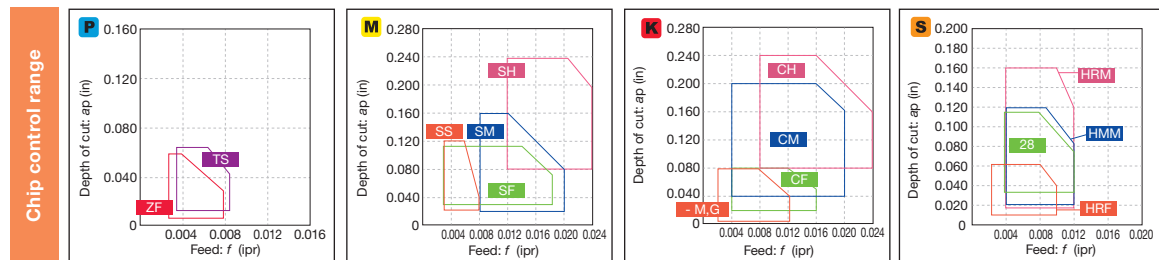

*-M,G: Without chipbreaker

Chipbreaker Overview

Application	Negative type with hole	C	D	S	T	V	W	Y
		80°	55°	90°	60°	35°	80°	25°
Finishing to medium cutting (wiper)	SW 	 B058	 B069		 B089		 B104	
	ASW 	 B058					 B104	
High feed, small depth of cut	AS 	 B058	 B069	 B078	 B089		 B104	
	CB 	 B058	 B069		 B089		 B104	
Finishing	NS 	 B058	 B069	 B079	 B089		 B104	
	SS 	 B059	 B070	 B079	 B090	 B098	 B104	
Medium cutting	TM 	 B059	 B070	 B079	 B090	 B098	 B105	

Please see the page B*** for the product details.

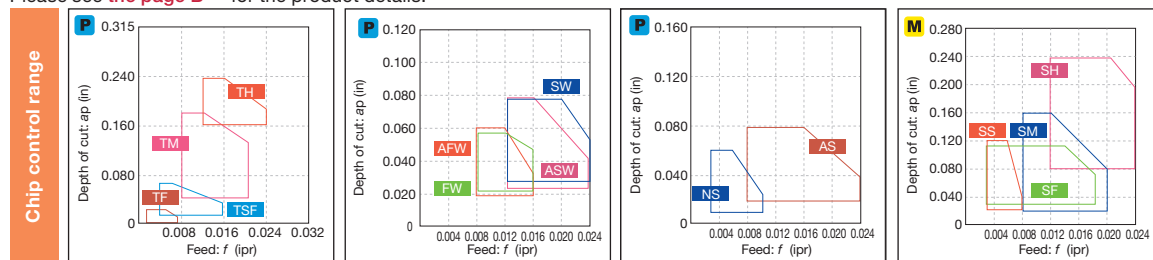







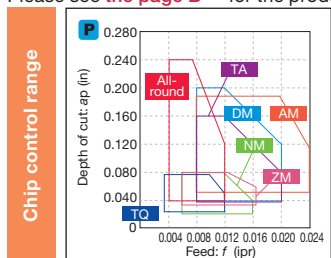



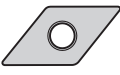

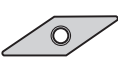



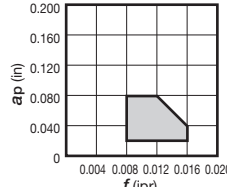
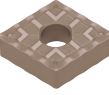
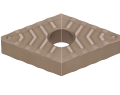



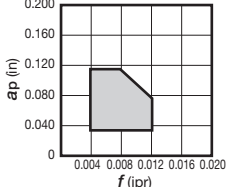
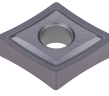
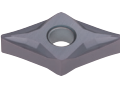
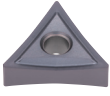
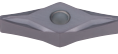

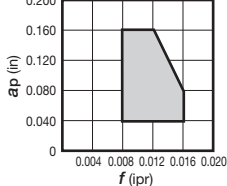
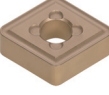
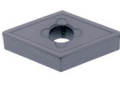





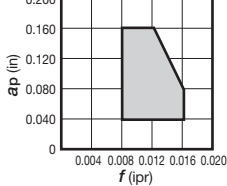
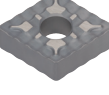
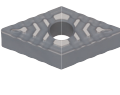

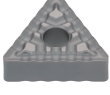
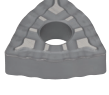

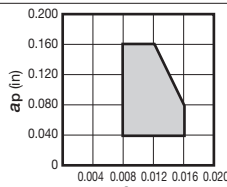
Chipbreaker Overview

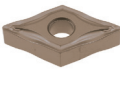
Application	Negative type with hole	C	D	S	T	V	W	Y
		80°	55°	90°	60°	35°	80°	25°
Finishing to medium cutting	AM 	 B059	 B070		 B090		 B105	
	NM 	 B059	 B070		 B090		 B105	
	TQ 	 B060	 B071		 B090	 B098	 B105	
	ZM 	 B060	 B071	 B079	 B091	 B099	 B106	 B109
Medium cutting	TA 	 B060		 B079	 B090		 B105	
	DM 	 B060	 B071	 B080	 B091	 B099	 B106	
	All-round 	 B060	 B071	 B080	 B091	 B099	 B106	

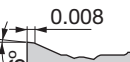
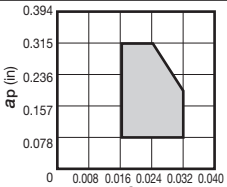
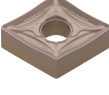
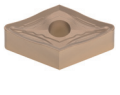
Please see the page B*** for the product details.



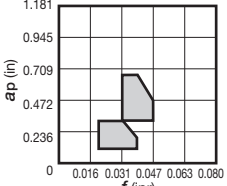







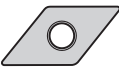



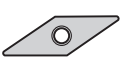

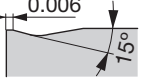
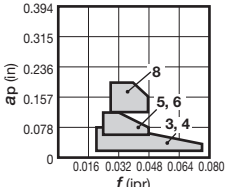

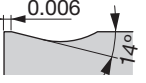
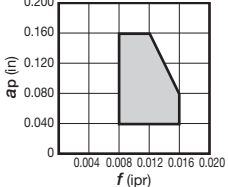
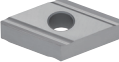
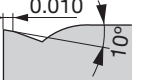
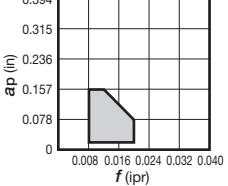
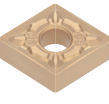





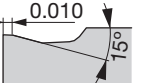
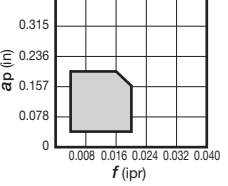
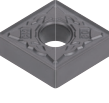
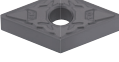

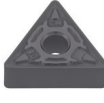
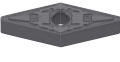
Chipbreaker Overview

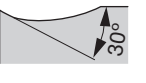
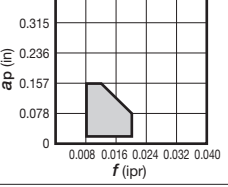
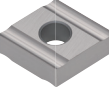
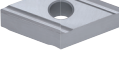
Application	Negative type with hole	C	D	S	T	V	W	Y
								
		80°	55°	90°	60°	35°	80°	25°
Finishing to medium cutting	27  							
	28  							
	33  							
	37  							
	38  							
	57  							
	65  							

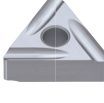
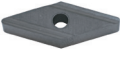
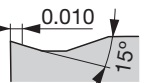
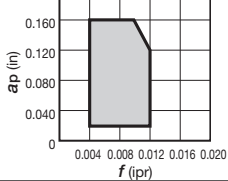
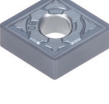
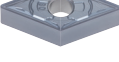
Please see the page B*** for the product details.

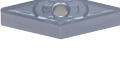
Chipbreaker Overview

Application	Negative type with hole	C	D	R	S	T	V	W
		 80°	 55°		 90°	 60°	 35°	 80°
Heavy cutting	61  			 B076				
	Parallel  		 B072					
Medium cutting	SM  	 B062	 B072		 B081	 B092	 B100	 B107
	CM  	 B062	 B072		 B081	 B092	 B100	 B107
	P  	 B062	 B073		 B081	 B093	 B096	
	HRM  	 B062	 B073		 B082	 B093	 B100	 B107

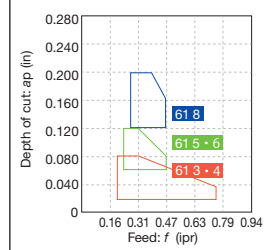
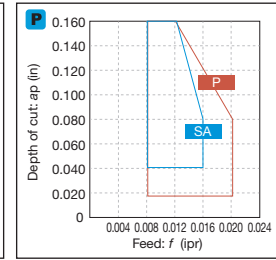
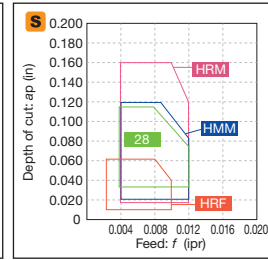
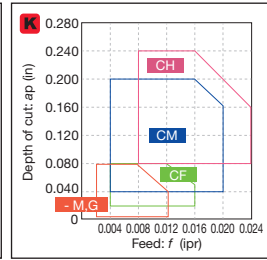
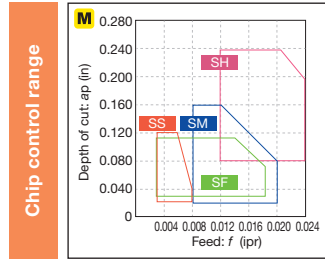

*-M,G: Without chipbreaker

Please see the page B*** for the product details.

Grade
Insert
Toolholder
Ext. Toolholder
Int. Toolholder
Threading
Grooving
Milling Cutter
Miniature Tool
Endmill
Drilling Tool
Tooling System
User's Guide
Index



Chipbreaker Overview







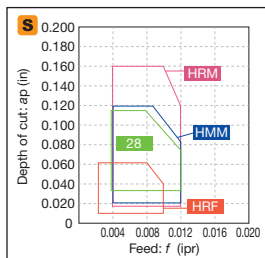
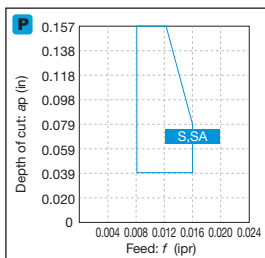
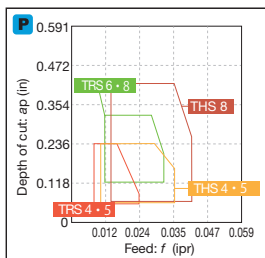
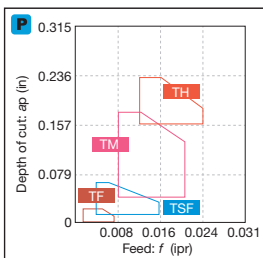



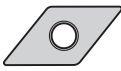



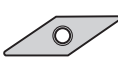

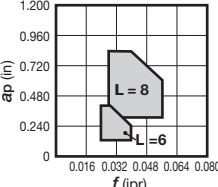
Application	Negative type with hole	C	D	R	S	T	V	W
		80°	55°		90°	60°	35°	80°
Medium cutting	HMM 0.200 0.160 0.120 0.080 0.040 0 0.004 0.008 0.012 0.016 0.020 f (ipr)							
	B062	B073		B082	B093	B100	B107	
	SA 0.200 0.160 0.120 0.080 0.040 0 0.004 0.008 0.012 0.016 0.020 f (ipr)							
B062	B073		B082	B093		B108		
S 0.200 0.160 0.120 0.080 0.040 0 0.004 0.008 0.012 0.016 0.020 f (ipr)								
B063	B073		B082	B094				
Medium to heavy cutting	TH 0.276 0.236 0.197 0.157 0.118 0.079 0.039 0 0.024 0.020 0.016 0.012 0.008 0.004 f (ipr)							
	B063	B074		B082	B094		B108	
THS 0.600 0.480 0.360 0.240 0.120 0 0.012 0.024 0.036 0.048 0.060 f (ipr)								
B063	B074		B082	B094		B108		
Medium to heavy cutting (single side)	TRS 0.394 0.315 0.157 0.078 0 0.008 0.016 0.024 0.032 0.040 f (ipr)							
B064			B083					

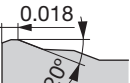
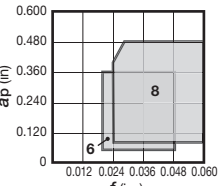
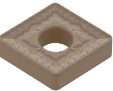
Please see the page B*** for the product details.

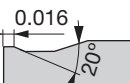
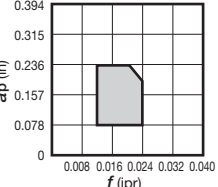
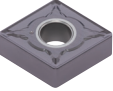
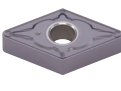
Chip control range

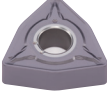
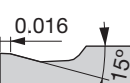
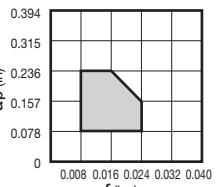
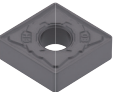
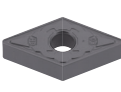

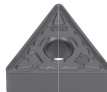
Chipbreaker Overview

Application	Negative type with hole	C	D	R	S	T	V	W
								
		80°	55°		90°	60°	35°	80°
Heavy cutting (single side)	TU  							
	TUS  							
Medium to heavy cutting	SH  							
	CH  							



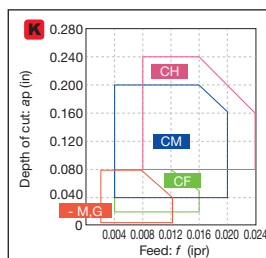
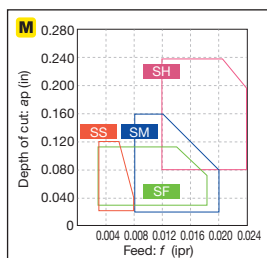
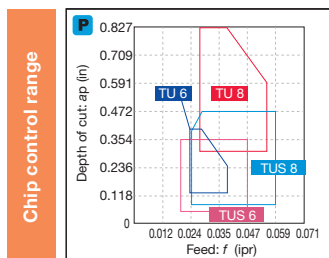







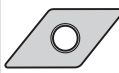



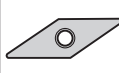

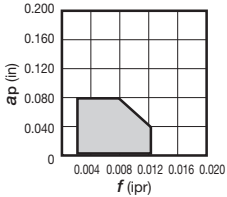
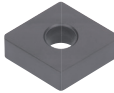
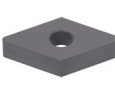
Please see the page B*** for the product details.

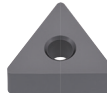
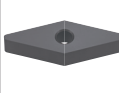
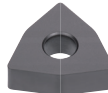
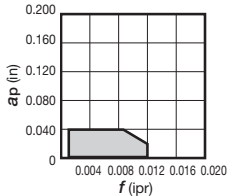
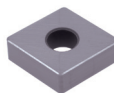

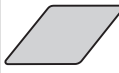
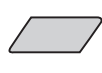
*-M,G: Without chipbreaker



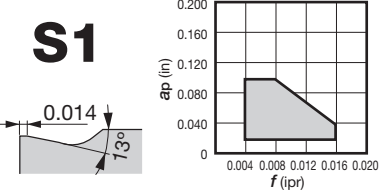













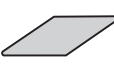

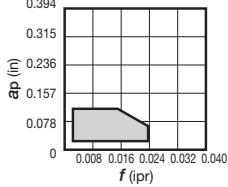

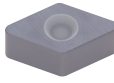
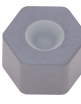

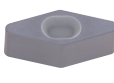
Chipbreaker Overview

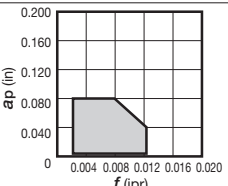
Application		Negative type with hole		C	D	R	S	T	V	W
										
				80°	55°		90°	60°	35°	80°
Finishing to medium cutting	M,G-class									
				B065	B074	B076	B084	B095	B100	B109
Finishing	Wiper M-class									
				B065						
Application		Negative type with hole		C	D	KNMX	LNGN	R	S	T
										
				80°	55°	55°	90°		90°	60°
Finishing	S1									
						B110				

Please see [the page B***](#) for the product details.

Chipbreaker Overview

Application	Negative type without hole	C	D	H	R	S	T	V
								
		80°	55°	120°		90°	60°	35°
Finishing to medium cutting	G-class  	 B066	 B075	 B110		 B085		 B101
	M,G-class  	 B066	 B075		 B076	 B085	 B096	

Please see [the page B***](#) for the product details.

Grade
Insert
Ext. Toolholder
Int. Toolholder
Threading
Grooving
Miniature Tool
Endmill
Drilling Tool
Tooling System
User's Guide
Index









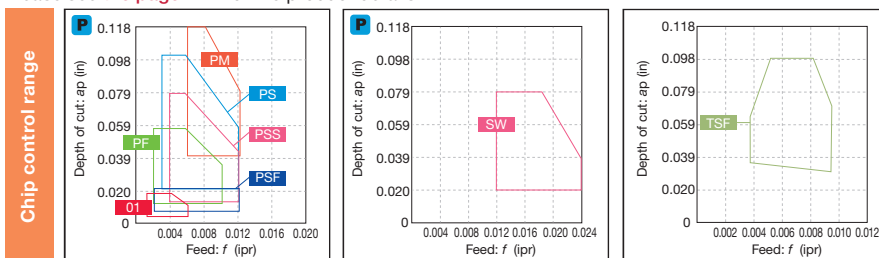



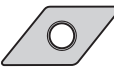

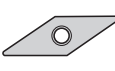
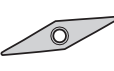
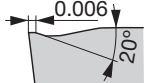
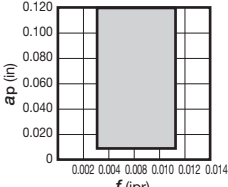

Chipbreaker Overview

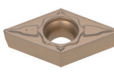
Application	Positive 7° with hole						
	C	D	R	S	T	V	Y
	80°	55°		90°	60°	35°	25°
Precision finishing	01 B111	 B121			 B139		
	PSF B111	 B121			 B139	 B155	
	PF B111	 B121				 B155	
	PSS B112	 B122			 B139	 B155	
	SW B112						
	PS B112	 B122		 B135	 B140	 B155	
	TSF B112	 B122			 B140	 B155	

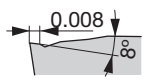
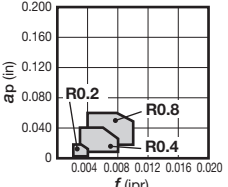
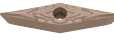
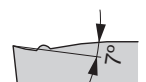
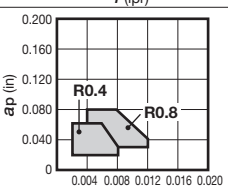
Please see the page B*** for the product details.

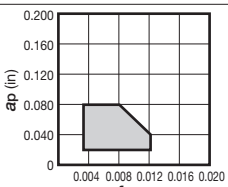
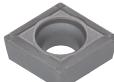
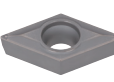

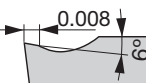
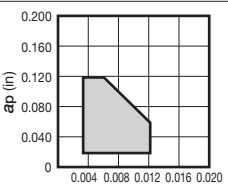
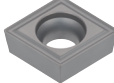
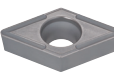
Chipbreaker Overview

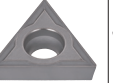
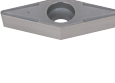
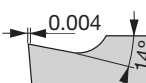
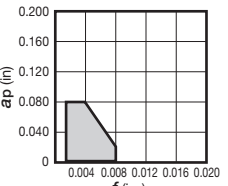
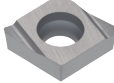
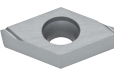
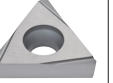
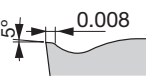
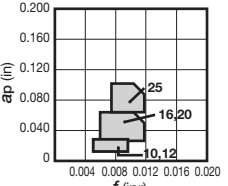
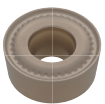
Application	Positive 7° with hole	C	D	R	S	T	V	Y
								
		80°	55°		90°	60°	35°	25°
Finishing to medium cutting	TM  							
	ZF  							
	ZM  							
	23  							
Medium cutting	24  							
Finishing	W**  							
Finishing to medium cutting	RS  							



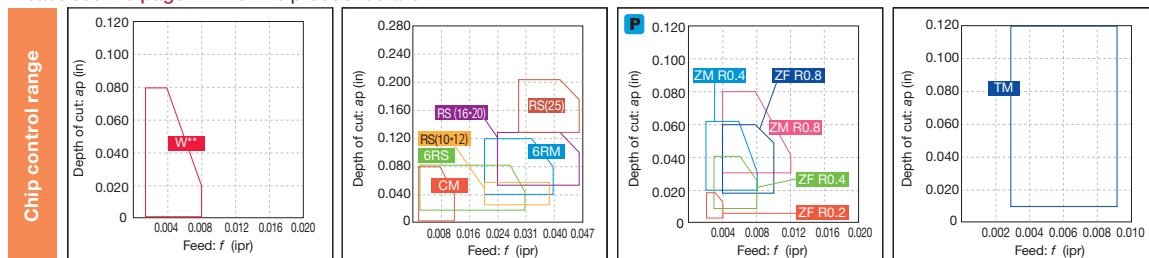







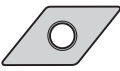



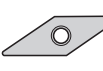
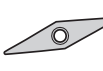
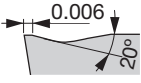
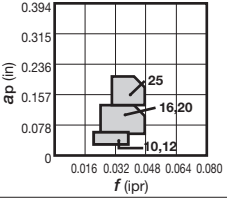

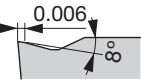
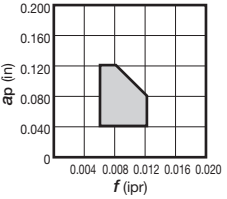

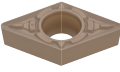

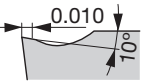
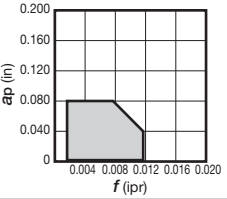

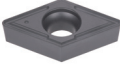

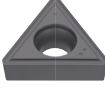

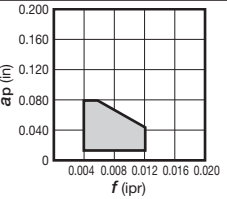
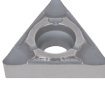
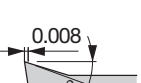
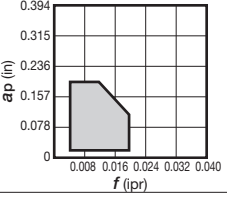

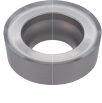
Please see the page B*** for the product details.

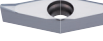

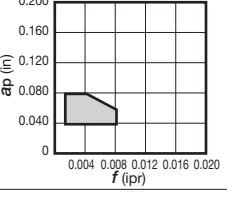
Grade
Insert
Toolholder
Ext. Toolholder
Int. Toolholder
Threading
Grooving
Miniature Tool
Milling Cutter
Endmill
Drilling Tool
Tooling System
User's Guide
Index

A
B
C
D
E
F
G
H
I
J
K
L
M

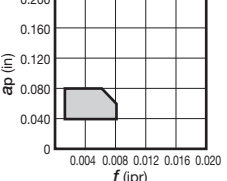





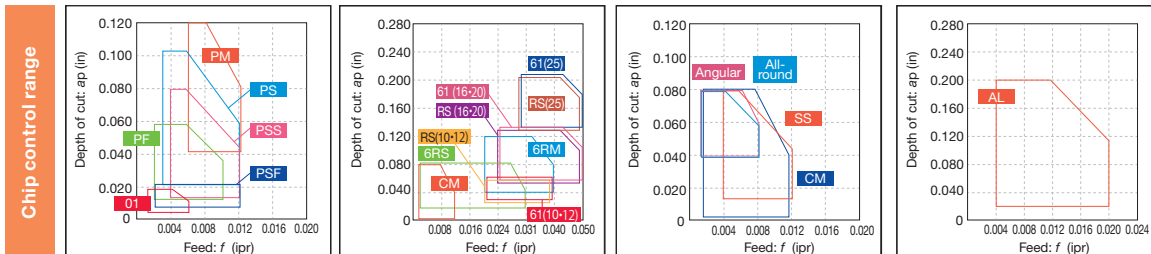



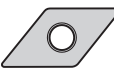

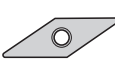
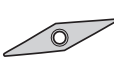
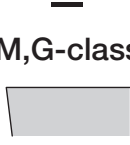
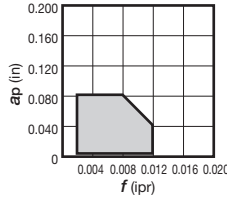

Chipbreaker Overview

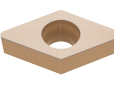
Application	Positive 7° with hole	C	D	R	S	T	V	Y
								
		80°	55°		90°	60°	35°	25°
Heavy cutting	61  							
				B132				
Medium cutting	PM  							
		B114	B123		B135	B141		
Finishing to medium cutting	CM  							
		B114	B123	B131	B135	B141	B156	
	SS  							
						B141		
	AL  							
		B115	B124	B131		B141	B156	
	All-round  							
	B115	B124				B156		
Angular  								
	B115	B124						

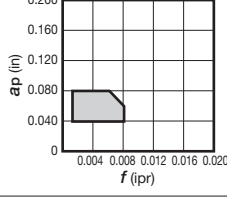
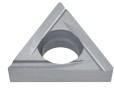
Please see the page B*** for the product details.

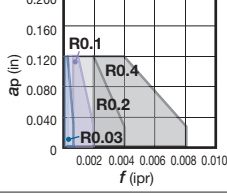
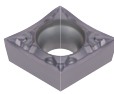
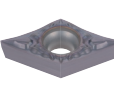
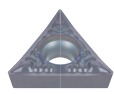

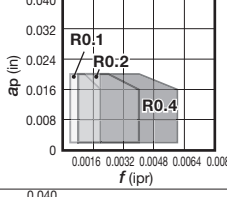
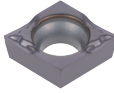
Chipbreaker Overview

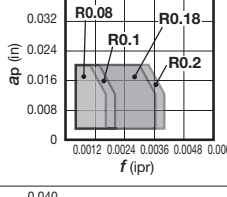
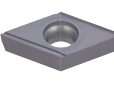
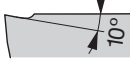
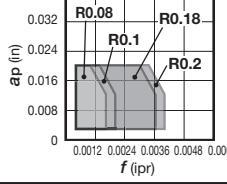
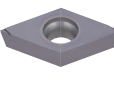
Application	Positive 7° with hole	C	D	R	S	T	V	Y
								
		80°	55°		90°	60°	35°	25°
Finishing to medium cutting	 							
Finishing (with hand)	 							
For external turning on Swiss lathes (including sharp edge type)	 							
	 							
For external turning on Swiss lathes (sharp edge)	 							
	 							

Please see the page B*** for the product details.

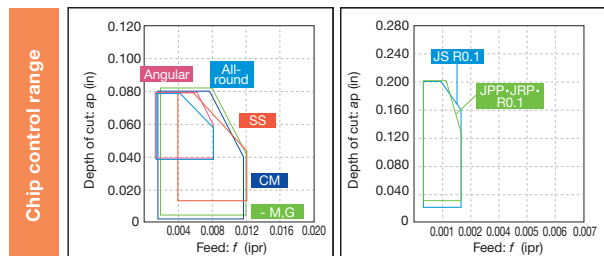











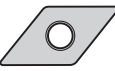



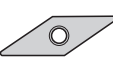
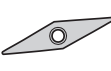

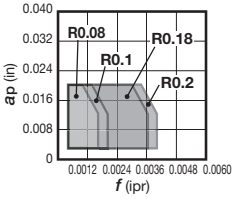
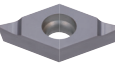
*-M,G: Without chipbreaker

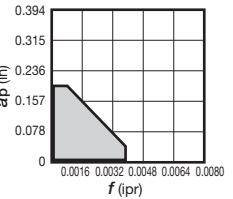
*Chip control range with typical R0.1

Grade
Insert
Toolholder
Ext. Toolholder
Int. Toolholder
Threading
Grooving
Milling Cutter
Miniature Tool
Endmill
Drilling Tool
Tooling System
User's Guide
Index

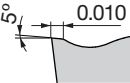
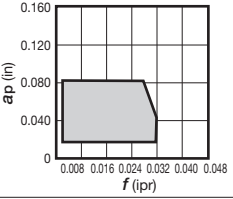

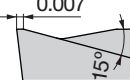
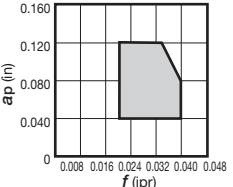
Chipbreaker Overview

Application	Positive 7° with hole	C	D	R	S	T	V	Y
								
		80°	55°		90°	60°	35°	25°
For external turning on Swiss lathes (sharp edge)	JSP  							
			B126					
	J**  							
		B117	B126			B142, B143		
Low cutting force	6RS  							
				B131				
Medium cutting	6RM  							
				B131				

Please see the page B*** for the product details.

Chip control range

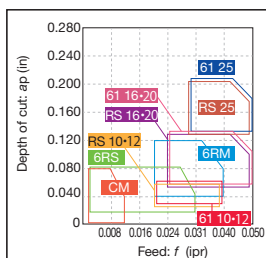
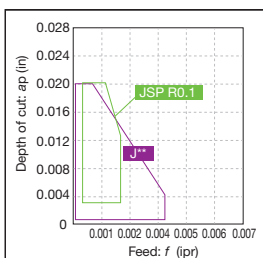

Chipbreaker Overview

Application	Positive 11° with hole	C	E	S	T	V
		80°	75°	90°	60°	35°
Precision finishing	01 				 B144	
	PSF 	 B118			 B144	
Finishing	PF 	 B118			 B144	
	PSS 	 B118			 B145	
Finishing to light cutting	PS 	 B118		 B136	 B145	
	TSF 	 B118			 B145	
Finishing to medium cutting	TM 	 B118			 B146	



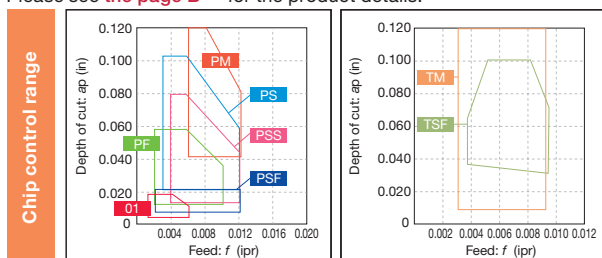







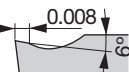
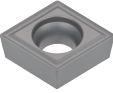

Please see the page B*** for the product details.

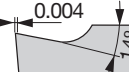
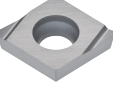
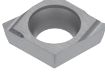

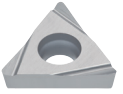
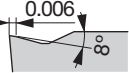
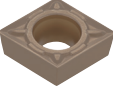
Grade
Insert
Ext. Toolholder
Int. Toolholder
Threading
Grooving
Milling Cutter
Miniature Tool
Endmill
Drilling Tool
Tooling System
User's Guide
Index

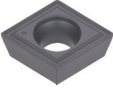

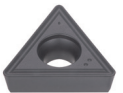
Chipbreaker Overview

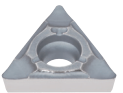
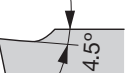
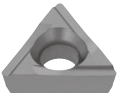
Application	Positive 11° with hole	C	E	S	T	V
		80°	75°	90°	60°	35°
Finishing to medium cutting	23  ap (in) vs f (ipr)			 B136	 B146	
	24  0.008 6° ap (in) vs f (ipr)	 B119		 B136	 B146	
Finishing	W**  0.004 7.4° ap (in) vs f (ipr)	 B119	 B129	 B136	 B146, B147	
	PM  0.006 8° ap (in) vs f (ipr)	 B120			 B148	
Finishing to medium cutting	CM  0.010 10° ap (in) vs f (ipr)	 B120		 B137	 B148	
	SS  ap (in) vs f (ipr)				 B148	
	H**  4.5° ap (in) vs f (ipr)				 B148	

Please see the page B*** for the product details.

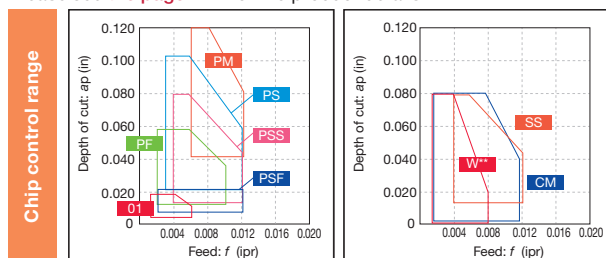

Chipbreaker Overview

Application	Positive 11° with hole	C	E	S	T	V
		80°	75°	90°	60°	35°
Medium cutting	<p>All-round</p>					
Finishing to medium cutting	<p>M,G-class</p>					
Finishing to medium cutting	<p>(with hand)</p>			<p>(Tungaloy standard hole specification) ISO non-compliant</p> <p>B137</p>		
	<p>(with hand)</p>				<p>(Tungaloy standard hole specification) ISO non-compliant</p> <p>B150</p>	

Please see [the page B***](#) for the product details.

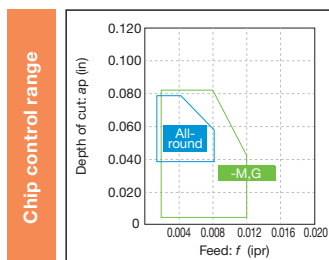







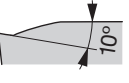
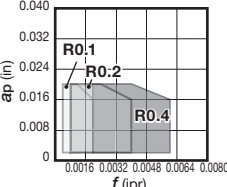
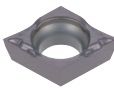
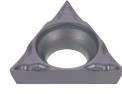
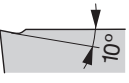
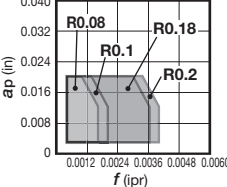
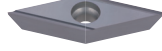

*-M,G: Without chipbreaker

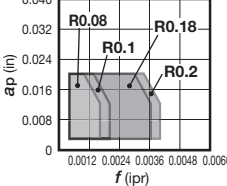
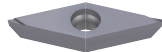

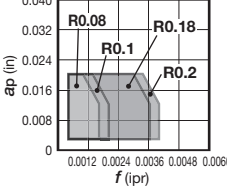
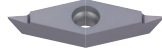
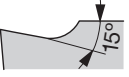
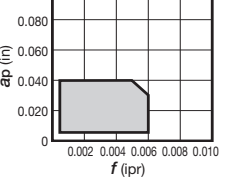
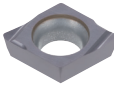
Grade
Insert
Ext. Toolholder
Int. Toolholder
Threading
Grooving
Milling Cutter
Endmill
Drilling Tool
Tooling System
User's Guide
Index

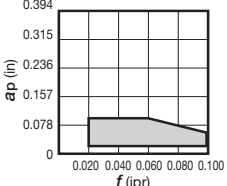

Chipbreaker Overview

Application	Positive 11° with hole	C	E	S	T	V
		80°	75°	90°	60°	35°
For internal turning on Swiss lathes	JS  		 B130		 B150	
	JPP  					 B157
For external turning on Swiss lathes (sharp edge)	JRP  					 B157
	JSP  					 B158
Finishing	J08  		 B130			

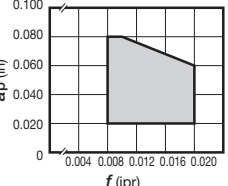
Application	Positive 11° with hole	W
		80°
Heavy cutting	ML  	  B159

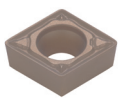
Application	Positive 7° with hole	C
		80°
Medium cutting (wiper)	SW  	  B112

Please see the page B*** for the product details.

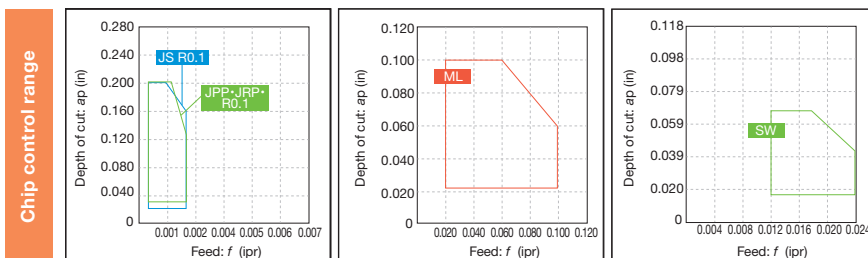

*Chip control range with typical R0.1

Chipbreaker Overview

Application	Positive 5° with hole	V	W	Application	Positive 5° with hole	V	W
		35°	80°			35°	80°
Finishing	PSF 			Finishing	W11 		
	PF 				Medium cutting	24 	
Finishing to light cutting	PSS 			Finishing to medium cutting		CM 	
	PS 				For external turning on Swiss lathes (sharp edge)	JS 	
Finishing to medium cutting	TSF 			For internal turning on Swiss lathes		JS 	
	TM 				For external turning on Swiss lathes (sharp edge)	J10 	
	W08 			For external turning on Swiss lathes (honed edge)		J10 	

Please see the page B*** for the product details.

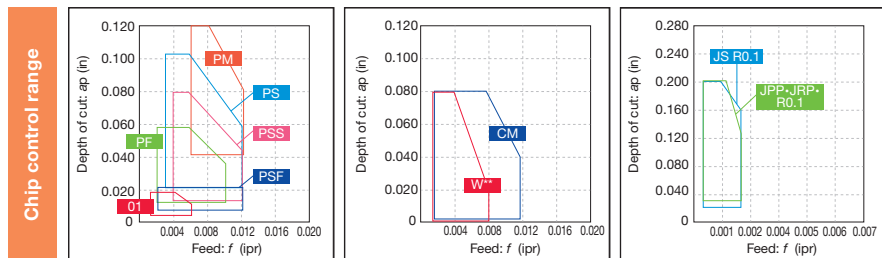

*Chip control range with typical R0.1



Chipbreaker Overview

Application	Positive type with hole	JXF
Front turning		

Application	Positive type with hole	J10E
Back turning		

Application	Positive type with hole	JXB
Back turning		













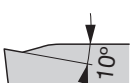
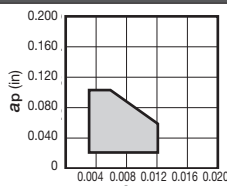

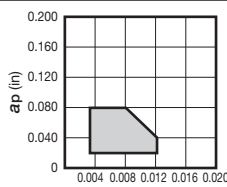

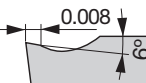
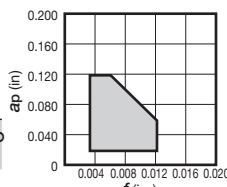

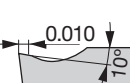
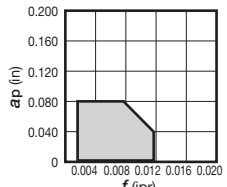
Application	Positive type with hole	JXR
Reverse turning		

Application	Positive type with hole	JTB
Back turning		

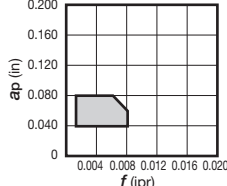
Application	Round	RT
Medium cutting		

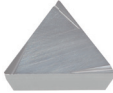
Please see the page B*** for the product details.

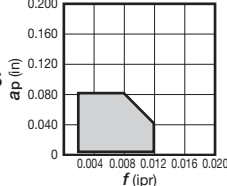
Chipbreaker Overview

Application	Positive 11° without hole	R	S	T
				
			90°	60°
Finishing to medium cutting	PS  			 B151
	23  		 B138	 B151
Medium cutting	24  			 B151
Finishing to medium cutting	CM  		 B138	 B151
	 (with hand) 		 B138	 B152
	 M,G-class 		 B138	 B152



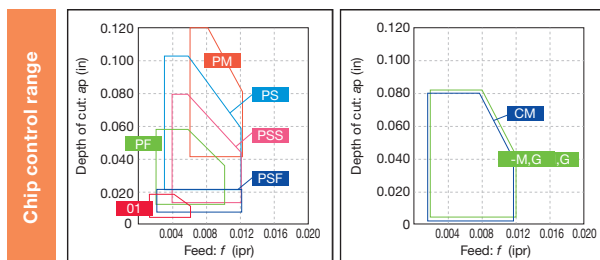





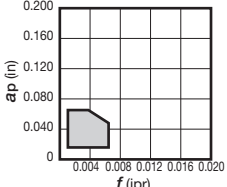
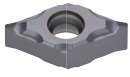
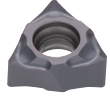
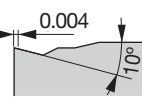
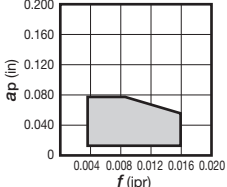
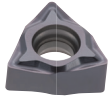
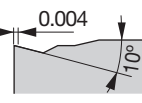
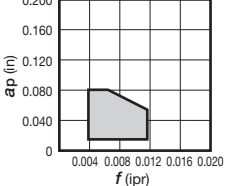
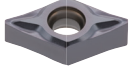
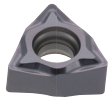

Please see the page B*** for the product details.

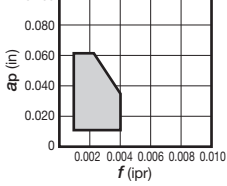
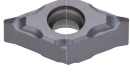
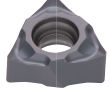

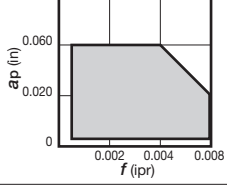
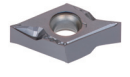
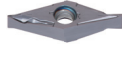
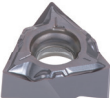
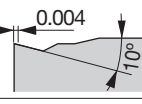
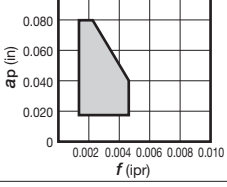
*-M,G: Without chipbreaker

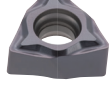

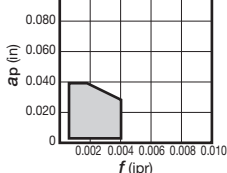
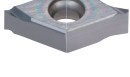

Chipbreaker Overview

Application	Double-sided positive type with hole	D	V	W
		55°	35°	80°
Finishing (low cutting force)	SS  			
Finishing (wiper)	TSW  			
Finishing to medium cutting	TS  			
Finishing (low cutting force) (sharp edge)	JSS  			
Finishing to medium cutting (sharp edge)	JS  			
Finishing to medium cutting (sharp edge)	JTS  			
Finishing (sharp edge)	JRP  			

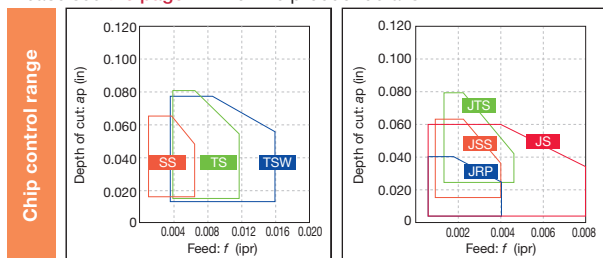
Please see the page B*** for the product details.

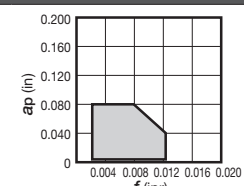

Chipbreaker Overview

Application	Positive 7° without hole		RCGX
			Special round insert
Medium cutting			 B133

Please see [the page B***](#) for the product details.

Cutting edge preparations for ceramic insert

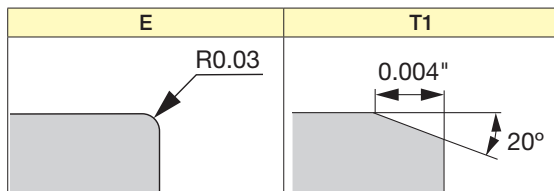

Grade	Symbols	Shape of edge
LX11	-	T01525
LX21	-	T01030
FX105	-	T02025
CX710	-	T02025
TS200	-E	R003
	-T1	T01020
TS300	-E	R003
	-T1	T01020
TZ120	-	T01020

Insert NEGATIVE TYPE

● : Continuous cutting
 ● : Light interrupted cutting
 ✖ : Heavy interrupted cutting

CN



Rhombic, 80° with hole

Material	P Steel	M Stainless	K Cast iron	N Non-ferrous	S Superalloy	H Hard material	T9215	T9225	T9235	T9115	T9125	T9135	T6120	T6130	AH630	T5105	T5115	GT9530	AT9530	GT720	NS9530	TH10	
P Steel	●●●✖	●●	●●	●●	●●	●●	●	●	●	●	●	●	●	●	●	●	●	●	●	●	●	●	●
M Stainless	●●	●●	●●	●●	●●	●●	●	●	●	●	●	●	●	●	●	●	●	●	●	●	●	●	●
K Cast iron	●●	●●	●●	●●	●●	●●	●	●	●	●	●	●	●	●	●	●	●	●	●	●	●	●	●
N Non-ferrous	●●	●●	●●	●●	●●	●●	●	●	●	●	●	●	●	●	●	●	●	●	●	●	●	●	●
S Superalloy	●●	●●	●●	●●	●●	●●	●	●	●	●	●	●	●	●	●	●	●	●	●	●	●	●	●
H Hard material	●●	●●	●●	●●	●●	●●	●	●	●	●	●	●	●	●	●	●	●	●	●	●	●	●	●

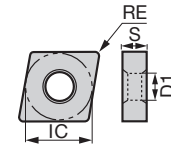

Application	Chipbreaker	Designation	Coated										Coated cermet	Cermet	Uncoated	Dimension (inch)															
			Inch	Metric	T9215	T9225	T9235	T9115	T9125	T9135	T6120	T6130	AH630	T5105	T5115	GT9530	AT9530	GT720	NS9530	TH10	RE	IC	S	D1							
Finishing		ZF CNMG 331E ZF CNMG090404E-ZF	●	●	▲	▲																			0.016	0.375	0.188	0.150			
		CNMG 431 ZF CNMG120404-ZF	●	●	▲	▲										●	●		●							0.016	0.500	0.188	0.203		
		CNMG 432 ZF CNMG120408-ZF	●	●	●	▲	▲	▲												●	●		●				0.031	0.500	0.188	0.203	
		CNMG 433 ZF CNMG120412-ZF				▲																						0.047	0.500	0.188	0.203
Finishing		11 CNMG 431-11 CNMG120404-11																	●			●				0.016	0.500	0.188	0.203		
		CNMG 432-11 CNMG120408-11																		●	●		●				0.031	0.500	0.188	0.203	
Finishing (for mild steel)		17 CNMG 431-17 CNMG120404-17																				●				0.016	0.500	0.188	0.203		
		CNMG 432-17 CNMG120408-17																					●				0.031	0.500	0.188	0.203	
Finishing		SF CNMG 321 SF CNMG090304-SF											●	●	●											0.016	0.375	0.125	0.150		
		CNMG 322 SF CNMG090308-SF											●	●	●												0.031	0.375	0.125	0.150	
		CNMG 431 SF CNMG120404-SF												●	●	●											0.016	0.500	0.188	0.203	
		CNMG 432 SF CNMG120408-SF												●	●	●												0.031	0.500	0.188	0.203
		CNMG 433 SF CNMG120412-SF												●	●	●												0.047	0.500	0.188	0.203
		CF CNMG 431 CF CNMG120404-CF																●	●									0.016	0.500	0.188	0.203
		CNMG 432 CF CNMG120408-CF														●	●									0.031	0.500	0.188	0.203		
		CNMG 433 CF CNMG120412-CF														●	●									0.047	0.500	0.188	0.203		

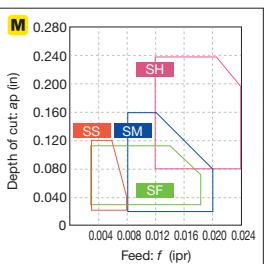
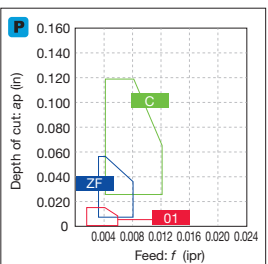
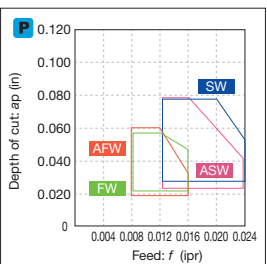
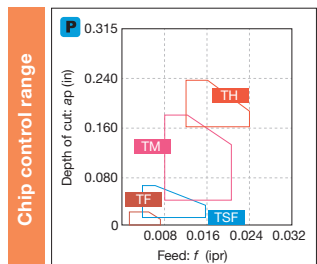

● : Line up
 ▲ : To be discontinued

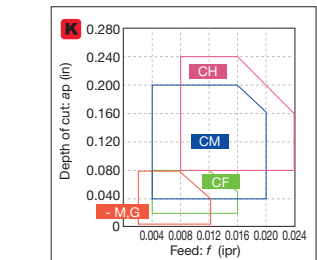

Reference pages: External toolholder → C018 - Internal toolholder → D028 -
 J-Series toolholder → G057 TungCap → K008 -

*-M,G: Without chipbreaker

Grade
 Insert
 Ext. Toolholder
 Int. Toolholder
 Threading
 Grooving
 Milling Cutter
 Miniature Tool
 Endmill
 Drilling Tool
 Tooling System
 User's Guide
 Index



Insert NEGATIVE TYPE

● : Continuous cutting
 ● : Light interrupted cutting
 ✳ : Heavy interrupted cutting

CN



Rhombic, 80° with hole

	P	M	K	N	S	H														
Steel	●	●	●	✳	●	●	●	✳	●	●	●	✳	●	●	●	●	●	●	●	●
Stainless	●	●	●	●	●	●	●	●	●	●	●	●	●	●	●	●	●	●	●	●
Cast iron	●	●	●	●	●	●	●	●	●	●	●	●	●	●	●	●	●	●	●	●
Non-ferrous	●	●	●	●	●	●	●	●	●	●	●	●	●	●	●	●	●	●	●	●
Superalloy	●	●	●	●	●	●	●	●	●	●	●	●	●	●	●	●	●	●	●	●
Hard material	●	●	●	●	●	●	●	●	●	●	●	●	●	●	●	●	●	●	●	●

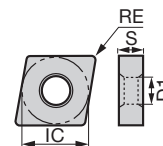

Application	Chipbreaker	Designation	Coated														Coated cermet		Cermet		Dimension (inch)						
			Inch		Metric		T9205	T9215	T9225	T9235	T9105	T9115	T9125	T9135	T6130	T515	T5115	AH8005	AH8015	GT9530	AT9530	NS9530	NS520	RE	IC	S	D1
Finishing		HRF	CNMG 431 HRF	CNMG120404-HRF														●	●			0.016	0.500	0.188	0.203		
			CNMG 432 HRF	CNMG120408-HRF															●	●			0.031	0.500	0.188	0.203	
			CNMG 433 HRF	CNMG120412-HRF															●	●			0.047	0.500	0.188	0.203	
		TS	CNMG 431 TS	CNMG120404-TS	●	●	●		▲	▲	▲								●	●	●	●	0.016	0.500	0.188	0.203	
			CNMG 432 TS	CNMG120408-TS	●	●	●	●	▲	▲	▲	▲	●						●	●	●	●	0.031	0.500	0.188	0.203	
			CNMG 433 TS	CNMG120412-TS	●	●	●		▲	▲	▲												0.047	0.500	0.188	0.203	
Finishing to medium cutting (wiper)		SW	CNMG 332E SW	CNMG090408E-SW	●	●	●		▲	▲	▲					●						0.031	0.375	0.188	0.150		
			CNMG 333E SW	CNMG090412E-SW	●	●	●		▲	▲	▲					●							0.047	0.375	0.188	0.150	
			CNMG 432 SW	CNMG120408-SW	●	●	●		▲	▲	▲			●	●								0.031	0.500	0.188	0.203	
			CNMG 433 SW	CNMG120412-SW	●	●	●		▲	▲	▲			●	●									0.047	0.500	0.188	0.203
		ASW	CNMG 432 ASW	CNMG120408-ASW	●	●	●		▲	▲	▲									●			0.031	0.500	0.188	0.203	
			CNMG 433 ASW	CNMG120412-ASW	●	●	●		▲	▲	▲												0.047	0.500	0.188	0.203	
High feed, small depth of cut		AS	CNMG 431 AS	CNMG120404-AS	●	●	●		▲	▲	▲								●			0.016	0.500	0.188	0.203		
			CNMG 432 AS	CNMG120408-AS	●	●	●	●	▲	▲	▲	▲							●				0.031	0.500	0.188	0.203	
			CNMG 433 AS	CNMG120412-AS	●	●	●		▲	▲	▲												0.047	0.500	0.188	0.203	
Boring (double side)		CB	CNMG 321 CB	CNMG090304-CB																●		0.016	0.375	0.125	0.150		
			CNMG 322 CB	CNMG090308-CB																	●		0.031	0.375	0.125	0.150	
Finishing		NS	CNMG 431 NS	CNMG120404-NS																●		0.016	0.500	0.188	0.203		
			CNMG 432 NS	CNMG120408-NS	●	●			▲	▲										●			0.031	0.500	0.188	0.203	

* Please see L034-L038 about the adjustment of the machining program for rounding or taper machining by using SW/FW. Please contact a Tungaloy sales representative with questions.

● : Line up
 ▲ : To be discontinued

Insert NEGATIVE TYPE

- : Continuous cutting
- : Light interrupted cutting
- ✱ : Heavy interrupted cutting

CN



Rhombic, 80° with hole

	P	M	K	N	S	H	●	○	✱	●	○	✱	●	○	✱	●	○	✱	●	○	✱	●	○	✱	●	○	✱
Steel	●	○	○	○	○	○	●	○	○	○	○	○	○	○	○	○	○	○	○	○	○	○	○	○	○	○	○
Stainless	○	○	○	○	○	○	○	○	○	○	○	○	○	○	○	○	○	○	○	○	○	○	○	○	○	○	○
Cast iron	○	○	○	○	○	○	○	○	○	○	○	○	○	○	○	○	○	○	○	○	○	○	○	○	○	○	○
Non-ferrous	○	○	○	○	○	○	○	○	○	○	○	○	○	○	○	○	○	○	○	○	○	○	○	○	○	○	○
Superalloy	○	○	○	○	○	○	○	○	○	○	○	○	○	○	○	○	○	○	○	○	○	○	○	○	○	○	○
Hard material	○	○	○	○	○	○	○	○	○	○	○	○	○	○	○	○	○	○	○	○	○	○	○	○	○	○	○

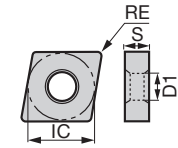

Application	Chipbreaker	Designation		Coated																Cermet	Dimension (inch)							
		Inch	Metric	T9205	T9215	T9225	T9235	T9105	T9115	T9125	T9135	T6120	T6130	AH630	AH645	T515	AH110	AH120	AH725		AH8015	GH330	NS9530	RE	IC	S	D1	
Finishing		SS	CNMG 331E SS	CNMG090404E-SS																			●	0.016	0.375	0.188	0.150	
			CNMG 332E SS	CNMG090408E-SS																				●	0.031	0.375	0.188	0.150
			CNMG 431 SS	CNMG120404-SS								●	●	●	●	●			●					●	0.016	0.500	0.188	0.203
			CNMG 432 SS	CNMG120408-SS								●	●	●	●	●			●					●	0.031	0.500	0.188	0.203
			CNMG 433 SS	CNMG120412-SS								●	●	●	●	●								●	0.047	0.500	0.188	0.203
Medium cutting		TM	CNMG 321 TM	CNMG090304-TM	●	●			▲	▲												●	0.016	0.375	0.125	0.150		
			CNMG 322 TM	CNMG090308-TM	●	●	●		▲	▲	▲												●	0.031	0.375	0.125	0.150	
			CNMG 331E TM	CNMG090404E-TM	●	●			▲	▲		●	●	●			●		●				●	0.016	0.375	0.188	0.150	
			CNMG 332E TM	CNMG090408E-TM	●	●			▲	▲		●	●	●			●		●				●	0.031	0.375	0.188	0.150	
			CNMG 333E TM	CNMG090412E-TM	●	●			▲	▲		●	●	●			●		●				●	0.047	0.375	0.188	0.150	
			CNMG 431 TM	CNMG120404-TM	●	●	●	●	▲	▲	▲	▲	●	●	●	●	●	●	●	●	●	●	●	0.016	0.500	0.188	0.203	
			CNMG 432 TM	CNMG120408-TM	●	●	●	●	▲	▲	▲	▲	●	●	●	●	●	●	●	●	●	●	●	0.031	0.500	0.188	0.203	
			CNMG 433 TM	CNMG120412-TM	●	●	●	●	▲	▲	▲	▲	●	●	●	●	●	●	●	●	●	●	●	0.047	0.500	0.188	0.203	
			CNMG 434 TM	CNMG120416-TM	●	●	●	●	▲	▲	▲	▲	●	●	●	●	●		●				●	0.063	0.500	0.188	0.203	
			CNMG 543 TM	CNMG160612-TM	●	●	●	●	▲	▲	▲	▲	●	●	●	●	●	●	●	●	●	●	●	0.047	0.625	0.250	0.250	
			CNMG 642 TM	CNMG190608-TM	●	●	●	●	▲	▲	▲	▲	●	●	●	●	●	●	●	●	●	●	●	0.031	0.750	0.250	0.312	
CNMG 643 TM	CNMG190612-TM	●	●	●	●	▲	▲	▲	▲	●	●	●	●	●	●	●	●	●	●	●	0.047	0.750	0.250	0.312				
Finishing to medium cutting		AM	CNMG 432 AM	CNMG120408-AM	●	●			▲	▲											●	0.031	0.500	0.188	0.203			
			CNMG 433 AM	CNMG120412-AM	●	●			▲	▲												●	0.047	0.500	0.188	0.203		
			CNMG 434 AM	CNMG120416-AM	●	●			▲	▲												●	0.063	0.500	0.188	0.203		
			NM	CNMG 432 NM	CNMG120408-NM	●	●	●	●	▲	▲	▲	▲										●	0.031	0.500	0.188	0.203	
				CNMG 433 NM	CNMG120412-NM	●	●	●	●	▲	▲	▲											●	0.047	0.500	0.188	0.203	

● : Line up
▲ : To be discontinued

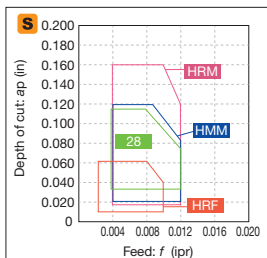
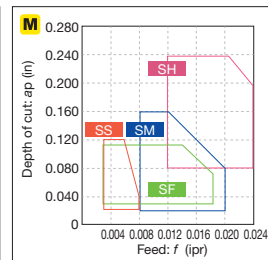
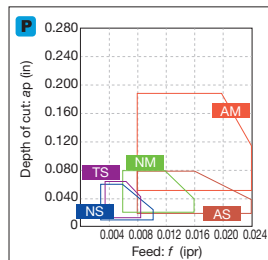
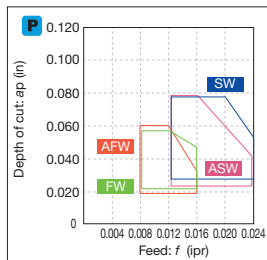
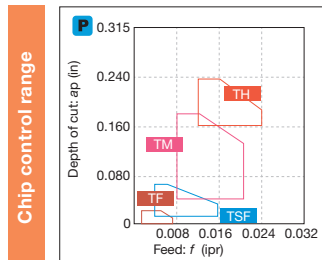

Reference pages: External toolholder → C018 - Internal toolholder → D028 -
J-Series toolholder → G057 TungCap → K008 -

Grade
Insert
Toolholder
Ext. Toolholder
Int. Toolholder
Threading
Grooving
Milling Cutter
Miniature Tool
Endmill
Drilling Tool
Tooling System
User's Guide
Index

Negative

Positive

PCD / CBN

C

D

G

R

S

T

V

W

Y

OTHERS

Insert NEGATIVE TYPE

- : Continuous cutting
- ◐ : Light interrupted cutting
- * : Heavy interrupted cutting

CN



Rhombic, 80° with hole

	P	M	K	N	S	H	T9205	T9215	T9225	T9235	T9105	T9115	T9125	T9135	T515	T5105	T5115	T5125	AH110	AH120	GT9530	AT9530	GT720	NS9530	NS520	TH10
Steel	●	●	●	●	●	●	●	●	●	●	●	●	●	●	●	●	●	●	●	●	●	●	●	●	●	●
Stainless	●	●	●	●	●	●	●	●	●	●	●	●	●	●	●	●	●	●	●	●	●	●	●	●	●	●
Cast iron	●	●	●	●	●	●	●	●	●	●	●	●	●	●	●	●	●	●	●	●	●	●	●	●	●	●
Non-ferrous	●	●	●	●	●	●	●	●	●	●	●	●	●	●	●	●	●	●	●	●	●	●	●	●	●	●
Superalloy	●	●	●	●	●	●	●	●	●	●	●	●	●	●	●	●	●	●	●	●	●	●	●	●	●	●
Hard material	●	●	●	●	●	●	●	●	●	●	●	●	●	●	●	●	●	●	●	●	●	●	●	●	●	●

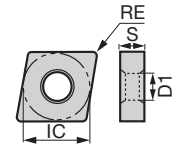

Application	Chipbreaker	Designation		Coated																				Coated cermet	Cermet	Un-coated	Dimension (inch)							
		Inch	Metric	T9205	T9215	T9225	T9235	T9105	T9115	T9125	T9135	T515	T5105	T5115	T5125	AH110	AH120	GT9530	AT9530	GT720	NS9530	NS520	TH10	RE	IC	S	D1							
Finishing to medium cutting		TQ	CNMG 431 TQ	CNMG120404-TQ	●	●	●	●	●	●	●	●	●	●	●	●	●	●	●	●	●	●	●	●	●	●	0.016	0.500	0.188	0.203				
			CNMG 432 TQ	CNMG120408-TQ	●	●																						0.031	0.500	0.188	0.203			
Medium cutting		TA	CNMG 432 TA	CNMG120408-TA	●	●																					0.031	0.500	0.188	0.203				
			CNMG 433 TA	CNMG120412-TA	●	●																						0.047	0.500	0.188	0.203			
Finishing to medium cutting		ZM	CNMG 332E ZM	CNMG090408E-ZM	●	●			▲	▲																	0.031	0.375	0.188	0.150				
			CNMG 432 ZM	CNMG120408-ZM	●	●	●		▲	▲	▲							●			●						0.031	0.500	0.188	0.203				
			CNMG 433 ZM	CNMG120412-ZM	●	●	●		▲	▲	▲								●			●						0.047	0.500	0.188	0.203			
			CNMG 434 ZM	CNMG120416-ZM	●	●			▲	▲																			0.063	0.500	0.188	0.203		
Medium cutting		DM	CNMG 431 DM	CNMG120404-DM	●	●			▲	▲																	0.016	0.500	0.188	0.203				
			CNMG 432 DM	CNMG120408-DM	●	●	●		▲	▲	▲	▲																0.031	0.500	0.188	0.203			
			CNMG 433 DM	CNMG120412-DM	●	●	●		▲	▲	▲	▲																0.047	0.500	0.188	0.203			
			CNMG 543 DM	CNMG160612-DM	●				▲																				0.047	0.625	0.250	0.250		
		All-round		All-round	CNMG 321	CNMG090304	●	●			▲	▲												●					0.016	0.375	0.125	0.150		
					CNMG 322	CNMG090308	●	●	●	●	▲	▲	▲	▲											●	●				0.031	0.375	0.125	0.150	
					CNMG 431	CNMG120404	●	●	●	●	▲	▲	▲	▲	●	●	●	●	●	●	●	●	●	●	●	●	●	●	●	0.016	0.500	0.188	0.203	
					CNMG 432	CNMG120408	●	●	●	●	▲	▲	▲	▲	●	●	●	●	●	●	●	●	●	●	●	●	●	●	●	0.031	0.500	0.188	0.203	
					CNMG 433	CNMG120412	●	●	●	●	▲	▲	▲	▲	●	●	●	●	●	●	●	●	●	●	●	●	●	●	●	0.047	0.500	0.188	0.203	
					CNMG 434	CNMG120416	●	●	●	●	▲	▲	▲	▲	●	●	●	●	●	●	●	●	●	●	●	●	●	●	●		0.063	0.500	0.188	0.203
					CNMG 542	CNMG160608	●	●	●	●	▲	▲	▲	▲	●	●	●	●	●	●	●	●	●	●	●	●	●	●	●		0.031	0.625	0.250	0.250
					CNMG 543	CNMG160612	●	●	●	●	▲	▲	▲	▲	●	●	●	●	●	●	●	●	●	●	●	●	●	●	●		0.047	0.625	0.250	0.250
	CNMG 544			CNMG160616	●	●	●	●	▲	▲	▲	▲	●	●	●	●	●	●	●	●	●	●	●	●	●	●	●		0.063	0.625	0.250	0.250		
	CNMG 642			CNMG190608	●	●	●		▲	▲	▲																		0.031	0.750	0.250	0.312		
	CNMG 643	CNMG190612	●	●	●	●	▲	▲	▲	▲	●	●	●	●	●	●	●	●	●	●	●	●	●	●	●		0.047	0.750	0.250	0.312				
	CNMG 644	CNMG190616	●	●	●		▲	▲	▲																		0.063	0.750	0.250	0.312				

● : Line up
▲ : To be discontinued

Reference pages: External toolholder → C018 - Internal toolholder → D028 -
J-Series toolholder → G057 TungCap → K008 -

Insert NEGATIVE TYPE

- : Continuous cutting
- ◐ : Light interrupted cutting
- ◑ : Heavy interrupted cutting

CN



Rhombic, 80° with hole

Material	T9205	T9215	T9225	T9235	T9115	T9125	T9135	AH110	AH120	AH725	AH905	AH8005	AH8015	GH330	GT720	NS9530	TH10	KS05F
P Steel	●	●	●	◐	●	●	●	●	●	●	●	●	●	●	●	●	●	●
M Stainless	●	●	●	●	●	●	●	●	●	●	●	●	●	●	●	●	●	●
K Cast iron	●	●	●	●	●	●	●	●	●	●	●	●	●	●	●	●	●	●
N Non-ferrous																		
S Superalloy								●	●	●	●	●	●					
H Hard material																		

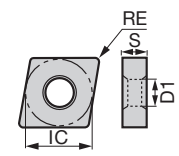

Application	Chipbreaker	Designation		Coated														Coated cermet	Cer- met	Un- coated	Dimension (inch)					
		Inch	Metric	T9205	T9215	T9225	T9235	T9115	T9125	T9135	AH110	AH120	AH725	AH905	AH8005	AH8015	GH330	GT720	NS9530	TH10	KS05F	RE	IC	S	D1	
Finishing to medium cutting		27	CNMG 431-27 / CNMG120404-27	●	●	●	◐	◐										●			0.016	0.500	0.188	0.203		
			CNMG 432-27 / CNMG120408-27	●	●	●	◐	◐	◐										●			0.031	0.500	0.188	0.203	
			CNMG 433-27 / CNMG120412-27		●			◐															0.047	0.500	0.188	0.203
Medium cutting		28	CNGP 430-28 / CNGP120401-28							●	●		●								0.004	0.500	0.188	0.203		
			CNGP 430.5-28 / CNGP120402-28							●	●		●									0.008	0.500	0.188	0.203	
			CNGP 431-28 / CNGP120404-28							●	●		●								●	0.016	0.500	0.188	0.203	
			CNGP 432-28 / CNGP120408-28							●	●		●								●	0.031	0.500	0.188	0.203	
			CNMG 431-28 / CNMG120404-28		●			◐		●	●		●	●									0.016	0.500	0.188	0.203
			CNMG 432-28 / CNMG120408-28							●	●		●	●									0.031	0.500	0.188	0.203
			CNMG 433-28 / CNMG120412-28								●		●	●									0.047	0.500	0.188	0.203
Medium cutting		33	CNMG 432-33 / CNMG120408-33						●							●					0.031	0.500	0.188	0.203		
			CNMG 434-33 / CNMG120416-33	●			◐															0.063	0.500	0.188	0.203	
			CNMG 543-33 / CNMG160612-33	●			◐																0.047	0.625	0.250	0.250
			CNMG 643-33 / CNMG190612-33	●			◐																0.047	0.750	0.250	0.312
Medium cutting		37	CNMG 431-37 / CNMG120404-37	●				◐										●			0.016	0.500	0.188	0.203		
			CNMG 432-37 / CNMG120408-37	●				◐										●	●		0.031	0.500	0.188	0.203		
			CNMG 433-37 / CNMG120412-37	●				◐								●			●			0.047	0.500	0.188	0.203	
Medium cutting		38	CNMG 431-38 / CNMG120404-38																		0.016	0.500	0.188	0.203		
			CNMG 432-38 / CNMG120408-38	●				◐			●											0.031	0.500	0.188	0.203	

- : Line up
- ▲ : To be discontinued

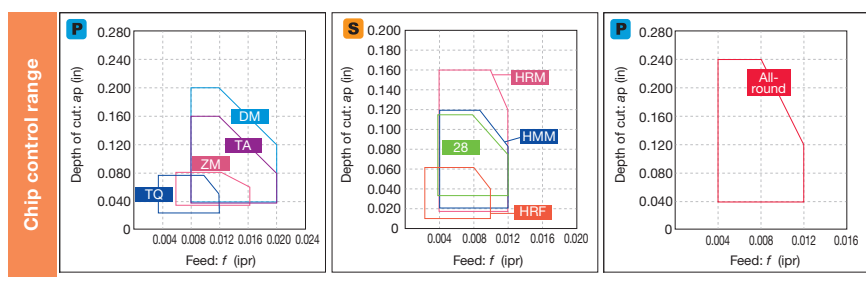

Reference pages: External toolholder → **C020 -** Internal toolholder → **D029 -**
 J-Series toolholder → **G057** TungCap → **K008 -**

Grade: A

Insert: B

Toolholder: C, D, E

Threading: E

Grooving: F

Miniature Tool: G

Milling Cutter: H

Endmill: I

Drilling Tool: J

User's Guide Tooling System: K, L, M

Index: M

Insert **NEGATIVE TYPE**

● : Continuous cutting
 ○ : Light interrupted cutting
 * : Heavy interrupted cutting

CN

Rhombic, 80°
with hole

	P	M	K	N	S	H	Coated	Cermet	Uncoated
Steel	●	●	●	●	●	●	●	●	●
Stainless	○	●	○	○	○	○	○	○	○
Cast iron	○	○	○	○	○	○	○	○	○
Non-ferrous	○	○	○	○	○	○	○	○	○
Superalloy	○	○	○	○	○	○	○	○	○
Hard material	○	○	○	○	○	○	○	○	○

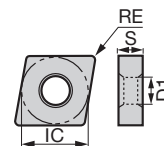

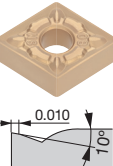
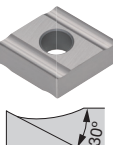
Application	Chipbreaker	Designation	Coated														Cermet		Uncoated		Dimension (inch)						
																	NS9530	TH10	KS05F	KS20	RE	IC	S	D1			
			Inch	Metric	T6120	T6130	AH630	AH645	AH110	AH120	T515	T5105	T5115	T5125	AH725	AH8005	AH8015	AH905	GH110	GH330	GT720	NS9530	TH10	KS05F	KS20	RE	IC
	SM	CNMG 331E SM	CNMG090404E-SM	●	●	●																		0.016	0.375	0.188	0.150
		CNMG 332E SM	CNMG090408E-SM	●	●	●																		0.031	0.375	0.188	0.150
		CNMG 333E SM	CNMG090412E-SM	●	●	●																		0.047	0.375	0.188	0.150
		CNMG 431 SM	CNMG120404-SM	●	●	●								●										0.016	0.500	0.188	0.203
		CNMG 432 SM	CNMG120408-SM	●	●	●								●		●								0.031	0.500	0.188	0.203
		CNMG 433 SM	CNMG120412-SM	●	●	●								●										0.047	0.500	0.188	0.203
		CNMG 543 SM	CNMG160612-SM	●	●																			0.047	0.625	0.250	0.250
Medium cutting	CM	CNMG 431 CM	CNMG120404-CM									●	●	●	●								0.016	0.500	0.188	0.203	
		CNMG 432 CM	CNMG120408-CM									●	●	●	●								0.031	0.500	0.188	0.203	
		CNMG 433 CM	CNMG120412-CM									●	●	●	●								0.047	0.500	0.188	0.203	
		CNMG 542 CM	CNMG160608-CM									●	●	●	●								0.031	0.625	0.250	0.250	
		CNMG 543 CM	CNMG160612-CM									●	●	●	●								0.047	0.625	0.250	0.250	
	P	CNGG 431 R-P	CNGG120404R-P														●			●	●		0.016	0.500	0.188	0.203	
		CNGG 431 L-P	CNGG120404L-P														●			●	●		0.016	0.500	0.188	0.203	
		CNGG 432 R-P	CNGG120408R-P														●			●	●		0.031	0.500	0.188	0.203	
		CNGG 432 L-P	CNGG120408L-P														●			●	●		0.031	0.500	0.188	0.203	
Finishing to medium cutting	HRM	CNMG 431 HRM	CNMG120404-HRM														●	●					0.016	0.500	0.188	0.203	
		CNMG 432 HRM	CNMG120408-HRM														●	●					0.031	0.500	0.188	0.203	
		CNMG 433 HRM	CNMG120412-HRM														●	●					0.047	0.500	0.188	0.203	
		CNMG 542 HRM	CNMG160608-HRM														●	●					0.031	0.625	0.250	0.250	
		CNMG 543 HRM	CNMG160612-HRM														●	●					0.047	0.625	0.250	0.250	
		CNMG 643 HRM	CNMG190612-HRM														●	●					0.047	0.750	0.250	0.312	
		CNMG 644 HRM	CNMG190616-HRM														●	●					0.063	0.750	0.250	0.312	
Medium cutting	HMM	CNMG 431 HMM	CNMG120404-HMM														●						0.016	0.500	0.188	0.203	
		CNMG 432 HMM	CNMG120408-HMM														●				●		0.031	0.500	0.188	0.203	
		CNMG 433 HMM	CNMG120412-HMM														●						0.047	0.500	0.188	0.203	
		CNMG 542 HMM	CNMG160608-HMM														●						0.031	0.625	0.250	0.250	
		CNMG 543 HMM	CNMG160612-HMM														●						0.047	0.625	0.250	0.250	
		CNMG 544 HMM	CNMG160616-HMM														●						0.063	0.625	0.250	0.250	
		SA	CNMG 431 SA	CNMG120404-SA	●	●	●	●	●															0.016	0.500	0.188	0.203
	CNMG 432 SA	CNMG120408-SA	●	●	●	●	●	●														●	0.031	0.500	0.188	0.203	
	CNMG 433 SA	CNMG120412-SA	●	●	●	●	●	●														●	0.047	0.500	0.188	0.203	
	CNMG 643 SA	CNMG190612-SA														●						●	0.047	0.750	0.250	0.312	
	CNMG 644 SA	CNMG190616-SA														●						●	0.063	0.750	0.250	0.312	

● : Line up
 ▲ : To be discontinued

Reference pages: External toolholder → **C018 -**
 J-Series toolholder → **G057**

Internal toolholder → **D028 -**
 TungCap → **K008 -**

Insert NEGATIVE TYPE

● : Continuous cutting
 ● : Light interrupted cutting
 ✱ : Heavy interrupted cutting

CN

**Rhombic, 80°
with hole**

P	Steel	●	●	●	●	✱	●	●	●	✱	✱	✱	✱	✱	✱	✱							
M	Stainless	●	●								●	●	✱										
K	Cast iron	●	●	●			●	●								●	●	●	✱				
N	Non-ferrous																						
S	Superalloy																						
H	Hard material																						

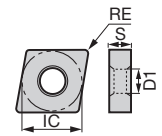

Application	Chipbreaker	Designation		Coated																Dimension (inch)						
		Inch	Metric	T9205	T9215	T9225	T9235	T9115	T9125	T9135	T6130	AH630	AH645	T515	T5105	T5115	T5125	RE	IC	S	D1					
Medium to heavy cutting (single side)		TRS	CNMM 432 TRS	CNMM120408-TRS	●	●	●	▲	▲	▲								0.031	0.500	0.188	0.203					
			CNMM 433 TRS	CNMM120412-TRS	●	●	●	▲	▲	▲									0.047	0.500	0.188	0.203				
			CNMM 543 TRS	CNMM160612-TRS	●	●	●	▲	▲	▲									0.047	0.625	0.250	0.250				
			CNMM 544 TRS	CNMM160616-TRS	●	●	●	▲	▲	▲									0.063	0.625	0.250	0.250				
			CNMM 644 TRS	CNMM190616-TRS	●	●	●	▲	▲	▲									0.063	0.750	0.250	0.312				
			CNMM 646 TRS	CNMM190624-TRS	●	●	●	▲	▲	▲									0.094	0.750	0.250	0.312				
			CNMM 866 TRS	CNMM250924-TRS	●	●	●	▲	▲	▲									0.094	1.000	0.375	0.359				
Heavy cutting (single side)		TU	CNMM 643 TU	CNMM190612-TU		●	●		▲	▲								0.047	0.750	0.250	0.312					
			CNMM 644 TU	CNMM190616-TU		●	●		▲	▲									0.063	0.750	0.250	0.312				
			CNMM 646 TU	CNMM190624-TU	●	●	●	▲	▲	▲									0.094	0.750	0.250	0.312				
			CNMM 866 TU	CNMM250924-TU		●	●		▲	▲									0.094	1.000	0.375	0.359				
Medium to heavy cutting (single side)		TUS	CNMM 642 TUS	CNMM190608-TUS	●	●			▲	▲								0.031	0.750	0.250	0.312					
			CNMM 643 TUS	CNMM190612-TUS	●	●	●		▲	▲	▲								0.047	0.750	0.250	0.312				
			CNMM 644 TUS	CNMM190616-TUS	●	●	●		▲	▲	▲								0.063	0.750	0.250	0.312				
			CNMM 646 TUS	CNMM190624-TUS	●	●	●		▲	▲	▲								0.094	0.750	0.250	0.312				
			CNMM 648 TUS	CNMM190632-TUS	●	●			▲	▲									0.125	0.750	0.250	0.312				
			CNMM 864 TUS	CNMM250916-TUS	●	●	●		▲	▲	▲								0.063	1.000	0.375	0.359				
			CNMM 866 TUS	CNMM250924-TUS	●	●	●		▲	▲	▲								0.094	1.000	0.375	0.359				
			CNMM 868 TUS	CNMM250932-TUS	●	●			▲	▲									0.125	1.000	0.375	0.359				
Medium to heavy cutting (single side)		65	CNMM 433-65	CNMM120412-65		●				▲								0.047	0.500	0.188	0.203					
Medium to heavy cutting		SH	CNMG 432 SH	CNMG120408-SH								●	●	●				0.031	0.500	0.188	0.203					
			CNMG 433 SH	CNMG120412-SH									●	●	●				0.047	0.500	0.188	0.203				
			CNMG 434 SH	CNMG120416-SH										●	●	●				0.063	0.500	0.188	0.203			
			CNMG 543 SH	CNMG160612-SH										●	●	●				0.047	0.625	0.250	0.250			
			CNMG 544 SH	CNMG160616-SH											●	●	●				0.063	0.625	0.250	0.250		
			CNMG 643 SH	CNMG190612-SH												●	●	●				0.047	0.750	0.250	0.312	
			CNMG 644 SH	CNMG190616-SH													●	●	●				0.063	0.750	0.250	0.312
	Medium to heavy cutting		CH	CNMG 431 CH	CNMG120404-CH											●	●	●	0.016	0.500	0.188	0.203				
				CNMG 432 CH	CNMG120408-CH												●	●	●	0.031	0.500	0.188	0.203			
				CNMG 433 CH	CNMG120412-CH												●	●	●	0.047	0.500	0.188	0.203			
				CNMG 543 CH	CNMG160612-CH													●	●	●	0.047	0.625	0.250	0.250		
				CNMG 544 CH	CNMG160616-CH														●	●	●	0.063	0.625	0.250	0.250	

● : Line up
 ▲ : To be discontinued

Insert NEGATIVE TYPE

- : Continuous cutting
- : Light interrupted cutting
- ✱ : Heavy interrupted cutting

CN

Rhombic, 80°
with hole

P	Steel	●	●							●●								
M	Stainless																	
K	Cast iron	●●	●●	●●	●●	●	✱			●●						●●		
N	Non-ferrous															●		
S	Superalloy																	
H	Hard material																	●

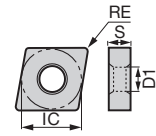

Application	Chipbreaker	Designation	Coated					Cermet		Uncoated	Ceramic			Dimension (inch)				
			T9205	T9105	T515	T5105	T5115	T5125	NS520	TH10	TZ120	FX105	LX21	LX11	RE	IC	S	D1
		Inch	Metric															
Finishing to medium cutting	-	CNMA 331E	CNMA090404E			●									0.016	0.375	0.188	0.150
		CNMA 332E	CNMA090408E			●									0.031	0.375	0.188	0.150
		CNMA 333E	CNMA090412E			●									0.047	0.375	0.188	0.150
		CNMA 334E	CNMA090416E			●									0.063	0.375	0.188	0.150
		CNMA 431	CNMA120404				●	●	●			●			0.016	0.500	0.188	0.203
		CNMA 432	CNMA120408	●	▲	●	●	●	●	●		●	●		0.031	0.500	0.188	0.203
		CNMA 433	CNMA120412	●	▲	●	●	●	●	●		●	●		0.047	0.500	0.188	0.203
		CNMA 434	CNMA120416	●	▲	●	●	●	●	●		●	●		0.063	0.500	0.188	0.203
		CNMA 542	CNMA160608				●	●	●						0.031	0.625	0.250	0.250
		CNMA 543	CNMA160612				●	●	●	●					0.047	0.625	0.250	0.250
		CNMA 544	CNMA160616				●	●	●	●					0.063	0.625	0.250	0.250
		CNMA 643	CNMA190612				●	●	●	●					0.047	0.750	0.250	0.312
		CNMA 644	CNMA190616				●	●	●	●					0.063	0.750	0.250	0.312
	Finishing to medium cutting	Wiper	CNMA 432 W	CNMA120408W											0.031	0.500	0.188	0.203
			CNMA 433 W	CNMA120412W											0.047	0.500	0.188	0.203
			CNMA 434 W	CNMA120416W											0.063	0.500	0.188	0.203
-		CNMA 431	CNMA120404															
		CNMA 432	CNMA120408															
		CNMA 433	CNMA120412															
Finishing to medium cutting		CNMA 434	CNMA120416															
		CNMA 435	CNMA120420															
		CNMA 431	CNMA120404															
		CNMA 432	CNMA120408															
		CNMA 433	CNMA120412															

● : Line up
▲ : To be discontinued

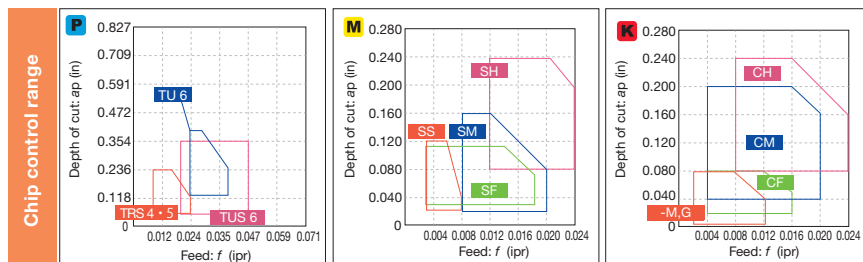

*-M,G: Without chipbreaker

Reference pages: External toolholder → C020 - Internal toolholder → D028 -
J-Series toolholder → G057 TungCap → K008 -

Grade
Insert
Ext. Toolholder
Int. Toolholder
Threading
Grooving
Miniature Tool
Endmill
Drilling Tool
Tooling System
User's Guide
Index



Insert NEGATIVE TYPE

● : Continuous cutting
 ● : Light interrupted cutting
 ✳ : Heavy interrupted cutting

CN

Rhombic, 80° without hole

P	Steel																
M	Stainless																
K	Cast iron	●	●		●	●											
N	Non-ferrous																
S	Superalloy																
H	Hard material		●														

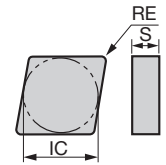

Application	Designation		Ceramic				Dimension (inch)			
	Inch	Metric	FX105	LX21	LX11	CX710	RE	IC	S	D1
Chipbreaker	CNGD 453	CNGD120712	●				0.047	0.500	0.313	-
	CNGD 454	CNGD120716	●				0.063	0.500	0.313	-
Finishing to medium cutting	CNMN 432	CNMN120408	●				0.031	0.500	0.187	-
	CNMN 433	CNMN120412	●				0.047	0.500	0.187	-
	CNGN 431	CNGN120404			●		0.016	0.500	0.187	-
	CNGN 432	CNGN120408	●	●			0.031	0.500	0.187	-
	CNGN 433	CNGN120412	●	●	●		0.047	0.500	0.187	-
	CNGN 434	CNGN120416	●	●	●		0.063	0.500	0.187	-
	CNGN 435	CNGN120420	●				0.079	0.500	0.187	-
	CNGN 452	CNGN120708	●	●			0.031	0.500	0.313	-
	CNGN 453	CNGN120712	●	●			0.047	0.500	0.313	-
	CNGN 454	CNGN120716	●	●			0.063	0.500	0.313	-
CNGN 455	CNGN120720			●		0.079	0.500	0.313	-	

● : Line up

Reference pages: CNGD...: External toolholder → **C024**

Insert NEGATIVE TYPE

● : Continuous cutting
 ● : Light interrupted cutting
 ✱ : Heavy interrupted cutting

DN

Rhombic, 55°
with hole

Material	T9205	T9215	T9225	T9235	T9105	T9115	T9125	T9135	T515	AH120	AH8015	GH110	GT9530	AT9530	GT720	NS9530	NS520	TH10	
P Steel	●	●	●	✱	●	●	●	✱	●	●	●	●	●	●	●	●	●	●	●
M Stainless	●	●								●	●	●	●	●	●	●	●	●	●
K Cast iron	●	●	●		●	●	●		●	●	●	●	●	●	●	●	●	●	●
N Non-ferrous										●	●	●	●	●	●	●	●	●	●
S Superalloy									●	●	●	●	●	●	●	●	●	●	●
H Hard material																			

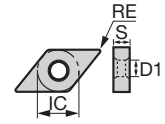

Application	Chipbreaker	Designation		Coated														Coated cermet	Cer- met	Un- coated	Dimension (inch)							
		Inch	Metric	T9205	T9215	T9225	T9235	T9105	T9115	T9125	T9135	T515	AH120	AH8015	GH110	GT9530	AT9530	GT720	NS9530	NS520	TH10	RE	IC	S	D1			
Precision finishing		TF	DNMG 330.5E TF	DNMG110402E-TF	●	●																						
			DNMG 431 TF	DNMG150404-TF															●	●			0.016	0.500	0.187	0.203		
			DNMG 432 TF	DNMG150408-TF															●				0.031	0.500	0.187	0.203		
		O1	DNGG 330.5-O1	DNGG110402-O1															●				0.008	0.375	0.187	0.150		
			DNGG 331-O1	DNGG110404-O1															●	●			0.016	0.375	0.187	0.150		
			DNGG 332-O1	DNGG110408-O1														●	●	●			0.031	0.375	0.187	0.150		
			DNGG 430.5-O1	DNGG150402-O1															●	●	●		0.008	0.500	0.187	0.203		
			DNGG 431-O1	DNGG150404-O1											●				●	●	●		0.016	0.500	0.187	0.203		
		DNGG 432-O1	DNGG150408-O1											●				●	●	●		0.031	0.500	0.187	0.203			
Finishing		TSAF	DNMG 330.5E TSAF	DNMG110402E-TSAF	●	●																0.008	0.375	0.187	0.150			
			DNMG 331E TSAF	DNMG110404E-TSAF	●	●				▲	▲				●	●		●				0.016	0.375	0.187	0.150			
			DNMG 332E TSAF	DNMG110408E-TSAF	●	●				▲	▲				●	●		●				0.031	0.375	0.187	0.150			
			DNMG 333E TSAF	DNMG110412E-TSAF	●	●				▲	▲				●	●		●					0.047	0.375	0.187	0.150		
			DNMG 431 TSAF	DNMG150404-TSAF	●	●	●	●	▲	▲	▲	▲			●	●		●					0.016	0.500	0.187	0.203		
			DNMG 432 TSAF	DNMG150408-TSAF	●	●	●	●	▲	▲	▲	▲			●	●		●					0.031	0.500	0.187	0.203		
			DNMG 433 TSAF	DNMG150412-TSAF	●	●	●	●	▲	▲	▲	▲	●	●	●	●							0.047	0.500	0.187	0.203		
			DNMG 441 TSAF	DNMG150604-TSAF	●	●			▲	▲					●	●		●					0.016	0.500	0.250	0.203		
			DNMG 442 TSAF	DNMG150608-TSAF	●	●	●	●	▲	▲	▲	▲			●	●		●					0.031	0.500	0.250	0.203		
	DNMG 443 TSAF	DNMG150612-TSAF	●	●	●	●	▲	▲	▲	▲											0.047	0.500	0.250	0.203				
Finishing (wiper)		FW	DNMG 331E FW	DNMG110404E-FW	●					▲												0.016	0.375	0.187	0.150			
			DNMG 332E FW	DNMG110408E-FW	●					▲													0.031	0.375	0.187	0.150		
			DNMG 431 FW	DNMG150404-FW	●					▲													0.016	0.500	0.187	0.203		
			DNMG 432 FW	DNMG150408-FW	●					▲													0.031	0.500	0.187	0.203		
			DNMG 441 FW	DNMG150604-FW	●					▲													0.016	0.500	0.250	0.203		
			DNMG 442 FW	DNMG150608-FW	●					▲													0.031	0.500	0.250	0.203		

* Please see L034-L038 about the adjustment of the machining program for rounding or taper machining by using SW/FW. Please contact a Tungaloy sales representative with questions.

● : Line up
 ▲ : To be discontinued

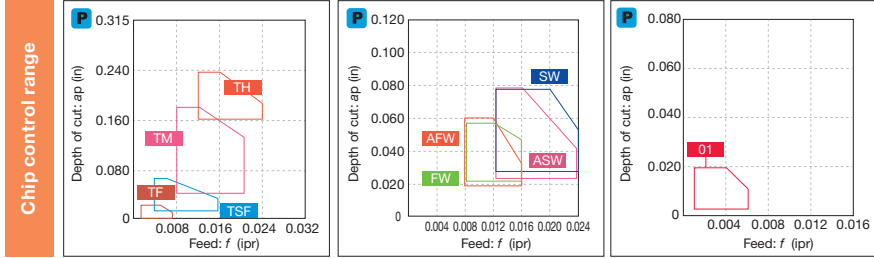

Reference pages: External toolholder → C040 - Internal toolholder → D060 -
 J-Series toolholder → G059 TungCap → C048, K012 -

Grade	A
Insert	B
Ext. Toolholder	C
Int. Toolholder	D
Threading	E
Grooving	F
Milling Cutter	G
Miniature Tool	H
Endmill	I
Drilling Tool	J
User's Guide	K
Tooling System	L
Index	M

Insert NEGATIVE TYPE

- : Continuous cutting
- ◐ : Light interrupted cutting
- ⬮ : Heavy interrupted cutting

DN

Rhombic, 55°
with hole

P Steel	● ● ● ● ● ✖ ● ● ● ● ✖	● ● ● ●	● ● ● ●	● ● ● ●	● ● ● ●	● ● ● ●	● ● ● ●	● ● ● ●	● ● ● ●
M Stainless	● ●								
K Cast iron	● ● ● ●			● ● ● ●			● ● ● ●		● ● ● ●
N Non-ferrous									
S Superalloy									
H Hard material									

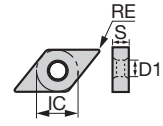

Application	Chipbreaker	Designation	Coated								Coated cermet		Cermet		Dimension (inch)												
			Inch				Metric				T9205	T9215	T9225	T9235	T9105	T9115	T9125	T9135	GT9530	AT9530	NS9530	NS520	RE	IC	S	D1	
Finishing		TS	DNMG 332 TS	DNMG110408-TS				●															0.031	0.375	0.187	0.150	
			DNMG 431 TS	DNMG150404-TS				●	●	●					●	●							0.016	0.500	0.187	0.203	
			DNMG 432 TS	DNMG150408-TS				●	●	●	▲	▲	▲	▲	●	●							0.031	0.500	0.187	0.203	
			DNMG 433 TS	DNMG150412-TS				●	●	●	▲	▲	▲	▲	●	●								0.047	0.500	0.187	0.203
			DNMG 441 TS	DNMG150604-TS												●	●							0.016	0.500	0.250	0.203
			DNMG 442 TS	DNMG150608-TS				●	●		▲	▲			●	●								0.031	0.500	0.250	0.203
Finishing to medium cutting (wiper)		SW	DNMG 332E SW	DNMG110408E-SW				●							▲								0.031	0.375	0.187	0.150	
			DNMG 333E SW	DNMG110412E-SW				●							▲								0.047	0.375	0.187	0.150	
			DNMG 432 SW	DNMG150408-SW				●							▲								0.031	0.500	0.187	0.203	
			DNMG 433 SW	DNMG150412-SW				●							▲								0.047	0.500	0.187	0.203	
			DNMG 442 SW	DNMG150608-SW				●							▲								0.031	0.500	0.250	0.203	
			DNMG 443 SW	DNMG150612-SW				●							▲								0.047	0.500	0.250	0.203	
High feed, small depth of cut		AS	DNMG 431 AS	DNMG150404-AS				●	●		▲	▲									●		0.016	0.500	0.187	0.203	
			DNMG 432 AS	DNMG150408-AS				●	●	●		▲	▲	▲								●		0.031	0.500	0.187	0.203
			DNMG 433 AS	DNMG150412-AS				●	●	●		▲	▲	▲									0.047	0.500	0.187	0.203	
			DNMG 441 AS	DNMG150604-AS				●					▲										0.016	0.500	0.250	0.203	
			DNMG 442 AS	DNMG150608-AS				●	●				▲	▲									0.031	0.500	0.250	0.203	
			DNMG 443 AS	DNMG150612-AS				●					▲										0.047	0.500	0.250	0.203	
Boring (double side)		CB	DNMG 331 CB	DNMG110404-CB																			0.016	0.375	0.187	0.150	
			DNMG 332 CB	DNMG110408-CB				●							▲								0.031	0.375	0.187	0.150	
Finishing		NS	DNMG 431 NS	DNMG150404-NS						●													0.016	0.500	0.187	0.203	
			DNMG 432 NS	DNMG150408-NS				●	●	●		▲	▲	▲									0.031	0.500	0.187	0.203	

* Please see L034-L038 about the adjustment of the machining program for rounding or taper machining by using SW/FW. Please contact a Tungaloy sales representative with questions.

● : Line up
▲ : To be discontinued

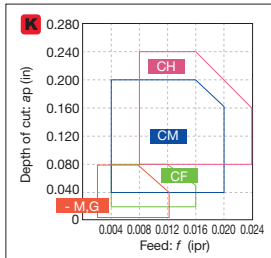
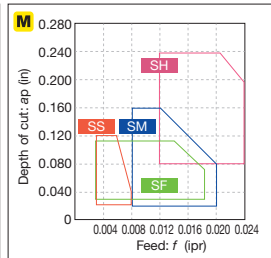
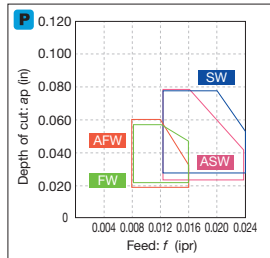
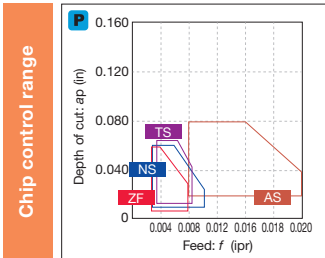

*-M,G: Without chipbreaker

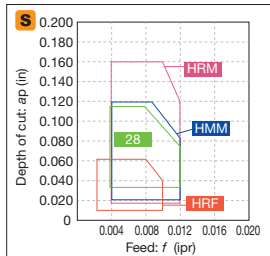

Reference pages: External toolholder → C040 - Internal toolholder → D060 -
J-Series toolholder → G059
TungCap → C048, K012 -

Insert NEGATIVE TYPE

- : Continuous cutting
- ◐ : Light interrupted cutting
- ✱ : Heavy interrupted cutting

DN

Rhombic, 55° with hole

Material	P	M	K	N	S	H
Steel	●●●●✱	●●●●✱	●●●●✱	●●●●✱	●●●●✱	●●●●✱
Stainless	●●	●●	●●	●●	●●	●●
Cast iron	●●●●	●●●●	●●●●	●●●●	●●●●	●●●●
Non-ferrous						
Superalloy						
Hard material						

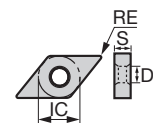

Application	Chipbreaker	Designation		Coated													Coated Cermet	Cermet	Uncoated	Dimension (inch)													
		Inch	Metric	T9205	T9215	T9225	T9235	T9105	T9115	T9125	T9135	T6120	T6130	AH630	AH645	AH110	AH120	AH8005	AH8015	GH330	GT9530	NS9530	KS20	RE	IC	S	D1						
Finishing		SS	DNMG 331E SS	DNMG110404E-SS																					●				0.016	0.375	0.187	0.150	
			DNMG 332E SS	DNMG110408E-SS											●	●										●				0.031	0.375	0.187	0.150
			DNMG 431 SS	DNMG150404-SS										●	●	●	●							●		●				0.016	0.500	0.187	0.203
			DNMG 432 SS	DNMG150408-SS										●	●	●	●							●		●				0.031	0.500	0.187	0.203
			DNMG 433 SS	DNMG150412-SS										●	●	●	●													0.047	0.500	0.187	0.203
			DNMG 441 SS	DNMG150604-SS										●	●	●	●		●					●						0.016	0.500	0.250	0.203
			DNMG 442 SS	DNMG150608-SS										●	●	●	●		●					●						0.031	0.500	0.250	0.203
			DNMG 443 SS	DNMG150612-SS										●	●	●	●													0.047	0.500	0.250	0.203
Medium cutting		TM	DNMG 331E TM	DNMG110404E-TM	●	●											●		●									0.016	0.375	0.187	0.150		
			DNMG 332E TM	DNMG110408E-TM	●	●					▲	▲						●		●									0.031	0.375	0.187	0.150	
			DNMG 333E TM	DNMG110412E-TM	●	●					▲	▲						●		●									0.047	0.375	0.187	0.150	
			DNMG 331 TM	DNMG110404-TM	●	●	●				▲	▲	▲																	0.016	0.375	0.187	0.150
			DNMG 332 TM	DNMG110408-TM	●	●	●				▲	▲	▲																	0.031	0.375	0.187	0.150
			DNMG 431 TM	DNMG150404-TM	●	●	●	●	▲	▲	▲	▲						●	●											0.016	0.500	0.187	0.203
			DNMG 432 TM	DNMG150408-TM	●	●	●	●	▲	▲	▲	▲						●	●											0.031	0.500	0.187	0.203
			DNMG 433 TM	DNMG150412-TM	●	●	●	●	▲	▲	▲	▲						●	●											0.047	0.500	0.187	0.203
			DNMG 434 TM	DNMG150416-TM	●	●					▲	▲																		0.063	0.500	0.187	0.203
			DNMG 441 TM	DNMG150604-TM	●	●	●	●	▲	▲	▲	▲						●												0.016	0.500	0.250	0.203
			DNMG 442 TM	DNMG150608-TM	●	●	●	●	▲	▲	▲	▲						●												0.031	0.500	0.250	0.203
			DNMG 443 TM	DNMG150612-TM	●	●	●	●	▲	▲	▲	▲						●												0.047	0.500	0.250	0.203
DNMG 444 TM	DNMG150616-TM	●	●	●	●	▲	▲	▲	▲							●											0.063	0.500	0.250	0.203			
Finishing to medium cutting		AM	DNMG 432 AM	DNMG150408-AM	●	●				▲	▲																0.031	0.500	0.187	0.203			
			DNMG 433 AM	DNMG150412-AM	●	●					▲	▲																	0.047	0.500	0.187	0.203	
			DNMG 434 AM	DNMG150416-AM	●	●					▲	▲																	0.063	0.500	0.187	0.203	
			DNMG 442 AM	DNMG150608-AM	●	●					▲	▲																		0.031	0.500	0.250	0.203
			DNMG 443 AM	DNMG150612-AM	●	●					▲	▲																		0.047	0.500	0.250	0.203
			DNMG 444 AM	DNMG150616-AM	●	●					▲	▲																		0.063	0.500	0.250	0.203
			NM	DNMG 432 NM	DNMG150408-NM	●	●	●				▲	▲	▲										●	●					0.031	0.500	0.187	0.203
				DNMG 433 NM	DNMG150412-NM	●	●	●				▲	▲	▲																0.047	0.500	0.187	0.203
DNMG 442 NM	DNMG150608-NM																				●	●					0.031	0.500	0.250	0.203			

● : Line up
▲ : To be discontinued

Insert NEGATIVE TYPE

- : Continuous cutting
- ◐ : Light interrupted cutting
- ◑ : Heavy interrupted cutting

DN

Rhombic, 55° with hole

P	Steel	●	◐	◑	●	◐	◑	●	◐	◑	●	◐	◑	●	◐	◑	●	◐	◑	●	◐	◑
M	Stainless	●	◐																			
K	Cast iron	◐	◑		◐	◑		◐	◑		◐	◑		◐	◑		◐	◑		◐	◑	
N	Non-ferrous																					●
S	Superalloy																					●
H	Hard material																					

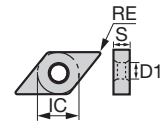

Application	Designation		Coated																	Coated cermet	Cermet	Un-coated	Dimension (inch)				
	Inch	Metric	T9205	T9215	T9225	T9235	T9105	T9115	T9125	T9135	T515	T5105	T5115	T5125	AH110	AH120	GT9530	AT9530	NS9530	NS520	TH10	RE	IC	S	D1		
Finishing to medium cutting		TQ DNMG 431 TQ	DNMG150404-TQ	●	●	●	◐	●	◐	◑	●							●	●	●			0.016	0.500	0.187	0.203	
		DNMG 432 TQ	DNMG150408-TQ	●	●													●	●	●			0.031	0.500	0.187	0.203	
Finishing to medium cutting		ZM DNMG 332E ZM	DNMG110408E-ZM	●	●			▲	▲													0.031	0.375	0.187	0.150		
		DNMG 432 ZM	DNMG150408-ZM	●	●	●		▲	▲	▲								●		●			0.031	0.500	0.187	0.203	
		DNMG 433 ZM	DNMG150412-ZM	●	●	●		▲	▲	▲													0.047	0.500	0.187	0.203	
		DNMG 442 ZM	DNMG150608-ZM	●	●	●		▲	▲	▲													0.031	0.500	0.250	0.203	
		DNMG 443 ZM	DNMG150612-ZM	●	●			▲	▲														0.047	0.500	0.250	0.203	
Medium cutting		DM DNMG 432 DM	DNMG150408-DM	●	●	●		▲	▲	▲												0.031	0.500	0.187	0.203		
		DNMG 433 DM	DNMG150412-DM	●	●	●		▲	▲	▲	▲												0.047	0.500	0.187	0.203	
		DNMG 441 DM	DNMG150604-DM	●				▲															0.016	0.500	0.250	0.203	
		DNMG 442 DM	DNMG150608-DM	●	●	●		▲	▲	▲													0.031	0.500	0.250	0.203	
		DNMG 443 DM	DNMG150612-DM	●	●	●		▲	▲	▲	▲												0.047	0.500	0.250	0.203	
		DNMG 444 DM	DNMG150616-DM	●				▲															0.063	0.500	0.250	0.203	
		All-round DNMG 331	DNMG110404	●	●			▲	▲				●	●	●			●		●			0.016	0.375	0.187	0.150	
		DNMG 332	DNMG110408	●	●	●		▲	▲	▲	▲		●	●	●			●		●			0.031	0.375	0.187	0.150	
		DNMG 431	DNMG150404	●	●	●		▲	▲	▲			●	●	●	●		●		●	●	●	0.016	0.500	0.187	0.203	
		DNMG 432	DNMG150408	●	●	●		▲	▲	▲	▲		●	●	●	●		●		●	●	●	0.031	0.500	0.187	0.203	
		DNMG 433	DNMG150412	●	●	●		▲	▲	▲	▲		●	●	●	●							0.047	0.500	0.187	0.203	
DNMG 434	DNMG150416	●	●			▲	▲				●	●	●								0.063	0.500	0.187	0.203			
DNMG 441	DNMG150604	●	●			▲					●	●	●								0.016	0.500	0.250	0.203			
DNMG 442	DNMG150608	●	●	●		▲	▲	▲	▲		●	●	●	●							0.031	0.500	0.250	0.203			
DNMG 443	DNMG150612	●	●	●		▲	▲	▲	▲		●	●	●	●							0.047	0.500	0.250	0.203			
DNMG 444	DNMG150616	●	●			▲	▲														0.063	0.500	0.250	0.203			
Finishing to medium cutting		27 DNMG 431-27	DNMG150404-27		●			▲											●			0.016	0.500	0.187	0.203		
		DNMG 432-27	DNMG150408-27	●	●			▲	▲											●			0.031	0.500	0.187	0.203	
		DNMG 433-27	DNMG150412-27	●				▲															0.047	0.500	0.187	0.203	

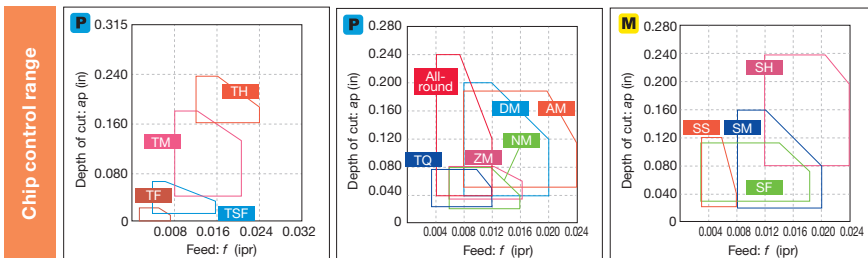

- : Line up
- ▲ : To be discontinued

Reference pages: External toolholder → C040 - Internal toolholder → D060 -
J-Series toolholder → G059 TungCap → C048, K012 -

Grade: A, B, C, D, E, F, G, H, I, J, K, L, M

Insert NEGATIVE TYPE

● : Continuous cutting
 ○ : Light interrupted cutting
 ✱ : Heavy interrupted cutting

DN

**Rhombic, 55°
with hole**

P	Steel	●	●	●	●	○	✱								●	●	●	●	●	●	●	●	
M	Stainless	●	●		●	○								●	✱	●		○	●	●	●	●	●
K	Cast iron	●	●	●	●		●	●	○	✱					●		○	●	●	●	●	●	●
N	Non-ferrous																				●		
S	Superalloy														●		○	●	●				
H	Hard material																						

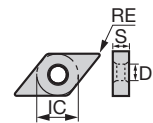

Application	Chipbreaker	Designation		Coated															Dimension (inch)												
		Inch	Metric																RE	IC	S	D1									
				T9215	T9115	T6120	T6130	T515	T5105	T5115	T5125	AH630	AH645	AH8005	AH8015	AH110	AH120	GH330					GT9530	NS9530	TH10						
Medium cutting	 0.008	28	DNMG 431-28	DNMG150404-28																					0.016	0.500	0.187	0.203			
			DNMG 432-28	DNMG150408-28																							0.031	0.500	0.187	0.203	
			DNMG 441-28	DNMG150604-28																								0.016	0.500	0.250	0.203
			DNMG 442-28	DNMG150608-28																								0.031	0.500	0.250	0.203
	 0.008	33	DNMG 431-33	DNMG150404-33																							0.016	0.500	0.187	0.203	
			DNMG 432-33	DNMG150408-33																				●			0.031	0.500	0.187	0.203	
		 0.008 30°	37	DNMG 431-37	DNMG150404-37																					●	0.016	0.500	0.187	0.203	
				DNMG 432-37	DNMG150408-37																					●	0.031	0.500	0.187	0.203	
		DNMG 442-37	DNMG150608-37	●	▲																						0.031	0.500	0.250	0.203	
	Medium cutting	 0.008 10°	38	DNMG 433-38	DNMG150412-38	●	▲																				0.047	0.500	0.187	0.203	
			 0.006 4°	Parallel	DNGG 431 R	DNGG150404R														●	●						0.016	0.500	0.187	0.203	
					DNGG 431 L	DNGG150404L															●	●						0.016	0.500	0.187	0.203
				DNGG 432 R	DNGG150408R																●	●						0.031	0.500	0.187	0.203
		DNGG 432 L		DNGG150408L																●	●						0.031	0.500	0.187	0.203	
 0.010 10°		SM	DNMG 331E SM	DNMG110404E-SM			●	●					●														0.016	0.375	0.187	0.150	
			DNMG 332E SM	DNMG110408E-SM			●	●					●															0.031	0.375	0.187	0.150
			DNMG 431 SM	DNMG150404-SM			●	●						●	●													0.016	0.500	0.187	0.203
		DNMG 432 SM	DNMG150408-SM			●	●							●	●												0.031	0.500	0.187	0.203	
Medium cutting	 0.010 75°	CM	DNMG 431 CM	DNMG150404-CM					●	●	●	●														0.016	0.500	0.187	0.203		
			DNMG 432 CM	DNMG150408-CM					●	●	●	●															0.031	0.500	0.187	0.203	
			DNMG 433 CM	DNMG150412-CM					●	●	●	●																0.047	0.500	0.187	0.203
			DNMG 441 CM	DNMG150604-CM							●	●	●															0.016	0.500	0.250	0.203
			DNMG 442 CM	DNMG150608-CM								●	●	●														0.031	0.500	0.250	0.203
			DNMG 443 CM	DNMG150612-CM									●	●	●													0.047	0.500	0.250	0.203
			DNMG 441 CM	DNMG150604-CM							●	●	●															0.016	0.500	0.250	0.203
			DNMG 442 CM	DNMG150608-CM								●	●	●														0.031	0.500	0.250	0.203
			DNMG 443 CM	DNMG150612-CM									●	●	●													0.047	0.500	0.250	0.203

● : Line up
 ▲ : To be discontinued

Reference pages: External toolholder → **C040 -** Internal toolholder → **D060 -**
 J-Series toolholder → **G059** TungCap → **C048, K012 -**

Insert NEGATIVE TYPE

- : Continuous cutting
- ◐ : Light interrupted cutting
- ◑ : Heavy interrupted cutting

DN

 Rhombic, 55° with hole

Material	P Steel	M Stainless	K Cast iron	N Non-ferrous	S Superalloy	H Hard material
Coated	●	●	●	●	●	●
Cermet	●	●	●	●	●	●
Un-coated	●	●	●	●	●	●

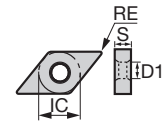

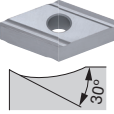
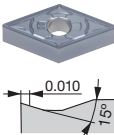
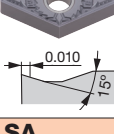
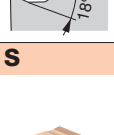
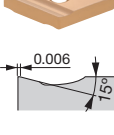
Application	Chipbreaker	Designation		Coated										Cermet	Un-coated	Dimension (inch)						
		Inch	Metric	T9225	T9235	T9125	T9135	T6130	AH630	AH645	AH120	AH8005	AH8015	AH905	GH110	GH330	NS9530	TH10	RE	IC	S	D1
Medium cutting		P	DNKG 430.5 R-P	DNKG150402R-P													●	0.008	0.500	0.187	0.203	
			DNKG 430.5 L-P	DNKG150402L-P														●	0.008	0.500	0.187	0.203
			DNKG 431 R-P	DNKG150404R-P														●	0.016	0.500	0.187	0.203
			DNKG 431 L-P	DNKG150404L-P														●	0.016	0.500	0.187	0.203
			DNKG 432 R-P	DNKG150408R-P														●	0.031	0.500	0.187	0.203
			DNKG 432 L-P	DNKG150408L-P														●	0.031	0.500	0.187	0.203
Finishing to medium cutting		HRM	DNMG 431 HRM	DNMG150404-HRM							●	●						0.016	0.500	0.187	0.203	
			DNMG 432 HRM	DNMG150408-HRM								●	●						0.031	0.500	0.187	0.203
			DNMG 433 HRM	DNMG150412-HRM								●	●						0.047	0.500	0.187	0.203
			DNMG 441 HRM	DNMG150604-HRM								●	●						0.016	0.500	0.250	0.203
			DNMG 442 HRM	DNMG150608-HRM								●	●						0.031	0.500	0.250	0.203
			DNMG 443 HRM	DNMG150612-HRM								●	●						0.047	0.500	0.250	0.203
Medium cutting		HMM	DNMG 431 HMM	DNMG150404-HMM														0.016	0.500	0.187	0.203	
			DNMG 432 HMM	DNMG150408-HMM															0.031	0.500	0.187	0.203
			DNMG 433 HMM	DNMG150412-HMM															0.047	0.500	0.187	0.203
			SA	DNMG 431 SA	DNMG150404-SA														0.016	0.500	0.187	0.203
			DNMG 432 SA	DNMG150408-SA															0.031	0.500	0.187	0.203
			DNMG 441 SA	DNMG150604-SA															0.016	0.500	0.250	0.203
Medium cutting		S	DNMG 431 R-S	DNMG150404R-S	●	●	▲	▲	●	●	●							0.016	0.500	0.187	0.203	
			DNMG 431 L-S	DNMG150404L-S	●	●	▲	▲	●	●	●							0.016	0.500	0.187	0.203	
			DNMG 432 R-S	DNMG150408R-S	●	●	▲	▲	●	●	●							0.031	0.500	0.187	0.203	
			DNMG 432 L-S	DNMG150408L-S	●	●	▲	▲	●	●	●							0.031	0.500	0.187	0.203	
			DNMG 441 R-S	DNMG150604R-S	●	●	▲	▲	●	●	●							0.016	0.500	0.250	0.203	
			DNMG 441 L-S	DNMG150604L-S	●	●	▲	▲	●	●	●							0.016	0.500	0.250	0.203	
Medium cutting			DNMG 442 R-S	DNMG150608R-S	●	●	▲	▲	●	●	●						0.031	0.500	0.250	0.203		
			DNMG 442 L-S	DNMG150608L-S	●	●	▲	▲	●	●	●						0.031	0.500	0.250	0.203		

● : Line up
▲ : To be discontinued

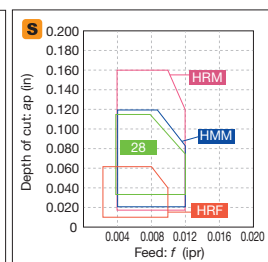
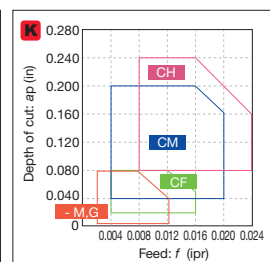
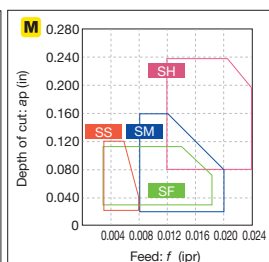
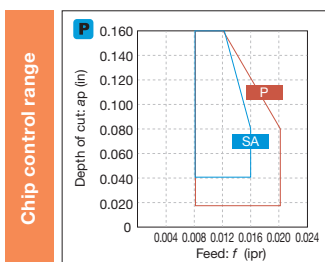

*-M,G: Without chipbreaker

Reference pages: External toolholder → **C046 -**
J-Series toolholder → **G059**

Internal toolholder → **D060 -**
TungCap → **C048, K012 -**

Insert NEGATIVE TYPE

● : Continuous cutting
 ● : Light interrupted cutting
 ✱ : Heavy interrupted cutting

DN

Rhombic, 55° with hole

P	Steel	●	●	●	✱	●	●	●	✱	✱	✱	✱	✱	✱	✱	✱	✱	✱	✱
M	Stainless	●	●																
K	Cast iron	●	●																
N	Non-ferrous																		
S	Superalloy																		
H	Hard material																		

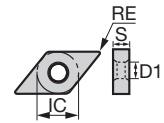

Application	Chipbreaker	Designation		Coated														Coated Cermet	Un-coated	Dimension (inch)								
		Inch	Metric	T9215	T9225	T9235	T9115	T9125	T9135	T6130	AH630	AH645	AH8015	T515	T5105	T5115	T5125	AH120	GT720	NS520	TH10	RE	IC	S	D1			
Medium to heavy cutting (single side)		DNMM 442-57	DNMM150608-57	●				▲															0.031	0.500	0.250	0.203		
		DNMM 443-57	DNMM150612-57	●				▲																0.047	0.500	0.250	0.203	
Medium to heavy cutting		DNMG 432 TH	DNMG150408-TH	●	●	●	▲	▲	▲					●	●								0.031	0.500	0.187	0.203		
		DNMG 433 TH	DNMG150412-TH	●	●	●	▲	▲	▲					●	●									0.047	0.500	0.187	0.203	
		DNMG 434 TH	DNMG150416-TH	●	●		▲	▲																0.063	0.500	0.187	0.203	
		DNMG 442 TH	DNMG150608-TH	●	●	●	▲	▲	▲										●					0.031	0.500	0.250	0.203	
		DNMG 443 TH	DNMG150612-TH	●	●	●	▲	▲	▲										●					0.047	0.500	0.250	0.203	
		DNMG 444 TH	DNMG150616-TH	●	●	●	▲	▲	▲															0.063	0.500	0.250	0.203	
		DNMG 432 THS	DNMG150408-THS	●	●	●	▲	▲	▲															0.031	0.500	0.187	0.203	
		DNMG 433 THS	DNMG150412-THS	●	●	●	▲	▲	▲															0.047	0.500	0.187	0.203	
		DNMG 434 THS	DNMG150416-THS	●	●		▲	▲																0.063	0.500	0.187	0.203	
		DNMG 442 THS	DNMG150608-THS	●	●	●	▲	▲	▲															0.031	0.500	0.250	0.203	
		DNMG 443 THS	DNMG150612-THS	●	●	●	▲	▲	▲															0.047	0.500	0.250	0.203	
		DNMG 444 THS	DNMG150616-THS	●	●		▲	▲																0.063	0.500	0.250	0.203	
	DNMG 432 SH	DNMG150408-SH								●	●	●											0.031	0.500	0.187	0.203		
	DNMG 433 SH	DNMG150412-SH								●	●	●											0.047	0.500	0.187	0.203		
	DNMG 434 SH	DNMG150416-SH								●	●	●											0.063	0.500	0.187	0.203		
	DNMG 442 SH	DNMG150608-SH								●	●	●											0.031	0.500	0.250	0.203		
	DNMG 443 SH	DNMG150612-SH								●	●	●											0.047	0.500	0.250	0.203		
Finishing to medium cutting		DNMA 431 CH	DNMG150404-CH												●	●	●						0.016	0.500	0.187	0.203		
		DNMA 432 CH	DNMG150408-CH											●	●	●	●						0.031	0.500	0.187	0.203		
		DNMA 433 CH	DNMG150412-CH											●	●	●	●						0.047	0.500	0.187	0.203		
		DNMA 441 CH	DNMG150604-CH													●	●	●						0.016	0.500	0.250	0.203	
		DNMA 442 CH	DNMG150608-CH													●	●	●						0.031	0.500	0.250	0.203	
		DNMA 443 CH	DNMG150612-CH													●	●	●						0.047	0.500	0.250	0.203	

● : Line up
 ▲ : To be discontinued

Reference pages: External toolholder → C040 - Internal toolholder → D060 -
 J-Series toolholder → G059 TungCap → C048, K012 -

Insert NEGATIVE TYPE

● : Continuous cutting
 ● : Light interrupted cutting
 ✱ : Heavy interrupted cutting

DN

Rhombic, 55° with hole

P	Steel	●●	●															
M	Stainless		●															
K	Cast iron	●●	●	●●														
N	Non-ferrous		●															
S	Superalloy																	
H	Hard material																	●

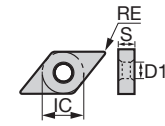

Application	Chipbreaker	Designation		Cermet	Uncoated	Ceramic			Dimension (inch)			
		Inch	Metric	NS520	TH10	FX105	LX21	LX11	RE	IC	S	D1
Finishing to medium cutting	-	DNGA 431	DNGA150404	●	●				0.016	0.500	0.187	0.203
		DNGA 432	DNGA150408	●	●				0.031	0.500	0.187	0.203
		DNGA 433	DNGA150412				●●		0.047	0.500	0.187	0.203
		DNGA 434	DNGA150416				●		0.063	0.500	0.187	0.203
		DNGA 441	DNGA150604					●	0.016	0.500	0.250	0.203
		DNGA 442	DNGA150608					●	0.031	0.500	0.250	0.203
		DNGA 443	DNGA150612					●	0.047	0.500	0.250	0.203
		DNGA 444	DNGA150616					●	0.063	0.500	0.250	0.203
		DNGA 445	DNGA150620					●	0.079	0.500	0.250	0.203

DN

Rhombic, 55° without hole

P	Steel																	
M	Stainless																	
K	Cast iron	●●																
N	Non-ferrous																	
S	Superalloy																	
H	Hard material																	●

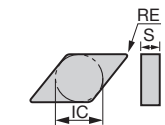

Application	Chipbreaker	Designation		Ceramic			Dimension (inch)					
		Inch	Metric	FX105	LX11							
Finishing to medium cutting	-	DNGD 452	DNGD150708	●					0.031	0.500	0.313	-
		DNGD 453	DNGD150712	●					0.047	0.500	0.313	-
		DNGD 454	DNGD150716	●					0.063	0.500	0.313	-
	-	DNGN 431	DNGN150404		●				0.016	0.500	0.187	-
		DNGN 432	DNGN150408		●				0.031	0.500	0.187	-
		DNGN 433	DNGN150412		●●				0.047	0.500	0.187	-
		DNGN 434	DNGN150416		●				0.063	0.500	0.187	-
		DNGN 452	DNGN150708		●				0.031	0.500	0.313	-
		DNGN 453	DNGN150712		●				0.047	0.500	0.313	-
		DNGN 454	DNGN150716		●				0.063	0.500	0.313	-
	-	DNMX 454	DNMX150716		●				0.063	0.500	0.313	-

● : Line up

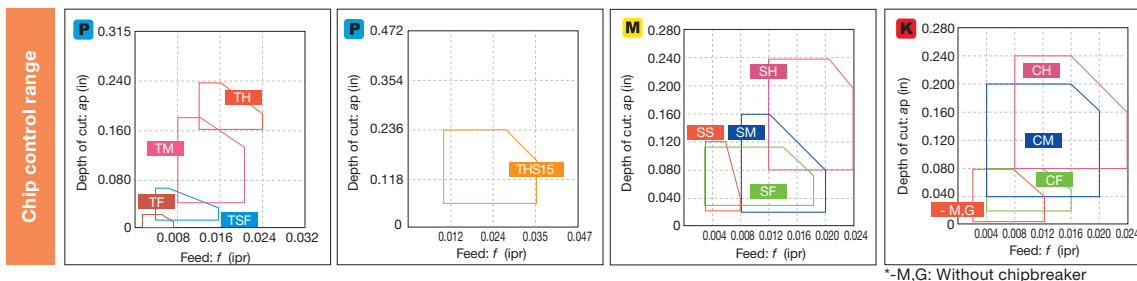

Reference pages: DNGA...: External toolholder → C046 -, Internal toolholder → D060 -, J-Series toolholder → G059,
 TungCap → C048, K012 -
 DNGD...: External toolholder → C0 -

Grade
Insert
Toolholder
Ext. Toolholder
Int. Toolholder
Threading
Grooving
Miniature Tool
Milling Cutter
Endmill
Drilling Tool
Tooling System
User's Guide
Index



Insert NEGATIVE TYPE

● : Continuous cutting
 ● : Light interrupted cutting
 * : Heavy interrupted cutting

RN

Round,
with hole

	P	M	K	N	S	H														
Steel	●	●	●	●	●	●	●	●	●	●	●	●	●	●	●	●	●	●	●	●
Stainless	●	●	●	●	●	●	●	●	●	●	●	●	●	●	●	●	●	●	●	●
Cast iron	●	●	●	●	●	●	●	●	●	●	●	●	●	●	●	●	●	●	●	●
Non-ferrous	●	●	●	●	●	●	●	●	●	●	●	●	●	●	●	●	●	●	●	●
Superalloy	●	●	●	●	●	●	●	●	●	●	●	●	●	●	●	●	●	●	●	●
Hard material	●	●	●	●	●	●	●	●	●	●	●	●	●	●	●	●	●	●	●	●

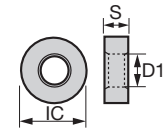

Application	Chipbreaker	Designation		Coated							Uncoated	Ceramic	Dimension (inch)					
		Inch	Metric	T9205	T9215	T9225	T9235	T9105	T9115	T9125	T9135	AH120	TH10	LX11	RE	IC	S	D1
Heavy cutting		61	RNMG 32-61	RNMG090300-61	●	●	●	●	●	●	●	●	●	●	-	0.375	0.125	0.150
			RNMG 43-61	RNMG120400-61	●	●	●	●	▲	▲	▲	▲	●	●	-	0.500	0.187	0.203
			RNMG 54-61	RNMG150600-61	●	●	●	●	▲	▲					-	0.625	0.250	0.253
			RNMG 64-61	RNMG190600-61	●	●	●	●	▲	▲	▲				-	0.750	0.250	0.312
			RNMG 86-61	RNMG250900-61	●	●	●	●	▲	▲					-	1.000	0.375	0.363
Finishing to medium cutting		-	RNGA 43	RNGA120400									●	-	0.500	0.187	0.203	

RN

Round,
without hole

	P	M	K	N	S	H														
Steel	●	●	●	●	●	●	●	●	●	●	●	●	●	●	●	●	●	●	●	●
Stainless	●	●	●	●	●	●	●	●	●	●	●	●	●	●	●	●	●	●	●	●
Cast iron	●	●	●	●	●	●	●	●	●	●	●	●	●	●	●	●	●	●	●	●
Non-ferrous	●	●	●	●	●	●	●	●	●	●	●	●	●	●	●	●	●	●	●	●
Superalloy	●	●	●	●	●	●	●	●	●	●	●	●	●	●	●	●	●	●	●	●
Hard material	●	●	●	●	●	●	●	●	●	●	●	●	●	●	●	●	●	●	●	●

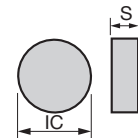

Application	Chipbreaker	Designation		Ceramic					Dimension (inch)								
		Inch	Metric	FX105	LX11	TW43	TS200	TS300	RE	IC	S	D1					
Finishing to medium cutting		-	RNGN 43	RNGN120400	●	●							-	0.500	0.187	-	
			RNGN 45	RNGN120700	●	●	●							-	0.500	0.313	-
			RNGN 45-E	-				●	●					-	0.500	0.187	-
			RNGN 45-T1	-				●	●					-	0.500	0.187	-
			RNGN 43 T6	-				●						-	0.500	0.187	-

● : Line up
 ▲ : To be discontinued

Reference pages: RNMG..., RNGA...:External toolholder → C084 -

Insert NEGATIVE TYPE

- : Continuous cutting
- ◐ : Light interrupted cutting
- ◑ : Heavy interrupted cutting

SN



Square, 90° with hole

Material	Coated	Coated cermet	Cermet	Others
P Steel	●●	●●	●●	●●
M Stainless	●●			
K Cast iron	●●			
N Non-ferrous				
S Superalloy				
H Hard material				

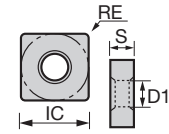

Application	Chipbreaker	Designation		Coated				Coated cermet		Cermet		Dimension (inch)					
		Inch	Metric	T9215	T9225	T9115	T9125	GT9530	AT9530	NS9530	NS520	X407	RE	IC	S	D1	
Precision finishing	TF	SNMG 431 TF	SNMG120404-TF								●		0.016	0.500	0.187	0.203	
		SNMG 432 TF	SNMG120408-TF								●		0.031	0.500	0.187	0.203	
	01	SNGG 320.5-01	SNGG090302-01									●	●	0.008	0.375	0.125	0.150
		SNGG 321-01	SNGG090304-01									●		0.016	0.375	0.125	0.150
		SNGG 322-01	SNGG090308-01									●	●	0.031	0.375	0.125	0.150
		SNGG 430.5-01	SNGG120402-01									●		0.008	0.500	0.187	0.203
		SNGG 431-01	SNGG120404-01									●		0.016	0.500	0.187	0.203
		SNGG 432-01	SNGG120408-01									●	●	0.031	0.500	0.187	0.203
	B ~ D	SNGG 321 R-B	SNGG090304R-B						●			●	●	0.016	0.375	0.125	0.150
		SNGG 321 L-B	SNGG090304L-B						●			●	●	0.016	0.375	0.125	0.150
		SNGG 322 R-B	SNGG090308R-B									●	●	0.031	0.375	0.125	0.150
		SNGG 322 L-B	SNGG090308L-B									●	●	0.031	0.375	0.125	0.150
SNGG 431 R-C		SNGG120404R-C						●			●	●	0.016	0.500	0.187	0.203	
SNGG 431 L-C		SNGG120404L-C						●			●	●	0.016	0.500	0.187	0.203	
SNGG 432 R-C		SNGG120408R-C									●		0.031	0.500	0.187	0.203	
SNGG 432 L-C		SNGG120408L-C									●	●	0.031	0.500	0.187	0.203	
Finishing	TSF	SNMG 431 TSF	SNMG120404-TSF	●	●	▲	▲	●	●		●		0.016	0.500	0.187	0.203	
		SNMG 432 TSF	SNMG120408-TSF	●	●	▲	▲	●	●		●		0.031	0.500	0.187	0.203	
		SNMG 433 TSF	SNMG120412-TSF	●	●	▲	▲						0.047	0.500	0.187	0.203	

- : Line up
- ▲ : To be discontinued

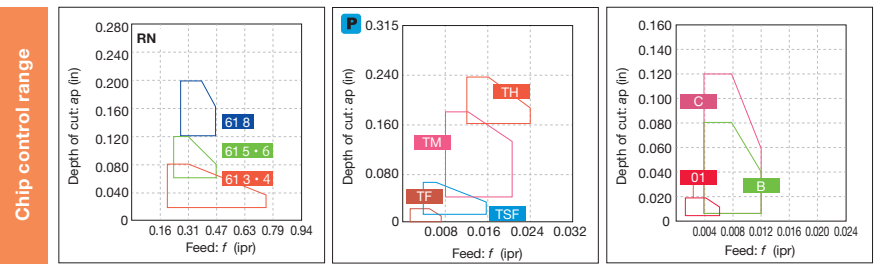

Reference pages: External toolholder → C098 - Internal toolholder → D047 -

Index
 User's Guide
 Tooling System
 Drilling Tool
 Endmill
 Milling Cutter
 Miniature Tool
 Grooving
 Threading
 Int. Toolholder
 Ext. Toolholder
 Insert
 Grade

Insert NEGATIVE TYPE

● : Continuous cutting
 ● : Light interrupted cutting
 ✱ : Heavy interrupted cutting

SN



Square, 90°
with hole

	P	M	K	N	S	H
Steel	● ● ● ● ✱	● ● ● ● ✱	● ● ● ● ✱	● ● ● ● ✱	● ● ● ● ✱	● ● ● ● ✱
Stainless	● ●	● ●	● ●	● ●	● ●	● ●
Cast iron	● ● ● ●	● ● ● ●	● ● ● ●	● ● ● ●	● ● ● ●	● ● ● ●
Non-ferrous	● ● ● ●	● ● ● ●	● ● ● ●	● ● ● ●	● ● ● ●	● ● ● ●
Superalloy	● ● ● ●	● ● ● ●	● ● ● ●	● ● ● ●	● ● ● ●	● ● ● ●
Hard material	● ● ● ●	● ● ● ●	● ● ● ●	● ● ● ●	● ● ● ●	● ● ● ●

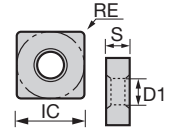

Application	Chipbreaker	Designation		Coated														Coated cermet	Cermet	Un-coated	Dimension (inch)							
		Inch	Metric	T9205	T9215	T9225	T9235	T9105	T9115	T9125	T9135	T6120	T6130	AH630	T5105	T5115	AH8005	AH8015	GT9530	AT9530	NS9530	TH10	RE	IC	S	D1		
Finishing		11	SNMG 431-11	SNMG120404-11																		●	0.016	0.500	0.187	0.203		
			SNMG 432-11	SNMG120408-11																			● ●	0.031	0.500	0.187	0.203	
Finishing (for mild steel)		17	SNMG 432-17	SNMG120408-17																		●	0.031	0.500	0.187	0.203		
Finishing		SF	SNMG 431 SF	SNMG120404-SF								● ● ●											0.016	0.500	0.187	0.203		
			SNMG 432 SF	SNMG120408-SF									● ● ●											0.031	0.500	0.187	0.203	
		CF	SNMG 432 CF	SNMG120408-CF													● ●							0.031	0.500	0.187	0.203	
			SNMG 433 CF	SNMG120412-CF													● ●								0.047	0.500	0.187	0.203
		HRF	SNMG 432 HRF	SNMG120408-HRF														● ●							0.031	0.500	0.187	0.203
			SNMG 433 HRF	SNMG120412-HRF														● ●								0.047	0.500	0.187
Finishing		TS	SNMG 431 TS	SNMG120404-TS	● ●				▲ ▲											● ● ●			0.016	0.500	0.187	0.203		
			SNMG 432 TS	SNMG120408-TS	● ● ● ●				▲ ▲ ▲ ▲												● ● ●			0.031	0.500	0.187	0.203	
			SNMG 433 TS	SNMG120412-TS	● ● ●				▲ ▲ ▲																0.047	0.500	0.187	0.203
High feed, small depth of cut		AS	SNMG 431 AS	SNMG120404-AS																		●	0.016	0.500	0.187	0.203		
			SNMG 432 AS	SNMG120408-AS	● ●				▲ ▲															●	0.031	0.500	0.187	0.203

● : Line up
 ▲ : To be discontinued

SN



Square, 90° with hole

P	Steel	●	●	●	◐	◑	◐	◑	◐	◑	◐	◑	◐	◑	◐	◑	◐	◑	◐	◑	◐	◑	◐	◑
M	Stainless	●	●																					
K	Cast iron	●	●	●	●	●	●																	
N	Non-ferrous																							
S	Superalloy																				●	●		
H	Hard material																							

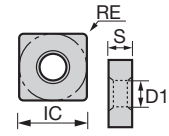

Application	Chipbreaker	Designation	Inch	Metric	Coated													Dimension (inch)						
					T9205	T9215	T9225	T9235	T9105	T9115	T9125	T9135	T6120	T6130	AH630	AH645	AH120	GH330	RE	IC	S	D1		
					●	●	●	●	●	●	●	●	●	●	●	●	●	●	●					
Finishing	NS	SNMG 432 NS	SNMG120408-NS			●	●														0.031	0.500	0.187	0.203
	SS	SNMG 431 SS	SNMG120404-SS							▲	▲										0.016	0.500	0.187	0.203
		SNMG 432 SS	SNMG120408-SS										●	●	●	●					0.031	0.500	0.187	0.203
		SNMG 433 SS	SNMG120412-SS										●	●	●	●					0.047	0.500	0.187	0.203
Medium cutting	TM	SNMG 321 TM	SNMG090304-TM			●	●	●		▲	▲	▲									0.016	0.375	0.125	0.150
		SNMG 322 TM	SNMG090308-TM			●	●	●		▲	▲	▲									0.031	0.375	0.125	0.150
		SNMG 431 TM	SNMG120404-TM			●	●			▲	▲							●			0.016	0.500	0.187	0.203
		SNMG 432 TM	SNMG120408-TM			●	●	●		▲	▲	▲						●			0.031	0.500	0.187	0.203
		SNMG 433 TM	SNMG120412-TM			●	●	●		▲	▲	▲						●			0.047	0.500	0.187	0.203
		SNMG 434 TM	SNMG120416-TM			●	●	●		▲	▲	▲						●			0.063	0.500	0.187	0.203
		SNMG 542 TM	SNMG150608-TM			●				▲								●			0.031	0.625	0.250	0.250
		SNMG 543 TM	SNMG150612-TM			●				▲								●			0.047	0.625	0.250	0.250
		SNMG 642 TM	SNMG190608-TM			●				▲								●			0.031	0.750	0.250	0.312
		SNMG 643 TM	SNMG190612-TM			●				▲								●			0.047	0.750	0.250	0.312
Medium cutting	TA	SNMG 432 TA	SNMG120408-TA			●	●														0.031	0.500	0.187	0.203
		SNMG 433 TA	SNMG120412-TA			●	●														0.047	0.500	0.187	0.203
Finishing to medium cutting	ZM	SNMG 432 ZM	SNMG120408-ZM			●	●	●		▲	▲	▲									0.031	0.500	0.187	0.203
		SNMG 433 ZM	SNMG120412-ZM			●	●	●		▲	▲	▲									0.047	0.500	0.187	0.203

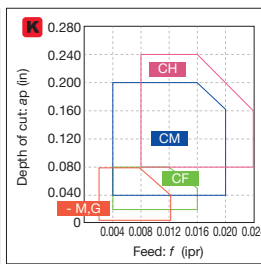
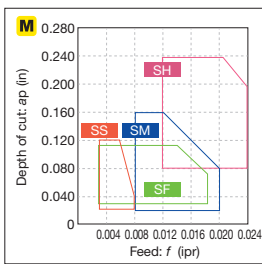
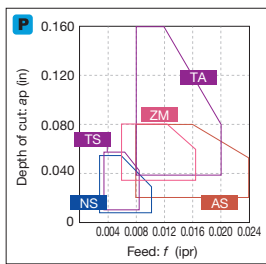
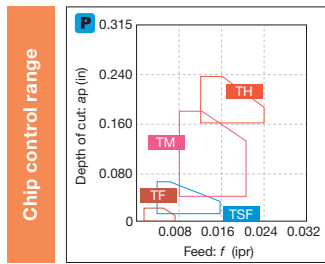

- : Line up
- ▲ : To be discontinued

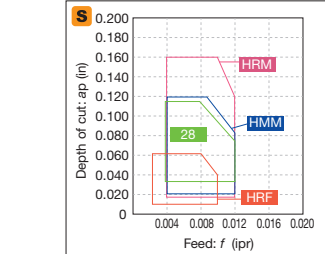

Reference pages: External toolholder → C098 - Internal toolholder → D047 -

Insert NEGATIVE TYPE

- : Continuous cutting
- ◐ : Light interrupted cutting
- ◑ : Heavy interrupted cutting

SN



Square, 90° with hole

	P	M	K	N	S	H												
Steel	●	●	●	●	●	●	●	●	●	●	●	●	●	●	●	●	●	●
Stainless	◐	◐	◐	◐	◐	◐	◐	◐	◐	◐	◐	◐	◐	◐	◐	◐	◐	◐
Cast iron	◑	◑	◑	◑	◑	◑	◑	◑	◑	◑	◑	◑	◑	◑	◑	◑	◑	◑
Non-ferrous	◐	◐	◐	◐	◐	◐	◐	◐	◐	◐	◐	◐	◐	◐	◐	◐	◐	◐
Superalloy	◐	◐	◐	◐	◐	◐	◐	◐	◐	◐	◐	◐	◐	◐	◐	◐	◐	◐
Hard material	◐	◐	◐	◐	◐	◐	◐	◐	◐	◐	◐	◐	◐	◐	◐	◐	◐	◐

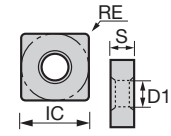

Application	Designation		Coated										Un-coated		Dimension (inch)														
			Inch		Metric		T6120	T6130	AH630	AH645	AH120	T515	T5105	T5115	T5125	AH8005	AH8015	GH110	AH905	GH330	AH725	TH10	KS20	RE	IC	S	D1		
Chipbreaker	SM	SNMG 432 SM	SNMG120408-SM	●	●	●	●																			0.031	0.500	0.187	0.203
		SNMG 433 SM	SNMG120412-SM	●	●	●	●																			0.047	0.500	0.187	0.203
		SNMG 866 SM	SNMG250924-SM	●																						0.094	1.000	0.375	0.359
	CM	SNMG 432 CM	SNMG120408-CM								●	●	●	●												0.031	0.500	0.187	0.203
		SNMG 433 CM	SNMG120412-CM								●	●	●	●												0.047	0.500	0.187	0.203
	Medium cutting	P	SNGG 321 R-P	SNGG090304R-P													●						●			0.016	0.375	0.125	0.150
SNGG 321 L-P			SNGG090304L-P													●							●			0.016	0.375	0.125	0.150
SNGG 322 R-P			SNGG090308R-P														●		●				●			0.031	0.375	0.125	0.150
SNGG 322 L-P			SNGG090308L-P														●						●			0.031	0.375	0.125	0.150
SNGG 431 R-P			SNGG120404R-P														●						●			0.016	0.500	0.187	0.203
SNGG 431 L-P			SNGG120404L-P														●						●			0.016	0.500	0.187	0.203
SNGG 432 R-P			SNGG120408R-P														●						●			0.031	0.500	0.187	0.203
SNGG 432 L-P			SNGG120408L-P														●						●			0.031	0.500	0.187	0.203
																	●						●			0.031	0.500	0.187	0.203

● : Line up

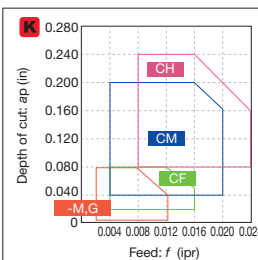
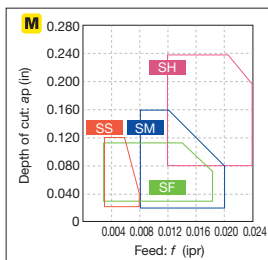
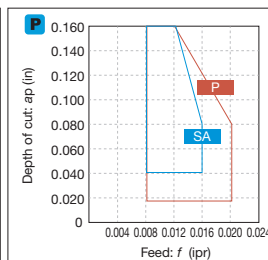
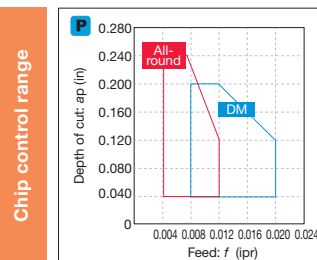

*-M,G: Without chipbreaker

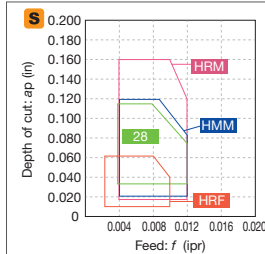

Grade
Insert
Ext. Toolholder
Int. Toolholder
Threading
Grooving
Milling Cutter
Miniature Tool
Endmill
Drilling Tool
Tooling System
User's Guide
Index



Negative

Positive

PCD / CBN

C

D

G

R

S

T

V

W

Y

OTHERS

Insert NEGATIVE TYPE

SN

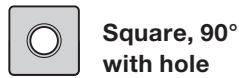

Material	Steel	Stainless	Cast iron	Non-ferrous	Superalloy	Hard material
P	●●●●●	●●●●●	●●●●●	●●●●●	●●●●●	●●●●●
M	●●	●●	●●	●●	●●	●●
K	●●●●●	●●●●●	●●●●●	●●●●●	●●●●●	●●●●●
N	●●	●●	●●	●●	●●	●●
S					●●	●●
H						●●

● : Continuous cutting
 ● : Light interrupted cutting
 ✳ : Heavy interrupted cutting

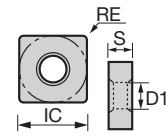

Application	Chipbreaker	Designation	Coated																		Cermet	Un-coated	Dimension (inch)									
			T9205						T9215						T9225								T9235						RE	IC	S	D1
			T9105	T9115	T9125	T9135	T6120	T6130	AH8005	AH8015	AH630	AH645	AH120	GH330	AH905	NS9530	KS20															
Finishing to medium cutting		HRM	SNMG 432 HRM	SNMG120408-HRM																												
			SNMG 433 HRM	SNMG120412-HRM										●	●																	
			SNMG 542 HRM	SNMG150608-HRM																												
			SNMG 543 HRM	SNMG150612-HRM																												
			SNMG 643 HRM	SNMG190612-HRM																												
			SNMG 644 HRM	SNMG190616-HRM																												
Medium cutting		HMM	SNMG 432 HMM	SNMG120408-HMM																												
			SNMG 433 HMM	SNMG120412-HMM																												
Medium cutting		SA	SNMG 431 SA	SNMG120404-SA																												
			SNMG 432 SA	SNMG120408-SA					●	●												●										
			SNMG 433 SA	SNMG120412-SA					●	●																						
			SNMG 643 SA	SNMG190612-SA																												
			SNMG 644 SA	SNMG190616-SA																												
						S	SNMG 431 R-S	SNMG120404R-S			●	●												●								
				SNMG 431 L-S	SNMG120404L-S			●	●													●										
				SNMG 432 R-S	SNMG120408R-S			●	●													●										
				SNMG 432 L-S	SNMG120408L-S			●	●													●										
Medium to heavy cutting		TH	SNMG 432 TH	SNMG120408-TH	●	●	●	▲	▲	▲																						
			SNMG 433 TH	SNMG120412-TH	●	●	●	▲	▲	▲																						
		SNMG 543 TH	SNMG150612-TH	●	●	●	▲	▲	▲													●										
		SNMG 544 TH	SNMG150616-TH	●	●	●	▲	▲	▲														●									
		SNMG 643 TH	SNMG190612-TH	●	●	●	▲	▲	▲	▲														●								
		SNMG 644 TH	SNMG190616-TH	●	●	●	▲	▲	▲	▲														●								
		THS	SNMG 432 THS	SNMG120408-THS	●	●	●	▲	▲	▲																						
			SNMG 433 THS	SNMG120412-THS	●	●	●	▲	▲	▲																						
			SNMG 543 THS	SNMG150612-THS	●	●		▲	▲																							
			SNMG 544 THS	SNMG150616-THS	●	●		▲	▲																							
			SNMG 642 THS	SNMG190608-THS	●	●	●	▲	▲	▲																						
			SNMG 643 THS	SNMG190612-THS	●	●	●	▲	▲	▲																						
SNMG 644 THS	SNMG190616-THS		●	●	●	▲	▲	▲																								
SNMG 646 THS	SNMG190624-THS		●	●	●	▲	▲	▲																								
SNMG 854 THS	SNMG250716-THS	●	●	●	▲	▲	▲																									
SNMG 856 THS	SNMG250724-THS	●	●	●	▲	▲	▲																									

● : Line up
 ▲ : To be discontinued

SN



Square, 90° with hole

P	Steel	●	●	●	●	●	●	●	●	●	●	●	●	●	●	●	●	●	●	●	●	●	●	●	●	●	●	●	●	●	●	●	●	●
M	Stainless	●	●																															
K	Cast iron	●	●																															
N	Non-ferrous																																	
S	Superalloy																																	
H	Hard material																																	

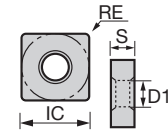

Application	Chipbreaker	Designation		Coated											Dimension (inch)																						
				T9215	T9225	T9235	T9115	T9125	T9135																												
		Inch	Metric																																		
		TR5	TR6	TR7	TR8	TR9	TR10	TR11	TR12	TR13	TR14	TR15	TR16	TR17	TR18	TR19	TR20	TR21	TR22	TR23	TR24	TR25	TR26	TR27	TR28	TR29	TR30	TR31	TR32	TR33	TR34	TR35	RE	IC	S	D1	
Medium to heavy cutting (single side)		TR5	SNMM 543 TR5	SNMM150612-TR5	●	●	●	▲	▲	▲																							0.047	0.625	0.250	0.250	
			SNMM 544 TR5	SNMM150616-TR5	●	●	●	▲	▲	▲																								0.063	0.625	0.250	0.250
			SNMM 644 TR5	SNMM190616-TR5	●	●	●	▲	▲	▲																								0.063	0.750	0.250	0.312
			SNMM 646 TR5	SNMM190624-TR5	●	●	●	▲	▲	▲																								0.094	0.750	0.250	0.312
			SNMM 866 TR5	SNMM250924-TR5	●	●	●	▲	▲	▲																								0.094	1.000	0.375	0.359
Heavy cutting (single side)		TU6	SNMM 644 TU6	SNMM190616-TU6			●			▲																						0.063	0.750	0.250	0.312		
			SNMM 646 TU6	SNMM190624-TU6			●			▲	▲																						0.094	0.750	0.250	0.312	
			SNMM 856 TU6	SNMM250724-TU6			●			▲	▲																						0.094	1.000	0.313	0.359	
			SNMM 866 TU6	SNMM250924-TU6	●	●				▲	▲																						0.094	1.000	0.375	0.359	
Heavy cutting (single side)		TUS6	SNMM 643 TUS6	SNMM190612-TUS6	●	●	●	▲	▲	▲																							0.047	0.750	0.250	0.312	
			SNMM 644 TUS6	SNMM190616-TUS6	●	●	●	▲	▲	▲																								0.063	0.750	0.250	0.312
			SNMM 646 TUS6	SNMM190624-TUS6	●	●	●	▲	▲	▲																								0.094	0.750	0.250	0.312
			SNMM 856 TUS6	SNMM250724-TUS6	●	●	●	▲	▲	▲																								0.094	1.000	0.313	0.359
			SNMM 858 TUS6	SNMM250732-TUS6	●	●				▲	▲																							0.126	1.000	0.313	0.359
			SNMM 866 TUS6	SNMM250924-TUS6	●	●	●			▲	▲	▲																						0.094	1.000	0.375	0.359
		SNMM 868 TUS6	SNMM250932-TUS6	●	●				▲	▲																							0.126	1.000	0.375	0.359	
		57	SNMM 432-57	SNMM120408-57	●	●				▲	▲																						0.031	0.500	0.188	0.203	
			SNMM 544-57	SNMM150616-57						▲																							0.063	0.625	0.250	0.250	
			SNMM 643-57	SNMM190612-57						▲																							0.047	0.750	0.250	0.312	
Medium to heavy cutting (single side)		65	SNMM 643-65	SNMM190612-65						●																						0.047	0.750	0.250	0.312		
			SNMM 1066-65	SNMM310924-65							●																						0.094	1.250	0.375	0.346	

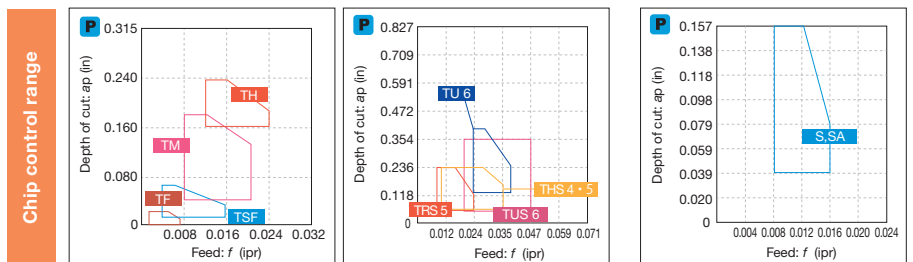

● : Line up
▲ : To be discontinued

Reference pages: External toolholder → [C098](#) - Internal toolholder → [D047](#) -

Insert NEGATIVE TYPE

● : Continuous cutting
 ● : Light interrupted cutting
 ✱ : Heavy interrupted cutting

SN



Square, 90° with hole

P	Steel	✱	●	✱						●	●	●					
M	Stainless	●	●	✱						●	●	●					
K	Cast iron				●	●	●	✱	●	●	●	●	●	●	●	●	●
N	Non-ferrous																
S	Superalloy																
H	Hard material																●

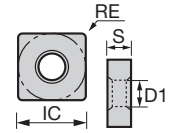

Application	Chipbreaker	Designation		Coated							Coated cermet	Cermet	Un-coated	Ceramic		Dimension (inch)				
		Inch	Metric	T6130	AH630	AH645	T515	T5105	T5115	T5125	GT720	NS520	TH10	FX105	LX21	LX11	RE	IC	S	D1
Medium to heavy cutting		SH	SNMG 432 SH	SNMG120408-SH	●	●	●									0.031	0.500	0.187	0.203	
			SNMG 433 SH	SNMG120412-SH	●	●	●										0.047	0.500	0.187	0.203
			SNMG 543 SH	SNMG150612-SH	●	●	●										0.047	0.625	0.250	0.250
			SNMG 544 SH	SNMG150616-SH	●	●	●										0.063	0.625	0.250	0.250
			SNMG 643 SH	SNMG190612-SH	●	●	●										0.047	0.750	0.250	0.312
			SNMG 644 SH	SNMG190616-SH	●	●	●										0.063	0.750	0.250	0.312
		CH	SNMG 432 CH	SNMG120408-CH				●	●	●						0.031	0.500	0.187	0.203	
			SNMG 433 CH	SNMG120412-CH				●	●	●						0.047	0.500	0.187	0.203	
			SNMG 434 CH	SNMG120416-CH				●	●	●						0.063	0.500	0.187	0.203	
	Finishing to medium cutting		-	SNMA 322	SNMA090308					●			●				0.031	0.375	0.125	0.150
			SNMA 323	SNMA090312													0.047	0.375	0.125	0.150
			SNMA 431	SNMA120404							●						0.016	0.500	0.187	0.203
			SNMA 432	SNMA120408				●	●	●		●	●	●			0.031	0.500	0.187	0.203
			SNMA 433	SNMA120412				●	●	●		●	●	●			0.047	0.500	0.187	0.203
			SNMA 434	SNMA120416				●	●	●							0.063	0.500	0.187	0.203
			SNMA 543	SNMA150612				●	●	●							0.047	0.625	0.250	0.250
			SNMA 643	SNMA190612				●	●	●							0.047	0.750	0.250	0.312
		-	SNGA 321	SNGA090304									●				0.016	0.375	0.125	0.150
			SNGA 431	SNGA120404							●		●		●		0.016	0.500	0.187	0.203
			SNGA 432	SNGA120408								●	●	●	●		0.031	0.500	0.187	0.203
			SNGA 433	SNGA120412									●	●	●		0.047	0.500	0.187	0.203
			SNGA 434	SNGA120416										●	●		0.063	0.500	0.187	0.203

● : Line up

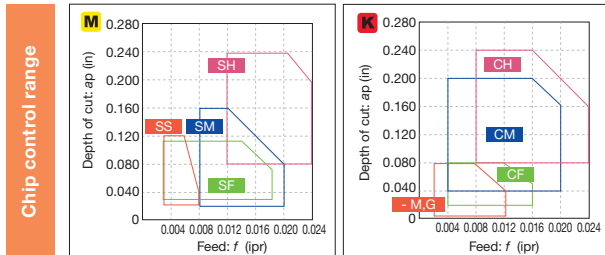

Reference pages: External toolholder → **C098** - Internal toolholder → **D047** -

Insert NEGATIVE TYPE

- : Continuous cutting
- ◐ : Light interrupted cutting
- ◑ : Heavy interrupted cutting

SN

Square, 90° without hole

Material	Coated	Uncoated	Ceramic
P Steel	●●	●	
M Stainless	●●	●	
K Cast iron	●●	●	●●●
N Non-ferrous	●●	●	
S Superalloy	●●		
H Hard material			●

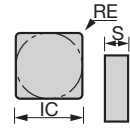

Application	Chipbreaker	Designation	Coated		Uncoated		Ceramic			Dimension (inch)					
			AH120		TH10		FX105	LX21	LX11	TZ120	RE	IC	S	D1	
		Inch	Metric												
Finishing to medium cutting	-	SNGD 453	SNGD120712						●			0.047	0.500	0.313	-
		SNGD 454	SNGD120716						●			0.063	0.500	0.313	-
		SNGN 322	SNGN090308							●	●	0.031	0.375	0.125	-
		SNGN 421	SNGN120304								●	0.016	0.500	0.125	-
		SNGN 423	SNGN120312								●	0.047	0.500	0.125	-
		SNGN 431	SNGN120404								●	0.016		0.187	-
		SNGN 432	SNGN120408			●			●	●	●	0.031	0.375	0.187	-
		SNGN 433	SNGN120412						●	●	●	0.047	0.500	0.187	-
		SNGN 434	SNGN120416						●	●	●	0.063	0.500	0.187	-
		SNGN 435	SNGN120420						●	●		0.079	0.500	0.187	-
		SNGN 436	SNGN120424						●			0.094	0.500	0.187	-
		SNGN 452	SNGN120708								●	0.031	0.500	0.313	-
		SNGN 453	SNGN120712						●	●	●	0.047	0.500	0.313	-
		SNGN 454	SNGN120716						●	●	●	0.063	0.500	0.313	-
		SNGN 455	SNGN120720							●		0.079	0.500	0.313	-
		-	SNMN 432	SNMN120408			●					0.031	0.500	0.187	-
			SNMN 433	SNMN120412	●							0.047	0.500	0.187	-
			*SNMN 434	SNMN120416						●		0.063	0.500	0.187	-
	-	SNGX 454	SNGX120716						●		0.063	0.500	0.313	-	

* Chamfer hone 0.008" wide, -25° angle.
Note: Carbide grades have a radius hone.

● : Line up

Reference pages: External toolholder → C098 -
SNGD...: External toolholder → C114 SNMN...: External toolholder → C101 -



Insert NEGATIVE TYPE

● : Continuous cutting
 ● : Light interrupted cutting
 ✱ : Heavy interrupted cutting

TN



Triangular, 60° with hole

	P	M	K	N	S	H
Steel	●●●●	●●●●	●●●●	●●●●	●●●●	●●●●
Stainless	●●●●	●●●●	●●●●	●●●●	●●●●	●●●●
Cast iron	●●●●	●●●●	●●●●	●●●●	●●●●	●●●●
Non-ferrous	●●●●	●●●●	●●●●	●●●●	●●●●	●●●●
Superalloy	●●●●	●●●●	●●●●	●●●●	●●●●	●●●●
Hard material	●●●●	●●●●	●●●●	●●●●	●●●●	●●●●

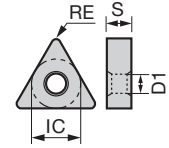

Application	Chipbreaker	Designation		Coated			Coated cermet		Cermet		Uncoated	Dimension (inch)					
		Inch	Metric	GH110	GH330	SH725	GT9530	GT720	NS9530	NS520	X407	TH10	RE	IC	S	D1	
Precision finishing		TF	TNMG 331 TF	TNMG160404-TF							●	0.016	0.375	0.187	0.150		
			TNMG 332 TF	TNMG160408-TF								0.031	0.375	0.187	0.150		
Precision finishing		01	TNGG 220.5-01	TNGG110302-01								0.008	0.250	0.125	0.089		
			TNGG 221-01	TNGG110304-01								0.016	0.250	0.125	0.089		
			TNGG 222-01	TNGG110308-01									0.031	0.250	0.125	0.089	
			TNGG 330.5-01	TNGG160402-01	●							●	0.008	0.375	0.187	0.150	
			TNGG 331-01	TNGG160404-01	●							●	0.016	0.375	0.187	0.150	
			TNGG 332-01	TNGG160408-01	●							●	0.031	0.375	0.187	0.150	
			TNGG 333-01	TNGG160412-01				●				●	0.047	0.375	0.187	0.150	
Precision finishing (sharp edge)		01	TNGG 330.5 F-01	TNGG160402F-01			●					0.008	0.375	0.187	0.150		
			TNGG 331 F-01	TNGG160404F-01			●					0.016	0.375	0.187	0.150		
			TNGG 332 F-01	TNGG160408F-01			●					0.031	0.375	0.187	0.150		
Precision finishing		A, C	TNGG 221 R-A	TNGG110304R-A				●		●		0.016	0.250	0.125	0.089		
			TNGG 221 L-A	TNGG110304L-A				●		●		0.016	0.250	0.125	0.089		
			TNGG 222 R-A	TNGG110308R-A				●		●		0.031	0.250	0.125	0.089		
			TNGG 222 L-A	TNGG110308L-A				●		●		0.031	0.250	0.125	0.089		
			TNGG 321 R-C	TNGG160304R-C						●	●		0.016	0.375	0.125	0.150	
			TNGG 321 L-C	TNGG160304L-C						●	●		0.016	0.375	0.125	0.150	
			TNGG 322 R-C	TNGG160308R-C						●	●		0.031	0.375	0.125	0.150	
			TNGG 322 L-C	TNGG160308L-C						●	●		0.031	0.375	0.125	0.150	
			TNGG 33V R-C	TNGG160400R-C						●	●		0.001	0.375	0.187	0.150	
			TNGG 33V L-C	TNGG160400L-C						●	●		0.001	0.375	0.187	0.150	
			TNGG 330.5 R-C	TNGG160402R-C					●		●	●	0.008	0.375	0.187	0.150	
			TNGG 330.5 L-C	TNGG160402L-C					●		●	●	0.008	0.375	0.187	0.150	
			TNGG 331 R-C	TNGG160404R-C	●	●			●		●	●	●	0.016	0.375	0.187	0.150
			TNGG 331 L-C	TNGG160404L-C	●	●			●		●	●	0.016	0.375	0.187	0.150	
			TNGG 332 R-C	TNGG160408R-C	●	●			●		●	●	0.031	0.375	0.187	0.150	
	TNGG 332 L-C	TNGG160408L-C	●	●			●		●	●	0.031	0.375	0.187	0.150			
D			TNGG 431 R-D	TNGG220404R-D					●	●		0.016	0.500	0.187	0.203		
			TNGG 431 L-D	TNGG220404L-D						●	●		0.016	0.500	0.187	0.203	
			TNGG 432 R-D	TNGG220408R-D						●	●		0.031	0.500	0.187	0.203	
			TNGG 432 L-D	TNGG220408L-D						●	●		0.031	0.500	0.187	0.203	

● : Line up

Reference pages: External toolholder → C029 - Internal toolholder → D053 -
 J-Series toolholder → G058 -

Insert NEGATIVE TYPE

- : Continuous cutting
- : Light interrupted cutting
- ✳ : Heavy interrupted cutting

TN



Triangular, 60° with hole

P	Steel	●	●	●	●	✳	●	●	●	✳	●	●	●	●	●	●	●	●	●	●
M	Stainless	●	●											●	●	●				
K	Cast iron	●	●				●	●	●				●	●	●	●				
N	Non-ferrous																		●	
S	Superalloy												●	●						
H	Hard material																			

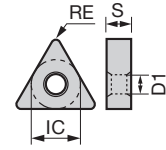

Application	Chipbreaker	Designation		Coated										Coated cermet		Cermet	Un-coated	Dimension (inch)						
		Inch	Metric	T9205	T9215	T9225	T9235	T9105	T9115	T9125	T9135	AH120	SH725	GT9530	AT9530	NS9530	TH10	RE	IC	S	D1			
Precision finishing		W	TNGG 331 R-W	TNGG160404R-W													●	●	0.016	0.375	0.187	0.150		
			TNGG 331 L-W	TNGG160404L-W														●	●	0.016	0.375	0.187	0.150	
			TNGG 332 R-W	TNGG160408R-W															●		0.031	0.375	0.187	0.150
			TNGG 332 L-W	TNGG160408L-W															●		0.031	0.375	0.187	0.150
Precision finishing (sharp edge)		W	TNGG 330.5 FR-W	TNGG160402FR-W															0.008	0.375	0.187	0.150		
			TNGG 330.5 FL-W	TNGG160402FL-W																0.008	0.375	0.187	0.150	
			TNGG 331 FR-W	TNGG160404FR-W																0.016	0.375	0.187	0.150	
			TNGG 331 FL-W	TNGG160404FL-W																0.016	0.375	0.187	0.150	
			TNGG 332 FR-W	TNGG160408FR-W																0.031	0.375	0.187	0.150	
			TNGG 332 FL-W	TNGG160408FL-W																0.031	0.375	0.187	0.150	
Finishing		TSF	TNMG 231E TSF	TNMG110404E-TSF	●	●				▲	▲				●	●	●		0.016	0.250	0.187	0.089		
			TNMG 232E TSF	TNMG110408E-TSF	●	●				▲	▲				●	●	●		0.031	0.250	0.187	0.089		
			TNMG 330.5 TSF	TNMG160402-TSF											●	●	●		0.008	0.375	0.187	0.150		
			TNMG 331 TSF	TNMG160404-TSF							▲	▲	▲	●		●	●	●		0.016	0.375	0.187	0.150	
			TNMG 332 TSF	TNMG160408-TSF	●	●	●	●	▲	▲	▲	▲	●		●	●	●		0.031	0.375	0.187	0.150		
			TNMG 333 TSF	TNMG160412-TSF	●	●				▲	▲	▲			●				0.047	0.375	0.187	0.150		
Finishing (wiper)		FW	TNMG 231E FW	TNMG110404E-FW		●				▲									0.016	0.250	0.187	0.089		
			TNMG 232E FW	TNMG110408E-FW		●				▲									0.031	0.250	0.187	0.089		
			TNMG 331 FW	TNMG160404-FW		●					▲								0.016	0.375	0.187	0.150		
			TNMG 332 FW	TNMG160408-FW		●					▲								0.031	0.375	0.187	0.150		
			*Wiper																					

* Please see L034-L038 about the adjustment of the machining program for rounding or taper machining by using SW/FW. Please contact a Tungaloy sales representative with questions.

- : Line up
- ▲ : To be discontinued

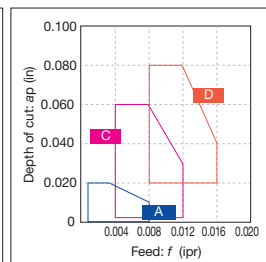
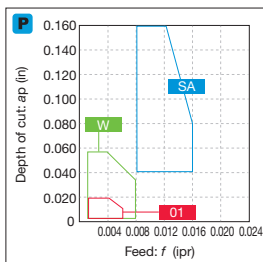
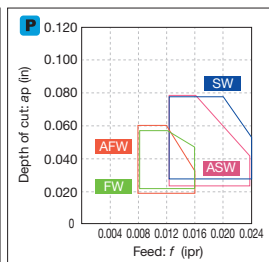
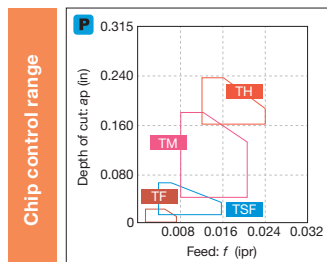

Reference pages: External toolholder → C029 - Internal toolholder → D053 -
 J-Series toolholder → G058 -

Insert NEGATIVE TYPE

- : Continuous cutting
- ◐ : Light interrupted cutting
- ✳ : Heavy interrupted cutting

TN

Triangular, 60°
with hole

P	Steel	●	●	●	✳	●	●	●	●	●	●	●	●	●	●	●	●	●	●	●
M	Stainless	●	●	●	●	●	●	●	●	●	●	●	●	●	●	●	●	●	●	●
K	Cast iron				●	●									●	●	●	●	●	●
N	Non-ferrous																			●
S	Superalloy														●	●				
H	Hard material																			

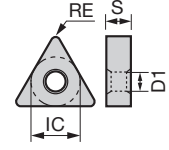

Application	Chipbreaker	Designation		Coated															Coated	Cer-	U-	Dimension (inch)				
		Inch	Metric	T9215	T9225	T9235	T9115	T9125	T9135	T6120	T6130	AH630	T5105	T5115	AH8005	AH8015	GH330	GT9530	AT9530	NS9530	TH10	RE	IC	S	D1	
				●	●	●	▲	▲	▲										●	●	●					
Finishing		TNMG 331 ZF	TNMG160404-ZF	●	●	●	▲	▲	▲									●	●	●		0.016	0.375	0.187	0.150	
		TNMG 332 ZF	TNMG160408-ZF	●	●	●	▲	▲	▲										●	●	●		0.031	0.375	0.187	0.150
		TNMG 333 ZF	TNMG160412-ZF	●				▲															0.047	0.375	0.187	0.150
Finishing		TNMG 221-11	TNMG110304-11																	●		0.016	0.250	0.125	0.089	
		TNMG 222-11	TNMG110308-11																		●		0.031	0.250	0.125	0.089
		TNMG 330.5-11	TNMG160402-11																		●		0.008	0.375	0.187	0.150
		TNMG 331-11	TNMG160404-11																●		●		0.016	0.375	0.187	0.150
		TNMG 332-11	TNMG160408-11																		●		0.031	0.375	0.187	0.150
		TNMG 431-11	TNMG220404-11																		●		0.016	0.500	0.187	0.203
Finishing (for mild steel)		TNMG 331-17	TNMG160404-17	●			▲													●		0.016	0.375	0.187	0.150	
		TNMG 332-17	TNMG160408-17	●			▲														●		0.031	0.375	0.187	0.150
Finishing		TNMG 331 SF	TNMG160404-SF							●	●	●										0.016	0.375	0.187	0.150	
		TNMG 332 SF	TNMG160408-SF							●	●	●											0.031	0.375	0.187	0.150
		TNMG 333 SF	TNMG160412-SF							●	●	●											0.047	0.375	0.187	0.150
Finishing		TNMG 331 CF	TNMG160404-CF										●	●								0.016	0.375	0.187	0.150	
		TNMG 332 CF	TNMG160408-CF										●	●									0.031	0.375	0.187	0.150
Finishing		TNMG 331 HRF	TNMG160404-HRF												●	●						0.016	0.375	0.187	0.150	
		TNMG 332 HRF	TNMG160408-HRF												●	●							0.031	0.375	0.187	0.150

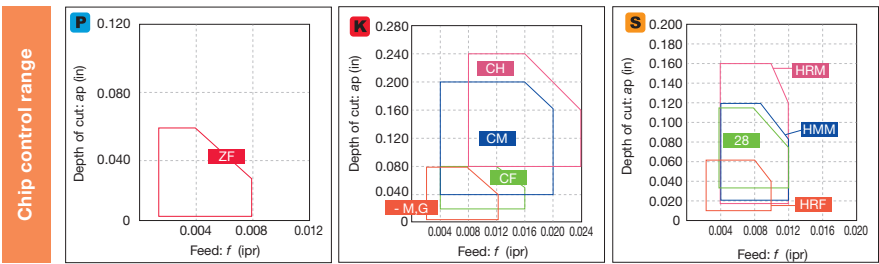

- : Line up
- ▲ : To be discontinued

*-M,G: Without chipbreaker

Insert NEGATIVE TYPE

- : Continuous cutting
- ◐ : Light interrupted cutting
- ✱ : Heavy interrupted cutting

TN

Triangular, 60° with hole

P	Steel	●	●	●	●	✱	●	●	●	✱		●	●	●	●		●	●	●
M	Stainless	●	●									●	●	●	●		●	●	●
K	Cast iron	●	●	●			●	●	●			●	●	●	●		●	●	●
N	Non-ferrous																		
S	Superalloy																		
H	Hard material																		

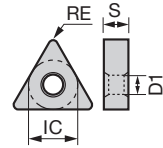

Application	Chipbreaker	Designation		Coated							Coated cermet		Cermet		Dimension (inch)						
		Inch	Metric	T9205	T9215	T9225	T9235	T9105	T9115	T9125	T9135	GT9530	AT9530	NS9530	NS520	RE	IC	S	D1		
Finishing		TS	TNMG 331 TS	TNMG160404-TS	●	●	●		▲	▲	▲	●	●		●	●	0.016	0.375	0.187	0.150	
			TNMG 332 TS	TNMG160408-TS	●	●	●	●	▲	▲	▲	▲	●	●		●	●	0.031	0.375	0.187	0.150
			TNMG 333 TS	TNMG160412-TS	●	●	●	●	▲	▲	▲	▲				●	●	0.047	0.375	0.187	0.150
Finishing to medium cutting (wiper)		SW	TNMG 232E SW	TNMG110408E-SW	●					▲							0.031	0.250	0.187	0.089	
			TNMG 233E SW	TNMG110412E-SW	●					▲								0.047	0.250	0.187	0.089
			TNMG 332 SW	TNMG160408-SW	●					▲								0.031	0.375	0.187	0.150
			TNMG 333 SW	TNMG160412-SW	●					▲								0.047	0.375	0.187	0.150
*Wiper																					
High feed, small depth of cut		AS	TNMG 331 AS	TNMG160404-AS		●	●			▲	▲		●				0.016	0.375	0.187	0.150	
			TNMG 332 AS	TNMG160408-AS	●	●	●	●	▲	▲	▲	▲	●	●				0.031	0.375	0.187	0.150
			TNMG 333 AS	TNMG160412-AS	●	●	●		▲	▲	▲							0.047	0.375	0.187	0.150
Boring (double side)		CB	TNMG 221 CB	TNMG110304-CB	●					▲			●				0.016	0.250	0.125	0.089	
			TNMG 222 CB	TNMG110308-CB	●					▲				●				0.031	0.250	0.125	0.089
Finishing		NS	TNMG 331 NS	TNMG160404-NS	●	●				▲	▲		●				0.016	0.375	0.187	0.150	
			TNMG 332 NS	TNMG160408-NS	●	●	●			▲	▲	▲		●				0.031	0.375	0.187	0.150

* Please see L034-L038 about the adjustment of the machining program for rounding or taper machining by using SW/FW. Please contact a Tungaloy sales representative with questions.

- : Line up
- ▲ : To be discontinued

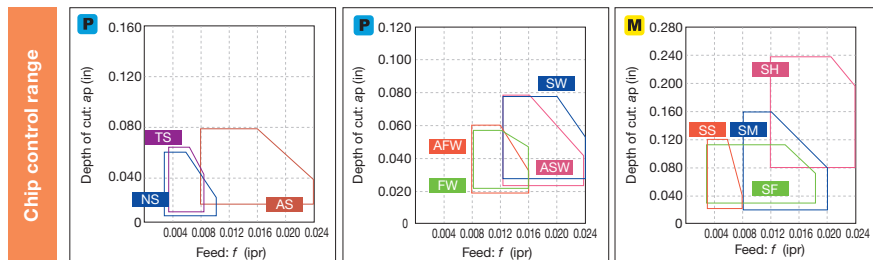

Reference pages: External toolholder → **C029** - Internal toolholder → **D053** -
 J-Series toolholder → **G058** -

Insert **NEGATIVE TYPE**

- : Continuous cutting
- ◐ : Light interrupted cutting
- ◑ : Heavy interrupted cutting

TN

Triangular, 60° with hole

P Steel	●	◐	◑	◑	◑			●	◐	◑	◑	●			●	
M Stainless	●	◐	◑	◑	◑	●	●	●	◐	◑	◑					
K Cast iron	●	◐	◑	◑	◑	●	●	●							●	◐
N Non-ferrous	●	◐	◑	◑	◑										●	◐
S Superalloy	●	◐	◑	◑	◑	●	●	●							●	◐
H Hard material																

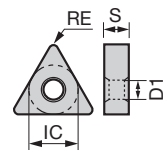

Application	Designation		Coated							Cermet	Uncoated		Dimension (inch)							
	Inch	Metric	T6120	T6130	AH630	AH645	AH120	AH8005	AH8015	AH905	GH110	GH330	SH725	NS9530	TH10	KS20	RE	IC	S	D1
Medium cutting 	P	TNGG 330.5 R-P	TNGG160402R-P							●	●		●			0.008	0.375	0.187	0.150	
		TNGG 330.5 L-P	TNGG160402L-P								●	●		●			0.008	0.375	0.187	0.150
		TNGG 331 R-P	TNGG160404R-P								●	●		●			0.016	0.375	0.187	0.150
		TNGG 331 L-P	TNGG160404L-P								●	●		●			0.016	0.375	0.187	0.150
		TNGG 332 R-P	TNGG160408R-P								●	●		●			0.031	0.375	0.187	0.150
		TNGG 332 L-P	TNGG160408L-P								●	●		●			0.031	0.375	0.187	0.150
Medium cutting (sharp edge) 	P	TNGG 330.5 FR-P	TNGG160402FR-P									●				0.008	0.375	0.187	0.150	
		TNGG 330.5 FL-P	TNGG160402FL-P										●				0.008	0.375	0.187	0.150
		TNGG 331 FR-P	TNGG160404FR-P										●				0.016	0.375	0.187	0.150
		TNGG 331 FL-P	TNGG160404FL-P										●				0.016	0.375	0.187	0.150
		TNGG 332 FR-P	TNGG160408FR-P										●				0.031	0.375	0.187	0.150
		TNGG 332 FL-P	TNGG160408FL-P										●				0.031	0.375	0.187	0.150
Finishing to medium cutting 	HRM	TNMG 331 HRM	TNMG160404-HRM					●	●							0.016	0.375	0.187	0.150	
		TNMG 332 HRM	TNMG160408-HRM						●	●							0.031	0.375	0.187	0.150
		TNMG 333 HRM	TNMG160412-HRM							●	●						0.047	0.375	0.187	0.150
Medium cutting 	HMM	TNMG 331 HMM	TNMG160404-HMM							●						0.016	0.375	0.187	0.150	
		TNMG 332 HMM	TNMG160408-HMM								●						0.031	0.375	0.187	0.150
		TNMG 333 HMM	TNMG160412-HMM									●					0.047	0.375	0.187	0.150
	SA	TNMG 331 SA	TNMG160404-SA	●	●	●	●	●									0.016	0.375	0.187	0.150
		TNMG 332 SA	TNMG160408-SA	●	●	●	●	●							●		0.031	0.375	0.187	0.150
		TNMG 333 SA	TNMG160412-SA	●	●	●	●	●							●		0.047	0.375	0.187	0.150
	TNMG 432 SA	TNMG220408-SA	●	●	●	●	●			●				●		0.031	0.500	0.187	0.203	
	TNMG 433 SA	TNMG220412-SA	●	●	●	●	●									0.047	0.500	0.187	0.203	

● : Line up

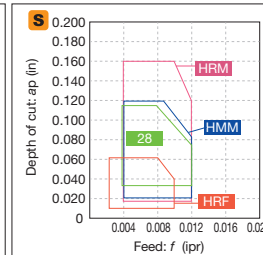
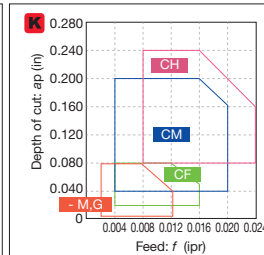
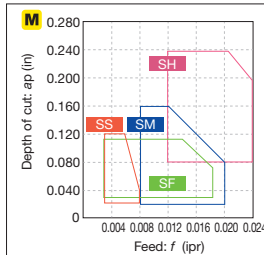
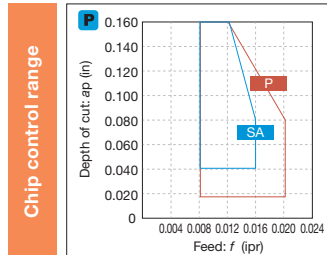

*-M,G: Without chipbreaker

Reference pages: External toolholder → **C029 -** Internal toolholder → **D053 -**
 J-Series toolholder → **G058 -**

Grade: **A**, **B**, **C**, **D**, **E**, **F**, **G**, **H**, **I**, **J**, **K**, **L**, **M**
 Insert: **B**
 Toolholder: **C**, **D**, **E**, **F**, **G**, **H**, **I**, **J**, **K**, **L**, **M**
 System: **K**
 User's Guide: Tooling System, Drilling Tool, Endmill, Milling Cutter, Miniature Tool, Grooving, Threading, Int. Toolholder, Ext. Toolholder

Insert NEGATIVE TYPE

● : Continuous cutting
 ● : Light interrupted cutting
 ✱ : Heavy interrupted cutting

TN

 Triangular, 60° with hole

P	Steel	●	●	●	✱	●	●	●	✱	✱	✱	✱	✱	✱	✱	✱	✱	✱	✱	✱	✱
M	Stainless	●	●																		
K	Cast iron	●	●																		
N	Non-ferrous																				
S	Superalloy																				
H	Hard material																				

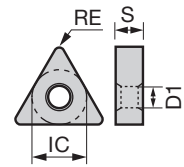

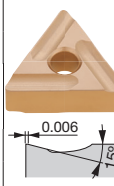
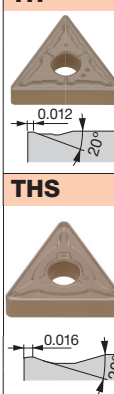
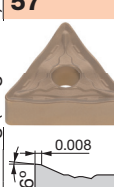
Application	Chipbreaker	Designation		Coated																	Cermet	Dimension (inch)					
		Inch	Metric	T9215	T9225	T9235	T9115	T9125	T9135	T6130	AH630	AH645	T515	T5105	T5115	T5125	AH120	AH725	GH330	NS9530	RE	IC	S	D1			
Medium cutting		S	TNMG 331 R-S	TNMG160404R-S	●	●	●	▲	▲	▲	●	●	●					●	●	●		0.016	0.375	0.187	0.150		
			TNMG 331 L-S	TNMG160404L-S	●	●		▲	▲	▲	●	●	●						●	●	●		0.016	0.375	0.187	0.150	
			TNMG 332 R-S	TNMG160408R-S	●	●		▲	▲	▲	●	●	●						●	●	●		0.031	0.375	0.187	0.150	
			TNMG 332 L-S	TNMG160408L-S	●	●		▲	▲	▲	●	●	●							●	●	●		0.031	0.375	0.187	0.150
			TNMG 431 R-S	TNMG220404R-S	●	●		▲	▲	▲	●	●	●							●	●	●		0.016	0.500	0.187	0.203
			TNMG 431 L-S	TNMG220404L-S	●	●		▲	▲	▲	●	●	●							●	●	●		0.016	0.500	0.187	0.203
			TNMG 432 R-S	TNMG220408R-S	●	●		▲	▲	▲	●	●	●							●	●	●		0.031	0.500	0.187	0.203
			TNMG 432 L-S	TNMG220408L-S	●	●		▲	▲	▲	●	●	●							●	●	●		0.031	0.500	0.187	0.203
Medium to heavy cutting		TH	TNMG 432 TH	TNMG220408-TH	●	●	●	▲	▲	▲								●				0.031	0.500	0.187	0.203		
			TNMG 433 TH	TNMG220412-TH	●	●	●	▲	▲	▲									●				0.047	0.500	0.187	0.203	
		THS	TNMG 432 THS	TNMG220408-THS	●	●	●	▲	▲	▲													0.031	0.500	0.187	0.203	
			TNMG 433 THS	TNMG220412-THS	●	●	●	▲	▲	▲														0.047	0.500	0.187	0.203
		CH	TNMG 331 CH	TNMG160404-CH										●	●	●	●						0.016	0.375	0.187	0.150	
			TNMG 332 CH	TNMG160408-CH										●	●	●	●						0.031	0.375	0.187	0.150	
Medium to heavy cutting (single side)			TNMG 333 CH	TNMG160412-CH								●	●	●	●							0.047	0.375	0.187	0.150		
			TNMG 432 CH	TNMG220408-CH										●	●	●							0.031	0.500	0.187	0.203	
			TNMG 433 CH	TNMG220412-CH										●	●	●							0.047	0.500	0.187	0.203	
			TNMG 434 CH	TNMG220416-CH										●	●	●								0.063	0.500	0.187	0.203
		57	TNMM 332-57	TNMM160408-57	●						▲												0.031	0.375	0.187	0.150	
			TNMM 432-57	TNMM220408-57	●						▲													0.031	0.500	0.187	0.203
			TNMM 433-57	TNMM220412-57	●						▲													0.047	0.500	0.187	0.203

● : Line up
 ▲ : To be discontinued

Reference pages: External toolholder → C029 - Internal toolholder → D053 -
 J-Series toolholder → G058 -

Insert NEGATIVE TYPE

- : Continuous cutting
- ◐ : Light interrupted cutting
- ◑ : Heavy interrupted cutting

TN

Triangular, 60° with hole

P Steel						●	●	●	●										
M Stainless						●	●	●	●										
K Cast iron	●	●	●	●	●	●	●	●	●	●	●	●	●	●	●	●	●	●	●
N Non-ferrous																			
S Superalloy																			
H Hard material																			

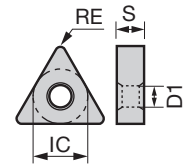

Application	Designation		Coated		Coated cermet	Cermet	Uncoated	Ceramic			Dimension (inch)														
			T515	T5105	T5115	T5125	GH110	GT720	NS520	TH03	TH10	FX105	LX21	LX11	RE	IC	S	D1							
			Inch	Metric																					
Finishing to medium cutting		-	TNMA 231E	TNMA110404E	●														0.016	0.250	0.187	0.089			
			TNMA 232E	TNMA110408E	●															0.031	0.250	0.187	0.089		
			TNMA 233E	TNMA110412E	●															0.047	0.250	0.187	0.089		
			TNMA 331	TNMA160404	●	●	●	●				●								0.016	0.375	0.187	0.150		
			TNMA 332	TNMA160408	●	●	●	●		●	●		●							0.031	0.375	0.187	0.150		
			TNMA 333	TNMA160412	●	●	●	●					●							0.047	0.375	0.187	0.150		
			TNMA 334	TNMA160416		●	●	●												0.063	0.375	0.187	0.150		
			TNMA 335	TNMA160420		●	●	●												0.079	0.375	0.187	0.150		
			TNMA 431	TNMA220404		●	●	●												0.016	0.500	0.187	0.203		
			TNMA 432	TNMA220408		●	●	●												0.031	0.500	0.187	0.203		
			TNMA 433	TNMA220412		●	●	●												0.047	0.500	0.187	0.203		
			TNMA 434	TNMA220416		●	●	●												0.063	0.500	0.187	0.203		
		Finishing to medium cutting		-	TNGA 221	TNGA110304															0.016	0.250	0.125	0.089	
					TNGA 222	TNGA110308																0.031	0.250	0.125	0.089
					TNGA 321	TNGA160304																0.016	0.375	0.125	0.150
	TNGA 322			TNGA160308																0.031	0.375	0.125	0.150		
	TNGA 330.5			TNGA160402																0.008	0.375	0.187	0.150		
	TNGA 331			TNGA160404				●			●		●	●		●	●			0.016	0.375	0.187	0.150		
	TNGA 332			TNGA160408				●			●		●	●		●	●			0.031	0.375	0.187	0.150		
	TNGA 333			TNGA160412							●		●	●		●	●			0.047	0.375	0.187	0.150		
	TNGA 334			TNGA160416									●	●		●	●			0.063	0.375	0.187	0.150		
	TNGA 432			TNGA220408												●				0.031	0.500	0.187	0.203		

● : Line up

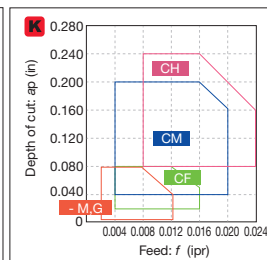
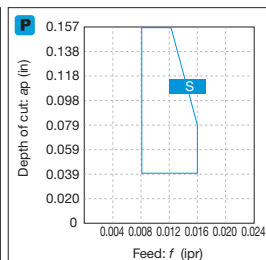
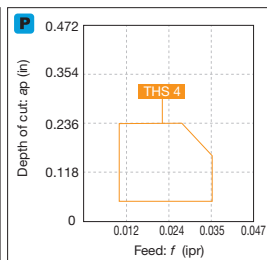
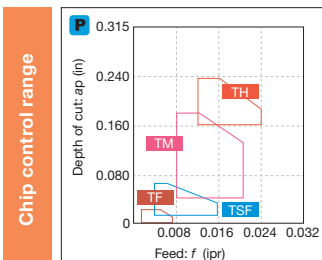

*-M,G: Without chipbreaker

Reference pages: External toolholder → C029 - Internal toolholder → D053 -
J-Series toolholder → G058 -

Grade
Insert
Toolholder
Ext. Toolholder
Int. Toolholder
Threading
Grooving
Milling Cutter
Miniature Tool
Endmill
Drilling Tool
Tooling System
User's Guide
Index



Negative

Positive

PCD / CBN

C

D

G

R

S

T

V

W

Y

OTHERS

Insert NEGATIVE TYPE

● : Continuous cutting
 ●c : Light interrupted cutting
 ●* : Heavy interrupted cutting

TN

 Triangular, 60° without hole

P	Steel	●																		
M	Stainless	●																		
K	Cast iron	●	●c	●c	●c	●c	●c	●c	●c	●c	●c	●c	●c	●c	●c	●c	●c	●c	●c	●c
N	Non-ferrous	●																		
S	Superalloy	●																		
H	Hard material																			●

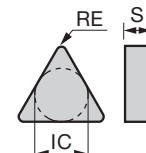

Application	Designation		Coating					Dimension (inch)					
	Inch	Metric	Uncoated	Ceramic				RE	IC	S	D1		
Chipbreaker			TH10	FX105	LX21	LX11	TZ120						
Finishing to medium cutting	-	TNGN 222	TNGN110308	●									
		TNGN 331	TNGN160404			●	●						
		TNGN 332	TNGN160408	●		●	●						
		TNGN 333	TNGN160412	●		●	●	●					
		TNGN 334	TNGN160416			●	●						
		TNGN 335	TNGN160420			●							
		TNGN 352	TNGN160708				●						
		TNGN 353	TNGN160712				●						

● : Line up

VN

 Rhombic, 35° with hole

P	Steel	●			●c				●c	●c		●								
M	Stainless	●										●								
K	Cast iron	●	●c	●c	●c	●c	●c	●c	●c	●c	●c	●								
N	Non-ferrous	●										●								
S	Superalloy	●																		
H	Hard material																			



Application	Designation		Coating				Dimension (inch)				
	Inch	Metric	Coated	Coated cermet		Cermet	Uncoated	RE	IC	S	D1
Chipbreaker			GH110	GT720	NS9530	NS520	TH10				
Precision finishing	TF	VNMG 331 TF	VNMG160404-TF			●					
		VNMG 332 TF	VNMG160408-TF		●	●					
	01	VGG 330.5-01	VGG160402-01	●		●	●	●			
		VGG 331-01	VGG160404-01			●	●	●			
		VGG 332-01	VGG160408-01			●	●				
Finishing to medium cutting	P	VGG 331 R-P	VGG160404R-P					●			
		VGG 332 R-P	VGG160408R-P					●			

● : Line up

Reference pages: TNGN...: External toolholder → C029 -
 VNMG..., VGG...: External toolholder → C062 -, Internal toolholder → D078 -,
 TungCap → K014 -

● : Continuous cutting
 ● : Light interrupted cutting
 ✳ : Heavy interrupted cutting

Insert NEGATIVE TYPE

VN

Rhombic, 35°
with hole



P	Steel	●	●	●	●	✳	●	●	●	✳	●	●	●	●	●	●	●	●	●	●	●	●	●	●	●	●
M	Stainless	●	●	●	●	●	●	●	●	●	●	●	●	●	●	●	●	●	●	●	●	●	●	●	●	●
K	Cast iron	●	●	●	●	●	●	●	●	●	●	●	●	●	●	●	●	●	●	●	●	●	●	●	●	●
N	Non-ferrous	●	●	●	●	●	●	●	●	●	●	●	●	●	●	●	●	●	●	●	●	●	●	●	●	●
S	Superalloy	●	●	●	●	●	●	●	●	●	●	●	●	●	●	●	●	●	●	●	●	●	●	●	●	●
H	Hard material	●	●	●	●	●	●	●	●	●	●	●	●	●	●	●	●	●	●	●	●	●	●	●	●	●

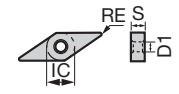

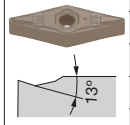
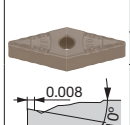
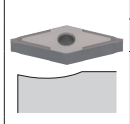
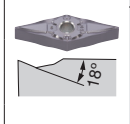
Application	Chipbreaker	Designation		Coated														Coated cermet	Cermet	Un-coated	Dimension (inch)			
				T9205	T9215	T9225	T9235	T9105	T9115	T9125	T9135	T6120	T6130	AH630	AH120	GH330	GT9530	AT9530	NS9530	TH10	RE	IC	S	D1
Finishing	TSF 	VNMG 2.330.5E TSF	VNMG120402E-TSF	●	●															0.008	0.281	0.187	0.150	
		VNMG 2.331E TSF	VNMG120404E-TSF	●	●																0.016	0.281	0.187	0.150
		VNMG 2.332E TSF	VNMG120408E-TSF	●	●																0.031	0.281	0.187	0.150
		VNMG 330.5 TSF	VNMG160402-TSF													●	●	●	●		0.008	0.375	0.187	0.150
		VNMG 331 TSF	VNMG160404-TSF	●	●	●	●	▲	▲	▲	▲					●	●	●	●		0.016	0.375	0.187	0.150
		VNMG 332 TSF	VNMG160408-TSF	●	●	●	●	▲	▲	▲	▲					●	●	●	●		0.031	0.375	0.187	0.150
	VNMG 333 TSF	VNMG160412-TSF	●	●	●	●	▲	▲	▲	▲					●					0.047	0.375	0.187	0.150	
	ZF 	VNMG 331 ZF	VNMG160404-ZF	●	●	●			▲	▲	▲					●	●	●		0.016	0.375	0.187	0.150	
		VNMG 332 ZF	VNMG160408-ZF	●	●	●			▲	▲	▲					●	●	●		0.031	0.375	0.187	0.150	
		VNMG 333 ZF	VNMG160412-ZF	●	●	●			▲	▲	▲					●				0.047	0.375	0.187	0.150	
	11 	VNMG 331-11	VNMG160404-11													●		●	●	0.016	0.375	0.187	0.150	
		VNMG 332-11	VNMG160408-11															●		0.031	0.375	0.187	0.150	
VNMG 333-11		VNMG160412-11															●		0.047	0.375	0.187	0.150		
SF 	VNMG 331 SF	VNMG160404-SF									●	●	●						0.016	0.375	0.187	0.150		
	VNMG 332 SF	VNMG160408-SF									●	●	●						0.031	0.375	0.187	0.150		

● : Line up
 ▲ : To be discontinued

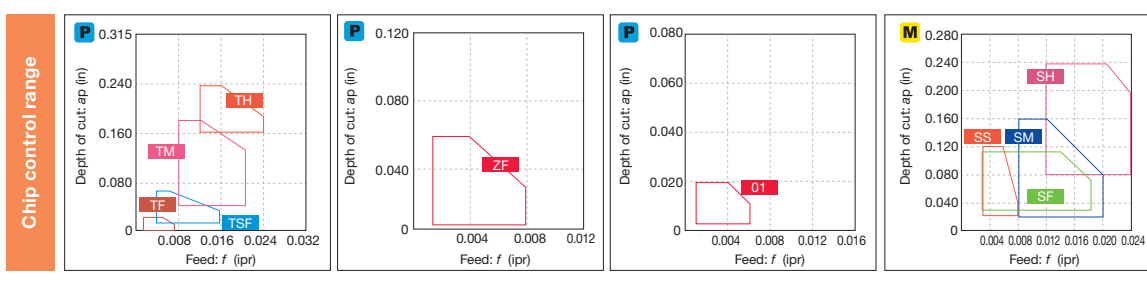

Reference pages: External toolholder → C057 - Internal toolholder → D078 -
 TungCap → C064 -, K015 -

Index
 User's Guide
 Tooling System
 Drilling Tool
 Endmill
 Milling Cutter
 Miniature Tool
 Grooving
 Threading
 Int. Toolholder
 Ext. Toolholder
 Insert
 Grade

A
 B
 C
 D
 E
 F
 G
 H
 I
 J
 K
 L
 M

Negative

Positive

PCD / CBN

C

D

G

R

S

T

V

W

Y

OTHERS

Insert NEGATIVE TYPE

● : Continuous cutting
 ○ : Light interrupted cutting
 ☆ : Heavy interrupted cutting

VN



Rhombic, 35°
with hole

Material	T9205	T9215	T9225	T9235	T9105	T9115	T9125	T9135	T6120	T6130	AH630	AH645	T5105	T5115	AH110	AH120	AH8005	AH8015	GH330	GT9530	AT9530	NS9530	NS520	
P Steel	●	●	●	●	●	●	●	●	●	●	●	●	●	●	●	●	●	●	●	●	●	●	●	●
M Stainless	●	●																						
K Cast iron	●	●			●	●	●						●	●	●	●	●	●	●	●	●	●	●	
N Non-ferrous																								
S Superalloy																●	●	●	●					
H Hard material																								

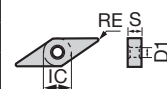

Application	Chipbreaker	Designation		Coated																			Coated cermet	Cermet	Dimension (inch)					
		Inch	Metric	T9205	T9215	T9225	T9235	T9105	T9115	T9125	T9135	T6120	T6130	AH630	AH645	T5105	T5115	AH110	AH120	AH8005	AH8015	GH330	GT9530	AT9530	NS9530	NS520	RE	IC	S	D1
Finishing	CF	VNMG 331 CF	VNMG160404-CF												●	●										0.016	0.375	0.187	0.150	
		VNMG 332 CF	VNMG160408-CF													●	●										0.031	0.375	0.187	0.150
	HRF	VNMG 331 HRF	VNMG160404-HRF																●	●							0.016	0.375	0.187	0.150
		VNMG 332 HRF	VNMG160408-HRF																●	●							0.031	0.375	0.187	0.150
	TS	VNMG 331 TS	VNMG160404-TS		●	●	●		▲	▲	▲											●	●	●	●		0.016	0.375	0.187	0.150
		VNMG 332 TS	VNMG160408-TS		●	●	●															●	●	●	●		0.031	0.375	0.187	0.150
VNMG 333 TS		VNMG160412-TS		●	●	●																				0.047	0.375	0.187	0.150	
Medium cutting	SS	VNMG 2.331E SS	VNMG120404E-SS								●	●	●													0.016	0.281	0.187	0.150	
		VNMG 2.332E SS	VNMG120408E-SS								●	●	●													0.031	0.281	0.187	0.150	
	TM	VNMG 331 TM	VNMG160404-TM		●	●	●	●	▲	▲	▲	▲		●			●	●								0.016	0.375	0.187	0.150	
		VNMG 332 TM	VNMG160408-TM		●	●	●	●	▲	▲	▲	▲		●			●	●								0.031	0.375	0.187	0.150	
		VNMG 333 TM	VNMG160412-TM		●	●	●	●	▲	▲	▲	▲					●									0.047	0.375	0.187	0.150	
	TQ	VNMG 331 TQ	VNMG160404-TQ		●	●																●	●	●		0.016	0.375	0.187	0.150	
VNMG 332 TQ		VNMG160408-TQ		●	●																●	●	●		0.031	0.375	0.187	0.150		
Finishing to medium cutting	ZM	VNMG 332 ZM	VNMG160408-ZM		●	●	●		▲	▲	▲														0.031	0.375	0.187	0.150		
		VNMG 333 ZM	VNMG160412-ZM		●	●	●																		0.047	0.375	0.187	0.150		

● : Line up
 ▲ : To be discontinued

Reference pages: External toolholder → C057 - Internal toolholder → D078 -
 TungCap → C064 -, K015 -

VN

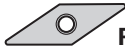

Rhombic, 35° with hole

Material compatibility table for Steel, Stainless, Cast iron, Non-ferrous, Superalloy, and Hard material across various tool grades.

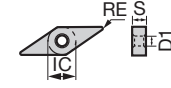

Main table mapping Application (Chipbreaker, Medium cutting), Designation (Inch/Metric), and Coated types to cutting parameters (RE, IC, S, D1) and material compatibility.

● : Line up
▲ : To be discontinued

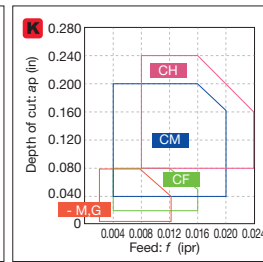
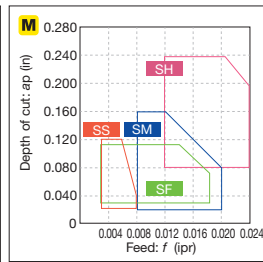
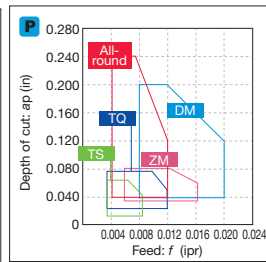
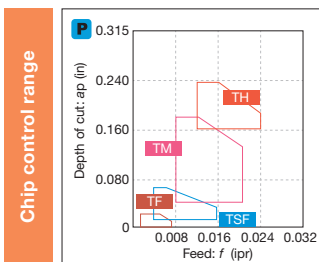

*-M,G: Without chipbreaker

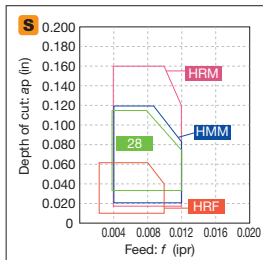

Reference pages: External toolholder -> C062 - Internal toolholder -> D078 - TungCap -> C064 -, K015 -

Insert NEGATIVE TYPE

● : Continuous cutting
 ● : Light interrupted cutting
 ✱ : Heavy interrupted cutting

VN



Rhombic, 35°
with hole

P	Steel	●	✱	●	✱							●	●				
M	Stainless	●	●	●	✱								●	●			
K	Cast iron					●	●	●	✱			●	●				
N	Non-ferrous												●				
S	Superalloy												●	●			
H	Hard material																●

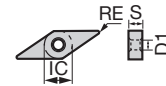

Application	Chipbreaker	Designation		Coated									Cermet	Un-coated	Ceramic	Dimension (inch)						
		Inch	Metric	T6120	T6130	AH630	AH645	T515	T5105	T5115	T5125	AH8005	AH8015	AH905	NS520	TH10	LX11	RE	IC	S	D1	
Medium cutting		SM	VNMG 2.331E SM	VNMG120404E-SM	●	●	●	●										0.016	0.281	0.187	0.150	
			VNMG 2.332E SM	VNMG120408E-SM	●	●	●	●											0.031	0.281	0.187	0.150
			VNMG 331 SM	VNMG160404-SM	●	●	●	●											0.016	0.375	0.187	0.150
			VNMG 332 SM	VNMG160408-SM	●	●	●	●											0.031	0.375	0.187	0.150
			VNMG 333 SM	VNMG160412-SM	●	●	●	●											0.047	0.375	0.187	0.150
Medium cutting		CM	VNMG 332 CM	VNMG160408-CM					●	●	●	●						0.031	0.375	0.187	0.150	
			VNMG 333 CM	VNMG160412-CM						●	●	●						0.047	0.375	0.187	0.150	
Finishing to medium cutting		HRM	VNMG 331 HRM	VNMG160404-HRM														0.016	0.375	0.187	0.150	
			VNMG 332 HRM	VNMG160408-HRM															0.031	0.375	0.187	0.150
			VNMG 333 HRM	VNMG160412-HRM															0.047	0.375	0.187	0.150
Medium cutting		HMM	VNMG 331 HMM	VNMG160404-HMM														0.016	0.375	0.187	0.150	
			VNMG 332 HMM	VNMG160408-HMM															0.031	0.375	0.187	0.150
			VNMG 333 HMM	VNMG160412-HMM															0.047	0.375	0.187	0.150
Finishing to medium cutting		-	VNMA 2.331E	VNMA120404E					●									0.016	0.281	0.187	0.150	
			VNMA 2.332E	VNMA120408E					●										0.031	0.281	0.187	0.150
			VNMA 330.5	VNMA160402												●			0.008	0.375	0.187	0.150
			VNMA 331	VNMA160404						●	●	●			●	●			0.016	0.375	0.187	0.150
			VNMA 332	VNMA160408						●	●	●			●	●			0.031	0.375	0.187	0.150
			VNGA 331	VNGA160404													●		0.016	0.375	0.187	0.150
			VNGA 332	VNGA160408													●		0.031	0.375	0.187	0.150

* Please see L034-L038 about the adjustment of the machining program for rounding or taper machining by using SW/FW.
 Please contact a Tungaloy sales representative with questions.

● : Line up

Reference pages: External toolholder → C057 - Internal toolholder → D078 -
 TungCap → C064 -, K015 -

Insert NEGATIVE TYPE

- : Continuous cutting
- ◐ : Light interrupted cutting
- ◑ : Heavy interrupted cutting

VN

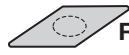

Rhombic, 35° without hole

P Steel	●●											
M Stainless	●●											
K Cast iron	●●											
N Non-ferrous	●●											
S Superalloy	●●											
H Hard material												

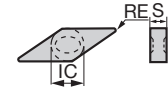

Application	Chipbreaker		Designation		Ceramic				Dimension (inch)			
	Inch	Metric	FX105						RE	IC	S	D1
Finishing to medium cutting	●	VNGD 353	VNGD160712	●								

WN



Trigon, 80° with hole

P Steel	●●			●●●●								
M Stainless	●●			●●●●								
K Cast iron	●●			●●●●								
N Non-ferrous	●●			●●●●								
S Superalloy	●●			●●●●								
H Hard material												

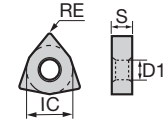

Application	Chipbreaker		Designation		Coated cermet		Cermet		Dimension (inch)			
	Inch	Metric	GT720		NS9530	NS520			RE	IC	S	D1
Precision finishing	●	WNMG 431 TF	WNMG080404-TF		●				0.016	0.500	0.187	0.203
		WNMG 432 TF	WNMG080408-TF		●				0.031	0.500	0.187	0.203
Precision finishing	●	WNGG 430.5-01	WNGG080402-01		●●				0.008	0.500	0.187	0.203
		WNGG 431-01	WNGG080404-01	●	●●				0.016	0.500	0.187	0.203
		WNGG 432-01	WNGG080408-01	●	●				0.031	0.500	0.187	0.203

● : Line up

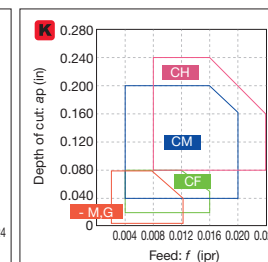
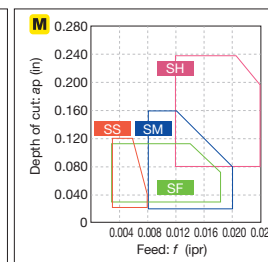
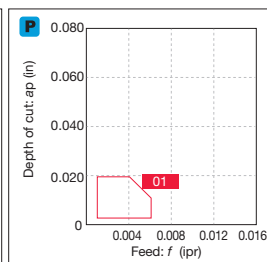
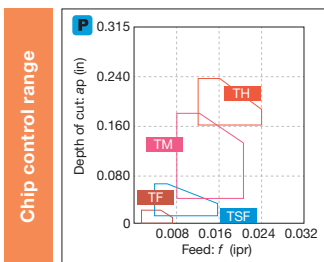

*-M,G: Without chipbreaker

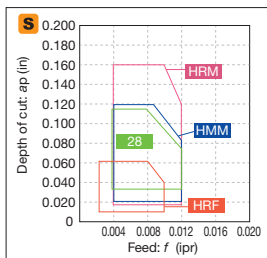

Reference pages: VNGD...: External toolholder → C074

WNMG..., WNGG...:

External toolholder → C037 -, Internal toolholder → D035 -,

TungCap → C038 -, K011 -

Grade
Insert
Ext. Toolholder
Int. Toolholder
Threading
Grooving
Miniature Tool
Endmill
Drilling Tool
Tooling System
User's Guide
Index

A
B
C
D
E
F
G
H
I
J
K
L
M

Insert NEGATIVE TYPE

● : Continuous cutting
 ◐ : Light interrupted cutting
 * : Heavy interrupted cutting

WN



Trigon, 80°
with hole

	P Steel	M Stainless	K Cast iron	N Non-ferrous	S Superalloy	H Hard material																	
●	●	●	●	●	●	●																	
◐																							
*																							

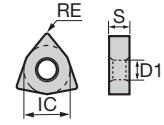

Application	Chipbreaker	Designation		Coated														Coated cermet	Cermet	Dimension (inch)													
				T9205	T9215	T9225	T9235	T9105	T9115	T9125	T9135	T5115	T515	AH120	AH8015	GT9530	AT9530	NS9530	RE	IC	S	D1											
		Inch	Metric																														
Finishing		TSF	WNUMG 330.5E TSF	WNUMG060402E-TSF																									0.008	0.375	0.187	0.150	
			WNUMG 331E TSF	WNUMG060404E-TSF		●	●		▲	▲				●	●		●	●		●										0.016	0.375	0.187	0.150
			WNUMG 332E TSF	WNUMG060408E-TSF	●	●			▲	▲				●	●		●	●		●										0.031	0.375	0.187	0.150
			WNUMG 333E TSF	WNUMG060412E-TSF	●	●			▲	▲				●	●		●	●		●										0.047	0.375	0.187	0.150
			WNUMG 331 TSF	WNUMG060404-TSF	●	●			▲	▲																				0.016	0.375	0.187	0.150
			WNUMG 332 TSF	WNUMG060408-TSF	●	●			▲	▲																				0.031	0.375	0.187	0.150
			WNUMG 431 TSF	WNUMG080404-TSF	●	●	●		▲	▲	▲			●	●	●	●	●		●										0.016	0.500	0.187	0.203
			WNUMG 432 TSF	WNUMG080408-TSF	●	●	●		▲	▲	▲			●	●	●	●	●		●										0.031	0.500	0.187	0.203
			WNUMG 433 TSF	WNUMG080412-TSF	●	●	●	●	▲	▲	▲	▲		●	●	●														0.047	0.500	0.187	0.203
Finishing (wiper)		FW	WNUMG 331E FW	WNUMG060404E-FW	●	●	●		▲	▲	▲						●		●								0.016	0.375	0.187	0.150			
			WNUMG 332E FW	WNUMG060408E-FW	●	●	●		▲	▲	▲							●		●								0.031	0.375	0.187	0.150		
			WNUMG 431 FW	WNUMG080404-FW	●	●			▲	▲								●		●									0.016	0.500	0.187	0.203	
			WNUMG 432 FW	WNUMG080408-FW	●	●	●		▲	▲	▲							●		●									0.031	0.500	0.187	0.203	
Finishing		AFW	WNUMG 331 AFW	WNUMG060404-AFW	●	●			▲	▲									●								0.016	0.375	0.187	0.150			
			WNUMG 332 AFW	WNUMG060408-AFW	●	●	●	●	▲	▲	▲	▲								●								0.031	0.375	0.187	0.150		
			WNUMG 431 AFW	WNUMG080404-AFW	●	●			▲	▲										●									0.016	0.500	0.187	0.203	
			WNUMG 432 AFW	WNUMG080408-AFW	●	●	●	●	▲	▲	▲	▲	●							●									0.031	0.500	0.187	0.203	
			ZF	WNUMG 331E ZF	WNUMG060404E-ZF	●	●			▲	▲																		0.016	0.375	0.187	0.150	
			WNUMG 331 ZF	WNUMG060404-ZF	●	●			▲	▲																			0.016	0.375	0.187	0.150	
Finishing		ZF	WNUMG 332 ZF	WNUMG060408-ZF	●	●			▲	▲																	0.031	0.375	0.187	0.150			
			WNUMG 431 ZF	WNUMG080404-ZF	●	●	●		▲	▲	▲					●	●		●									0.016	0.500	0.187	0.203		
			WNUMG 432 ZF	WNUMG080408-ZF	●	●	●		▲	▲	▲					●	●		●									0.031	0.500	0.187	0.203		
			WNUMG 433 ZF	WNUMG080412-ZF	●				▲																				0.047	0.500	0.187	0.203	
			11	WNUMG 431-11	WNUMG080404-11																	●							0.016	0.500	0.187	0.203	
WNUMG 432-11	WNUMG080408-11																		●							0.031	0.500	0.187	0.203				
Finishing (for mild steel)		17	WNUMG 431-17	WNUMG080404-17																	●						0.016	0.500	0.187	0.203			
			WNUMG 432-17	WNUMG080408-17																			●						0.031	0.500	0.187	0.203	

* Please see L034-L038 about the adjustment of the machining program for rounding or taper machining by using SW/FW. Please contact a Tungaloy sales representative with questions.

● : Line up
▲ : To be discontinued

Reference pages: External toolholder → C031 - Internal toolholder → D035 -
 TungCap → C038 -, K011 -

Insert NEGATIVE TYPE

- : Continuous cutting
- ◐ : Light interrupted cutting
- ◑ : Heavy interrupted cutting

WN



Trigon, 80°
with hole

Material	T9205	T9215	T9225	T9235	T9115	T9125	T9135	T6120	T6130	AH630	T5105	T5115	AH8005	AH8015	GT9530	AT9530	NS9530	NS520	
P Steel	●	●	●	●	●	●	●	●	●	●	●	●	●	●	●	●	●	●	●
M Stainless	●	●						●	●	●			●	●					
K Cast iron	●	●	●	●	●	●		●	●	●	●		●	●	●	●	●	●	●
N Non-ferrous																			
S Superalloy														●	●				
H Hard material																			

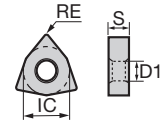

Application	Chipbreaker	Designation		Coated															Coated cermet	Cermet	Dimension (inch)				
		Inch	Metric	T9205	T9215	T9225	T9235	T9115	T9125	T9135	T6120	T6130	AH630	T5105	T5115	AH8005	AH8015	GT9530	AT9530	NS9530	NS520	RE	IC	S	D1
		Metric																							
Finishing	SF	WNMG 331 SF	WNMG060404-SF								●	●	●								0.016	0.375	0.187	0.150	
		WNMG 332 SF	WNMG060408-SF								●	●	●									0.031	0.375	0.187	0.150
		WNMG 431 SF	WNMG080404-SF								●	●	●									0.016	0.500	0.187	0.203
		WNMG 432 SF	WNMG080408-SF								●	●	●									0.031	0.500	0.187	0.203
	CF	WNMG 431 CF	WNMG080404-CF											●	●							0.016	0.500	0.187	0.203
		WNMG 432 CF	WNMG080408-CF											●	●							0.031	0.500	0.187	0.203
		WNMG 433 CF	WNMG080412-CF											●	●							0.047	0.500	0.187	0.203
	HRF	WNMG 431 HRF	WNMG080404-HRF												●	●						0.016	0.500	0.187	0.203
		WNMG 432 HRF	WNMG080408-HRF												●	●						0.031	0.500	0.187	0.203
	TS	WNMG 431 TS	WNMG080404-TS	●	●	●	▲	▲	▲								●	●	●	●	0.016	0.500	0.187	0.203	
		WNMG 432 TS	WNMG080408-TS	●	●	●	▲	▲	▲								●	●	●	●	0.031	0.500	0.187	0.203	
WNMG 433 TS		WNMG080412-TS	●	●	●	▲	▲	▲												0.047	0.500	0.187	0.203		

● : Line up
▲ : To be discontinued

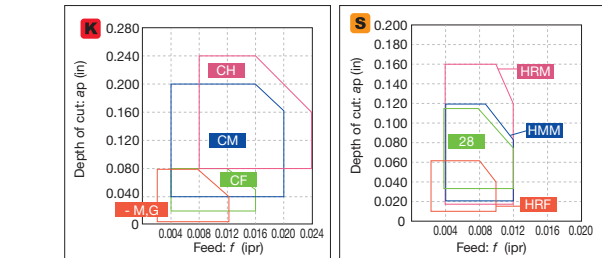
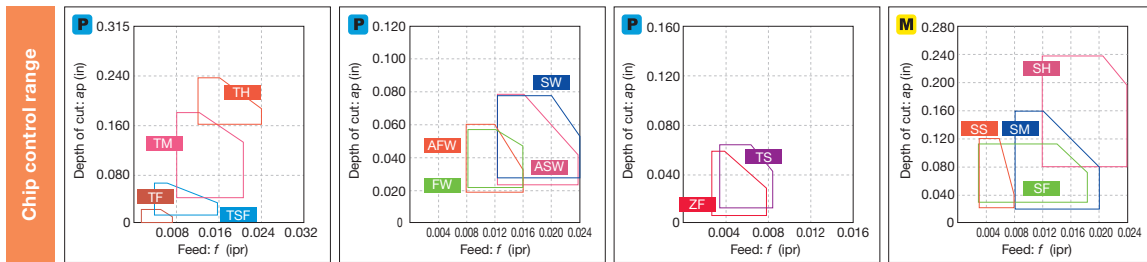

*-M,G: Without chipbreaker

Reference pages: External toolholder → **C031** - Internal toolholder → **D035** -
TungCap → **C038** -, **K011** -

Grade
Insert
Toolholder
Ext. Toolholder
Int. Toolholder
Threading
Grooving
Milling Cutter
Miniature Tool
Endmill
Drilling Tool
Tooling System
User's Guide
Index



Insert NEGATIVE TYPE

● : Continuous cutting
 ● : Light interrupted cutting
 ✖ : Heavy interrupted cutting

WN



Trigon, 80° with hole

P	Steel	●	●	●	✖	●	●	●	✖	●	●	●	●	●	●	●	●	●	●	●
M	Stainless	●	●							●	●	●	✖			●	●	●		
K	Cast iron	●	●	●		●	●	●							●	●	●	●	●	●
N	Non-ferrous																			
S	Superalloy																			
H	Hard material																			

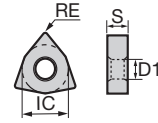

Application	Chipbreaker	Designation		Coated															Cermet	Dimension (inch)					
		Inch	Metric	T9205	T9215	T9225	T9235	T9105	T9115	T9125	T9135	T6120	T6130	AH630	AH645	T515	T5115	GH330	NS9530	RE	IC	S	D1		
Finishing to medium cutting (wiper)	 0.008 70°	SW	WNMG 332E SW	WNMG060408E-SW	●	●	●		▲	▲	▲									●	0.031	0.375	0.187	0.150	
			WNMG 333E SW	WNMG060412E-SW	●	●	●		▲	▲	▲										●	0.047	0.375	0.187	0.150
			WNMG 432 SW	WNMG080408-SW	●	●	●		▲	▲	▲						●	●			●	0.031	0.500	0.187	0.203
			WNMG 433 SW	WNMG080412-SW		●	●		▲	▲							●	●			●	0.047	0.500	0.187	0.203
		*Wiper																							
	 0.008 18°	ASW	WNMG 332 ASW	WNMG060408-ASW	●	●	●		▲	▲	▲									●	0.031	0.375	0.187	0.150	
			WNMG 333 ASW	WNMG060412-ASW	●	●	●	●	▲	▲	▲	▲									●	0.047	0.375	0.187	0.150
			WNMG 432 ASW	WNMG080408-ASW	●	●	●	●	▲	▲	▲	▲									●	0.031	0.500	0.187	0.203
		WNMG 433 ASW	WNMG080412-ASW	●	●	●	●	▲	▲	▲	▲									●	0.047	0.500	0.187	0.203	
High feed, small depth of cut	 0.008 18°	AS	WNMG 431 AS	WNMG080404-AS	●				▲										●	0.016	0.500	0.187	0.203		
			WNMG 432 AS	WNMG080408-AS	●	●	●	●	▲	▲	▲	▲								●	0.031	0.500	0.187	0.203	
			WNMG 433 AS	WNMG080412-AS	●	●	●	●	▲	▲	▲	▲								●	0.047	0.500	0.187	0.203	
Boring (double side)	 37°	CB	WNMG 331 CB	WNMG060404-CB				●		▲									●	0.016	0.375	0.187	0.150		
			WNMG 332 CB	WNMG060408-CB				●		▲										●	0.031	0.375	0.187	0.150	
Finishing	 16°	NS	WNMG 431 NS	WNMG080404-NS	●	●			▲	▲									●	0.016	0.500	0.187	0.203		
			WNMG 432 NS	WNMG080408-NS	●	●			▲	▲										●	0.031	0.500	0.187	0.203	
		SS	WNMG 331E SS	WNMG060404E-SS										●	●					●	0.016	0.375	0.187	0.150	
			WNMG 332E SS	WNMG060408E-SS										●	●					●	0.031	0.375	0.187	0.150	
			WNMG 333E SS	WNMG060412E-SS										●	●					●	0.047	0.375	0.187	0.150	
			WNMG 431 SS	WNMG080404-SS								●	●	●	●		●			●	0.016	0.500	0.187	0.203	
			WNMG 432 SS	WNMG080408-SS								●	●	●	●		●			●	0.031	0.500	0.187	0.203	
			WNMG 433 SS	WNMG080412-SS								●	●	●	●					●	0.047	0.500	0.187	0.203	

* Please see L034-L038 about the adjustment of the machining program for rounding or taper machining by using SW/FW.
 Please contact a Tungaloy sales representative with questions.

● : Line up
 ▲ : To be discontinued

Reference pages: External toolholder → C031 - Internal toolholder → D035 -
 TungCap → C038 -, K011 -

Insert NEGATIVE TYPE

- : Continuous cutting
- ◐ : Light interrupted cutting
- ◑ : Heavy interrupted cutting

WN



Trigon, 80° with hole

P	Steel	●	◐	◑	✱	●	◐	◑	✱	◐	◑	●	◐	◑	●	◐	◑	●	◐	◑
M	Stainless	●	◐			●	◐	◑	✱	◐	◑	●	◐	◑	●	◐	◑	●	◐	◑
K	Cast iron	◐	◑	●		◐	◑	●		◐	◑	●	◐	◑	●	◐	◑	●	◐	◑
N	Non-ferrous																			
S	Superalloy											◐	◑	●						
H	Hard material																			

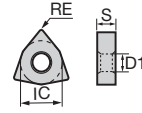

Application	Chipbreaker	Designation		Coated												Coated cermet		Cermet	Dimension (inch)								
		Inch	Metric	T9205	T9215	T9225	T9235	T9105	T9115	T9125	T9135	AH120	AH725	AH8015	T515	GT9530	AT9530	NS9530	RE	IC	S	D1					
Medium cutting		TM	WNMG 331E TM	WNMG060404E-TM	●	●				▲	▲		●	●									0.016	0.375	0.187	0.150	
			WNMG 332E TM	WNMG060408E-TM	●	●				▲	▲		●	●										0.031	0.375	0.187	0.150
			WNMG 333E TM	WNMG060412E-TM	●	●				▲	▲		●	●										0.047	0.375	0.187	0.150
			WNMG 331 TM	WNMG060404-TM	●	●	●			▲	▲	▲												0.016	0.375	0.187	0.150
			WNMG 332 TM	WNMG060408-TM	●	●	●	●		▲	▲	▲	▲	●										0.031	0.375	0.187	0.150
			WNMG 431 TM	WNMG080404-TM	●	●	●	●		▲	▲	▲	▲	●	●									0.016	0.500	0.187	0.203
			WNMG 432 TM	WNMG080408-TM	●	●	●	●		▲	▲	▲	▲	●	●	●	●							0.031	0.500	0.187	0.203
			WNMG 433 TM	WNMG080412-TM	●	●	●	●		▲	▲	▲	▲	●	●	●	●							0.047	0.500	0.187	0.203
			WNMG 434 TM	WNMG080416-TM	●	●	●			▲	▲	▲		●										0.063	0.500	0.187	0.203
Finishing to medium cutting		AM	WNMG 432 AM	WNMG080408-AM	●	●				▲	▲												0.031	0.500	0.187	0.203	
			WNMG 433 AM	WNMG080412-AM	●	●				▲	▲												0.047	0.500	0.187	0.203	
			WNMG 434 AM	WNMG080416-AM	●	●				▲	▲												0.063	0.500	0.187	0.203	
		TQ	WNMG 431 TQ	WNMG080404-TQ	●	●									●	●		●						0.016	0.500	0.187	0.203
			WNMG 432 TQ	WNMG080408-TQ	●	●									●	●		●						0.031	0.500	0.187	0.203
Medium cutting		TA	WNMG 432 TA	WNMG080408-TA	●	●																	0.031	0.500	0.187	0.203	
			WNMG 433 TA	WNMG080412-TA	●	●																		0.047	0.500	0.187	0.203
		NM	WNMG 333E NM	WNMG060412E-NM		●						▲												0.047	0.375	0.187	0.150
	WNMG 432 NM	WNMG080408-NM	●	●	●				▲	▲	▲											0.031	0.500	0.187	0.203		
	WNMG 433 NM	WNMG080412-NM	●	●	●	●			▲	▲	▲	▲										0.047	0.500	0.187	0.203		

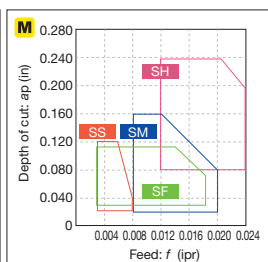
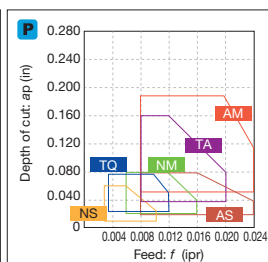
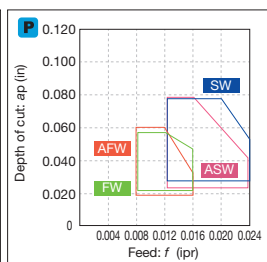
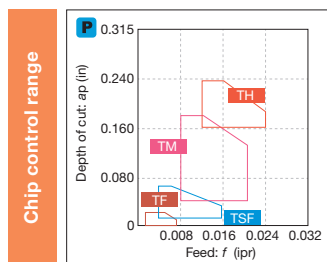

● : Line up
▲ : To be discontinued

Reference pages: External toolholder → C031 - Internal toolholder → D035 - TungCap → C038 -, K011 -

Grade
Insert
Ext. Toolholder
Int. Toolholder
Threading
Grooving
Milling Cutter
Miniature Tool
Endmill
Drilling Tool
Tooling System
User's Guide
Index



Insert NEGATIVE TYPE

● : Continuous cutting
 ● : Light interrupted cutting
 ✱ : Heavy interrupted cutting

WN

Trigon, 80° with hole



Material	Steel	Stainless	Cast iron	Non-ferrous	Superalloy	Hard material
P	●●●●●✱		●●●●●✱			
M	●●					
K	●●●●●		●●●●●			
N						●
S					●●	
H						

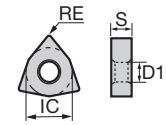

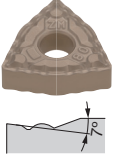
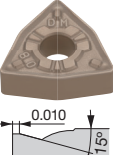
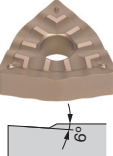
Application	Chipbreaker	Designation	Coated														Coated cermet	Cermet	Un-coated	Dimension (inch)												
			Inch		Metric		T9205	T9215	T9225	T9235	T9105	T9115	T9125	T9135	T515	T5105	T5115	T5125	AH110	AH120	GH330	GT720	GT9530	NS9530	NS520	TH10	RE	IC	S	D1		
Finishing to medium cutting		ZM WNMG 332E ZM WNMG060408E-ZM	●	●																							0.031	0.375	0.187	0.150		
		WNMG 332 ZM WNMG060408-ZM	●	●	●																							0.031	0.375	0.187	0.150	
		WNMG 333 ZM WNMG060412-ZM	●	●	●																							0.047	0.375	0.187	0.150	
		WNMG 432 ZM WNMG080408-ZM	●	●	●																		●	●				0.031	0.500	0.187	0.203	
		WNMG 433 ZM WNMG080412-ZM	●	●	●																							0.047	0.500	0.187	0.203	
		WNMG 434 ZM WNMG080416-ZM	●	●																								0.063	0.500	0.187	0.203	
Medium cutting		DM WNMG 432 DM WNMG080408-DM	●	●	●	●	▲	▲	▲	▲																	0.031	0.500	0.187	0.203		
		WNMG 433 DM WNMG080412-DM	●	●	●	●	▲	▲	▲	▲																		0.047	0.500	0.187	0.203	
		All-round WNMG 331 WNMG060404	●	●						▲	▲					●	●	●										0.016	0.375	0.187	0.150	
		WNMG 332 WNMG060408	●	●						▲	▲					●	●	●										0.031	0.375	0.187	0.150	
		WNMG 431 WNMG080404	●	●	●	●	▲	▲	▲	▲	●	●	●	●	●	●	●	●	●	●	●			●	●	●	●	0.016	0.500	0.187	0.203	
		WNMG 432 WNMG080408	●	●	●	●	▲	▲	▲	▲	●	●	●	●	●	●	●	●	●	●	●			●	●	●	●	0.031	0.500	0.187	0.203	
Finishing to medium cutting		27 WNMG 432-27 WNMG080408-27			●																						0.031	0.500	0.187	0.203		
		33 WNMG 431-33 WNMG080404-33																					●					0.016	0.500	0.187	0.203	
		WNMG 432-33 WNMG080408-33									▲														●			0.031	0.500	0.187	0.203	
		WNMG 433-33 WNMG080412-33																								●		0.047	0.500	0.187	0.203	
		37 WNMG 431-37 WNMG080404-37																							●				0.016	0.500	0.187	0.203
		WNMG 432-37 WNMG080408-37	●								▲													●	●				0.031	0.500	0.187	0.203

● : Line up
 ▲ : To be discontinued

Reference pages: External toolholder → C031 - Internal toolholder → D035 - TungCap → C038 -, K011 -

Insert

NEGATIVE TYPE

- : Continuous cutting
- ◐ : Light interrupted cutting
- ◑ : Heavy interrupted cutting

WN



Trigon, 80°
with hole

P Steel	◐	◑	◑	◑	◑	◑	◑	◑	◑	◑	◑	◑	◑	◑	◑	◑	◑	◑	◑	◑	◑	◑	◑
M Stainless	◐	◑	◑	◑	◑	◑	◑	◑	◑	◑	◑	◑	◑	◑	◑	◑	◑	◑	◑	◑	◑	◑	◑
K Cast iron	◐	◑	◑	◑	◑	◑	◑	◑	◑	◑	◑	◑	◑	◑	◑	◑	◑	◑	◑	◑	◑	◑	◑
N Non-ferrous	◐	◑	◑	◑	◑	◑	◑	◑	◑	◑	◑	◑	◑	◑	◑	◑	◑	◑	◑	◑	◑	◑	◑
S Superalloy	◐	◑	◑	◑	◑	◑	◑	◑	◑	◑	◑	◑	◑	◑	◑	◑	◑	◑	◑	◑	◑	◑	◑
H Hard material	◐	◑	◑	◑	◑	◑	◑	◑	◑	◑	◑	◑	◑	◑	◑	◑	◑	◑	◑	◑	◑	◑	◑

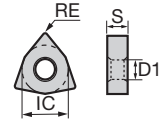

Application	Chipbreaker	Designation		Coated											Uncoated	Dimension (inch)						
		Inch	Metric	T6120	T6130	AH630	AH645	T515	T5105	T5115	T5125	AH120	AH725	AH8005	AH8015	AH905	KS20	RE	IC	S	D1	
Medium cutting		SM	WNMG 331E SM	WNMG060404E-SM	●	●	●												0.016	0.375	0.187	0.150
		WNMG 332E SM	WNMG060408E-SM	●	●	●													0.031	0.375	0.187	0.150
		WNMG 333E SM	WNMG060412E-SM	●	●	●													0.047	0.375	0.187	0.150
		WNMG 332 SM	WNMG060408-SM											●					0.031	0.375	0.187	0.150
		WNMG 431 SM	WNMG080404-SM	●	●	●	●												0.016	0.500	0.187	0.203
		WNMG 432 SM	WNMG080408-SM	●	●	●	●							●					0.031	0.500	0.187	0.203
		WNMG 433 SM	WNMG080412-SM	●	●	●	●							●					0.047	0.500	0.187	0.203
Medium cutting		CM	WNMG 431 CM	WNMG080404-CM						●							0.016	0.500	0.187	0.203		
		WNMG 432 CM	WNMG080408-CM				●	●	●	●							0.031	0.500	0.187	0.203		
		WNMG 433 CM	WNMG080412-CM				●	●	●	●							0.047	0.500	0.187	0.203		
Finishing to medium cutting		HRM	WNMG 431 HRM	WNMG080404-HRM									●	●			0.016	0.500	0.187	0.203		
		WNMG 432 HRM	WNMG080408-HRM										●	●			0.031	0.500	0.187	0.203		
		WNMG 433 HRM	WNMG080412-HRM										●	●			0.047	0.500	0.187	0.203		
Medium cutting		HMM	WNMG 431 HMM	WNMG080404-HMM										●			0.016	0.500	0.187	0.203		
		WNMG 432 HMM	WNMG080408-HMM											●			0.031	0.500	0.187	0.203		
		WNMG 433 HMM	WNMG080412-HMM											●			0.047	0.500	0.187	0.203		

● : Line up

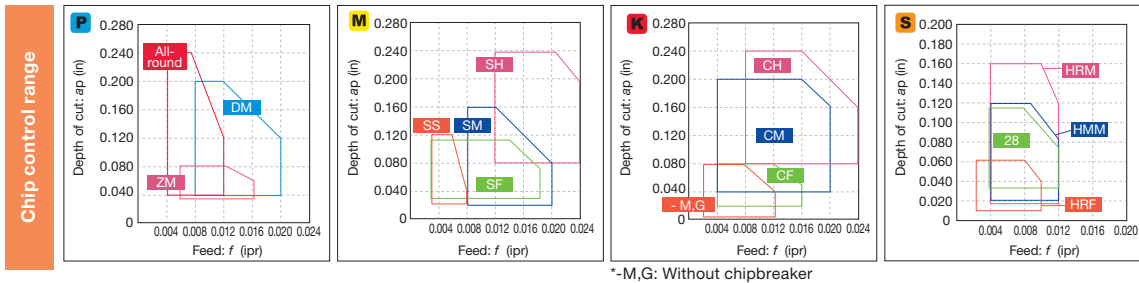

Reference pages: External toolholder → C031 - Internal toolholder → D035 - TungCap → C038 -, K011 -

Insert NEGATIVE TYPE

● : Continuous cutting
 ● : Light interrupted cutting
 ✱ : Heavy interrupted cutting

WN



Trigon, 80°
with hole

	P	M	K	N	S	H
Steel	●●●●✱	●●●●✱	●●●●✱	●●●●✱	●●●●✱	●●●●✱
Stainless	●●	●●	●●	●●	●●	●●
Cast iron	●●●●	●●●●	●●●●	●●●●	●●●●	●●●●
Non-ferrous	●●	●●	●●	●●	●●	●●
Superalloy	●●	●●	●●	●●	●●	●●
Hard material						

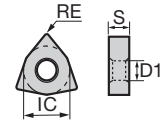

Application	Chipbreaker	Designation	Coated														Un-coated	Dimension (inch)										
			T9205	T9215	T9225	T9235	T9105	T9115	T9125	T9135	T6120	T6130	AH630	AH645	T5105	T5115	T5125	T515	AH120	AH725	AH8015	KS20	RE	IC	S	D1		
Medium cutting		SA WNMG 432 SA WNMG080408-SA																			●	0.031	0.500	0.187	0.203			
		WNMG 433 SA WNMG080412-SA																				●	0.047	0.500	0.187	0.203		
Medium to heavy cutting		TH WNMG 432 TH WNMG080408-TH	●●●●	●●●●	●●●●	●●●●	▲▲▲▲	▲▲▲▲	▲▲▲▲	▲▲▲▲	●								●●	●●	●●		0.031	0.500	0.187	0.203		
		WNMG 433 TH WNMG080412-TH	●●●●	●●●●	●●●●	●●●●	▲▲▲▲	▲▲▲▲	▲▲▲▲	▲▲▲▲										●●	●●	●●		0.047	0.500	0.187	0.203	
		WNMG 434 TH WNMG080416-TH	●●●●	●●●●			▲▲▲▲	▲▲▲▲	▲▲▲▲	▲▲▲▲											●●	●●	●●		0.063	0.500	0.187	0.203
		WNMG 543 TH WNMG100612-TH	●●●●	●●●●			▲▲▲▲	▲▲▲▲	▲▲▲▲	▲▲▲▲														0.047	0.625	0.250	0.250	
		WNMG 544 TH WNMG100616-TH	●●●●	●●●●			▲▲▲▲	▲▲▲▲	▲▲▲▲	▲▲▲▲														0.063	0.625	0.250	0.250	
Medium to heavy cutting		SH WNMG 432 SH WNMG080408-SH																●●●	●●●	●●●		0.031	0.500	0.187	0.203			
		WNMG 433 SH WNMG080412-SH																	●●●	●●●	●●●		0.047	0.500	0.187	0.203		
Medium to heavy cutting		CH WNMG 432 CH WNMG080408-CH																●●●	●●●	●●●		0.031	0.500	0.187	0.203			
		WNMG 433 CH WNMG080412-CH																	●●●	●●●	●●●		0.047	0.500	0.187	0.203		

● : Line up
 ▲ : To be discontinued

- : Continuous cutting
- ◐ : Light interrupted cutting
- ◑ : Heavy interrupted cutting

Insert NEGATIVE TYPE

WN

 **Trigon, 80° with hole**

P	Steel					●●														
M	Stainless					●●														
K	Cast iron	●●		●	◑	●●		●●												
N	Non-ferrous												●							
S	Superalloy												●●							
H	Hard material																			●

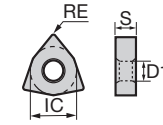

Application	Chipbreaker	Designation		Coated					Cermet	Uncoated	Ceramic	Dimension (inch)				
		Inch	Metric	T515	T5105	T5115	T5125	AH120	NS520	TH10	LX11	RE	IC	S	D1	
Finishing to medium cutting		-	WNMA 331E	WNMA060404E	●							0.016	0.375	0.187	0.150	
			WNMA 332E	WNMA060408E	●								0.031	0.375	0.187	0.150
			WNMA 333E	WNMA060412E	●								0.047	0.375	0.187	0.150
			WNMA 334E	WNMA060416E	●								0.063	0.375	0.187	0.150
			WNMA 431	WNMA080404		●	●	●			●		0.016	0.500	0.187	0.203
			WNMA 432	WNMA080408		●	●	●		●			0.031	0.500	0.187	0.203
			WNMA 433	WNMA080412		●	●	●					0.047	0.500	0.187	0.203
			WNMA 434	WNMA080416		●	●	●					0.063	0.500	0.187	0.203
			WNGA 431	WNGA080404									0.016	0.500	0.187	0.203
			WNGA 432	WNGA080408								●	0.031	0.500	0.187	0.203
	WNGA 433	WNGA080412								●	0.047	0.500	0.187	0.203		

YN

 **Rhombic, 25° with hole**

P	Steel	●●	◑	●●	◑	●●														
M	Stainless																			
K	Cast iron							●●		●●										
N	Non-ferrous																			
S	Superalloy																			
H	Hard material																			

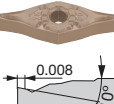
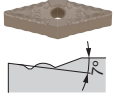

Application	Chipbreaker	Designation		Coated				Coated cermet	Cermet	Dimension (inch)					
		Inch	Metric	T9225	T9235	T9125	T9135	GT9530	NS9530	RE	IC	S	D1		
Finishing		ZF	YNMG 331 ZF	YNMG160404-ZF	●	●	▲	▲	●		●	0.016	0.375	0.187	0.150
			YNMG 332 ZF	YNMG160408-ZF	●	●	▲	▲	●		●	0.031	0.375	0.187	0.150
Finishing to medium cutting		ZM	YNMG 331 ZM	YNMG160404-ZM	●	●	▲	▲	●		●	0.016	0.375	0.187	0.150
			YNMG 332 ZM	YNMG160408-ZM	●	●	▲	▲	●		●	0.031	0.375	0.187	0.150

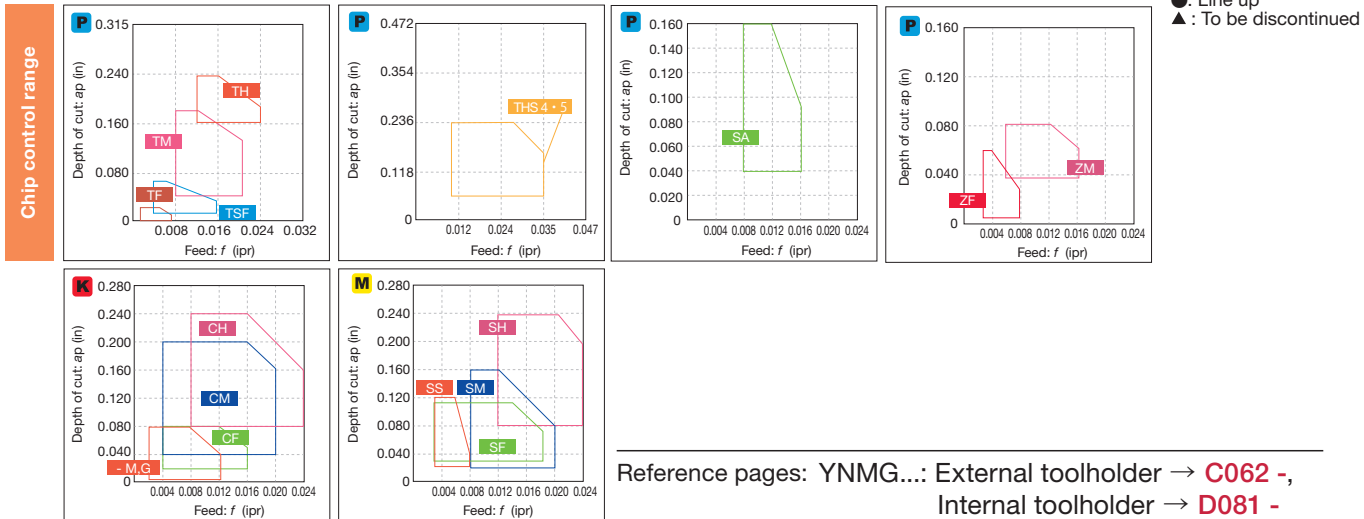

*-M,G: Without chipbreaker

Grade
Insert
Ext. Toolholder
Int. Toolholder
Threading
Grooving
Miniature Tool
Milling Cutter
Endmill
Drilling Tool
Tooling System
User's Guide
Index

Negative

Positive

PCD / CBN

C

D

G

R

S

T

V

W

Y

OTHERS

Insert NEGATIVE TYPE

- : Continuous cutting
- : Light interrupted cutting
- ⚡ : Heavy interrupted cutting

KN



Parallelogram, 55° without hole

P	Steel	●●
M	Stainless	●●
K	Cast iron	●●
N	Non-ferrous	
S	Superalloy	
H	Hard material	

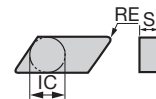

Application	Designation		Coated	Dimension (inch)			
	Inch	Metric		RE	IC	S	D1
Chipbreaker			GH330				
Finishing	S1	KNMX160405R-S1	●	0.020	0.375	0.187	-
		KNMX160405L-S1	●	0.020	0.375	0.187	-

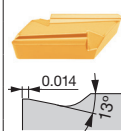

●: Line up

HN



Hexagonal, 120° without hole

P	Steel	
M	Stainless	
K	Cast iron	●●
N	Non-ferrous	
S	Superalloy	
H	Hard material	

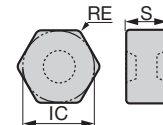

Application	Designation		Ceramic	Dimension (inch)			
	Inch	Metric		RE	IC	S	D1
Chipbreaker			FX105				
Finishing to medium cutting	-	HNGD 453	●	0.047	0.500	0.313	-
		HNGD 454	●	0.063	0.500	0.313	-

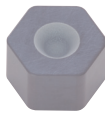

●: Line up

Reference pages: HNGD...: External toolholder → C111

Insert POSITIVE TYPE

- : Continuous cutting
- ◐ : Light interrupted cutting
- ◑ : Heavy interrupted cutting

CC



Rhombic, 80°
with hole
Positive 7°

	P	M	K	N	S	H
Steel	●	●	●	●	●	●
Stainless	●	●	●	●	●	●
Cast iron	●	●	●	●	●	●
Non-ferrous	●	●	●	●	●	●
Superalloy	●	●	●	●	●	●
Hard material	●	●	●	●	●	●

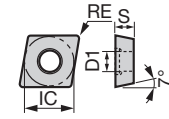

Application	Chipbreaker	Designation	Coated										Coated cermet	Cermet	Dimension (inch)													
			Inch		Metric		T9215	T9225	T9115	T9125	T6120	T6130	AH725	AH8005	AH8015	AH110	GH730	SH725	J740	GT9530	NS9530	RE	IC	S	D1			
Precision finishing		01	CCGT 21.50.5-01	CCGT060202-01																								
			CCGT 32.50.5-01	CCGT09T302-01																								
Precision finishing (sharp edge)		01	CCGT 21.50.5 F-01	CCGT060202F-01																								
			CCGT 21.51 F-01	CCGT060204F-01																								
			CCGT 32.50.5 F-01	CCGT09T302F-01																								
			CCGT 32.51 F-01	CCGT09T304F-01																								
Finishing		PSF	CCMT 21.50.5 PSF	CCMT060202-PSF																								
			CCMT 21.51 PSF	CCMT060204-PSF	●	●	▲	▲																				
			CCMT 32.50.5 PSF	CCMT09T302-PSF																								
			CCMT 32.51 PSF	CCMT09T304-PSF	●	●	▲	▲																				
			CCMT 32.52 PSF	CCMT09T308-PSF	●	●	▲	▲																				
			PF	CCMT 21.50.5 PF	CCMT060202-PF																							
		CCMT 21.51 PF	CCMT060204-PF																									
		CCMT 21.52 PF	CCMT060208-PF																									
		CCMT 32.50.5 PF	CCMT09T302-PF																									
		CCMT 32.51 PF	CCMT09T304-PF																									
		CCMT 32.52 PF	CCMT09T308-PF																									

*Corner radius (RE) with a sign of inequality (<) means minus tolerance.

● : Line up
▲ : To be discontinued

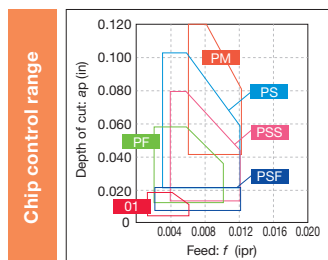

Reference pages: External toolholder → **C026** - Internal toolholder → **D020** -
J-Series toolholder → **G027** -

Grade
Insert
Toolholder
Ext. Toolholder
Int. Toolholder
Threading
Grooving
Miniature Tool
Milling Cutter
Endmill
Drilling Tool
Tooling System
User's Guide
Index

Insert POSITIVE TYPE

● : Continuous cutting
 ◐ : Light interrupted cutting
 ✱ : Heavy interrupted cutting

CC



**Rhombic, 80°
with hole
Positive 7°**

	P	M	K	N	S	H
Steel	●●◐✱	●●	●●	●●	●●	●●
Stainless	●●	●●	●●	●●	●●	●●
Cast iron	●●	●●	●●	●●	●●	●●
Non-ferrous	●●	●●	●●	●●	●●	●●
Superalloy	●●	●●	●●	●●	●●	●●
Hard material	●●	●●	●●	●●	●●	●●

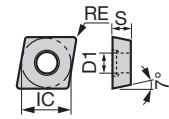

Application	Chipbreaker	Designation		Coated													Coated cermet	Cermet	Dimension (inch)					
		Inch	Metric	T9215	T9225	T9115	T9125	T6120	T6130	AH630	AH645	AH120	AH725	AH8005	AH8015	GH730	GT9530	AT9530	NS9530	RE	IC	S	D1	
		Finishing to light cutting		PSS	CCMT 21.51 PSS / CCMT060204-PSS	●●	●●	▲▲	●●	●●	●●	●●	●●	●●	●●	●●	●●	●●	●●	●●	●●	●●	0.016	0.250
		CCMT 21.52 PSS / CCMT060208-PSS	●●	●●	▲▲	●●	●●	●●	●●	●●	●●	●●	●●	●●	●●	●●	●●	●●	●●	0.031	0.250	0.094	0.110	
		CCMT 32.51 PSS / CCMT09T304-PSS	●●	●●	▲▲	●●	●●	●●	●●	●●	●●	●●	●●	●●	●●	●●	●●	●●	●●	0.016	0.375	0.156	0.173	
		CCMT 32.52 PSS / CCMT09T308-PSS	●●	●●	▲▲	●●	●●	●●	●●	●●	●●	●●	●●	●●	●●	●●	●●	●●	●●	0.031	0.375	0.156	0.173	
		CCMT 431 PSS / CCMT120404-PSS	●●	●●	▲▲	●●	●●	●●	●●	●●	●●	●●	●●	●●	●●	●●	●●	●●	●●	0.016	0.500	0.187	0.217	
		CCMT 432 PSS / CCMT120408-PSS	●●	●●	▲▲	●●	●●	●●	●●	●●	●●	●●	●●	●●	●●	●●	●●	●●	●●	0.031	0.500	0.187	0.217	
		CCMT 433 PSS / CCMT120412-PSS	●●	●●	▲▲	●●	●●	●●	●●	●●	●●	●●	●●	●●	●●	●●	●●	●●	●●	0.047	0.500	0.187	0.217	
Medium cutting (wiper)		SW	CCMT 21.51 SW / CCMT060204-SW	●●	●●	▲▲	●●	●●	●●	●●	●●	●●	●●	●●	●●	●●	●●	●●	●●	0.016	0.250	0.094	0.110	
		CCMT 21.52 SW / CCMT060208-SW	●●	●●	▲▲	●●	●●	●●	●●	●●	●●	●●	●●	●●	●●	●●	●●	●●	0.031	0.250	0.094	0.110		
		CCMT 32.51 SW / CCMT09T304-SW	●●	●●	▲▲	●●	●●	●●	●●	●●	●●	●●	●●	●●	●●	●●	●●	●●	0.016	0.375	0.156	0.173		
		CCMT 32.52 SW / CCMT09T308-SW	●●	●●	▲▲	●●	●●	●●	●●	●●	●●	●●	●●	●●	●●	●●	●●	●●	0.031	0.375	0.156	0.173		
		*Wiper																						
Finishing to medium cutting		PS	CCMT 21.50.5 PS / CCMT060202-PS	●●	●●	▲▲	●●	●●	●●	●●	●●	●●	●●	●●	●●	●●	●●	●●	●●	0.008	0.250	0.094	0.110	
		CCMT 21.51 PS / CCMT060204-PS	●●	●●	▲▲	●●	●●	●●	●●	●●	●●	●●	●●	●●	●●	●●	●●	●●	0.016	0.250	0.094	0.110		
		CCMT 21.52 PS / CCMT060208-PS	●●	●●	▲▲	●●	●●	●●	●●	●●	●●	●●	●●	●●	●●	●●	●●	●●	0.031	0.250	0.094	0.110		
		CCMT 32.50.5 PS / CCMT09T302-PS	●●	●●	▲▲	●●	●●	●●	●●	●●	●●	●●	●●	●●	●●	●●	●●	●●	0.008	0.375	0.156	0.173		
		CCMT 32.51 PS / CCMT09T304-PS	●●	●●	▲▲	●●	●●	●●	●●	●●	●●	●●	●●	●●	●●	●●	●●	●●	0.016	0.375	0.156	0.173		
		CCMT 32.52 PS / CCMT09T308-PS	●●	●●	▲▲	●●	●●	●●	●●	●●	●●	●●	●●	●●	●●	●●	●●	●●	0.031	0.375	0.156	0.173		
		CCMT 431 PS / CCMT120404-PS	●●	●●	▲▲	●●	●●	●●	●●	●●	●●	●●	●●	●●	●●	●●	●●	●●	0.016	0.500	0.187	0.217		
		CCMT 432 PS / CCMT120408-PS	●●	●●	▲▲	●●	●●	●●	●●	●●	●●	●●	●●	●●	●●	●●	●●	●●	0.031	0.500	0.187	0.217		
		CCMT 433 PS / CCMT120412-PS	●●	●●	▲▲	●●	●●	●●	●●	●●	●●	●●	●●	●●	●●	●●	●●	●●	0.047	0.500	0.187	0.217		
		TSF	CCMT 21.51 TSF / CCMT060204-TSF	●●	●●														0.016	0.250	0.094	0.110		
		CCMT 21.52 TSF / CCMT060208-TSF	●●	●●															0.031	0.250	0.094	0.110		
		CCMT 32.51 TSF / CCMT09T304-TSF	●●	●●															0.016	0.375	0.156	0.173		
		CCMT 32.52 TSF / CCMT09T308-TSF	●●	●●															0.031	0.375	0.156	0.173		
		TM	CCMT 21.51 TM / CCMT060204-TM	●●	●●														0.016	0.250	0.094	0.110		
		CCMT 21.52 TM / CCMT060208-TM	●●	●●															0.031	0.250	0.094	0.110		
		CCMT 32.51 TM / CCMT09T304-TM	●●	●●															0.016	0.375	0.156	0.173		
		CCMT 32.52 TM / CCMT09T308-TM	●●	●●															0.031	0.375	0.156	0.173		

* Please see L034-L038 about the adjustment of the machining program for rounding or taper machining by using SW/FW.
Please contact a Tungaloy sales representative with questions.

● : Line up
▲ : To be discontinued

Reference pages: External toolholder → **C026** - Internal toolholder → **D020** -
 J-Series toolholder → **G027** -

Insert POSITIVE TYPE

- : Continuous cutting
- ◐ : Light interrupted cutting
- ◑ : Heavy interrupted cutting

CC



**Rhombic, 80°
with hole
Positive 7°**

Material	Steel	Stainless	Cast iron	Non-ferrous	Superalloy	Hard material
P	●	◐	◑	◐	◐	◐
M	◐	◐	◐	◐	◐	◐
K	◐	◐	◐	◐	◐	◐
N	◐	◐	◐	◐	◐	◐
S	◐	◐	◐	◐	◐	◐
H	◐	◐	◐	◐	◐	◐

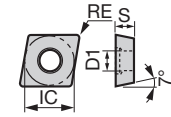

Application	Chipbreaker	Designation	Coated						Cermet	Uncoated	Dimension (inch)				
			T9215	T9225	T9115	T9125	T6130	AH120	SH730	NS9530	TH10	RE	IC	S	D1
		Inch	Metric												
Finishing to medium cutting		23 CCGT 21.50.5-23 CCGT060202-23	●	●	●	●	●	●	●	●	0.008	0.250	0.094	0.110	
		CCMT 21.51-23 CCMT060204-23	●	●	●	●	●	●	●	●	0.016	0.250	0.094	0.110	
		CCMT 21.52-23 CCMT060208-23	●	●	●	●	●	●	●	●	0.031	0.250	0.094	0.110	
		CCMT 32.51-23 CCMT09T304-23	●	●	●	●	●	●	●	●	0.016	0.375	0.156	0.173	
		CCMT 32.52-23 CCMT09T308-23	●	●	●	●	●	●	●	●	0.031	0.375	0.156	0.173	
Medium cutting		24 CCGT 21.50.5-24 CCGT060202-24	●	●	●	●	●	●	●	●	0.008	0.250	0.094	0.110	
		CCMT 21.51-24 CCMT060204-24	●	●	●	●	●	●	●	●	0.016	0.250	0.094	0.110	
		CCMT 21.52-24 CCMT060208-24	●	●	●	●	●	●	●	●	0.031	0.250	0.094	0.110	
		CCMT 32.50.5-24 CCMT09T302-24	●	●	●	●	●	●	●	●	0.008	0.375	0.156	0.173	
		CCMT 32.51-24 CCMT09T304-24	●	●	●	●	●	●	●	●	0.016	0.375	0.156	0.173	
		CCMT 32.52-24 CCMT09T308-24	●	●	●	●	●	●	●	●	0.031	0.375	0.156	0.173	
		CCMT 432-24 CCMT120408-24	●	●	●	●	●	●	●	●	0.031	0.500	0.187	0.217	
Finishing		W08 CCGT 4.51.8V R-W08 CCGT03X100R-W08						●	●	0.001	0.141	0.055	0.075		
		CCGT 4.51.8V L-W08 CCGT03X100L-W08						●	●	0.001	0.141	0.055	0.075		
		CCGT 4.51.80 R-W08 CCGT03X101R-W08						●	●	0.004	0.141	0.055	0.075		
		CCGT 4.51.80 L-W08 CCGT03X101L-W08						●	●	0.004	0.141	0.055	0.075		
		CCGT 4.51.80.5 R-W08 CCGT03X102R-W08						●	●	0.008	0.141	0.055	0.075		
		CCGT 4.51.80.5 L-W08 CCGT03X102L-W08						●	●	0.008	0.141	0.055	0.075		
		CCGT 4.51.81 R-W08 CCGT03X104R-W08						●	●	0.016	0.141	0.055	0.075		
		CCGT 4.51.81 L-W08 CCGT03X104L-W08						●	●	0.016	0.141	0.055	0.075		
		CCGT 5.52.2V R-W08 CCGT04T100R-W08						●	●	0.001	0.172	0.070	0.091		
		CCGT 5.52.2V L-W08 CCGT04T100L-W08						●	●	0.001	0.172	0.070	0.091		
		CCGT 5.52.20 R-W08 CCGT04T101R-W08						●	●	0.004	0.172	0.070	0.091		
		CCGT 5.52.20 L-W08 CCGT04T101L-W08						●	●	0.004	0.172	0.070	0.091		
		CCGT 5.52.20.5 R-W08 CCGT04T102R-W08						●	●	0.008	0.172	0.070	0.091		
		CCGT 5.52.20.5 L-W08 CCGT04T102L-W08						●	●	0.008	0.172	0.070	0.091		
		CCGT 5.52.21 R-W08 CCGT04T104R-W08						●	●	0.016	0.172	0.070	0.091		
		CCGT 5.52.21 L-W08 CCGT04T104L-W08						●	●	0.016	0.172	0.070	0.091		

● : Line up
▲ : To be discontinued

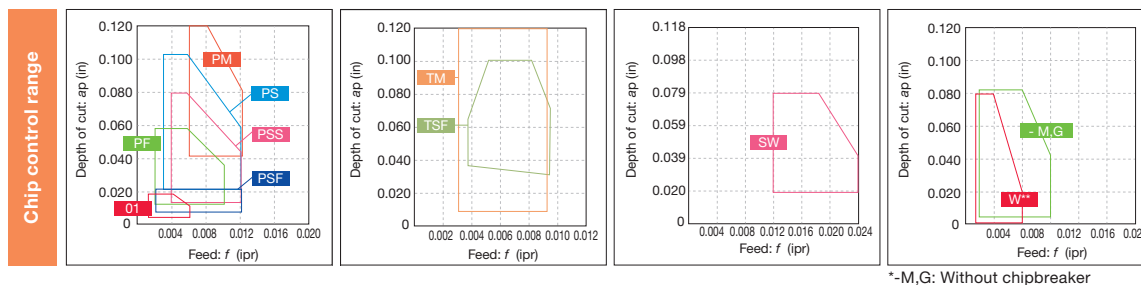

Reference pages: External toolholder → **C026** - Internal toolholder → **D020** -
J-Series toolholder → **G027** -

Insert POSITIVE TYPE

● : Continuous cutting
 ● : Light interrupted cutting
 ✦ : Heavy interrupted cutting

CC



Rhombic, 80°
with hole
Positive 7°

	P Steel	M Stainless	K Cast iron	N Non-ferrous	S Superalloy	H Hard material								
	● ● ● ●	● ● ● ●	● ● ● ●	● ● ● ●	● ● ● ●	● ● ● ●	● ● ● ●	● ● ● ●	● ● ● ●	● ● ● ●	● ● ● ●	● ● ● ●	● ● ● ●	● ● ● ●

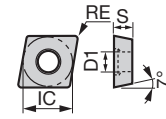

Application	Chipbreaker	Designation		Coated		Cermet		Uncoated		Dimension (inch)			
		Inch	Metric	T5115 GH110 SH725	NS9530	TH10 KS05F				RE	IC	S	D1
Finishing to medium cutting		AL	CCGT 21.50 AL	CCGT060201-AL		●		●		0.004	0.250	0.094	0.110
			CCGT 21.50.5 AL	CCGT060202-AL		●		●		0.008	0.250	0.094	0.110
			CCGT 21.51 AL	CCGT060204-AL				●		0.016	0.250	0.094	0.110
			CCGT 32.50 AL	CCGT09T301-AL				●		0.004	0.375	0.156	0.173
			CCGT 32.50.5 AL	CCGT09T302-AL		●		●		0.008	0.375	0.156	0.173
			CCGT 32.51 AL	CCGT09T304-AL		●		●		0.016	0.375	0.156	0.173
			CCGT 32.52 AL	CCGT09T308-AL				●		0.031	0.375	0.156	0.173
			CCGT 430.5 AL	CCGT120402-AL				●		0.008	0.500	0.187	0.217
			CCGT 431 AL	CCGT120404-AL				●		0.016	0.500	0.187	0.217
			CCGT 432 AL	CCGT120408-AL				●		0.031	0.500	0.187	0.217
			All-round	CCGT 21.50.5	CCGT060202		●			0.008	0.250	0.094	0.110
				CCGT 21.51	CCGT060204		●			0.016	0.250	0.094	0.110
				CCGT 32.50.5	CCGT09T302		●			0.008	0.375	0.156	0.173
		CCGT 32.51	CCGT09T304		●			0.016	0.375	0.156	0.173		
		CCGT 32.52	CCGT09T308		●			0.031	0.375	0.156	0.173		
	Angular	CCGT 21.5V R	CCGT060200R				●	0.001	0.250	0.094	0.110		
		CCGT 21.50.5 R	CCGT060202R				●	0.008	0.250	0.094	0.110		
		CCGT 21.50.5 L	CCGT060202L				●	0.008	0.250	0.094	0.110		
		CCGT 21.51 L	CCGT060204L				●	0.016	0.250	0.094	0.110		
		CCGT 32.50.5 R	CCGT09T302R				●	0.008	0.375	0.156	0.173		
		CCGT 32.50.5 L	CCGT09T302L				●	0.008	0.375	0.156	0.173		
		CCGT 32.51 R	CCGT09T304R				●	0.016	0.375	0.156	0.173		
		CCGT 32.51 L	CCGT09T304L				●	0.016	0.375	0.156	0.173		
	-	CCMW 21.51	CCMW060204	●				0.016	0.250	0.094	0.110		
		CCMW 21.52	CCMW060208	●				0.031	0.250	0.094	0.110		
		CCMW 32.51	CCMW09T304	●				0.016	0.375	0.156	0.173		
		CCMW 32.52	CCMW09T308	●				0.031	0.375	0.156	0.173		
	-	CCGW 21.50.5	CCGW060202				●	0.008	0.250	0.094	0.110		
		CCGW 21.51	CCGW060204				●	0.016	0.250	0.094	0.110		
		CCGW 32.51	CCGW09T304	●			●	0.016	0.375	0.156	0.173		

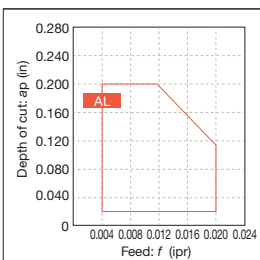
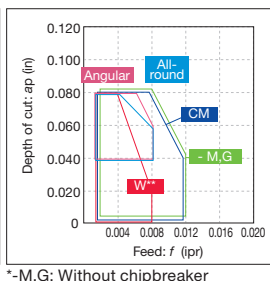
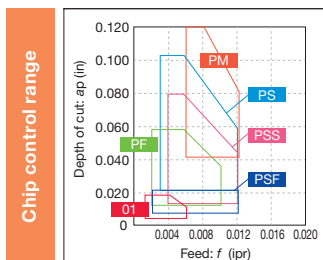

● : Line up

Reference pages: External toolholder → C026 - Internal toolholder → D020 -
 J-Series toolholder → G027 -

Grade
 Insert
 Ext. Toolholder
 Int. Toolholder
 Threading
 Grooving
 Milling Cutter
 Miniature Tool
 Endmill
 Drilling Tool
 Tooling System
 User's Guide
 Index



Insert POSITIVE TYPE

- : Continuous cutting
- ◐ : Light interrupted cutting
- ◑ : Heavy interrupted cutting

CC



**Rhombic, 80°
with hole
Positive 7°**

P	Steel	●●●●			●●															
M	Stainless	●●●●																		
K	Cast iron				●●															
N	Non-ferrous																			
S	Superalloy																			
H	Hard material																			

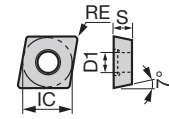

Application	Chipbreaker	Designation		Coated			Cermet			Uncoated			Dimension (inch)						
		Inch	Metric	SH725 J740		NS9530			TH10			RE	IC	S	D1				
For external turning on Swiss lathes (sharp edge)		J10	CCGT 21.5V FR-J10	CCGT060200FR-J10	●	●								0.001	0.250	0.094	0.110		
			CCGT 21.5V FL-J10	CCGT060200FL-J10	●	●									0.001	0.250	0.094	0.110	
			CCGT 21.50 FR-J10	CCGT060201FR-J10	●	●			●						0.004	0.250	0.094	0.110	
			CCGT 21.50 FL-J10	CCGT060201FL-J10	●	●									0.004	0.250	0.094	0.110	
			CCGT 21.50.5 FR-J10	CCGT060202FR-J10	●	●			●						0.008	0.250	0.094	0.110	
			CCGT 21.50.5 FL-J10	CCGT060202FL-J10	●	●			●						0.008	0.250	0.094	0.110	
			CCGT 32.5V FR-J10	CCGT09T300FR-J10	●	●										0.001	0.375	0.156	0.173
			CCGT 32.5V FL-J10	CCGT09T300FL-J10	●	●										0.001	0.375	0.156	0.173
			CCGT 32.50 FR-J10	CCGT09T301FR-J10	●	●										0.004	0.375	0.156	0.173
			CCGT 32.50 FL-J10	CCGT09T301FL-J10	●	●										0.004	0.375	0.156	0.173
			CCGT 32.50.5 FR-J10	CCGT09T302FR-J10	●	●										0.008	0.375	0.156	0.173
			CCGT 32.50.5 FL-J10	CCGT09T302FL-J10	●	●										0.008	0.375	0.156	0.173
			CCGT 32.51 FR-J10	CCGT09T304FR-J10	●											0.016	0.375	0.156	0.173

● : Line up

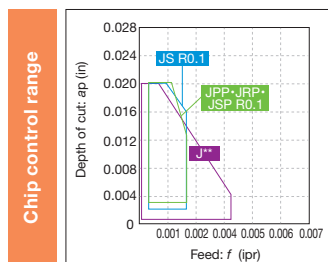

*Chip control range with typical R0.1

Reference pages: External toolholder → **C026** - Internal toolholder → **D020** -
J-Series toolholder → **G027** -



Insert POSITIVE TYPE

- : Continuous cutting
- ◐ : Light interrupted cutting
- ◑ : Heavy interrupted cutting

CP

Rhombic, 80°
with hole
Positive 11°

P	Steel	●	◐	◑	●	◐	◑	●	◐	◑	●	◐	◑
M	Stainless	●	◐					●	◐	◑	●	◐	◑
K	Cast iron	●	◐		●		●	◐	◑	●	◐	◑	
N	Non-ferrous	●	◐					●	◐	◑	●	◐	◑
S	Superalloy												
H	Hard material												

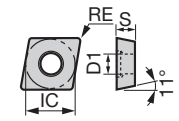

Application	Chipbreaker	Designation	Coated			Cermet		Uncoated		Dimension (inch)			
			T9215	T9225	T9115	T9125	NS9530	TH10	RE	IC	S	D1	
		Inch	Metric										
Medium cutting		24 CPMT 2.51.51-24	CPMT080204-24	●	▲					0.016	0.313	0.094	0.134
		CPMT 2.51.52-24	CPMT080208-24	●	▲					0.031	0.313	0.094	0.134
		CPMT 322-24	CPMT090308-24	●	▲					0.031	0.375	0.125	0.173
		CPMT 432-24	CPMT120408-24			●				0.031	0.500	0.187	0.217
		CPMT 53.52-24	CPMT160508-24	●	▲	●				0.031	0.625	0.219	0.217
		CPMT 53.53-24	CPMT160512-24			●				0.047	0.625	0.219	0.217
Finishing		W15 CPGT 730.5 L-W15	CPGT050202L-W15			●				0.008	0.219	0.094	0.098
		CPGT 731 L-W15	CPGT050204L-W15			●				0.016	0.219	0.094	0.098
		CPGT 2.51.50.5 R-W15	CPGT080202R-W15					●		0.008	0.313	0.094	0.134
		CPGT 2.51.50.5 L-W15	CPGT080202L-W15			●		●		0.008	0.313	0.094	0.134
		CPGT 2.51.51 R-W15	CPGT080204R-W15					●		0.016	0.313	0.094	0.134
		CPGT 2.51.51 L-W15	CPGT080204L-W15			●		●		0.016	0.313	0.094	0.134
		W20 CPGT 320.5 R-W20	CPGT090302R-W20			●		●		0.008	0.375	0.125	0.173
		CPGT 320.5 L-W20	CPGT090302L-W20			●		●		0.008	0.375	0.125	0.173
CPGT 321 R-W20	CPGT090304R-W20			●		●		0.016	0.375	0.125	0.173		
CPGT 321 L-W20	CPGT090304L-W20			●		●		0.016	0.375	0.125	0.173		

- : Line up
- ▲ : To be discontinued

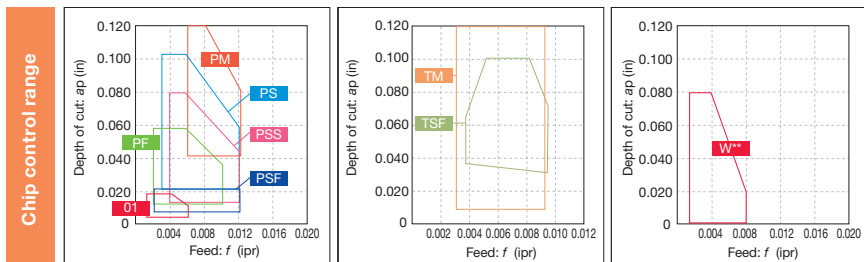

Reference pages: Internal toolholder → **D025 -**

Grade A
Insert B
Toolholder C
Int. Toolholder D
Threading E
Grooving F
Miniature Tool G
Milling Cutter H
Endmill I
Drilling Tool J
Tooling System K
User's Guide L
Index M

Negative

Positive

PCD / CBN

C

D

G

R

S

T

V

W

Y

OTHERS

Insert POSITIVE TYPE

- : Continuous cutting
- ◐ : Light interrupted cutting
- ⊛ : Heavy interrupted cutting

CP

**Rhombic, 80° with hole
Positive 11°**

P	Steel	●	●	●	●	●	●	●	●	●	●	●	●	●	●	●	●	●	●	●	●
M	Stainless	●	●	●	●	●	●	●	●	●	●	●	●	●	●	●	●	●	●	●	●
K	Cast iron	●	●	●	●	●	●	●	●	●	●	●	●	●	●	●	●	●	●	●	●
N	Non-ferrous	●	●	●	●	●	●	●	●	●	●	●	●	●	●	●	●	●	●	●	●
S	Superalloy	●	●	●	●	●	●	●	●	●	●	●	●	●	●	●	●	●	●	●	●
H	Hard material	●	●	●	●	●	●	●	●	●	●	●	●	●	●	●	●	●	●	●	●

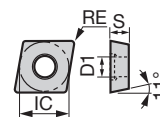

Application	Chipbreaker	Designation	Coated												Cermet	Dimension (inch)						
			T9225	T9105	T9125	T6120	T6130	AH630	AH645	T515	T5115	AH725	AH8005	AH8015		AH905	NS9530	RE	IC	S	D1	
Medium cutting		PM CPMT 21.51 PM CPMT060204-PM	●	●	●	●	●	●	●	●	●	●	●	●	●	●	●	●	●	●	●	
		CPMT 21.52 PM CPMT060208-PM	●	▲	●	●	●	●	●	●	●	●	●	●	●	●	●	●	●	●	●	●
		CPMT 321 PM CPMT090304-PM	●	▲	●	●	●	●	●	●	●	●	●	●	●	●	●	●	●	●	●	●
		CPMT 322 PM CPMT090308-PM	●	▲	●	●	●	●	●	●	●	●	●	●	●	●	●	●	●	●	●	●
Finishing to medium cutting		CM CPMT 21.51 CM CPMT060204-CM									●											
		CPMT 21.52 CM CPMT060208-CM									●											
		CPMT 2.51.51 CM CPMT080204-CM									●											
		CPMT 2.51.52 CM CPMT080208-CM									●											
		CPMT 321 CM CPMT090304-CM									●	●										
		CPMT 322 CM CPMT090308-CM									●	●										
		CPMT 32.51 CM CPMT09T304-CM									●	●										
		CPMT 32.52 CM CPMT09T308-CM									●	●										
		CPMT 32.53 CM CPMT09T312-CM										●										
		CPMT 432 CM CPMT120408-CM										●										
CPMT 433 CM CPMT120412-CM										●												
Medium cutting		All-round CPMT 432 CPMT120408									●	●	●									
		- CPMW 2.51.51 CPMW080204										●										
		CPMW 2.51.52 CPMW080208										●										
		CPMW 321 CPMW090304			▲							●										
CPMW 322 CPMW090308										●												

- : Line up
- ▲ : To be discontinued

Reference pages: Internal toolholder → **D025 -**

Insert POSITIVE TYPE

- : Continuous cutting
- ◐ : Light interrupted cutting
- ⊛ : Heavy interrupted cutting

DC

Rhombic, 55°
with hole
Positive 7°



Material	Steel	Stainless	Cast iron	Non-ferrous	Superalloy	Hard material
P	●●◐●●	●●	●●	●●	●●	●●
M	●●	●●	●●	●●	●●	●●
K	●●	●●	●●	●●	●●	●●
N	●●	●●	●●	●●	●●	●●
S	●●	●●	●●	●●	●●	●●
H						

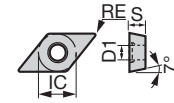

Application	Chipbreaker		Designation		Coated								Coated cermet		Cermet	Dimension (inch)						
			Inch	Metric	T9215	T9225	T9115	T9125	AH725	AH8005	AH8015	AH905	GH730	SH725	J740	GT9530	J9530	NS9530	RE	IC	S	D1
	Precision finishing	01	DCGT 21.50.5-01	DCGT070202-01																0.008	0.250	0.094
		DCGT 32.50.5-01	DCGT11T302-01											●					0.008	0.375	0.156	0.173
Precision finishing (sharp edge)	01	DCGT 21.50.5 F-01	DCGT070202F-01											●					<0.008	0.250	0.094	0.110
		DCGT 21.51 F-01	DCGT070204F-01											●					<0.016	0.250	0.094	0.110
		DCGT 32.50.5 F-01	DCGT11T302F-01											●					<0.008	0.375	0.156	0.173
		DCGT 32.51 F-01	DCGT11T304F-01											●					<0.016	0.375	0.156	0.173
Finishing	PSF	DCMT 21.50.5 PSF	DCMT070202-PSF					●								●	●	0.008	0.250	0.094	0.110	
		DCMT 21.51 PSF	DCMT070204-PSF	●●▲▲													●	●	0.016	0.250	0.094	0.110
		DCMT 32.50.5 PSF	DCMT11T302-PSF														●	●	0.008	0.375	0.156	0.173
		DCMT 32.51 PSF	DCMT11T304-PSF	●●▲▲●●●●													●	●	0.016	0.375	0.156	0.173
		DCMT 32.52 PSF	DCMT11T308-PSF	●●▲▲●●●●													●	●	0.031	0.375	0.156	0.173
		PF	DCMT 21.50.5 PF	DCMT070202-PF										●			●	●	0.008	0.250	0.094	0.110
			DCMT 21.51 PF	DCMT070204-PF										●			●	●	0.016	0.250	0.094	0.110
		DCMT 21.52 PF	DCMT070208-PF													●	●	0.031	0.250	0.094	0.110	
		DCMT 32.50.5 PF	DCMT11T302-PF										●			●	●	0.008	0.375	0.156	0.173	
		DCMT 32.51 PF	DCMT11T304-PF										●			●	●	0.016	0.375	0.156	0.173	
		DCMT 32.52 PF	DCMT11T308-PF													●	●	0.031	0.375	0.156	0.173	

*Corner radius (RE) with a sign of inequality (<) means minus tolerance.

- : Line up
- ▲ : To be discontinued

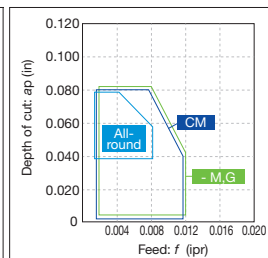
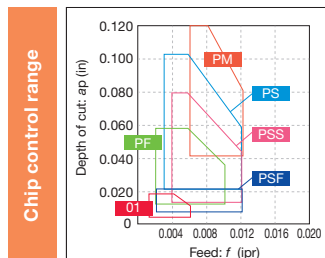

*-M,G: Without chipbreaker

Reference pages: External toolholder → C050 - Internal toolholder → D056 -
J-Series toolholder → G036 -

Insert POSITIVE TYPE

● : Continuous cutting
 ◐ : Light interrupted cutting
 ✳ : Heavy interrupted cutting

DC

Rhombic, 55°
with hole
Positive 7°

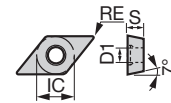

P	Steel	●	●	●	●	●	●	●	●	●	●	●	●	●	●	●	●	●	●	●	●	●	●
M	Stainless	●	●	●	●	●	●	●	●	●	●	●	●	●	●	●	●	●	●	●	●	●	●
K	Cast iron	●	●	●	●	●	●	●	●	●	●	●	●	●	●	●	●	●	●	●	●	●	●
N	Non-ferrous	●	●	●	●	●	●	●	●	●	●	●	●	●	●	●	●	●	●	●	●	●	●
S	Superalloy	●	●	●	●	●	●	●	●	●	●	●	●	●	●	●	●	●	●	●	●	●	●
H	Hard material	●	●	●	●	●	●	●	●	●	●	●	●	●	●	●	●	●	●	●	●	●	●

Application	Chipbreaker	Designation	Coated														Coated cermet	Cermet	Uncoated	Dimension (inch)							
			Inch		Metric		T9215	T9225	T9115	T9125	T6120	T6130	AH630	AH645	T515	T5115	AH120	AH725	GH330	GH730	GT9530	NS9530	TH10	RE	IC	S	D1
			Finishing	W10	DCGT 21.5V R-W10	DCGT070200R-W10																		●	●	0.001	0.250
		DCGT 21.5V R-W10	DCGT070200L-W10																			●	●	0.001	0.250	0.094	0.110
		DCGT 21.50.5 R-W10	DCGT070202R-W10																			●	●	0.008	0.250	0.094	0.110
		DCGT 21.50.5 L-W10	DCGT070202L-W10																	●	●	●	●	0.008	0.250	0.094	0.110
		DCGT 21.51 R-W10	DCGT070204R-W10															●				●	●	0.016	0.250	0.094	0.110
		DCGT 21.51 L-W10	DCGT070204L-W10															●				●	●	0.016	0.250	0.094	0.110
Finishing	W15	DCGT 32.50.5 R-W15	DCGT11T302R-W15																			●	●	0.008	0.375	0.156	0.173
		DCGT 32.50.5 L-W15	DCGT11T302L-W15																			●	●	0.008	0.375	0.156	0.173
		DCGT 32.51 R-W15	DCGT11T304R-W15																			●	●	0.016	0.375	0.156	0.173
		DCGT 32.51 L-W15	DCGT11T304L-W15																			●	●	0.016	0.375	0.156	0.173
		DCGT 32.52 R-W15	DCGT11T308R-W15																			●	●	0.031	0.375	0.156	0.173
		DCGT 32.52 L-W15	DCGT11T308L-W15																			●	●	0.031	0.375	0.156	0.173
Medium cutting	PM	DCMT 21.51 PM	DCMT070204-PM	●	●	▲	▲	●	●	●	●	●	●			●	●	●	●	●	●	●	0.016	0.250	0.094	0.110	
		DCMT 21.52 PM	DCMT070208-PM	●	●	▲	▲	●	●	●	●	●	●			●	●	●	●	●	●	●	0.031	0.250	0.094	0.110	
		DCMT 32.51 PM	DCMT11T304-PM	●	●	▲	▲	●	●	●	●	●	●			●	●	●	●	●	●	●	0.016	0.375	0.156	0.173	
		DCMT 32.52 PM	DCMT11T308-PM	●	●	▲	▲	●	●	●	●	●	●			●	●	●	●	●	●	●	0.031	0.375	0.156	0.173	
		DCMT 32.53 PM	DCMT11T312-PM	●	●	▲	▲	●	●	●	●	●	●									●	●	0.047	0.375	0.156	0.173
Finishing to medium cutting	CM	DCMT 21.51 CM	DCMT070204-CM												●							●	0.016	0.250	0.094	0.110	
		DCMT 21.52 CM	DCMT070208-CM												●							●	0.031	0.250	0.094	0.110	
		DCMT 32.51 CM	DCMT11T304-CM												●	●						●	0.016	0.375	0.156	0.173	
		DCMT 32.52 CM	DCMT11T308-CM												●	●						●	0.031	0.375	0.156	0.173	
		DCMT 32.53 CM	DCMT11T312-CM												●							●	0.047	0.375	0.156	0.173	

● : Line up
 ▲ : To be discontinued

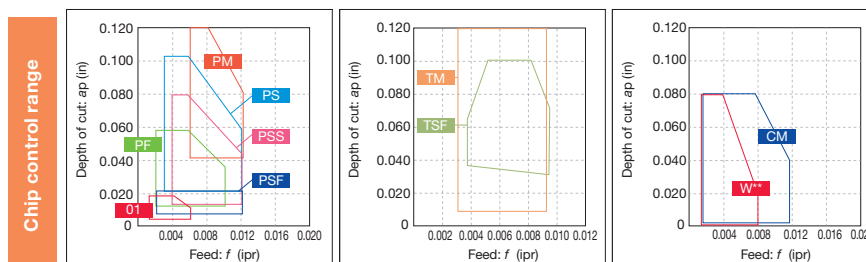

Reference pages: External toolholder → **C050 -** Internal toolholder → **D056 -**
 J-Series toolholder → **G036 -**



Negative
Positive

Insert POSITIVE TYPE

● : Continuous cutting
 ● : Light interrupted cutting
 * : Heavy interrupted cutting

DC

Rhombic, 55°
with hole
Positive 7°



P	Steel	●	●			●														
M	Stainless			●						●										
K	Cast iron	●	●	●		●				●		●								
N	Non-ferrous									●		●								
S	Superalloy			●								●								
H	Hard material																			

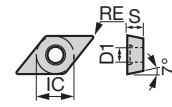

PCD / CBN

C

D

G

R

S

T

V

W

Y

OTHERS

Application	Chipbreaker	Designation		Coated			Cermet	Uncoated		Dimension (inch)				
		Inch	Metric	T9105	T5115	GH110	NS9530	TH10	KS05F	RE	IC	S	D1	
Finishing to medium cutting	AL	DCGT 21.50.5 AL	DCGT070202-AL						●		0.008	0.250	0.094	0.110
		DCGT 21.51 AL	DCGT070204-AL						●		0.016	0.250	0.094	0.110
		DCGT 32.50.5 AL	DCGT11T302-AL						●		0.008	0.375	0.156	0.173
		DCGT 32.51 AL	DCGT11T304-AL						●		0.016	0.375	0.156	0.173
		DCGT 32.52 AL	DCGT11T308-AL						●		0.031	0.375	0.156	0.173
	All-round	DCGT 21.50.5	DCGT070202				●				0.008	0.250	0.094	0.110
		DCGT 21.51	DCGT070204				●				0.016	0.250	0.094	0.110
		DCGT 32.50.5	DCGT11T302				●				0.008	0.375	0.156	0.173
		DCGT 32.51	DCGT11T304				●				0.016	0.375	0.156	0.173
		DCGT 32.52	DCGT11T308				●				0.031	0.375	0.156	0.173
	Angular	DCGT 21.50.5 R	DCGT070202R						●		0.008	0.250	0.094	0.110
		DCGT 21.50.5 L	DCGT070202L						●		0.008	0.250	0.094	0.110
		DCGT 21.51 R	DCGT070204R						●		0.016	0.250	0.094	0.110
		DCGT 21.51 L	DCGT070204L						●		0.016	0.250	0.094	0.110
		DCGT 32.50.5 R	DCGT11T302R						●		0.008	0.375	0.156	0.173
	DCGT 32.50.5 L	DCGT11T302L						●		0.008	0.375	0.156	0.173	
	DCGT 32.51 R	DCGT11T304R						●		0.016	0.375	0.156	0.173	
	DCGT 32.51 L	DCGT11T304L						●		0.016	0.375	0.156	0.173	
Medium cutting	-	DCMW 21.51	DCMW070204	▲	●						0.016	0.250	0.094	0.110
		DCMW 21.52	DCMW070208		●						0.031	0.250	0.094	0.110
		DCMW 32.51	DCMW11T304	▲	●						0.016	0.375	0.156	0.173
		DCMW 32.52	DCMW11T308		●						0.031	0.375	0.156	0.173
	-	DCGW 21.50.5	DCGW070202						●		0.008	0.250	0.094	0.110
		DCGW 21.51	DCGW070204			●			●		0.016	0.250	0.094	0.110
		DCGW 32.51	DCGW11T304						●		0.016	0.375	0.156	0.173
		DCGW 32.52	DCGW11T308						●		0.031	0.375	0.156	0.173

● : Line up
 ▲ : To be discontinued

Reference pages: External toolholder → C050 - Internal toolholder → D056 -
 J-Series toolholder → G036 -

Insert POSITIVE TYPE

- : Continuous cutting
- ◐ : Light interrupted cutting
- ◑ : Heavy interrupted cutting

DC

Rhombic, 55°
with hole
Positive 7°



Material	Steel	Stainless	Cast iron	Non-ferrous	Superalloy	Hard material
P	●●●●					
M		●●●●				
K			●			
N				●●●●		
S					●●	
H						●●

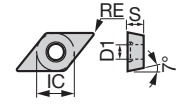

Application	Chipbreaker	Designation	Coated			Dimension (inch)							
			AH725	SH725	SH730	RE	IC	S	D1				
										Inch	Metric		
For external turning on Swiss lathes (sharp edge)			JS	DCGT 21.5V FN-JS	DCGT070200FN-JS	●	●			0.001	0.250	0.094	0.110
				DCGT 21.50 FN-JS	DCGT070201FN-JS	●	●			<0.004	0.250	0.094	0.110
				DCGT 21.50.5 FN-JS	DCGT070202FN-JS	●	●			<0.008	0.250	0.094	0.110
				DCGT 32.5V FN-JS	DCGT11T300FN-JS	●	●			0.001	0.375	0.156	0.173
				DCGT 32.50 FN-JS	DCGT11T301FN-JS	●	●			<0.004	0.375	0.156	0.173
				DCGT 32.50.5 FN-JS	DCGT11T302FN-JS	●	●			<0.008	0.375	0.156	0.173
				DCGT 32.51 FN-JS	DCGT11T304FN-JS	●	●			<0.016	0.375	0.156	0.173
For external turning on Swiss lathes			JS	DCGT 21.50 N-JS	DCGT070201N-JS	●				0.004	0.250	0.094	0.110
				DCGT 21.50.5 N-JS	DCGT070202N-JS	●				0.008	0.250	0.094	0.110
				DCGT 32.50 N-JS	DCGT11T301N-JS	●				0.004	0.375	0.156	0.173
				DCGT 32.50.5 N-JS	DCGT11T302N-JS	●				0.008	0.375	0.156	0.173
				DCGT 32.51 N-JS	DCGT11T304N-JS	●				0.016	0.375	0.156	0.173
For external turning on Swiss lathes (sharp edge)			JPP	DCET 21.5X MFR-JPP	DCET0702008MFR-JPP	●	●			<0.003	0.250	0.094	0.110
				DCET 21.5X MFL-JPP	DCET0702008MFL-JPP	●	●			<0.003	0.250	0.094	0.110
				DCET 21.50 MFR-JRP	DCET070201MFR-JPP	●	●			<0.004	0.250	0.094	0.110
				DCET 21.50 MFL-JRP	DCET070201MFL-JPP	●	●			<0.004	0.250	0.094	0.110
				DCET 21.50.4 MFR-JRP	DCET0702018MFR-JPP	●	●			<0.007	0.250	0.094	0.110
				DCET 21.50.4 MFL-JPP	DCET0702018MFL-JPP	●	●			<0.007	0.250	0.094	0.110
				DCET 21.50.5 MFR-JPP	DCET070202MFR-JPP	●	●			<0.008	0.250	0.094	0.110
				DCET 21.50.5 MFL-JPP	DCET070202MFL-JPP	●	●			<0.008	0.250	0.094	0.110
				DCET 32.5X MFR-JPP	DCET11T3008MFR-JPP	●	●			<0.003	0.375	0.156	0.173
				DCET 32.5X MFL-JPP	DCET11T3008MFL-JPP	●	●			<0.003	0.375	0.156	0.173
				DCET 32.50 MFR-JPP	DCET11T301MFR-JPP	●	●			<0.004	0.375	0.156	0.173
				DCET 32.50 MFL-JPP	DCET11T301MFL-JPP	●	●			<0.004	0.375	0.156	0.173
				DCET 32.50.4 MFR-JPP	DCET11T3018MFR-JPP	●	●			<0.007	0.375	0.156	0.173
				DCET 32.50.4 MFL-JPP	DCET11T3018MFL-JPP	●	●			<0.007	0.375	0.156	0.173
				DCET 32.50.5 MFR-JPP	DCET11T302MFR-JPP	●	●			<0.008	0.375	0.156	0.173
				DCET 32.50.5 MFL-JPP	DCET11T302MFL-JPP	●	●			<0.008	0.375	0.156	0.173

*Corner radius (RE) with a sign of inequality (<) means minus tolerance.

● : Line up

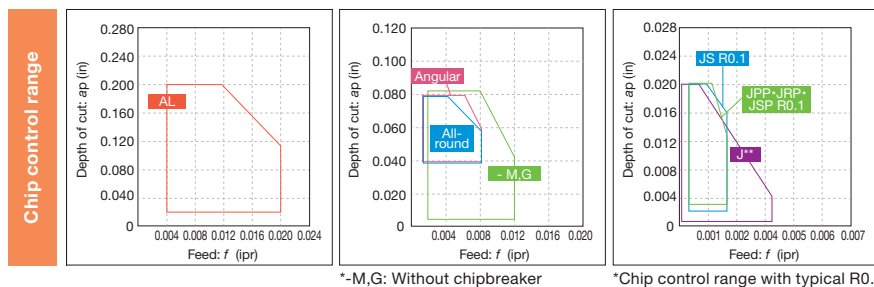

*-M,G: Without chipbreaker

*Chip control range with typical R0.1

Reference pages: External toolholder → **C050 -** Internal toolholder → **D056 -**
J-Series toolholder → **G036 -**



Insert POSITIVE TYPE

- : Continuous cutting
- ◐ : Light interrupted cutting
- * : Heavy interrupted cutting

DC



Rhombic, 55°
with hole
Positive 7°

P	Steel	●●●●●●				●●		●●		●●		●			
M	Stainless	●●●●●●													●
K	Cast iron	●●●●●●				●●		●●		●●		●			
N	Non-ferrous														●
S	Superalloy	●●													
H	Hard material														

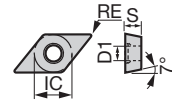

Application	Chipbreaker	Designation	Coated				Coated cermet	Cermet	Uncoated	Dimension (inch)				
			Inch		Metric		J9530	NS9530	TH10	RE	IC	S	D1	
			SH725	SH730	J740									
For external turning on Swiss lathes (sharp edge)	JRP	DCET 21.5X MFR-JRP	DCET0702008MFR-JRP	●●						<0.003	0.250	0.094	0.110	
		DCET 21.5X MFL-JRP	DCET0702008MFL-JRP	●●						<0.003	0.250	0.094	0.110	
	DCET 21.50 MFR-JRP	DCET070201MFR-JRP	●●							<0.004	0.250	0.094	0.110	
	DCET 21.50 MFL-JRP	DCET070201MFL-JRP	●●							<0.004	0.250	0.094	0.110	
	DCET 21.50.4 MFR-JRP	DCET0702018MFR-JRP	●●							<0.007	0.250	0.094	0.110	
	DCET 21.50.4 MFL-JRP	DCET0702018MFL-JRP	●●							<0.007	0.250	0.094	0.110	
	DCET 21.50.5 MFR-JRP	DCET070202MFR-JRP	●●							<0.008	0.250	0.094	0.110	
	DCET 21.50.5 MFL-JRP	DCET070202MFL-JRP	●●							<0.008	0.250	0.094	0.110	
	DCET 32.5X MFR-JRP	DCET11T3008MFR-JRP	●●							<0.003	0.375	0.156	0.173	
	DCET 32.5X MFL-JRP	DCET11T3008MFL-JRP	●●							<0.003	0.375	0.156	0.173	
	DCET 32.50 MFR-JRP	DCET11T301MFR-JRP	●●							<0.004	0.375	0.156	0.173	
	DCET 32.50 MFL-JRP	DCET11T301MFL-JRP	●●							<0.004	0.375	0.156	0.173	
	DCET 32.50.4 MFR-JRP	DCET11T3018MFR-JRP	●●							<0.007	0.375	0.156	0.173	
	DCET 32.50.4 MFL-JRP	DCET11T3018MFL-JRP	●●							<0.007	0.375	0.156	0.173	
	DCET 32.50.5 MFR-JRP	DCET11T302MFR-JRP	●●							<0.008	0.375	0.156	0.173	
	DCET 32.50.5 MFL-JRP	DCET11T302MFL-JRP	●●							<0.008	0.375	0.156	0.173	
	For external turning on Swiss lathes (sharp edge)	JSP	DCET 21.5X MFN-JSP	DCET0702008MFN-JSP	●●						<0.003	0.250	0.094	0.110
DCET 21.50 MFN-JSP			DCET070201MFN-JSP	●●						<0.004	0.250	0.094	0.110	
DCET 21.50.4 MFN-JSP		DCET0702018MFN-JSP	●●							<0.007	0.250	0.094	0.110	
DCET 21.50.5 MFN-JSP		DCET070202MFN-JSP	●●							<0.008	0.250	0.094	0.110	
DCET 32.5X MFN-JSP		DCET11T3008MFN-JSP	●●							<0.003	0.375	0.156	0.173	
DCET 32.50 MFN-JSP		DCET11T301MFN-JSP	●●							<0.004	0.375	0.156	0.173	
DCET 32.50.4 MFN-JSP		DCET11T3018MFN-JSP	●●							<0.007	0.375	0.156	0.173	
DCET 32.50.5 MFN-JSP		DCET11T302MFN-JSP	●●							<0.008	0.375	0.156	0.173	
For external turning on Swiss lathes (honed edge)		J10	DCGT 21.5V FR-J10	DCGT070200FR-J10	●●	●				●	0.001	0.250	0.094	0.110
			DCGT 21.5V FL-J10	DCGT070200FL-J10	●●	●				●	0.001	0.250	0.094	0.110
	DCGT 21.50 FR-J10	DCGT070201FR-J10	●●	●				●	0.004	0.250	0.094	0.110		
	DCGT 21.50 FL-J10	DCGT070201FL-J10	●●	●			●	●	0.004	0.250	0.094	0.110		
	DCGT 21.50.5 FR-J10	DCGT070202FR-J10	●●	●			●	●	0.008	0.250	0.094	0.110		
	DCGT 21.50.5 FL-J10	DCGT070202FL-J10	●●	●			●	●	0.008	0.250	0.094	0.110		
	DCGT 21.51 FR-J10	DCGT070204FR-J10	●●						0.016	0.250	0.094	0.110		
	DCGT 21.51 FL-J10	DCGT070204FL-J10	●●						0.016	0.250	0.094	0.110		
	DCGT 32.5V FR-J10	DCGT11T300FR-J10	●●	●					●	0.001	0.375	0.156	0.173	
	DCGT 32.5V FL-J10	DCGT11T300FL-J10	●●	●					●	0.001	0.375	0.156	0.173	
	DCGT 32.50 FR-J10	DCGT11T301FR-J10	●●	●			●	●	0.004	0.375	0.156	0.173		
	DCGT 32.50 FL-J10	DCGT11T301FL-J10	●●	●			●	●	0.004	0.375	0.156	0.173		
	DCGT 32.50.5 FR-J10	DCGT11T302FR-J10	●●	●			●	●	0.008	0.375	0.156	0.173		
	DCGT 32.50.5 FL-J10	DCGT11T302FL-J10	●●	●			●	●	0.008	0.375	0.156	0.173		
	For external turning on Swiss lathes (honed edge)	J10	DCGT 21.50.5 R-J10	DCGT070202R-J10			●				0.008	0.250	0.094	0.110
			DCGT 32.50.5 R-J10	DCGT11T302R-J10			●				0.008	0.375	0.156	0.173

*Corner radius (RE) with a sign of inequality (<) means minus tolerance.

● : Line up

Reference pages: External toolholder → C050 - Internal toolholder → D056 -
 J-Series toolholder → G036 -

Insert POSITIVE TYPE

- : Continuous cutting
- ◐ : Light interrupted cutting
- ◑ : Heavy interrupted cutting

DP

Rhombic, 55°
with hole
Positive 11°



	P Steel	M Stainless	K Cast iron	N Non-ferrous	S Superalloy	H Hard material
●	●	●	●	●	●	●
◐	◐	◐	◐	◐	◐	◐
◑	◑	◑	◑	◑	◑	◑

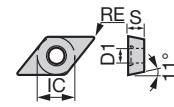

Application	Chipbreaker	Designation		Coated			Cermet			Dimension (inch)				
		Inch	Metric	T9225	T9125	AH8015	NS9530				RE	IC	S	D1
Finishing to medium cutting 70°		PS	DPMT 21.50.5 PS	DPMT070202-PS	● ▲ ●	●	●				0.008	0.250	0.094	0.110
			DPMT 21.51 PS	DPMT070204-PS	● ▲ ●	●	●				0.016	0.250	0.094	0.110
			DPMT 21.52 PS	DPMT070208-PS	● ▲ ●	●	●				0.031	0.250	0.094	0.110

- : Line up
- ▲ : To be discontinued

Insert POSITIVE TYPE / DOUBLE SIDE

- : Continuous cutting
- ◐ : Light interrupted cutting
- ◑ : Heavy interrupted cutting

DX

Rhombic, 55°
with hole



	P Steel	M Stainless	K Cast iron	N Non-ferrous	S Superalloy	H Hard material
●	●	●	●	●	●	●
◐	◐	◐	◐	◐	◐	◐
◑	◑	◑	◑	◑	◑	◑

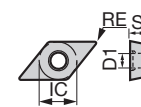

Application	Chipbreaker	Designation		Coated			Dimension (inch)						
		Inch	Metric	SH725					RE	IC	S	D1	
Finishing (sharp edge) 25°		JRP	DXGU 220MFRE JRP	DXGU070301MFRE-JRP	●					<0.004	0.250	0.125	0.106
			DXGU 220MFLE JRP	DXGU070301MFLE-JRP	●					<0.004	0.250	0.125	0.106
			DXGU 220.5MFRE JRP	DXGU070302MFRE-JRP	●					<0.008	0.250	0.125	0.106
			DXGU 220.5MFLE JRP	DXGU070302MFLE-JRP	●					<0.008	0.250	0.125	0.106
Finishing to medium cutting (sharp edge) 70°		JS	DXGU 220MFR JS	DXGU070301MFR-JS	●					<0.004	0.250	0.125	0.106
			DXGU 220MFL JS	DXGU070301MFL-JS	●					<0.004	0.250	0.125	0.106
			DXGU 220.5MFR JS	DXGU070302MFR-JS	●					<0.008	0.250	0.125	0.106
			DXGU 220.5MFL JS	DXGU070302MFL-JS	●					<0.008	0.250	0.125	0.106
			DXGU 221MFR JS	DXGU070304MFR-JS	●					<0.016	0.250	0.125	0.106
			DXGU 221MFL JS	DXGU070304MFL-JS	●					<0.016	0.250	0.125	0.106

*Corner radius (RE) with a sign of inequality (<) means minus tolerance.

- : Line up

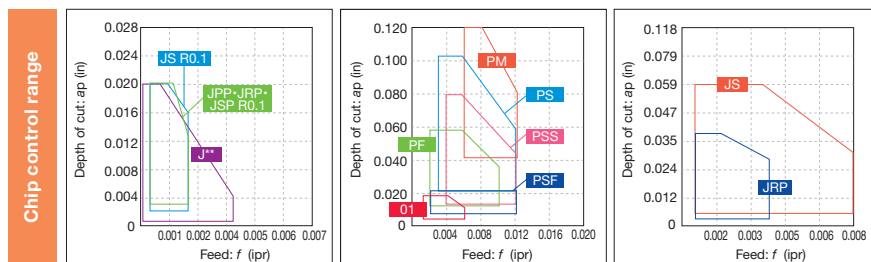

*Chip control range with typical R0.1

Reference pages: DPMT...: Internal toolholder → D059 -

DXGU...: External toolholder → C042 -, Internal toolholder → D042 -

Insert POSITIVE TYPE / DOUBLE SIDE

- : Continuous cutting
- c : Light interrupted cutting
- ⊛ : Heavy interrupted cutting

DX

**Rhombic, 55°
with hole**

P	Steel	●	●c	●c				●c				
M	Stainless	●	●c	●c								
K	Cast iron	●			●c			●c			●	
N	Non-ferrous										●	
S	Superalloy	●	●c								●	
H	Hard material											

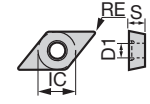

Application	Chipbreaker	Designation		Coated		Coated cermet		Cermet	Uncoated	Dimension (inch)			
		Inch	Metric	AH725	AH8015	SH725	GT9530	NS9530	KS05F	RE	IC	S	D1
Finishing to medium cutting (sharp edge)		JTS	DXGU 220MFR JTS	DXGU070301MFR-JTS		●				<0.004	0.250	0.125	0.106
			DXGU 220MFL JTS	DXGU070301MFL-JTS		●				<0.004	0.250	0.125	0.106
			DXGU 220.5MFR JTS	DXGU070302MFR-JTS		●				<0.008	0.250	0.125	0.106
			DXGU 220.5MFL JTS	DXGU070302MFL-JTS		●				<0.008	0.250	0.125	0.106
Finishing to medium cutting		JTS	DXGU 220MR JTS	DXGU070301MR-JTS	●					<0.004	0.250	0.125	0.106
			DXGU 220ML JTS	DXGU070301ML-JTS	●					<0.004	0.250	0.125	0.106
			DXGU 220.5MR JTS	DXGU070302MR-JTS	●					<0.008	0.250	0.125	0.106
			DXGU 220.5ML JTS	DXGU070302ML-JTS	●					<0.008	0.250	0.125	0.106
Finishing (low cutting force) (sharp edge)		JSS	DXGU 220MFR JSS	DXGU070301MFR-JSS			●			<0.004	0.250	0.125	0.106
			DXGU 220MFL JSS	DXGU070301MFL-JSS			●			<0.004	0.250	0.125	0.106
			DXGU 220.5MFR JSS	DXGU070302MFR-JSS			●			<0.008	0.250	0.125	0.106
			DXGU 220.5MFL JSS	DXGU070302MFL-JSS			●			<0.008	0.250	0.125	0.106
Finishing (low cutting force)		JSS	DXGU 220MR JSS	DXGU070301MR-JSS	●					<0.004	0.250	0.125	0.106
			DXGU 220ML JSS	DXGU070301ML-JSS	●					<0.004	0.250	0.125	0.106
			DXGU 220.5MR JSS	DXGU070302MR-JSS	●					<0.008	0.250	0.125	0.106
			DXGU 220.5ML JSS	DXGU070302ML-JSS	●					<0.008	0.250	0.125	0.106
Finishing to medium cutting		TS	DXGU 220.5R TS	DXGU070302R-TS	●	●		●	●	0.008	0.250	0.125	0.106
			DXGU 220.5L TS	DXGU070302L-TS	●	●		●	●	0.008	0.250	0.125	0.106
			DXGU 221R TS	DXGU070304R-TS	●	●		●	●	0.016	0.250	0.125	0.106
			DXGU 221L TS	DXGU070304L-TS	●	●		●	●	0.016	0.250	0.125	0.106
			DXGU 222R TS	DXGU070308R-TS	●	●		●	●	0.031	0.250	0.125	0.106
			DXGU 222L TS	DXGU070308L-TS	●	●		●	●	0.031	0.250	0.125	0.106
Finishing (low cutting force)		SS	DXGU 220.5R SS	DXGU070302R-SS	●	●		●	●	0.008	0.250	0.125	0.106
			DXGU 220.5L SS	DXGU070302L-SS	●	●		●	●	0.008	0.250	0.125	0.106
			DXGU 221R SS	DXGU070304R-SS	●	●		●	●	0.016	0.250	0.125	0.106
			DXGU 221L SS	DXGU070304L-SS	●	●		●	●	0.016	0.250	0.125	0.106

*Corner radius (RE) with a sign of inequality (<) means minus tolerance.

● : Line up

Insert POSITIVE TYPE

● : Continuous cutting
 ● : Light interrupted cutting
 ✱ : Heavy interrupted cutting

EP



Rhombic, 75°
with hole
Positive 11°

P	Steel	●●●●●																		
M	Stainless	●●●●●																		
K	Cast iron																			
N	Non-ferrous																			
S	Superalloy	●●																		
H	Hard material																			

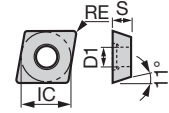

Application	Chipbreaker		Designation	Coated			Dimension (inch)			
	Inch	Metric		SH725	SH730	J740	RE	IC	S	D1
For internal turning on Swiss lathes	JS	EPGT 4.51.80 JS	EPGT03X101-JS	●			<0.004	0.141	0.055	0.075
		EPGT 4.51.80.5 JS	EPGT03X102-JS	●			<0.008	0.141	0.055	0.075
		EPGT 4.51.81 JS	EPGT03X104-JS	●			<0.016	0.141	0.055	0.075
		EPGT 520 JS	EPGT040101-JS	●			<0.004	0.156	0.063	0.091
		EPGT 520.5 JS	EPGT040102-JS	●			<0.008	0.156	0.063	0.091
		EPGT 521 JS	EPGT040104-JS	●			<0.016	0.156	0.063	0.091
For internal turning on Swiss lathes (sharp edge)	JS	EPGT 4.51.80 F-JS	EPGT03X101F-JS	●			<0.004	0.141	0.055	0.075
		EPGT 4.51.80.5 F-JS	EPGT03X102F-JS	●			<0.008	0.141	0.055	0.075
		EPGT 4.51.81 F-JS	EPGT03X104F-JS	●			<0.016	0.141	0.055	0.075
		EPGT 520 F-JS	EPGT040101F-JS	●			<0.004	0.156	0.063	0.091
		EPGT 520.5 F-JS	EPGT040102F-JS	●			<0.008	0.156	0.063	0.091
		EPGT 521 F-JS	EPGT040104F-JS	●			<0.016	0.156	0.063	0.091
Finishing	J08	EPGT 52V L-J08	EPGT040100L-J08	●	●		0.001	0.156	0.063	0.091
		EPGT 520.5 L-J08	EPGT040102L-J08	●	●		0.008	0.156	0.063	0.091
		EPGT 521 L-J08	EPGT040104L-J08	●	●		0.016	0.156	0.063	0.091
Finishing (sharp edge)	J08	EPGT 52V FL-J08	EPGT040100FL-J08	●			0.001	0.156	0.063	0.091
		EPGT 520.5 FL-J08	EPGT040102FL-J08	●			0.008	0.156	0.063	0.091
		EPGT 521 FL-J08	EPGT040104FL-J08	●			0.016	0.156	0.063	0.091

*Corner radius (RE) with a sign of inequality (<) means minus tolerance.

● : Line up

Reference pages: Internal toolholder → **D040** -

Insert POSITIVE TYPE

- : Continuous cutting
- ◐ : Light interrupted cutting
- ◑ : Heavy interrupted cutting

RC



Round,
with hole
Positive 7°

	P	M	K	N	S	H												
Steel	●	◐	◑	◐	◐	◐	●	●										
Stainless	●	●					●	●	●	●								
Cast iron	●		◐	◐			●	●										
Non-ferrous																		
Superalloy							●	●	●	●								
Hard material																		

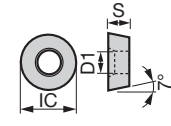

Application	Chipbreaker	Designation		Coated								Uncoated	Dimension (inch)					
		Inch	Metric	T9215	T9225	T9115	T9125	T5115	AH120	AH8005	AH8015	AH905	KS05F	RE	IC	S	D1	
Finishing to medium cutting		RS	-	RCMT10T3M0-RS	●	●	▲	▲							-	0.394	0.156	0.173
			-	RCMT1204M0-RS	●	●	▲	▲		●	●	●			-	0.472	0.187	0.173
			-	RCMT1606M0-RS	●	●	▲	▲		●					-	0.630	0.250	0.217
			-	RCMT2006M0-RS		●		▲							-	0.787	0.250	0.256
			-	RCMT2507M0-RS		●		▲							-	0.984	0.313	0.299
		CM	-	RCMT0502M0-CM						●					-	0.197	0.094	0.098
			-	RCMT0602M0-CM						●					-	0.236	0.094	0.110
			-	RCMT0803M0-CM						●					-	0.315	0.125	0.134
		AL	-	RCGT0602M0-AL									●		-	0.236	0.094	0.110
		-	RCGT0803M0-AL									●		-	0.315	0.125	0.134	
		-	RCGT1003M0-AL									●		-	0.394	0.125	0.173	
Finishing (low cutting force)	6RS	-	RCMT1204M0-6RS	●	●	▲	▲							-	0.472	0.187	0.173	
	6RM	-	RCMT1204M0-6RM	●	●	▲	▲							-	0.472	0.187	0.173	

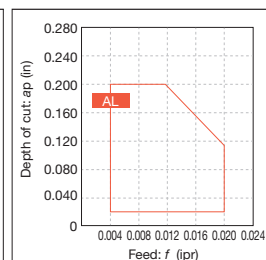
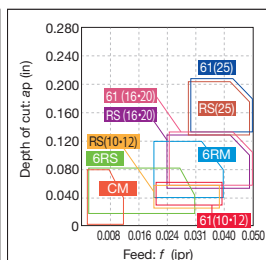
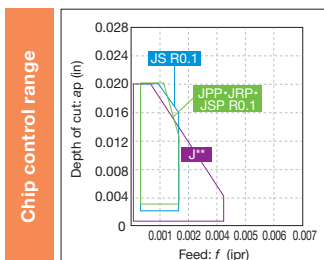

- : Line up
- ▲ : To be discontinued

*Chip control range with typical R0.1

Reference pages: External toolholder → C078 -, C087

Grade
Insert
Toolholder
Ext. Toolholder
Int. Toolholder
Threading
Grooving
Miniature Tool
Milling Cutter
Endmill
Drilling Tool
Tooling System
User's Guide
Index



Negative

Positive

PCD / CBN

C

D

G

R

S

T

V

W

Y

OTHERS

Insert POSITIVE TYPE

● : Continuous cutting
 ● : Light interrupted cutting
 ✱ : Heavy interrupted cutting

RC



Round,
with hole
Positive 7°

	P	M	K	N	S	H
Steel	●	●	●	●	●	●
Stainless	●	●	●	●	●	●
Cast iron	●	●	●	●	●	●
Non-ferrous	●	●	●	●	●	●
Superalloy	●	●	●	●	●	●
Hard material	●	●	●	●	●	●

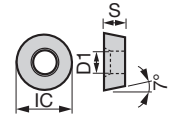

Application	Chipbreaker	Designation		Coated			Cermet	Uncoated	Dimension (inch)						
		Inch	Metric	T9215	T9225	T9115	T9125	AH8005	AH8015	AH905	NS9530	TH10	RE	IC	S
Heavy cutting		-	RCMT0502M0-61	●	●	▲	▲			●		-	0.197	0.094	0.098
		-	RCMT0602M0-61	●	●	▲	▲			●		-	0.236	0.094	0.110
		-	RCMT0803M0-61	●	●	▲	▲			●		-	0.315	0.125	0.134
		-	RCMM1003M0-61	●	●	▲	▲	●	●	●	●	-	0.394	0.125	0.142
		-	RCMM1204M0-61	●	●	▲	▲	●	●	●	●	-	0.472	0.187	0.165
		-	RCMM1606M0-61	●	●	▲	▲					-	0.630	0.250	0.205
		-	RCMM2006M0-61	●	●	▲	▲					-	0.787	0.250	0.256
		-	RCMM2507M0-61	●	●	▲	▲					-	0.984	0.313	0.283

D1 (in)	Designation	0502M0	0602M0	0803M0	1003M0	1204M0	1606M0	2006M0	2507M0
	RC*T	0.098	0.110	0.134	0.173	0.173	0.217	0.256	0.299
	RCMM	-	-	-	0.142	0.165	0.205	0.256	0.283

RT



Special round
insert

	P	M	K	N	S	H
Steel	●	●	●	●	●	●
Stainless	●	●	●	●	●	●
Cast iron	●	●	●	●	●	●
Non-ferrous	●	●	●	●	●	●
Superalloy	●	●	●	●	●	●
Hard material	●	●	●	●	●	●

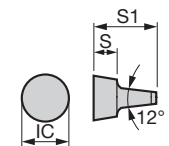

Application	Chipbreaker	Designation		Uncoated		Dimension (inch)			
		Inch	Metric	TH10	KS20	RE	IC	S	S1
Medium cutting		-	RT05	●		-	0.197	0.098	0.256
		-	RT06	●	●	-	0.236	0.118	0.303
		-	RT08	●		-	0.315	0.165	0.406

● : Line up
 ▲ : To be discontinued

Reference pages: RC...: External toolholder → **C078 -**

Insert POSITIVE TYPE

- : Continuous cutting
- : Light interrupted cutting
- ✳ : Heavy interrupted cutting

RC



Round,
without hole
Positive 7°

P	Steel																					
M	Stainless																					
K	Cast iron																					
N	Non-ferrous																					
S	Superalloy																					
H	Hard material	●																				

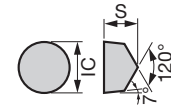

Application	Chipbreaker	Designation	Ceramic	Dimension (inch)							
				Inch	Metric	RE	IC	S	D1		
										LX11	
Medium cutting	-	RCGX090800	●								
	-	RCGX120800	●								

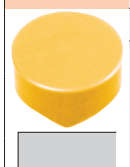

● : Line up

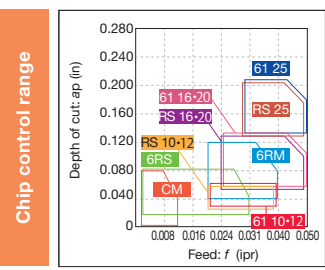

- Grade A
- Insert B
- Toolholder C
- Ext. Toolholder D
- Int. Toolholder E
- Threading F
- Grooving G
- Miniature Tool H
- Endmill I
- Drilling Tool J
- Tooling System K
- User's Guide L
- Index M

MEMO

Negative

Positive

PCD / CBN

C

D

G

R

S

T

V

W

Y

OTHERS

Insert POSITIVE TYPE

- : Continuous cutting
- ◐ : Light interrupted cutting
- ◑ : Heavy interrupted cutting

SC

Square, 90°
with hole
Positive 7°

Material	P Steel	M Stainless	K Cast iron	N Non-ferrous	S Superalloy	H Hard material
●	●	●	●	●	●	●
◐	◐	◐	◐	◐	◐	◐
◑	◑	◑	◑	◑	◑	◑

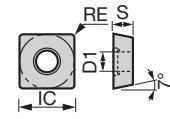

Application	Chipbreaker	Designation	Coated								Coated cermet	Cermet	Dimension (inch)							
			T9215	T9225	T9115	T9125	T6120	T6130	AH630	AH645	T515	T5115	AH120	AH725	GT9530	AT9530	NS9530	RE	IC	S
Finishing to medium cutting		PS SCMT 32.51 PS SCMT09T304-PS	●	●	▲	▲	●	●	●	●	●			●			0.016	0.375	0.156	0.173
		SCMT 32.52 PS SCMT09T308-PS	●	●	▲	▲	●	●	●	●				●	●		0.031	0.375	0.156	0.173
		SCMT 431 PS SCMT120404-PS	●	●	▲	▲	●	●	●	●				●			0.016	0.500	0.187	0.217
		SCMT 432 PS SCMT120408-PS	●	●	▲	▲	●	●	●	●				●			0.031	0.500	0.187	0.217
Threading		23 SCMT 32.50.5-23 SCMT09T302-23																		
		SCMT 32.52-23 SCMT09T308-23		●	▲								●				0.031	0.375	0.156	0.173
		SCMT 432-23 SCMT120408-23		●	▲								●	●			0.031	0.500	0.187	0.217
Medium cutting		24 SCMT 21.51-24 SCMT070204-24			●	▲										0.016	0.313	0.094	0.134	
		SCMT 32.50.5-24 SCMT09T302-24															0.008	0.375	0.156	0.173
		SCMT 32.51-24 SCMT09T304-24			●	▲											0.016	0.375	0.156	0.173
		SCMT 32.52-24 SCMT09T308-24		●	▲	▲											0.031	0.375	0.156	0.173
		SCMT 431-24 SCMT120404-24		●	▲	▲											0.016	0.500	0.187	0.217
		SCMT 432-24 SCMT120408-24		●	▲	▲						●					0.031	0.500	0.187	0.217
Milling		PM SCMT 32.51 PM SCMT09T304-PM	●	●	▲	▲	●	●	●	●			●			0.016	0.375	0.156	0.173	
		SCMT 32.52 PM SCMT09T308-PM	●	●	▲	▲	●	●	●	●			●			0.031	0.375	0.156	0.173	
		SCMT 432 PM SCMT120408-PM	●	●	▲	▲	●	●	●	●			●			0.031	0.500	0.187	0.217	
		SCMT 433 PM SCMT120412-PM		●	▲	▲	●	●	●	●			●			0.047	0.500	0.187	0.217	
Finishing to medium cutting		CM SCMT 32.51 CM SCMT09T304-CM									●	●				0.016	0.375	0.156	0.173	
		SCMT 32.52 CM SCMT09T308-CM										●	●				0.031	0.375	0.156	0.173
		SCMT 32.53 CM SCMT09T312-CM											●				0.047	0.375	0.156	0.173
		SCMT 431 CM SCMT120404-CM										●	●				0.016	0.500	0.187	0.217
		SCMT 432 CM SCMT120408-CM										●	●				0.031	0.500	0.187	0.217

- : Line up
- ▲ : To be discontinued

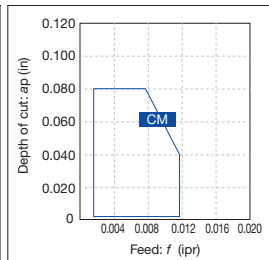
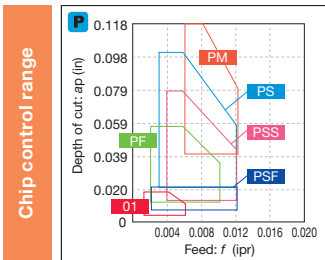

Reference pages: External toolholder → **C110 -**

Insert POSITIVE TYPE

● : Continuous cutting
● : Light interrupted cutting
⊛ : Heavy interrupted cutting

SP



Square, 90°
with hole
Positive 11°

P	Steel	●●	●●	●●	●●	●	⊛	⊛	⊛	●	●	●●	●●	●●	●●	●	●
M	Stainless	●●				●	●	●	⊛	●	●	●●	●●	●●	●●	●	●
K	Cast iron	●●	●●							●●	●	●●	●●	●●	●●	●	●
N	Non-ferrous															●	●
S	Superalloy									●●	●						
H	Hard material																

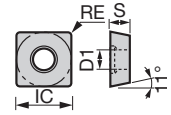

Application	Chipbreaker	Designation	Coated								Coated cermet	Cermet	Un-coated	Dimension (inch)							
			Inch	Metric	T9215	T9225	T9115	T9125	T6120	T6130	AH630	AH645	AH120	AH725	GT9530	AT9530	NS9530	TH10	RE	IC	S
Finishing to medium cutting		PS SPMT 321 PS SPMT090304-PS	●	●	▲	▲	●	●	●	●	●	●	●	●	●			0.016	0.375	0.125	0.173
		SPMT 322 PS SPMT090308-PS	●	●	▲	▲	●	●	●	●	●	●	●	●	●			0.031	0.375	0.125	0.173
		SPMT 431 PS SPMT120404-PS	●	●	▲	▲	●	●	●	●	●	●	●	●	●			0.016	0.500	0.187	0.217
		SPMT 432 PS SPMT120408-PS	●	●	▲	▲	●	●	●	●	●	●	●	●	●			0.031	0.500	0.187	0.217
Finishing		23 SPMT 321 23 SPMT090304-23		●		▲								●			0.016	0.375	0.125	0.173	
		SPMT 322-23 SPMT090308-23		●		▲								●			0.031	0.375	0.125	0.173	
Medium cutting		24 SPMT 321-24 SPMT090304-24		●		▲								●			0.016	0.375	0.125	0.173	
		SPMT 322-24 SPMT090308-24		●		▲					●			●			0.031	0.375	0.125	0.173	
		SPMT 431-24 SPMT120404-24									●			●			0.016	0.500	0.187	0.217	
		SPMT 432-24 SPMT120408-24									●			●			0.031	0.500	0.187	0.217	
Finishing		W15 SPGT 320.5 L-W15 SPGT090302L-W15													●		0.008	0.375	0.125	0.173	
		SPGT 321 L-W15 SPGT090304L-W15													●	●	0.016	0.375	0.125	0.173	
		SPGT 322 R-W15 SPGT090308R-W15													●	●	0.031	0.375	3.18	0.173	
		SPGT 322 L-W15 SPGT090308L-W15													●	●	0.031	0.375	3.18	0.173	
Finishing		W20 SPGT 431 L-W20 SPGT120404L-W20													●		0.016	0.500	0.187	0.217	

● : Line up
▲ : To be discontinued

Reference pages: Internal toolholder → **D045 -**

Insert POSITIVE TYPE

- : Continuous cutting
- ◐ : Light interrupted cutting
- ◑ : Heavy interrupted cutting

SP



Square, 90°
with hole
Positive 11°

Material	Steel	Stainless	Cast iron	Non-ferrous	Superalloy	Hard material
P	●					
M		●				
K	●		●			
N				●		
S					●	
H						●

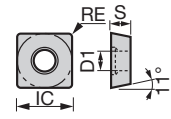

Application	Chipbreaker	Designation	Coated				Cermet				Uncoated				Dimension (inch)			
			Inch		Metric		NS9530		TH10		RE	IC	S	D1				
			T515	T5115														
Finishing to medium cutting		CM	SPMT 321 CM	SPMT090304-CM	●						0.016	0.375	0.125	0.173				
			SPMT 322 CM	SPMT090308-CM	●						0.031	0.375	0.125	0.173				
			SPMT 431 CM	SPMT120404-CM	●	●					0.016	0.500	0.187	0.217				
			SPMT 432 CM	SPMT120408-CM	●	●					0.031	0.500	0.187	0.217				
		-	SPGM 321 L	SPGM090304L			●				0.016	0.375	0.125	0.173				
		(Tungaloy standard hole specification)	SPGM 421 L	SPGM120304L			●				0.016	0.500	0.125	0.217				
			SPGM 422 L	SPGM120308L			●				0.031	0.500	0.125	0.217				
		-	SPMW 321	SPMW090304	●						0.016	0.375	0.125	0.173				
			SPMW 322	SPMW090308	●						0.031	0.375	0.125	0.173				
			SPMW 431	SPMW120404	●	●					0.016	0.500	0.187	0.217				
			SPMW 432	SPMW120408	●	●					0.031	0.500	0.187	0.217				
		-	SPGW 320.5	SPGW090302				●			0.008	0.375	0.125	0.173				
			SPGW 321	SPGW090304				●			0.016	0.375	0.125	0.173				
			SPGW 431	SPGW120404				●			0.016	0.500	0.187	0.217				
		-	SPGA 321	SPGA090304			●				0.016	0.375	0.125	0.173				
		(Tungaloy standard hole specification)																

● : Line up

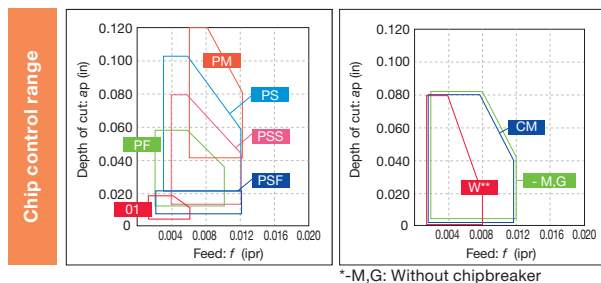

Reference pages: Internal toolholder → **D045 -**

Grade
Insert
Toolholder
Ext. Toolholder
Int. Toolholder
Threading
Grooving
Milling Cutter
Miniature Tool
Endmill
Drilling Tool
Tooling System
User's Guide
Index



Insert POSITIVE TYPE

- : Continuous cutting
- ◐ : Light interrupted cutting
- ◑ : Heavy interrupted cutting

TC

Triangular, 60° with hole Positive 7°



Material	P Steel	M Stainless	K Cast iron	N Non-ferrous	S Superalloy	H Hard material	Coated	Coated cermet	Cermet	Un-coated
P Steel	●●●●●●●●●●●●	●●●●●●●●●●●●	●●●●●●●●●●●●	●●●●●●●●●●●●	●●●●●●●●●●●●	●●●●●●●●●●●●	●●●●●●●●●●●●	●●●●●●●●●●●●	●●●●●●●●●●●●	●●●●●●●●●●●●
M Stainless	●●●●●●●●●●●●	●●●●●●●●●●●●	●●●●●●●●●●●●	●●●●●●●●●●●●	●●●●●●●●●●●●	●●●●●●●●●●●●	●●●●●●●●●●●●	●●●●●●●●●●●●	●●●●●●●●●●●●	●●●●●●●●●●●●
K Cast iron	●●●●●●●●●●●●	●●●●●●●●●●●●	●●●●●●●●●●●●	●●●●●●●●●●●●	●●●●●●●●●●●●	●●●●●●●●●●●●	●●●●●●●●●●●●	●●●●●●●●●●●●	●●●●●●●●●●●●	●●●●●●●●●●●●
N Non-ferrous	●●●●●●●●●●●●	●●●●●●●●●●●●	●●●●●●●●●●●●	●●●●●●●●●●●●	●●●●●●●●●●●●	●●●●●●●●●●●●	●●●●●●●●●●●●	●●●●●●●●●●●●	●●●●●●●●●●●●	●●●●●●●●●●●●
S Superalloy	●●●●●●●●●●●●	●●●●●●●●●●●●	●●●●●●●●●●●●	●●●●●●●●●●●●	●●●●●●●●●●●●	●●●●●●●●●●●●	●●●●●●●●●●●●	●●●●●●●●●●●●	●●●●●●●●●●●●	●●●●●●●●●●●●
H Hard material	●●●●●●●●●●●●	●●●●●●●●●●●●	●●●●●●●●●●●●	●●●●●●●●●●●●	●●●●●●●●●●●●	●●●●●●●●●●●●	●●●●●●●●●●●●	●●●●●●●●●●●●	●●●●●●●●●●●●	●●●●●●●●●●●●

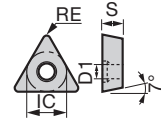

Application	Designation		Coated							Coated cermet	Cermet	Un-coated	Dimension (inch)							
			T9215	T9225	T9115	T9125	AH725	SH725	J740	GT9530	NS9530	NS520	TH10	RE	IC	S	D1			
			Inch		Metric															
Precision finishing		01	TCGT 731-01	TCGT090204-01																
			TCGT 21.50.5-01	TCGT110202-01																
			TCGT 21.51-01	TCGT110204-01																
			TCGT 21.52-01	TCGT110208-01																
			TCGT 32.51-01	TCGT16T304-01																
			TCGT 32.52-01	TCGT16T308-01																
Precision finishing (sharp edge)		01	TCGT 21.50.5 F-01	TCGT110202F-01																
			TCGT 21.51 F-01	TCGT110204F-01																
Finishing		PSF	TCMT 730.5 PSF	TCMT090202-PSF																
			TCMT 731 PSF	TCMT090204-PSF	●	●	▲	▲	●											
			TCMT 21.50.5 PSF	TCMT110202-PSF																
			TCMT 21.51 PSF	TCMT110204-PSF	●	●	▲	▲	●											
			TCMT 220.5 PSF	TCMT110302-PSF																
			TCMT 221 PSF	TCMT110304-PSF	●	●	▲	▲	●											
Finishing to light cutting		PSS	TCMT 731 PSS	TCMT090204-PSS	●	●	▲	▲	●											
			TCMT 732 PSS	TCMT090208-PSS	●	●	▲	▲	●											
			TCMT 21.51 PSS	TCMT110204-PSS	●	●	▲	▲	●											
			TCMT 21.52 PSS	TCMT110208-PSS	●	●	▲	▲	●											
			TCMT 221 PSS	TCMT110304-PSS	●	●	▲	▲	●											
			TCMT 222 PSS	TCMT110308-PSS	●	●	▲	▲	●											
			TCMT 32.51 PSS	TCMT16T304-PSS	●	●	▲	▲	●											
			TCMT 32.52 PSS	TCMT16T308-PSS	●	●	▲	▲	●											
	TCMT 32.53 PSS	TCMT16T312-PSS	●	●	▲	▲	●													

*Corner radius (RE) with a sign of inequality (<) means minus tolerance.

- : Line up
- ▲ : To be discontinued

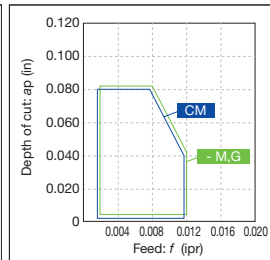
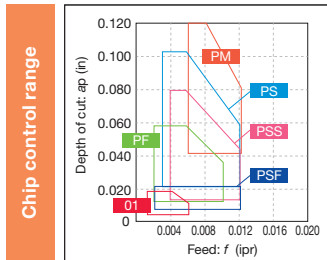

*-M,G: Without chipbreaker

Reference pages: External toolholder → C080 - Internal toolholder → D049
J-Series toolholder → G051 -

Insert POSITIVE TYPE

- : Continuous cutting
- ◐ : Light interrupted cutting
- ◑ : Heavy interrupted cutting

TC



Triangular, 60° with hole Positive 7°

	P Steel	M Stainless	K Cast iron	N Non-ferrous	S Superalloy	H Hard material
●	●	●	●	●	●	●
◐	◐	◐	◐	◐	◐	◐
◑	◑	◑	◑	◑	◑	◑

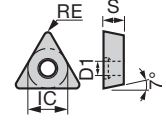

Application	Chipbreaker	Designation		Coated				Coated cermet	Cermet	Un-coated	Dimension (inch)											
		Inch	Metric	T9215	T9225	T9115	T9125	T6120	T6130	AH630	AH645	AH725	GH730	GT9530	AT9530	NS9530	TH10	RE	IC	S	D1	
Finishing to medium cutting		PS	TCMT 731 PS	TCMT090204-PS													0.016	0.219	0.094	0.098		
			TCMT 732 PS	TCMT090208-PS														0.031	0.219	0.094	0.098	
		TCMT 21.50.5 PS	TCMT110202-PS	●	●	▲	▲	●	●	●	●	●	●	●	●	●	●	0.008	0.250	0.094	0.110	
		TCMT 21.51 PS	TCMT110204-PS	●	●	▲	▲	●	●	●	●	●	●	●	●	●	●	0.016	0.250	0.094	0.110	
		TCMT 21.52 PS	TCMT110208-PS	●	●	▲	▲	●	●	●	●	●	●	●	●	●	●	0.031	0.250	0.094	0.110	
		TCMT 220.5 PS	TCMT110302-PS	●	●	▲	▲	●	●	●	●							0.008	0.250	0.125	0.110	
		TCMT 221 PS	TCMT110304-PS	●	●	▲	▲	●	●	●	●							0.016	0.250	0.125	0.110	
		TCMT 222 PS	TCMT110308-PS	●	●	▲	▲	●	●	●	●							0.031	0.250	0.125	0.110	
		TCMT 32.50.5 PS	TCMT16T302-PS	●	●	▲	▲	●	●	●	●					●		0.008	0.375	0.156	0.173	
		TCMT 32.51 PS	TCMT16T304-PS	●	●	▲	▲	●	●	●	●					●		0.016	0.375	0.156	0.173	
		TCMT 32.52 PS	TCMT16T308-PS	●	●	▲	▲	●	●	●	●							0.031	0.375	0.156	0.173	
		TCMT 21.51 TSF	TCMT110204-TSF	●	●													0.016	0.250	0.094	0.110	
		TCMT 21.52 TSF	TCMT110208-TSF	●	●													0.031	0.250	0.094	0.110	
		TCMT 32.51 TSF	TCMT16T304-TSF	●	●													0.016	0.375	0.156	0.173	
TCMT 32.52 TSF	TCMT16T308-TSF	●	●													0.031	0.375	0.156	0.173			
Finishing		W15	TCGT 32.50.5 L-W15	TCGT16T302L-W15												●	0.008	0.375	0.156	0.173		
			TCGT 32.51 L-W15	TCGT16T304L-W15														●	0.016	0.375	0.156	0.173
			TCGT 32.52 L-W15	TCGT16T308L-W15															●	0.031	0.375	0.156
		23	TCMT 731-23	TCMT090204-23			●	▲										●	0.016	0.219	0.094	0.098
			TCMT 21.51-23	TCMT110204-23															●	0.016	0.250	0.094
Medium cutting		24	TCMT 730.5-24	TCMT090202-24													0.008	0.219	0.094	0.098		
			TCMT 731-24	TCMT090204-24	●	●	▲	▲										●	0.016	0.219	0.094	0.098
		TCMT 21.50.5-24	TCMT110202-24															●	0.008	0.250	0.094	0.110
		TCMT 21.51-24	TCMT110204-24	●	●	▲	▲											●	0.016	0.250	0.094	0.110
		TCMT 21.52-24	TCMT110208-24			●	▲												0.031	0.250	0.094	0.110
		TCMT 32.51-24	TCMT16T304-24	●	●	▲	▲											●	0.016	0.375	0.156	0.173
TCMT 32.52-24	TCMT16T308-24	●	●	▲	▲					●							0.031	0.375	0.156	0.173		

Reference pages: External toolholder → C080 - Internal toolholder → D049
 J-Series toolholder → G051 -

- : Line up
- ▲ : To be discontinued

Insert POSITIVE TYPE

- : Continuous cutting
- ◐ : Light interrupted cutting
- ✱ : Heavy interrupted cutting

TC



Triangular, 60°
with hole
Positive 7°

Material	Steel	Stainless	Cast iron	Non-ferrous	Superalloy	Hard material
P	●●●●●●●●●●	●●	●●			
M	●●	●●●●●●●●	●●	●●●●●●●●	●●	●●
K	●●	●●	●●●●●●●●			
N				●●●●●●●●		
S					●●●●●●●●	
H						●●●●●●●●

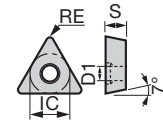

Application	Chipbreaker	Designation	Coated										Cermet	Uncoated	Dimension (inch)											
			Inch		Metric		T9215	T9225	T9115	T9125	T6120	T6130			AH630	AH645	T515	T5115	AH725	NS9530	KS05F	RE	IC	S	D1	
Medium cutting		PM TCMT 21.50.5 PM	TCMT110202-PM																							
		TCMT 21.51 PM	TCMT110204-PM	●	●	▲	▲	●	●	●	●	●	●	●	●	●	●	●	●	●	●	●	●	●	●	●
		TCMT 21.52 PM	TCMT110208-PM	●	●	▲	▲	●	●	●	●	●	●	●	●	●	●	●	●	●	●	●	●	●	●	●
		TCMT 220.5 PM	TCMT110302-PM					●	●	●	●	●	●	●	●	●	●	●	●	●	●	●	●	●	●	●
		TCMT 221 PM	TCMT110304-PM					●	●	●	●	●	●	●	●	●	●	●	●	●	●	●	●	●	●	●
		TCMT 222 PM	TCMT110308-PM					●	●	●	●	●	●	●	●	●	●	●	●	●	●	●	●	●	●	●
		TCMT 32.51 PM	TCMT16T304-PM	●	●	▲	▲	●	●	●	●	●	●	●	●	●	●	●	●	●	●	●	●	●	●	●
		TCMT 32.52 PM	TCMT16T308-PM	●	●	▲	▲	●	●	●	●	●	●	●	●	●	●	●	●	●	●	●	●	●	●	●
		TCMT 32.53 PM	TCMT16T312-PM	●	●	▲	▲	●	●	●	●	●	●	●	●	●	●	●	●	●	●	●	●	●	●	●
Finishing to medium cutting		CM TCMT 731 CM	TCMT090204-CM																							
		TCMT 732 CM	TCMT090208-CM																							
		TCMT 21.51 CM	TCMT110204-CM																							
		TCMT 21.52 CM	TCMT110208-CM																							
		TCMT 221 CM	TCMT110304-CM																							
		TCMT 222 CM	TCMT110308-CM																							
	SS TCGT 21.51 SS	TCGT110204-SS																								
	TCGT 21.52 SS	TCGT110208-SS																								
	TCGT 32.51 SS	TCGT16T304-SS																								
	AL TCGT 21.51 AL	TCGT110204-AL																								
	TCGT 32.51 AL	TCGT16T304-AL																								

● : Line up
▲ : To be discontinued

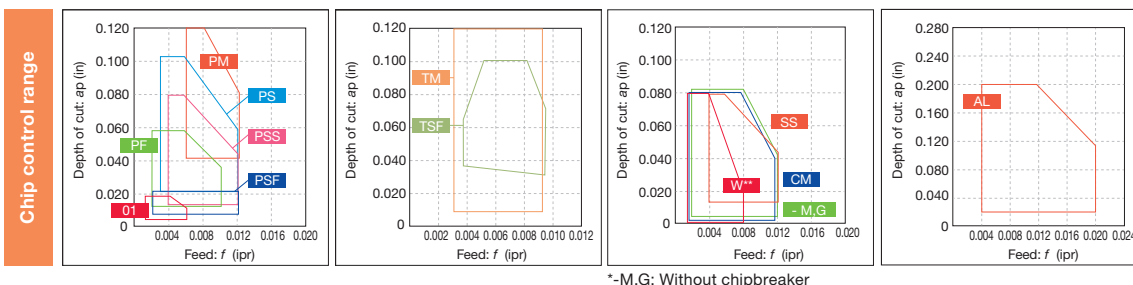

Reference pages: External toolholder → **C080** - Internal toolholder → **D049**
J-Series toolholder → **G051** -

Grade
Insert
Toolholder
Ext. Toolholder
Int. Toolholder
Threading
Grooving
Miniature Tool
Milling Cutter
Endmill
Drilling Tool
Tooling System
User's Guide
Index



Insert POSITIVE TYPE

- : Continuous cutting
- ◐ : Light interrupted cutting
- ◑ : Heavy interrupted cutting

TC



Triangular, 60°
with hole
Positive 7°

P	Steel	●	●	●	●	●	●	●	●	●	●	●	●	●
M	Stainless	●	●	●	●	●	●	●	●	●	●	●	●	●
K	Cast iron	●	●	●	●	●	●	●	●	●	●	●	●	●
N	Non-ferrous													
S	Superalloy	●	●	●	●	●	●	●	●	●	●	●	●	●
H	Hard material													

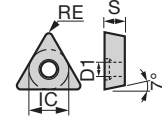

Application	Chipbreaker	Designation	Coated				Cermet	Uncoated	Dimension (inch)														
			AH725	SH725	SH730	J740			NS9530	TH10	RE	IC	S	D1									
	Inch	Metric																					
Finishing		TCGT 620.5 R	TCGT080102R														0.008	0.187	0.063	0.106			
For external turning on Swiss lathes (sharp edge)		JS	TCGT 21.5V FN-JS	TCGT110200FN-JS	●	●											0.001	0.250	0.094	0.110			
			TCGT 21.50 FN-JS	TCGT110201FN-JS	●	●												<0.004	0.250	0.094	0.110		
			TCGT 21.50.5 FN-JS	TCGT110202FN-JS	●	●													<0.008	0.250	0.094	0.110	
			TCGT 21.51 FN-JS	TCGT110204FN-JS	●	●													<0.016	0.250	0.094	0.110	
For external turning on Swiss lathes (honed edge)		JS	TCGT 21.50 N-JS	TCGT110201N-JS	●													0.004	0.250	0.094	0.110		
			TCGT 21.50.5 N-JS	TCGT110202N-JS	●														0.008	0.250	0.094	0.110	
			TCGT 21.51 N-JS	TCGT110204N-JS	●														0.016	0.250	0.094	0.110	
For external turning on Swiss lathes (sharp edge)		J08	TCGT 63V FR-J08	TCGT080200FR-J08	●	●			●									0.001	0.187	0.094	0.091		
			TCGT 63V FL-J08	TCGT080200FL-J08	●	●			●										0.001	0.187	0.094	0.091	
			TCGT 630 FR-J08	TCGT080201FR-J08	●	●			●										0.004	0.187	0.094	0.091	
			TCGT 630 FL-J08	TCGT080201FL-J08	●	●			●											0.004	0.187	0.094	0.091
			TCGT 630.5 FR-J08	TCGT080202FR-J08	●	●			●											0.008	0.187	0.094	0.091
			TCGT 630.5 FL-J08	TCGT080202FL-J08	●	●			●											0.008	0.187	0.094	0.091
			TCGT 631 FR-J08	TCGT080204FR-J08	●															0.016	0.187	0.094	0.091

*Corner radius (RE) with a sign of inequality (<) means minus tolerance. ● : Line up

Reference pages: J-Series toolholder → **G051**

Insert POSITIVE TYPE

- : Continuous cutting
- : Light interrupted cutting
- ✶ : Heavy interrupted cutting

TC



Triangular, 60° with hole Positive 7°

Material	Steel	Stainless	Cast iron	Non-ferrous	Superalloy	Hard material
P	●●●●	●●●●	●●	●●	●●	●
M	●●●●	●●●●				●
K			●●	●●	●●	●
N						●
S						●
H						●

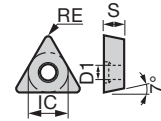

Application		Designation		Coated	Coated cermet	Cermet	Uncoated	Dimension (inch)				
		Inch	Metric	SH725 J740	J9530	NS9530	TH10	RE	IC	S	D1	
For external turning on Swiss lathes (sharp edge)		J10	TCGT 21.5V FR-J10	TCGT110200FR-J10	●●			●	0.001	0.250	0.094	0.110
			TCGT 21.5V FL-J10	TCGT110200FL-J10	●●			●	0.001	0.250	0.094	0.110
			TCGT 21.50 FR-J10	TCGT110201FR-J10	●●			●	0.004	0.250	0.094	0.110
			TCGT 21.50 FL-J10	TCGT110201FL-J10	●●			●	0.004	0.250	0.094	0.110
			TCGT 21.50.5 FR-J10	TCGT110202FR-J10	●●		●	●	0.008	0.250	0.094	0.110
			TCGT 21.50.5 FL-J10	TCGT110202FL-J10	●●		●	●	0.008	0.250	0.094	0.110
			TCGT 21.51 FR-J10	TCGT110204FR-J10	●				0.016	0.250	0.094	0.110
			TCGT 22V FR-J10	TCGT110300FR-J10	●●			●	0.001	0.250	0.125	0.110
			TCGT 22V FL-J10	TCGT110300FL-J10	●●			●	0.001	0.250	0.125	0.110
			TCGT 220 FR-J10	TCGT110301FR-J10	●●			●	0.004	0.250	0.125	0.110
			TCGT 220 FL-J10	TCGT110301FL-J10	●●			●	0.004	0.250	0.125	0.110
			TCGT 220.5 FR-J10	TCGT110302FR-J10	●●		●	●	0.008	0.250	0.125	0.110
TCGT 220.5 FL-J10	TCGT110302FL-J10	●●		●	●	0.008	0.250	0.125	0.110			
For external turning on Swiss lathes (honed edge)		J10	TCGT 220.5 R-J10	TCGT110302R-J10		●		0.008	0.250	0.125	0.110	
			TCGT 220.5 L-J10	TCGT110302L-J10		●			0.008	0.250	0.125	0.110

● : Line up

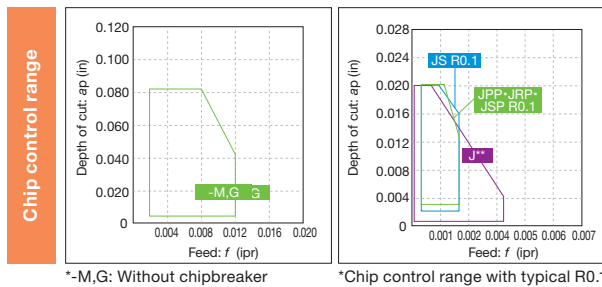

Reference pages: Internal toolholder → **D049** J-Series toolholder → **G051**

Grade A B C D E F G H I J K L M

TP



Triangular, 60°
with hole
Positive 11°

	P Steel	M Stainless	K Cast iron	N Non-ferrous	S Superalloy	H Hard material
●	●	●	●	●	●	●
●	●	●	●	●	●	●
✱	●	●	●	●	●	●
✱	●	●	●	●	●	●
●	●	●	●	●	●	●
●	●	●	●	●	●	●
●	●	●	●	●	●	●
●	●	●	●	●	●	●
●	●	●	●	●	●	●
●	●	●	●	●	●	●
●	●	●	●	●	●	●
●	●	●	●	●	●	●
●	●	●	●	●	●	●
●	●	●	●	●	●	●
●	●	●	●	●	●	●
●	●	●	●	●	●	●
●	●	●	●	●	●	●
●	●	●	●	●	●	●

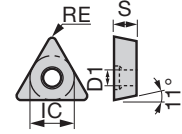

Application	Chipbreaker	Designation		Coated										Coated cermet	Cermet	Dimension (inch)					
		Inch	Metric	T9215	T9225	T9115	T9125	T6120	T6130	AH630	AH645	AH120	AH725	GH730	GT9530	AT9530	NS9530	RE	IC	S	D1
				●	●	▲	▲	●	●	●	●	●	●	●	●	●		●	●	●	●
Finishing to light cutting	 Finishing to light cutting	PSS	TPMT 731 PSS	TPMT090204-PSS	●	●	▲	▲	●	●	●	●	●	●	●	●	●	0.016	0.219	0.094	0.098
			TPMT 732 PSS	TPMT090208-PSS	●	●	▲	▲	●	●	●	●	●	●	●	●	●	0.031	0.219	0.094	0.098
			TPMT 21.51 PSS	TPMT110204-PSS	●	●	▲	▲	●	●	●	●	●	●	●	●	●	0.016	0.250	0.094	0.110
			TPMT 21.52 PSS	TPMT110208-PSS	●	●	▲	▲	●	●	●	●	●	●	●	●	●	0.031	0.250	0.094	0.110
			TPMT 221 PSS	TPMT110304-PSS	●	●	▲	▲	●	●	●	●	●	●	●	●	●	0.016	0.250	0.125	0.134
			TPMT 222 PSS	TPMT110308-PSS	●	●	▲	▲	●	●	●	●	●	●	●	●	●	0.031	0.250	0.125	0.134
			TPMT 2.521 PSS	TPMT130304-PSS	●	●	▲	▲	●	●	●	●	●	●	●	●	●	0.016	0.313	0.125	0.134
			TPMT 2.522 PSS	TPMT130308-PSS	●	●	▲	▲	●	●	●	●	●	●	●	●	●	0.031	0.313	0.125	0.134
			TPMT 32.51 PSS	TPMT16T304-PSS	●	●	▲	▲	●	●	●	●	●	●	●	●	●	0.016	0.375	0.156	0.173
			TPMT 32.52 PSS	TPMT16T308-PSS	●	●	▲	▲	●	●	●	●	●	●	●	●	●	0.031	0.375	0.156	0.173
Finishing to medium cutting	 Finishing to medium cutting	PS	TPMT 730.5 PS	TPMT090202-PS	●	●	▲	▲	●	●	●	●	●	●	●	●	0.008	0.219	0.094	0.098	
			TPMT 731 PS	TPMT090204-PS	●	●	▲	▲	●	●	●	●	●	●	●	●	0.016	0.219	0.094	0.098	
			TPMT 732 PS	TPMT090208-PS	●	●	▲	▲	●	●	●	●	●	●	●	●	0.031	0.219	0.094	0.098	
			TPMT 21.50.5 PS	TPMT110202-PS	●	●	▲	▲	●	●	●	●	●	●	●	●	0.008	0.250	0.094	0.110	
			TPMT 21.51 PS	TPMT110204-PS	●	●	▲	▲	●	●	●	●	●	●	●	●	0.016	0.250	0.094	0.110	
			TPMT 21.52 PS	TPMT110208-PS	●	●	▲	▲	●	●	●	●	●	●	●	●	0.031	0.250	0.094	0.110	
			TPMT 221 PS	TPMT110304-PS	●	●	▲	▲	●	●	●	●	●	●	●	●	0.016	0.250	0.125	0.134	
			TPMT 222 PS	TPMT110308-PS	●	●	▲	▲	●	●	●	●	●	●	●	●	0.031	0.250	0.125	0.134	
			TPMT 2.520.5 PS	TPMT130302-PS	●	●	▲	▲	●	●	●	●	●	●	●	●	0.008	0.313	0.125	0.134	
			TPMT 2.521 PS	TPMT130304-PS	●	●	▲	▲	●	●	●	●	●	●	●	●	0.016	0.313	0.125	0.134	
			TPMT 2.522 PS	TPMT130308-PS	●	●	▲	▲	●	●	●	●	●	●	●	●	0.031	0.313	0.125	0.134	
			TPMT 32.51 PS	TPMT16T304-PS	●	●	▲	▲	●	●	●	●	●	●	●	●	0.016	0.375	0.156	0.173	
			TPMT 32.52 PS	TPMT16T308-PS	●	●	▲	▲	●	●	●	●	●	●	●	●	0.031	0.375	0.156	0.173	
			 Finishing to medium cutting	TSF	TPMT 21.51 TSF	TPMT110204-TSF	●	●										0.016	0.250	0.094	0.110
	TPMT 21.52 TSF			TPMT110208-TSF	●	●											0.031	0.250	0.094	0.110	
	TPMT 221 TSF			TPMT110304-TSF	●	●											0.016	0.250	0.125	0.134	
	TPMT 222 TSF			TPMT110308-TSF	●	●											0.031	0.250	0.125	0.134	
	TPMT 32.51 TSF			TPMT16T304-TSF	●	●											0.016	0.375	0.156	0.173	
	TPMT 32.52 TSF			TPMT16T308-TSF	●	●											0.031	0.375	0.156	0.173	

● : Line up
 ▲ : To be discontinued

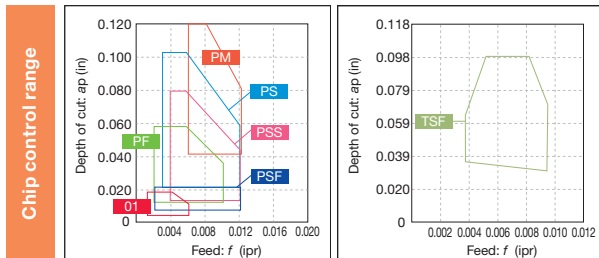

Reference pages: Mounting hole specification → **B149**
 Internal toolholder → **D050 -**

Grade A
 Insert B
 Ext. Toolholder C
 Int. Toolholder D
 Threading E
 Grooving F
 Milling Cutter Miniature Tool G
 Endmill H
 Drilling Tool I
 Tooling System J
 User's Guide Tooling System K
 Index L
 M

TP



Triangular, 60° with hole Positive 11°

Material	Steel	Stainless	Cast iron	Non-ferrous	Superalloy	Hard material
P	●●●					
M		●●●				
K			●●●			
N				●●●		
S					●	
H						

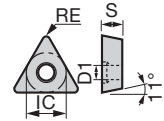

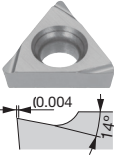
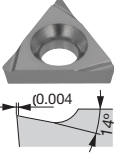
Application	Chipbreaker	Designation		Coating				Dimension (inch)								
		Inch	Metric	Coated		Coated cermet	Cermet	Uncoated		RE	IC	S	D1			
				GH110	GH330	GT9530	NS9530	TH10	UX30							
Finishing	W10	TPGH 630.5 L-W10	TPGH080202L-W10			●										
		TPGH 631 L-W10	TPGH080204L-W10			●										
		TPGH 731 L-W10	TPGH090204L-W10			●										
	W13	TPGH 21.51 L-W13	TPGH110204L-W13					●					0.016	0.250	0.094	0.134
		TPGH 220.5 L-W13	TPGH110302L-W13					●					0.008	0.250	0.125	0.134
		TPGH 221 L-W13	TPGH110304L-W13					●					0.016	0.250	0.125	0.134
	W15	TPGT 730.5 R-W15	TPGT090202R-W15						●				0.008	0.219	0.094	0.098
		TPGT 730.5 L-W15	TPGT090202L-W15				●						0.008	0.219	0.094	0.098
		TPGT 731 R-W15	TPGT090204R-W15					●					0.016	0.219	0.094	0.098
		TPGT 731 L-W15	TPGT090204L-W15	●	●		●			●	●		0.016	0.219	0.094	0.098
		TPGT 21.50.5 R-W15	TPGT110202R-W15						●				0.008	0.250	0.094	0.110
		TPGT 21.50.5 L-W15	TPGT110202L-W15					●					0.008	0.250	0.094	0.110
		TPGT 21.51 L-W15	TPGT110204L-W15	●	●		●				●	●	0.016	0.250	0.094	0.110
		TPGT 21.52 R-W15	TPGT110208R-W15						●				0.031	0.250	0.094	0.110
		TPGT 21.52 L-W15	TPGT110208L-W15									●	0.031	0.250	0.094	0.110
	TPGT 220.5 L-W15	TPGT110302L-W15						●				0.008	0.250	0.125	0.134	
	TPGT 221 R-W15	TPGT110304R-W15						●				0.016	0.250	0.125	0.134	
	TPGT 221 L-W15	TPGT110304L-W15						●				0.016	0.250	0.125	0.134	
	TPGT 222 L-W15	TPGT110308L-W15						●				0.031	0.250	0.125	0.134	
	TPGT 2.520.5 R-W15	TPGT130302R-W15							●			0.008	0.313	0.125	0.134	
	TPGT 2.520.5 L-W15	TPGT130302L-W15							●			0.008	0.313	0.125	0.134	
	TPGT 2.521 R-W15	TPGT130304R-W15	●						●			0.016	0.313	0.125	0.134	
	TPGT 2.521 L-W15	TPGT130304L-W15	●	●		●				●	●	0.016	0.313	0.125	0.134	
	TPGT 2.522 L-W15	TPGT130308L-W15							●			0.031	0.313	0.125	0.134	
	TPGT 32.50.5 R-W15	TPGT16T302R-W15							●			0.008	0.375	0.156	0.173	
	TPGT 32.50.5 L-W15	TPGT16T302L-W15							●			0.008	0.375	0.156	0.173	
	TPGT 32.51 R-W15	TPGT16T304R-W15							●			0.016	0.375	0.156	0.173	
	TPGT 32.51 L-W15	TPGT16T304L-W15	●	●		●				●	●	0.016	0.375	0.156	0.173	
	TPGT 32.52 L-W15	TPGT16T308L-W15							●			0.031	0.375	0.156	0.173	

● : Line up

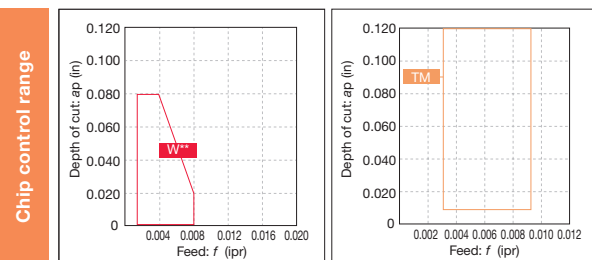

Reference pages: Mounting hole specification → **B149**
 Internal toolholder → **D050 -**

Insert POSITIVE TYPE

- : Continuous cutting
- ◐ : Light interrupted cutting
- ◑ : Heavy interrupted cutting

TP

Triangular, 60°
with hole
Positive 11°



P Steel				●	◐			●	◐							
M Stainless								●	◐							
K Cast iron	◐			●	◐			●	◐							
N Non-ferrous								●	◐							
S Superalloy								●	◐							
H Hard material																

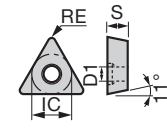

Application		Designation		Dimension (inch)									
				Chipbreaker		Finishing to medium cutting							
				Inch	Metric	T5115	NS9530	TH10 UX30	RE	IC	S	D1	
	-	TPGM 5.520.5 R	TPGM070102R		●					0.008	0.172	0.063	0.106
		TPGM 5.520.5 L	TPGM070102L		●		●			0.008	0.172	0.063	0.106
		TPGM 5.521 R	TPGM070104R		●					0.016	0.172	0.063	0.106
		TPGM 5.521 L	TPGM070104L		●		●			0.016	0.172	0.063	0.106
		TPGM 730.5 R	TPGM090202R		●					0.008	0.219	0.094	0.126
		TPGM 730.5 L	TPGM090202L		●					0.008	0.219	0.094	0.126
		TPGM 731 L	TPGM090204L		●					0.016	0.219	0.094	0.126
	(Tungaloy standard hole specification) ISO non-compliant		TPGM 21.50.5 R	TPGM110202R		●				0.008	0.250	0.094	0.118
		TPGM 21.50.5 L	TPGM110202L		●		●			0.008	0.250	0.094	0.118
		TPGM 21.51 R	TPGM110204R		●					0.016	0.250	0.094	0.118
		TPGM 21.51 L	TPGM110204L		●		●			0.016	0.250	0.094	0.118
		TPGM 220.5 R	TPGM110302R		●					0.008	0.250	0.125	0.118
		TPGM 220.5 L	TPGM110302L		●					0.008	0.250	0.125	0.118
		TPGM 220.5 L-2	TPGM110302L-2				●			0.008	0.250	0.125	0.118
		TPGM 221 R	TPGM110304R		●					0.016	0.250	0.125	0.118
		TPGM 221 L	TPGM110304L		●		●			0.016	0.250	0.125	0.118
		TPGM 221 L-2	TPGM110304L-2				●			0.016	0.250	0.125	0.118
		TPGM 320.5 L	TPGM160302L		●					0.008	0.375	0.125	0.157
		TPGM 321 R	TPGM160304R		●					0.016	0.375	0.125	0.157
		TPGM 321 L	TPGM160304L		●		●			0.016	0.375	0.125	0.157
		TPGM 321 L-2	TPGM160304L-2				●			0.016	0.375	0.125	0.157
	-	TPMW 21.51	TPMW110204	●					0.016	0.250	0.094	0.110	
		TPMW 21.52	TPMW110208	●					0.031	0.250	0.094	0.110	
		TPMW 2.521	TPMW130304	●					0.016	0.313	0.125	0.134	
		TPMW 2.522	TPMW130308	●					0.031	0.313	0.125	0.134	
		TPMW 32.51	TPMW16T304	●					0.016	0.375	0.156	0.173	
		TPMW 32.52	TPMW16T308	●					0.031	0.375	0.156	0.173	

● : Line up

Mounting hole specification	TP*T	TPGM0701	TPGM (A) 0902~1603	TPGH	0701**	0802**	0902**	1102**	1103**	1303**	1603**	16T3**	
	D1	D1	D1	D1	TP*T(W)	-	0.091	0.098	0.110	0.134	0.134	-	0.173
				TPGM(A)	0.106	-	0.126	0.118	0.118	-	0.157	-	
				TPGH	-	0.091	0.118	0.134	0.134	-	0.177	-	

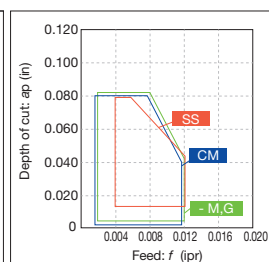
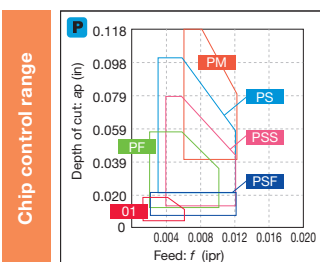

Reference pages: Internal toolholder → **D050** -

Grade
Insert
Toolholder
Ext. Toolholder
Int. Toolholder
Threading
Grooving
Milling Cutter
Miniature Tool
Endmill
Drilling Tool
Tooling System
User's Guide
Index

Insert POSITIVE TYPE

● : Continuous cutting
 ● : Light interrupted cutting
 ✱ : Heavy interrupted cutting

TP
 Triangular, 60°
 with hole
 Positive 11°

Material	Steel	Stainless	Cast iron	Non-ferrous	Superalloy	Hard material								
P	●	●●●●	●●											
M	●	●●●●												
K	●													
N														
S	●		●●											
H														

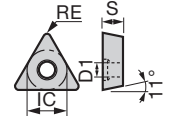

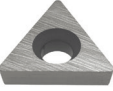
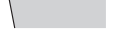
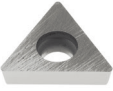
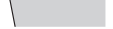
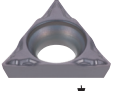
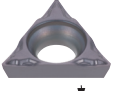
Application	Chipbreaker	Designation		Coated		Cermet		Uncoated		Dimension (inch)					
		Inch	Metric	GH110	SH725	SH730	NS9530	TH10	RE	IC	S	D1			
Finishing to medium cutting	-	TPGA 731	TPGA090204												
	(Tungaloy standard hole specification)	TPGA 21.50.5	TPGA110202				●								
	ISO non-compliant	TPGA 21.51	TPGA110204												
		TPGA 220.5	TPGA110302				●								
		TPGA 221	TPGA110304												
		TPGA 321	TPGA160304				●								
		TPGA 322	TPGA160308												
	-	TPGW 730.5	TPGW090202						●						
		TPGW 731	TPGW090204						●						
	TPGW 21.51	TPGW110204	●					●							
	TPGW 221	TPGW110304						●							
	TPGW 2.521	TPGW130304						●							
	TPGW 32.51	TPGW16T304	●					●							
	TPGW 32.52	TPGW16T308						●							
For internal turning on Swiss lathes	JS	TPGT 5.520 JS	TPGT070101-JS			●									
		TPGT 5.520.5 JS	TPGT070102-JS			●									
		TPGT 5.521 JS	TPGT070104-JS			●									
For internal turning on Swiss lathes (sharp edge)	JS	TPGT 5.520 F-JS	TPGT070101F-JS	●											
		TPGT 5.520.5 F-JS	TPGT070102F-JS	●											
		TPGT 5.521 F-JS	TPGT070104F-JS	●											

*Corner radius (RE) with a sign of inequality (<) means minus tolerance.

● : Line up

- : Continuous cutting
- ◐ : Light interrupted cutting
- ◑ : Heavy interrupted cutting

Insert POSITIVE TYPE

TP

Triangular, 60°
without hole
Positive 11°



	P	M	K	N	S	H								
Steel	◐	◐	◐	◐	◐	◐	◐	◐	◐	◐	◐	◐	◐	◐
Stainless	◐	◐	◐	◐	◐	◐	◐	◐	◐	◐	◐	◐	◐	◐
Cast iron	◐	◐	◐	◐	◐	◐	◐	◐	◐	◐	◐	◐	◐	◐
Non-ferrous	◐	◐	◐	◐	◐	◐	◐	◐	◐	◐	◐	◐	◐	◐
Superalloy	◐	◐	◐	◐	◐	◐	◐	◐	◐	◐	◐	◐	◐	◐
Hard material	◐	◐	◐	◐	◐	◐	◐	◐	◐	◐	◐	◐	◐	◐

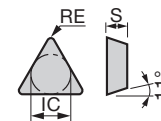

Application	Chipbreaker	Designation	Coated						Cermet	Uncoated	Dimension (inch)			
			Inch	Metric	T9215	T9225	T9115	T9125	T5115	AH725	NS9530	TH10	RE	IC
Finishing to medium cutting		PS TPMPR 221 PS TPMPR110304-PS ● ▲	0.016	0.250	0.125	-								
		TPMPR 222 PS TPMPR110308-PS ● ▲	0.031	0.250	0.125	-								
		TPMPR 321 PS TPMPR160304-PS ● ▲	0.016	0.375	0.125	-								
		TPMPR 322 PS TPMPR160308-PS ● ▲	0.031	0.375	0.125	-								
Finishing to medium cutting		23 TPMPR 221-23 TPMPR110304-23 ● ● ▲ ▲	0.016	0.250	0.125	-								
		TPMPR 222-23 TPMPR110308-23 ● ▲	0.031	0.250	0.125	-								
		TPMPR 321-23 TPMPR160304-23 ● ● ▲ ▲	0.016	0.375	0.125	-								
		TPMPR 322-23 TPMPR160308-23 ● ▲	0.031	0.375	0.125	-								
Medium cutting		24 TPMPR 221-24 TPMPR110304-24 ● ▲	0.016	0.250	0.125	-								
		TPMPR 222-24 TPMPR110308-24 ● ▲	0.031	0.250	0.125	-								
		TPMPR 321-24 TPMPR160304-24 ● ● ▲ ▲ ●	0.016	0.375	0.125	-								
		TPMPR 322-24 TPMPR160308-24 ● ● ▲ ▲	0.031	0.375	0.125	-								
Finishing to medium cutting		CM TPMPR 221 CM TPMPR110304-CM	0.016	0.250	0.125	-								
		TPMPR 222 CM TPMPR110308-CM	0.031	0.250	0.125	-								
		TPMPR 321 CM TPMPR160304-CM	0.016	0.375	0.125	-								
		TPMPR 322 CM TPMPR160308-CM	0.031	0.375	0.125	-								
		TPMPR 323 CM TPMPR160312-CM	0.047	0.375	0.125	-								

● : Line up
▲ : To be discontinued

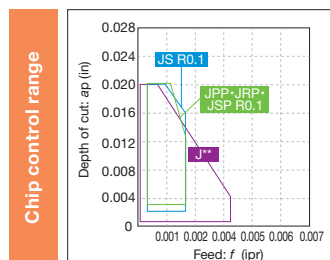

*Chip control range with typical R0.1

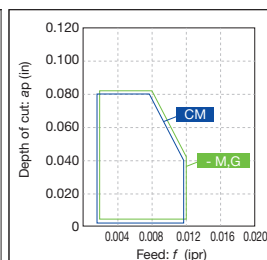
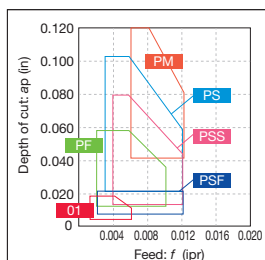

*-M,G: Without chipbreaker

Reference pages: Internal toolholder → D051 -

Insert POSITIVE TYPE

● : Continuous cutting
 ● : Light interrupted cutting
 * : Heavy interrupted cutting

TP

Triangular, 60°
 without hole
 Positive 11°

	P Steel	M Stainless	K Cast iron	N Non-ferrous	S Superalloy	H Hard material
●	●●●●	●●●●	●●●●	●●●●	●●●●	●●●●
●	●●●●	●●●●	●●●●	●●●●	●●●●	●●●●
●	●●●●	●●●●	●●●●	●●●●	●●●●	●●●●
●	●●●●	●●●●	●●●●	●●●●	●●●●	●●●●
●	●●●●	●●●●	●●●●	●●●●	●●●●	●●●●
●	●●●●	●●●●	●●●●	●●●●	●●●●	●●●●
●	●●●●	●●●●	●●●●	●●●●	●●●●	●●●●
●	●●●●	●●●●	●●●●	●●●●	●●●●	●●●●
●	●●●●	●●●●	●●●●	●●●●	●●●●	●●●●
●	●●●●	●●●●	●●●●	●●●●	●●●●	●●●●
●	●●●●	●●●●	●●●●	●●●●	●●●●	●●●●

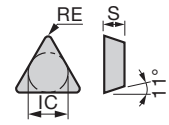

Application	Chipbreaker	Designation	Coated				Cermet		Uncoated		Ceramic		Dimension (inch)				
			T5115	GH110	AH120	T3130	NS9530	NS740	TH10	UX30	LX21	LX11	RE	IC	S	D1	
																	Inch
Finishing to medium cutting	-	TPGR 220.5 L	TPGR110302L									0.008	0.250	0.125	-		
			TPGR 221 L	TPGR110304L									0.016	0.250	0.125	-	
			TPGR 321 R	TPGR160304R									0.016	0.375	0.125	-	
			TPGR 321 L	TPGR160304L									0.016	0.375	0.125	-	
			TPGR 322 L	TPGR160308L									0.031	0.375	0.125	-	
		-	TPMN 221	TPMN110304		●				●	●		0.016	0.250	0.125	-	
			TPMN 222	TPMN110308		●				●	●		0.031	0.250	0.125	-	
			TPMN 321	TPMN160304		●		●		●	●		0.016	0.375	0.125	-	
			TPMN 322	TPMN160308		●		●		●	●		0.031	0.375	0.125	-	
			TPMN 323	TPMN160312		●		●					0.047	0.375	0.125	-	
			TPMN 431	TPMN220404						●	●		0.016	0.500	0.187	-	
			TPMN 432	TPMN220408				●		●	●		0.031	0.500	0.187	-	
			TPMN 433	TPMN220412				●		●	●		0.047	0.500	0.187	-	
			-	TPGN 220.5	TPGN110302						●			0.008	0.250	0.125	-
			TPGN 221	TPGN110304						●		●	0.016	0.250	0.125	-	
			TPGN 222	TPGN110308						●		●	0.031	0.250	0.125	-	
			TPGN 320.5	TPGN160302						●			0.008	0.375	0.125	-	
			TPGN 321	TPGN160304				●		●		●	0.016	0.375	0.125	-	
	TPGN 322		TPGN160308				●		●		●	0.031	0.375	0.125	-		
	TPGN 323		TPGN160312						●		●	0.047	0.375	0.125	-		
	TPGN 431		TPGN220404						●			0.016	0.500	0.187	-		
	TPGN 432		TPGN220408						●			0.031	0.500	0.187	-		
	TPGN 433		TPGN220412						●			0.047	0.500	0.187	-		

VB

Rhombic, 35°
 with hole
 Positive 5°

	P Steel	M Stainless	K Cast iron	N Non-ferrous	S Superalloy	H Hard material
●	●●●●	●●	●●	●●	●●	●●
●	●●	●●	●●	●●	●●	●●
●	●●	●●	●●	●●	●●	●●
●	●●	●●	●●	●●	●●	●●
●	●●	●●	●●	●●	●●	●●
●	●●	●●	●●	●●	●●	●●
●	●●	●●	●●	●●	●●	●●
●	●●	●●	●●	●●	●●	●●
●	●●	●●	●●	●●	●●	●●
●	●●	●●	●●	●●	●●	●●

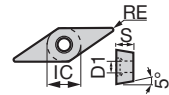

Application	Chipbreaker	Designation	Coated				Coated cermet		Cermet		Dimension (inch)				
			T9215	T9225	T9115	T9125	AH725	GT9530	NS9530	RE	IC	S	D1		
														Inch	Metric
Finishing	PSF	VBMT 220.5 PSF	VBMT110302-PSF		●				●			0.008	0.250	0.125	0.110
		VBMT 221 PSF	VBMT110304-PSF		●	▲	▲	●	●			0.016	0.250	0.125	0.110
		VBMT 330.5 PSF	VBMT160402-PSF					●	●			0.008	0.375	0.187	0.173
		VBMT 331 PSF	VBMT160404-PSF		●	▲	▲	●	●			0.016	0.375	0.187	0.173

● : Line up
 ▲ : To be discontinued

Reference pages: VBMT...: External toolholder → **C065**
 Internal toolholder → **D051 -**

Insert POSITIVE TYPE

● : Continuous cutting
 ● : Light interrupted cutting
 ✱ : Heavy interrupted cutting

VB

Rhombic, 35°
 with hole
 Positive 5°



Material	T9215	T9225	T9115	T9125	T6120	T6130	AH630	AH645	T515	T5115	AH120	AH725	AH8005	AH8015	GT9530	AT9530	NS9530	
P Steel	●	●	●	●	●	●	●	●	●	●	●	●	●	●	●	●	●	●
M Stainless	●	●	●	●	●	●	●	●	●	●	●	●	●	●	●	●	●	●
K Cast iron	●	●	●	●	●	●	●	●	●	●	●	●	●	●	●	●	●	●
N Non-ferrous	●	●	●	●	●	●	●	●	●	●	●	●	●	●	●	●	●	●
S Superalloy	●	●	●	●	●	●	●	●	●	●	●	●	●	●	●	●	●	●
H Hard material	●	●	●	●	●	●	●	●	●	●	●	●	●	●	●	●	●	●

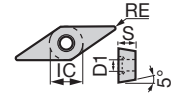

Application	Chipbreaker	Designation	Coated														Coated cermet	Cermet	Dimension (inch)											
			Inch		Metric		T9215	T9225	T9115	T9125	T6120	T6130	AH630	AH645	T515	T5115	AH120	AH725	AH8005	AH8015	GT9530	AT9530	NS9530	RE	IC	S	D1			
Finishing		PF	VBMT 220.5 PF	VBMT110302-PF																										
			VBMT 221 PF	VBMT110304-PF																										
			VBMT 222 PF	VBMT110308-PF																										
			VBMT 331 PF	VBMT160404-PF																										
			VBMT 332 PF	VBMT160408-PF		●		▲																						
Finishing to light cutting		PSS	VBMT 221 PSS	VBMT110304-PSS	●	●	▲	▲	●	●	●	●			●		●	●												
			VBMT 222 PSS	VBMT110308-PSS	●	●	▲	▲	●	●	●	●			●		●	●												
			VBMT 331 PSS	VBMT160404-PSS	●	●	▲	▲	●	●	●	●			●		●	●												
			VBMT 332 PSS	VBMT160408-PSS	●	●	▲	▲	●	●	●	●			●		●	●												
			VBMT 333 PSS	VBMT160412-PSS	●	●	▲	▲							●															
Finishing to medium cutting		PS	VBMT 220.5 PS	VBMT110302-PS	●	●	▲	▲	●	●	●			●	●	●	●	●												
			VBMT 221 PS	VBMT110304-PS	●	●	▲	▲	●	●	●			●	●	●	●	●	●											
			VBMT 222 PS	VBMT110308-PS	●	●	▲	▲	●	●	●			●	●	●	●	●	●											
			VBMT 330.5 PS	VBMT160402-PS	●	●	▲	▲	●	●	●			●	●	●	●	●	●											
			VBMT 331 PS	VBMT160404-PS	●	●	▲	▲	●	●	●			●	●	●	●	●	●											
			VBMT 332 PS	VBMT160408-PS	●	●	▲	▲	●	●	●			●	●	●	●	●	●											
			TSF	VBMT 220.5 TSF	VBMT110302-TSF	●	●																							
			VBMT 221 TSF	VBMT110304-TSF	●	●																								
			VBMT 222 TSF	VBMT110308-TSF	●	●																								
			VBMT 331 TSF	VBMT160404-TSF	●	●																								
	VBMT 332 TSF	VBMT160408-TSF	●	●																										
Finishing to heavy cutting		TM	VBMT 220.5 TM	VBMT110302-TM	●	●																								
			VBMT 221 TM	VBMT110304-TM	●	●																								
			VBMT 222 TM	VBMT110308-TM	●	●																								
			VBMT 331 TM	VBMT160404-TM	●	●																								
			VBMT 332 TM	VBMT160408-TM	●	●																								

● : Line up
 ▲ : To be discontinued

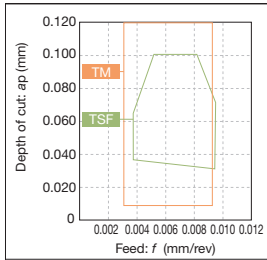
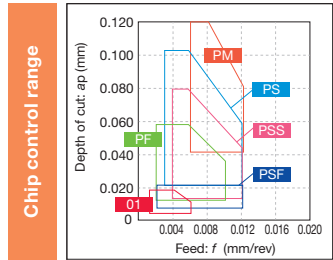

Reference pages: External toolholder → **C065** Internal toolholder → **D043 -**
 J-Series toolholder → **G044 -**

Grade
 Insert
 Ext. Toolholder
 Int. Toolholder
 Threading
 Grooving
 Miniature Tool
 Milling Cutter
 Endmill
 Drilling Tool
 Tooling System
 User's Guide
 Index

Insert POSITIVE TYPE

● : Continuous cutting
 ● : Light interrupted cutting
 ✱ : Heavy interrupted cutting

VB

Rhombic, 35°
 with hole
 Positive 5°



	P	M	K	N	S	H																	
Steel	●	●	●	●	●	●	●	●	●	●	●	●	●	●	●	●	●	●	●	●	●	●	●
Stainless	●	●																					
Cast iron	●		●					●	●	●	●	●	●	●	●	●	●	●	●	●	●	●	●
Non-ferrous				●																			
Superalloy					●																		
Hard material																							

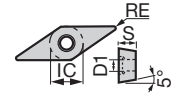

Application	Chipbreaker	Designation		Coated								Coated cermet	Cermet	Un-coated	Dimension (inch)							
		Inch	Metric	T9215	T9225	T9115	T9125	T515	T5115	AH725	SH725	SH730	J740	J9530	NS9530	TH10	RE	IC	S	D1		
		Medium cutting																				
Finishing to medium cutting		24	VBMT 331-24	VBMT160404-24	●	●	▲	▲														
			VBMT 332-24	VBMT160408-24	●	●	▲	▲														
		CM	VBMT 221 CM	VBMT110304-CM																		
			VBMT 222 CM	VBMT110308-CM																		
			VBMT 331 CM	VBMT160404-CM					●	●												
For external turning on Swiss lathes (sharp edge)			VBMT 332 CM	VBMT160408-CM					●	●												
			VBMT 333 CM	VBMT160412-CM					●	●												
		JS	VBGT 22V FN-JS	VBGT110300FN-JS								●	●									
			VBGT 220 FN-JS	VBGT110301FN-JS								●	●									
For external turning on Swiss lathes			VBGT 220.5 FN-JS	VBGT110302FN-JS							●	●										
			VBGT 221 FN-JS	VBGT110304FN-JS								●	●									
		JS	VBGT 220 N-JS	VBGT110301N-JS								●										
For external turning on Swiss lathes (sharp edge)			VBGT 220.5 N-JS	VBGT110302N-JS							●											
			VBGT 221 N-JS	VBGT110304N-JS							●											
		J10	VBGT 22V FR-J10	VBGT110300FR-J10																		
			VBGT 22V FL-J10	VBGT110300FL-J10																		
			VBGT 220 FR-J10	VBGT110301FR-J10																		
			VBGT 220 FL-J10	VBGT110301FL-J10																		
			VBGT 220.5 FR-J10	VBGT110302FR-J10																		
			VBGT 220.5 FL-J10	VBGT110302FL-J10																		
For external turning on Swiss lathes (honed edge)			VBGT 221 FR-J10	VBGT110304FR-J10																		
			VBGT 221 FL-J10	VBGT110304FL-J10																		
		J10	VBGT 220.5 R-J10	VBGT110302R-J10																		
			VBGT 220.5 L-J10	VBGT110302L-J10																		

*Corner radius (RE) with a sign of inequality (<) means minus tolerance.

● : Line up
 ▲ : To be discontinued

Reference pages: External toolholder → **C065** Internal toolholder → **D043 -**
 J-Series toolholder → **G044 -**

Insert POSITIVE TYPE

- : Continuous cutting
- ◐ : Light interrupted cutting
- ◑ : Heavy interrupted cutting

VC

Rhombic, 35°
with hole
Positive 7°



	P	M	K	N	S	H														
Steel	●	●	●	●	●	●	●	●	●	●	●	●	●	●	●	●	●	●	●	●
Stainless	●	●	●	●	●	●	●	●	●	●	●	●	●	●	●	●	●	●	●	●
Cast iron	●	●	●	●	●	●	●	●	●	●	●	●	●	●	●	●	●	●	●	●
Non-ferrous	●	●	●	●	●	●	●	●	●	●	●	●	●	●	●	●	●	●	●	●
Superalloy	●	●	●	●	●	●	●	●	●	●	●	●	●	●	●	●	●	●	●	●
Hard material	●	●	●	●	●	●	●	●	●	●	●	●	●	●	●	●	●	●	●	●

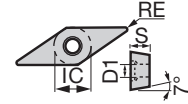

Application	Chipbreaker	Designation	Coated											Coated cermet	Cermet	Dimension (inch)											
			Inch		Metric		T9215	T9225	T9115	T9125	T6120	T6130	AH630	AH645	AH120	AH725	AH8005	AH8015	AH905	GT9530	AT9530	NS9530	RE	IC	S	D1	
Finishing		PSF	VCMT 630.5 PSF	VCMT080202-PSF																							
			VCMT 631 PSF	VCMT080204-PSF	●	●	▲	▲								●				●		●		0.008	0.187	0.094	0.091
			VCMT 220.5 PSF	VCMT110302-PSF												●								0.008	0.250	0.125	0.110
			VCMT 221 PSF	VCMT110304-PSF	●	●	▲	▲								●								0.016	0.250	0.125	0.110
			VCMT 331 PSF	VCMT160404-PSF	●	●	▲	▲								●	●	●	●	●	●	●	●	0.016	0.375	0.187	0.173
			VCMT 332 PSF	VCMT160408-PSF	●	●	▲	▲								●	●	●	●	●	●	●	●	0.031	0.375	0.187	0.173
		PF	VCMT 630.5 PF	VCMT080202-PF																●		●		0.008	0.187	0.094	0.091
			VCMT 631 PF	VCMT080204-PF																●		●		0.016	0.187	0.094	0.091
Finishing to light cutting		PSS	VCMT 221 PSS	VCMT110304-PSS	●	●	▲	▲	●	●	●	●	●	●	●	●	●	●	●	●	●	●	0.016	0.250	0.125	0.110	
			VCMT 222 PSS	VCMT110308-PSS	●	●	▲	▲	●	●	●	●	●	●	●	●	●	●	●	●	●	●	●	0.031	0.250	0.125	0.110
			VCMT 331 PSS	VCMT160404-PSS	●	●	▲	▲	●	●	●	●	●	●	●	●	●	●	●	●	●	●	●	0.016	0.375	0.187	0.173
			VCMT 332 PSS	VCMT160408-PSS	●	●	▲	▲	●	●	●	●	●	●	●	●	●	●	●	●	●	●	●	0.031	0.375	0.187	0.173
Finishing to medium cutting		PS	VCMT 220.5 PS	VCMT110302-PS	●	●	▲	▲	●	●	●	●	●	●	●	●	●	●	●	●	●	●	0.008	0.250	0.125	0.110	
			VCMT 221 PS	VCMT110304-PS	●	●	▲	▲	●	●	●	●	●	●	●	●	●	●	●	●	●	●	●	0.016	0.250	0.125	0.110
			VCMT 222 PS	VCMT110308-PS	●	●	▲	▲	●	●	●	●	●	●	●	●	●	●	●	●	●	●	●	0.031	0.250	0.125	0.110
			VCMT 331 PS	VCMT160404-PS	●	●	▲	▲	●	●	●	●	●	●	●	●	●	●	●	●	●	●	●	0.016	0.375	0.187	0.173
			VCMT 332 PS	VCMT160408-PS	●	●	▲	▲	●	●	●	●	●	●	●	●	●	●	●	●	●	●	●	0.031	0.375	0.187	0.173
			TSF	VCMT 331 TSF	VCMT160404-TSF	●	●																		0.016	0.375	0.187
			VCMT 332 TSF	VCMT160408-TSF	●	●																		0.031	0.375	0.187	0.173
		TM	VCMT 331 TM	VCMT160404-TM	●	●																		0.016	0.375	0.187	0.173
		VCMT 332 TM	VCMT160408-TM	●	●																		0.031	0.375	0.187	0.173	

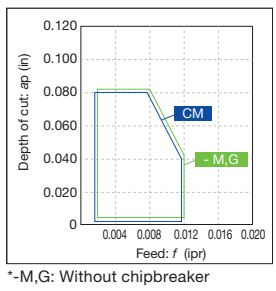
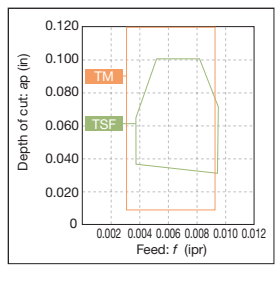
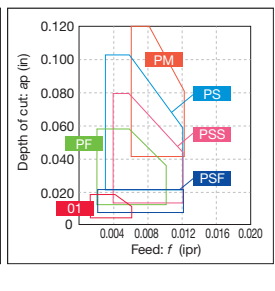
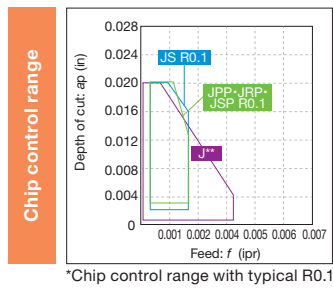

Reference pages: External toolholder → C068 - Internal toolholder → D044 -

Grade
 Insert
 Ext. Toolholder
 Int. Toolholder
 Threading
 Grooving
 Milling Cutter
 Miniature Tool
 Endmill
 Drilling Tool
 Tooling System
 User's Guide
 Index

Insert POSITIVE TYPE

- : Continuous cutting
- ◐ : Light interrupted cutting
- ◑ : Heavy interrupted cutting

VC

Rhombic, 35°
with hole
Positive 7°



	P	M	K	N	S	H	Steel	Stainless	Cast iron	Non-ferrous	Superalloy	Hard material
●	●	●	●	●	●	●	●	●	●	●	●	●
◐	◐	◐	◐	◐	◐	◐	◐	◐	◐	◐	◐	◐
◑	◑	◑	◑	◑	◑	◑	◑	◑	◑	◑	◑	◑

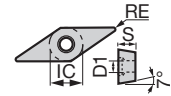

Application	Chipbreaker	Designation		Coated						Cermet	Un-coated	Dimension (inch)						
		Inch	Metric	T9215	T9225	T9115	T9125	T515	T5115	AH8005	AH8015	AH905	NS9530	KS05F	RE	IC	S	D1
		24	VCMT 331-24	VCMT160404-24	●	●	▲	▲						●		0.016	0.375	0.187
	VCMT 332-24	VCMT160408-24	●	●	▲	▲						●		0.031	0.375	0.187	0.173	
Finishing to medium cutting		CM	VCMT 631 CM	VCMT080204-CM										0.016	0.187	0.094	0.091	
			VCMT 331 CM	VCMT160404-CM					●	●					0.016	0.375	0.187	0.173
			VCMT 332 CM	VCMT160408-CM					●	●					0.031	0.375	0.187	0.173
			VCMT 333 CM	VCMT160412-CM					●						0.047	0.375	0.187	0.173
Medium cutting		All-round	VCMT 331	VCMT160404										0.016	0.375	0.187	0.173	
			VCMT 332	VCMT160408						●	●	●			0.031	0.375	0.187	0.173
			VCMT 333	VCMT160412						●	●	●			0.047	0.375	0.187	0.173
Finishing to medium cutting		AL	VCGT 331 AL	VCGT160404-AL									●	0.016	0.375	0.187	0.173	
			VCGT 332 AL	VCGT160408-AL									●	0.031	0.375	0.187	0.173	
			VCGT 333 AL	VCGT160412-AL									●	0.047	0.375	0.187	0.173	
			VCGT 43.55 AL	VCGT220520-AL									●	0.079	0.500	0.219	0.217	
			VCGT 43.57.5 AL	VCGT220530-AL									●	0.118	0.500	0.219	0.217	

- : Line up
- ▲ : To be discontinued

Reference pages: VC*T...: External toolholder → C068 - Internal toolholder → D044 -

Insert POSITIVE TYPE

- : Continuous cutting
- : Light interrupted cutting
- ✳ : Heavy interrupted cutting

VP

Rhombic, 35°
with hole
Positive 11°



P	Steel	●●●●																			
M	Stainless	●●●●																			
K	Cast iron																				
N	Non-ferrous																				
S	Superalloy	●●																			
H	Hard material																				

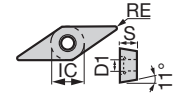

Application	Chipbreaker		Designation		Coated		Dimension (inch)				
	Inch	Metric	SH725	SH730			RE	IC	S	D1	
	JPP										
For external turning on Swiss lathes (sharp edge)	VPET 63X MFR-JPP	VPET0802008MFR-JPP	●●				<0.003	0.187	0.094	0.091	
	VPET 63X MFL-JPP	VPET0802008MFL-JPP	●●				<0.003	0.187	0.094	0.091	
	VPET 630 MFR-JPP	VPET080201MFR-JPP	●●				<0.004	0.187	0.094	0.091	
	VPET 630 MFL-JPP	VPET080201MFL-JPP	●●				<0.004	0.187	0.094	0.091	
	VPET 630.4 MFR-JPP	VPET0802018MFR-JPP	●●				<0.007	0.187	0.094	0.091	
	VPET 630.4 MFL-JPP	VPET0802018MFL-JPP	●●				<0.007	0.187	0.094	0.091	
	VPET 630.5 MFR-JPP	VPET080202MFR-JPP	●●				<0.008	0.187	0.094	0.091	
	VPET 630.5 MFL-JPP	VPET080202MFL-JPP	●●				<0.008	0.187	0.094	0.091	
	VPET 22X MFR-JPP	VPET1103008MFR-JPP	●●				<0.003	0.250	0.125	0.110	
	VPET 22X MFL-JPP	VPET1103008MFL-JPP	●●				<0.003	0.250	0.125	0.110	
	VPET 220 MFR-JPP	VPET110301MFR-JPP	●●				<0.004	0.250	0.125	0.110	
	VPET 220 MFL-JPP	VPET110301MFL-JPP	●●				<0.004	0.250	0.125	0.110	
	VPET 220.4 MFR-JPP	VPET1103018MFR-JPP	●●				<0.007	0.250	0.125	0.110	
	VPET 220.4 MFL-JPP	VPET1103018MFL-JPP	●●				<0.007	0.250	0.125	0.110	
	VPET 220.5 MFR-JPP	VPET110302MFR-JPP	●●				<0.008	0.250	0.125	0.110	
	VPET 220.5 MFL-JPP	VPET110302MFL-JPP	●●				<0.008	0.250	0.125	0.110	
	JRP										
	VPET 63X MFR-JRP	VPET0802008MFR-JRP	●●				<0.003	0.187	0.094	0.091	
	VPET 63X MFL-JRP	VPET0802008MFL-JRP	●●				<0.003	0.187	0.094	0.091	
VPET 630 MFR-JRP	VPET080201MFR-JRP	●●				<0.004	0.187	0.094	0.091		
VPET 630 MFL-JRP	VPET080201MFL-JRP	●●				<0.004	0.187	0.094	0.091		
VPET 630.4 MFR-JRP	VPET0802018MFR-JRP	●●				<0.007	0.187	0.094	0.091		
VPET 630.4 MFL-JRP	VPET0802018MFL-JRP	●●				<0.007	0.187	0.094	0.091		
VPET 630.5 MFR-JRP	VPET080202MFR-JRP	●●				<0.008	0.187	0.094	0.091		
VPET 630.5 MFL-JRP	VPET080202MFL-JRP	●●				<0.008	0.187	0.094	0.091		
VPET 22X MFR-JRP	VPET1103008MFR-JRP	●●				<0.003	0.250	0.125	0.110		
VPET 22X MFL-JRP	VPET1103008MFL-JRP	●●				<0.003	0.250	0.125	0.110		
VPET 220 MFR-JRP	VPET110301MFR-JRP	●●				<0.004	0.250	0.125	0.110		
VPET 220 MFL-JRP	VPET110301MFL-JRP	●●				<0.004	0.250	0.125	0.110		
VPET 220.4 MFR-JRP	VPET1103018MFR-JRP	●●				<0.007	0.250	0.125	0.110		
VPET 220.4 MFL-JRP	VPET1103018MFL-JRP	●●				<0.007	0.250	0.125	0.110		
VPET 220.5 MFR-JRP	VPET110302MFR-JRP	●●				<0.008	0.250	0.125	0.110		
VPET 220.5 MFL-JRP	VPET110302MFL-JRP	●●				<0.008	0.250	0.125	0.110		

*Corner radius (RE) with a sign of inequality (<) means minus tolerance.

● : Line up

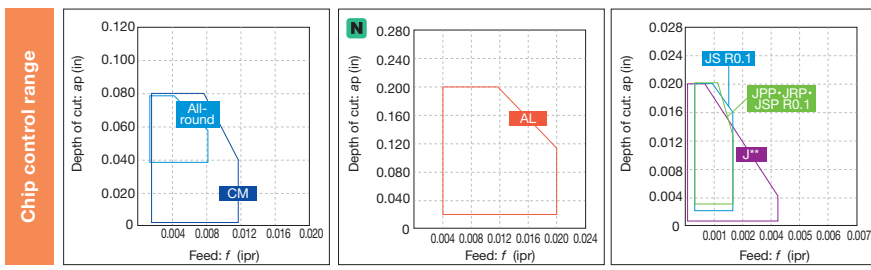

Reference pages: VPET...: J-Series toolholder → G030 -

- Grade **A**
- Insert **B**
- Toolholder **C**
- Ext. Toolholder **D**
- Int. Toolholder **E**
- Threading **F**
- Grooving **G**
- Miniature Tool **H**
- Milling Cutter **I**
- Endmill **J**
- Drilling Tool **K**
- Tooling System **L**
- User's Guide **M**

Insert POSITIVE TYPE

- : Continuous cutting
- : Light interrupted cutting
- ✱ : Heavy interrupted cutting

VP

Rhombic, 35° with hole
Positive 11°



P	Steel	●●●●																				
M	Stainless	●●●●																				
K	Cast iron																					
N	Non-ferrous																					
S	Superalloy	●●																				
H	Hard material																					

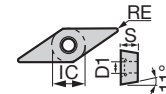

Application	Chipbreaker	Designation		Coated		Dimension (inch)			
		Inch	Metric	SH725	SH730	RE	IC	S	D1
		JSP		VPET 63X MFN-JSP	VPET0802008MFN-JSP	●●		<0.003	0.187
For external turning on Swiss lathes (sharp edge)		VPET 630 MFN-JSP	VPET080201MFN-JSP	●●		<0.004	0.187	0.094	0.091
		VPET 630.4 MFN-JSP	VPET0802018MFN-JSP	●●		<0.007	0.187	0.094	0.091
		VPET 630.5 MFN-JSP	VPET080202MFN-JSP	●●		<0.008	0.187	0.094	0.091
		VPET 22X MFN-JSP	VPET1103008MFN-JSP	●●		<0.003	0.250	0.125	0.110
		VPET 220 MFN-JSP	VPET110301MFN-JSP	●●		<0.004	0.250	0.125	0.110
		VPET 220.4 MFN-JSP	VPET1103018MFN-JSP	●●		<0.007	0.250	0.125	0.110
		VPET 220.5 MFN-JSP	VPET110302MFN-JSP	●●		<0.008	0.250	0.125	0.110

*Corner radius (RE) with a sign of inequality (<) means minus tolerance. ● : Line up

Insert POSITIVE TYPE / DOUBLE SIDE

VX

Rhombic, 35° with hole



P	Steel	●●																				
M	Stainless	●●																				
K	Cast iron																					
N	Non-ferrous																					
S	Superalloy																					
H	Hard material																					

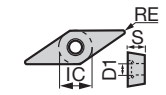

Application	Chipbreaker	Designation		Coated		Dimension (inch)			
		Inch	Metric	SH725		RE	IC	S	D1
		JRP		VXGU 73.50MFRE-JRP	VXGU09T201MFRE-JRP	●		<0.004	0.219
Finishing (sharp edge)		VXGU 73.50MFLE-JRP	VXGU09T201MFLE-JRP	●		<0.004	0.219	0.109	0.098
		VXGU 73.50.5MFRE-JRP	VXGU09T202MFRE-JRP	●		<0.008	0.219	0.109	0.098
		VXGU 73.50.5MFLE-JRP	VXGU09T202MFLE-JRP	●		<0.008	0.219	0.109	0.098
	JS		VXGU 73.50MFR-JS	VXGU09T201MFR-JS	●		<0.004	0.219	0.109
Finishing to medium cutting (sharp edge)		VXGU 73.50MFL-JS	VXGU09T201MFL-JS	●		<0.004	0.219	0.109	0.098
		VXGU 73.50.5MFR-JS	VXGU09T202MFR-JS	●		<0.008	0.219	0.109	0.098
		VXGU 73.50.5MFL-JS	VXGU09T202MFL-JS	●		<0.008	0.219	0.109	0.098
		VXGU 73.51MFR-JS	VXGU09T204MFR-JS	●		<0.016	0.219	0.109	0.098
		VXGU 73.51MFL-JS	VXGU09T204MFL-JS	●		<0.016	0.219	0.109	0.098

*Corner radius (RE) with a sign of inequality (<) means minus tolerance. ● : Line up

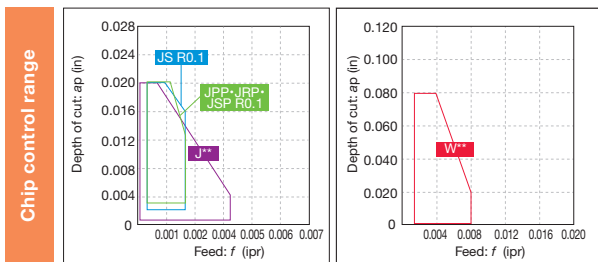

*Chip control range with typical R0.1

Reference pages: WPMT...: External toolholder → **C104** VXGU...: External toolholder → **C059 -**
 VPET... : J-Series toolholder → **G030 -**

● : Continuous cutting
 ● : Light interrupted cutting
 ✱ : Heavy interrupted cutting

Insert POSITIVE TYPE

WP



**Trigon, 80°
with hole
Positive 11°**

P	Steel	●	●	●	●	●															
M	Stainless	●	●	●	●	●															
K	Cast iron	●	●	●	●	●															
N	Non-ferrous																				
S	Superalloy												●	●							
H	Hard material																				

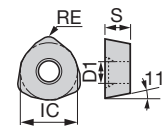

Application	Chipbreaker		Coated					Dimension (inch)				
	Designation		T9215	T9225	T9115	T9125	AH120	RE	IC	S	D1	
	Inch	Metric										
Heavy cutting	ML	-	WPMT090725ZPR-ML	●	●	▲	▲	●	0.098	0.591	0.276	0.217
		-	WPMT090725ZPL-ML	●	●	▲	▲	●	0.098	0.591	0.276	0.217

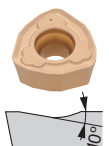

● : Line up
 ▲ : To be discontinued

WB



**Trigon, 80°
with hole
Positive 5°**

P	Steel	●	●	●	●				●	●											
M	Stainless	●	●	●	●					●	●										
K	Cast iron	●						●	●	●											
N	Non-ferrous									●											
S	Superalloy	●		●	●																
H	Hard material																				

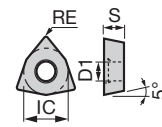

Application	Chipbreaker		Coated		Cermet	Uncoated		Dimension (inch)						
	Designation		GH110	SH725	SH730	NS9530	TH10	UX30	RE	IC	S	D1		
	Inch	Metric												
Finishing		W08	WBGT 52V R-W08	WBGT030100R-W08						0.001	0.156	0.063	0.091	
			WBGT 52V L-W08	WBGT030100L-W08						0.001	0.156	0.063	0.091	
			WBGT 520 R-W08	WBGT030101R-W08					●	●	0.004	0.156	0.063	0.091
			WBGT 520 L-W08	WBGT030101L-W08							0.004	0.156	0.063	0.091
			WBGT 520.5 R-W08	WBGT030102R-W08							0.008	0.156	0.063	0.091
			WBGT 520.5 L-W08	WBGT030102L-W08	●	●			●	●	0.008	0.156	0.063	0.091
			WBGT 521 R-W08	WBGT030104R-W08							0.016	0.156	0.063	0.091
			WBGT 521 L-W08	WBGT030104L-W08	●	●			●	●	0.016	0.156	0.063	0.091
Finishing (sharp edge)		W08	WBGT 52V FR-W08	WBGT030100FR-W08						0.001	0.156	0.063	0.091	
			WBGT 52V FL-W08	WBGT030100FL-W08						0.001	0.156	0.063	0.091	
			WBGT 520 FR-W08	WBGT030101FR-W08							0.004	0.156	0.063	0.091
			WBGT 520 FL-W08	WBGT030101FL-W08							0.004	0.156	0.063	0.091
			WBGT 520.5 FR-W08	WBGT030102FR-W08							0.008	0.156	0.063	0.091
			WBGT 520.5 FL-W08	WBGT030102FL-W08							0.008	0.156	0.063	0.091
			WBGT 521 FR-W08	WBGT030104FR-W08							0.016	0.156	0.063	0.091
			WBGT 521 FL-W08	WBGT030104FL-W08							0.016	0.156	0.063	0.091

● : Line up

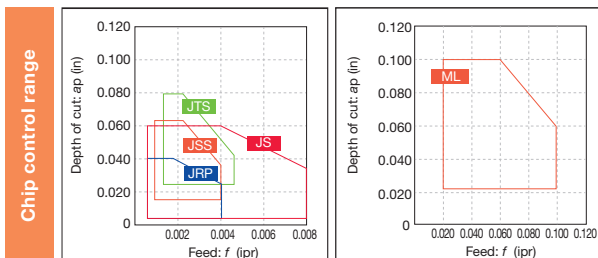

Reference pages: Internal toolholder → **D083**

Grade
Insert
Toolholder
Ext. Toolholder
Int. Toolholder
Threading
Grooving
Miniature Tool
Endmill
Drilling Tool
Tooling System
User's Guide
Index



Insert POSITIVE TYPE

● : Continuous cutting
 ● : Light interrupted cutting
 ❖ : Heavy interrupted cutting

WB



Trigon, 80° with hole Positive 5°

	P	M	K	N	S	H
Steel	●●●●●					
Stainless	●●●●●					
Cast iron	●					
Non-ferrous						
Superalloy	●	●●				
Hard material						

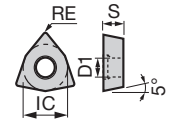

Application	Chipbreaker	Designation		Coated			Cermet			Dimension (inch)				
		Inch	Metric	GH110	SH725	SH730	NS9530	RE	IC	S	D1			
Finishing (sharp edge)		W11	WBGT 520.5 L-W11	WBGT060102L-W11	●			●			0.008	0.156	0.063	0.091
			WBGT 521 L-W11	WBGT060104L-W11				●			0.016	0.156	0.063	0.091
			WBGT 630.5 L-W11	WBGT080202L-W11				●			0.008	0.187	0.094	0.091
			WBGT 631 L-W11	WBGT080204L-W11				●			0.016	0.187	0.094	0.091
For internal turning on Swiss lathes		JS	WBGT 520 R-JS	WBGT030101R-JS		●					<0.004	0.156	0.063	0.091
			WBGT 520 L-JS	WBGT030101L-JS		●					<0.004	0.156	0.063	0.091
			WBGT 520.5 R-JS	WBGT030102R-JS		●					<0.008	0.156	0.063	0.091
			WBGT 520.5 L-JS	WBGT030102L-JS		●					<0.008	0.156	0.063	0.091
			WBGT 521 R-JS	WBGT030104R-JS		●					<0.016	0.156	0.063	0.091
			WBGT 521 L-JS	WBGT030104L-JS		●					<0.016	0.156	0.063	0.091
For internal turning on Swiss lathes (sharp edge)		JS	WBGT 520 FR-JS	WBGT030101FR-JS	●						<0.004	0.156	0.063	0.091
			WBGT 520 FL-JS	WBGT030101FL-JS	●						<0.004	0.156	0.063	0.091
			WBGT 520.5 FR-JS	WBGT030102FR-JS	●						<0.008	0.156	0.063	0.091
			WBGT 520.5 FL-JS	WBGT030102FL-JS	●						<0.008	0.156	0.063	0.091
			WBGT 521 FR-JS	WBGT030104FR-JS	●						<0.016	0.156	0.063	0.091
	WBGT 521 FL-JS	WBGT030104FL-JS	●						<0.016	0.156	0.063	0.091		

*Corner radius (RE) with a sign of inequality (<) means minus tolerance.

● : Line up

Insert POSITIVE TYPE / DOUBLE SIDE

- : Continuous cutting
- ◐ : Light interrupted cutting
- ◑ : Heavy interrupted cutting

WX

Trigon, 80°
with hole

P	Steel	●	●																	
M	Stainless	●	●																	
K	Cast iron	●																		
N	Non-ferrous																			
S	Superalloy	●																		
H	Hard material																			

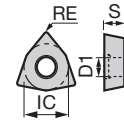

Application	Chipbreaker		Designation		Coated		Dimension (inch)			
	Inch	Metric	AH725	SH725	RE	IC	S	D1		
Finishing to medium cutting (sharp edge)		JS	WXGU 220MFR JS	WXGU040301MFR-JS	●	<0.004	0.250	0.125	0.106	
			WXGU 220MFL JS	WXGU040301MFL-JS	●	<0.004	0.250	0.125	0.106	
			WXGU 220.5MFR JS	WXGU040302MFR-JS	●	<0.008	0.250	0.125	0.106	
			WXGU 220.5MFL JS	WXGU040302MFL-JS	●	<0.008	0.250	0.125	0.106	
			WXGU 221MFR JS	WXGU040304MFR-JS	●	<0.016	0.250	0.125	0.106	
			WXGU 221MFL JS	WXGU040304MFL-JS	●	<0.016	0.250	0.125	0.106	
		JTS	WXGU 220MFR JTS	WXGU040301MFR-JTS	●	<0.004	0.250	0.125	0.106	
			WXGU 220MFL JTS	WXGU040301MFL-JTS	●	<0.004	0.250	0.125	0.106	
			WXGU 220.5MFR JTS	WXGU040302MFR-JTS	●	<0.008	0.250	0.125	0.106	
			WXGU 220.5MFL JTS	WXGU040302MFL-JTS	●	<0.008	0.250	0.125	0.106	
Finishing to medium cutting		JTS	WXGU 220MR JTS	WXGU040301MR-JTS	●	<0.004	0.250	0.125	0.106	
			WXGU 220ML JTS	WXGU040301ML-JTS	●	<0.004	0.250	0.125	0.106	
			WXGU 220.5MR JTS	WXGU040302MR-JTS	●	<0.008	0.250	0.125	0.106	
			WXGU 220.5ML JTS	WXGU040302ML-JTS	●	<0.008	0.250	0.125	0.106	

*Corner radius (RE) with a sign of inequality (<) means minus tolerance.

● : Line up

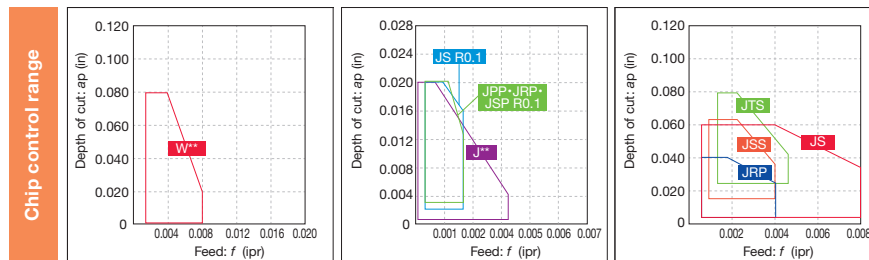

*Chip control range with typical R0.1

Reference pages: WXGU...: External toolholder → C033 -, Internal toolholder → D034

Grade A, Insert B, Toolholder C, D, E, F, G, H, I, J, K, L, M

Insert POSITIVE TYPE

● : Continuous cutting
 ● : Light interrupted cutting
 ✱ : Heavy interrupted cutting

WX



Trigon, 80° with hole

P	Steel	●	●	●	●	●	●	●	●	●	●	●	●	●	●	●	●	●	●	●	●
M	Stainless	●	●	●	●	●	●	●	●	●	●	●	●	●	●	●	●	●	●	●	●
K	Cast iron	●	●	●	●	●	●	●	●	●	●	●	●	●	●	●	●	●	●	●	●
N	Non-ferrous	●	●	●	●	●	●	●	●	●	●	●	●	●	●	●	●	●	●	●	●
S	Superalloy	●	●	●	●	●	●	●	●	●	●	●	●	●	●	●	●	●	●	●	●
H	Hard material	●	●	●	●	●	●	●	●	●	●	●	●	●	●	●	●	●	●	●	●

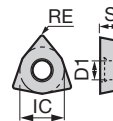

Application	Chipbreaker	Designation		Coated			Coated cermet		Cermet	Uncoated		Dimension (inch)					
				AH725	AH8015	SH725	GT9530	NS9530	KS05F	RE	IC	S	D1				
		Inch	Metric														
Finishing (low cutting force) (sharp edge)		JSS	WXGU 220MFR JSS	WXGU040301MFR-JSS	●	●	●	●	●	●	●	●	<0.004	0.250	0.125	0.106	
			WXGU 220MFL JSS	WXGU040301MFL-JSS	●	●	●	●	●	●	●	●	●	<0.004	0.250	0.125	0.106
			WXGU 220.5MFR JSS	WXGU040302MFR-JSS	●	●	●	●	●	●	●	●	●	<0.008	0.250	0.125	0.106
			WXGU 220.5MFL JSS	WXGU040302MFL-JSS	●	●	●	●	●	●	●	●	●	<0.008	0.250	0.125	0.106
Finishing (low cutting force)		JSS	WXGU 220MR JSS	WXGU040301MR-JSS	●	●	●	●	●	●	●	●	<0.004	0.250	0.125	0.106	
			WXGU 220ML JSS	WXGU040301ML-JSS	●	●	●	●	●	●	●	●	<0.004	0.250	0.125	0.106	
			WXGU 220.5MR JSS	WXGU040302MR-JSS	●	●	●	●	●	●	●	●	<0.008	0.250	0.125	0.106	
			WXGU 220.5ML JSS	WXGU040302ML-JSS	●	●	●	●	●	●	●	●	<0.008	0.250	0.125	0.106	
Finishing to medium cutting		TS	WXGU 220.5R TS	WXGU040302R-TS	●	●	●	●	●	●	●	●	0.008	0.250	0.125	0.106	
			WXGU 220.5L TS	WXGU040302L-TS	●	●	●	●	●	●	●	●	0.008	0.250	0.125	0.106	
			WXGU 221R TS	WXGU040304R-TS	●	●	●	●	●	●	●	●	0.016	0.250	0.125	0.106	
			WXGU 221L TS	WXGU040304L-TS	●	●	●	●	●	●	●	●	0.016	0.250	0.125	0.106	
			WXGU 222R TS	WXGU040308R-TS	●	●	●	●	●	●	●	●	0.031	0.250	0.125	0.106	
Finishing (wiper)		TSW	WXGU 221R TSW	WXGU040304R-TSW	●	●	●	●	●	●	●	●	0.016	0.250	0.125	0.106	
			WXGU 221L TSW	WXGU040304L-TSW	●	●	●	●	●	●	●	●	0.016	0.250	0.125	0.106	
			WXGU 222R TSW	WXGU040308R-TSW	●	●	●	●	●	●	●	●	0.031	0.250	0.125	0.106	
			WXGU 222L TSW	WXGU040308L-TSW	●	●	●	●	●	●	●	●	0.031	0.250	0.125	0.106	
Finishing (low cutting force)		SS	WXGU 220.5R SS	WXGU040302R-SS	●	●	●	●	●	●	●	●	0.008	0.250	0.125	0.106	
			WXGU 220.5L SS	WXGU040302L-SS	●	●	●	●	●	●	●	●	0.008	0.250	0.125	0.106	
			WXGU 221R SS	WXGU040304R-SS	●	●	●	●	●	●	●	●	0.016	0.250	0.125	0.106	
			WXGU 221L SS	WXGU040304L-SS	●	●	●	●	●	●	●	●	0.016	0.250	0.125	0.106	

*Corner radius (RE) with a sign of inequality (<) means minus tolerance.

● : Line up

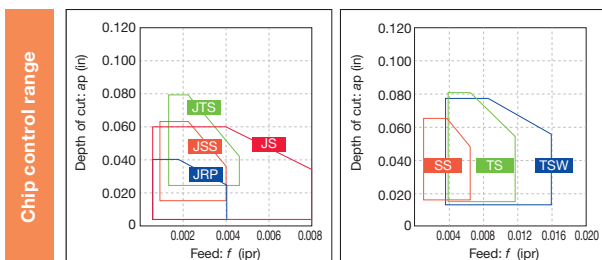

Reference pages: WXGU...: External toolholder → C033 -, Internal toolholder → D034

Insert POSITIVE TYPE

- : Continuous cutting
- ◐ : Light interrupted cutting
- ◑ : Heavy interrupted cutting

YW



**Rhombic, 25°
with hole
Positive 7°**

P	Steel	●●	●●																	
M	Stainless	●●	●●																	
K	Cast iron	●●	●●																	
N	Non-ferrous	●●	●●																	
S	Superalloy	●●	●●																	
H	Hard material																			

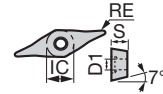

Application	Chipbreaker	Designation		Coated		Coated cermet		Dimension (inch)						
		Inch	Metric	T9225	T9125	GT9530	RE	IC	S	D1				
Finishing to medium cutting	ZF	-	YWMT11T202-ZF	●	▲	●					0.008	0.184	0.109	0.091
		-	YWMT11T204-ZF	●	▲	●					0.016	0.184	0.109	0.091
		-	YWMT16T302-ZF	●	▲	●					0.008	0.276	0.156	0.113
		-	YWMT16T304-ZF	●	▲	●					0.016	0.276	0.156	0.113
		-	YWMT16T308-ZF	●	▲	●					0.031	0.276	0.156	0.113
	ZM	-	YWMT11T204-ZM	●	▲	●					0.016	0.184	0.109	0.091
Finishing to fine cutting	ZM	-	YWMT16T304-ZM	●	▲	●					0.016	0.276	0.156	0.113
		-	YWMT16T308-ZM	●	▲	●					0.031	0.276	0.156	0.113

JXF



Front turning

P	Steel	●●	●●																	
M	Stainless	●●	●●																	
K	Cast iron	●●	●●																	
N	Non-ferrous	●●	●●																	
S	Superalloy	●●	●●																	
H	Hard material																			

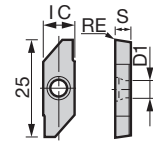

Application	Chipbreaker	Designation		Coated		Uncoated		Dimension (inch)						
		Inch	Metric	J740	TH10	RE	IC	S	D1					
Front turning	-	-	JXFR8000F	●	●						0.001	0.315	0.156	0.173
		-	JXFR8010F	●	●						0.004	0.315	0.156	0.173

- : Line up
- ▲ : To be discontinued

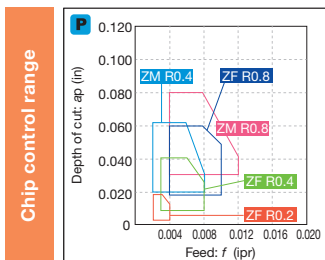

Reference pages: External toolholder → **C069, C136** Internal toolholder → **D084**
 JXF...: J-Series toolholder → **G056 -**



Insert POSITIVE TYPE

● : Continuous cutting
 ● : Light interrupted cutting
 ✱ : Heavy interrupted cutting

JXR



Reverse turning

	P	M	K	N	S	H
Steel	●●					
Stainless	●●					
Cast iron			●			
Non-ferrous				●		
Superalloy					●	
Hard material						

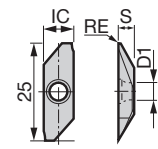

Application	Chipbreaker	Designation		Coated		Uncoated		Dimension (inch)			
		Inch	Metric	J740	TH10	RE	IC	S	D1		
Reverse turning	-	-	JXRR8000F	●		●		0.001	0.315	0.156	0.173
		-	JXRR8010F	●		●		0.004	0.315	0.156	0.173

JXB



Back turning

	P	M	K	N	S	H
Steel	●●					
Stainless	●●					
Cast iron			●			
Non-ferrous				●		
Superalloy					●	
Hard material						

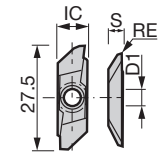

Application	Chipbreaker	Designation		Coated		Uncoated		Dimension (inch)			
		Inch	Metric	J740	TH10	RE	IC	S	D1		
Back turning	-	-	JXBR8000F	●		●		0.001	0.315	0.156	0.173
		-	JXBL8000F	●		●		0.001	0.315	0.156	0.173
		-	JXBR8005F	●		●		0.002	0.315	0.156	0.173
		-	JXBL8005F	●		●		0.002	0.315	0.156	0.173
		-	JXBR8005	●		●		0.002	0.315	0.156	0.173
		-	JXBL8005	●		●		0.002	0.315	0.156	0.173
		-	JXBR8010F	●		●		0.004	0.315	0.156	0.173
		-	JXBL8010F	●		●		0.004	0.315	0.156	0.173
		-	JXBR8010	●		●		0.004	0.315	0.156	0.173
		-	JXBL8010	●		●		0.004	0.315	0.156	0.173
		-	JXBR8015F	●		●		0.006	0.315	0.156	0.173
		-	JXBL8015F	●		●		0.006	0.315	0.156	0.173
		-	JXBR8015	●		●		0.006	0.315	0.156	0.173
		-	JXBL8015	●		●		0.006	0.315	0.156	0.173

● : Line up

Reference pages: JXF..., JXR..., JXB...: J-Series toolholder → G056 -

- : Continuous cutting
- : Light interrupted cutting
- ⊛ : Heavy interrupted cutting

Insert POSITIVE TYPE

JTB*



P Steel	●●●●	●●	●●	●
M Stainless	●●●●			●
K Cast iron	●●	●●	●●	●
N Non-ferrous				●
S Superalloy				
H Hard material				

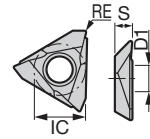

Application	Chipbreaker	Designation	Coated				Coated cermet		Cermet	Uncoated	Dimension (inch)			
			SH725	J740	J9530	NS9530	TH10	RE	IC	S	D1			
		Inch	Metric											
Back turning		-	-	JTBR3000F	●	●				●	0.001	0.374	0.125	0.173
				JTBL3000F	●	●				●	0.001	0.374	0.125	0.173
				JTBR3005F	●	●				●	0.002	0.374	0.125	0.173
				JTBL3005F	●	●				●	0.002	0.374	0.125	0.173
				JTBR3005		●	●				0.002	0.374	0.125	0.173
				JTBL3005		●					0.002	0.374	0.125	0.173
				JTBR3010F	●	●			●	●	0.004	0.374	0.125	0.173
				JTBL3010F	●	●			●	●	0.004	0.374	0.125	0.173
				JTBR3010		●	●				0.004	0.374	0.125	0.173
				JTBL3010		●					0.004	0.374	0.125	0.173
				JTBR3015F	●	●					0.006	0.374	0.125	0.173
				JTBL3015F	●						0.006	0.374	0.125	0.173

J10E*



P Steel	●●●●	●●	●●	●
M Stainless	●●●●			●
K Cast iron	●●	●●	●●	●
N Non-ferrous				●
S Superalloy				
H Hard material				

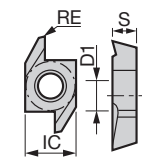

Application	Chipbreaker	Designation	Coated				Coated cermet		Cermet	Uncoated	Dimension (inch)			
			SH725	J740	J9530	NS9530	TH10	RE	IC	S	D1			
		Inch	Metric											
Back turning		-	-	J10ER005BF	●	●			●	●	0.002	0.250	0.125	0.118
				J10EL005BF	●	●			●	●	0.002	0.250	0.125	0.118
				J10ER005B		●	●				0.002	0.250	0.125	0.118
				J10EL005B		●					0.002	0.250	0.125	0.118
				J10ER010BF	●	●			●	●	0.004	0.250	0.125	0.118
				J10EL010BF	●	●			●	●	0.004	0.250	0.125	0.118
				J10ER010B		●	●				0.004	0.250	0.125	0.118
				J10EL010B		●					0.004	0.250	0.125	0.118
				J10EL015BF	●						0.006	0.250	0.125	0.118
				J10ER015BF	●						0.006	0.250	0.125	0.118

● : Line up

Index User's Guide Tooling System Drilling Tool Endmill Milling Cutter Miniature Tool Grooving Threading Int. Toolholder Ext. Toolholder Insert Grade



Negative

Positive

PCD / CBN

C

D

G

R

S

T

V

W

Y

OTHERS

Insert POSITIVE TYPE

- : Continuous cutting
- ◐ : Light interrupted cutting
- ◑ : Heavy interrupted cutting

10E*



Back turning

Material	Application
P Steel	●
M Stainless	●
K Cast iron	●
N Non-ferrous	●
S Superalloy	●
H Hard material	

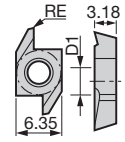

Application	Chipbreaker	Designation	Uncoated								Dimension (inch)				
			TH10								RE	IC	S	D1	
		Inch	Metric												
Back turning		-	10ER100B	●								0.001	0.250	0.125	0.118
		-	10EL100B	●								0.001	0.250	0.125	0.118
		-	10ER150B	●								0.001	0.250	0.125	0.118
		-	10EL150B	●								0.001	0.250	0.125	0.118
		-	10ER300	●								-	0.250	0.125	0.118
		-	10EL300	●								-	0.250	0.125	0.118

● : Line up

BXA10, BXA20

- Coated CBN grade for hardened steel



Incredible reliability in hardened steel turning

APPLICATION AREA

The best suitable grade can be selected for your application requirements

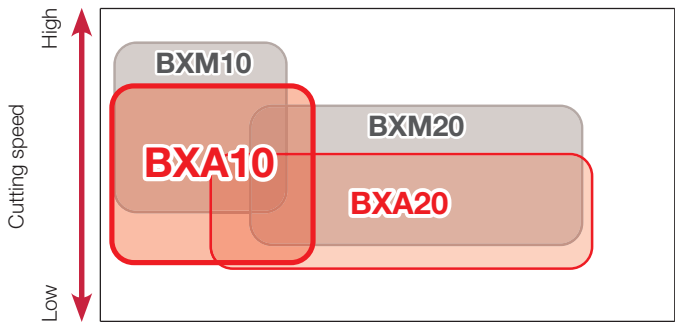

BXA10

First choice for continuous to light interrupted cuts
For $V_c = 230$ m/min or less

BXA20

First choice for light to heavy interrupted cuts
For $V_c = 180$ m/min or less

BXM10

Complementary grade for continuous to light interrupted cuts
For extremely high cutting speeds of $V_c = 300$ m/min

BXM20

Complementary grade for light to heavy interrupted cuts
For high cutting speeds of $V_c = 200$ m/min

GRADE PROPERTIES

BXA10

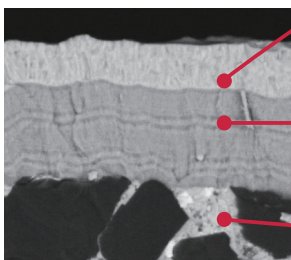

TiCN layer with high thermal stability and wear resistance

TiAlN layer with good adhesion and resistance to delamination and chipping

Dedicated CBN substrate with excellent flank wear and crater wear resistance

BXA20

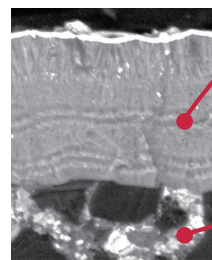

Extremely thick TiAlN coating (max 3.5x thicker than existing grades) with good adhesion and delamination resistance enhances the grade's wear and fracture resistance

Dedicated CBN substrate with excellent fracture resistance

Grade
Insert
Ext. Toolholder
Int. Toolholder
Threading
Grooving
Miniature Tool
Milling Cutter
Endmill
Drilling Tool
Tooling System
User's Guide
Index



T-CBN SERIES

- WavyJoint



For **high efficiency** hardened steel machining

■ New brazing technology for increased machining efficiency - "WavyJoint"

- A maximum depth of cut up to 0.8 mm
- Reduces the number of passes to increase productivity



Strong joint

WavyJoint BXA20

Vs.

Standard

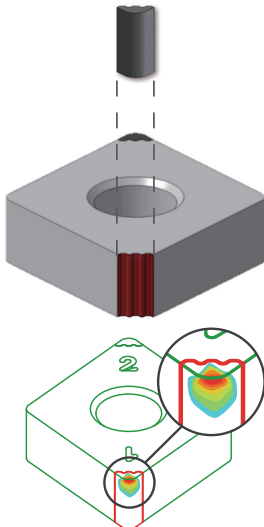

CBN tip size:
Using the CBN tip in a mass as large as **200%** provides increased thermal conductivity and helps reduce the temperature at the cutting edge

Brazing area:

Increased **160%** for enhanced brazing strength

Temperature during machining is concentrated on the CBN tip, reducing temperature issues in the brazing zone.

Workpiece material : 4140 (60HRC)
Cutting speed : $V_c = 492$ sfm
Feed : $f_z = 0.008$ ipr
Depth of cut : $a_p = 0.030$ "
Coolant : Dry

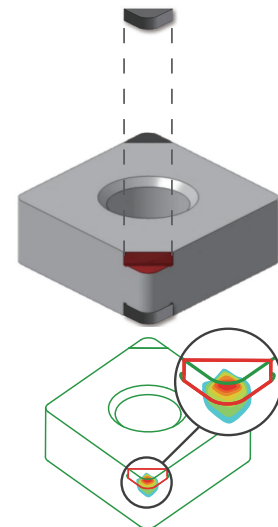

■ APPLICATION AREA

Hard Turning

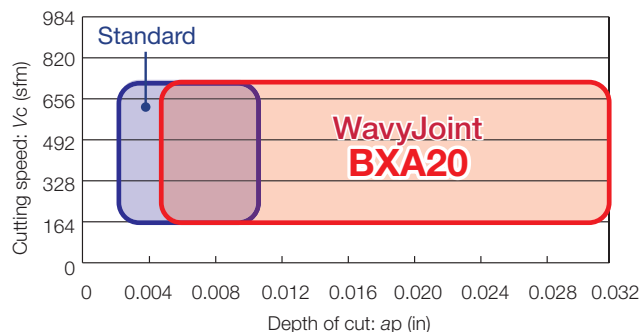

H

WavyJoint BXA20
Great performance for continuous to heavy interrupted cutting at low and medium speeds.

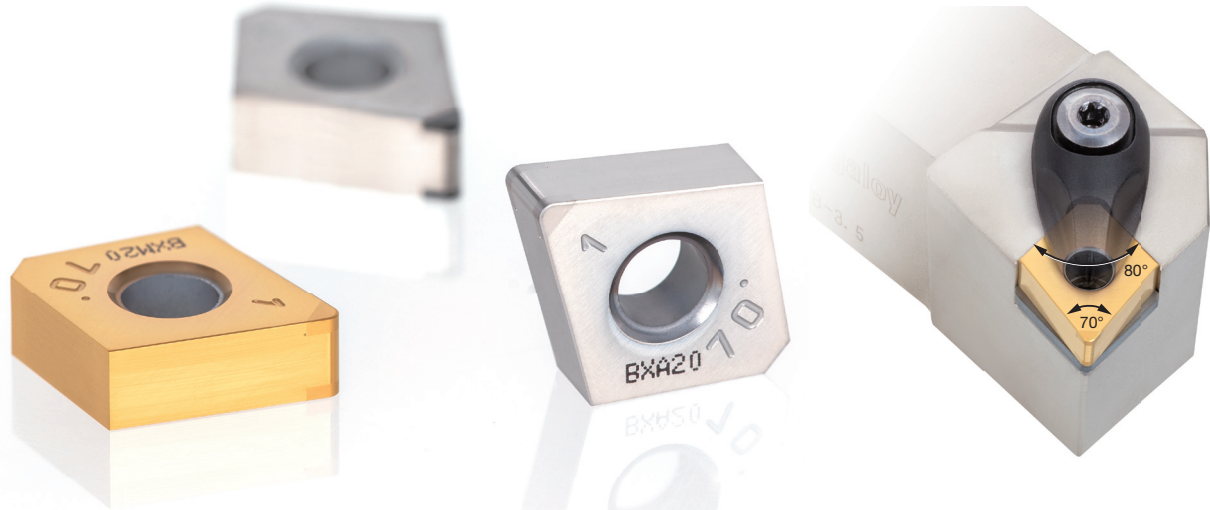

For **high efficiency in finishing** hardened steel, cast iron and sintered metals

■ Chip control in face turning

Continuous cutting

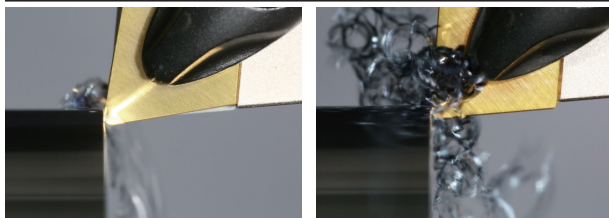

GNGA type
Corner angle: 70°

CNGA type
Corner angle: 80°

Since GNGA type inserts have enough space for chip flow, chip packing doesn't occur, improving surface finish and preventing sudden chipping on cutting edge. Existing standard toolholders for CNGA1204 can be used.

Interrupted cutting



GNGA type
Corner angle: 70°

CNGA type
Corner angle: 80°

H Toolholder : ACLNL2525M12-A
Insert : 2QP-GNGA 432 BXM20
2QP-CNGA 432 BXM20
Workpiece material : 4140 (60HRC)
Cutting speed : $V_c = 492$ sfm
Feed : $f = 0.004$ ipr
Depth of cut : $a_p = 0.005$ "
Machining : Face turning
Coolant : Dry

■ CUTTING PERFORMANCE

Cutting force
(Thrust force)

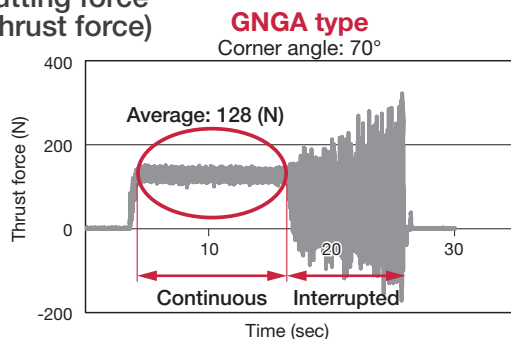

GNGA type has large clearance and reduces cutting force compared to the regular CNGA type.

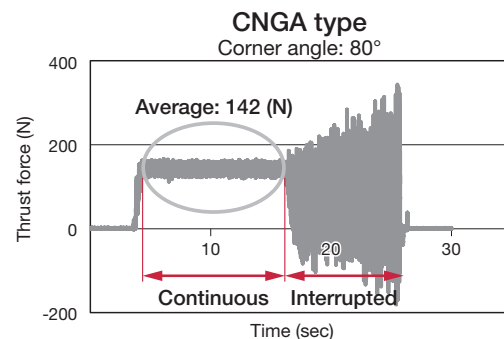

H Toolholder : ACLNL2525M12-A
Insert : 2QP-GNGA 432 BXM20
2QP-CNGA 432 BXM20
Workpiece material : 4140 (59HRC)
Cutting speed : $V_c = 492$ sfm
Feed : $f = 0.006$ ipr
Depth of cut : $a_p = 0.005$ "
Machining : Face turning
Coolant : Dry

Grade
Insert
Ext. Toolholder
Int. Toolholder
Threading
Grooving
Milling Cutter
Miniature Tool
Endmill
Drilling Tool
Tooling System
User's Guide
Index

A
B
C
D
E
F
G
H
I
J
K
L
M

HARDBREAKER HP

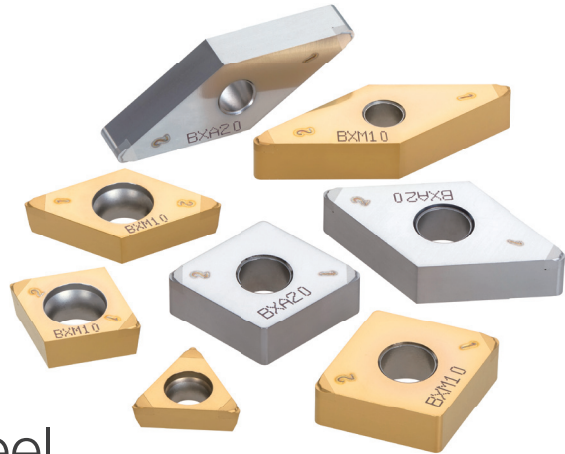

New HP Chipbreaker for Finishing Hardened Steel

- 1 By separating the chipbreaker from the cutting edge, the cutting force imposed on the cutting edge during machining is significantly reduced, thus providing long tool life.
- 2 The cutting edge preparation is designed to ensure easy cutting at low cutting forces, while maintaining close tolerances with no deviations.
- 3 The HP style chipbreaker, combined with built-in wipers, yields excellent surface quality and good chip control.

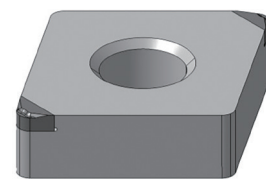

Optimized edge preparation for low cutting force

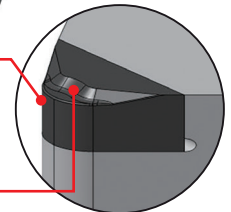

HP chipbreaker

APPLICATION AREA

For negative insert

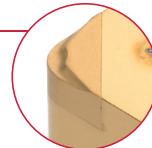
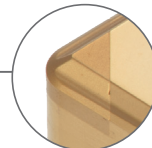
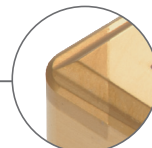
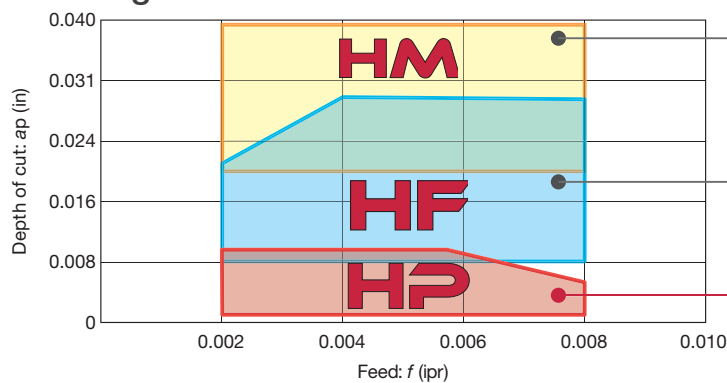

HP

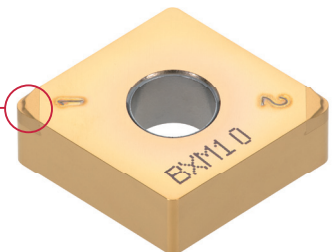

For positive insert

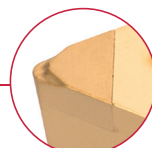
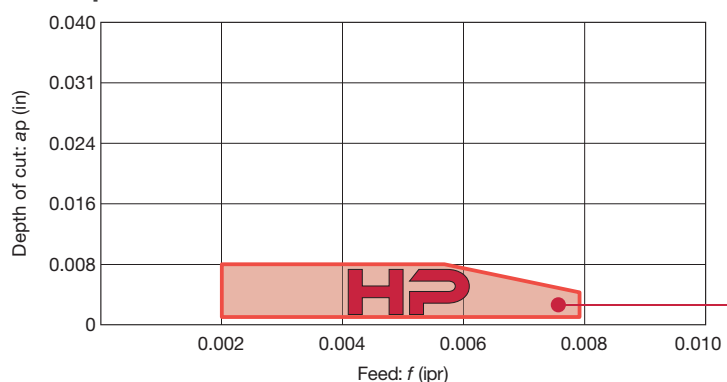

HP

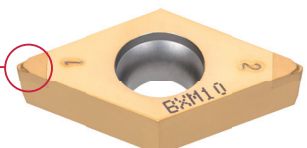

Designation System for T-CBN (PCBN) Inserts

One-use type

2 **QP** - **CNGA120404** - **L**

1 Number of corners

2 Type

QP	One-use inserts
QS	WavyJoint

3 ISO symbol

4 Special feature & chipbreaker

Without	Standard cutting edge	W	With wiper
F	Sharp edge	W□	With wiper
-L	Excellent wear resistance	-HF	With chipbreaker
-LF	Lower cutting force, superior sharpness	-HM	With chipbreaker
-LC	Excellent crater wear resistance	-HP	With chipbreaker
-H	Excellent fracture resistance		

One-use type (10 pieces per package)

T **2** **QP** - **CNGA120408**

1 "T" means 10 pieces per package.

Regrindable type

TNGA160402 - **QBN**

1 ISO symbol

2 CBN inserts

T-CBN (PCBN tipped) grooving inserts

XG **R** **63** **10** **S** - **QBN**

1 For grooving tool GX-type

2 Hand of Insert

L	Left
R	Right

3 Groove width (mm)

10	1.0
15	1.5

4 Corner radius: RE (mm)

S	0.2
---	-----

5 CBN inserts

For TUNGCUT

S **G** **N** **200** - **020**

1 Number of edge

S	Single corner
---	---------------

2 Application

G	Grooving
---	----------

3 For use

N	Non breaker
---	-------------

4 Groove width (mm)

200	2.0
-----	-----

5 Corner radius: RE (mm)

020	0.2
-----	-----

Designation System for T-DIA (PCD) Inserts

One-use type

1 **QP** - **TCMT110304**

1 Number of corners

2 Type

QP	One-use inserts
----	-----------------

3 ISO symbol

Regrindable type

TPGW110204 - **DIA**

1 ISO symbol

2 PCD inserts

Grade
Insert
Ext. Toolholder
Int. Toolholder
Threading
Grooving
Milling Cutter
Miniature Tool
Endmill
Drilling Tool
Tooling System
User's Guide
Index



- : Continuous cutting
- ◐ : Light interrupted cutting
- ⊛ : Heavy interrupted cutting

CBN Insert NEGATIVE TYPE

Negative

Positive

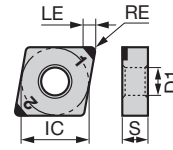

P	Steel												
M	Stainless												
K	Cast iron										●●	⊛	●●
N	Non-ferrous												
S	Superalloy												
H	Hard material			●●	●●	●●	●●	●●	●●	●●	●●	●●	●●
	Sintered metal											●●	⊛

PCD / CBN

C

D

G

R

S









T

V

W

Y

OTHERS

Shape	Designation		Dimension (inch)										Edge prep.					Wiper				
	Inch	Metric	No. of corners	LE	RE	IC	S	D1	Standard	Sharp edge				Wiper								
										L	LF	LC	H									
	2QP-CNGA	2QP-CNGA 430.5	2QP-CNGA120402																			
		2QP-CNGA 431	2QP-CNGA120404	●	●	●	●	●	●	●	●	●	●	○								
		2QP-CNGA 432	2QP-CNGA120408	●	●	●	●	●	●	●	●	●	●	○								
		2QP-CNGA 433	2QP-CNGA120412	●	●	●	●	●	●	●	●	●	●	○								
		2QP-CNGA 434	2QP-CNGA120416			●	●							○								
		2QP-CNGA 435	2QP-CNGA120420			●	●							○								
		2QP-CNGA 436	2QP-CNGA120424			●	●							○								
	T2QP-CNGA	T2QP-CNGA 431	T2QP-CNGA120404																			
		T2QP-CNGA 432	T2QP-CNGA120408																			
	2QP-CNGA**F	2QP-CNGA 431-F	2QP-CNGA120404F																			
		2QP-CNGA 432-F	2QP-CNGA120408F																			
	2QP-CNGA**-L	2QP-CNGA 430.5-L	2QP-CNGA120402-L			●	●															
		2QP-CNGA 431-L	2QP-CNGA120404-L	●	●	●	●	●	●	●	●	●	●	○								
		2QP-CNGA 432-L	2QP-CNGA120408-L	●	●	●	●	●	●	●	●	●	●	○								
		2QP-CNGA 433-L	2QP-CNGA120412-L	●	●	●	●	●	●	●	●	●	●	○								
	2QP-CNGA**-LF	2QP-CNGA 430.5-LF	2QP-CNGA120402-LF	●	●	●																
		2QP-CNGA 431-LF	2QP-CNGA120404-LF	●	●	●	●	●	●	●	●	●	●	○								
		2QP-CNGA 432-LF	2QP-CNGA120408-LF	●	●	●	●	●	●	●	●	●	●	○								
		2QP-CNGA 433-LF	2QP-CNGA120412-LF	●	●	●								○								
	2QP-CNGA**-LC	2QP-CNGA 430.5-LC	2QP-CNGA120402-LC			●	●															
		2QP-CNGA 431-LC	2QP-CNGA120404-LC			●	●															
		2QP-CNGA 432-LC	2QP-CNGA120408-LC			●	●															
		2QP-CNGA 433-LC	2QP-CNGA120412-LC			●	●															
	2QP-CNGA**-H	2QP-CNGA 431-H	2QP-CNGA120404-H	●	●	●			●	●											○	
		2QP-CNGA 432-H	2QP-CNGA120408-H	●	●	●			●	●												
		2QP-CNGA 433-H	2QP-CNGA120412-H	●	●	●			●	●											○	
	2QP-CNGA**WL	2QP-CNGA 431-WL	2QP-CNGA120404WL	●	●	●	●														○	
		2QP-CNGA 432-WL	2QP-CNGA120408WL	●	●	●	●															
		2QP-CNGA 433-WL	2QP-CNGA120412WL	●	●	●	●														○	
	2QP-CNMA**W	2QP-CNMA 431-W	2QP-CNMA120404W							●											○	
		2QP-CNMA 432-W	2QP-CNMA120408W							●											○	
		2QP-CNMA 433-W	2QP-CNMA120412W							●											○	

*Please see the page B201 about the toolholders recommended for wiper inserts of the designation with W, WL, and WJ at the end.

● : Line up

Edge preparation specification

	BXM10	BXM20	BXA20	BX310 BXC50	BX330	BX360 BX380	BX470	BX480	BX910 BX930	BXC90
Standard	S01325	S01325	S01325	S01325	S01325	S01325	T01315	S01325	S01315	T02020
Sharp edge	-	-	-	-	-	-	F	-	-	-
-L	S01315	S01315	S01315	-	S01315	-	-	-	-	-
-LF	-	-	S00515	-	-	-	-	-	-	-
-LC	-	-	S00535	-	-	-	-	-	-	-
-H	-	S01835	S01835	-	S01335	-	-	-	-	-
Wiper	S01315	S01315	S01315	-	S01325	-	-	-	-	-

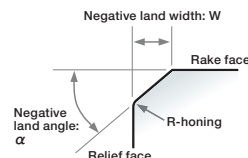

S

0

1

3

2

5

Edge prep. ID Negative land width W Negative land angle α

T ... Chamfered
S ... Chamfered + R-honing
E ... R-honing alone
F ... Sharp edge

CBN Insert NEGATIVE TYPE

● : Continuous cutting
 ● : Light interrupted cutting
 ✱ : Heavy interrupted cutting

P	Steel										
M	Stainless										
K	Cast iron								●●		
N	Non-ferrous										
S	Superalloy										
H	Hard material	●●	●●	●●	●●	✱	●●				
	Sintered metal										

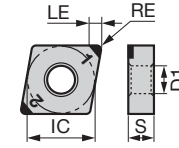

Shape	Designation		Dimension (inch)						Edge prep.															
	Inch	Metric	BXM10	BXM20	BXA10	BXA20	BXC50	BX360	BXC90	No. of corners	LE	RE	IC	S	D1	Standard	Sharp edge	L	LF	LC	H	Wiper	Chipbreaker	
 2QP-CNGM** -H*	2QP-CNGM 432-HF	2QP-CNGM120408-HF	●							2	0.087	0.031	0.500	0.187	0.203								○	
	2QP-CNGM 433-HF	2QP-CNGM120412-HF	●							2	0.094	0.047	0.500	0.187	0.203								○	
	2QP-CNGM 432-HM	2QP-CNGM120408-HM	●		●					2	0.087	0.031	0.500	0.187	0.203									○
	2QP-CNGM 433-HM	2QP-CNGM120412-HM	●		●					2	0.094	0.047	0.500	0.187	0.203									○
	2QP-CNGM431-HP	2QP-CNGM120404-HP	●	●	●					2	0.091	0.016	0.500	0.187	0.203									○
	2QP-CNGM432-HP	2QP-CNGM120408-HP	●	●	●					2	0.087	0.031	0.500	0.187	0.203									○
	2QP-CNGM433-HP	2QP-CNGM120412-HP	●	●	●					2	0.094	0.047	0.500	0.187	0.203									○
	2QP-CNGM** -WL-HP	2QP-CNGM432WLHP	2QP-CNGM120408WL-HP	●		●	●				2	0.087	0.031	0.500	0.187	0.203								○
 4QP-CNGA	4QP-CNGA 431	4QP-CNGA120404					●			4	0.091	0.016	0.500	0.187	0.203	○								
	4QP-CNGA 432	4QP-CNGA120408					●			4	0.087	0.031	0.500	0.187	0.203	○								
	4QP-CNGA 433	4QP-CNGA120412					●			4	0.094	0.047	0.500	0.187	0.203	○								
 4QP-CNMA** -W	4QP-CNMA 431-W	4QP-CNMA120404W					●			4	0.091	0.016	0.500	0.187	0.203								○	
	4QP-CNMA 432-W	4QP-CNMA120408W					●			4	0.087	0.031	0.500	0.187	0.203								○	
	4QP-CNMA 433-W	4QP-CNMA120412W					●			4	0.094	0.047	0.500	0.187	0.203								○	
 4QS-CNGA WavyJoint	4QS-CNGA 432	4QS-CNGA120408					●			4	0.059	0.031	0.500	0.187	0.203	○								
	4QS-CNGA 433	4QS-CNGA120412					●			4	0.067	0.047	0.500	0.187	0.203	○								
 4QS-CNGA** -H WavyJoint	4QS-CNGA432-H	4QS-CNGA120408-H					●			4	0.059	0.031	0.500	0.187	0.203								○	
	4QS-CNGA433-H	4QS-CNGA120412-H					●			4	0.067	0.047	0.500	0.187	0.203								○	
 4QS-CNGG** -HM WavyJoint	4QS-CNGG432-HM	4QS-CNGG120408-HM					●			4	0.059	0.031	0.500	0.187	0.203								○	
	4QS-CNGG433-HM	4QS-CNGG120412-HM					●			4	0.067	0.047	0.500	0.187	0.203								○	
 CNGA** -QBN	CNGA 430.5-QBN	CNGA120402-QBN						●		1	0.161	0.008	0.500	0.187	0.203	○								
	CNGA 431-QBN	CNGA120404-QBN						●		1	0.157	0.016	0.500	0.187	0.203	○								
	CNGA 431-QBN	CNGA120408-QBN						●		1	0.154	0.031	0.500	0.187	0.203	○								
	CNGA 433-QBN	CNGA120412-QBN						●		1	0.154	0.047	0.500	0.187	0.203	○								
 S-CNGN Solid CBN	S-CNGN 322	S-CNGN090308						●		4	-	0.031	0.375	0.125	-	○								
	S-CNGN 323	S-CNGN090312						●		4	-	0.047	0.375	0.125	-	○								
	S-CNGN 432	S-CNGN120408						●		4	-	0.031	0.500	0.187	-	○								
	S-CNGN 433	S-CNGN120412						●		4	-	0.047	0.500	0.187	-	○								

*Please see the page B201 about the toolholders recommended for wiper inserts of the designation with W, WL, and WJ at the end. ● : Line up

Reference pages: External toolholder → **C020** - Internal toolholder → **D028** -
 J-Series toolholder → **G057** TungCap → **K008** -

Grade
 Insert
 Toolholder
 Ext. Toolholder
 Int. Toolholder
 Threading
 Grooving
 Miniature Tool
 Milling Cutter
 Endmill
 Drilling Tool
 Tooling System
 User's Guide
 Index



Negative

Positive

PCD / CBN

C

D

G

R

S

T

V

W

Y

OTHERS

CBN Insert NEGATIVE TYPE

- : Continuous cutting
- ◐ : Light interrupted cutting
- ✱ : Heavy interrupted cutting

P	Steel														
M	Stainless														
K	Cast iron										●	✱	●		
N	Non-ferrous														
S	Superalloy														
H	Hard material	●	●	●	●	●	●	●	●	●	●	●	●	●	●
	Sintered metal	●	●	●	●	●	●	●	●	●	●	●	●	●	●

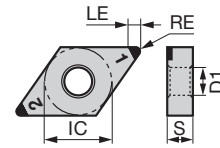

Shape	Designation		No. of corners	Dimension (inch)					Edge prep.					Wiper								
	Inch	Metric		LE	RE	IC	S	D1	Standard	Sharp edge	L	LF	LC		H							
	2QP-DNGA	2QP-DNGA 331	2QP-DNGA110404	BXM10	●																	
		2QP-DNGA 332	2QP-DNGA110408	BXM20	●																	
		2QP-DNGA 333	2QP-DNGA110412	BXA10	●	●																
		2QP-DNGA 430.5	2QP-DNGA150402	BXA20	●	●																
		2QP-DNGA 431	2QP-DNGA150404	BX310	●	●	●	●	●	●	●	●	●	●	●	●	●	●	●	●	●	●
		2QP-DNGA 432	2QP-DNGA150408	BX330	●	●	●	●	●	●	●	●	●	●	●	●	●	●	●	●	●	●
		2QP-DNGA 433	2QP-DNGA150412	BX360	●	●	●	●	●	●	●	●	●	●	●	●	●	●	●	●	●	●
		2QP-DNGA 434	2QP-DNGA150416	BX380		●	●															
		2QP-DNGA 435	2QP-DNGA150420	BX470		●	●															
		2QP-DNGA 436	2QP-DNGA150424	BX480		●	●															
		2QP-DNGA 441	2QP-DNGA150604	BX930	●	●	●	●	●	●	●	●	●	●	●	●	●	●	●	●	●	●
		2QP-DNGA 442	2QP-DNGA150608		●	●	●	●	●	●	●	●	●	●	●	●	●	●	●	●	●	●
		2QP-DNGA 443	2QP-DNGA150612		●	●	●	●	●	●	●	●	●	●	●	●	●	●	●	●	●	●
		2QP-DNGA**-L	2QP-DNGA 430.5-L	2QP-DNGA150402-L		●	●												○			
		2QP-DNGA 431-L	2QP-DNGA150404-L	●	●	●	●	●	●	●	●	●	●	●	●	●	●	●	●	●	●	●
		2QP-DNGA 432-L	2QP-DNGA150408-L	●	●	●	●	●	●	●	●	●	●	●	●	●	●	●	●	●	●	●
		2QP-DNGA 433-L	2QP-DNGA150412-L	●	●	●	●	●	●	●	●	●	●	●	●	●	●	●	●	●	●	●
		2QP-DNGA 441-L	2QP-DNGA150604-L		●	●													○			
		2QP-DNGA 442-L	2QP-DNGA150608-L		●	●													○			
	2QP-DNGA**-LF	2QP-DNGA 430.5-LF	2QP-DNGA150402-LF		●	●												○				
		2QP-DNGA 431-LF	2QP-DNGA150404-LF	●	●														○			
		2QP-DNGA 432-LF	2QP-DNGA150408-LF	●	●														○			
		2QP-DNGA 433-LF	2QP-DNGA150412-LF	●	●														○			
		2QP-DNGA 441-LF	2QP-DNGA150604-LF		●	●													○			
		2QP-DNGA 442-LF	2QP-DNGA150608-LF		●	●													○			
	2QP-DNGA**-LC	2QP-DNGA 430.5-LC	2QP-DNGA150402-LC		●	●												○				
		2QP-DNGA 431-LC	2QP-DNGA150404-LC	●	●														○			
		2QP-DNGA 432-LC	2QP-DNGA150408-LC	●	●														○			
		2QP-DNGA 433-LC	2QP-DNGA150412-LC	●	●														○			
		2QP-DNGA 441-LC	2QP-DNGA150604-LC		●	●													○			
		2QP-DNGA 442-LC	2QP-DNGA150608-LC		●	●													○			
	2QP-DNGA**-H	2QP-DNGA 431-H	2QP-DNGA150404-H	●	●	●				●	●									○		
		2QP-DNGA 432-H	2QP-DNGA150408-H	●	●	●				●	●									○		
		2QP-DNGA 433-H	2QP-DNGA150412-H	●	●	●				●	●									○		
		2QP-DNGA 441-H	2QP-DNGA150604-H		●	●														○		
		2QP-DNGA 442-H	2QP-DNGA150608-H		●	●														○		
		2QP-DNGA 443-H	2QP-DNGA150612-H		●	●														○		
	2QP-DNGA**WJ	2QP-DNGA 431-WJ	2QP-DNGA150404WJ	●	●	●				●	●										○	
		2QP-DNGA 432-WJ	2QP-DNGA150408WJ	●	●	●				●	●											○





*Please see the page B201 about the toolholders recommended for wiper inserts of the designation with W, WL, and WJ at the end.

● : Line up

Reference pages: External toolholder → C046 - Internal toolholder → D060 - J-Series toolholder → G059 -

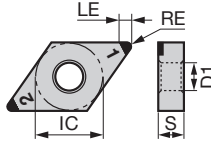
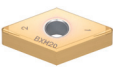
CBN Insert NEGATIVE TYPE

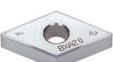
- : Continuous cutting
- : Light interrupted cutting
- ✱ : Heavy interrupted cutting

Shape	Designation		Material						Dimension (inch)						Edge prep.												
	Inch	Metric	P	M	K	N	S	H	No. of corners	LE	RE	IC	S	D1	Standard	Sharp edge	L	LF	LC	H	Wiper	Chipbreaker					
			Steel	Stainless	Cast iron	Non-ferrous	Superalloy	Hard material		Sintered metal																	
	2QP-DNGM**-H*	2QP-DNGM 432-HF	2QP-DNGM150408-HF	●	●	●	●	●	●	●	●	●	●	●	2	0.083	0.031	0.500	0.187	0.203							○
		2QP-DNGM 433-HF	2QP-DNGM150412-HF												2	0.079	0.047	0.500	0.187	0.203							○
		2QP-DNGM 432-HM	2QP-DNGM150408-HM												2	0.083	0.031	0.500	0.187	0.203							○
		2QP-DNGM 433-HM	2QP-DNGM150412-HM												2	0.079	0.047	0.500	0.187	0.203							○
		2QP-DNGM 431-HP	2QP-DNGM150404-HP		●	●	●								2	0.098	0.016	0.500	0.187	0.203							○
		2QP-DNGM 432-HP	2QP-DNGM150408-HP		●	●	●								2	0.083	0.031	0.500	0.187	0.203							○
		2QP-DNGM 433-HP	2QP-DNGM150412-HP			●	●								2	0.079	0.047	0.500	0.187	0.203							○
		2QP-DNGM 442-HP	2QP-DNGM150608-HP		●	●	●								2	0.083	0.031	0.500	0.250	0.203							○
	4QP-DNGA	4QP-DNGA 431	4QP-DNGA150404											4	0.098	0.016	0.500	0.187	0.203	○							
		4QP-DNGA 432	4QP-DNGA150408											4	0.083	0.031	0.500	0.187	0.203	○							
		4QP-DNGA 433	4QP-DNGA150412											4	0.079	0.047	0.500	0.187	0.203	○							
	4QS-DNGA	4QS-DNGA 432	4QS-DNGA150408											4	0.063	0.031	0.500	0.187	0.203	○							
	WavyJoint	4QS-DNGA 433	4QS-DNGA150412											4	0.063	0.047	0.500	0.187	0.203	○							
	4QS-DNGA**-H	4QS-DNGA 432-H	4QS-DNGA150408-H											4	0.063	0.031	0.500	0.187	0.203							○	
	WavyJoint	4QS-DNGA 433-H	4QS-DNGA150412-H											4	0.063	0.047	0.500	0.187	0.203							○	
	4QS-DNGG**-HM	4QS-DNGG 432-HM	4QS-DNGG150408-HM											4	0.063	0.031	0.500	0.187	0.203							○	
	DNGA**-QBN	DNGA 430.5 QBN	DNGA150402-QBN											1	0.169	0.008	0.500	0.187	0.203	○							
		DNGA 431 QBN	DNGA150404-QBN											1	0.161	0.016	0.500	0.187	0.203	○							
		DNGA 432 QBN	DNGA150408-QBN											1	0.150	0.031	0.500	0.187	0.203	○							
		DNGA 433 QBN	DNGA150412-QBN											1	0.134	0.047	0.500	0.187	0.203	○							

● : Line up

Edge preparation specification

	BXM10	BXM20	BXA20	BX310 BXC50	BX330	BX360 BX380	BX470	BX480	BX910 BX930	BXC90
Standard	S01325	S01325	S01325	S01325	S01325	S01325	T01315	S01325	S01315	T02020
Sharp edge	-	-	-	-	-	-	F	-	-	-
-L	S01315	S01315	S01315	-	S01315	-	-	-	-	-
-LF	-	-	S00515	-	-	-	-	-	-	-
-LC	-	-	S00535	-	-	-	-	-	-	-
-H	-	S01835	S01835	-	-	S01335	-	-	-	-
Wiper	S01315	S01315	S01315	-	S01325	-	-	-	-	-

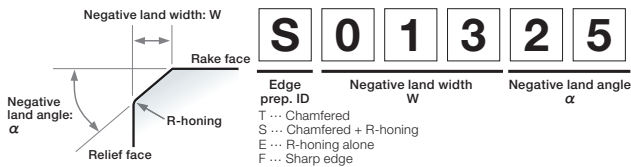

Reference pages: Internal toolholder → **D060 -**

Negative

Positive

PCD / CBN

C

D

G

R

S

T

V







W

Y

OTHERS

CBN Insert NEGATIVE TYPE

- : Continuous cutting
- : Light interrupted cutting
- * : Heavy interrupted cutting

Shape	Designation Inch Metric		Material P Steel M Stainless K Cast iron N Non-ferrous S Superalloy H Hard material Sintered metal	Dimension (inch)							Edge prep.										
				No. of corners	LE	RE	IC	S	D1	Standard Sharp edge	L	LF	LC	H	Wiper	Chipbreaker					
																	BXM10	BXM20	BXA10	BXA20	BX360
2QP-GNGA (Corner angle 70°) 	*2QP-GNGA 430.5	2QP-GNGA120402							2	0.087	0.080	0.500	0.187	0.203	○						
	*2QP-GNGA 431	2QP-GNGA120404	●						2	0.083	0.016	0.500	0.187	0.203	○						
	*2QP-GNGA 432	2QP-GNGA120408	●	●	●	●	●	●	2	0.083	0.031	0.500	0.187	0.203	○						
	*2QP-GNGA 433	2QP-GNGA120412	●	●	●	●	●	●	2	0.087	0.047	0.500	0.187	0.203	○						
2QP-GNGA**-L (Corner angle 70°) 	*2QP-GNGA 430.5-L	2QP-GNGA120402-L							2	0.087	0.080	0.500	0.187	0.203		○					
	*2QP-GNGA 431-L	2QP-GNGA120404-L							2	0.083	0.016	0.500	0.187	0.203		○					
	*2QP-GNGA 432-L	2QP-GNGA120408-L							2	0.083	0.031	0.500	0.187	0.203		○					
	*2QP-GNGA 433-L	2QP-GNGA120412-L							2	0.087	0.047	0.500	0.187	0.203		○					
2QP-GNGA**-LF (Corner angle 70°) 	*2QP-GNGA 430.5-LF	2QP-GNGA120402-LF							2	0.087	0.080	0.500	0.187	0.203			○				
	*2QP-GNGA 431-LF	2QP-GNGA120404-LF							2	0.083	0.016	0.500	0.187	0.203			○				
	*2QP-GNGA 432-LF	2QP-GNGA120408-LF							2	0.083	0.031	0.500	0.187	0.203			○				
	*2QP-GNGA 433-LF	2QP-GNGA120412-LF							2	0.087	0.047	0.500	0.187	0.203			○				
2QP-GNGA**-LC (Corner angle 70°) 	*2QP-GNGA 430.5-LC	2QP-GNGA120402-LC							2	0.087	0.080	0.500	0.187	0.203				○			
	*2QP-GNGA 431-LC	2QP-GNGA120404-LC							2	0.083	0.016	0.500	0.187	0.203				○			
	*2QP-GNGA 432-LC	2QP-GNGA120408-LC							2	0.083	0.031	0.500	0.187	0.203				○			
	*2QP-GNGA 433-LC	2QP-GNGA120412-LC							2	0.087	0.047	0.500	0.187	0.203				○			
2QP-GNGA**-H (Corner angle 70°) 	*2QP-GNGA 431-H	2QP-GNGA120404-H							2	0.083	0.016	0.500	0.187	0.203						○	
	*2QP-GNGA 432-H	2QP-GNGA120408-H							2	0.083	0.031	0.500	0.187	0.203						○	
	*2QP-GNGA 433-H	2QP-GNGA120412-H							2	0.087	0.047	0.500	0.187	0.203						○	
2QP-GNGG**-HP (Corner angle 70°) 	*2QP-GNGG431-HP	2QP-GNGG120404-HP	●						2	0.083	0.016	0.500	0.187	0.203							○
	*2QP-GNGG432-HP	2QP-GNGG120408-HP	●	●	●	●	●	●	2	0.083	0.031	0.500	0.187	0.203							○
	*2QP-GNGG433-HP	2QP-GNGG120412-HP	●	●	●	●	●	●	2	0.087	0.047	0.500	0.187	0.203							○

* Tungaloy's standard

Shape	Designation Inch Metric		Material P Steel M Stainless K Cast iron N Non-ferrous S Superalloy H Hard material	Dimension (inch)							Edge prep.									
				No. of corners	LE	RE	IC	S	D1	Standard Sharp edge	L	LF	LC	H	Wiper	Chipbreaker				
																	BXC90			
S-RNGN 	S-RNGN 32	S-RNGN090300	●						-	-	-	0.375	0.125	-	○					
	S-RNGN 43	S-RNGN 120400	●						-	-	-	0.500	0.187	-	○					

● : Line up

Edge preparation specification

	BXM10	BXM20	BXA20	BX310 BXC50	BX330	BX360 BX380	BX470	BX480	BX910 BX930	BXC90
Standard	S01325	S01325	S01325	S01325	S01325	S01325	T01315	S01325	S01315	T02020
Sharp edge	-	-	-	-	-	-	F	-	-	-
-L	S01315	S01315	S01315	-	S01315	-	-	-	-	-
-LF	-	-	S00515	-	-	-	-	-	-	-
-LC	-	-	S00535	-	-	-	-	-	-	-
-H	-	S01835	S01835	-	S01335	-	-	-	-	-
Wiper	S01315	S01315	S01315	-	S01325	-	-	-	-	-

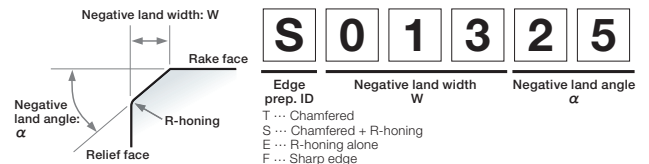







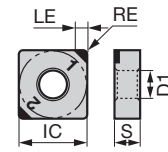

CBN Insert NEGATIVE TYPE

- : Continuous cutting
- ◐ : Light interrupted cutting
- ✱ : Heavy interrupted cutting

	P	M	K	N	S	H	Sintered metal
Steel	●	●	●	●	●	●	●
Stainless	●	●	●	●	●	●	●
Cast iron	●	●	●	●	●	●	●
Non-ferrous	●	●	●	●	●	●	●
Superalloy	●	●	●	●	●	●	●
Hard material	●	●	●	●	●	●	●
Sintered metal	●	●	●	●	●	●	●



Shape	Designation	Inch	Metric	BXM20	BXA10	BXA20	BXC50	BX310	BX330	BX360	BX380	BX480	BX910	BX930	BXC90	Dimension (inch)						Edge prep.				
																No. of corners	LE	RE	IC	S	D1	Standard	Sharp edge	L	LFL	LC
 2QP-SNGA	2QP-SNGA 431	2QP-SNGA 431	2QP-SNGA120404	●	●	●	●	●	●	●	●	●	●	●	●	2	0.094	0.016	0.500	0.187	0.203	○				
	2QP-SNGA 432	2QP-SNGA 432	2QP-SNGA120408	●	●	●	●	●	●	●	●	●	●	●	●	2	0.094	0.031	0.500	0.187	0.203	○				
	2QP-SNGA 433	2QP-SNGA 433	2QP-SNGA120412	●	●	●	●	●	●	●	●	●	●	●	●	2	0.094	0.047	0.500	0.187	0.203	○				
 2QP-SNGA**-L	2QP-SNGA 431-L	2QP-SNGA 431-L	2QP-SNGA120404-L					●	●						2	0.094	0.016	0.500	0.187	0.203		○				
	2QP-SNGA 432-L	2QP-SNGA 432-L	2QP-SNGA120408-L	●	●	●	●	●	●	●	●	●	●	●	●	2	0.094	0.031	0.500	0.187	0.203		○			
	2QP-SNGA 433-L	2QP-SNGA 433-L	2QP-SNGA120412-L	●	●	●	●	●	●	●	●	●	●	●	●	2	0.094	0.047	0.500	0.187	0.203		○			
 2QP-SNGA**-LF	2QP-SNGA 432-LF	2QP-SNGA 432-LF	2QP-SNGA120408-LF	●	●										2	0.094	0.031	0.500	0.187	0.203			○			
	2QP-SNGA 433-LF	2QP-SNGA 433-LF	2QP-SNGA120412-LF	●	●										2	0.094	0.047	0.500	0.187	0.203			○			
 2QP-SNGA**-H	2QP-SNGA 431-H	2QP-SNGA 431-H	2QP-SNGA120404-H						●	●					2	0.094	0.016	0.500	0.187	0.203					○	
	2QP-SNGA 432-H	2QP-SNGA 432-H	2QP-SNGA120408-H	●	●				●	●					2	0.094	0.031	0.500	0.187	0.203					○	
	2QP-SNGA 433-H	2QP-SNGA 433-H	2QP-SNGA120412-H	●	●				●	●					2	0.094	0.047	0.500	0.187	0.203					○	
 4QP-SNGA	4QP-SNGA 431	4QP-SNGA 431	4QP-SNGA120404			●									4	0.094	0.016	0.500	0.187	0.203	○					
	4QP-SNGA 432	4QP-SNGA 432	4QP-SNGA120408			●									4	0.094	0.031	0.500	0.187	0.203	○					
	4QP-SNGA 433	4QP-SNGA 433	4QP-SNGA120412			●									4	0.094	0.047	0.500	0.187	0.203	○					
 SNGA**-QBN	SNGA 430.5 QBN	SNGA 430.5 QBN	SNGA120402-QBN						●						1	0.161	0.008	0.500	0.187	0.203	○					
	SNGA 431 QBN	SNGA 431 QBN	SNGA120404-QBN						●						1	0.161	0.016	0.500	0.187	0.203	○					
	SNGA 432 QBN	SNGA 432 QBN	SNGA120408-QBN						●						1	0.161	0.031	0.500	0.187	0.203	○					
	SNGA 433 QBN	SNGA 433 QBN	SNGA120412-QBN						●						1	0.161	0.047	0.500	0.187	0.203	○					
 2QP-SNGN	2QP-SNGN 322	2QP-SNGN 322	2QP-SNGN090308									●			2	0.094	0.031	0.375	0.125	-	○					
	2QP-SNGN 323	2QP-SNGN 323	2QP-SNGN090312									●			2	0.094	0.047	0.375	0.125	-	○					
 S-SNGN Solid CBN	S-SNGN 322	S-SNGN 322	S-SNGN090308									●			8	-	0.031	0.375	0.125	-	○					
	S-SNGN 323	S-SNGN 323	S-SNGN090312									●			8	-	0.047	0.375	0.125	-	○					
	S-SNGN 422	S-SNGN 422	S-SNGN120308									●			8	-	0.031	0.500	0.125	-	○					
	S-SNGN 423	S-SNGN 423	S-SNGN120312									●			8	-	0.047	0.500	0.125	-	○					
	S-SNGN 432	S-SNGN 432	S-SNGN120408									●			8	-	0.031	0.500	0.187	-	○					
S-SNGN 433	S-SNGN 433	S-SNGN120412									●			8	-	0.047	0.500	0.187	-	○						







● : Line up

Reference pages: External toolholder → C098 - Internal toolholder → D047 -



CBN Insert NEGATIVE TYPE

- : Continuous cutting
- ◐ : Light interrupted cutting
- ✱ : Heavy interrupted cutting

Shape	Designation		BXA20	BXC50	BX360	BXC90	Dimension (inch)					Edge prep.										
	Inch	Metric					No. of corners	LE	RE	IC	S	D1	Standard	Sharp edge	L	LF	LC	H	Wiper	Chipbreaker		
																					Steel	Stainless
	6QP-TNGA	6QP-TNGA 331	6QP-TNGA160404	●				6	0.087	0.016	0.375	0.187	0.150	○								
		6QP-TNGA 332	6QP-TNGA160408	●				6	0.075	0.031	0.375	0.187	0.150	○								
		6QP-TNGA 333	6QP-TNGA160412	●				6	0.094	0.047	0.375	0.187	0.150	○								
	6QS-TNGA	6QS-TNGA 332	6QS-TNGA160408	●				6	0.063	0.031	0.375	0.187	0.150	○								
		6QS-TNGA 333	6QS-TNGA160412	●				6	0.071	0.047	0.375	0.187	0.150	○								
	6QS-TNGA**	6QS-TNGA 332-H	6QS-TNGA160408-H	●				6	0.063	0.031	0.375	0.187	0.150								○	
		6QS-TNGA 333-H	6QS-TNGA160412-H	●				6	0.071	0.047	0.375	0.187	0.150								○	
	6QS-TNGG**	6QS-TNGG 332-HM	6QS-TNGG160408-HM	●				6	0.063	0.031	0.375	0.187	0.150									○
	TNGA**	TNGA 330.5 QBN	TNGA160402-QBN		●			1	0.173	0.008	0.375	0.187	0.150	○								
		TNGA 331 QBN	TNGA160404-QBN		●			1	0.165	0.016	0.375	0.187	0.150	○								
		TNGA 332 QBN	TNGA160408-QBN		●			1	0.157	0.031	0.375	0.187	0.150	○								
		TNGA 333 QBN	TNGA160412-QBN		●			1	0.146	0.047	0.375	0.187	0.150	○								
	S-TNGN	S-TNGN 222	S-TNGN110308			●		6	-	0.031	0.250	0.125	-	○								
		S-TNGN 223	S-TNGN110312			●		6	-	0.047	0.250	0.125	-	○								
		S-TNGN 322	S-TNGN160408			●		6	-	0.031	0.375	0.187	-	○								
		S-TNGN 333	S-TNGN160412			●		6	-	0.047	0.375	0.187	-	○								

● : Line up

Edge preparation specification

	BXM10	BXM20	BXA20	BX310 BXC50	BX330	BX360 BX380	BX470	BX480	BX910 BX930	BXC90
Standard	S01325	S01325	S01325	S01325	S01325	S01325	T01315	S01325	S01315	T02020
Sharp edge	-	-	-	-	-	-	F	-	-	-
-L	S01315	S01315	S01315	-	S01315	-	-	-	-	-
-LF	-	-	S00515	-	-	-	-	-	-	-
-LC	-	-	S00535	-	-	-	-	-	-	-
-H	-	S01835	S01835	-	-	S01335	-	-	-	-
Wiper	S01315	S01315	S01315	-	S01325	-	-	-	-	-

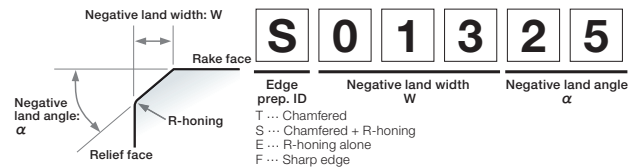

Reference pages: External toolholder → **C121** - Internal toolholder → **D052** -
 J-Series toolholder → **G058** - TungCap → **K014** -



Negative

Positive

PCD / CBN

C

D

G

R

S

T

V

W

Y









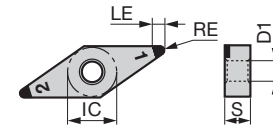

OTHERS

CBN Insert NEGATIVE TYPE

● : Continuous cutting
 ● : Light interrupted cutting
 ✱ : Heavy interrupted cutting

	P	M	K	N	S	H											
Steel	●																
Stainless		●															
Cast iron			●														
Non-ferrous				●													
Superalloy					●												
Hard material						●											
Sintered metal							●										











Shape	Designation		No. of corners	Dimension (inch)					Edge prep.					Chipbreaker			
	Inch	Metric		LE	RE	IC	S	D1	Standard	Sharp edge	L	LFLC	H				
	2QP-VNGA 330.5	2QP-VNGA160402	2	0.138	0.080	0.375	0.187	0.150	○								
	2QP-VNGA 331	2QP-VNGA160404	2	0.122	0.016	0.375	0.187	0.150	○								
	2QP-VNGA 332	2QP-VNGA160408	2	0.087	0.031	0.375	0.187	0.150	○								
	2QP-VNGA 333	2QP-VNGA160412	2	0.118	0.047	0.375	0.187	0.150	○								
	2QP-VNGA 330.5-L	2QP-VNGA160402-L	2	0.138	0.080	0.375	0.187	0.150		○							
	2QP-VNGA 331-L	2QP-VNGA160404-L	2	0.122	0.016	0.375	0.187	0.150		○							
	2QP-VNGA 332-L	2QP-VNGA160408-L	2	0.087	0.031	0.375	0.187	0.150		○							
	2QP-VNGA 333-L	2QP-VNGA160412-L	2	0.118	0.047	0.375	0.187	0.150		○							
	2QP-VNGA 330.5-LF	2QP-VNGA160402-LF	2	0.138	0.080	0.375	0.187	0.150			○						
	2QP-VNGA 331-LF	2QP-VNGA160404-LF	2	0.122	0.016	0.375	0.187	0.150			○						
	2QP-VNGA 332-LF	2QP-VNGA160408-LF	2	0.087	0.031	0.375	0.187	0.150			○						
	2QP-VNGA 333-LF	2QP-VNGA160412-LF	2	0.118	0.047	0.375	0.187	0.150			○						
	2QP-VNGA 330.5-LC	2QP-VNGA160402-LC	2	0.138	0.080	0.375	0.187	0.150				○					
	2QP-VNGA 331-LC	2QP-VNGA160404-LC	2	0.122	0.016	0.375	0.187	0.150				○					
	2QP-VNGA 332-LC	2QP-VNGA160408-LC	2	0.087	0.031	0.375	0.187	0.150				○					
	2QP-VNGA 333-LC	2QP-VNGA160412-LC	2	0.118	0.047	0.375	0.187	0.150				○					
	2QP-VNGA 331-H	2QP-VNGA160404-H	2	0.122	0.016	0.375	0.187	0.150								○	
	2QP-VNGA 332-H	2QP-VNGA160408-H	2	0.087	0.031	0.375	0.187	0.150								○	
	2QP-VNGA 333-H	2QP-VNGA160412-H	2	0.118	0.047	0.375	0.187	0.150								○	
	2QP-VNGM 332-HF	2QP-VNGM160408-HF	2	0.087	0.031	0.375	0.187	0.150									○
	2QP-VNGM 332-HM	2QP-VNGM160408-HM	2	0.087	0.031	0.375	0.187	0.150									○
	2QP-VNGM 331-HP	2QP-VNGM160404-HP	2	0.122	0.016	0.375	0.187	0.150									○
	2QP-VNGM 332-HP	2QP-VNGM160408-HP	2	0.087	0.031	0.375	0.187	0.150									○
	4QP-VNGA 331	4QP-VNGA160404	4	0.122	0.016	0.375	0.187	0.150	○								
	4QP-VNGA 332	4QP-VNGA160408	4	0.087	0.031	0.375	0.187	0.150	○								
	4QS-VNGA 332	4QS-VNGA160408	4	0.067	0.031	0.375	0.187	0.150	○								
	WavyJoint																
	4QS-VNGA 332-H	4QS-VNGA160408-H	4	0.067	0.031	0.375	0.187	0.150									○
	WavyJoint																
	4QS-VNGG 332-HM	4QS-VNGG160408-HM	4	0.067	0.031	0.375	0.187	0.150									○
	WavyJoint																

● : Line up

Reference pages: External toolholder → C062 - Internal toolholder → D078 -
 TungCap → K015 -

CBN Insert NEGATIVE TYPE

- : Continuous cutting
- ◐ : Light interrupted cutting
- ✱ : Heavy interrupted cutting

Shape	Designation		Material										Dimension (inch)						Edge prep.							
	Inch	Metric	BXM10	BXM20	BXA10	BXA20	BXC50	BX310	BX330	BX360	BX380	BX480	BX930	No. of corners	LE	RE	IC	S	D1	Standard	Sharp edge	L	LF	LC	H	Wiper
			P	M	K	N	S	H	✱																	
	3QP-WNGA	3QP-WNGA 431	3QP-WNGA080404											3	0.091	0.016	0.500	0.187	0.203	○						
		3QP-WNGA 432	3QP-WNGA080408	●	●			●	●	●	●	●	●	3	0.087	0.031	0.500	0.187	0.203	○						
		3QP-WNGA 433	3QP-WNGA080412			●	●							3	0.094	0.047	0.500	0.187	0.203	○						
	3QP-WNGA**-L	3QP-WNGA 432-L	3QP-WNGA080408-L			●	●							3	0.087	0.031	0.500	0.187	0.203		○					
	3QP-WNGA**-LF	3QP-WNGA 432-LF	3QP-WNGA080408-LF			●	●							3	0.087	0.031	0.500	0.187	0.203			○				
	3QP-WNGA**-H	3QP-WNGA 432-H	3QP-WNGA080408-H			●	●							3	0.087	0.031	0.500	0.187	0.203						○	
	3QP-WNGA**-WL	3QP-WNGA 432-WL	3QP-WNGA080408WL	●	●	●	●							3	0.087	0.031	0.500	0.187	0.203						○	
	6QP-WNGA	6QP-WNGA 431	6QP-WNGA080404					●						6	0.091	0.016	0.500	0.187	0.203	○						
		6QP-WNGA 432	6QP-WNGA080408			●								6	0.087	0.031	0.500	0.187	0.203	○						
	6QS-WNGA	6QS-WNGA 432	6QS-WNGA080408			●								6	0.059	0.031	0.500	0.187	0.203	○						
		WavyJoint																								
	6QS-WNGA**-H	6QS-WNGA 432-H	6QS-WNGA080408-H			●								6	0.059	0.031	0.500	0.187	0.203						○	
WavyJoint																										

*Please see the page B201 about the toolholders recommended for wiper inserts of the designation with WL at the end.

● : Line up

Edge preparation specification

	BXM10	BXM20	BXA20	BX310 BXC50	BX330	BX360 BX380	BX470	BX480	BX910 BX930	BXC90
Standard	S01325	S01325	S01325	S01325	S01325	S01325	T01315	S01325	S01315	T02020
Sharp edge	-	-	-	-	-	-	F	-	-	-
-L	S01315	S01315	S01315	-	S01315	-	-	-	-	-
-LF	-	-	S00515	-	-	-	-	-	-	-
-LC	-	-	S00535	-	-	-	-	-	-	-
-H	-	S01835	S01835	-	-	S01335	-	-	-	-
Wiper	S01315	S01315	S01315	-	S01325	-	-	-	-	-

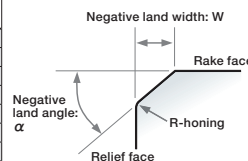

S	0	1	3	2	5
Edge prep. ID		Negative land width W		Negative land angle α	
T ... Chamfered					
S ... Chamfered + R-honing					
E ... R-honing alone					
F ... Sharp edge					

Reference pages: External toolholder → C037 - Internal toolholder → D035 -
TungCap → C038 -, K011 -

CBN Insert POSITIVE TYPE

- : Continuous cutting
- ◐ : Light interrupted cutting
- ✱ : Heavy interrupted cutting

Negative

Positive

PCD / CBN

C

D

G

R

S

T

V







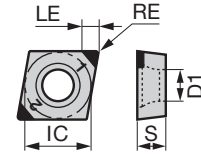

W

Y

OTHERS

P	Steel															
M	Stainless															
K	Cast iron									●	●	●	●	●	●	●
N	Non-ferrous															
S	Superalloy														●	
H	Hard material	●	●	●	●	●	●	●	●	●	●	●	●	●	●	●
	Sintered metal									●	●	●	●	●	●	●







Shape	Designation		Dimension (inch)										Edge prep.						
			Standard	Sharp edge	L	LF	LC	H	Wiper	Chipbreaker									
	2QP-CCGW	21.50.5 2QP-CCGW060202	●	●	●	●													
		21.51 2QP-CCGW060204	●	●	●	●					●	●							
	21.52 2QP-CCGW060208			●	●														
	32.50.5 2QP-CCGW09T302				●	●													
	32.51 2QP-CCGW09T304	●	●	●	●						●	●							
	32.52 2QP-CCGW09T308	●	●	●	●							●							
	2QP-CCGW**	21.50.5-L 2QP-CCGW060202-L			●	●													
		21.51-L 2QP-CCGW060204-L			●	●					2	0.091	0.016	0.250	0.094	0.110		○	
	21.52-L 2QP-CCGW060208-L			●	●					2	0.087	0.031	0.250	0.094	0.110		○		
	32.51-L 2QP-CCGW09T304-L			●	●					2	0.091	0.016	0.375	0.156	0.173		○		
	32.52-L 2QP-CCGW09T308-L			●	●					2	0.087	0.031	0.375	0.156	0.173		○		
	2QP-CCGW**-LF	21.50.5-LF 2QP-CCGW060202-LF			●	●													
		21.51-LF 2QP-CCGW060204-LF			●	●					2	0.091	0.016	0.250	0.094	0.110		○	
	21.52-LF 2QP-CCGW060208-LF			●	●					2	0.087	0.031	0.250	0.094	0.110		○		
	32.50.5-LF 2QP-CCGW09T302-LF			●	●														
	32.51-LF 2QP-CCGW09T304-LF			●	●					2	0.091	0.016	0.375	0.156	0.173		○		
	2QP-CCGW**-LC	21.50.5-LC 2QP-CCGW060202-LC			●	●													
		21.51-LC 2QP-CCGW060204-LC			●	●					2	0.091	0.016	0.250	0.094	0.110		○	
	21.52-LC 2QP-CCGW060208-LC			●	●					2	0.087	0.031	0.250	0.094	0.110		○		
	32.50.5-LC 2QP-CCGW09T302-LC			●	●														
	32.51-LC 2QP-CCGW09T304-LC			●	●					2	0.091	0.016	0.375	0.156	0.173		○		
	2QP-CCGW**-H	32.51-H 2QP-CCGW09T304-H			●													○	
		32.52-H 2QP-CCGW09T308-H			●						2	0.087	0.031	0.375	0.156	0.173		○	
		2QP-CCGW**-WL	32.51-WL 2QP-CCGW09T304WL			●	●												○
32.52-WL 2QP-CCGW09T308WL					●	●					2	0.087	0.031	0.375	0.156	0.173		○	
	2QP-CCGT**-HP	21.51-HP 2QP-CCGT060204-HP	●	●	●					2	0.091	0.016	0.250	0.094	0.110			○	
		32.51-HP 2QP-CCGT09T304-HP	●	●	●						2	0.091	0.016	0.375	0.156	0.173			○
		32.52-HP 2QP-CCGT09T308-HP	●	●	●						2	0.087	0.031	0.375	0.156	0.173			○
	2QP-CCGT**-WL-HP	32.51WL-HP 2QP-CCGT09T304WL-HP	●	●						2	0.091	0.016	0.375	0.156	0.173			○	
		32.52WL-HP 2QP-CCGT09T308WL-HP	●	●							2	0.087	0.031	0.375	0.156	0.173			○

● : Line up

Reference pages: External toolholder → **C026** - Internal toolholder → **D020** -
J-Series toolholder → **G027** -

CBN Insert POSITIVE TYPE

- : Continuous cutting
- ◐ : Light interrupted cutting
- ⊛ : Heavy interrupted cutting

Shape	Designation		BX10	BX20	BXA10	BXA20	BX310	BX330	BX360	BX470	BX480	BX930	Dimension (inch)					Edge prep.						
	Inch	Metric											No. of corners	LE	RE	IC	S	D1	Standard	Sharp edge	L	LFLC	H	Wiper
	2QP-CCMW	2QP-CCMW 21.50.5	2QP-CCMW060202					●	●				2	0.091	0.008	0.250	0.094	0.110	○					
		2QP-CCMW 21.51	2QP-CCMW060204					●	●			●	2	0.091	0.016	0.250	0.094	0.110	○					
		2QP-CCMW 32.51	2QP-CCMW09T304					●	●	●			2	0.091	0.016	0.375	0.156	0.173	○					
		2QP-CCMW 32.52	2QP-CCMW09T308					●	●	●			2	0.087	0.031	0.375	0.156	0.173	○					
	Q-CCMW	Q-CCMW 21.51	Q-CCMW060204					●					1	0.098	0.016	0.250	0.094	0.110	○					
		Q-CCMW 32.51	Q-CCMW09T304					●					1	0.098	0.016	0.375	0.156	0.173	○					
	1QP-CCGW	1QP-CCGW 4.51.80.5	1QP-CCGW03X102					●		●			1	0.055	0.008	0.141	0.055	0.075						
		1QP-CCGW 4.51.81	1QP-CCGW03X104					●		●			1	0.051	0.016	0.141	0.055	0.075						
		1QP-CCGW 5.52.20.5	1QP-CCGW04T102					●		●			1	0.075	0.008	0.172	0.070	0.091						
		1QP-CCGW 5.52.21	1QP-CCGW04T104					●		●			1	0.071	0.016	0.172	0.070	0.091						
	2QP-CPGW	2QP-CPGW 2.51.50.5	2QP-CPGW080202		●●								2	0.091	0.080	0.313	0.094	0.134	○					
		2QP-CPGW 2.51.51	2QP-CPGW080204		●●								2	0.091	0.016	0.313	0.094	0.134	○					
		2QP-CPGW 2.51.52	2QP-CPGW080208		●●								2	0.087	0.031	0.313	0.094	0.134	○					
		2QP-CPGW 320.5	2QP-CPGW090302		●●								2	0.091	0.080	0.313	0.094	0.134	○					
		2QP-CPGW 321	2QP-CPGW090304		●●								2	0.091	0.016	0.375	0.125	0.173	○					
		2QP-CPGW 322	2QP-CPGW090308		●●								2	0.087	0.031	0.375	0.125	0.173	○					
	CPGA**-QBN	CPGA 31.51 QBN	CPGA090204-QBN							●			1	0.157	0.016	0.375	0.094	0.157	○					
		CPGA 31.52 QBN	CPGA090208-QBN							●			1	0.150	0.031	0.375	0.094	0.157	○					

Q-CCMW: 2 pieces per package

● : Line up

Edge preparation specification

	BX10 BX20	BXA20	BX310 BX330 BX360 BX480 BX930	BX470	BX910
Standard	S01325	S01325	S00515	T01315	S01315
Sharp edge	-	-	-	F	-
-L	-	S01315	-	-	-
-LF	-	S00515	-	-	-
-LC	-	S00535	-	-	-
-H	-	S01835	-	-	-
Wiper	-	S01315	-	-	-

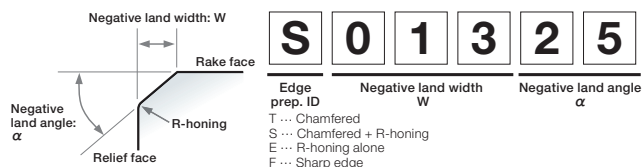

Reference pages: External toolholder → C026 - Internal toolholder → D020 -
 J-Series toolholder → G027 -



Negative

Positive

PCD / CBN

C

D

G

R

S

T

V

W

Y

OTHERS

CBN Insert POSITIVE TYPE

- : Continuous cutting
- ◐ : Light interrupted cutting
- ✱ : Heavy interrupted cutting

	P	M	K	N	S	H														
Steel																				
Stainless																				
Cast iron																●	✱	●		
Non-ferrous																				
Superalloy																				
Hard material						●	●	●	●	●	●	●	●	●	●	●	●	●	●	●
Sintered metal																●	●	●	●	●

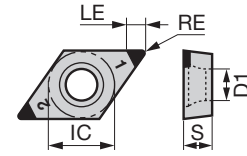

Shape	Designation		BXM10	BXM20	BXA10	BXA20	BX310	BX330	BX360	BX470	BX480	BX930	No. of corners	Dimension (inch)					Edge prep.					Wiper	Chipbreaker	
	Inch	Metric												LE	RE	IC	S	D1	Standard	Sharp edge	L	LF	LC			H
	2QP-DCGW	2QP-DCGW 21.50	2QP-DCGW070202	●	●	●	●						2	0.106	0.008	0.250	0.094	0.110	○							
		2QP-DCGW 21.51	2QP-DCGW070204	●	●	●	●				●	●	2	0.098	0.016	0.250	0.094	0.110	○							
		2QP-DCGW 21.52	2QP-DCGW070208			●	●				●		2	0.083	0.031	0.250	0.094	0.110	○							
		2QP-DCGW 32.50.2	2QP-DCGW11T301			●	●						2	0.110	0.004	0.375	0.156	0.173	○							
		2QP-DCGW 32.50.5	2QP-DCGW11T302	●	●	●	●						2	0.106	0.008	0.375	0.156	0.173	○							
		2QP-DCGW 32.51	2QP-DCGW11T304	●	●	●	●				●	●	2	0.098	0.016	0.375	0.156	0.173	○							
		2QP-DCGW 32.52	2QP-DCGW11T308	●	●	●	●				●		2	0.083	0.031	0.375	0.156	0.173	○							
	2QP-DCGW**-L	2QP-DCGW 21.50.5-L	2QP-DCGW070202-L		●	●							2	0.106	0.008	0.250	0.094	0.110		○						
		2QP-DCGW 21.51-L	2QP-DCGW070204-L		●	●							2	0.098	0.016	0.250	0.094	0.110		○						
		2QP-DCGW 21.52-L	2QP-DCGW070208-L		●	●							2	0.083	0.031	0.250	0.094	0.110		○						
		2QP-DCGW 32.50.5-L	2QP-DCGW11T302-L		●	●							2	0.106	0.008	0.375	0.156	0.173		○						
		2QP-DCGW 32.51-L	2QP-DCGW11T304-L		●	●							2	0.098	0.016	0.375	0.156	0.173		○						
		2QP-DCGW 32.52-L	2QP-DCGW11T308-L		●	●							2	0.083	0.031	0.375	0.156	0.173		○						
	2QP-DCGW**-LF	2QP-DCGW 21.50.5-LF	2QP-DCGW070202-LF		●	●							2	0.106	0.008	0.250	0.094	0.110			○					
		2QP-DCGW 21.51-LF	2QP-DCGW070204-LF		●	●							2	0.098	0.016	0.250	0.094	0.110			○					
		2QP-DCGW 21.52-LF	2QP-DCGW070208-LF		●	●							2	0.083	0.031	0.250	0.094	0.110			○					
		2QP-DCGW 32.50.5-LF	2QP-DCGW11T302-LF		●	●							2	0.106	0.008	0.375	0.156	0.173			○					
		2QP-DCGW 32.51-LF	2QP-DCGW11T304-LF		●	●							2	0.098	0.016	0.375	0.156	0.173			○					
	2QP-DCGW**-LC	2QP-DCGW 21.50.5-LC	2QP-DCGW070202-LC		●	●							2	0.106	0.008	0.250	0.094	0.110				○				
		2QP-DCGW 21.51-LC	2QP-DCGW070204-LC		●	●							2	0.098	0.016	0.250	0.094	0.110				○				
		2QP-DCGW 21.52-LC	2QP-DCGW070208-LC		●	●							2	0.083	0.031	0.250	0.094	0.110				○				
		2QP-DCGW 32.50.5-LC	2QP-DCGW11T302-LC		●	●							2	0.106	0.008	0.375	0.156	0.173				○				
		2QP-DCGW 32.51-LC	2QP-DCGW11T304-LC		●	●							2	0.098	0.016	0.375	0.156	0.173				○				
	2QP-DCGW**-H	2QP-DCGW 32.51-H	2QP-DCGW11T304-H				●						2	0.098	0.016	0.375	0.156	0.173					○			
		2QP-DCGW 32.52-H	2QP-DCGW11T308-H				●						2	0.083	0.031	0.375	0.156	0.173					○			
	2QP-DCGT**-HP	2QP-DCGT21.51-HP	2QP-DCGT070204-HP	●		●							2	0.098	0.016	0.250	0.094	0.110							○	
		2QP-DCGT32.51-HP	2QP-DCGT11T304-HP	●		●							2	0.098	0.016	0.375	0.156	0.173							○	
		2QP-DCGT32.52-HP	2QP-DCGT11T308-HP	●		●							2	0.083	0.031	0.375	0.156	0.173							○	

● : Line up

Reference pages: External toolholder → C050 - Internal toolholder → D056 -
 J-Series toolholder → G036 -

CBN Insert POSITIVE TYPE

- : Continuous cutting
- ◐ : Light interrupted cutting
- ⊛ : Heavy interrupted cutting

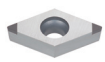
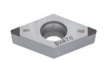
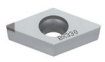
Shape	Designation		Dimension (inch)							Edge prep.					Wiper	Chipbreaker			
	Inch	Metric	No. of corners	LE	RE	IC	S	D1	Standard	Sharp edge	L	LF	LC	H					
																	BXM10	BXM20	BXA20
	2QP-DCMW	2QP-DCMW 21.50.5	2QP-DCMW070202																
		2QP-DCMW 21.51	2QP-DCMW070204																
		2QP-DCMW 32.50.5	2QP-DCMW11T302																
		2QP-DCMW 32.51	2QP-DCMW11T304																
		2QP-DCMW 32.52	2QP-DCMW11T308																
	2QP-DCGW**F	2QP-DCGW32.50.5F	2QP-DCGW11T302F																
		2QP-DCGW32.51F	2QP-DCGW11T304F																
	Q-DCMW	Q-DCMW 21.51	Q-DCMW070204																
		Q-DCMW 32.51	Q-DCMW11T304																

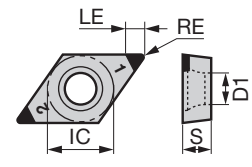

Q-DCMW: 2 pieces per package

● : Line up

Edge preparation specification

	BXM10 BXM20	BXA20	BX310 BX330 BX360 BX480 BX930	BX470	BX910
Standard	S01325	S01325	S00515	T01315	S01315
Sharp edge	-	-	-	F	-
-L	-	S01315	-	-	-
-LF	-	S00515	-	-	-
-LC	-	S00535	-	-	-
-H	-	S01835	-	-	-
Wiper	-	S01315	-	-	-

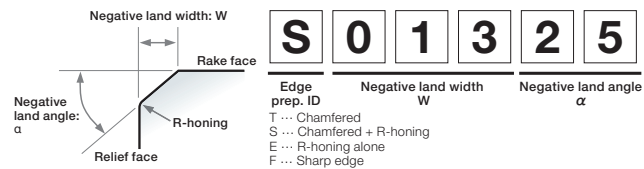

Reference pages: External toolholder → **C050 -** Internal toolholder → **D056 -**
 J-Series toolholder → **G036 -**

Negative

Positive

PCD / CBN

C

D

G

R

S

T

V

W

Y

OTHERS

CBN Insert POSITIVE TYPE

- : Continuous cutting
- ◐ : Light interrupted cutting
- ✱ : Heavy interrupted cutting

P	Steel																	
M	Stainless																	
K	Cast iron	●●																
N	Non-ferrous																	
S	Superalloy	●●																
H	Hard material	●																
	Sintered metal	●●																

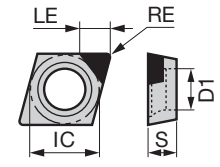

Shape	Designation		BX310	BX470	No. of corners	Dimension (inch)					Edge prep.					Wiper	Chipbreaker	
						LE	RE	IC	S	D1	Standard	Sharp edge	L	LF	LC			H
	1QP-EPGW	1QP-EPGW 4.51.80.5	1QP-EPGW03X102	●	●	1	0.055	0.008	0.141	0.055	0.075							
		1QP-EPGW 4.51.81	1QP-EPGW03X104	●	●	1	0.051	0.016	0.141	0.055	0.075							
		1QP-EPGW 520.5	1QP-EPGW040102	●	●	1	0.067	0.008	0.156	0.063	0.091							
		1QP-EPGW 521	1QP-EPGW040104	●	●	1	0.063	0.016	0.156	0.063	0.091							

P	Steel																	
M	Stainless																	
K	Cast iron			✱	●				●●	●●								
N	Non-ferrous																	
S	Superalloy																	
H	Hard material	●	●			●●●●												
	Sintered metal			●		●●												

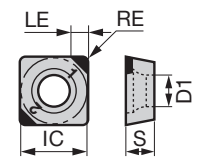

Shape	Designation		BX330	BX360	BX910	BX930	No. of corners	Dimension (inch)					Edge prep.					Wiper	Chipbreaker	
								LE	RE	IC	S	D1	Standard	Sharp edge	L	LF	LC			H
	2QP-SPGN	2QP-SPGN 322	2QP-SPGN090308		●		2	0.094	0.031	0.375	0.125	-	○							
		2QP-SPGN 323	2QP-SPGN090312		●		2	0.094	0.047	0.375	0.125	-	○							
	2QP-SPMN	2QP-SPMN 321	2QP-SPMN090304	●	●	●	2	0.094	0.016	0.375	0.125	-	○							
		2QP-SPMN 322	2QP-SPMN090308	●	●	●	2	0.094	0.031	0.375	0.125	-	○							
	Q-SPGN	Q-SPGN 321	Q-SPGN090304	●			1	0.110	0.016	0.375	0.125	-	○							
		Q-SPGN 322	Q-SPGN090308	●			1	0.110	0.031	0.375	0.125	-	○							
	SPGN**_QBN	SPG 321 QBN	SPGN090304-QBN	●			1	0.161	0.016	0.375	0.125	-	○							
		SPG 322 QBN	SPGN090308-QBN	●			1	0.161	0.031	0.375	0.125	-	○							
		SPG 323 QBN	SPGN090312-QBN	●			1	0.161	0.047	0.375	0.125	-	○							
		SPG 422 QBN	SPGN120308-QBN	●			1	0.161	0.031	0.500	0.125	-	○							
		SPG 423 QBN	SPGN120312-QBN	●			1	0.161	0.047	0.500	0.125	-	○							
	2QP-SPGW	2QP-SPGW 32.52	2QP-SPGW09T308		●		2	0.094	0.031	0.375	0.156	0.173	○							
		2QP-SPGW 32.53	2QP-SPGW09T312		●		2	0.094	0.047	0.375	0.156	0.173	○							
		2QP-SPGW 432	2QP-SPGW120408		●		2	0.094	0.031	0.500	0.187	0.217	○							
		2QP-SPGW 433	2QP-SPGW120412		●		2	0.094	0.047	0.500	0.187	0.217	○							
		2QP-SPGW 434	2QP-SPGW120416		●		2	0.094	0.063	0.500	0.187	0.217	○							

Q-SPGN: 2 pieces per package

● : Line up

Reference pages: Internal toolholder → **D040 -**

CBN Insert POSITIVE TYPE

- : Continuous cutting
- ◐ : Light interrupted cutting
- ✱ : Heavy interrupted cutting

Shape	Designation							Dimension (inch)					Edge prep.									
	Inch	Metric	BX330	BX360	BX480	BX910	BX930	No. of corners	LE	RE	IC	S	D1	Standard	Sharp edge	L	LFL	LC	H	Wiper	Chipbreaker	
	3QP-TPGN	3QP-TPGN22.5	3QP-TPGN110302			●																
		3QP-TPGN221	3QP-TPGN110304			●																
		3QP-TPGN 222	3QP-TPGN110308			●	●															
		3QP-TPGN 223	3QP-TPGN110312				●															
		3QP-TPGN 321	3QP-TPGN160304			●																
		3QP-TPGN 322	3QP-TPGN160308			●																
	3QP-TPMN	3QP-TPMN 220.5	3QP-TPMN110302	●	●		●															
		3QP-TPMN 221	3QP-TPMN110304	●	●		●															
		3QP-TPMN 222	3QP-TPMN110308	●	●		●															
		3QP-TPMN 321	3QP-TPMN160304	●	●		●															
		3QP-TPMN 322	3QP-TPMN160308	●	●		●															
	Q-TPGN	Q-TPGN221	Q-TPGN110304	●																		
		Q-TPGN 222	Q-TPGN110308	●																		
		Q-TPGN 321	Q-TPGN160304	●																		
		Q-TPGN 332	Q-TPGN160308	●																		
	TPGN**-QBN	TPG 221 QBN	TPGN110304-QBN	●																		
		TPG 222 QBN	TPGN110308-QBN	●																		
		TPG 321 QBN	TPGN160304-QBN	●																		
		TPG 322 QBN	TPGN160308-QBN	●																		
	TBGN**-QBN	TBGN 521 QBN	TBGN060104-15-QBN	●																		
		TBGN 522 QBN	TBGN060108-15-QBN	●																		

Q-TPGN: 2 pieces per package

● : Line up

Edge preparation specification

	BXM10 BXM20	BXA20	BX310 BX330 BX360 BX480 BX930	BX470	BX910
Standard	S01325	S01325	S00515	T01315	S01315
Sharp edge	-	-	-	F	-
-L	-	S01315	-	-	-
-LF	-	S00515	-	-	-
-LC	-	S00535	-	-	-
-H	-	S01835	-	-	-
Wiper	-	S01315	-	-	-

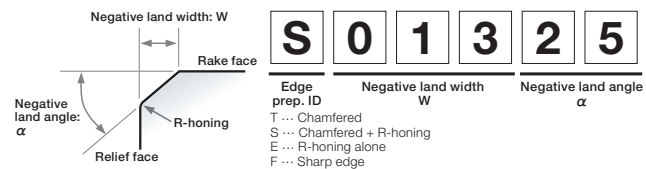

Reference pages: Internal toolholder → **D050 -**



Negative

Positive

PCD / CBN

C

D

G

R

S

T

V

W

Y

OTHERS

CBN Insert POSITIVE TYPE

● : Continuous cutting
 ○ : Light interrupted cutting
 ✱ : Heavy interrupted cutting

P	Steel											
M	Stainless											
K	Cast iron									●	●	●
N	Non-ferrous											
S	Superalloy											
H	Hard material	●	●	●	●	●	●	●	●			
	Sintered metal									●	●	●





Shape	Designation Inch Metric		Dimension (inch)									Edge prep.												
			No. of corners	LE	RE	IC	S	D1	Standard	Edge prep.														
										Sharp edge	L	LFLC	H	Wiper	Chipbreaker									
	3QP-TPGW	3QP-TPGW 630.5	3QP-TPGW080202								3	0.091	0.008	0.187	0.094	0.091	○							
		3QP-TPGW 631	3QP-TPGW080204	●	●	●	●				3	0.087	0.016	0.187	0.094	0.091	○							
		3QP-TPGW 632	3QP-TPGW080208			●	●					3	0.075	0.031	0.187	0.094	0.091	○						
		3QP-TPGW 730.5	3QP-TPGW090202			●	●					3	0.091	0.008	0.219	0.094	0.098	○						
		3QP-TPGW 731	3QP-TPGW090204	●	●	●	●					3	0.087	0.016	0.219	0.094	0.098	○						
		3QP-TPGW 732	3QP-TPGW090208			●	●					3	0.075	0.031	0.219	0.094	0.098	○						
		3QP-TPGW 21.50	3QP-TPGW110202		●	●	●					3	0.091	0.008	0.250	0.094	0.110	○						
		3QP-TPGW 21.51	3QP-TPGW110204	●	●	●	●					3	0.087	0.016	0.250	0.094	0.110	○						
		3QP-TPGW 21.52	3QP-TPGW110208			●	●					3	0.075	0.031	0.250	0.094	0.110	○						
		3QP-TPGW 220.5	3QP-TPGW110302		●	●	●					3	0.091	0.008	0.250	0.125	0.134	○						
		3QP-TPGW 221	3QP-TPGW110304	●	●	●	●					3	0.087	0.016	0.250	0.125	0.134	○						
		3QP-TPGW 222	3QP-TPGW110308	●	●	●	●					3	0.075	0.031	0.250	0.125	0.134	○						
		3QP-TPGW 2.520.5	3QP-TPGW130302		●	●	●					3	0.091	0.008	0.313	0.125	0.134	○						
		3QP-TPGW 2.521	3QP-TPGW130304	●	●	●	●					3	0.087	0.016	0.313	0.125	0.134	○						
		3QP-TPGW 2.522	3QP-TPGW130308		●	●	●					3	0.075	0.031	0.313	0.125	0.134	○						
		3QP-TPGW 32.50.5	3QP-TPGW16T304		●	●	●					3	0.091	0.008	0.375	0.156	0.173	○						
		3QP-TPGW 32.51	3QP-TPGW16T304	●	●	●	●					3	0.087	0.016	0.375	0.156	0.173	○						
		3QP-TPGW 32.52	3QP-TPGW16T308	●	●	●	●					3	0.075	0.031	0.375	0.156	0.173	○						
		3QP-TPGW 330.5	3QP-TPGW160402		●	●	●					3	0.091	0.008	0.375	0.187	0.173	○						
		3QP-TPGW 331	3QP-TPGW160404	●	●	●	●					3	0.087	0.016	0.375	0.187	0.173	○						
	3QP-TPGW 332	3QP-TPGW160408		●	●	●					3	0.075	0.031	0.375	0.187	0.173	○							
	3QP-TPGW**F	3QP-TPGW 221F	3QP-TPGW110304F								3	0.087	0.016	0.250	0.125	0.134	○							
		3QP-TPGW 222F	3QP-TPGW110308F								3	0.075	0.031	0.250	0.125	0.134	○							
	3QP-TPGW**-L	3QP-TPGW 220.5-L	3QP-TPGW110302-L	●	●						3	0.091	0.008	0.250	0.125	0.134		○						
		3QP-TPGW 221-L	3QP-TPGW110304-L	●	●						3	0.087	0.016	0.250	0.125	0.134		○						
		3QP-TPGW 222-L	3QP-TPGW110308-L	●	●						3	0.075	0.031	0.250	0.125	0.134		○						
	3QP-TPGW**-LF	3QP-TPGW 220.5-LF	3QP-TPGW110302-LF	●	●						3	0.091	0.008	0.250	0.125	0.134			○					
		3QP-TPGW 221-LF	3QP-TPGW110304-LF	●	●						3	0.087	0.016	0.250	0.125	0.134			○					
		3QP-TPGW 222-LF	3QP-TPGW110308-LF	●	●						3	0.075	0.031	0.250	0.125	0.134			○					
	3QP-TPGW**-LC	3QP-TPGW 220.5-LC	3QP-TPGW110302-LC	●	●						3	0.091	0.008	0.250	0.125	0.134				○				
		3QP-TPGW 221-LC	3QP-TPGW110304-LC	●	●						3	0.087	0.016	0.250	0.125	0.134				○				
		3QP-TPGW 222-LC	3QP-TPGW110308-LC	●	●						3	0.075	0.031	0.250	0.125	0.134				○				
	3QP-TPGW**-H	3QP-TPGW 221-H	3QP-TPGW110304-H		●						3	0.087	0.016	0.250	0.125	0.134					○			
		3QP-TPGW 222-H	3QP-TPGW110308-H		●						3	0.075	0.031	0.250	0.125	0.134					○			
		3QP-TPGW 330.5-H	3QP-TPGW160402-H	●							3	0.091	0.008	0.375	0.187	0.173					○			
		3QP-TPGW 331-H	3QP-TPGW160404-H	●	●						3	0.087	0.016	0.375	0.187	0.173					○			
		3QP-TPGW 332-H	3QP-TPGW160408-H	●	●						3	0.075	0.031	0.375	0.187	0.173					○			

● : Line up

Reference pages: Internal toolholder → D050 -

CBN Insert POSITIVE TYPE

- : Continuous cutting
- ◐ : Light interrupted cutting
- ◑ : Heavy interrupted cutting

Shape	Designation		Material							Dimension (inch)					Edge prep.								
	Inch	Metric	P	M	K	N	S	H	No. of corners	LE	RE	IC	S	D1	Standard	Sharp edge	L	LF	LC	H	Wiper	Chipbreaker	
			Steel	Stainless	Cast iron	Non-ferrous	Superalloy	Hard material															Sintered metal
	3QP-TPGT	3QP-TPGT221-HP	3QP-TPGT110304-HP	●																			
		3QP-TPGT222-HP	3QP-TPGT110308-HP	●		●																	
	3QP-TPMW	3QP-TPMW 631	3QP-TPMW080204						●	●	●	●			○								
		3QP-TPMW 730.5	3QP-TPMW090202									●	●	●	○								
		3QP-TPMW 731	3QP-TPMW090204									●	●	●	○								
		3QP-TPMW 21.50.5	3QP-TPMW110202									●	●	●	○								
		3QP-TPMW 21.51	3QP-TPMW110204									●	●	●	○								
		3QP-TPMW 220.5	3QP-TPMW110302									●	●	●	○								
		3QP-TPMW 221	3QP-TPMW110304									●	●	●	○								
		3QP-TPMW 222	3QP-TPMW110308									●	●	●	○								
		3QP-TPMW 2.520.5	3QP-TPMW130302									●	●	●	○								
		3QP-TPMW 2.521	3QP-TPMW130304									●	●	●	○								
		3QP-TPMW 32.51	3QP-TPMW16T304									●	●	●	○								
		3QP-TPMW 32.52	3QP-TPMW16T308									●	●	●	○								
		3QP-TCGW	3QP-TCGW 730.5	3QP-TCGW090202			●	●								○							
		3QP-TCGW 731	3QP-TCGW090204			●	●								○								
		3QP-TCGW 732	3QP-TCGW090208			●	●								○								
		3QP-TCGW 21.50.5	3QP-TCGW110202			●	●								○								
		3QP-TCGW 21.51	3QP-TCGW110204			●	●								○								
		3QP-TCGW 21.52	3QP-TCGW110208			●	●								○								
		3QP-TCGW 32.50.5	3QP-TCGW16T302			●	●								○								
		3QP-TCGW 32.51	3QP-TCGW16T304			●	●								○								
	3QP-TCGW 32.52	3QP-TCGW16T308			●	●								○									

● : Line up

Edge preparation specification

	BXM10 BXM20	BXA20	BX310 BX330 BX360 BX480 BX930	BX470	BX910
Standard	S01325	S01325	S00515	T01315	S01315
Sharp edge	-	-	-	F	-
-L	-	S01315	-	-	-
-LF	-	S00515	-	-	-
-LC	-	S00535	-	-	-
-H	-	S01835	-	-	-
Wiper	-	S01315	-	-	-

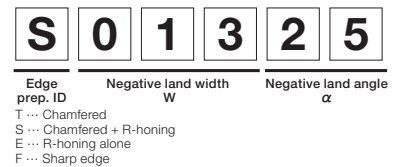
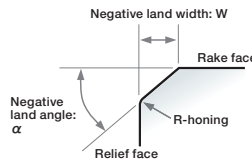

Reference pages: Internal toolholder → **D050 -**

Negative

Positive

PCD / CBN

C

D

G

R

S

T

V

W

Y



OTHERS

CBN Insert POSITIVE TYPE

● : Continuous cutting
 ○ : Light interrupted cutting
 ✱ : Heavy interrupted cutting

P	Steel																			
M	Stainless																			
K	Cast iron																			
N	Non-ferrous																			
S	Superalloy																			
H	Hard material	●●●●																		



Shape	Designation		Dimension (inch)										Edge prep.								
			BX330	BX360	No. of corners	LE	RE	IC	S	D1	Standard	Sharp edge				Wiper	Chipbreaker				
												L	LF	LC	H						
	Q-TPMW	Q-TPMW 631	Q-TPMW080204	●		1	0.087	0.016	0.187	0.094	0.091	○									
		Q-TPMW 730.5	Q-TPMW090202	●		1	0.094	0.008	0.219	0.094	0.098	○									
	Q-TPMW 731	Q-TPMW090204	●		1	0.091	0.016	0.219	0.094	0.098	○										
	Q-TPMW 21.50.5	Q-TPMW110202	●		1	0.094	0.008	0.250	0.094	0.110	○										
	Q-TPMW 21.51	Q-TPMW110204	●		1	0.087	0.016	0.250	0.094	0.110	○										
	Q-TPMW 221	Q-TPMW110304	●		1	0.087	0.016	0.250	0.125	0.134	○										
	Q-TPMW 222	Q-TPMW110308	●		1	0.079	0.031	0.250	0.125	0.134	○										
	Q-TPMW 2.520.5	Q-TPMW130302	●		1	0.094	0.008	0.313	0.125	0.134	○										
	Q-TPMW 2.521	Q-TPMW130304	●		1	0.091	0.016	0.313	0.125	0.134	○										
	Q-TPMW 32.51	Q-TPMW16T304	●		1	0.091	0.016	0.375	0.156	0.173	○										
	Q-TPMW 331	Q-TPMW160404	●		1	0.091	0.016	0.375	0.187	0.173	○										
	Q-TPMW 332	Q-TPMW160408	●		1	0.079	0.031	0.375	0.187	0.173	○										
		TPGW**-QBN	TPGW 730.5 QBN	TPGW090202-QBN	●		1	0.130	0.008	0.219	0.094	0.098	○								
TPGW 731 QBN			TPGW090204-QBN	●		1	0.126	0.016	0.219	0.094	0.098	○									
TPGW 21.50.5 QBN			TPGW110202-QBN	●		1	0.154	0.008	0.250	0.094	0.110	○									
TPGW 21.51 QBN			TPGW110204-QBN	●		1	0.146	0.016	0.250	0.094	0.110	○									
TPGW 2.520.5 QBN			TPGW130302-QBN	●		1	0.154	0.008	0.313	0.125	0.134	○									
TPGW 2.521 QBN			TPGW130304-QBN	●		1	0.146	0.016	0.313	0.125	0.134	○									
TPGW 32.50.5 QBN			TPGW16T302-QBN	●		1	0.173	0.008	0.375	0.156	0.173	○									
TPGW 32.51 QBN			TPGW16T304-QBN	●		1	0.165	0.016	0.375	0.156	0.173	○									
TPGW 32.52 QBN	TPGW16T308-QBN	●		1	0.157	0.031	0.375	0.156	0.173	○											
	TPGA**-QBN	TPGA 730.5 QBN	TPGA090202-QBN	●		1	0.122	0.008	0.219	0.094	0.126	○									
		TPGA 731 QBN	TPGA090204-QBN	●		1	0.114	0.016	0.219	0.094	0.126	○									
		TPGA 21.50.5 QBN	TPGA110202-QBN	●		1	0.154	0.008	0.250	0.094	0.118	○									
		TPGA 21.51 QBN	TPGA110204-QBN	●		1	0.146	0.016	0.250	0.094	0.118	○									
		TPGA 220.5 QBN	TPGA110302-QBN	●		1	0.154	0.008	0.250	0.125	0.118	○									
		TPGA 221 QBN	TPGA110304-QBN	●		1	0.146	0.016	0.250	0.125	0.118	○									
		TPGA 320.5 QBN	TPGA160302-QBN	●		1	0.173	0.008	0.375	0.125	0.157	○									
TPGA 321 QBN	TPGA160304-QBN	●		1	0.165	0.016	0.375	0.125	0.157	○											
TPGA 322 QBN	TPGA160308-QBN	●		1	0.157	0.031	0.375	0.125	0.157	○											

Q-TPMW: 2 pieces per package

● : Line up

Reference pages: Internal toolholder → D050 -

CBN Insert POSITIVE TYPE

- : Continuous cutting
- : Light interrupted cutting
- ⊛ : Heavy interrupted cutting

Shape	Designation						Dimension (inch)					Edge prep.								
	Inch	Metric	BXM10	BXM20	BXA10	BXA20	No. of corners	LE	RE	IC	S	D1	Standard	Sharp edge	L	LF	LC	H	Wiper	Chipbreaker
	2QP-VBGW	2QP-VBGW 21.50.5	2QP-VBGW110202			●	●						○							
		2QP-VBGW 21.51	2QP-VBGW110204			●	●						○							
		2QP-VBGW 21.52	2QP-VBGW110208			●	●						○							
		2QP-VBGW 220.2	2QP-VBGW110301			●	●						○							
		2QP-VBGW 220.5	2QP-VBGW110302			●	●						○							
		2QP-VBGW 221	2QP-VBGW110304	●	●	●	●						○							
		2QP-VBGW 222	2QP-VBGW110308	●	●	●	●						○							
		2QP-VBGW 330.5	2QP-VBGW160402			●	●						○							
		2QP-VBGW 331	2QP-VBGW160404	●	●	●	●						○							
		2QP-VBGW 332	2QP-VBGW160408	●	●	●	●						○							
	2QP-VBGW 333	2QP-VBGW160412			●	●						○								
	2QP-VBGW**-L	2QP-VBGW 220.5-L	2QP-VBGW110302-L			●	●							○						
		2QP-VBGW 221-L	2QP-VBGW110304-L			●	●							○						
		2QP-VBGW 222-L	2QP-VBGW110308-L			●	●							○						
		2QP-VBGW 330.5-L	2QP-VBGW160402-L			●	●							○						
		2QP-VBGW 331-L	2QP-VBGW160404-L			●	●							○						
		2QP-VBGW 332-L	2QP-VBGW160408-L			●	●							○						
	2QP-VBGW**-LF	2QP-VBGW 220.5-LF	2QP-VBGW110302-LF			●	●								○					
		2QP-VBGW 221-LF	2QP-VBGW110304-LF			●	●								○					
		2QP-VBGW 222-LF	2QP-VBGW110308-LF			●	●								○					
		2QP-VBGW 330.5-LF	2QP-VBGW160402-LF			●	●								○					
		2QP-VBGW 331-LF	2QP-VBGW160404-LF			●	●								○					
		2QP-VBGW 332-LF	2QP-VBGW160408-LF			●	●								○					
	2QP-VBGW**-LC	2QP-VBGW 220.5-LC	2QP-VBGW110302-LC			●	●													
		2QP-VBGW 221-LC	2QP-VBGW110304-LC			●	●									○				
		2QP-VBGW 222-LC	2QP-VBGW110308-LC			●	●									○				
		2QP-VBGW 330.5-LC	2QP-VBGW160402-LC			●	●									○				
		⌀1-LC	2QP-VBGW160404-LC			●	●									○				
		2QP-VBGW 332-LC	2QP-VBGW160408-LC			●	●									○				
	2QP-VBGW**-H	2QP-VBGW 331-H	2QP-VBGW160404-H				●												○	
		2QP-VBGW 332-H	2QP-VBGW160408-H				●												○	

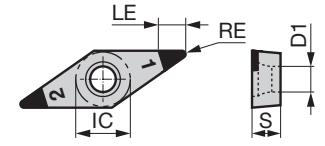

● : Line up

Edge preparation specification

	BXM10 BXM20	BXA20	BX310 BX330 BX360 BX480 BX930	BX470	BX910
Standard	S01325	S01325	S00515	T01315	S01315
Sharp edge	-	-	-	F	-
-L	-	S01315	-	-	-
-LF	-	S00515	-	-	-
-LC	-	S00535	-	-	-
-H	-	S01835	-	-	-
Wiper	-	S01315	-	-	-

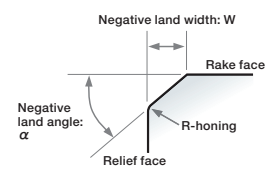

S	0	1	3	2	5
Edge prep. ID	Negative land width W	Negative land angle α			
T... Chamfered					
S... Chamfered + R-honing					
E... R-honing alone					
F... Sharp edge					

Reference pages: External toolholder → **C065** - Internal toolholder → **D043** -
 J-Series toolholder → **G044** - TungCap → **K021**

Grade **A**
 Insert **B**
 Toolholder Ext. **C**
 Toolholder Int. **D**
 Threading **E**
 Grooving **F**
 Miniature Tool **G**
 Milling Cutter **H**
 Endmill **I**
 Drilling Tool **J**
 Tooling System **K**
 User's Guide **L**
 Index **M**

Negative

Positive

PCD / CBN

C

D

G

R

S

T

V

W

Y

OTHERS

CBN Insert POSITIVE TYPE

- : Continuous cutting
- ◐ : Light interrupted cutting
- ✱ : Heavy interrupted cutting

P	Steel																
M	Stainless																
K	Cast iron															●●	
N	Non-ferrous																
S	Superalloy																
H	Hard material	●●	●●	●●	●●	●●	●●	●●	●●	●●	●●	●●	●●	●●	●●	●●	●●
	Sintered metal																

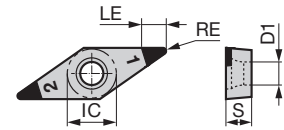

Shape	Designation		BXM10	BXM20	BXA10	BXA20	BX310	BX330	BX360	BX930	Dimension (inch)					Edge prep.										
	Inch	Metric									No. of corners	LE	RE	IC	S	D1	Standard	Sharp edge	L	LF	LC	H	Wiper	Chipbreaker		
	2QP-VBGT**-HP	2QP-VBGT221-HP	2QP-VBGT110304-HP	●		●					2	0.118	0.016	0.250	0.125	0.110									○	
		2QP-VBGT222-HP	2QP-VBGT110308-HP	●		●					2	0.087	0.031	0.250	0.125	0.110									○	
		2QP-VBGT331-HP	2QP-VBGT160404-HP	●		●					2	0.118	0.016	0.375	0.187	0.173										○
		2QP-VBGT332-HP	2QP-VBGT160408-HP	●		●					2	0.087	0.031	0.375	0.187	0.173										○
	2QP-VBMW	2QP-VBMW221	2QP-VBMW110304					●	●	●	2	0.122	0.016	0.250	0.125	0.110	○									
		2QP-VBMW222	2QP-VBMW110308					●	●	●	2	0.087	0.031	0.250	0.125	0.110	○									
		2QP-VBMW331	2QP-VBMW160404					●	●	●	2	0.122	0.016	0.375	0.187	0.173	○									
		2QP-VBMW332	2QP-VBMW160408					●	●	●	2	0.087	0.031	0.375	0.187	0.173	○									
	2QP-VCGW	2QP-VCGW 630.5	2QP-VCGW080202			●	●				2	0.138	0.080	0.187	0.094	0.091	○									
		2QP-VCGW 631	2QP-VCGW080204			●	●				2	0.122	0.016	0.187	0.094	0.091	○									
		2QP-VCGW 632	2QP-VCGW080208			●	●				2	0.087	0.031	0.187	0.094	0.091	○									
		2QP-VCGW 330.5	2QP-VCGW160402			●	●				2	0.138	0.080	0.375	0.187	0.173	○									
		2QP-VCGW 331	2QP-VCGW160404	●	●	●	●				2	0.122	0.016	0.375	0.187	0.173	○									
		2QP-VCGW 332	2QP-VCGW160408			●	●				2	0.087	0.031	0.375	0.187	0.173	○									
	2QP-VCGW**-H	2QP-VCGW 330.5-H	2QP-VCGW160402-H			●	●				2	0.138	0.080	0.375	0.187	0.173										○
		2QP-VCGW 331-H	2QP-VCGW160404-H			●	●				2	0.122	0.016	0.375	0.187	0.173										○
		2QP-VCGW 332-H	2QP-VCGW160408-H			●	●				2	0.087	0.031	0.375	0.187	0.173										○
	2QP-VCMW	2QP-VCMW331	2QP-VCMW160404						●	●	2	0.122	0.016	0.375	0.187	0.173	○									

● : Line up

Edge preparation specification

	BXM10 BXM20	BXA20	BX310 BX330 BX360 BX480 BX930	BX470	BX910
Standard	S01325	S01325	S00515	T01315	S01315
Sharp edge	-	-	-	F	-
-L	-	S01315	-	-	-
-LF	-	S00515	-	-	-
-LC	-	S00535	-	-	-
-H	-	S01835	-	-	-
Wiper	-	S01315	-	-	-

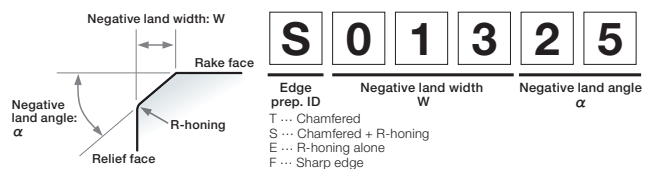

Reference pages: External toolholder → **C065** - Internal toolholder → **D043** -
 J-Series toolholder → **G044** - TungCap → **K016** -

CBN Insert NEGATIVE TYPE



- : Continuous cutting
- ◐ : Light interrupted cutting
- ✱ : Heavy interrupted cutting

For GX-RE

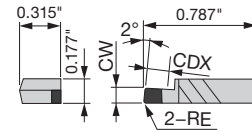
Shape	Designation	BX360	P	M	K	N	S	H	Dimension (inch)		
									CW±0.05	RE	CDX
	XGR** QBN XGR6310S-QBN	●							0.039	0.008	0.059
	XGR6315S-QBN	●							0.059	0.008	0.091
	XGR6320S-QBN	●							0.079	0.008	0.118
	XGR6325S-QBN	●							0.098	0.008	0.150
	XGR6330S-QBN	●							0.118	0.008	0.177
	XGR6335S-QBN	●							0.138	0.008	0.209
	XGR6340S-QBN	●							0.157	0.008	0.236
	XGR6345S-QBN	●							0.177	0.008	0.236



For TungCut

Shape	Designation	BX360	P	M	K	N	S	H	Dimension (inch)				Edge prep.			
									Seat size	CW±0.025	RE	INSL	h	Standard	S	H
	SGN SGN200-020	●							2	0.079	0.008	0.787	0.197	○		
	SGN300-020	●							3	0.118	0.008	0.787	0.197	○		
	SGN400-020	●							4	0.157	0.008	0.787	0.197	○		
	SGN** S SGN200-020-S	●							2	0.079	0.008	0.787	0.197	○		
	SGN300-020-S	●							3	0.118	0.008	0.787	0.197	○		
	SGN400-020-S	●							4	0.157	0.008	0.787	0.197	○		
	SGN500-020-S	●							5	0.197	0.008	0.984	0.217	○		
	SGN** H SGN200-020-H	●							2	0.079	0.008	0.787	0.197			○
	SGN300-020-H	●							3	0.118	0.008	0.787	0.197			○
	SGN400-020-H	●							4	0.157	0.008	0.787	0.197			○
	SGN500-020-H	●							5	0.197	0.008	0.984	0.217			○

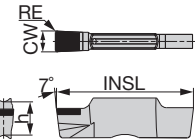

● : Line up

Edge preparation specification

	BX360
Standard	E002
-S	S01325
-H	S01335

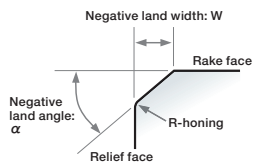

Edge prep. ID	Negative land width W	Negative land angle alpha
S	0	1
3	2	5

S ... Chamfered + R-honing
E ... R-honing alone

Reference pages: XGR...: Toolholder → **F100 -**

SGN...: Toolholder → **F013 -**



PCD Insert

● : Continuous cutting
 ○ : Light interrupted cutting
 ✱ : Heavy interrupted cutting

Negative type with rake

P	Steel									
M	Stainless									
K	Cast iron									
N	Non-ferrous	●	●	●						
S	Superalloy									
H	Hard material									

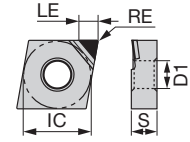

Shape	Designation		DX110	DX120						Dimension (inch)					Edge prep.			Rake angle		
	Inch	Metric								No. of corners	LE	RE	IC	S	D1	Sharp edge				
	CNMM** -DIA	CNMM 430.5 DIA	CNMM120402 -DIA	●																
		CNMM 431 DIA	CNMM120404 -DIA	●																
		1QP-CNMM 430.5	1QP-CNMM120402	●																
		1QP-CNMM 431	1QP-CNMM120404	●																
	DNMM** -DIA	DNMM 430.5 DIA	DNMM150402 -DIA	●																
		DNMM 431 DIA	DNMM150404 -DIA	●																
	TNMM** -DIA	TNMM 330.5 DIA	TNMM160402 -DIA	●																
		TNMM 331 DIA	TNMM160404 -DIA	●																
		1QP-TNMM 330.5	1QP-TNMM160402	●																
		1QP-TNMM 331	1QP-TNMM160404	●																
	VNMM** -DIA	VNMM 330.5 DIA	VNMM160402 -DIA	●																
		VNMM 331 DIA	VNMM160404 -DIA	●																
		VNMM 332 DIA	VNMM160408 -DIA	●																

● : Line up

Reference pages: External toolholder → **C018** - Internal toolholder → **D028** -
 J-Series toolholder → **G057** - TungCap → **K008** -





PCD Insert

- : Continuous cutting
- ◐ : Light interrupted cutting
- ◑ : Heavy interrupted cutting

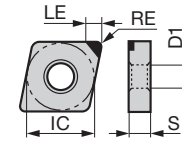
Negative type

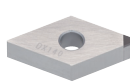
P	Steel																			
M	Stainless																			
K	Cast iron																			
N	Non-ferrous	●●●●																		
S	Superalloy																			
H	Hard material																			



Shape	Designation		DX140	DX160	No. of corners	Dimension (inch)					Edge prep.								
	Inch	Metric				LE	RE	IC	S	D1	Sharp edge								
	CNGA** - DIA	CNGA 431 DIA	CNGA120404 - DIA	●	1	0.138	0.016	0.500	0.187	0.203	○								
		CNGA 432 DIA	CNGA120408 - DIA	●	1	0.110	0.031	0.500	0.187	0.203	○								
	DNGA** - DIA	DNGA 431 DIA	DNGA150404 - DIA	● ●	1	0.122	0.016	0.500	0.187	0.203	○								
		DNGA 432 DIA	DNGA150408 - DIA	●	1	0.110	0.031	0.500	0.187	0.203	○								
	SNGA** - DIA	SNGA 431 DIA	SNGA120404 - DIA	●	1	0.142	0.016	0.500	0.187	0.203	○								
		SNGA 432 DIA	SNGA120408 - DIA	●	1	0.142	0.031	0.500	0.187	0.203	○								
	SNGN** - DIA	SNGN 432 DIA	SNGN120408 - DIA	●	1	0.142	0.031	0.500	0.187	-	○								
	TNGA** - DIA	TNGA 331 DIA	TNGA160404 - DIA	● ●	1	0.126	0.016	0.375	0.187	0.150	○								
		TNGA 332 DIA	TNGA160408 - DIA	● ●	1	0.031	0.031	0.375	0.187	0.150	○								

● : Line up

Reference pages: External toolholder → **C018** - Internal toolholder → **D028** -
 J-Series toolholder → **G057** - TungCap → **K008** -



PCD Insert

- : Continuous cutting
- ◐ : Light interrupted cutting
- ◑ : Heavy interrupted cutting

Positive type
with rake

P	Steel																			
M	Stainless																			
K	Cast iron																			
N	Non-ferrous	●	●	●																
S	Superalloy																			
H	Hard material																			

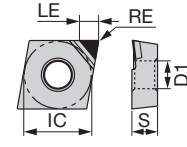

Shape	Designation		DX110	DX120						Dimension (inch)					Edge prep.		Rake angle					
	Inch	Metric								No. of corners	LE	RE	IC	S	D1	Sharp edge						
	CCMT** -DIA	CCMT 21.50.5-DIA	CCMT060202-DIA	●																		
		CCMT 21.51-DIA	CCMT060204-DIA	●																		
		CCMT 32.50.5-DIA	CCMT09T302-DIA	●																		
		CCMT 32.51-DIA	CCMT09T304-DIA	●																		
		1QP-CCMT 21.51	1QP-CCMT060204	●																		
		1QP-CCMT 32.51	1QP-CCMT09T304	●																		
	DCMT** -DIA	DCMT 21.50.5-DIA	DCMT070202-DIA	●																		
		DCMT 21.51-DIA	DCMT070204-DIA	●																		
		DCMT 32.50.5-DIA	DCMT11T302-DIA	●																		
		DCMT 32.51-DIA	DCMT11T304-DIA	●																		
	TCMT** -DIA	TCMT 630.5-DIA	TCMT080202-DIA	●																		
		TCMT 631-DIA	TCMT080204-DIA	●																		
		TCMT 21.50.5-DIA	TCMT110202-DIA	●																		
		TCMT 21.51-DIA	TCMT110204-DIA	●																		
		TCMT 220.5-DIA	TCMT110302-DIA	●																		
		TCMT 221-DIA	TCMT110304-DIA	●																		
		1QP-TCMT 221	1QP-TCMT110304	●																		
	VCMT** -DIA	VCMT 330.5-DIA	VCMT160402-DIA	●																		
		VCMT 331-DIA	VCMT160404-DIA	●																		

● : Line up

Negative

Positive

PCD / CBN

C

D

G

R

S

T

V

W

Y

OTHERS

Reference pages: External toolholder → **C026** - Internal toolholder → **D028** -
 J-Series toolholder → **G027** - TungCap → **K016** -

PCD Insert

- : Continuous cutting
- ◐ : Light interrupted cutting
- ✱ : Heavy interrupted cutting

Positive type

P	Steel																		
M	Stainless																		
K	Cast iron																		
N	Non-ferrous	●	●	●	●	●													
S	Superalloy																		
H	Hard material																		

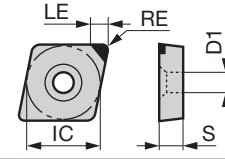

Shape	Designation		DX120	DX140	DX160	No. of corners	Dimension (inch)					Edge prep.		Ext. Toolholder	Int. Toolholder	Threading	Grooving	Miniature Tool	Endmill	Drilling Tool	Tooling System	Index		
	Inch	Metric					LE	RE	IC	S	D1	Sharp edge												
	CCGW** -DIA	CCGW 21.5V -DIA	CCGW060200 -DIA	●			1	0.094	0.002	0.250	0.094	0.110	○											
		CCGW 21.50.5 -DIA	CCGW060202 -DIA	●			1	0.094	0.008	0.250	0.094	0.110	○											
		CCGW 21.51 -DIA	CCGW060204 -DIA	●			1	0.094	0.016	0.250	0.094	0.110	○											
		CCGW 32.50.5 -DIA	CCGW09T302 -DIA	●			1	0.138	0.008	0.375	0.156	0.173	○											
		CCGW 32.51 -DIA	CCGW09T304 -DIA	● ●			1	0.138	0.016	0.375	0.156	0.173	○											
		CCGW 32.52 -DIA	CCGW09T308 -DIA	●			1	0.134	0.031	0.375	0.156	0.173	○											
	CPGA** -DIA	CPGA080202 -DIA	CPGA080202 -DIA	●			1	0.094	0.008	0.375	0.094	0.157	○											
		CPGA 31.51 DIA	CPGA090204 -DIA	●			1	0.138	0.016	0.375	0.094	0.157	○											
	DCGW** -DIA	DCGW 21.5V -DIA	DCGW070200 -DIA	●			1	0.094	0.002	0.250	0.094	0.110	○											
		DCGW 21.50.5 -DIA	DCGW070202 -DIA	● ●			1	0.094	0.008	0.250	0.094	0.110	○											
		DCGW 21.51 -DIA	DCGW070204 -DIA	●			1	0.016	0.016	0.250	0.094	0.110	○											
		DCGW 32.50.5 -DIA	DCGW11T302 -DIA	●			1	0.126	0.008	0.375	0.156	0.173	○											
		DCGW 32.51 -DIA	DCGW11T304 -DIA	●			1	0.118	0.016	0.375	0.156	0.173	○											
		DCGW 32.52 -DIA	DCGW11T308 -DIA	●			1	0.106	0.031	0.375	0.156	0.173	○											
	EPGW** -DIA	EPGW 520.5 -DIA	EPGW040102 -DIA	●			1	0.075	0.008	0.125	0.063	0.091	○											
		EPGW 521 -DIA	EPGW040104 -DIA	●			1	0.075	0.016	0.125	0.063	0.091	○											
	SPGN** -DIA	SPGN 322 -DIA	SPGN090308 -DIA	●			1	0.142	0.031	0.375	0.125	-	○											
		SPGN 420.5 -DIA	SPGN120302 -DIA	●			1	0.142	0.008	0.500	0.125	-	○											
		SPGN 421 -DIA	SPGN120304 -DIA	●			1	0.142	0.016	0.500	0.125	-	○											
		SPGN 422 -DIA	SPGN120308 -DIA	● ●			1	0.142	0.031	0.500	0.125	-	○											

● : Line up

PCD Insert

- : Continuous cutting
- ◐ : Light interrupted cutting
- ◑ : Heavy interrupted cutting

Positive type

P	Steel									
M	Stainless									
K	Cast iron									
N	Non-ferrous	●●●●								
S	Superalloy									
H	Hard material									

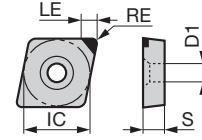

Negative

Positive

PCD / CBN

C

D

G

R

S

T

V

W

Y

OTHERS

Shape	Designation		DX120	DX140	No. of corners	Dimension (inch)					Edge prep.			
	Inch	Metric				LE	RE	IC	S	D1	Sharp edge			
	TPGA**-DIA	TPGA730.5-DIA	TPGA090202-DIA	●	1	0.094	0.008	0.219	0.094	0.098	○			
		TPGA731-DIA	TPGA090204-DIA	●	1	0.087	0.016	0.219	0.094	0.098	○			
		TPGA21.50.5-DIA	TPGA110202-DIA	●	1	0.094	0.008	0.250	0.094	0.110	○			
		TPGA21.51-DIA	TPGA110204-DIA	●	1	0.087	0.016	0.250	0.094	0.110	○			
		TPGA220.5-DIA	TPGA110302-DIA	●	1	0.094	0.008	0.250	0.125	0.118	○			
		TPGA221-DIA	TPGA110304-DIA	●	1	0.087	0.016	0.250	0.125	0.118	○			
		TPGA222-DIA	TPGA110308-DIA	●	1	0.031	0.031	0.250	0.125	0.118	○			
		TPGA320.5-DIA	TPGA160302-DIA	●	1	0.130	0.008	0.375	0.125	0.157	○			
		TPGA321-DIA	TPGA160304-DIA	●	1	0.126	0.016	0.375	0.125	0.157	○			
		TPGA322-DIA	TPGA160308-DIA	●	1	0.031	0.031	0.375	0.125	0.157	○			
		TPGN**-DIA	TPGN 731-DIA	TPGN090204-DIA	●	1	0.087	0.016	0.219	0.094	-	○		
		TPGN 221-DIA	TPGN110304-DIA	●●	1	0.126	0.016	0.250	0.125	-	○			
		TPGN 222-DIA	TPGN110308-DIA	●	1	0.031	0.031	0.250	0.125	-	○			
		TPGN 320.5-DIA	TPGN160302-DIA	●	1	0.130	0.008	0.375	0.125	-	○			
		TPGN 321-DIA	TPGN160304-DIA	●●	1	0.126	0.016	0.375	0.125	-	○			
		TPGN 322-DIA	TPGN160308-DIA	●	1	0.031	0.031	0.375	0.125	-	○			
	TPGW**-DIA	TPGW 630.5-DIA	TPGW080202-DIA	●	1	0.094	0.008	0.187	0.094	0.091	○			
		TPGW 631-DIA	TPGW080204-DIA	●	1	0.094	0.016	0.187	0.094	0.091	○			
		TPGW 730.5-DIA	TPGW090202-DIA	●●	1	0.094	0.008	0.219	0.094	0.098	○			
		TPGW 731-DIA	TPGW090204-DIA	●	1	0.087	0.016	0.219	0.094	0.098	○			
		TPGW 21.50.5-DIA	TPGW110202-DIA	●●	1	0.094	0.008	0.250	0.094	0.110	○			
		TPGW 21.51-DIA	TPGW110204-DIA	●●	1	0.087	0.016	0.250	0.094	0.110	○			
		TPGW 2.520.5-DIA	TPGW130302-DIA	●●	1	0.130	0.008	0.313	0.125	0.134	○			
		TPGW 2.521-DIA	TPGW130304-DIA	●	1	0.126	0.016	0.313	0.125	0.134	○			
		TPGW 32.50.5-DIA	TPGW16T302-DIA	●	1	0.130	0.008	0.375	0.156	0.173	○			
		TPGW 32.51-DIA	TPGW16T304-DIA	●	1	0.126	0.016	0.375	0.156	0.173	○			
	TPGW 32.52-DIA	TPGW16T308-DIA	●	1	0.031	0.031	0.375	0.156	0.173	○				
	VCGW**-DIA	VCGW 330.5-DIA	VCGW160402-DIA	●	1	0.189	0.008	0.375	0.187	0.173	○			
		VCGW 331-DIA	VCGW160404-DIA	●	1	0.173	0.016	0.375	0.187	0.173	○			

● : Line up

Reference pages: External toolholder → **C075 -** Internal toolholder → **D050 -**

H T-CBN series for hardened steel and hard material

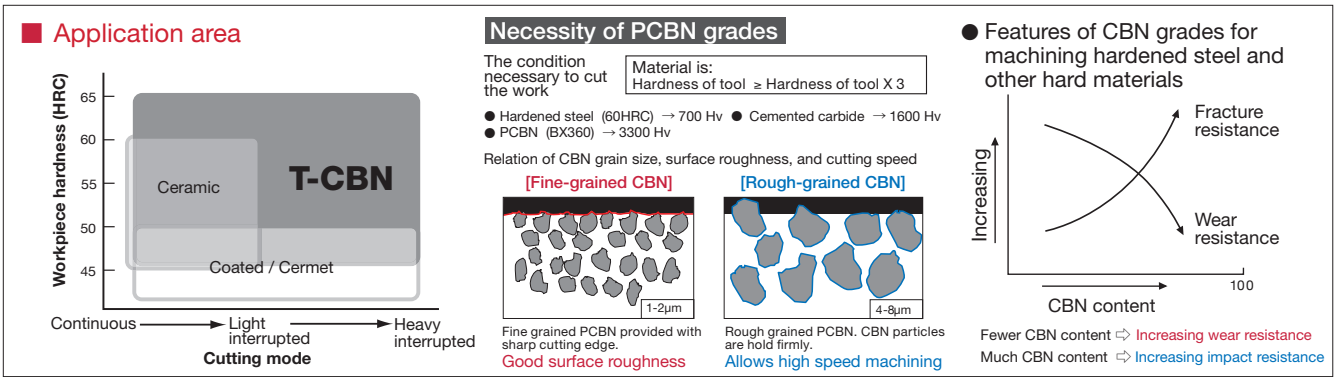

Basic selection of T-CBN grades in machining of hardened steel and hard material

Coated T-CBN grades

- BXA10** For continuous and light interrupted cutting
- BXA20** For general purpose, less than $V_c = 591$ sfm
- BXM10** For high speeds cutting
- BXM20** For general purpose, more than $V_c = 591$ sfm

Uncoated T-CBN grades

- BX310** For high speeds / Priority on wear resistance in continuous cutting
- BX330** For medium speeds / Priority on surface quality
- BX360** For low to medium speeds / General purpose grade with excellent fracture resistance
- BX380** For low to medium speeds / Priority on fracture resistance in heavy interrupted cutting

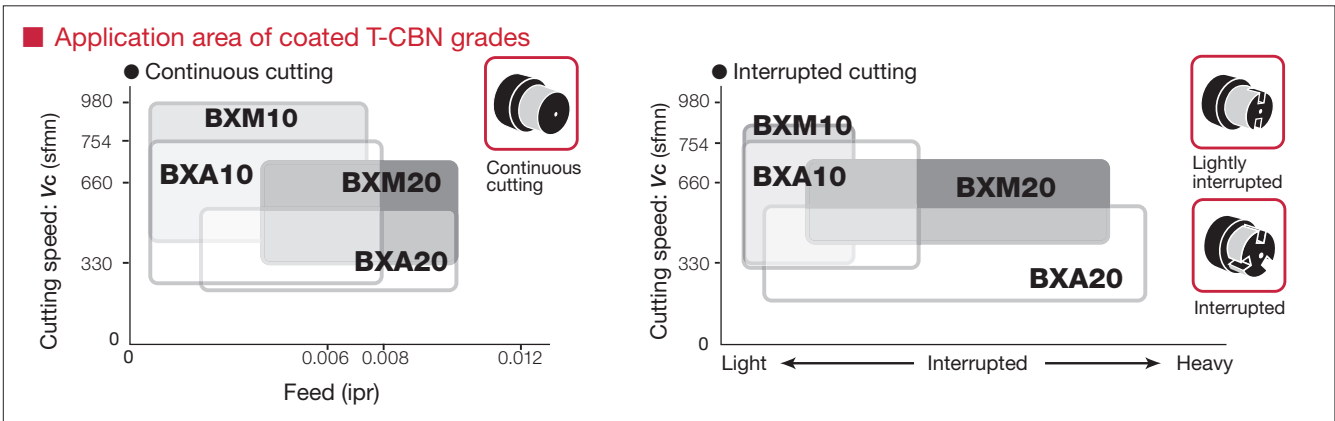

Effects of Coated T-CBN grades

Coated on hard CBN
Hardness: CBN > Coating layer

- Protect CBN from oxidation wear**
Since the coating layer intercepts air, oxidation wear of CBN can be prevented.
- Peeling of coating layer can be prevented**
Hard and deformation resistant CBN is excellent substrate material.

➔ **Improved resistance to flank wear**

Effects of coolant in machining of hardened steel

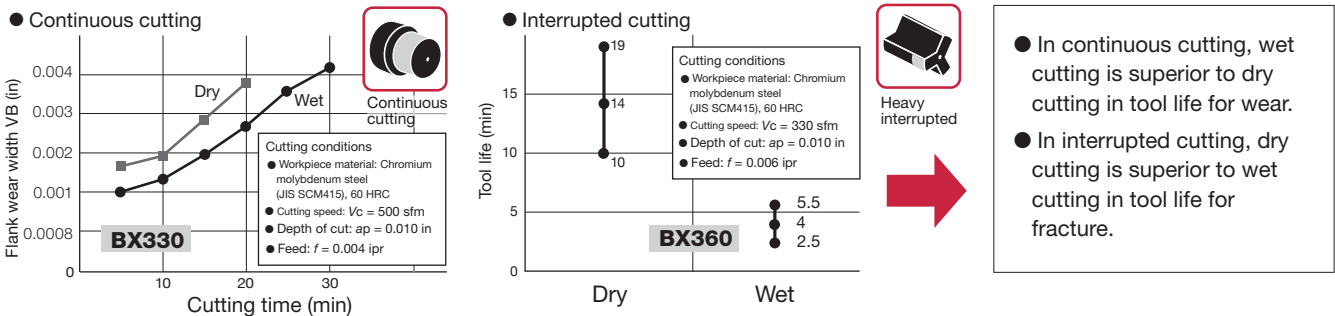

Technical Guide

T-CBN series for sintered metal

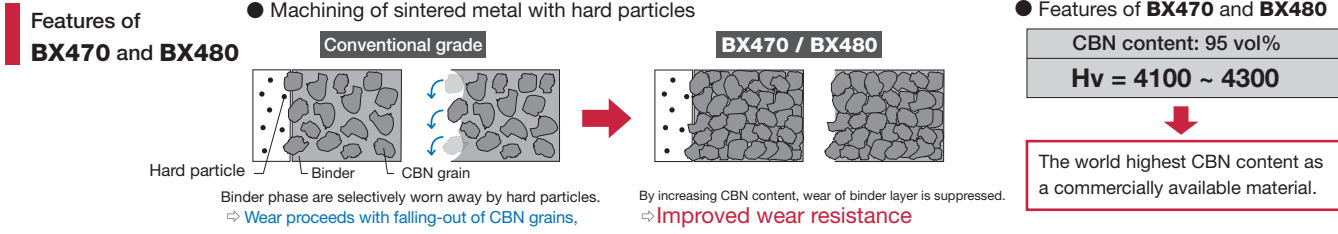
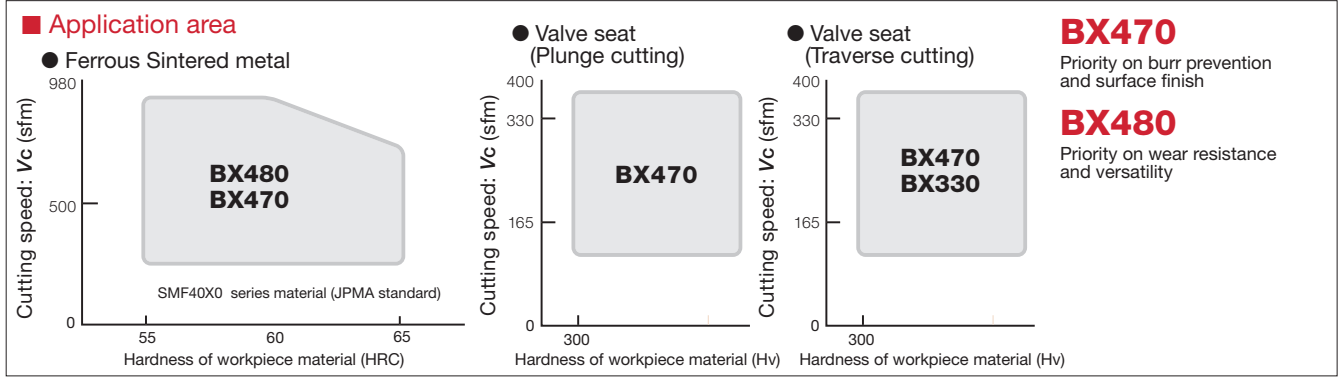

K T-CBN series for grey cast iron and ductile cast iron

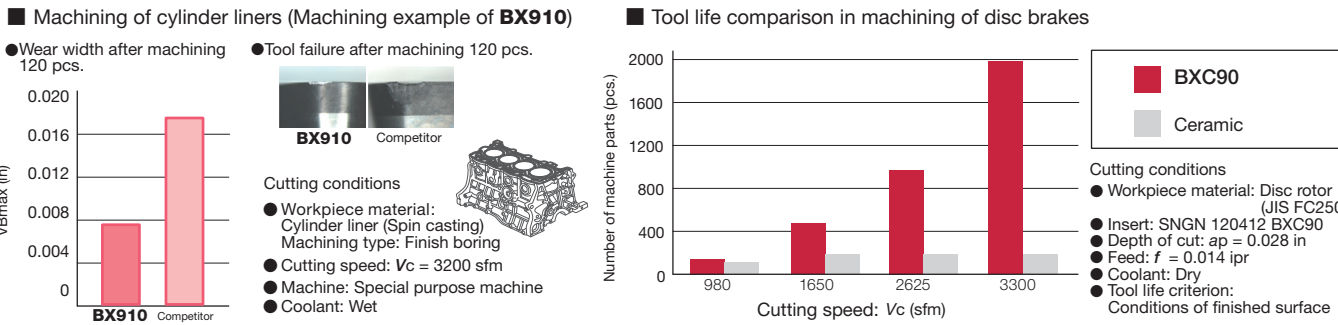
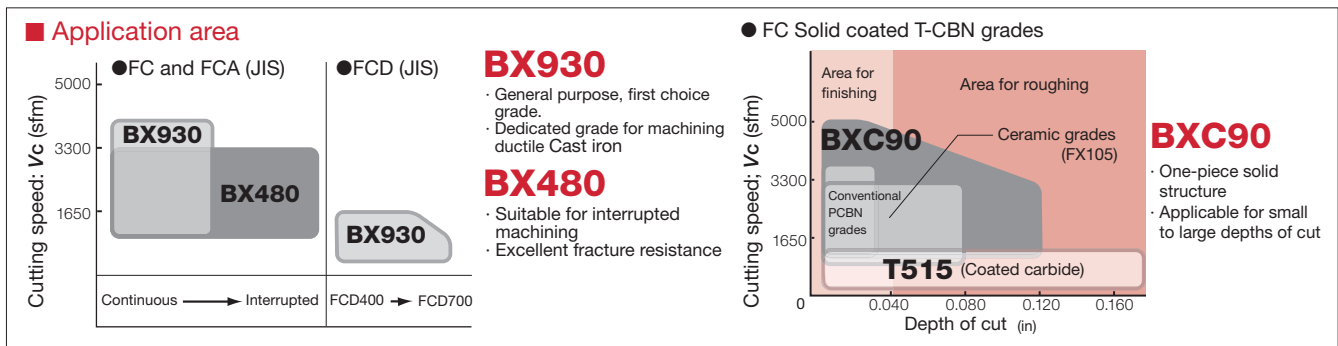

BX910 For machining cylinder liners

T-CBN Series

Edge preparation specifications

T-CBN inserts with special edge preparation specifications are made to order. Refer to the following description.

Designation system for edge specifications

Example:
 Negative land width: 0.13 mm
 Negative land angle: -25°
 With R-honing



Shape Negative land width: W Negative land angle: α

T ... Chamfered
 S ... Chamfered + R-honing
 E ... R-honing alone
 F ... Sharp edge

● Symbol

W	Negative land width (mm)	α	Negative land angle
005	0.05	10°	-10°
010	0.10	15°	-15°
013	0.13	20°	-20°
015	0.15	25°	-25°
018	0.18	30°	-30°
		35°	-35°
		40°	-40°

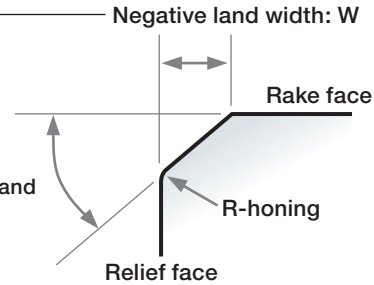

● Edge specification can be selected in combination of items described here.
 ● Inserts with "R" honing alone are available.

● Relationship between negative land angle and tool life in continuous turning

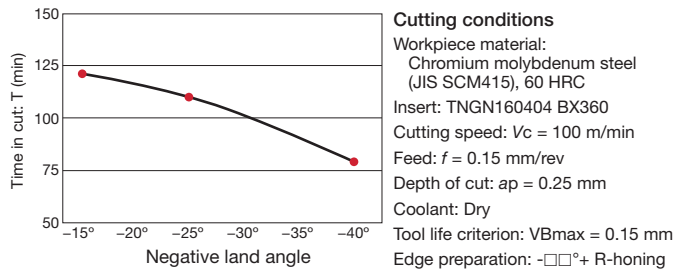

● Relationship between negative land angle and tool life in interrupted turning

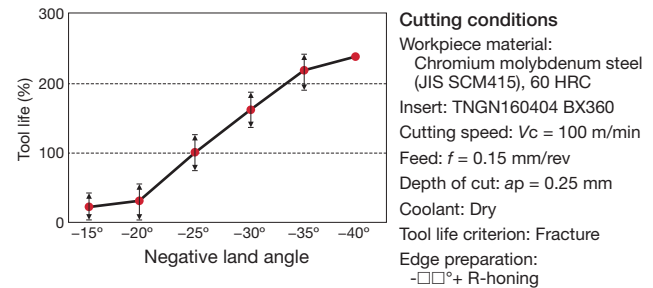

- For **continuous cutting**, small negative land angle is favorable to **minimize wear**.
- For **interrupted cutting**, large negative land angle is favorable to **minimize fracture**.

Standard edge specifications

Grade	BXA10	BXA20	BXM10	BXM20	BXC50	BX310	BX330	BX360	BX380	BX470	BX480	BX910	BX930
Negative insert	S01325	S01325	S01325	S01325	S01325	S01325	S01325	S01325	S01325	T01315	S01325	S01315	S01315
Positive insert	S01325	S01325	S01325	S01325	-	S00515	S00515	S00515	-	T01315	S00515	S01315	S00515

Wiper insert

● A finishing edge (wiper edge) is formed at the point of intersection between corner radius and straight cutting edge.

Effect of wiper edge

- **Doubles the productivity → Reduced machining time**
 The wiper edge can double the feed rate and moreover does not deteriorate the surface roughness. (Note: Feed rate: $*f < 0.3$ mm/rev)
- **Superior surface roughness → By integrating roughing and finishing into one process, productivity can be increased.**
 Compared with conventional inserts only with corner radius, surface roughness can be improved with the wiper edge.

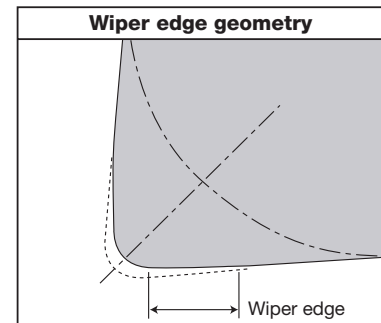

Profiles of surface roughness

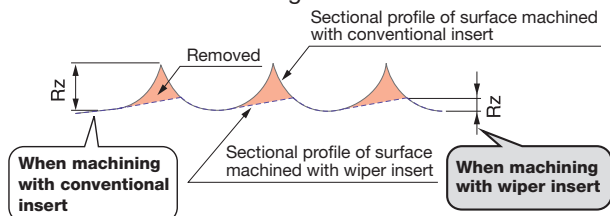

Recommended toolholders for wiper inserts

	2QP-CNGA1204**WL	3QP-WNGA080408WL	2QP-DNGA1504**WJ	3QP-TNGA1604**WG
End cutting angle	95°		93°	91°
External toolholder	ACLNR/L**12-A	AWLNR/L**08-A	ADJNR/L**15-A	ATGNR/L**16-A
	DCLNR/L**12	DWLNR/L**08	DDJNR/L**15	ATFNR/L**16-A
Internal toolholder	A**-ACLNR/L12-D...	A**-AWLNR/L08-D...	A**-ADUNR/L15-D...	A**-ATFNR/L16-D...

Technical Guide

T-CBN Series

5 edge preparation options covering various hard

Edge preparations turning applications

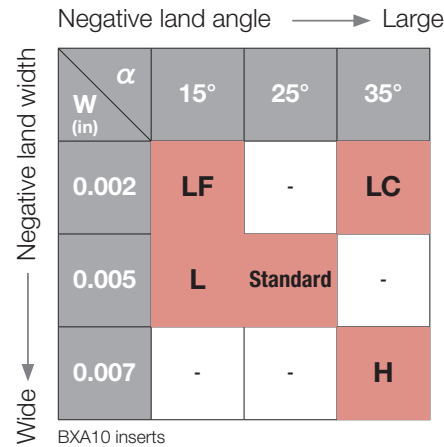

Selections of edge preparations

Allows you to select the most suited types of edge prep for your applications

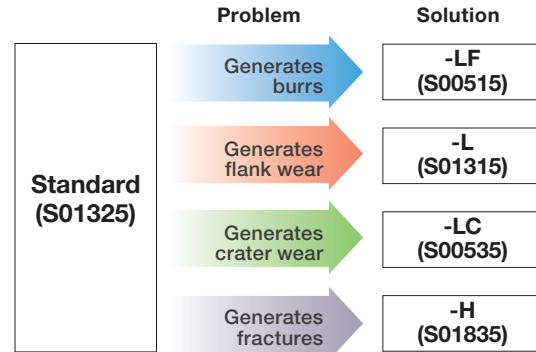

Cutting loads

The -L and -LF provide reduced cutting loads over the standard edge prep type

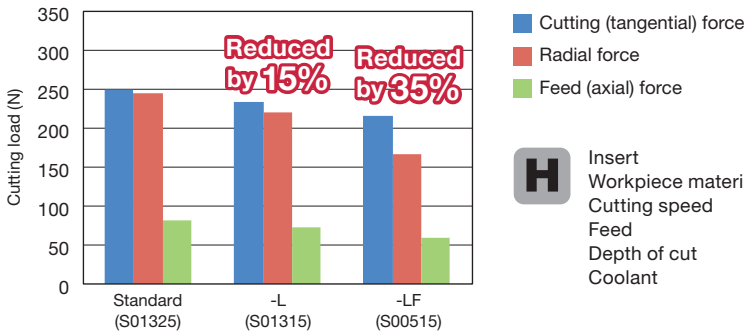

H Insert : 2QP-CNGA 432
 Workpiece material : 4140 (Alloy steel, 60HRC)
 Cutting speed : Vc = 328 sfm
 Feed : f = 0.012 ipr
 Depth of cut : ap = 0.008"
 Coolant : Dry

Flank wear

The -L and -LF provide reduced flank wear over the standard edge prep type

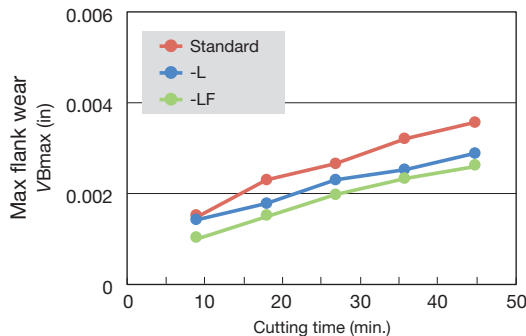

H Insert : 2QP-CNGA 432
 Workpiece material : 4140 (Alloy steel, 60HRC)
 Cutting speed : Vc = 427 sfm
 Feed : f = 0.006 ipr
 Depth of cut : ap = 0.008"
 Coolant : Wet

Crater wear

The -LC provides reduced crater wear over the standard edge prep type
 Reduces insert fracture induced by crater wear

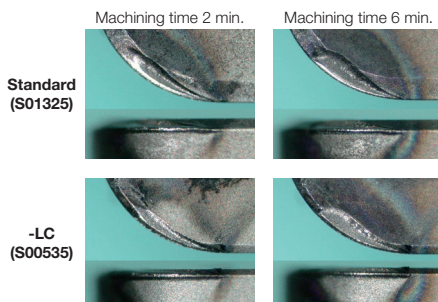

H Insert : 2QP-CNGA 432
 Workpiece material : 4140 (Alloy steel, 60HRC)
 Cutting speed : Vc = 656 sfm
 Feed : f = 0.004 ipr
 Depth of cut : ap = 0.008"
 Coolant : Wet

PCD grade, T-DIA series

Expanded product line allows T-DIA tools to be applied to wider workpiece materials and cutting conditions.

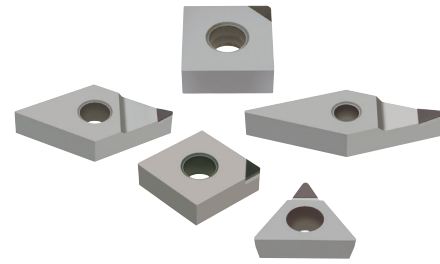

Features and applications (Physical and mechanical properties)

	DX110	DX120	DX140	DX160
Grade				
Property	Super fine grained grade. Excels in surface finish.	Fine grained grade. Excels in surface finish.	General purpose grade	High purity grade for hard materials
Approx. grain size of diamond (µm)	< 1	5	13	28
Hardness (Hv)	8500	→→→→→		10000 (Harder)
Wear resistance		→→→→→		Higher
Grindability (Cutting edge sharpness)	Better	←←←←←		

Cutting performance (Wear resistance)

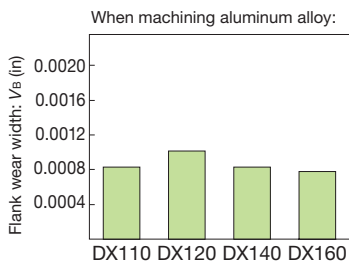

- Continuous external turning**
- Workpiece material: 10 % Si, aluminum alloy
 - Insert: SPGN120308-DIA
 - Toolholder: CSBPR2525M4
 - Cutting speed: $v_c = 1640$ sfm
 - Feed: $f = 0.004$ ipr
 - Depth of cut: $a_p = 0.020$ in
 - Coolant: Dry cutting
 - Cutting time: 30 min

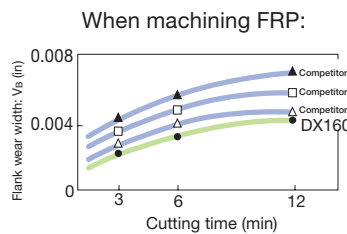

- Face milling**
- Workpiece material: Fiber reinforced plastics (FRP)
 - Insert: SFCN42ZFN-DIA
 - Milling cutter: THF4408RIA
 - Cutting speed: $v_c = 3090$ sfm
 - Feed: $f = 0.004$ ipr
 - Depth of cut: $a_p = 0.059$ in
 - Coolant: Dry cutting

Grade selection guide

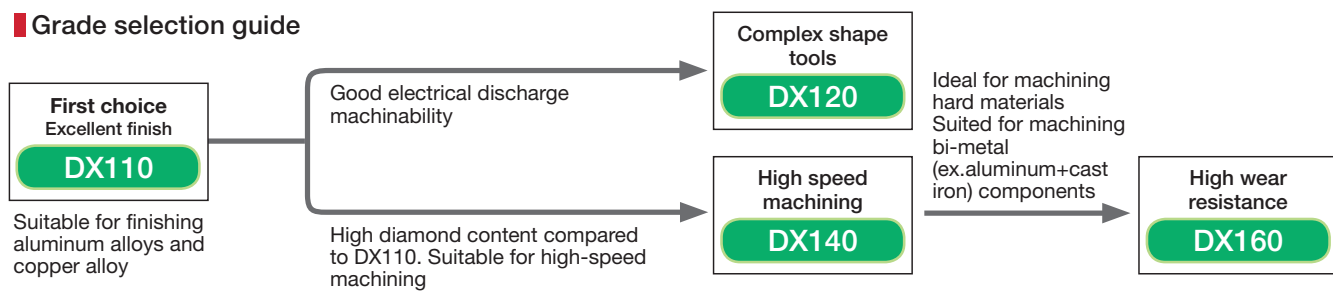

STANDARD CUTTING CONDITIONS

ISO	Workpiece material	Grade				Cutting speed v_c (sfm)	Depth of cut a_p (in)	Feed f (ipr)
		DX110	DX120	DX140	DX160			
N	Aluminum alloys (Si < 12 %)	◎	○	○		3300 - 8200	0.002 - 0.080	0.002 - 0.008
	Aluminum alloys (Si ≥ 12 %)	◎	○	○	○	1300 - 2630	0.002 - 0.080	0.002 - 0.008
	Copper, brass	◎	○	○		1640 - 4920	0.002 - 0.080	0.002 - 0.008
	Phosphor bronze	◎	○	○		980 - 1640	0.002 - 0.080	0.002 - 0.008
	Carbon, graphite		○	○	◎	980 - 1640	0.002 - 0.080	0.002 - 0.008
	FRP		○	○	◎	1640 - 3300	0.002 - 0.020	0.001 - 0.004
	Plastics	◎	○	○		1640 - 3300	0.002 - 0.020	0.00039 - 0.002
	Cemented carbides			○	◎	30 - 65	0.002 - 0.008	0.00039 - 0.002
	Green ceramics			○	◎	330 - 500	0.002 - 0.080	0.001 - 0.004

(Note) ◎ : First choice ○ : Second choice

MEMO

Negative

Positive

PCD / CBN

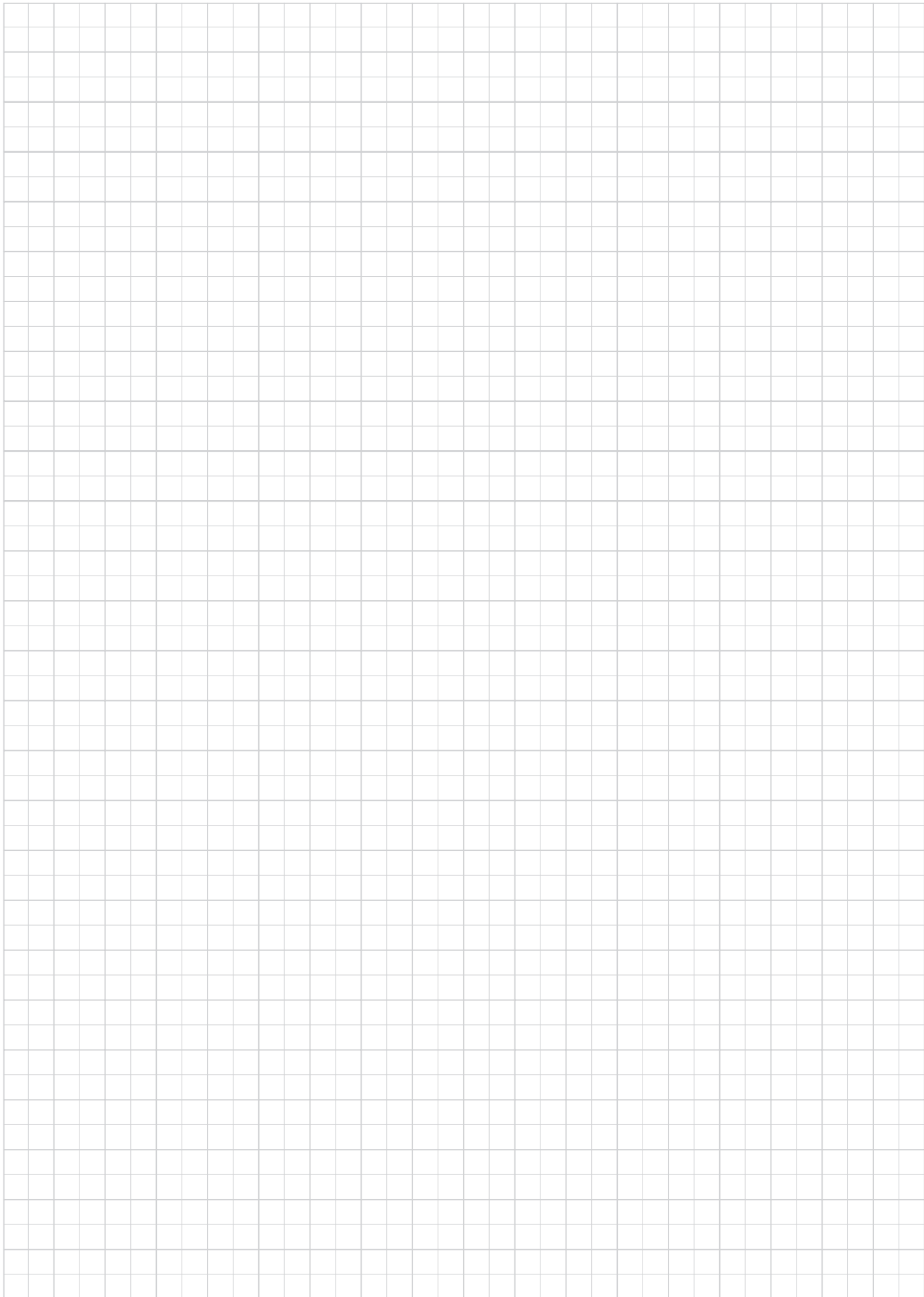

External Toolholder



External Toolholder - Content structure

- Indexable toolholders are listed by cutting edge shape.
- In the same cutting edge shape, the inserts are sorted alphabetically.
- The order of the list: CN** insert → DN** insert → RN** insert → SN** insert → TN** insert → VN** insert → WN** insert
- Toolholders in the catalog are our standard stock items.

How to use the page

Method 1 Select the cutting edge shape described at the left end of each page, jump to the page on the left index, and choose a designation you need (4) in the dimension table (3). Applicable inserts are shown in (6) and (8).

Method 2 Select the cutting edge on C003 and check the details on the product page.

Method 3 Select the series name of a toolholder on C003 and check the details on each page.

Method 4 Select an item from Quick Guide on C008-C015.

ISO TURN ACLNR/L-Eco
Double-clamp toolholder with 95° approach angle, for negative 80° rhombic inserts

ISO TURN PCLNR/L-Eco
Lever-lock toolholder with 95° approach angle, for negative 80° rhombic inserts

ISO TURN PCLNR/L-CHP-Eco
Lever-lock toolholder with 95° approach angle, for negative 80° rhombic inserts, with high pressure coolant capability

ISO TURN TUNGTJET
Lever-lock toolholder with 95° approach angle, for negative 80° rhombic inserts, with high pressure coolant capability

SPARE PARTS

Reference pages: ACLNR/L-Eco, PCLNR/L-CHP-Eco: Inserts → B056 - Parts for coolant hose → C142

Reference pages: PCLNR/L-Eco: Inserts → B056 -

- 1: Cutting edge shape
- 2: Series name of indexable external toolholders
- 3: Dimension table
- 4: Toolholder designation
e.g. right-hand, 1 inch square shank
- 5: Dimension drawing (conforming to ISO13399)
- 6: Applicable insert
- 7: Spare parts
- 8: Basic selection
- 9: Reference pages

→ **ACLNR1633-A**

When ordering

- Please specify the designation and quantity.

e.g. **ACLNR164-A ... 1** (one external toolholder per package)

* Inserts are not included. Please order those separately.

Main products

L		C018
J		C040
N		C070
V		C072
P		C076
A		C078
G		C084
BR		C096
X		C102
D		C105
S		C111
K		C115
F		C119
Q-H		C125
Special		C137

			Inch	Metric
	TURN^{FEED} Innovative tool realizing both high productivity and economy C016, C102		✓	✓
	ISO E^{CO}TURN Small-sized "Eco" insert series for maximized profits C017		✓	✓
	MINI^{FORCE}TURN Economical double-sided inserts with excellent sharpness C033 - C036, C042 - C045 C059 - C061, C137 - C138		✓	✓
	TURNING A Highly rigid clamping system with excellent repeatability C008		✓	✓
	TUNG T^{URN}JET Toolholders for high pressure coolant supply C018, C021, C023, C031, C038, C040, C046, C048, C050, C058, C063 - C064, C067, C092, C133, C140 - C141		✓	✓
	DIMPLE FX Ceramic insert with dimple for highly efficient cast iron machining C010		✓	✓
	TURN TEC Inserts and toolholders for roughing large depths of cut with high productivity C082, C097, C120		✓	
	Y-PRO SERIES Inserts with 25° corner angle for profiling C069, C136, C139		✓	✓
	TURN FEED Tool series for super high-feed cutting C104		✓	
	FIX R TURN Highly productive round insert with 6 indexes C089, C107		✓	✓

Designation system for Toolholders

A,C	Clamp-on
D	Double clamp ("One Double")
E	Eccentric pin lock
M	Multi-clamp
P	Pin-lock
S	Screw-on
T	Taper-lock
W	Wedge-on
1 Clamping system	

Symbol	Shape	Offset						
A		Without	G		With	R		Without
							S	
B		Without	J		With	V		Without
							X*	
C		Without	L		With	Y		
							Without	*mark: Tungaloy's symbol
D		Without	N		Without			
						Without		
E		Without	P		Without			
						Without		
F		Without	Q		With			
						With		
3 Cutting edge style								

(Example)



2 Insert shape	
C	80° Rhombic
D	55° Rhombic
K	55° Parallelogram
R	Round
S	Square
T	Triangular
V	35° Rhombic
W	Trigon

4 Relief angle of insert	
C	0°
B	5°
C	7°
D	15°
E	20°
P	11°

ANSI Designation

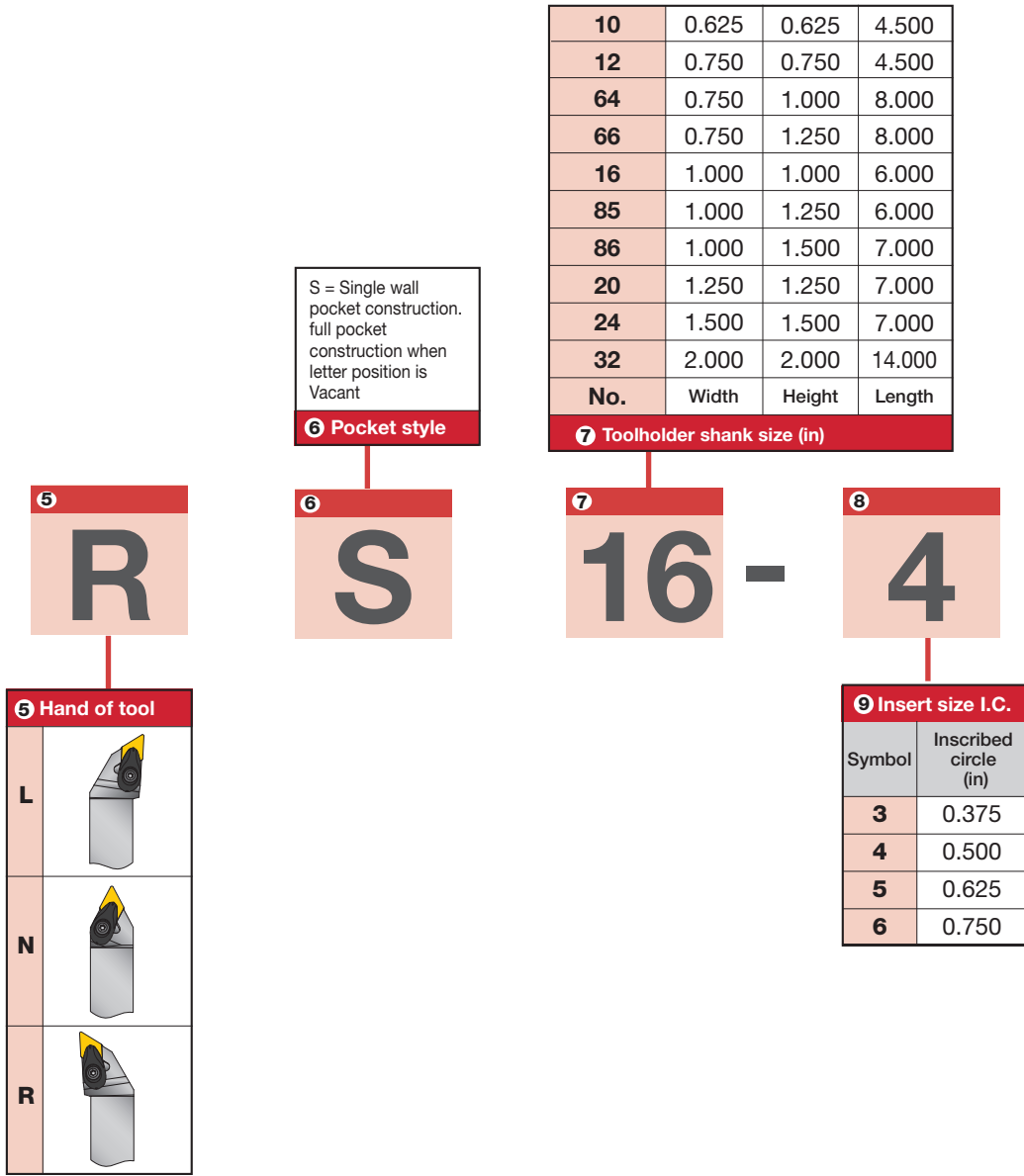

Grade	A
Insert	B
Ext. Toolholder	C
Int. Toolholder	D
Threading	E
Grooving	F
Miniature Tool	G
Milling Cutter	H
Endmill	I
Drilling Tool	J
Tooling System	K
User's Guide	L
Index	M

Designation system for Toolholders

A Double Clamping		JP Side lever clamping		
C Clamp-on		JS Screw-on		X Double Clamping
D One-Double		JT Side clamping		S Screw-on
P Lever-lock		M Multi clamping		T Taper-lock

1 Clamping system

Symbol	Shape	Offset	H		With	P		Without
A		Without	I		Without	Q		With
			J		With	S		With
B		Without	J2		Without	V		Without
C		Without	K		With	U		With
D		Without	L		With	X		With
E		Without	L2		Without	Y		With
F		With	N		Without	Z		Without
G		With	N3		With	No mark: ISO symbol *mark: Tungaloy's symbol		
			P		Without			

3 Cutting edge style

(Example)

1
A

W

3
L

N

R

(Example)

P

2
T

G

4
N

5
R

2 Insert shape	
C	80° Rhombic
D	55° Rhombic
K	55° Parallelogram
R	Round
S	Square
T	Triangular
V	35° Rhombic
W	Trigon

4 Relief angle of insert	
C	7°
B	5°
N	0°
P	11°

5 Hand of tool	
L	
N	
R	

ISO Designation

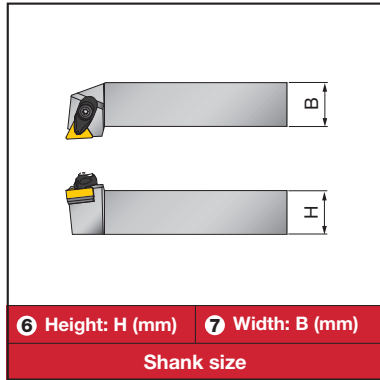

6

25

20

7

25

20

F	80	*MiniForceTurn
F	85*	
H	100	
X	120	
K	125	
M	150	
P	170	
Q	180	
R	200	
S	250	
T	300	
U	350	

8 Holder length

8

M

08

K

9

RD	Ceramic insert with dimple
C	M-type for ceramic insert
A	Turning A

11 Added symbol

11

A

10

3

9 Insert size



Symbol	Inscribed circle (mm)	
3	9.525	
4	12.7	
5	15.875	
6	19.05	
8	25.4	

In the ISO metric system, edge length of inserts is expressed by L in 2 digits.

10 Insert thickness

Symbol	Thickness (mm)	
2	3.18	
3	4.76	

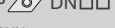
External Toolholder - Quick Guide (Negative type)

Name	Appearance/Feature	External profiling					Turning
		Turning / Facing					
		L 95°	J 93°	N 63°	V 72.5°	P 62.5°	G 91°
TURN T FEED Double clamp	 <ul style="list-style-type: none"> Economical, 10-cornered insert ensures high machining efficiency Available in 2 types of holders: HD type for large depths of cut and HF type for high feed turning Maximum 0.276" (7 mm) depth of cut, or maximum feed 0.079 ipr (2 mm) per rev is attainable! 						
	 <ul style="list-style-type: none"> Improved clamping rigidity realizes excellent repeatability and long tool life. The enlarged surface of insert pressing provides excellent repeatability. Great performance even with VNMG type (corner angle 35°), which is particularly prone to the displacement of the cutting edge position. *Corner angle 25° and YNMG type also can be used. The simple structure contributes to cost reduction. Easy operation with one wrench. 	80°  ACLNR/L C018, C020	55°  ADJNR/L C040, C046	35°  AVVNN C072, C073	55°  ADPNN C076	60°  ATGNR/L C091	
TURNING A Double clamp	<ul style="list-style-type: none"> Improved clamping rigidity realizes excellent repeatability and long tool life. The enlarged surface of insert pressing provides excellent repeatability. Great performance even with VNMG type (corner angle 35°), which is particularly prone to the displacement of the cutting edge position. *Corner angle 25° and YNMG type also can be used. The simple structure contributes to cost reduction. Easy operation with one wrench. 	70°  ACLNR/L C020	60°  ATJNR/L C055	25°  AVVNN C073			
D One-Double	 <ul style="list-style-type: none"> Excellent usability that the clamp and the lever simultaneously hold the insert in tightening. The tool can be handled from the back side and provides excellent usability even when the tool is placed in the reverse. 	80°  DCLNR/L C025	55°  DDJNR/L C049			60°  DTGNR/L C094	
		70°  DCLNR/L C025					
		80°  DWLNR/L C039					

Please see the page C*** for the product details.

Turning	Turning / Chamfering	External profiling		Turning / Facing Chamfering	Facing		Profiling	External profiling
B-R 75° 	D 45° 	X 22.5° 	X 48.5° 	S 45° 	K 75° 	F 91° 	Q*1 · H*1 45° 	Special
		22.5° POMG PPXOR/L-HF C102	48.5° POMG PPXOR/L-HD C102					
90° SN□□ ASBNR/L C098	90° SN□□ ASDNN C108			90° SN□□ ASSNR/L C112	90° SN□□ ASKNR/L C115	60° TN□□ ATFNR/L C122	55° DN□□ ADQNR/L C125, C126	- RN□□ ARGNR/L C084
							60° TN□□ ATQNR/L C130	
							35° VN□□ AVQNR/L C131, C132	
							25° YNMG AVQNR/L C132	
90° SN□□ DSBNR/L C099	90° SN□□ DSDNN C109			90° SN□□ DSSNR/L C115	90° SN□□ DSKNR/L C118	60° TN□□ DTFNR/L C124	55° DN□□ DDQNR/L C128	- RN□□ DRGNR/L C086

*1: Symbol used exclusively by Tungaloy

Grade
Insert
Ext. Toolholder
Int. Toolholder
Threading
Grooving
Miniature Tool
Milling Cutter
Endmill
Drilling Tool
Tooling System
User's Guide
Index

A
B
C
D
E
F
G
H
I
J
K
L
M

External Toolholder - Quick Guide (Negative type)

Name	Appearance/Feature	Turning / Facing		External profiling		Turning
		L 95° 	J 93° 	V 72.5° 	P 62.5° 	A 91°
DIMPLEFX Double clamp for dimple ceramic insert	 <ul style="list-style-type: none"> Firmly clamp the insert at two locations: drawing by dimple and holding from the top. Two locations can be clamped simultaneously with one screw. Excellent operability. The tool can be handled from the back side. Easy to change inserts when mounting those on the back. 	80° CN□□ CCLNR/L C024		55° DNGD CDNNN C070		35° VNGD CVVNN C074
		80° CN□□ 80° CN□□ PCLNR/L PCMNN C018, C019, C021, C022, C023, G057 C140		55° DN□□ PDJNR/L C040, C041, C046, C047, C048	35° VN□□ PVVNN C072	55° DN□□ PDPNN C077
P Lever lock	 <ul style="list-style-type: none"> Great repeatability of the cutting edge position with the two-face holding system. Excellent performance on NC lathes and special-purpose machines. There are many types of geometries available such as rhombus, triangle, square and round. Economical downsized type is also available. 	80° CN□□ 80° WN□□ PCL2NR PWLNR/L G057 C031, C032, C038	60° TN□□ PTJNR/L C054	55° DN□□ PDMNL C141		
		70° GN□□ 70° GN□□ 35° VN□□ PCLNR/L PCMNN PVJNR/L C021, C022, C023, G057 C140 C058, C063, C064	25° YNMG PVJNR/L C063, C064			
		70° GN□□ 60° TN□□ PCL2NR PTL2NR/L G057 C029				
H Retract pin	 <ul style="list-style-type: none"> Toolholder for super heavy cutting 					
JT Back clamp	 <ul style="list-style-type: none"> Tool holder with access on both sides to allow for insert changes in set ups with limited clearances such as gang tooling. Inserts can be clamped with screws from the back side of the tool, providing good usability. Shank sizes are available in 8, 10, 12, 16 mm. 	60° TN□□ JTTLNR/L C030			60° TN□□ JTANR/L C079	

Please see the page C*** for the product details.

Turning		Turning / Chamfering		Turning / Facing Chamfering		Facing		Profiling		External profiling					
G 91°		B-R 75°		D 45°		S 45°		K 75°		F 91°		Q*1 · H*1 45°		Special	
						90° SNGD CSSNR/L C114									
						90° HNGD CHSNR/L C111									
60° TN□□ PTG NR/L C090, C092, C093		90° SN□□ PSB NR/L C099		90° SN□□ PSD NN C108		90° SN□□ PSS NR/L C113		90° SN□□ PSK NR/L C117		60° TN□□ PTF NR/L C121, C123		55° DN□□ PDQ NR/L C127		- RNMG PRG NR/L C085	
		100° CN□□ PCB NR/L C096								80° CN□□ PCF NR/L C119		35° VN□□ PVQ NR/L C131, C133		25° YNMG PVQ NR/L C133	
		90° SNMM HSR NR/L C101													

*1: Symbol used exclusively by Tungaloy

External Toolholder - Quick Guide (Positive type)

Name	Appearance/Feature	Turning / Facing	External profiling				Turning
		L 95°	J 93°	N 72.5°	N 62.5°	A 91°	
X Double clamp <small>(screw-on)</small>	 <ul style="list-style-type: none"> • Super high feed machining increases productivity by 8 times. • The insert is secured by double clamping system with clamp + clamp screw. Both the insert and the tool body achieve high rigidity. 						
P Lever lock	 <ul style="list-style-type: none"> • Clamping positive round insert with lever lock leads to good indexing accuracy. • Can be used for external turning, facing, and profiling. High-feed machining is possible. • Insert diameters: $\phi 10$, $\phi 12$, $\phi 16$, $\phi 20$, $\phi 25$ mm. 	80°  WXGU JPWL2XR/L C035	55°  DXGU JPDJ2XR/L C044				
			35°  VXGU JPVJ2XR/L C060				
J Screw-on	 <ul style="list-style-type: none"> • Suitable for machining complex small parts on small NC lathes. A great variety of cutting edge geometries. • The screw-on method firmly holds the small positive inserts. The clamp screw is a reliable and durable Torx® screw. • J type is high-precision shank with 4 faces ground. 	80°  CC□□ JSCLCR/L C026, G029 JSCL2CR/L*2 G027, G028	55°  DC□□ JSDJCR-F C052, G038 JSDJ2CR/L*2 C050, G036, G037	35°  VB□□ JSVJBR/L G046 JSVJ2BR/L C066, C067, G044, G045	35°  VB□□ JSVNB G049	55°  DC□□ JSDNCN G047	60°  TC□□ JSTACR/L C080, G051
		80°  WXGU JSWLXR/L C034 JSWL2XR/L C034, C035, G023, G025 JSWLXR-F C036, G026	55°  DXGU JSDJXR/L C042 JSDJ2XR/L C042, C043, G031, G033 JSDJXR-F C045, G034	35°  VXGU JSVJXR/L C059 JSVJ2XR/L C059, C060, G040, G041 JSVJXR-F C061, G042		55°  DC□□ JSDN3CR/L*3 G048	35°  VB□□ JSVABR/L G052

*2: L2 and J2: without offset *3 

Please see the page C*** for the product details.

	Turning	Turning / Facing	Facing	Profiling	External profiling Special	Back turning	Front turning Reverse turning
	G 91° 	X 20° 	F 91° 	P 117.5° 			
		80° WPMT XWXPR/L C104					
					- RCM□ PRGCR/L C087 - RCM□ PRDCN C105		
	80° CC□□ JSCGCR/L G053		55° DC□□ JSDFCR/L G055	25° VP□□ JSVP2PR/L G050		JXB JSXBR/L G067 JTB JSTBR/L G061 JTB JS□□K-TBL G061 J10E JSEGR/L G064	JX□□ JSXGR/L G056 55° DC□□ JS□□K-SDUCL G039 55° DXGU JS□□□-SDUXL C137, G035 35° VXGU JS□□□-SVUXL C138, G042

Grade
Insert
Ext. Toolholder
Int. Toolholder
Threading
Grooving
Miniature Tool
Milling Cutter
Endmill
Drilling Tool
Tooling System
User's Guide
Index



External Toolholder - Quick Guide (Positive type)

Name	Appearance/Feature	Turning / Facing	External profiling			Turning	Turning / Chamfering
		L 95°	J 93°	V 72.5°	N 62.5°	A 91°	D 45°
S Screw-on <ul style="list-style-type: none"> • Suitable for machining complex small parts on small NC lathes. A great variety of cutting edge geometries. • The screw-on method firmly holds the small positive inserts. The clamp screw is a reliable and durable Torx® screw. 		80° CC□□ SCLCR/L C028	55° DC□□ SDJCR/L C053 35° VC□□ SVJCR/L C068 25° YWMT SYJBR/L C069	35° VC□□ SVJCR/L C068 25° YWMT SYJBR/L C069	55° DC□□ SDNCR/L C071	60° TC□□ STACR/L C081	90° SC□□ SSDCN C110 90° SP□□ SSDPN <small>Tungaloy standard</small> C110
		JT Back clamp <ul style="list-style-type: none"> • Tool holder with access on both sides to allow for insert changes in set ups with limited clearances such as gang tooling. • Inserts can be clamped with screws from the back side of the tool, providing good usability. • Shank sizes are available in 0.315", 0.394", 0.472", 0.630" (8, 10, 12, 16 mm). 		80° CC□□ JTCL2CR/L C027, G028	55° DC□□ JTDJ2CR/L C051, G036		

Please see the page C*** for the product details.

	Profiling			External profiling	Back turning	Front turning Reverse turning
	Q*145° · H*17.5° 	H 100° 	I 76.5° 	Special 		
	35° VCG□□ SVQCR/L C134 35° VCG□ SVHCR/L C135	55° DC□□ SDQCR/L C129 25° YWMT SYQBR/L C136	25° YWMT SYHBR/L C136 25° YWMT SYIBN C139	- RCMT SRACR/L C078 - RCMT SRGCR/L C088, C089 - RCMT SRDCN C106, C107	Note: JSXBR/L can be used with JXT threading insert.	Note: JSXGR/L can be used with JXG grooving insert.

*1: Symbol used exclusively by Tungaloy

TURN^{EN}FEED



Economical, 10-cornered insert ensures high machining efficiency

- Available in 2 types of holders: HD type for large depths of cut and HF type for high feed turning
- Maximum 0.276" depth of cut, or maximum 0.079" feed per rev is attainable!

Economical 10-cornered, double-sided, M-class insert

Achieves outstanding cost efficiency over standard ISO inserts.

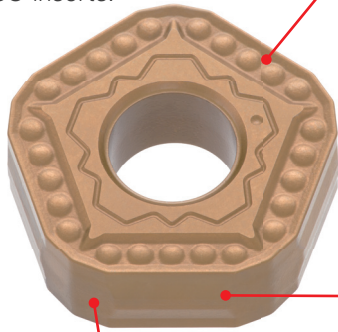

Flat Wiper

Built in the cutting edge to achieve superior machining surface at higher feed rates!

New – MNW style chipbreaker

Features protrusions on the rake face to facilitate smooth chip control, while achieving high crater wear resistance.

Dovetail clamping

Ensures secure insert retention while promoting smooth chip flow thanks to the integration of lever lock and dovetail clamping methods.

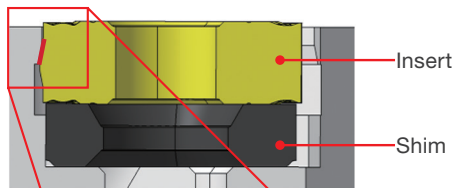

Insert

Shim

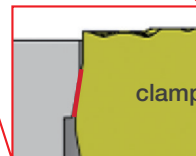

clamp contact cross section

Holder selections

Available in 2 types:

- HD holder for large depths of cut
 - HF holder for high feed turning
- Inserts are interchangeable between these two holders.

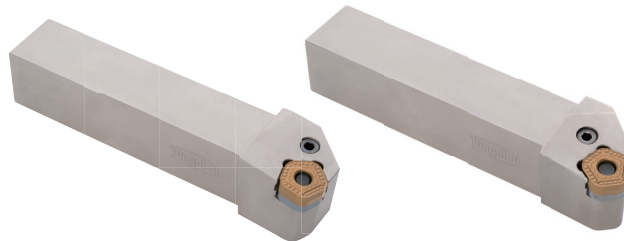

Features of Holders

HD holder
For **H**igh **D**ePTH of Cut

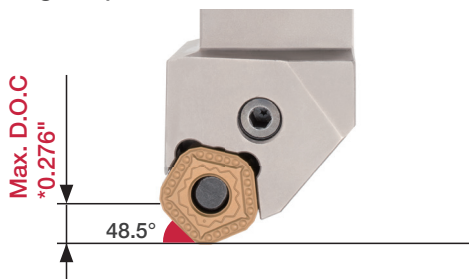

Max. D.O.C
*0.276"

48.5°

HF holder
For **H**igh **F**eed

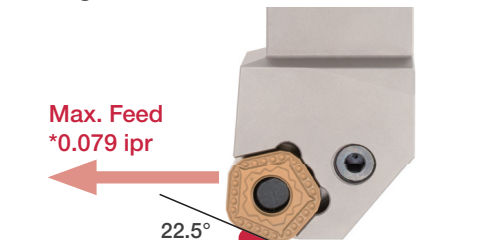

Max. Feed
*0.079 ipr

22.5°

* Insert: POMG130612-MNW

Reference pages: **C102**



ISO-EcoTurn Small size inserts, for an economical advantage

Uncompromising insert performance

Comparison of ISO-EcoTurn and regular size inserts

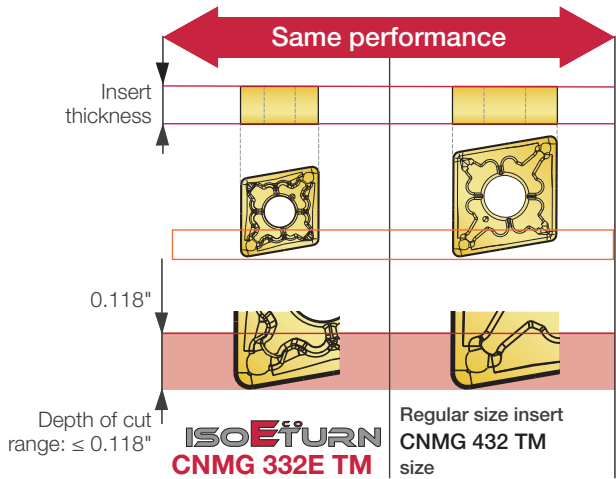

ISO-EcoTurn inserts feature the identical thickness and chipbreaker geometry as Tungaloy's regular size inserts. These properties provide cutting performance equal to that of the regular size inserts, including chip control at a depth of cut up to 0.118".

Chip control

ISO-EcoTurn inserts incorporate an identical chipbreaker geometry as regular size inserts providing the same chip removal at a depth of cut up to 0.118".

ISO ^{Eco} TURN CNMG 332E TM						
Depth of cut (in)	0.118					
	0.079					
	0.059					
	0.039					
	0.020					
Condition	0.004	0.006	0.008	0.012	0.016	
		Feed (ipr)				

Regular size CNMG 432 TM						
Depth of cut (in)	0.118					
	0.079					
	0.059					
	0.039					
	0.020					
Condition	0.004	0.006	0.008	0.012	0.016	
		Feed (ipr)				

Workpiece : 1045
Cutting speed : Vc = 660 sfm
Coolant : Wet

Double-clamp toolholder with 95° approach angle, for negative 80° rhombic inserts

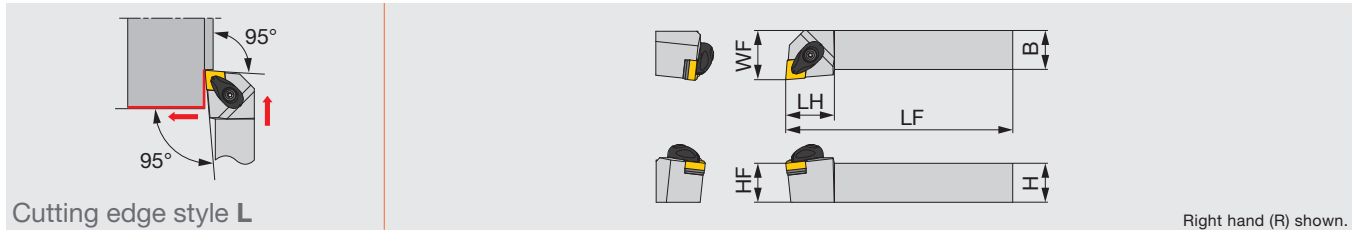

Inch	H	B	LF	LH	HF	WF	RE**	Insert	Torque
ACLNR/L1233-A	0.750	0.750	4.500	0.900	0.750	1.000	0.031	CN**33...	2.2
ACLNR/L1633-A	1.000	1.000	6.000	1.000	1.000	1.250	0.031	CN**33...	2.2

Metric	H	B	LF	LH	HF	WF	RE**	Insert	Torque*
ACLNR/L2020K0904-A	20	20	125	25	20	25	0.8	CN**0904...	3
ACLNR/L2525M0904-A	25	25	150	25	25	32	0.8	CN**0904...	3

Torque: Recommended clamping torque: lbs-ft (*N-m)
 **RE: Standard corner radius

SPARE PARTS							
Designation	Clamp	Clamp screw	Spring	Spring pin	Shim	Shim screw	Wrench
ACLNR/L**-A	ACP3S-E	ACS-5W	BP-7	SP-2.5	ASC322	CSTB-3.5	T-15F

Lever-lock toolholder with 95° approach angle, for negative 80° rhombic inserts, with high pressure coolant capability

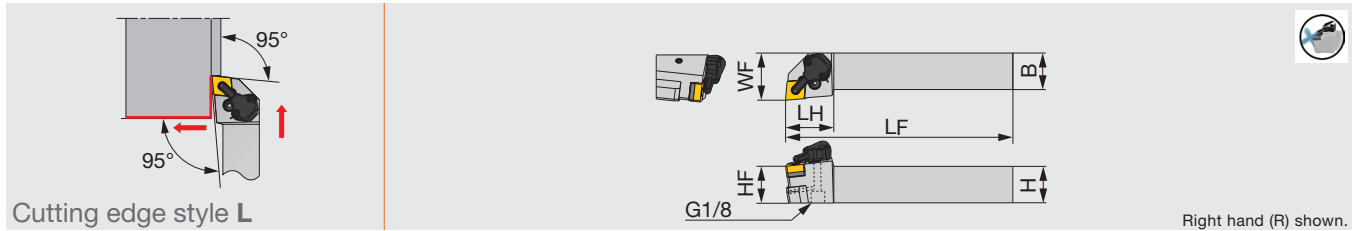

Inch	H	B	LF	LH	HF	WF	RE**	Insert	Torque
PCLNR/L1233-CHP	0.750	0.750	4.500	1.300	0.750	1.250	0.031	CN**33...	1.5
PCLNR/L1633-CHP	1.000	1.000	6.000	0.813	1.000	1.250	0.031	CN**33...	1.5

Metric	H	B	LF	LH	HF	WF	RE**	Insert	Torque*
PCLNR/L2020K0904-CHP	20	20	125	33	20	32	0.8	CN**0904...	2
PCLNR/L2525M0904-CHP	25	25	150	33	25	32	0.8	CN**0904...	2

Torque: Recommended clamping torque: lbs-ft (*N-m)
 **RE: Standard corner radius

SPARE PARTS					
Designation	Shim	Clamping screw	Wrench1	Spring pin	Lever
PCLNR/L**-CHP	LSC317	LCS3	P-2.5	LSP3	LCL33

SPARE PARTS						
Designation	Coolant unit	Mounting screw	Wrench2	O-ring	Coolant screw	Wrench3
PCLNR/L**-CHP	CU-CW-CHP	SRM3	T-8F	OR6.4X0.9N	SRM4X4TL360	P-2

Reference pages: ACLNR/L-Eco, PCLNR/L-CHP-Eco: Inserts → **B056** -
 Parts for coolant hose → **C142**

Lever-lock toolholder with 95° approach angle, for negative 80° rhombic inserts

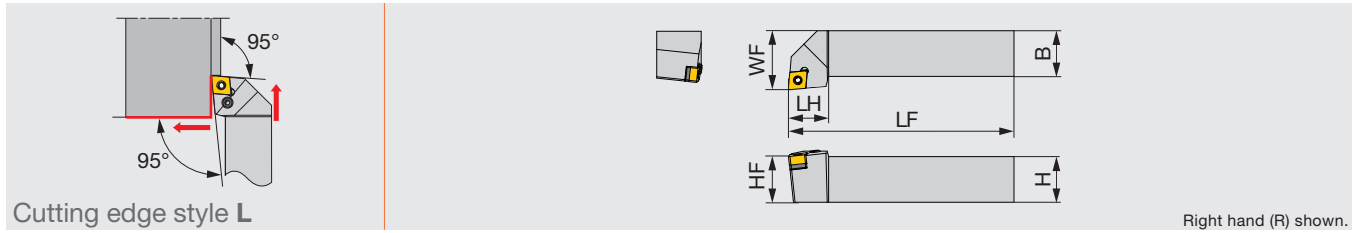

Inch	H	B	LF	LH	HF	WF	RE**	Insert	Torque
PCLNR/L1233	0.750	0.750	4.500	0.813	0.750	1.000	0.031	CN**33...	1.5
PCLNR/L1633	1.000	1.000	6.000	0.813	1.000	1.250	0.031	CN**33...	1.5
Metric	H	B	LF	LH	HF	WF	RE**	Insert	Torque*
PCLNR/L2020K0904	20	20	125	20	20	25	0.8	CN**0904...	2
PCLNR/L2525M0904	25	25	150	25	25	32	0.8	CN**0904...	2

Torque: Recommended clamping torque: lbs-ft (**N·m)
 **RE: Standard corner radius

SPARE PARTS					
Designation	Shim	Clamping screw	Wrench	Spring pin	Lever
PCLNR/L...	LSC317	LCS3	P-2.5	LSP3	LCL33

INSERT SELECTION

P	Application	Finishing	Medium cutting	M	Application	Finishing	Medium cutting				
	Grade	T9215	T9215		Grade	T6120	T6130				
	Chipbreaker shape				Chipbreaker shape						
Cutting conditions				B008				B010			
K	Application	Medium cutting			S	Application	Medium cutting				
	Grade	T515				Grade	AH8015				
	Chipbreaker shape					Chipbreaker shape					
Cutting conditions			B012		Cutting conditions			B016			

Reference pages: PCLNR/L-Eco: Inserts → **B056** -

- Grade **A**
- Insert **B**
- Toolholder **C**
- Ext. Toolholder **D**
- Int. Toolholder **E**
- Threading **F**
- Grooving **G**
- Milling Cutter **H**
- Miniature Tool **I**
- Endmill **J**
- Drilling Tool **K**
- System **L**
- User's Guide **M**
- Index **M**

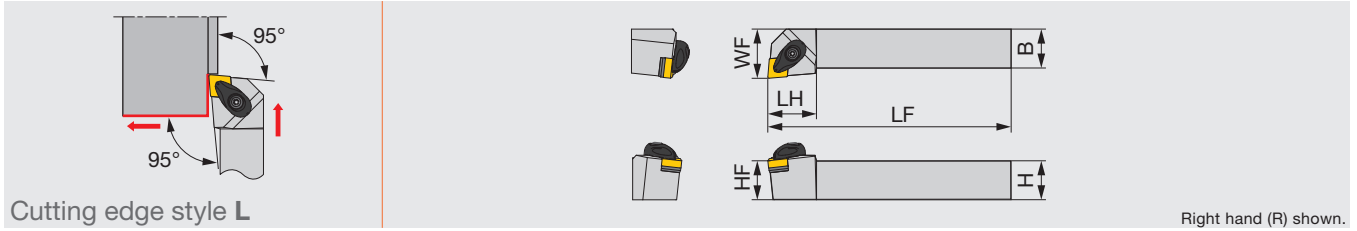

Right hand (R) shown.

Inch	H	B	LF	LH	HF	WF	RE**	Insert	Torque
ACLNR/L124-A	0.750	0.750	4.500	1.000	0.750	1.000	0.031	CN**43...	2.2
ACLNR/L164-A	1.000	1.000	6.000	1.250	1.000	1.250	0.031	CN**43...	2.2
ACLNR/L204-A	1.250	1.250	7.000	1.500	1.250	1.500	0.031	CN**43...	2.2
ACLNR/L205-A	1.250	1.250	7.000	1.500	1.250	1.500	0.047	CN**54...	4.7
ACLNR/L245-A	1.500	1.500	8.000	1.500	1.500	1.750	0.047	CN**54...	4.7
ACLNR/L206-A	1.250	1.250	7.000	1.500	1.250	1.500	0.047	CN**64...	4.7
ACLNR/L246-A	1.500	1.500	8.000	1.500	1.500	1.750	0.047	CN**64...	4.7
Metric	H	B	LF	LH	HF	WF	RE**	Insert	Torque*
ACLNR/L2020H12-A	20	20	120	26	20	25	0.8	CN**1204...	3
ACLNR/L2020K12-A	20	20	125	26	20	25	0.8	CN**1204...	3
ACLNR/L2525K12-A	25	25	125	30	25	32	0.8	CN**1204...	3
ACLNR/L2525M12-A	25	25	150	30	25	32	0.8	CN**1204...	3
ACLNR/L3225P12-A	32	25	170	30	32	32	0.8	CN**1204...	3
ACLNR/L2525M16-A	25	25	150	31	25	32	1.2	CN**1606...	6.4
ACLNR/L3225P16-A	32	25	170	31	32	32	1.2	CN**1606...	6.4
ACLNR/L3232P16-A	32	32	170	31	32	40	1.2	CN**1606...	6.4
ACLNR/L3232P19-A	32	32	170	40	32	40	1.2	CN**1906...	6.4
ACLNR/L4040S19-A	40	40	250	40	40	50	1.2	CN**1906...	6.4

Torque: Recommended clamping torque: lbs-ft (*N·m)

**RE: Standard corner radius

SPARE PARTS

Designation	Clamp	Clamp screw	Spring	Spring pin	Shim	Shim screw	Wrench1	Wrench2
ACLNR/L**4-A, ACLNR/L**12-A	ACP4S	ACS-5W	BP-7	SP-2.5	ASC422	CSTB-3.5	T-15F	-
ACLNR/L**5-A, ACLNR/L**16-A	ACP5S	ACS-6W	BP-8.8	SP-2.5	ASC533	CSTB-5	-	KEYV-T20
ACLNR/L**6-A, ACLNR/L**19-A	ACP6S	ACS-6W	BP-8.8	SP-2.5	ASC634	CSTB-5	-	KEYV-T20

Lever-lock toolholder, for negative 80° rhombic inserts, with high pressure coolant capability

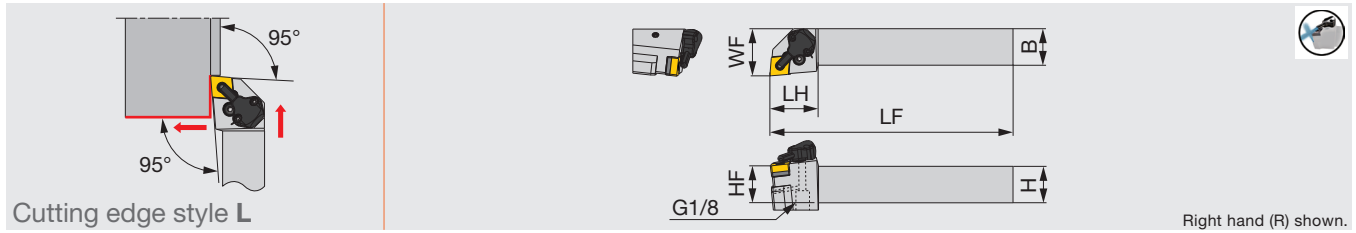

Inch	H	B	LF	LH	HF	WF	RE**	Insert	Torque
PCLNR/L124-CHP	0.750	0.750	4.500	1.300	0.750	1.250	0.031	CN**43...	2.2
PCLNR/L164-CHP	1.000	1.000	6.000	1.300	1.000	1.250	0.031	CN**43...	2.2

Metric	H	B	LF	LH	HF	WF	RE**	Insert	Torque*
PCLNR/L2020K12-CHP	20	20	125	33	20	32	0.8	CN/GN**1204...	3
PCLNR/L2525M12-CHP	25	25	150	33	25	32	0.8	CN/GN**1204...	3

Torque: Recommended clamping torque: lbs-ft (*N-m)
 **RE: Standard corner radius

SPARE PARTS					
Designation	Shim	Clamping screw	Wrench1	Spring pin	Lever
PCLNR/L**-CHP	LSC42	LCS4	P-3	LSP4	LCL4

SPARE PARTS						
Designation	Coolant unit	Mounting screw	Wrench2	O-ring	Coolant screw	Wrench3
PCLNR/L**-CHP	CU-CW-CHP	SRM3	T-8F	OR6.4X0.9N	SRM4X4TL360	P-2

INSERT SELECTION

P	Application	Precision finishing	Finishing	Medium cutting	Medium to heavy cutting
	Grade	NS9530	GT9530	T9215	T9215
Chipbreaker shape	TF	TSF	TM	TH	
Cutting conditions	B008				

M	Application	Finishing	Medium cutting	Medium to heavy cutting
	Grade	T6120	T6130	T6130
Chipbreaker shape	SF	SM	SH	
Cutting conditions	B010			

K	Application	Finishing	Medium cutting	Medium to heavy cutting
	Grade	T515	T515	T515
Chipbreaker shape	All-round	All-round	All-round	
Cutting conditions	B012			

N	Application	Precision finishing	Finishing	Medium cutting
	Grade	DX120	DX140	TH10
Chipbreaker shape	T-DIA	with rake T-DIA	P	
Cutting conditions	B014			

S	Application	Precision finishing	Finishing	Medium cutting
	Grade	BX470	AH8005	AH8005
Chipbreaker shape	T-CBN	HRF	HRM	
Cutting conditions	B016			

H	Application	Precision finishing	Finishing
	Grade	BXM10	BXM20
Chipbreaker shape	T-CBN	T-CBN	
Cutting conditions	B018		

Reference pages: PCLNR/L-CHP: Inserts → **B056** -, CBN → **B172** -, PCD → **B194** -
 Parts for coolant hose → **C142**

PCLNR/L

Lever-lock toolholder with 95° approach angle, for negative 80° rhombic inserts

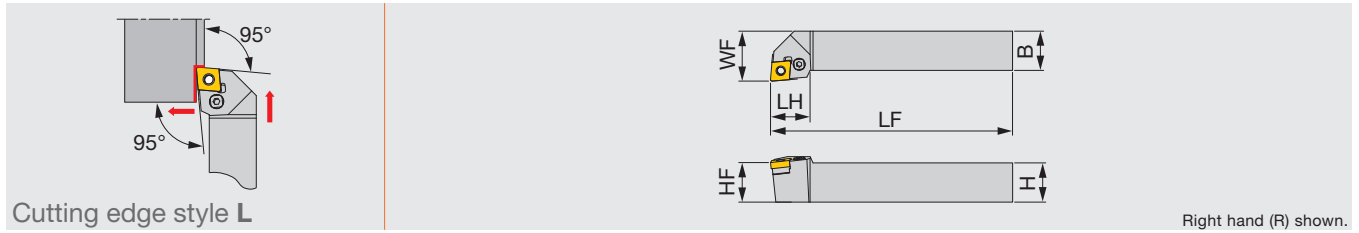

Metric	H	B	LF	LH	HF	WF	RE**	Insert
PCLNR/L1616H09	16	16	100	20	16	20	0.8	CN**0903...
PCLNR/L2020K09	20	20	125	20	20	25	0.8	CN**0903...
PCLNR/L2525M09	25	25	150	20	25	32	0.8	CN**0903...
PCLNR/L1616	16	16	100	26	16	20	0.8	CN/GN**1204...
PCLNR/L2020	20	20	125	28	20	25	0.8	CN/GN**1204...
PCLNR/L2525M4	25	25	150	28	25	32	0.8	CN/GN**1204...
PCLNR/L3225P4	32	25	170	28	32	32	0.8	CN/GN**1204...
PCLNR/L3232	32	32	170	40	32	40	1.2	CN**1906...
PCLNR/L1616H12E	16	16	100	26	16	20	0.8	CN/GN**1204...
PCLNR/L2020K12E	20	20	125	28	20	25	0.8	CN/GN**1204...
PCLNR/L2525M12E	25	25	150	28	25	32	0.8	CN/GN**1204...
PCLNR/L3225P12E	32	25	170	28	32	32	0.8	CN/GN**1204...
PCLNR/L2525M16E	25	25	150	31	25	25	1.2	CN**1606...
PCLNR/L3225P16E	32	25	150	31	32	32	1.2	CN**1606...
PCLNR/L3232P16E	32	32	170	31	32	40	1.2	CN**1606...
PCLNR/L3232P19E	32	32	170	40	32	40	1.2	CN**1906...

**RE: Standard corner radius

SPARE PARTS					
Designation	Shim	Clamping screw	Wrench	Spring pin	Lever
PCLNR/L1616H09	ELSC32	LCS3	P-2.5	LSP3L	LCL33
PCLNR/L2020K09	ELSC32	LCS3	P-2.5	LSP3L	LCL33
PCLNR/L2525M09	ELSC32	LCS3	P-2.5	LSP3L	LCL33
PCLNR/L1616	LSC42	LCS4CA	P-3	LSP4	LCL4
PCLNR/L2020	LSC42	LCS4	P-3	LSP4	LCL4
PCLNR/L2525M4	LSC42	LCS4	P-3	LSP4	LCL4
PCLNR/L3225P4	LSC42	LCS4	P-3	LSP4	LCL4
PCLNR/L3232	LSC63	LCS6	P-4	LSP6	LCL6
PCLNR/L1616H12E	ELSC42	LCS4CA	P-3	LSP4S	LCL43S
PCLNR/L2020K12E	ELSC42	LCS4	P-3	LSP4S	LCL43M
PCLNR/L2525M12E	ELSC42	LCS4	P-3	LSP4S	LCL43M
PCLNR/L3225P12E	ELSC42	LCS4	P-3	LSP4S	LCL43M
PCLNR/L2525M16E	ELSC53	LCS5	P-3	LSP6C	LCL54
PCLNR/L3225P16E	ELSC53	LCS5	P-3	LSP6C	LCL54
PCLNR/L3232P16E	ELSC53	LCS5	P-3	LSP6C	LCL54
PCLNR/L3232P19E	ELSC63	LCS6	P-4	LSP6	LCL6

Reference pages: PCLNR/L: Inserts → B056 -, CBN → B172 -, PCD → B194 -

Lever-lock toolholder with TungCap connection, for negative 80° rhombic inserts, with high pressure coolant capability

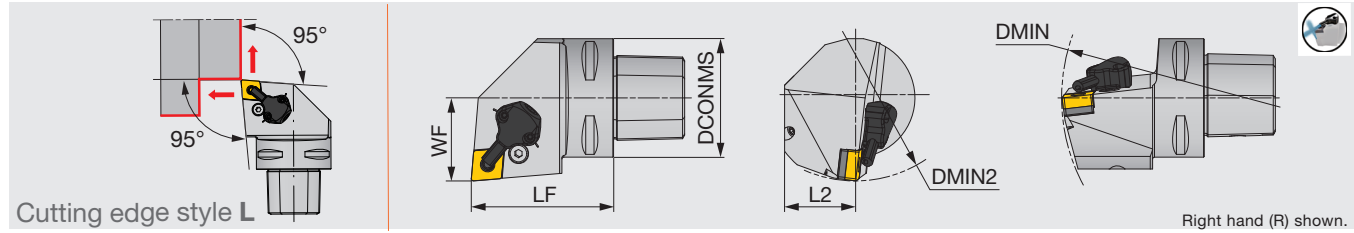

Inch	DCONMS	LF	L2	WF	DMIN	DMIN2	RE**	Insert
C4PCLNR/L27050-0904-CHP	1.575	1.969	0.984	1.063	5.512	4.331	0.031	CN**33...
C4PCLNR/L27050-12-CHP	1.575	1.969	0.984	1.063	5.512	4.331	0.031	CN**43...
C5PCLNR/L35060-12-CHP	1.969	2.362	1.260	1.378	6.496	4.331	0.031	CN**43...
C6PCLNR/L45065-0904-CHP	2.480	2.559	1.614	1.772	7.480	4.921	0.031	CN**33...
C6PCLNR/L45065-12-CHP	2.480	2.559	1.614	1.772	7.480	4.921	0.031	CN**43...

Metric	DCONMS	LF	L2	WF	DMIN	DMIN2	RE**	Insert
C4PCLNR/L27050-0904-CHP	40	50	25	27	140	110	0.8	CN**0904...
C4PCLNR/L27050-12-CHP	40	50	25	27	140	110	0.8	CN/GN**1204...
C5PCLNR/L35060-12-CHP	50	60	32	35	165	110	0.8	CN/GN**1204...
C6PCLNR/L45065-0904-CHP	63	65	41	45	190	125	0.8	CN**0904...
C6PCLNR/L45065-12-CHP	63	65	41	45	190	125	0.8	CN/GN**1204...

**RE: Standard corner radius

SPARE PARTS

Designation	Shim	Clamping screw	Wrench 1	Spring pin	Lever
C*PCLNR/L*-0904-CHP	LSC317	LCS3	P-2.5	LSP3	LCL33
C*PCLNR**-12-CHP	LSC42	LCS4	P-3	LSP4	LCL4

SPARE PARTS

Designation	Coolant unit	Coolant screw	Wrench 2	Wrench 3
C*PCLNR/L*-0904-CHP	CU-CW-CHP	SRM4X4TL360	T-8F	P-2
C*PCLNR**-12-CHP	CU-CW-CHP	SRM4X4TL360	T-8F	P-2

INSERT SELECTION

P	Application	Precision finishing	Finishing	Medium cutting	Medium to heavy cutting
	Grade	NS9530	GT9530	T9215	T9215
	Chipbreaker shape	TF	TSF	TM	TH
Cutting conditions: B008					
M	Application	Finishing	Medium cutting	Medium to heavy cutting	
	Grade	T6120	T6130	T6130	
	Chipbreaker shape	SF	SM	SH	
Cutting conditions: B010					
K	Application	Finishing	Medium cutting	Medium to heavy cutting	
	Grade	T515	T515	T515	
	Chipbreaker shape	All-round	All-round	All-round	
Cutting conditions: B012					
N	Application	Precision finishing	Finishing	Medium cutting	
	Grade	DX120	DX140	TH10	
	Chipbreaker shape	T-DIA	with rake T-DIA	P	
Cutting conditions: B014					
S	Application	Precision finishing	Finishing	Medium cutting	
	Grade	BX470	AH8005	AH8005	
	Chipbreaker shape	T-CBN	HRF	HRM	
Cutting conditions: B016					
H	Application	Precision finishing	Finishing		
	Grade	BXM10	BXM20		
	Chipbreaker shape	T-CBN	T-CBN		
Cutting conditions: B018					

Reference pages: C-PCLNR/L-CHP: Inserts → **B056 -**, CBN → **B172 -**, PCD → **B194 -**
Parts for coolant hose → **C142**

Double-clamp toolholder with 95° approach angle, for negative 80° rhombic ceramic inserts with dimple

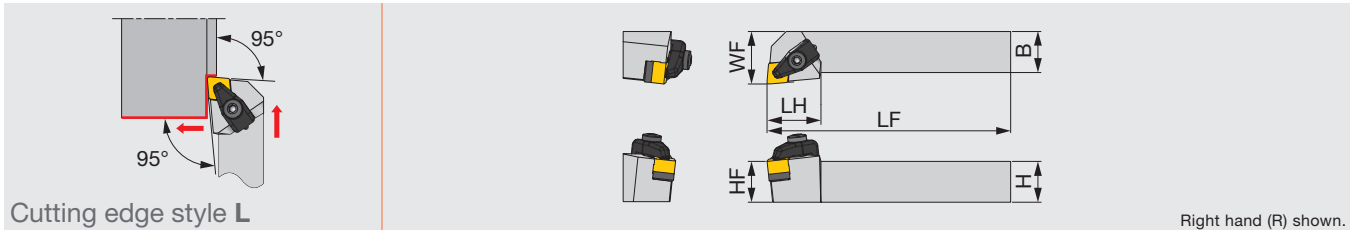

Right hand (R) shown.

Inch	H	B	LF	LH	HF	WF	RE**	Insert	Torque
CCLNR/L16M45-RD	1.000	1.000	6.000	1.300	1.000	1.250	0.047	CNGD45...	3.0

Torque: Recommended clamping torque: lb-ft
 **RE: Standard corner radius

SPARE PARTS

Designation	Clamp	Clamp screw	Shim	Shim screw	Spring	Wrench1	Wrench2
CCLNR/L*-RD	CCP4-A	CCS4-A	CC44-A	BH5-10-A	BP-5-A	P-3	P-4

INSERT SELECTION

K	Application	Finishing to medium cutting
	Grade	FX105
	Chipbreaker shape	
	Cutting conditions	C144

Reference pages: CCLNR/L-RD: Inserts → **B066**,
 Standard cutting conditions → **C144**

DCLNR/L

"One-Double" toolholder with 95° approach angle, for negative 80° rhombic inserts

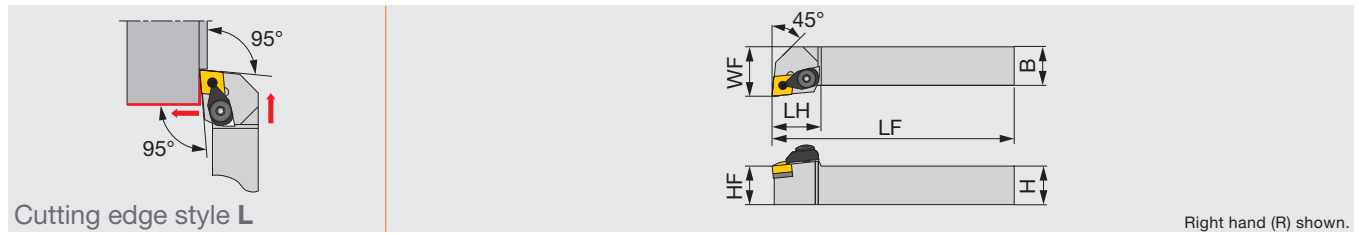

Metric	H	B	LF	LH	HF	WF	RE**	Insert
DCLNR/L2020K12	20	20	125	30	20	25	0.8	CN**1204...
DCLNR/L2525M12	25	25	150	30	25	32	0.8	CN**1204...
DCLNR/L3225P12	32	25	170	30	32	32	0.8	CN**1204...

Except for 57-type chipbreaker inserts
 **RE: Standard corner radius

SPARE PARTS									
Designation	Clamp	Lever	Piston	Clamp screw	Shim	Spring	Spring pin	Wrench1	Wrench2
DCLNR/L...	DCPM-43	DLCL43	DPIS43	DLCS43	LSC42	BP-10	LSP4	P-3	P-4

INSERT SELECTION

Application	Precision finishing	Finishing	Medium cutting	Medium to heavy cutting
	Grade	NS9530	GT9530	T9215
Chipbreaker shape	TF	TSF	TM	TH
Cutting conditions	B008			

Application	Finishing	Medium cutting	Medium to heavy cutting
	Grade	T6120	T6130
Chipbreaker shape	SF	SM	SH
Cutting conditions	B010		

Application	Finishing	Medium cutting	Medium to heavy cutting
	Grade	T515	T515
Chipbreaker shape	All-round	All-round	All-round
Cutting conditions	B012		

Application	Precision finishing	Finishing	Medium cutting
	Grade	DX120	DX140
Chipbreaker shape	T-DIA	with rake T-DIA	P
Cutting conditions	B014		

Application	Precision finishing	Finishing	Medium cutting
	Grade	BX480	AH8005
Chipbreaker shape	T-CBN	HRF	HRM
Cutting conditions	B016		

Application	Precision finishing	Finishing
	Grade	BXM10
Chipbreaker shape	T-CBN	T-CBN
Cutting conditions	B018	

Reference pages: DCLNR/L: Inserts → B056 -, CBN → B172 -, PCD → B194 -



Screw-on toolholder with 95° approach angle, for positive 80° rhombic inserts

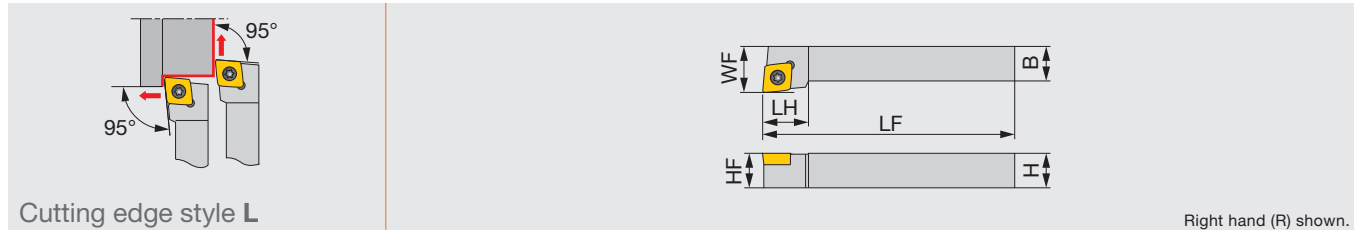

Metric	H	B	LF	LH	HF	WF	RE**	Insert	Torque
JSCLCR/L0808H06	8	8	100	12	8	10	0.4	CC**0602...	1.2
JSCLCR/L1010H06	10	10	100	12	10	12	0.4	CC**0602...	1.2
JSCLCR/L1212H09	12	12	100	16	12	16	0.8	CC**09T3...	1.2
JSCLCR/L1616H09	16	16	100	16	16	20	0.8	CC**09T3...	1.2

Torque: Recommended clamping torque: N·m
 **RE: Standard corner radius

SPARE PARTS

Designation	Clamping screw	Wrench
JSCLCR/L**H06	CSTB-2.5	T-8F
JSCLCR/L**H09	CSTB-4SD	T-8F

Screw-on toolholder without offset with 95° approach angle for positive 80° rhombic inserts

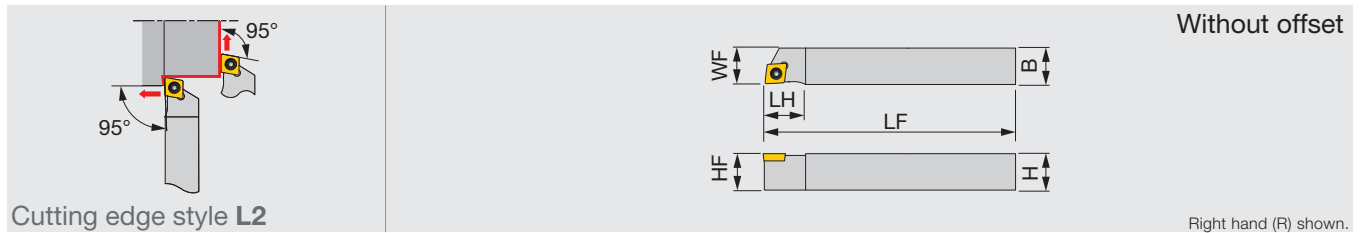

Inch	H	B	LF	LH	HF	WF	RE**	Insert	Torque
JSCL2CR/L062	0.375	0.375	5.000	0.400	0.375	0.375	0.016	CC**21.5...	0.89
JSCL2CR/L082	0.500	0.500	5.000	0.400	0.500	0.500	0.016	CC**21.5...	0.89
JSCL2CR/L103	0.625	0.625	5.000	0.680	0.625	0.625	0.031	CC**32.5...	0.89

Metric	H	B	LF	LH	HF	WF	RE**	Insert	Torque*
JSCL2CR/L1010X06	10	10	120	12	10	10	0.2	CC**0602...	1.2
JSCL2CR/L1212F06	12	12	85	12	12	12	0.2	CC**0602...	1.2
JSCL2CR/L1212X06	12	12	120	12	12	12	0.2	CC**0602...	1.2
JSCL2CR/L1212F09	12	12	85	16	12	12	0.2	CC**09T3...	1.2
JSCL2CR/L1212X09	12	12	120	16	12	12	0.2	CC**09T3...	1.2
JSCL2CR/L1616X09	16	16	120	16	16	16	0.2	CC**09T3...	1.2

Torque: Recommended clamping torque: lbs-ft (*N·m)
 **RE: Standard corner radius

SPARE PARTS

Designation	Clamping screw	Wrench
JSCL2CR/L062, JSCL2CR/L082, JSCL2CR/L**06	CSTB-2.5	T-8F
JSCL2CR/L103, JSCL2CR/L**09	CSTB-4SD	T-8F

Reference pages: JSCLCR/L, JSCL2CR/L: Inserts → **B111 -**, CBN → **B182 -**, PCD → **B196 -**

Back-clamp toolholder with 95° approach angle, for positive 80° rhombic inserts

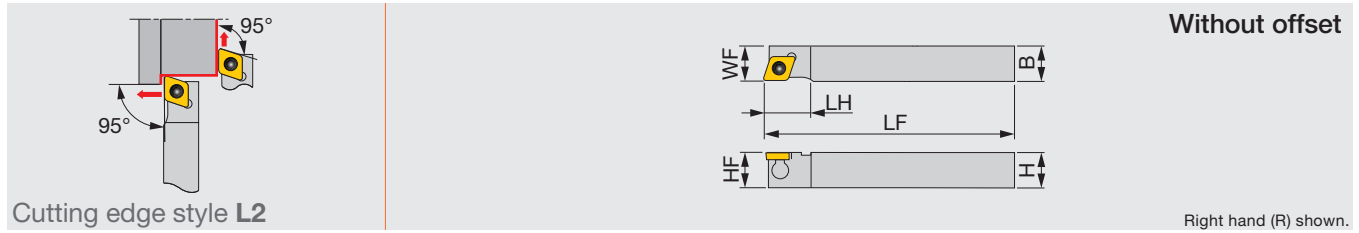

Cutting edge style **L2**

Metric	H	B	LF	LH	HF	WF	RE**	Insert	Torque
JTCL2CR/L1010X06	10	10	120	12	10	10	0.2	CC**0602...	0.9
JTCL2CR/L1212F09	12	12	85	16	12	12	0.2	CC**09T3...	1.2
JTCL2CR/L1212X09	12	12	120	16	12	12	0.2	CC**09T3...	1.2
JTCL2CR/L1616X09	16	16	120	16	16	16	0.2	CC**09T3...	1.2
JTCL2CR1616M09	16	16	150	16	16	16	0.8	CC**09T3...	1.2

Torque: Recommended clamping torque: N·m

**RE: Standard corner radius

SPARE PARTS

Designation	Clamp	Clamping screw	Wrench
JTCL2CR/L**06	JCP-2	JDS-3525	P-2F
JTCL2CR/L**09	JCP-3	JDS-5040	P-2.5F

INSERT SELECTION

Application	Precision finishing	Finishing	Finishing to medium cutting	Medium cutting
	SH725	SH725	T9215	T9215
Grade	01	JS	PS	PM
Chipbreaker shape				
Cutting conditions	B020			

Application	Precision finishing	Finishing	Finishing to medium cutting	Medium cutting
	SH725	SH725	T9215	T9215
Grade	01	JS	PS	PM
Chipbreaker shape				
Cutting conditions	B022			

Application	Finishing to medium cutting
	T515
Grade	CM
Chipbreaker shape	
Cutting conditions	B024

Application	Precision finishing	Finishing	Medium cutting
	DX120	TH10	KS05F
Grade	T-DIA	with rake W20	AL
Chipbreaker shape			
Cutting conditions	B026		

Application	Precision finishing	Finishing to medium cutting
	BX470	AH8005
Grade	T-CBN	PS
Chipbreaker shape		
Cutting conditions	B028	

Application	Precision finishing	Finishing
	BXM10	BXM20
Grade	T-CBN	T-CBN
Chipbreaker shape		
Cutting conditions	B030	

Reference pages: JTCL2CR/L: Inserts → **B111** -, CBN → **B182** -, PCD → **B196** -



SCLCR/L

Screw-on toolholder with 95° approach angle, for positive 80° rhombic inserts

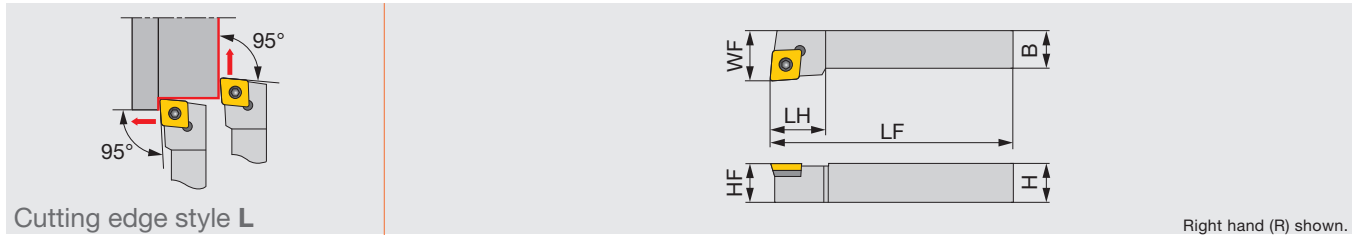

Right hand (R) shown.

Inch	H	B	LF	LH	HF	WF	RE**	Insert
SCLCR/L 103	0.625	0.625	4.000	0.625	0.625	0.750	0.031	CC**32.5...
SCLCR/L 123	0.750	0.750	4.500	0.625	0.750	0.750	0.031	CC**32.5...
SCLCR/L 163	1.000	1.000	6.000	0.625	1.000	0.750	0.031	CC**32.5...
SCLCR/L 124B	0.750	0.750	4.500	0.625	0.750	0.750	0.031	CC**43...
SCLCR/L 164D	1.000	1.000	6.000	0.750	1.000	0.750	0.031	CC**43...

Metric	H	B	LF	LH	HF	WF	RE**	Insert
SCLCR/L1616H09	16	16	100	16	16	20	0.8	CC**09T3...
SCLCR/L2020K12	20	20	125	20	20	25	0.8	CC**1204...

**RE: Standard corner radius

SPARE PARTS

Designation	Clamping screw	Shim screw	Shim	Wrench1	Wrench2
SCLCR/L103, 123, 163 SCLCR/L1616H09	CSTB-3.5L	DTS5-3.5	SSC32	P-3.5	T-15F
SCLCR/L124B, 164D	CSPB-5	DTS6-4	SSC4T3	P-4	T20F
SCLCR/L2020K12	CSTB-4F	DTS6-4	SSC4T3	P-4	T-15F

INSERT SELECTION

Application	Precision finishing	Finishing	Finishing to medium cutting	Medium cutting
Grade	NS9530	NS9530	T9215	T9215
Chipbreaker shape	01	PSS	PS	PM
Cutting conditions	B020			

Application	Precision finishing	Finishing	Finishing to medium cutting	Medium cutting
Grade	GH330	AH725	AH630	T6130
Chipbreaker shape	W**	PSF	PSS	PM
Cutting conditions	B022			

Application	Finishing to medium cutting
Grade	T515
Chipbreaker shape	CM
Cutting conditions	B024

Application	Precision finishing	Finishing	Medium cutting
Grade	DX120	DX140	KS05F
Chipbreaker shape	T-DIA	with rake T-DIA	AL
Cutting conditions	B026		

Application	Finishing	Finishing to medium cutting
Grade	AH8015	AH8015
Chipbreaker shape	PSS	PS
Cutting conditions	B028	

Application	Precision finishing	Finishing
Grade	BXM10	BXM20
Chipbreaker shape	T-CBN	T-CBN
Cutting conditions	B030	

Reference pages: SCLCR/L: Inserts → B111 -, CBN → B182 -, PCD → B196 -

PTL2NR/L

Lever-lock toolholder with 95° approach angle, for negative 60° triangular inserts

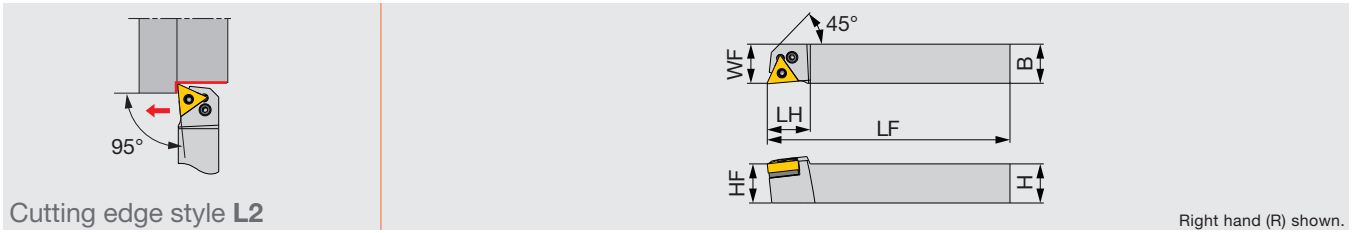

Metric	H	B	LF	LH	HF	WF	RE**	Insert	Torque
PTL2NR/L2020H16	20	20	100	22	20	20	0.4	TN**1604...	2

Torque: Recommended clamping torque: N·m
 **RE: Standard corner radius

SPARE PARTS

Designation	Shim	Clamping screw	Wrench	Spring pin	Lever
PTL2NR/L...	LST317 D30	LCS3	P-2.5	LSP3	LCL3

INSERT SELECTION

Application	Precision finishing	Finishing	Medium cutting	Medium to heavy cutting
Grade	NS9530	GT9530	T9215	T9215
Chipbreaker shape	TF	TSF	TM	TH
Cutting conditions	B008			

Application	Finishing	Medium cutting
Grade	T6120	T6130
Chipbreaker shape	SF	SM
Cutting conditions	B010	

Application	Finishing	Medium cutting	Medium to heavy cutting
Grade	T515	T515	T515
Chipbreaker shape	All-round	All-round	All-round
Cutting conditions	B012		

Application	Precision finishing	Finishing	Medium cutting
Grade	DX120	DX140	TH10
Chipbreaker shape	T-DIA	with rake T-DIA	P
Cutting conditions	B014		

Application	Precision finishing	Finishing	Medium cutting
Grade	BX470	AH8005	AH8005
Chipbreaker shape	T-CBN	HRF	HRM
Cutting conditions	B016		

Application	Precision finishing	Finishing
Grade	BXM10	BXM20
Chipbreaker shape	T-CBN	T-CBN
Cutting conditions	B018	

Reference pages: PTL2NR/L: Inserts → **B086 -**, CBN → **B178 -**, PCD → **B194 -**



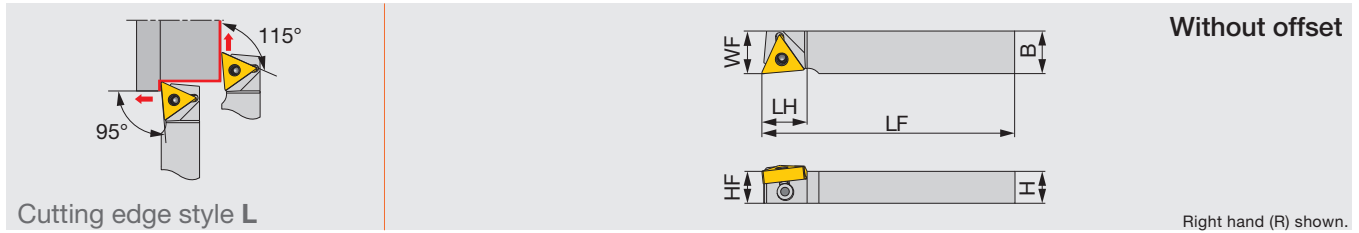

Metric	H	B	LF	LH	HF	WF	RE**	Insert	Torque
JTTLNR/L1216F16	12	16	85	17	12	16	0.4	TN**1604...	1
JTTLNR/L1216X16	12	16	120	17	12	16	0.4	TN**1604...	1
JTTLNR/L1616X16	16	16	120	17	16	16	0.4	TN**1604...	1

Torque: Recommended clamping torque: N·m
 **RE: Standard corner radius

SPARE PARTS

Designation	Clamp	Clamping screw	Wrench
JTTLNR/L...	JCP-3N	JDS-5040	P-2.5F

INSERT SELECTION

P	Application	Precision finishing	M	Application	Precision finishing	
	Grade	SH725		Grade	SH725	
	Chipbreaker shape	01		Chipbreaker shape	01	
	Cutting conditions	B008		Cutting conditions	B010	
K	Application	Finishing to medium cutting	N	Application	Precision finishing	
	Grade	T515		Grade	DX120	
	Chipbreaker shape	CM		Chipbreaker shape	T-DIA with rake	
	Cutting conditions	B012		Cutting conditions	B014	
S	Application	Precision finishing	H	Application	Precision finishing	Finishing
	Grade	BX470		Grade	BXM10	BXM20
	Chipbreaker shape	T-CBN		Chipbreaker shape	T-CBN	T-CBN
	Cutting conditions	B016		Cutting conditions	B018	

Reference pages: JTTLNR/L: Inserts → B086 -, CBN → B178 -, PCD → B194 -

Double-clamp toolholder with 95° approach angle, for negative 80° trigon inserts

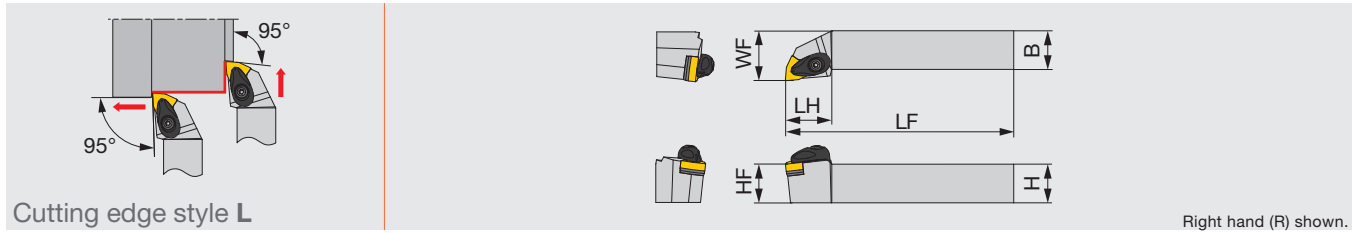

Inch		B	LF	LH	HF	WF	RE**	Insert	Torque
AWLNR/L1233-A	0.750	0.750	4.500	1.125	0.750	1.000	0.031	WN**33...	2.21
AWLNR/L1633-A	1.000	1.000	6.000	1.125	1.000	1.250	0.031	WN**33...	2.21

Metric		H	B	LF	LH	HF	WF	RE**	Insert	Torque*
AWLNR/L2020K0604-A	20	20	125	27	20	25	0.8	WN**0604...	3	
AWLNR/L2525M0604-A	25	25	150	27	25	32	0.8	WN**0604...	3	

Torque: Recommended clamping torque: lbs-ft (*N-m) **RE: Standard corner radius

SPARE PARTS							
Designation	Clamp	Clamp screw	Spring	Spring pin	Shim	Shim screw	Wrench
AWLNR/L**-A	ACP3S-E	ACS-5W	BP-7	SP-2.5	ASW322	CSTB-3.5	T-15F

Lever-lock toolholder with 95° approach angle, for negative 80° trigon inserts, with high pressure coolant capability

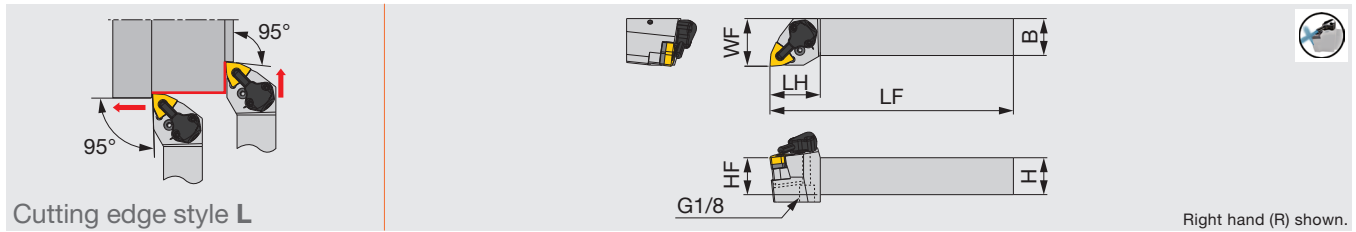

Inch		B	LF	LH	HF	WF	RE**	Insert	Torque
PWLNR/L1233-CHP	0.750	0.750	4.500	1.969	0.750	1.250	0.031	WN**33...	1.48
PWLNR/L1633-CHP	1.000	1.000	6.000	1.969	1.000	1.250	0.031	WN**33...	1.48

Metric		H	B	LF	LH	HF	WF	RE**	Insert	Torque*
PWLNR/L2020K0604-CHP	20	20	125	34	20	32	0.8	WN**0604...	2	
PWLNR/L2525M0604-CHP	25	25	150	34	25	32	0.8	WN**0604...	2	

Torque: Recommended clamping torque: lbs-ft (*N-m) **RE: Standard corner radius

SPARE PARTS					
Designation	Shim	Clamping screw	Wrench1	Spring pin	Lever
PWLNR/L**-CHP	LSW312	LCS3	P-2.5	LSP3	LCL3

SPARE PARTS						
Designation	Coolant unit	Mounting screw	Wrench2	O-ring	Coolant screw	Wrench3
PWLNR/L**-CHP	CU-CW-CHP	SRM3	T-8F	OR6.4X0.9N	SRM4X4TL360	P-2

INSERT SELECTION

P	Application	Finishing	Medium cutting	M	Application	Finishing	Medium cutting	K	Application	Medium cutting
	Grade	T9215	T9215		Grade	T6120	T6130		Grade	T515
Chipbreaker shape	TSF		TM		SS		SM		TM	
Cutting conditions	B008			Cutting conditions	B010			Cutting conditions	B012	

Reference pages: AWLNR/L-Eco, PWLNR/L-CHP: Inserts → **B102** -

Parts for coolant hose → **C142**

Lever-lock toolholder with 95° approach angle, for negative 80° trigon inserts

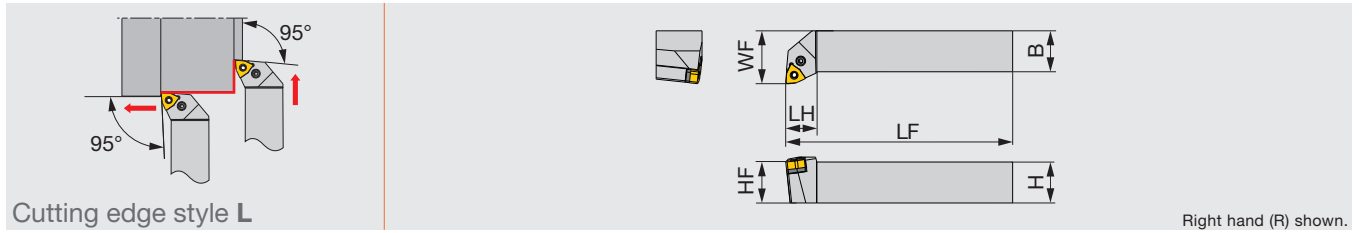

Right hand (R) shown.

Inch	H	B	LF	LH	HF	WF	RE**	Insert	Torque
PWLNR/L1233	0.750	0.750	4.500	0.625	0.750	1.000	0.031	WN**33...	1.48
PWLNR/L1633	1.000	1.000	6.000	0.719	1.000	1.250	0.031	WN**33...	1.48
Metric	H	B	LF	LH	HF	WF	RE**	Insert	Torque*
PWLNR/L2020K0604	20	20	125	15	20	25	0.8	WN**0604...	2
PWLNR/L2525M0604	25	25	150	19	25	32	0.8	WN**0604...	2

Torque: Recommended clamping torque: lbs-ft (*N-m) **RE: Standard corner radius

SPARE PARTS					
Designation	Shim	Clamping screw	Wrench	Spring pin	Lever
PWLNR/L...	LSW312	LCS3	P-2.5	LSP3	LCL3

INSERT SELECTION

P	Application	Finishing	Medium cutting
	Grade	T9215	T9215
Chipbreaker shape	TSF	TM	
Cutting conditions	B008		

M	Application	Finishing	Medium cutting
	Grade	T6120	T6130
Chipbreaker shape	SS	SM	
Cutting conditions	B010		

K	Application	Medium cutting
	Grade	T515
Chipbreaker shape	TM	
Cutting conditions	B012	

Reference pages: PWLNR/L-Eco: Inserts → **B102** -

Screw-on toolholder with 95° approach angle, for WXGU inserts

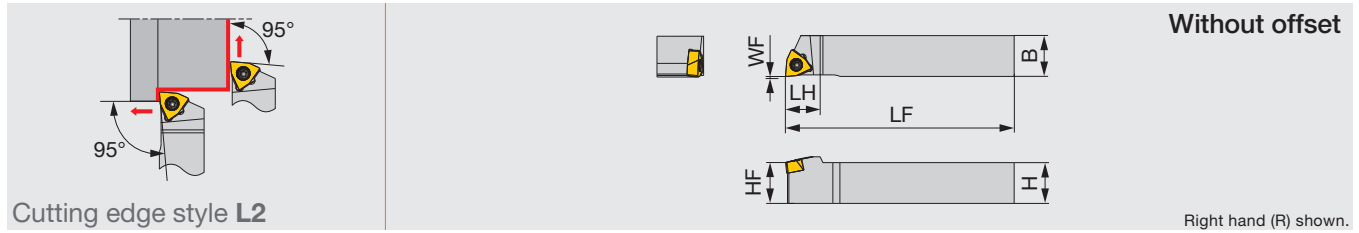

Inch	H	B	LF	LH	HF	WF	RE**	Insert	Torque
JSWL2XR/L062	0.375	0.375	4.750	0.500	0.375	0	0.008	WXGU0403**L/R...	0.66
JSWL2XR/L082	0.500	0.500	4.750	0.500	0.500	0	0.008	WXGU0403**L/R...	0.66
JSWL2XR/L102	0.625	0.625	4.750	0.500	0.625	0	0.008	WXGU0403**L/R...	0.66

Metric	H	B	LF	LH	HF	WF	RE**	Insert	Torque*
JSWL2XR/L1010X04	10	10	120	11	10	0	0.2	WXGU0403**L/R...	0.9
JSWL2XR/L1212F04	12	12	85	11	12	0	0.2	WXGU0403**L/R...	0.9
JSWL2XR/L1212X04	12	12	120	11	12	0	0.2	WXGU0403**L/R...	0.9
JSWL2XR/L1616X04	16	16	120	13	16	0	0.2	WXGU0403**L/R...	0.9
JSWL2XR/L2020H04	20	20	100	13	20	0	0.2	WXGU0403**L/R...	0.9

Torque: Recommended clamping torque: lbs-ft (*N·m) **RE: Standard corner radius
Use right-hand toolholders (R) with left-hand inserts (L); and left-hand toolholders (L) with right-hand inserts (R).

SPARE PARTS

Designation	Clamping screw	Wrench
JSWL2XR/L...	SR34-514	T-7F

INSERT SELECTION

Swiss lathes

P	Application	Finishing	Medium cutting	M	Application	Finishing	Medium cutting
	Grade	SH725	AH725		Grade	SH725	AH725
	JSS	JTS			JSS	JTS	
	Cutting conditions C143				Cutting conditions C143		

Small CNC lathes

P	Application	Finishing	Medium cutting	M	Application	Finishing	Medium cutting
	Grade	AH725	AH725		Grade	AH8015	AH8015
	SS	TS			SS	TS	
	Cutting conditions C143				Cutting conditions C143		

Reference pages: JSWL2XR/L: Inserts → **B161** -
Standard cutting conditions → **C143**



Lever-lock toolholder with 95° approach angle, for negative 80° trigon inserts

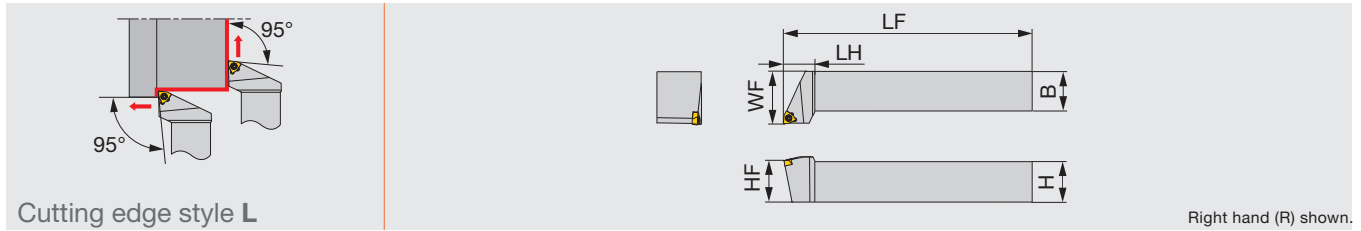

Right hand (R) shown.

Inch	H	B	LF	LH	HF	WF	RE**	Insert	Torque
JSWLXR/122	0.750	0.750	4.500	0.625	0.750	1.000	0.008	WXGU0403**L/R...	0.66
JSWLXR/162	1.000	1.000	6.000	0.750	1.000	1.250	0.008	WXGU0403**L/R...	0.66

Metric	H	B	LF	LH	HF	WF	RE**	Insert	Torque*
JSWLXR/L2020K04	20	20	125	15	20	25	0.4	WXGU0403**L/R...	0.9
JSWLXR/L2525M04	25	25	150	19	25	32	0.4	WXGU0403**L/R...	0.9

Torque: Recommended clamping torque: lbs-ft (*N-m) **RE: Standard corner radius
Use right-hand toolholders (R) with left-hand inserts (L); and left-hand toolholders (L) with right-hand inserts (R).

SPARE PARTS

Designation	Clamping screw	Wrench
JSWLXR/L...	SR34-514	T-7F

Screw-on toolholder with 95° approach angle, for WXGU inserts, with high pressure coolant capability

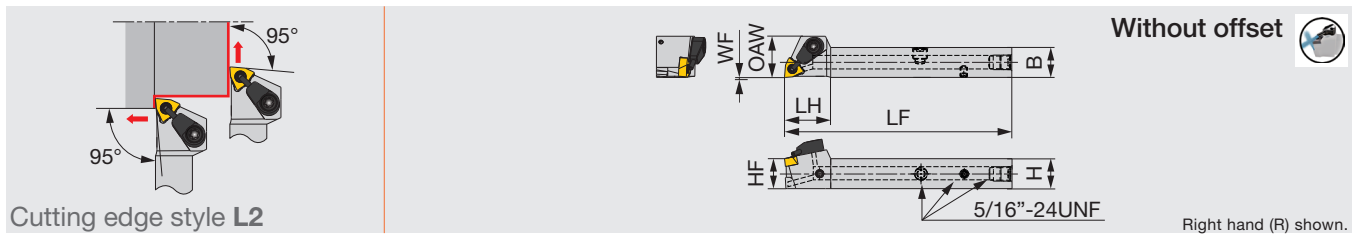

Right hand (R) shown.

Inch	H	B	LF	LH	HF	WF	OAW	RE**	Insert	Torque
JSWL2XR/L082-CHP	0.500	0.500	3.344	0.750	0.500	0	0.650	0.008	WXGU0403**L/R...	0.66
JSWL2XR082X-CHP	0.500	0.500	4.750	0.728	0.500	0	0.650	0.008	WXGU0403**L	0.66
JSWL2XR102X-CHP	0.625	0.625	4.750	0.728	0.625	0	0.650	0.008	WXGU0403**L	0.66

Metric	H	B	LF	LH	HF	WF	OAW	RE**	Insert	Torque*
JSWL2XR/L1212F04-CHP	12	12	85	18	12	0	16.5	0.2	WXGU0403**L/R...	0.9
JSWL2XR1212X04-CHP ⁽¹⁾	12	12	120	18.5	12	0	16.5	0.2	WXGU0403**L	0.9
JSWL2XR1616X04-CHP ⁽¹⁾	16	16	120	18.5	16	0	16.5	0.2	WXGU0403**L	0.9

Torque: Recommended clamping torque: lbs-ft (*N-m) **RE: Standard corner radius
Use right-hand toolholders (R) with left-hand inserts (L); and left-hand toolholders (L) with right-hand inserts (R).
(1) Compatible to the direct internal coolant supply system without the use of external coolant hose.

SPARE PARTS

Designation	Clamping screw	Coolant unit	Wrench
JSWL2XR**-CHP	SR34-514	S-CU-CHP	T-7F

Reference pages: JSWLXR/L, JSWL2XR/L-CHP: Inserts → **B161** -
Standard cutting conditions → **C143**

Back-clamp toolholder with 95° approach angle, for WXGU inserts

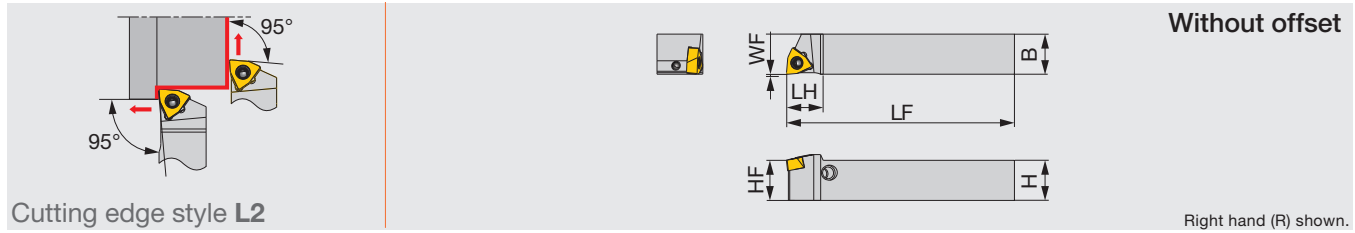

Inch	H	B	LF	LH	HF	WF	RE**	Insert	Torque
JPWL2XR/L062	0.375	0.375	4.750	0.500	0.375	0	0.008	WXGU0403**/L/R...	0.66
JPWL2XR/L082	0.500	0.500	4.750	0.500	0.500	0	0.008	WXGU0403**/L/R...	0.66
JPWL2XR/L102	0.625	0.625	4.750	0.500	0.625	0	0.008	WXGU0403**/L/R...	0.66

Metric	H	B	LF	LH	HF	WF	RE**	Insert	Torque*
JPWL2XR/L1010X04	10	10	120	11	10	0	0.2	WXGU0403**/L/R...	0.9
JPWL2XR/L1212F04	12	12	85	11	12	0	0.2	WXGU0403**/L/R...	0.9
JPWL2XR/L1212X04	12	12	120	11	12	0	0.2	WXGU0403**/L/R...	0.9
JPWL2XR/L1616X04	16	16	120	13	16	0	0.2	WXGU0403**/L/R...	0.9

Torque: Recommended clamping torque: lbs-ft (*N-m) **RE: Standard corner radius
 Use right-hand toolholders (R) with left-hand inserts (L); and left-hand toolholders (L) with right-hand inserts (R).

SPARE PARTS				
Designation	Lever	Pin	Clamping screw	Wrench
JPWL2XR/L...	SLLV-2	SL-PI-2	SR10400611	HW2.0/5RED

INSERT SELECTION

Swiss lathes

Application	Finishing		Medium cutting	
	Grade	SH725	Grade	AH725
Chipbreaker shape	JSS	JTS	JSS	JTS
Cutting conditions	C143			

Small CNC lathes

Application	Finishing		Medium cutting	
	Grade	AH725	Grade	AH8015
Chipbreaker shape	SS	TS	SS	TS
Cutting conditions	C143			

Reference pages: JPWL2XR/L: Inserts → **B161** -
 Standard cutting conditions → **C143**

Screw-on stepped-head toolholder with 95° approach angle, for WXGU inserts

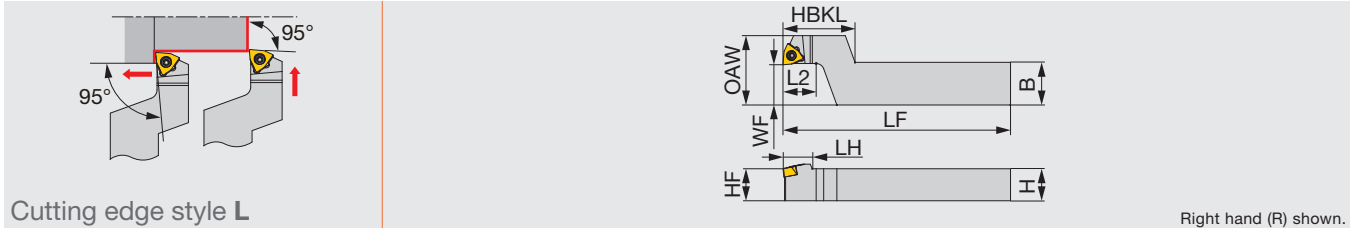

Cutting edge style L

Right hand (R) shown.

Inch	H	B	LF	L2	HBKL	LH	HF	WF	OAW	RE**	Insert	Torque
JSWLXR082-F10	0.500	0.625	4.750	0.500	1.125	0.750	0.500	0.625	1	0.008	WXGU0403**L...	0.66
JSWLXR102-F10	0.625	0.750	4.750	0.500	1.125	0.750	0.625	0.625	1	0.008	WXGU0403**L...	0.66

Metric	H	B	LF	L2	HBKL	LH	HF	WF	OAW	RE**	Insert	Torque*
JSWLXR1016X04-F15	10	16	120	12	27	11	10	15	26	0.2	WXGU0403**L...	0.9
JSWLXR1216F04-F15	12	16	85	12	27	11	12	15	26	0.2	WXGU0403**L...	0.9
JSWLXR1216X04-F15	12	16	120	12	27	11	12	15	26	0.2	WXGU0403**L...	0.9
JSWLXR1620X04-F15	16	20	120	12	27	11	16	15	26	0.2	WXGU0403**L...	0.9

Torque: Recommended clamping torque: lbs-ft (*N·m) **RE: Standard corner radius
Use right-hand toolholders (R) with left-hand inserts (L).

SPARE PARTS

Designation	Clamping screw	Wrench
JSWLXR**-F10	SR34-514	T-7F
JSWLXR**-F15		

INSERT SELECTION

Swiss lathes

P	Application	Finishing	Medium cutting	M	Application	Finishing	Medium cutting
	Grade	SH725	AH725		SH725	AH725	
Chipbreaker shape	JSS	JTS	JSS	JTS			
Cutting conditions	C143		C143				

Small CNC lathes

P	Application	Finishing	Medium cutting	M	Application	Finishing	Medium cutting
	Grade	AH725	AH725		AH8015	AH8015	
Chipbreaker shape	SS	TS	SS	TS			
Cutting conditions	C143		C143				

Reference pages: JSWLXR-F: Inserts → **B161** -
Standard cutting conditions → **C143**

Double-clamp toolholder with 95° approach angle, for negative 80° trigon inserts

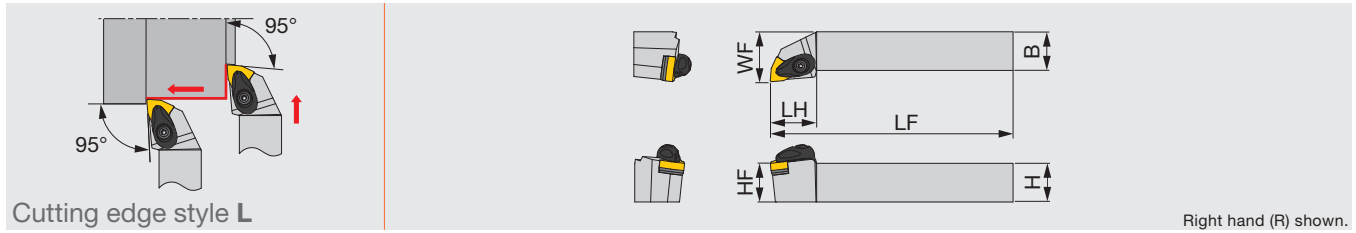

Inch	H	B	LF	LH	HF	WF	RE**	Insert	Torque
AWLNR/L123-A	0.750	0.750	4.500	1.125	0.750	1.000	0.031	WN**33...	2.2
AWLNR/L163-A	1.000	1.000	6.000	1.125	1.000	1.250	0.031	WN**33...	2.2
AWLNR/L124-A	0.750	0.750	4.500	1.250	0.750	1.000	0.031	WN**43...	2.2
AWLNR/L164-A	1.000	1.000	6.000	1.250	1.000	1.250	0.031	WN**43...	2.2
AWLNR/L204-A	1.250	1.250	7.000	1.250	1.250	1.500	0.031	WN**43...	2.2

Metric	H	B	LF	LH	HF	WF	RE**	Insert	Torque*
AWLNR/L2020H08-A	20	20	100	30	20	25	0.8	WN**0804...	3
AWLNR/L2020K08-A	20	20	125	30	20	25	0.8	WN**0804...	3
AWLNR/L2525K08-A	25	25	125	30	25	32	0.8	WN**0804...	3
AWLNR/L2525M08-A	25	25	150	30	25	32	0.8	WN**0804...	3
AWLNR/L3225P08-A	32	25	170	30	32	32	0.8	WN**0804...	3

Torque: Recommended clamping torque: lbs-ft (*N·m)
 **RE: Standard corner radius

SPARE PARTS

Designation	Clamp	Clamp screw	Spring	Spring pin	Shim	Shim screw	Wrench
AWLNR/L**3-A	ACP3S	ACS-5W	BP-7	SP-2.5	ASW322	CSTB-3.5	T-15F
AWLNR/L**4-A, 08-A	ACP4S	ACS-5W	BP-7	SP-2.5	ASW422	CSTB-3.5	T-15F

INSERT SELECTION

Application	Precision finishing	Finishing	Medium cutting	Medium to heavy cutting
	Grade	Grade	Grade	Grade
	NS9530	GT9530	T9215	T9215
Chipbreaker shape	TF	TSF	TM	TH
Cutting conditions	B008			

Application	Finishing	Medium cutting	Medium to heavy cutting
	Grade	Grade	Grade
	T6120	T6130	T6130
Chipbreaker shape	SF	SM	SH
Cutting conditions	B010		

Application	Finishing	Medium cutting	Medium to heavy cutting
	Grade	Grade	Grade
	T515	T515	T515
Chipbreaker shape	All-round	All-round	All-round
Cutting conditions	B012		

Application	Precision finishing	Finishing	Medium cutting
	Grade	Grade	Grade
	BX480	AH8005	AH8005
Chipbreaker shape	T-CBN	HRF	HRM
Cutting conditions	B016		

Application	Precision finishing	Finishing
	Grade	Grade
	BXM10	BXM20
Chipbreaker shape	T-CBN	T-CBN
Cutting conditions	B018	

Reference pages: AWLNR/L: Inserts → **B101** -, CBN → **B181**
 Parts for coolant hose → **C142**

TUNG T^{URN}JET

PWLNR/L-CHP

Lever-lock toolholder with 95° approach angle, for negative 80° trigon inserts, with high pressure coolant capability

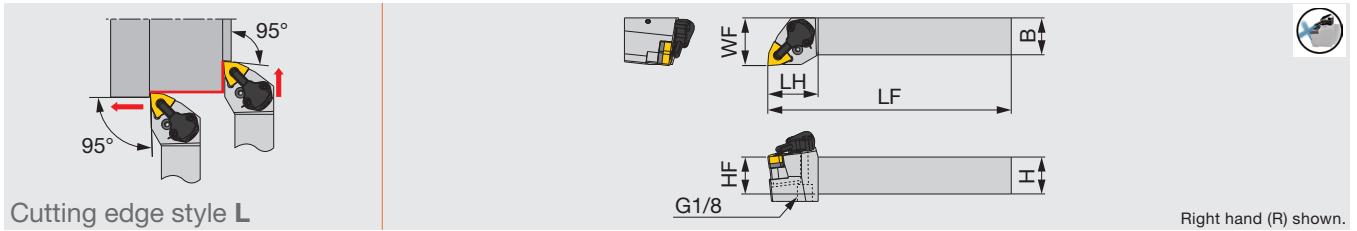

Inch	H	B	LF	LH	HF	WF	RE**	Insert	Torque
PWLNR/L124-CHP	0.750	0.750	4.500	1.969	0.750	1.250	0.031	WN**43...	1.5
PWLNR/L164-CHP	1.000	1.000	6.000	1.969	1.000	1.250	0.031	WN**43...	1.5

Metric	H	B	LF	LH	HF	WF	RE**	Insert	Torque*
PWLNR/L2020K08-CHP	20	20	125	34	20	32	0.8	WN**0804...	3
PWLNR/L2525M08-CHP	25	25	150	34	25	32	0.8	WN**0804...	3

Torque: Recommended clamping torque: lbs-ft (*N-m)
 **RE: Standard corner radius

SPARE PARTS	Shim	Clamping screw	Wrench1	Spring pin	Lever
Designation	LSW42	LCS4	P-2.5	LSP4	LCL4
PWLNR/L*4-CHP, PWLNR/L**08-CHP					

SPARE PARTS	Coolant unit	Mounting screw	Wrench2	O-ring	Coolant screw	Wrench3
Designation	CU-CW-CHP	SRM3	T-8F	OR6.4X0.9N	SRM4X4TL360	P-2
PWLNR/L*4-CHP, PWLNR/L**08-CHP						

TUNG T^{URN}JET

C-PWLNR/L-CHP

ISO E^{CO}TURN TUNG CAP

Lever-lock toolholder with TungCap connection, for negative 80° trigon inserts, with high pressure coolant capability

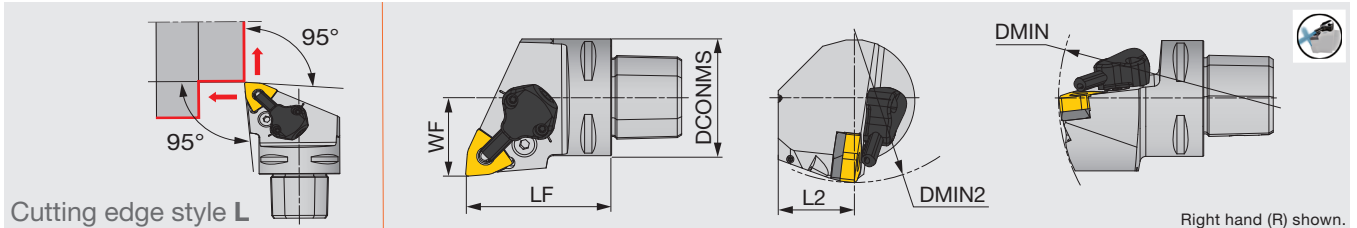

Inch	DCONMS	LF	L2	WF	DMIN	DMIN2	RE**	Insert
C4PWLNR/L27050-0604-CHP	1.575	1.969	0.984	1.063	5.512	4.331	0.031	WN**33...
C4PWLNR/L27050-08-CHP	1.575	1.969	0.984	1.063	5.512	4.331	0.031	WN**43...
C6PWLNR/L45065-08-CHP	2.480	2.559	1.614	1.772	7.480	4.331	0.031	WN**43...

Metric	DCONMS	LF	L2	WF	DMIN	DMIN2	RE**	Insert
C4PWLNR/L27050-0604-CHP	40	50	25	27	140	110	0.8	WN**0604...
C4PWLNR/L27050-08-CHP	40	50	25	27	140	110	0.8	WN**0804...
C6PWLNR/L45065-08-CHP	63	65	41	45	190	110	0.8	WN**0804...

**RE: Standard corner radius

SPARE PARTS FOR P-TYPE	Shim	Clamping screw	Wrench1	Spring pin	Lever
Designation	LSW312	LCS3	P-2.5	LSP3	LCL3
C*PWLNR/L*-0604-CHP					
C*PWLNR/L*-08-CHP	LSW42BL	LCS4	P-3	LSP4	LCL4

COOLANT SET	Coolant unit	Mounting screw	Wrench2	O-ring
Designation	CU-CW-CHP	SRM3	T-8F	OR6.4X0.9N
C*PWLNR/L*-CHP				

Reference pages: PWLNR/L-CHP, C-PWLNR/L-CHP: Inserts → **B101 -**, CBN → **B181**
 Parts for coolant hose → **C142**

DWLNLR/L

One-Double toolholder with 95° approach angle, for negative 80° trigon inserts

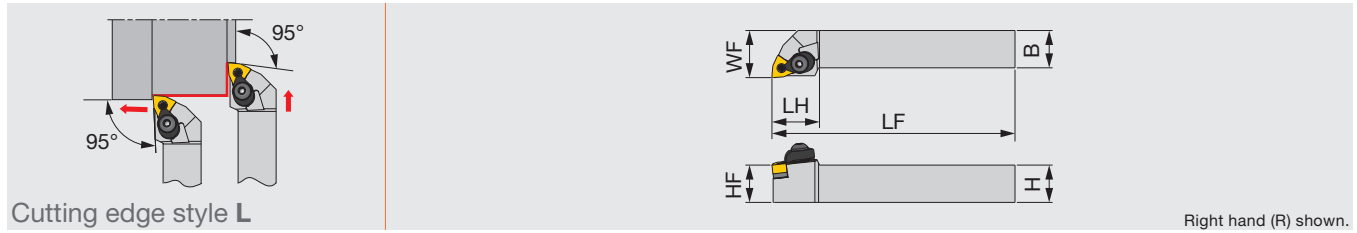

Metric	H	B	LF	LH	HF	WF	RE**	Insert
DWLNLR/L2020K06	20	20	125	25.5	20	25	0.8	WN**0604...
DWLNLR/L2020K08	20	20	125	31	20	25	0.8	WN**0804...
DWLNLR/L2525M06	25	25	150	26	25	32	0.8	WN**0604...
DWLNLR/L2525M08	25	25	150	31	25	32	0.8	WN**0804...
DWLNLR/L3225P08	32	25	170	30	32	32	0.8	WN**0804...

Except for 57-type chipbreaker inserts
 **RE: Standard corner radius

SPARE PARTS									
Designation	Clamp	Lever	Piston	Clamp screw	Shim	Spring	Spring pin	Wrench1	Wrench2
DWLNLR/L**06	DCPM-33	LCL33	DPIS33	DLCS33	LSW312	BP-9	LSP3	P-2.5	P-3
DWLNLR/L**08	DCPM-43	DLCL43	DPIS43	DLCS43	LSW42	BP-10	LSP4	P-3	P-4

INSERT SELECTION

P	Application	Precision finishing	Finishing	Medium cutting	Medium to heavy cutting	M	Application	Finishing	Medium cutting	Medium to heavy cutting
	Grade	NS9530	GT9530	T9215	T9215		Grade	T6120	T6130	T6130
	Chipbreaker shape						Chipbreaker shape			
	Cutting conditions	B008					Cutting conditions	B010		
K	Application	Finishing	Medium cutting	Medium to heavy cutting	S	Application	Precision finishing	Finishing	Medium cutting	
	Grade	T515	T515	T515		Grade	BX480	AH8005	AH8005	
	Chipbreaker shape	All-round	All-round	All-round		Chipbreaker shape	T-CBN	HRF	HRM	
	Cutting conditions	B012				Cutting conditions	B016			
H	Application	Precision finishing	Finishing			Index	Application	Precision finishing	Finishing	Medium cutting
	Grade	BXM10	BXM20				Grade	BX480	AH8005	AH8005
	Chipbreaker shape	T-CBN	T-CBN				Chipbreaker shape	T-CBN	HRF	HRM
	Cutting conditions	B018					Cutting conditions	B016		

Reference pages: DWLNLR/L: Inserts → B101 -, CBN → B181



Double-clamp toolholder with 93° approach angle, for negative 55° rhombic inserts

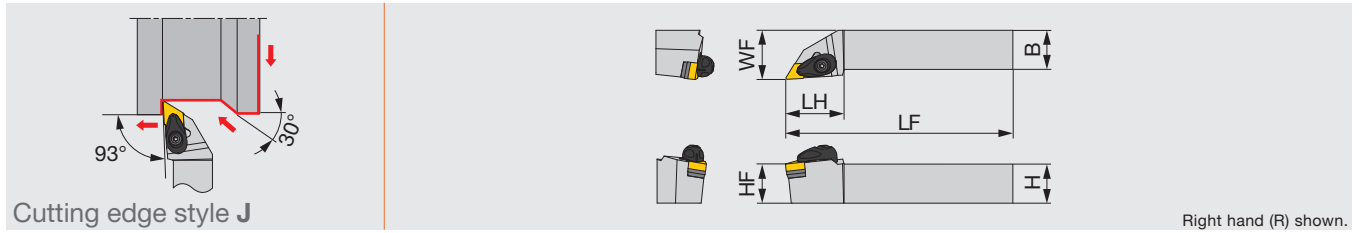

Inch	H	B	LF	LH	HF	WF	RE**	Insert	Torque
ADJNR/L1233-A	0.750	0.750	4.500	1.250	0.750	1.000	0.031	DN**33...	2.2
ADJNR/L1633-A	1.000	1.000	6.000	1.250	1.000	1.250	0.031	DN**33...	2.2

Metric	H	B	LF	LH	HF	WF	RE**	Insert	Torque*
ADJNR/L2020K1104-A	20	20	125	30	20	25	0.8	DN**1104...	3
ADJNR/L2525M1104-A	25	25	150	30	25	32	0.8	DN**1104...	3

Right hand (R) shown.

Torque: Recommended clamping torque: lbs-ft (*N-m) **RE: Standard corner radius

SPARE PARTS	Clamp	Clamp screw	Spring	Spring pin	Shim	Shim screw	Wrench
Designation	ACP3S-E	ACS-5W	BP-7	SP-2.5	ASD322	CSTB-3.5	T-15F
ADJNR/L**-A							

Lever-lock toolholder with 93° approach angle, for negative 55° rhombic inserts, with high pressure coolant capability

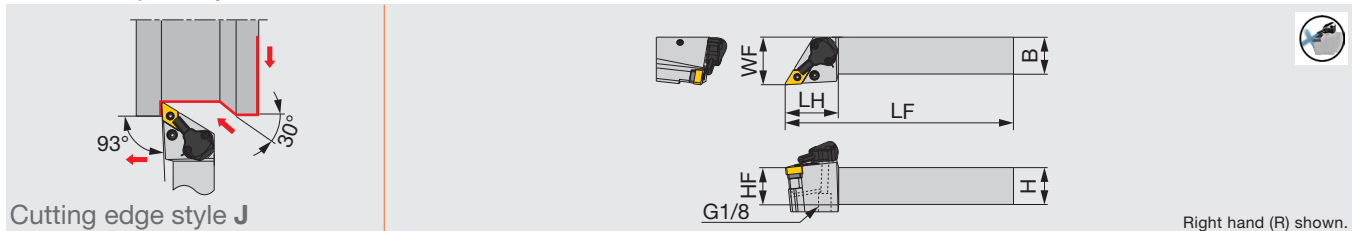

Inch	H	B	LF	LH	HF	WF	RE**	Insert	Torque
PDJNR/L1233-CHP	0.750	0.750	4.500	1.420	0.750	1.250	0.031	DN**33...	1.5
PDJNR/L1633-CHP	1.000	1.000	6.000	1.125	1.000	1.250	0.031	DN**33...	1.5

Metric	H	B	LF	LH	HF	WF	RE**	Insert	Torque*
PDJNR/L2020K1104-CHP	20	20	125	36	20	32	0.8	DN**1104...	2
PDJNR/L2525M1104-CHP	25	25	150	36	25	32	0.8	DN**1104...	2

Right hand (R) shown.

Torque: Recommended clamping torque: lbs-ft (*N-m) **RE: Standard corner radius

SPARE PARTS	Shim	Clamping screw	Wrench1	Spring pin	Lever
Designation	ELSD32	LCS3	P-2.5	LSP3	LCL33L
PDJNR/L**-CHP					

SPARE PARTS	Coolant unit	Mounting screw	Wrench2	O-ring	Coolant screw	Wrench3
Designation	CU-D-CHP	SRM3	T-8F	OR6.4X0.9N	SRM4X4TL360	P-2
PDJNR/L**-CHP						

Reference pages: ADJNR/L-Eco, PDJNR/L-CHP-Eco: Inserts → **B067 -**
Parts for coolant hose → **C142**

Lever-lock toolholder with 93° approach angle, for negative 55° rhombic inserts

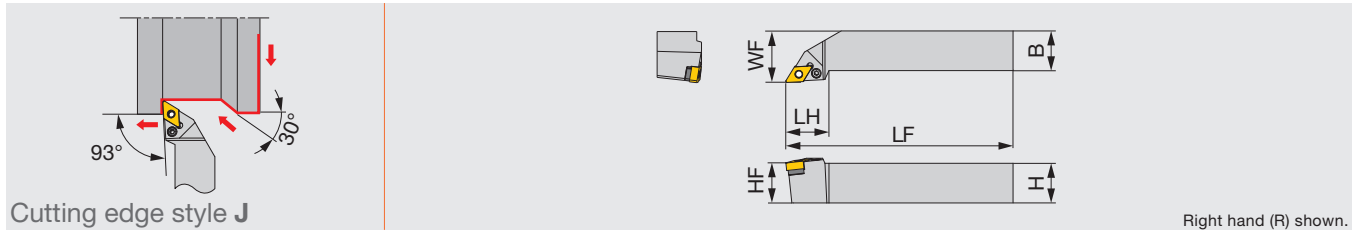

Right hand (R) shown.

Inch	H	B	LF	LH	HF	WF	RE**	Insert	Torque
PDJNR/L1033	0.625	0.625	4.000	1.125	0.625	0.875	0.031	DN**33...	1.5
PDJNR/L1233	0.750	0.750	4.500	1.125	0.750	1.000	0.031	DN**33...	1.5
PDJNR/L1633	1.000	1.000	6.000	1.125	1.000	1.250	0.031	DN**33...	1.5

Metric	H	B	LF	LH	HF	WF	RE**	Insert	Torque*
PDJNR/L1616H1104	16	16	100	27	16	20	0.8	DN**1104...	2
PDJNR/L2020K1104	20	20	125	27	20	25	0.8	DN**1104...	2
PDJNR/L2525M1104	25	25	150	27	25	32	0.8	DN**1104...	2

Torque: Recommended clamping torque: lbs-ft (*N-m) **RE: Standard corner radius

SPARE PARTS

Designation	Shim	Clamping screw	Wrench	Spring pin	Lever
PDJNR/L...	ELSD32	LCS3	P-2.5	LSP3	LCL33L

INSERT SELECTION

P

Application	Finishing	Medium cutting
Grade	T9215	T9215
Chipbreaker shape	TSF	TM
Cutting conditions	B008	

M

Application	Finishing	Medium cutting
Grade	T6120	T6130
Chipbreaker shape	SS	SM
Cutting conditions	B010	

K

Application	Medium cutting
Grade	T515
Chipbreaker shape	TM
Cutting conditions	B012

Reference pages: PDJNR/L-Eco: Inserts → **B067** -
Parts for coolant hose → **C142**

Grade
Insert
Toolholder
Ext. Toolholder
Int. Toolholder
Threading
Grooving
Milling Cutter
Miniature Tool
Endmill
Drilling Tool
User's Guide
Tooling System
Index



Screw-on toolholder with 93° approach angle, for DXGU inserts

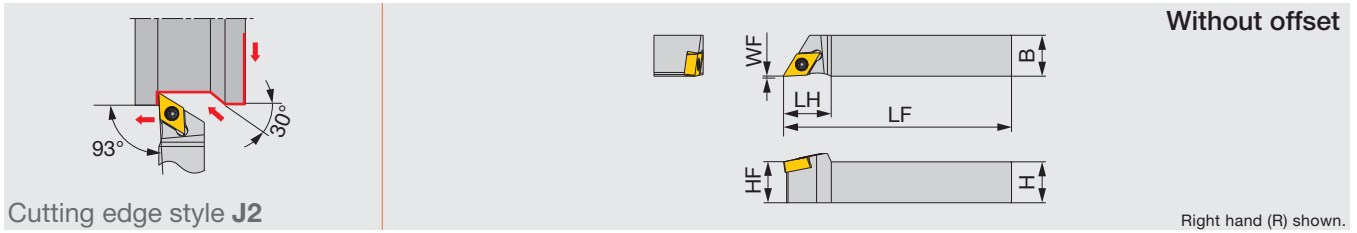

Inch	H	B	LF	LH	HF	WF	RE**	Insert	Torque
JSDJ2XR/L062	0.375	0.375	4.750	0.625	0.375	0	0.008	DXGU0703**L/R...	0.66
JSDJ2XR/L082	0.500	0.500	4.750	0.625	0.500	0	0.008	DXGU0703**L/R...	0.66
JSDJ2XR/L102	0.625	0.625	4.750	0.625	0.625	0	0.008	DXGU0703**L/R...	0.66
Metric	H	B	LF	LH	HF	WF	RE**	Insert	Torque*
JSDJ2XR/L1010X07	10	10	120	14	10	0	0.2	DXGU0703**L/R...	0.9
JSDJ2XR/L1212F07	12	12	85	14	12	0	0.2	DXGU0703**L/R...	0.9
JSDJ2XR/L1212X07	12	12	120	14	12	0	0.2	DXGU0703**L/R...	0.9
JSDJ2XR/L1616X07	16	16	120	18	16	0	0.2	DXGU0703**L/R...	0.9
JSDJ2XR/L2020H07	20	20	100	18	20	0	0.2	DXGU0703**L/R...	0.9

Torque: Recommended clamping torque: lbs-ft (*N·m) **RE: Standard corner radius
Use right-hand toolholders (R) with left-hand inserts (L); and left-hand toolholders (L) with right-hand inserts (R).

SPARE PARTS

Designation	Clamping screw	Wrench
JSDJ2XR/L...	SR34-514	T-7F

Screw-on toolholder with 93° approach angle, for DXGU inserts

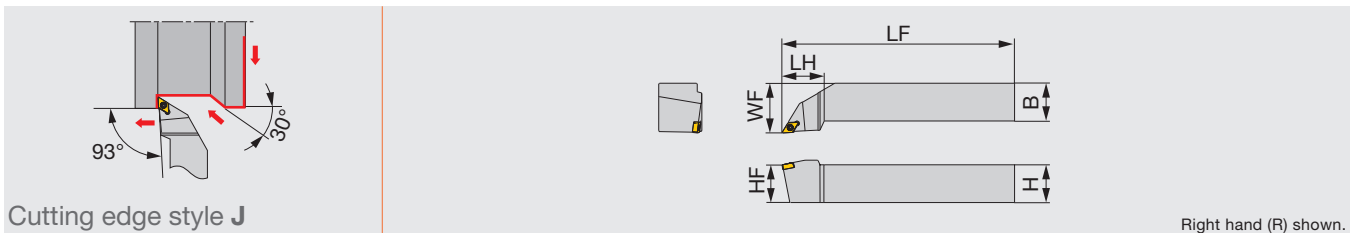

Inch	H	B	LF	LH	HF	WF	RE**	Insert	Torque
JSDJXR/122	0.750	0.750	4.500	1.125	0.750	1.000	0.008	DXGU0703**L/R...	0.66
JSDJXR/162	1.000	1.000	6.000	1.125	1.000	1.250	0.008	DXGU0703**L/R...	0.66
Metric	H	B	LF	LH	HF	WF	RE**	Insert	Torque*
JSDJXR/L2020K07	20	20	125	27	20	25	0.4	DXGU0703**L/R...	0.9
JSDJXR/L2525M07	25	25	150	27	25	32	0.4	DXGU0703**L/R...	0.9

Torque: Recommended clamping torque: lbs-ft (*N·m) **RE: Standard corner radius
Use right-hand toolholders (R) with left-hand inserts (L); and left-hand toolholders (L) with right-hand inserts (R).

SPARE PARTS

Designation	Clamping screw	Wrench
JSDJXR/L...	SR34-514	T-7F

Reference pages: JSDJ2XR/L, JSDJXR/L: Inserts → **B127** -
Standard cutting conditions → **C143**

Screw-on toolholder with 93° approach angle, for DXGU inserts, with high pressure coolant capability

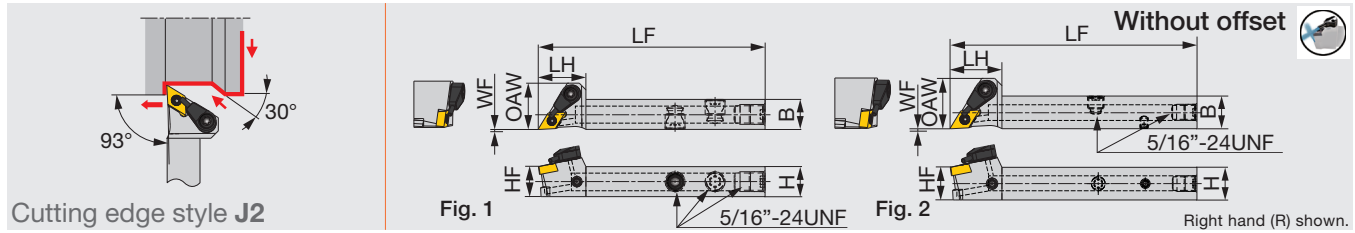

Inch	H	B	LF	LH	HF	WF	OAW	RE**	Insert	Torque	Fig.
JSDJ2XR/L082-CHP	0.500	0.500	3.344	0.750	0.500	0	0.730	0.008	DXGU0703**/L/R...	0.66	1
JSDJ2XR082X-CHP ⁽¹⁾	0.500	0.500	4.750	0.748	0.500	0	0.728	0.008	DXGU0703**/L...	0.66	2
JSDJ2XR102X-CHP ⁽¹⁾	0.625	0.625	4.750	0.748	0.625	0	0.728	0.008	DXGU0703**/L...	0.66	2

Metric	H	B	LF	LH	HF	WF	OAW	RE**	Insert	Torque*	Fig.
JSDJ2XR/L1212F07-CHP	12	12	85	19	12	0	18.5	0.2	DXGU0703**/L/R...	0.9	1
JSDJ2XR1212X07-CHP ⁽¹⁾	12	12	120	19	12	0	18.5	0.2	DXGU0703**/L...	0.9	2
JSDJ2XR1616X07-CHP ⁽¹⁾	16	16	120	19	16	0	18.5	0.2	DXGU0703**/L...	0.9	2

Torque: Recommended clamping torque: lbs-ft (*N-m) **RE: Standard corner radius
 Use right-hand toolholders (R) with left-hand inserts (L); and left-hand toolholders (L) with right-hand inserts (R).
 (1) Compatible to the direct internal coolant supply system without the use of external coolant hose.

SPARE PARTS

Designation	Clamping screw	Coolant unit	Wrench
JSDJ2XR/L*-CHP	SR34-514	S-CU-CHP	T-7F

INSERT SELECTION

Swiss lathes

Application	Finishing		Medium cutting	
	Grade	SH725	Grade	AH725
Chipbreaker shape	JSS	JTS	JSS	JTS
Cutting conditions	C143			

Small CNC lathes

Application	Finishing		Medium cutting	
	Grade	AH725	Grade	AH725
Chipbreaker shape	SS	TS	SS	TS
Cutting conditions	C143			

Reference pages: JSDJ2XR/L-CHP: Inserts → **B127** -
 Standard cutting conditions → **C143**

Back-clamp toolholder with 93° approach angle, for DXGU inserts

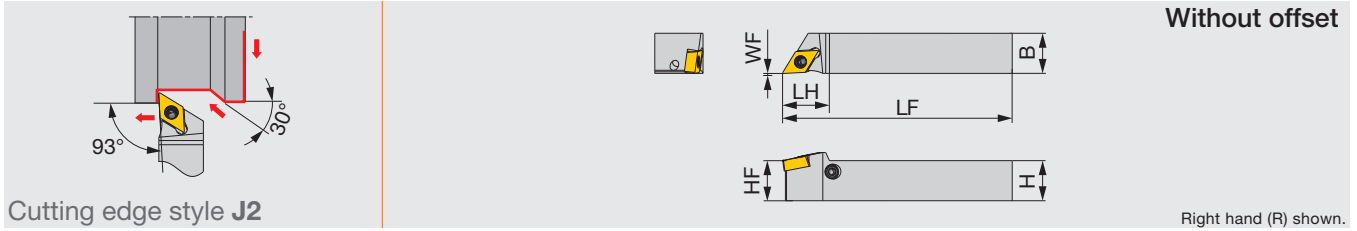

Inch	H	B	LF	LH	HF	WF	RE**	Insert	Torque
JPDJ2XR/L062	0.375	0.375	4.750	0.625	0.375	0	0.008	DXGU0703**L/R...	0.66
JPDJ2XR/L082	0.500	0.500	4.750	0.625	0.500	0	0.008	DXGU0703**L/R...	0.66
JPDJ2XR/L102	0.625	0.625	4.750	0.625	0.625	0	0.008	DXGU0703**L/R...	0.66

Metric	H	B	LF	LH	HF	WF	RE**	Insert	Torque*
JPDJ2XR/L1010X07	10	10	120	14	10	0	0.2	DXGU0703**L/R...	0.9
JPDJ2XR/L1212F07	12	12	85	14	12	0	0.2	DXGU0703**L/R...	0.9
JPDJ2XR/L1212X07	12	12	120	14	12	0	0.2	DXGU0703**L/R...	0.9
JPDJ2XR/L1616X07	16	16	120	18	16	0	0.2	DXGU0703**L/R...	0.9

Torque: Recommended clamping torque: lbs-ft (*N-m) **RE: Standard corner radius
Use right-hand toolholders (R) with left-hand inserts (L); and left-hand toolholders (L) with right-hand inserts (R).

SPARE PARTS

Designation	Lever	Pin	Clamping screw	Wrench
JPDJ2XR/L...	SLLV-2	SL-PI-2	SR10400611	HW2.0/5RED

INSERT SELECTION

Swiss lathes

P	Application	Finishing	Medium cutting	M	Application	Finishing	Medium cutting
	Grade	SH725	AH725		Grade	SH725	AH725
Chipbreaker shape	JSS	JTS	Chipbreaker shape	JSS	JTS		
Cutting conditions	C143		Cutting conditions	C143			

Small CNC lathes

P	Application	Finishing	Medium cutting	M	Application	Finishing	Medium cutting
	Grade	AH725	AH725		Grade	AH8015	AH8015
Chipbreaker shape	SS	TS	Chipbreaker shape	SS	TS		
Cutting conditions	C143		Cutting conditions	C143			

Reference pages: JPDJ2XR/L: Inserts → **B127** -
Standard cutting conditions → **C143**

Screw-on stepped-head toolholder with 93° approach angle, for DXGU inserts

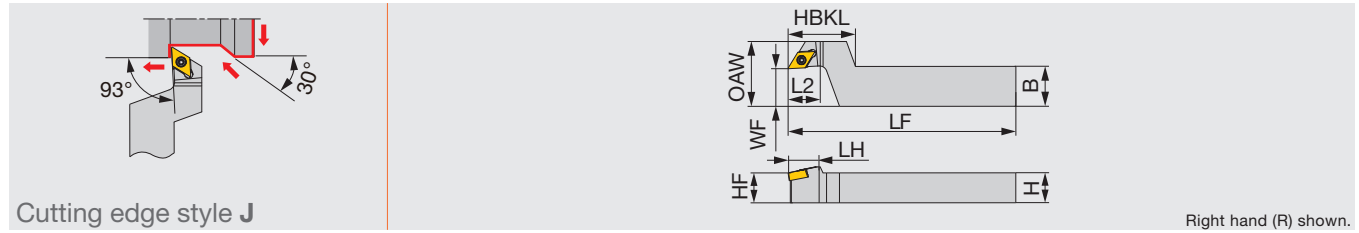

Cutting edge style J

Right hand (R) shown.

Inch	H	B	LF	L2	HBKL	LH	HF	WF	OAW	RE**	Insert	Torque
JSDJXR082-F10	0.500	0.625	4.750	0.500	1.125	0.625	0.500	0.625	1	0.008	DXGU0703**L...	0.66
JSDJXR102-F10	0.625	0.750	4.750	0.500	1.125	0.625	0.625	0.625	1	0.008	DXGU0703**L...	0.66

Metric	H	B	LF	L2	HBKL	LH	HF	WF	OAW	RE**	Insert	Torque*
JSDJXR1016X07-F15	10	16	120	12	27	14	10	15	26	0.2	DXGU0703**L...	0.9
JSDJXR1216F07-F15	12	16	85	12	27	14	12	15	26	0.2	DXGU0703**L...	0.9
JSDJXR1216X07-F15	12	16	120	12	27	14	12	15	26	0.2	DXGU0703**L...	0.9
JSDJXR1620X07-F15	16	20	120	12	27	14	16	15	26	0.2	DXGU0703**L...	0.9

Torque: Recommended clamping torque: lbs-ft (*N-m) **RE: The holder measurements are true with this insert radius
Use the right-hand toolholder (R) for the left-hand insert (L)

SPARE PARTS

Designation	Clamping screw	Wrench
JSDJXR**-F...	SR34-514	T-7F

INSERT SELECTION

Swiss lathes

Application	Finishing		Medium cutting		Application	Finishing		Medium cutting	
	Grade	SH725	Grade	AH725		Grade	SH725	Grade	AH725
Chipbreaker shape	JSS	JTS	JSS	JTS	Chipbreaker shape	JSS	JTS	JSS	JTS
Cutting conditions	C143				Cutting conditions	C143			

Small CNC lathes

Application	Finishing		Medium cutting		Application	Finishing		Medium cutting	
	Grade	AH725	Grade	AH725		Grade	AH8015	Grade	AH8015
Chipbreaker shape	SS	TS	SS	TS	Chipbreaker shape	SS	TS	SS	TS
Cutting conditions	C143				Cutting conditions	C143			

Reference pages: JSDJXR-F: Inserts → **B127** -
Standard cutting conditions → **C143**

Double-clamp toolholder with 93° approach angle, for negative 55° rhombic inserts

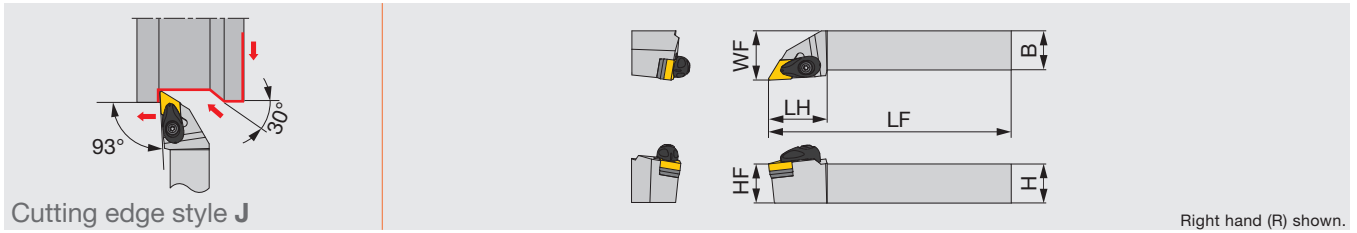

Right hand (R) shown.

Inch	H	B	LF	LH	HF	WF	RE**	Insert	Torque
ADJNR/L124-A	0.750	0.750	4.500	1.500	0.750	1.000	0.031	DN**43...	2.2
ADJNR/L164-A	1.000	1.000	6.000	1.500	1.000	1.250	0.031	DN**43...	2.2
ADJNR/L204-A	1.250	1.250	7.000	1.500	1.250	1.500	0.031	DN**43...	2.2

Metric	H	B	LF	LH	HF	WF	RE**	Insert	Torque*
ADJNR/L2020K15-A	20	20	125	36	20	25	0.8	DN**1504...	3
ADJNR/L2020K1506-A	20	20	125	36	20	25	0.8	DN**1506...	3
ADJNR/L2525M15-A	25	25	150	36	25	32	0.8	DN**1504...	3
ADJNR/L2525M1506-A	25	25	150	36	25	32	0.8	DN**1506...	3
ADJNR/L3225P15-A	32	25	170	36	32	32	0.8	DN**1504...	3

Torque: Recommended clamping torque: lbs-ft (*N·m) **RE: Standard corner radius

SPARE PARTS

Designation	Clamp	Clamp screw	Spring	Spring pin	Shim	Shim screw	Wrench
ADJNR/L**15-A	ACP4S	ACS-5W	BP-7	SP-2.5	ASD432	CSTB-3.5	T-15F
ADJNR/L**4-A, 1506-A	ACP4S	ACS-5W	BP-7	SP-2.5	ASD423	CSTB-3.5	T-15F

TUNG T^{URN}JET

PDJNR/L-CHP

Lever-lock toolholder, for negative 55° rhombic inserts, with high pressure coolant capability

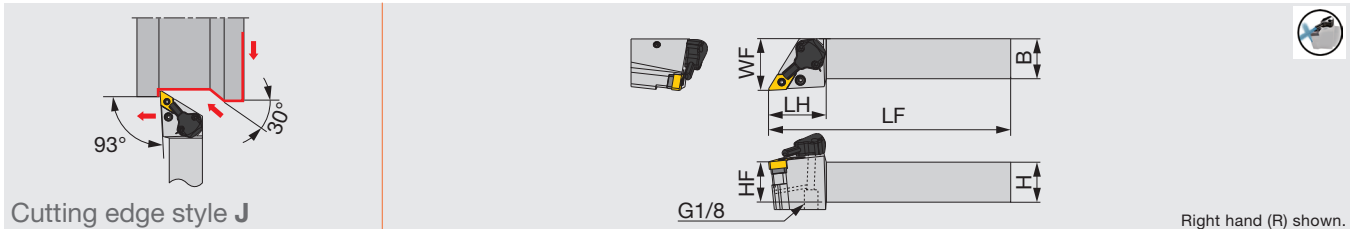

Right hand (R) shown.

Inch	H	B	LF	LH	HF	WF	RE**	Insert	Torque
PDJNR/L124-CHP	0.750	0.750	4.500	1.420	0.750	1.250	0.031	DN**43...	2.2
PDJNR/L164-CHP	1.000	1.000	6.000	1.420	1.000	1.250	0.031	DN**43...	2.2

Metric	H	B	LF	LH	HF	WF	RE**	Insert	Torque*
PDJNR/L2020K15-CHP	20	20	125	36	20	32	0.8	DN**1504...	3
PDJNR/L2525M15-CHP	25	25	150	36	25	32	0.8	DN**1504...	3

Torque: Recommended clamping torque: lbs-ft (*N·m) **RE: Standard corner radius

SPARE PARTS

Designation	Shim	Clamping screw	Wrench1	Spring pin	Lever
PDJNR/L**4-CHP, PDJNR/L**15-CHP	LSD43A	LCS4	P-3	LSP4	LCL4

SPARE PARTS

Designation	Coolant unit	Mounting screw	Wrench2	O-ring	Coolant screw	Wrench3
PDJNR/L**4-CHP, PDJNR/L**15-CHP	CU-D-CHP	SRM3	T-8F	OR6.4X0.9N	SRM4X4TL360	P-2

Reference pages: ADJNR/L, PDJNR/L-CHP: Inserts → **B067 -**, CBN → **B174 -**, PCD → **B194 -**
Parts for coolant hose → **C142**

PDJNR/L

Lever-lock toolholder with 93° approach angle, for negative 55° rhombic inserts

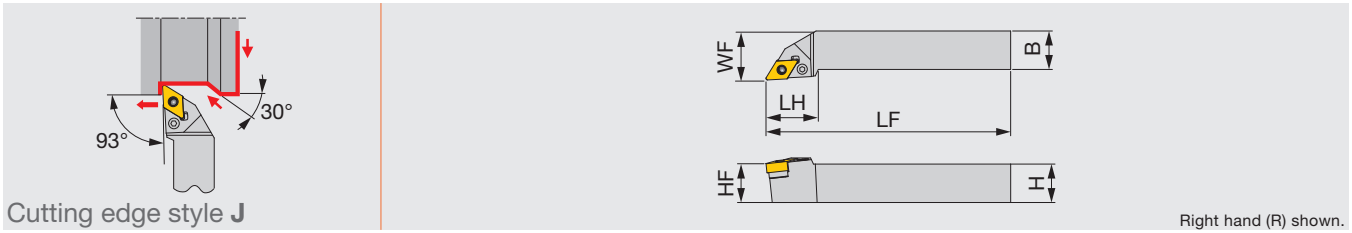

Right hand (R) shown.

Metric	H	B	LF	LH	HF	WF	RE**	Insert
PDJNR/L1616H11	16	16	100	27	16	20	0.8	DN**1104...
PDJNR/L2020K11	20	20	125	27	20	25	0.8	DN**1104...
PDJNR/L2020	20	20	125	34	20	25	0.8	DN**1504...
PDJNR2020K15E	20	20	125	36	20	25	0.8	DN**1506...
PDJNR/L2520	25	20	150	34	25	25	0.8	DN**1504...
PDJNR/L2525M11	25	25	150	27	25	32	0.8	DN**1104...
PDJNR/L2525	25	25	150	34	25	32	0.8	DN**1504...
PDJNR/L2525M15E	25	25	150	36	25	32	0.8	DN**1506...
PDJNR/L3225	32	25	170	32	32	32	0.8	DN**1504...
PDJNR3225P15E	32	25	170	36	32	34	0.8	DN**1506...

**RE: Standard corner radius

SPARE PARTS

Designation	Shim	Clamping screw	Wrench	Spring pin	Lever
PDJNR/L****11	ELSD32	LCS3	P-2.5	LSP3	LCL33L
PDJNR/L2020	LSD42	LCS4	P-3	LSP4	LCL4
PDJNR2020K15E	ELSD42	ELCS4	P-3	LSP4S	LCL44
PDJNR/L2520	LSD42	LCS4	P-3	LSP4	LCL4
PDJNR/L2525	LSD42	LCS4	P-3	LSP4	LCL4
PDJNR/L2525M15E	ELSD42	ELCS4	P-3	LSP4S	LCL44
PDJNR/L3225	LSD42	LCS4	P-3	LSP4	LCL4
PDJNR3225P15E	ELSD42	ELCS4	P-3	LSP4S	LCL44

INSERT SELECTION

P	Application	Precision finishing	Finishing	Medium cutting	Medium to heavy cutting
	Grade	NS9530	GT9530	T9215	T9215
	Chipbreaker shape	TF	TSF	TM	TH
	Cutting conditions	B008			
M	Application	Finishing	Medium cutting	Medium to heavy cutting	
	Grade	T6120	T6130	T6130	
	Chipbreaker shape	SF	SM	SH	
	Cutting conditions	B010			
K	Application	Finishing	Medium cutting	Medium to heavy cutting	
	Grade	T515	T515	T515	
	Chipbreaker shape	All-round	All-round	All-round	
	Cutting conditions	B012			
N	Application	Precision finishing	Finishing	Medium cutting	
	Grade	DX120	DX140	TH10	
	Chipbreaker shape	T-DIA	with rake T-DIA	P	
	Cutting conditions	B014			
S	Application	Precision finishing	Finishing	Medium cutting	
	Grade	BX470	AH8005	AH8005	
	Chipbreaker shape	T-CBN	HRF	HRM	
	Cutting conditions	B016			
H	Application	Precision finishing	Finishing		
	Grade	BXM10	BXM20		
	Chipbreaker shape	T-CBN	T-CBN		
	Cutting conditions	B018			

Reference pages: PDJNR/L: Inserts → B067 -, CBN → B174 -, PCD → B194 -



Lever-lock toolholder with TungCap connection, for negative 55° rhombic inserts, with high pressure coolant capability

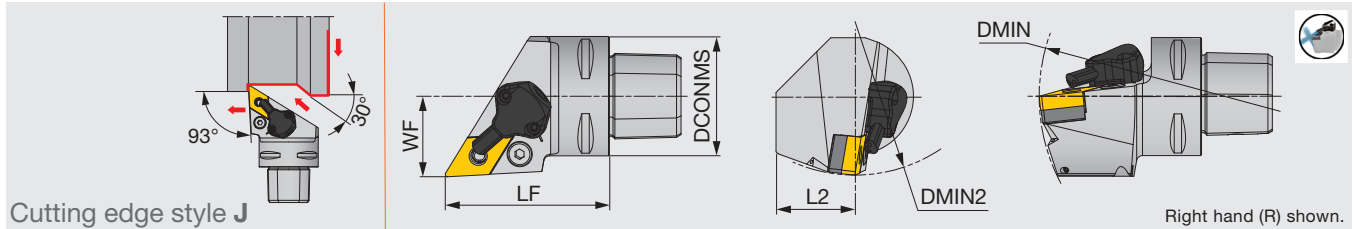

Metric	DCONMS	LF	L2	WF	DMIN	DMIN2	RE**	Insert
C4PDJNR/L27055-1104-CHP	40	55	25	27	140	110	0.8	DN**1104...
C4PDJNR/L27055-15-CHP	40	55	25	27	140	110	0.8	DN**1504(06)...
C5PDJNR/L35060-15-CHP	50	60	32	35	165	110	0.8	DN**1504(06)...
C6PDJNR/L45065-1104-CHP	63	65	41	45	190	110	0.8	DN**1104...
C6PDJNR/L45065-15-CHP	63	65	41	45	190	110	0.8	DN**1504(06)...

**RE: Standard corner radius

SPARE PARTS

Designation	Shim	Clamping screw	Wrench 1	Spring pin	Lever
C*PDJNR/L**1104-CHP	ELSD32	LCS3	P-2.5	LSP3	LCL33L
C*PDJNR/L**15-CHP	LSD43A	LCS4	P-3	LSP4	LCL4

Option: LSD42A (Shim for DN**1506...), LSP4S (Spring pin for DN**1506...)

SPARE PARTS

Designation	Coolant unit	Coolant screw	Wrench 2	Wrench 3
C*PDJNR/L**1104-CHP	CU-D-CHP	SRM4X4TL360	T-8F	P-2
C*PDJNR/L**15-CHP	CU-D-CHP	SRM4X4TL360	T-8F	P-2

INSERT SELECTION

Application	Precision finishing	Finishing	Medium cutting	Medium to heavy cutting
	Grade	NS9530	GT9530	T9215
Chipbreaker shape	TF	TSF	TM	TH
Cutting conditions	B008			

Application	Finishing	Medium cutting	Medium to heavy cutting
	Grade	T6120	T6130
Chipbreaker shape	SF	SM	SH
Cutting conditions	B010		

Application	Finishing	Medium cutting	Medium to heavy cutting
	Grade	T515	T515
Chipbreaker shape	All-round	All-round	All-round
Cutting conditions	B012		

Application	Precision finishing	Finishing	Medium cutting
	Grade	DX120	DX140
Chipbreaker shape	T-DIA	with rake T-DIA	P
Cutting conditions	B014		

Application	Precision finishing	Finishing	Medium cutting
	Grade	BX470	AH8005
Chipbreaker shape	T-CBN	HRF	HRM
Cutting conditions	B016		

Application	Precision finishing	Finishing
	Grade	BXM10
Chipbreaker shape	T-CBN	T-CBN
Cutting conditions	B018	

Reference pages: C-PDJNR/L-CHP: Inserts → **B067** -, CBN → **B174** -, PCD → **B194** -
Parts for coolant hose → **C142**

DDJNR/L

One-Double toolholder with 93° approach angle, for negative 55° rhombic inserts

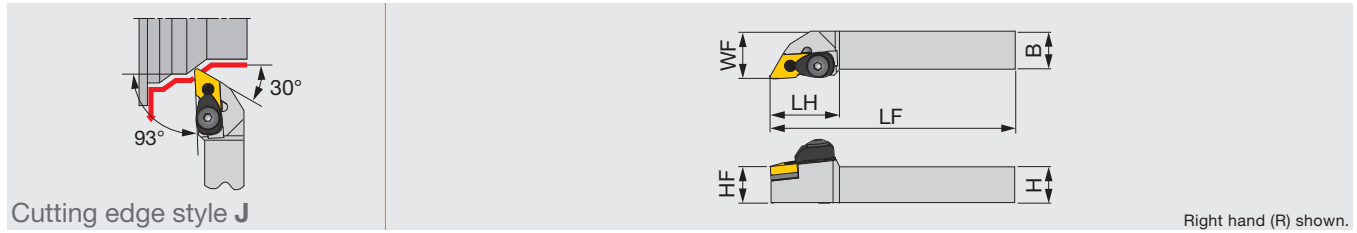

Metric	H	B	LF	LH	HF	WF	RE**	Insert
DDJNR/L2020K15	20	20	125	38	20	25	0.8	DN**1504...
DDJNR/L2020K1506	20	20	125	38	20	25	0.8	DN**1506...
DDJNR/L2525M15	25	25	150	38	25	32	0.8	DN**1504...
DDJNR/L2525M1506	25	25	150	38	25	32	0.8	DN**1506...
DDJNR/L3225P15	32	25	170	38	32	32	0.8	DN**1504...
DDJNR/L3225P1506	32	25	170	38	32	32	0.8	DN**1506...

Except for 57-type chipbreaker inserts
**RE: Standard corner radius

SPARE PARTS									
Designation	Clamp	Lever	Piston	Clamp screw	Shim	Spring	Spring pin	Wrench1	Wrench2
DDJNR/L**15	DCPM-43	DLCL43	DPIS43	DLCS43	LSD42	BP-10	LSP4	P-3	P-4
DDJNR/L**1506	DCPM-43	DLCL43	DPIS44	DLCS43	LSD42	BP-10	LSP4	P-3	P-4

INSERT SELECTION

P	Application	Precision finishing	Finishing	Medium cutting	Medium to heavy cutting
	Grade	NS9530	GT9530	T9215	T9215
Chipbreaker shape	TF	TSF	TM	TH	
Cutting conditions	B008				

M	Application	Finishing	Medium cutting	Medium to heavy cutting
	Grade	T6120	T6130	T6130
Chipbreaker shape	SF	SM	SH	
Cutting conditions	B010			

K	Application	Finishing	Medium cutting	Medium to heavy cutting
	Grade	T515	T515	T515
Chipbreaker shape	All-round	All-round	All-round	
Cutting conditions	B012			

N	Application	Precision finishing	Finishing	Medium cutting
	Grade	DX120	DX140	TH10
Chipbreaker shape	T-DIA	with rake T-DIA	P	
Cutting conditions	B014			

S	Application	Precision finishing	Finishing	Medium cutting
	Grade	BX470	AH8005	AH8005
Chipbreaker shape	T-CBN	HRF	HRM	
Cutting conditions	B016			

H	Application	Precision finishing	Finishing
	Grade	BXM10	BXM20
Chipbreaker shape	T-CBN	T-CBN	
Cutting conditions	B018		

Reference pages: DDJNR/L: Inserts → B067 -, CBN → B174 -, PCD → B194 -



Screw-on toolholder with 93° approach angle, for positive 55° rhombic inserts, with high pressure coolant capability

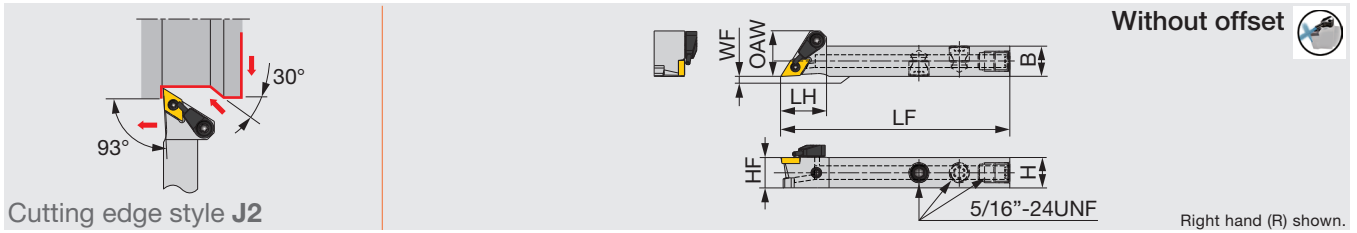

Inch	H	B	LF	LH	HF	WF	OAW	RE**	Insert	Torque
JSDJ2CR/L082-CHP	0.500	0.500	3.344	0.710	0.500	0	0.710	0.008	DC**21.5...	0.89
JSDJ2CR083X-CHP	0.500	0.500	4.750	0.748	0.500	0	0.807	0.008	DC**32.5...	0.89
JSDJ2CR103X-CHP	0.625	0.625	4.750	0.748	0.625	0	0.807	0.008	DC**32.5...	0.89

Metric	H	B	LF	LH	HF	WF	OAW	RE**	Insert	Torque*
JSDJ2CR/L1212F07-CHP	12	12	85	18	12	0	18	0.2	DC**0702...	1.2
JSDJ2CR/L1212F11-CHP	12	12	85	19	12	0	20.5	0.2	DC**11T3...	1.2
JSDJ2CR1212X11-CHP	12	12	120	19	12	0	20.5	0.2	DC**11T3...	1.2
JSDJ2CR1616X11-CHP	16	16	120	19	16	0	20.5	0.2	DC**11T3...	1.2

Torque: Recommended clamping torque: lbs-ft (*N-m)
**RE: Standard corner radius

SPARE PARTS

Designation	Clamping screw	Coolant unit	Wrench1	Coolant plug	Wrench2	DirectJet plug	Wrench3
JSDJ2CR/L082-CHP, JSDJ2CR/L1212F07-CHP	CSTB-2.5	S-CU-CHP	T-8F	-	-	-	-
JSDJ2CR/L1212F11-CHP	CSTB-4SD	S-CU-CHP	T-8F	-	-	-	-
JSDJ2CR**3X-CHP, JSDJ2CR**X11-CHP	CSTB-4SD	S-CU-CHP	T-8F	SR5/16UNFTL360	P-4	SSHM4-6-TB	P-2

INSERT SELECTION

P

Application	Finishing	Finishing to medium cutting	Medium cutting
Grade	NS9530	T9215	T9215
Chipbreaker shape	PSS	PS	PM
Images			
Cutting conditions	B020		

M

Application	Precision finishing	Finishing	Finishing to medium cutting	Medium cutting
Grade	GH330	AH725	AH630	T6130
Chipbreaker shape	W**	PSF	PSS	PM
Images				
Cutting conditions	B022			

K

Application	Finishing to medium cutting
Grade	T515
Chipbreaker shape	CM
Image	
Cutting conditions	B024

N

Application	Precision finishing	Finishing	Medium cutting
Grade	DX120	DX140	KS05F
Chipbreaker shape	T-DIA	with rake T-DIA	AL
Images			
Cutting conditions	B026		

S

Application	Finishing	Finishing to medium cutting
Grade	AH8015	AH8015
Chipbreaker shape	PSS	PS
Images		
Cutting conditions	B028	

H

Application	Precision finishing	Finishing
Grade	BXM10	BXM20
Chipbreaker shape	T-CBN	T-CBN
Images		
Cutting conditions	B030	

Reference pages: JSDJ2CR/L-CHP: Inserts → **B121 -**, CBN → **B184 -**, PCD → **B196 -**
Parts for coolant hose → **C142**

Back-clamp toolholder with 93° approach angle, for positive 55° rhombic inserts

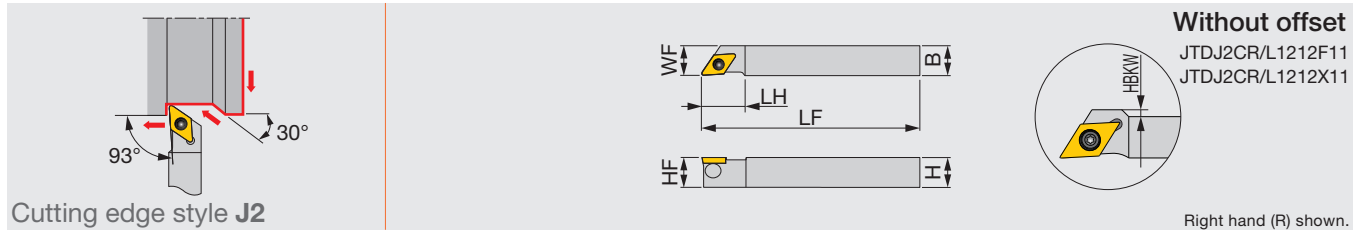

Cutting edge style **J2**

Metric	H	B	LF	LH	HF	WF	HBKW	RE**	Insert	Torque
JTDJ2CR/L1010X07	10	10	120	14	10	10	-	0.2	DC**0702...	0.9
JTDJ2CR/L1212F07	12	12	85	14	12	12	-	0.2	DC**0702...	0.9
JTDJ2CR/L1212X07	12	12	120	14	12	12	-	0.2	DC**0702...	0.9
JTDJ2CR/L1212F11	12	12	85	20	12	12	2	0.2	DC**11T3...	1.2
JTDJ2CR/L1212X11	12	12	120	20	12	12	2	0.2	DC**11T3...	1.2
JTDJ2CR/L1616X11	16	16	120	20	16	16	-	0.2	DC**11T3...	1.2

Torque: Recommended clamping torque: N·m

**RE: Standard corner radius

SPARE PARTS



Designation	Clamp	Clamping screw	Wrench
JTDJ2CR/L**07	JCP-2	JDS-3525	P-2F
JTDJ2CR/L**11	JCP-3	JDS-5040	P-2.5F

INSERT SELECTION

Application	Precision finishing	Finishing	Finishing to medium cutting	Medium cutting
	Grade	SH725	SH725	T9215
Chipbreaker shape	01	JS	PS	PM
Cutting conditions	B020			

Application	Precision finishing	Finishing	Finishing to medium cutting	Medium cutting
	Grade	SH725	SH725	T9215
Chipbreaker shape	01	JS	PS	PM
Cutting conditions	B022			

Application	Finishing to medium cutting
	Grade
Chipbreaker shape	CM
Cutting conditions	B024

Application	Precision finishing	Medium cutting
	Grade	DX120
Chipbreaker shape	T-DIA	with rake AL
Cutting conditions	B026	

Application	Precision finishing	Finishing to medium cutting	
	Grade	BX470	PS
Chipbreaker shape	T-CBN	PS	
Cutting conditions	B028		

Application	Precision finishing	Finishing
	Grade	BXM10
Chipbreaker shape	T-CBN <td>T-CBN </td>	T-CBN
Cutting conditions	B030	

Reference pages: JTDJ2CR/L: Inserts → **B121** -, CBN → **B184** -, PCD → **B196** -



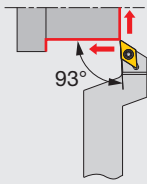

Cutting edge style J

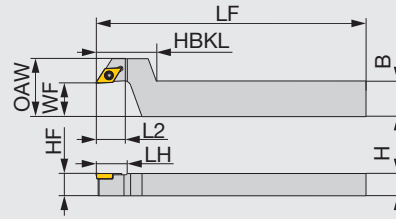

Right hand (R) shown.

Metric	H	B	LF	L2	HBKL	LH	HF	WF	OAW	RE**	Insert	Torque
JSDJCR1016X07-F15	10	16	120	12.5	27	14	10	15	26	0.2	DC**0702...	1.2
JSDJCR1216F07-F15	12	16	85	12.5	27	14	12	15	26	0.2	DC**0702...	1.2
JSDJCR1216X07-F15	12	16	120	12.5	27	14	12	15	26	0.2	DC**0702...	1.2
JSDJCR1216F11-F15	12	16	85	12.5	27	20	12	15	28	0.2	DC**11T3...	1.2
JSDJCR1216X11-F15	12	16	120	12.5	27	20	12	15	28	0.2	DC**11T3...	1.2
JSDJCR1620X11-F15	16	20	120	12.5	27	20	16	15	28	0.2	DC**11T3...	1.2

Torque: Recommended clamping torque: N·m

**RE: Standard corner radius

SPARE PARTS



Designation	Clamping screw	Wrench
JSDJCR**07-F15	CSTB-2.5	T-8F
JSDJCR**11-F15	CSTB-4SD	T-8F

INSERT SELECTION

Application	Precision finishing	Finishing	Finishing to medium cutting	Medium cutting
	Grade	SH725	SH725	T9215
Chipbreaker shape	01	JS	PS	PM
Cutting conditions	B020			

Application	Precision finishing	Finishing	Finishing to medium cutting	Medium cutting
	Grade	SH725	SH725	T9215
Chipbreaker shape	01	JS	PS	PM
Cutting conditions	B022			

Application	Finishing to medium cutting
	Grade
Chipbreaker shape	CM
Cutting conditions	B024

Application	Precision finishing	Medium cutting
	Grade	DX120
Chipbreaker shape	T-DIA	with rake AL
Cutting conditions	B026	

Application	Precision finishing	Finishing to medium cutting
	Grade	BX470
Chipbreaker shape	T-CBN	PS
Cutting conditions	B028	

Application	Precision finishing	Finishing
	Grade	BXM10
Chipbreaker shape	T-CBN	T-CBN
Cutting conditions	B030	

Reference pages: JSDJCR-F: Inserts → B121 -, CBN → B184 -, PCD → B196 -

SDJCR/L

Screw-on toolholder with 93° approach angle, for positive 55° rhombic inserts

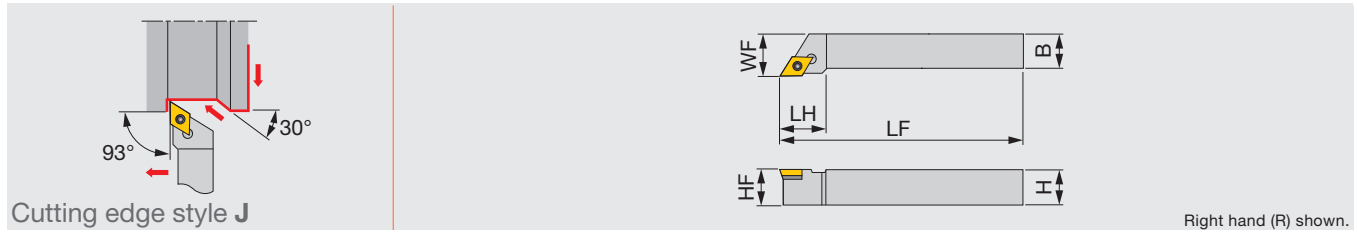

Inch	H	B	LF	LH	HF	WF	RE**	Insert
SDJCR/L 062	0.375	0.375	2.500	0.625	0.375	0.500	0.016	DC**21.5...
SDJCR/L 082	0.500	0.500	3.500	0.625	0.500	0.625	0.016	DC**21.5...
SDJCR/L 083	0.500	0.500	3.500	-	0.500	0.625	0.016	DC**32.5...
SDJCR/L 103	0.625	0.625	4.000	-	0.625	0.750	0.031	DC**32.5...
SDJCR/L 123	0.750	0.750	4.500	-	0.750	1.000	0.031	DC**32.5...
SDJCR/L 163	1.000	1.000	6.000	-	1.000	1.250	0.031	DC**32.5...

Metric	H	B	LF	LH	HF	WF	RE**	Insert
SDJCR1616H11	16	16	100	20	16	20	0.8	DC**11T3...
SDJCR/L2020K11	20	20	125	20.5	20	25	0.8	DC**11T3...
SDJCR/L2525M11	25	25	150	21.5	25	32	0.8	DC**11T3...

**RE: Standard corner radius

SPARE PARTS

Designation	Clamping screw	Shim screw	Shim	Wrench1	Wrench2
SDJCR/L **2	CSTB-2.5	-	-	-	T-8F
SDJCR/L **3, SDJCR/L**11	CSTB-3.5L	DTS5-3.5	SSD32	P-3.5	T-15F

INSERT SELECTION

P	Application	Finishing	Finishing to medium cutting	Medium cutting	
	Grade	NS9530	T9215	T9215	
	Chipbreaker shape	PSS	PS	PM	
Cutting conditions		B020			
M	Application	Precision finishing	Finishing	Finishing to medium cutting	Medium cutting
	Grade	GH330	AH725	AH630	T6130
	Chipbreaker shape	W**	PSF	PSS	PM
Cutting conditions		B022			
K	Application	Finishing to medium cutting			
	Grade	T515			
	Chipbreaker shape	CM			
Cutting conditions		B024			
N	Application	Precision finishing	Finishing	Medium cutting	
	Grade	DX120	DX140	KS05F	
	Chipbreaker shape	T-DIA	with rake T-DIA	AL	
Cutting conditions		B026			
S	Application	Finishing	Finishing to medium cutting		
	Grade	AH8015	AH8015		
	Chipbreaker shape	PSS	PS		
Cutting conditions		B028			
H	Application	Precision finishing	Finishing		
	Grade	BXM10	BXM20		
	Chipbreaker shape	T-CBN	T-CBN		
Cutting conditions		B030			

Reference pages: SDJCR/L: Inserts → B121 -, CBN → B184 -, PCD → B196 -

Grade
Insert
Toolholder
Ext. Toolholder
Int. Toolholder
Threading
Grooving
Miniature Tool
Milling Cutter
Endmill
Drilling Tool
Tooling System
User's Guide
Index



Lever-lock toolholder with 93° approach angle, for negative triangular inserts

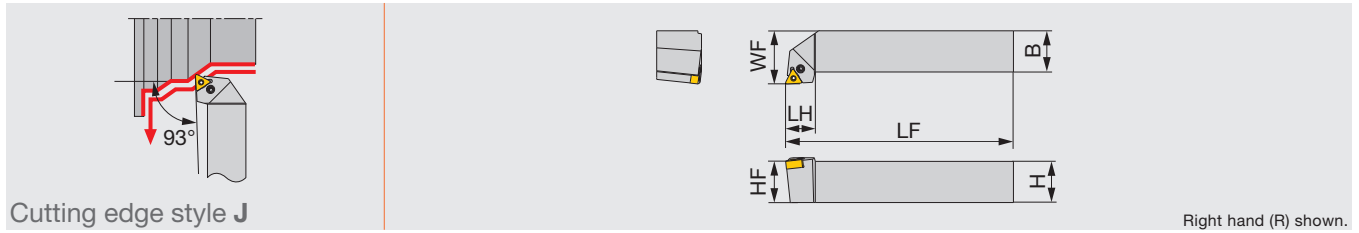

Right hand (R) shown.

Metric	H	B	LF	LH	HF	WF	RE**	Insert	Torque
PTJNR/L2525M1104	25	25	150	18	25	32	0.8	TN**1104...	2

Torque: Recommended clamping torque: N·m
 **RE: Standard corner radius

SPARE PARTS

Designation	Clamping screw	Wrench	Lever
PTJNR/L2525M1104	LCS23A	P-2.5	LCL23

INSERT SELECTION

Application	Finishing	Medium cutting
	Grade	T9215
Chipbreaker shape	TSF	TM
Cutting conditions	B008	

Application	Finishing	Medium cutting
	Grade	T6120
Chipbreaker shape	SS	SM
Cutting conditions	B010	

Reference pages: PTJNR/L-Eco: Inserts → **B086** -

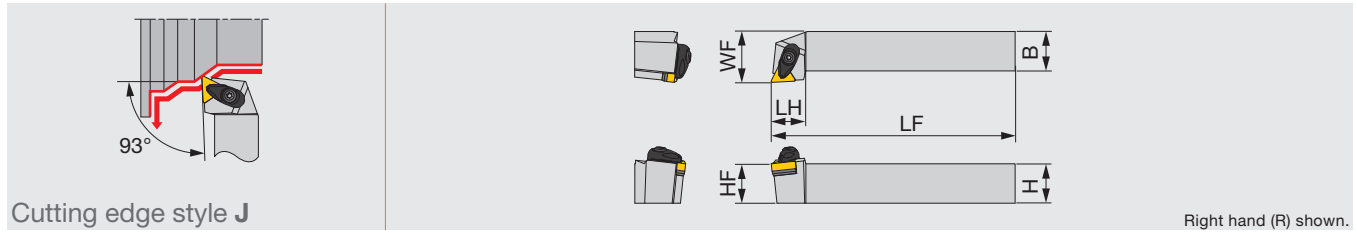

Cutting edge style J

Right hand (R) shown.

Inch	H	B	LF	LH	HF	WF	RE**	Insert	Torque
ATJNR/L123-A	0.750	0.750	4.500	0.875	0.750	1.000	0.031	TN**33...	2.2
ATJNR/L163-A	1.000	1.000	6.000	0.875	1.000	1.250	0.031	TN**33...	2.2

Metric	H	B	LF	LH	HF	WF	RE**	Insert	Torque*
ATJNR/L2020K16-A	20	20	125	22	20	25	0.8	TN**1604...	3
ATJNR/L2525M16-A	25	25	150	22	25	32	0.8	TN**1604...	3

Torque: Recommended clamping torque: lbs-ft (*N·m) **RE: Standard corner radius

SPARE PARTS							
Designation	Clamp	Clamp screw	Spring	Spring pin	Shim	Shim screw	Wrench
ATJNR/L**3-A, 16-A	ACP3S	ACS-5W	BP-7	SP-2.5	AST322	CSTB-3.5	T-15F

INSERT SELECTION

Application	Precision finishing	Finishing	Medium cutting	Medium to heavy cutting
	Grade	NS9530	GT9530	T9215
Chipbreaker shape	TF	TSF	TM	TH
Cutting conditions	B008			

Application	Finishing	Medium cutting
	Grade	T6120
Chipbreaker shape	SF	SM
Cutting conditions	B010	

Application	Finishing	Medium cutting	Medium to heavy cutting
	Grade	T515	T515
Chipbreaker shape	All-round	All-round	All-round
Cutting conditions	B012		

Application	Precision finishing	Finishing	Medium cutting
	Grade	DX120	DX140
Chipbreaker shape	T-DIA	with rake T-DIA	P
Cutting conditions	B014		

Application	Precision finishing	Finishing	Medium cutting
	Grade	BX470	AH8005
Chipbreaker shape	T-CBN	HRF	HRM
Cutting conditions	B016		

Application	Precision finishing	Finishing
	Grade	BXM10
Chipbreaker shape	T-CBN	T-CBN
Cutting conditions	B018	

Reference pages: ATJNR/L: Inserts → B086 -, CBN → B178 -, PCD → B194 -



WTJNR/L

Wedge-on toolholder with 93° approach angle, for negative 60° triangular inserts

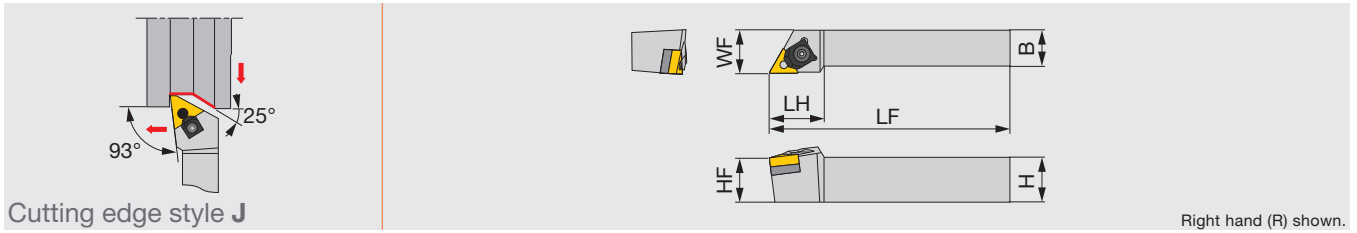

Right hand (R) shown.

Metric	H	B	LF	LH	HF	WF	RE**	Insert
WTJNR2020	20	20	125	31	20	25	0.8	TN**1604...
WTJNR/L2525M3	25	25	150	31	25	32	0.8	TN**1604...

**RE: Standard corner radius

SPARE PARTS

Designation	Clamp	E-ring	Nut	Pin	Clamping screw	Shim	Wrench
WTJNR2020	WCW3	5103-25	WCN3S	WCP3S	WCS3	WST33	P-3
WTJNR/L2525M3	WCW3	5103-25	WCN3	WCP3S	WCS3	WST33	P-3

INSERT SELECTION

Application	Precision finishing	Finishing	Medium cutting	Medium to heavy cutting
Grade	NS9530	GT9530	T9215	T9215
Chipbreaker shape	TF	TSF	TM	TH
Cutting conditions	B008			

Application	Finishing	Medium cutting
Grade	T6120	T6130
Chipbreaker shape	SF	SM
Cutting conditions	B010	

Application	Finishing	Medium cutting	Medium to heavy cutting
Grade	T515	T515	T515
Chipbreaker shape	All-round	All-round	All-round
Cutting conditions	B012		

Application	Precision finishing	Finishing	Medium cutting
Grade	DX120	DX140	TH10
Chipbreaker shape	T-DIA	with rake T-DIA	P
Cutting conditions	B014		

Application	Precision finishing	Finishing	Medium cutting
Grade	BX470	AH8005	AH8005
Chipbreaker shape	T-CBN	HRF	HRM
Cutting conditions	B016		

Application	Precision finishing	Finishing
Grade	BXM10	BXM20
Chipbreaker shape	T-CBN	T-CBN
Cutting conditions	B018	

Reference pages: WTJNR/L: Inserts → B086 -, CBN → B178 -, PCD → B194 -

Double-clamp toolholder with 93° approach angle, for negative 35° rhombic inserts

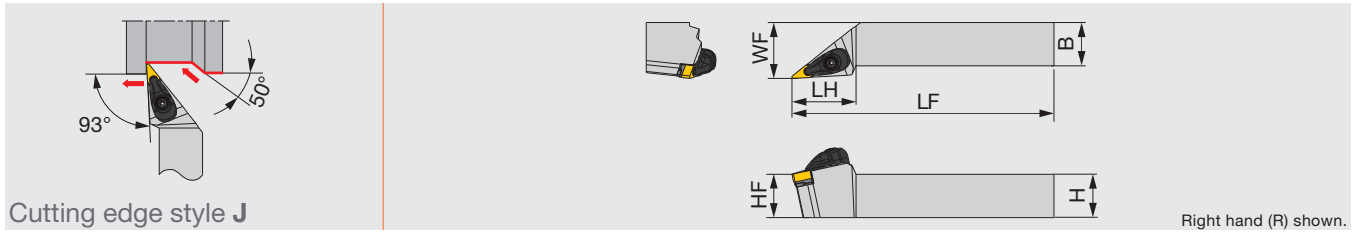

Inch	H	B	LF	LH	HF	WF	RE**	Insert	Torque
AVJNR/L122.33-A	0.750	0.750	4.500	1.500	0.750	1.000	0.031	VN**2.33**E...	2.2
AVJNR/L162.33-A	1.000	1.000	6.000	1.500	1.000	1.250	0.031	VN**2.33**E...	2.2
Metric	H	B	LF	LH	HF	WF	RE**	Insert	Torque*
AVJNR/L2020K1204-A	20	20	125	37	20	25	0.8	VN**1204...	3
AVJNR/L2525M1204-A	25	25	150	37	25	32	0.8	VN**1204...	3

Torque: Recommended clamping torque: lbs-ft (**N·m) **RE: Standard corner radius

SPARE PARTS							
Designation	Clamp	Clamp screw	Spring	Spring pin	Shim	Shim screw	Wrench
AVJNR/L**-A	ACP3L-E	ACS-5W	BP-7	SP-2.5	ASV222	CSTB-3.0	T-15F

INSERT SELECTION

P	Application	Finishing	Medium cutting
	Grade	T9215	T9215
Chipbreaker shape	TSF	TM	
Cutting conditions	B008		

M	Application	Finishing	Medium cutting
	Grade	T6120	T6130
Chipbreaker shape	SS	SM	
Cutting conditions	B010		

Reference pages: AVJNR/L-Eco: Inserts → **B097** -
Parts for coolant hose → **C142**

Lever-lock toolholder with 93° approach angle, for negative 35° rhombic inserts, with high pressure coolant capability

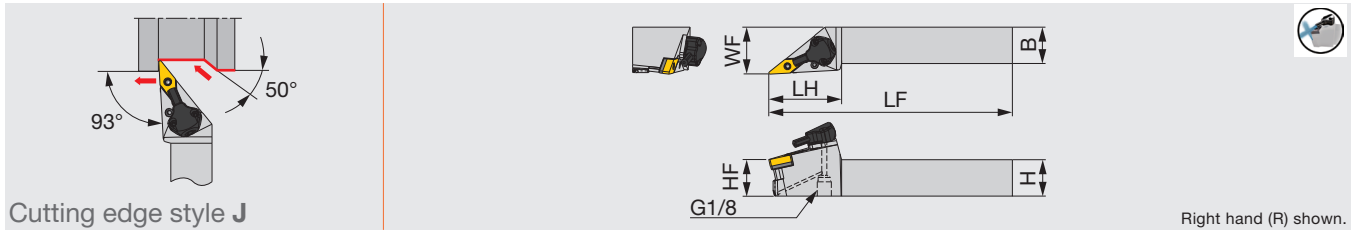

Right hand (R) shown.

Inch	H	B	LF	LH	HF	WF	RE**	Insert	Torque
PVJNR/L122.33-CHP	0.750	0.750	4.500	1.969	0.750	1.250	0.031	VN**2.33**E...	1.5
PVJNR/L162.33-CHP	1.000	1.000	6.000	1.969	1.000	1.250	0.8	VN**2.33**E...	1.5

Metric	H	B	LF	LH	HF	WF	RE**	Insert	Torque*
PVJNR/L2020K1204-CHP	20	20	125	50	20	32	0.8	VN**1204...	2
PVJNR/L2525M1204-CHP	25	25	150	50	25	32	0.8	VN**1204...	2

Torque: Recommended clamping torque: lbs-ft (*N-m) **RE: Standard corner radius

SPARE PARTS

Designation	Shim	Clamping screw	Wrench1	Spring pin	Lever
PVJNR/L*-CHP	LSV212	LCS3V	P-2.5	LSP3	LCL3V

SPARE PARTS

Designation	Coolant unit	Mounting screw	Wrench2	O-ring	Coolant screw	Wrench3
PVJNR/L*-CHP	CU-V-CHP	SRM3	T-8F	OR6.4X0.9N	SRM4X4TL360	P-2

ISO E^{CO}TURN
PVJNR/L-Eco

Lever-lock toolholder with 93° approach angle, for negative 35° rhombic inserts

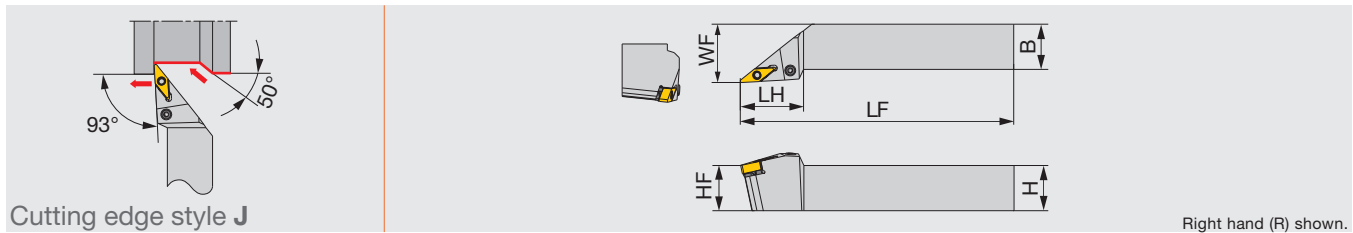

Right hand (R) shown.

Metric	H	B	LF	LH	HF	WF	RE**	Insert	Torque
PVJNR/L2020K1204	20	20	125	35	20	25	0.8	VN**1204...	2
PVJNR/L2525M1204	25	25	150	35	25	32	0.8	VN**1204...	2

Torque: Recommended clamping torque: N-m **RE: Standard corner radius

SPARE PARTS

Designation	Shim	Clamping screw	Wrench	Spring pin	Lever
PVJNR/L**1204	LSV212	LCS3V	P-2.5	LSP3	LCL3V

INSERT SELECTION

P

Application	Finishing	Medium cutting
Grade	T9215	T9215
Chipbreaker shape	TSF	TM
Chipbreaker shape		
Cutting conditions	B008	

M

Application	Finishing	Medium cutting
Grade	T6120	T6130
Chipbreaker shape	SS	SM
Chipbreaker shape		
Cutting conditions	B010	

Reference pages: PVJNR/L-CHP, PVJNR/L-Eco: Inserts → **B097 -**
Parts for coolant hose → **C142**

Screw-on toolholder with 93° approach angle, for VXGU inserts

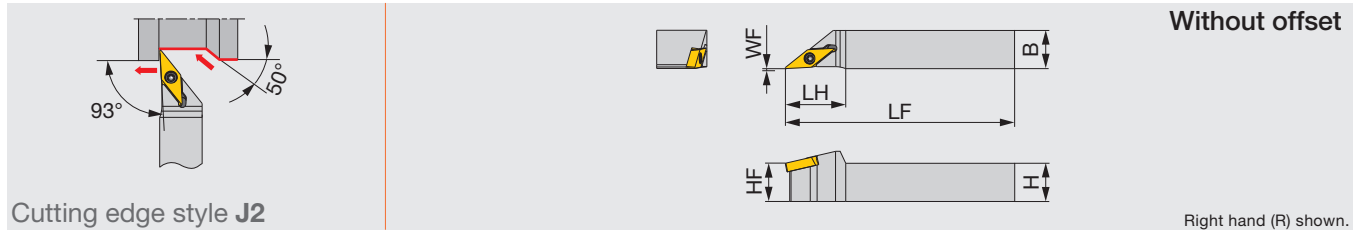

Inch	H	B	LF	LH	HF	WF	RE**	Insert	Torque
JSVJ2XR/L067	0.375	0.375	4.750	0.669	0.375	0	0.008	VXGU09T2**/L/R...	0.66
JSVJ2XR/L087	0.500	0.500	4.750	0.748	0.500	0	0.008	VXGU09T2**/L/R...	0.66
JSVJ2XR/L107	0.625	0.625	4.750	0.748	0.625	0	0.008	VXGU09T2**/L/R...	0.66

Metric	H	B	LF	LH	HF	WF	RE**	Insert	Torque*
JSVJ2XR/L1010X09	10	10	120	17	10	0	0.2	VXGU09T2**/L/R...	0.9
JSVJ2XR/L1212F09	12	12	85	19	12	0	0.2	VXGU09T2**/L/R...	0.9
JSVJ2XR/L1212X09	12	12	120	19	12	0	0.2	VXGU09T2**/L/R...	0.9
JSVJ2XR/L1616X09	16	16	120	19	16	0	0.2	VXGU09T2**/L/R...	0.9
JSVJ2XR/L2020H09	20	20	100	19	20	0	0.2	VXGU09T2**/L/R...	0.9

Torque: Recommended clamping torque: lbs-ft (*N-m) **RE: Standard corner radius
Use right-hand toolholders (R) with left-hand inserts (L); and left-hand toolholders (L) with right-hand inserts (R).

SPARE PARTS

Designation	Clamping screw	Wrench
JSVJ2XR/L...	SR34-508	T-7F

Screw-on toolholder with 93° approach angle, for VXGU inserts

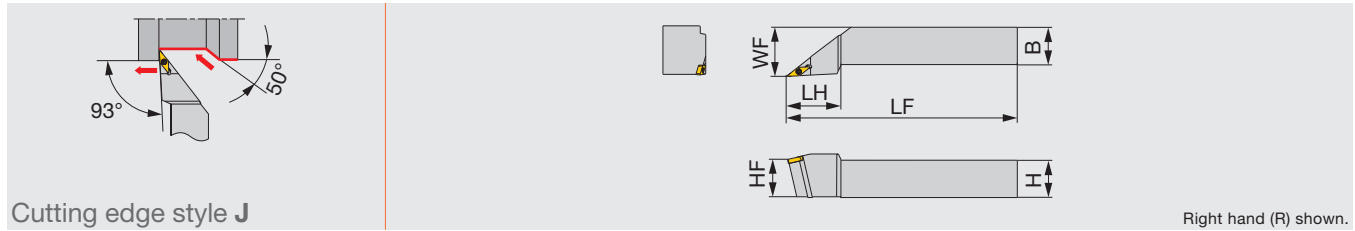

Inch	H	B	LF	LH	HF	WF	RE**	Insert	Torque
JSVJXR/127	0.750	0.750	4.500	1.500	0.750	1.000	0.008	VXGU09T2**/L/R...	0.66
JSVJXR/167	1.000	1.000	6.000	1.500	1.000	1.250	0.008	VXGU09T2**/L/R...	0.66

Metric	H	B	LF	LH	HF	WF	RE**	Insert	Torque*
JSVJXR/L2020K09	20	20	125	35	20	25	0.4	VXGU09T2**/L/R...	0.9
JSVJXR/L2525M09	25	25	150	35	25	32	0.4	VXGU09T2**/L/R...	0.9

Torque: Recommended clamping torque: lbs-ft (*N-m) **RE: Standard corner radius
Use right-hand toolholders (R) with left-hand inserts (L); and left-hand toolholders (L) with right-hand inserts (R).

SPARE PARTS

Designation	Clamping screw	Wrench
JSVJXR/L...	SR34-508	T-7F

INSERT SELECTION

P	Application	Finishing	M	Application	Finishing
	Grade	SH725		Grade	SH725
	Chipbreaker shape	JRP		Chipbreaker shape	JRP
	Cutting conditions	C143		Cutting conditions	C143

Reference pages: JSVJ2XR/L, JSVJXR/L: Inserts → **B158**, Standard cutting conditions → **C143**

Screw-on toolholder with 93° approach angle, for VXGU inserts, with high pressure coolant capability

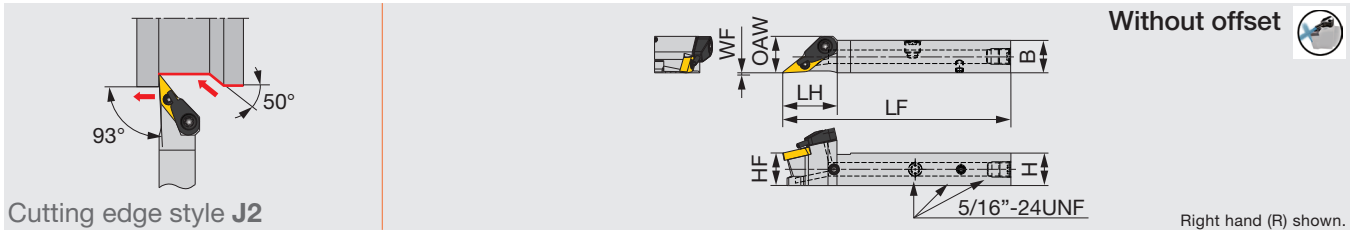

Inch	H	B	LF	LH	HF	WF	OAW	RE**	Insert	Torque
JSVJ2XR/L087-CHP	0.500	0.500	4.750	0.748	0.500	0	0.535	0.008	VXGU09T2**L/R...	0.66
JSVJ2XR087X-CHP ⁽¹⁾	0.500	0.500	4.750	0.768	0.500	0	0.528	0.008	VXGU09T2**L...	0.66
JSVJ2XR107X-CHP ⁽¹⁾	0.625	0.625	4.750	0.768	0.625	0	0.625	0.008	VXGU09T2**L...	0.66

Metric	H	B	LF	LH	HF	WF	OAW	RE**	Insert	Torque*
JSVJ2XR/L1212F09-CHP	12	12	85	20	12	0	13.5	0.2	VXGU09T2**L/R...	0.9
JSVJ2XR1212X09-CHP ⁽¹⁾	12	12	120	19.5	12	0	13.4	0.2	VXGU09T2**L...	0.9
JSVJ2XR1616X09-CHP ⁽¹⁾	16	16	120	19.5	16	0	16	0.2	VXGU09T2**L...	0.9

Torque: Recommended clamping torque: lbs-ft (*N-m) **RE: Standard corner radius
Use right-hand toolholders (R) with left-hand inserts (L); and left-hand toolholders (L) with right-hand inserts (R).
(1) Compatible to the direct internal coolant supply system without the use of external coolant hose.

SPARE PARTS

Designation	Clamping screw	Coolant unit	Wrench
JSVJ2XR/L*-CHP	SR34-508	S-CU-CHP	T-7F

MINIFORCE
JPVJ2XR/L

Back-clamp toolholder with 93° approach angle, for VXGU inserts

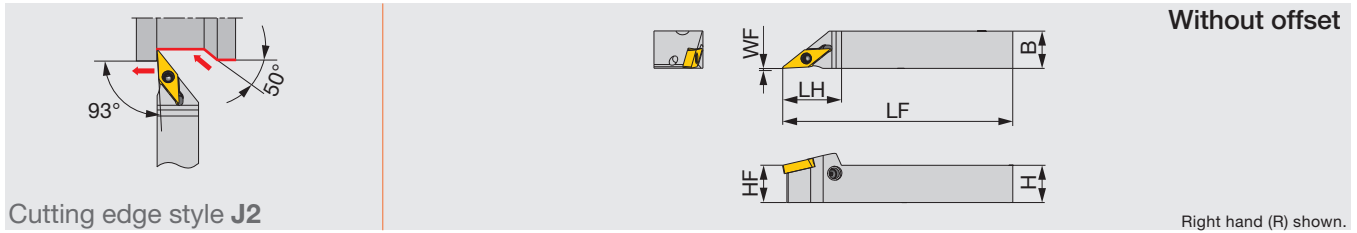

Inch	H	B	LF	LH	HF	WF	RE**	Insert	Torque
JPVJ2XR/L067	0.375	0.375	4.750	0.669	0.375	0	0.008	VXGU09T2**L/R...	0.66
JPVJ2XR/L087	0.500	0.500	4.750	0.748	0.500	0	0.008	VXGU09T2**L/R...	0.66
JPVJ2XR/L107	0.625	0.625	4.750	0.748	0.625	0	0.008	VXGU09T2**L/R...	0.66

Metric	H	B	LF	LH	HF	WF	RE**	Insert	Torque*
JPVJ2XR/L1010X09	10	10	120	19	10	0	0.2	VXGU09T2**L/R...	0.9
JPVJ2XR/L1212F09	12	12	85	19	12	0	0.2	VXGU09T2**L/R...	0.9
JPVJ2XR/L1212X09	12	12	120	19	12	0	0.2	VXGU09T2**L/R...	0.9
JPVJ2XR/L1616X09	16	16	120	19	16	0	0.2	VXGU09T2**L/R...	0.9

Torque: Recommended clamping torque: lbs-ft (*N-m) **RE: Standard corner radius
Use right-hand toolholders (R) with left-hand inserts (L); and left-hand toolholders (L) with right-hand inserts (R).

SPARE PARTS

Designation	Lever	Pin	Clamping screw	Wrench
JPVJ2XR/L...	SLLV-1	SL-PI-2	SR10400611	HW2.0/5RED

Reference pages: JSVJ2XR/L-CHP, JPVJ2XR/L: Inserts → **B158**
Standard cutting conditions → **C143**

Screw-on stepped-head toolholder with 93° approach angle, for VXGU inserts

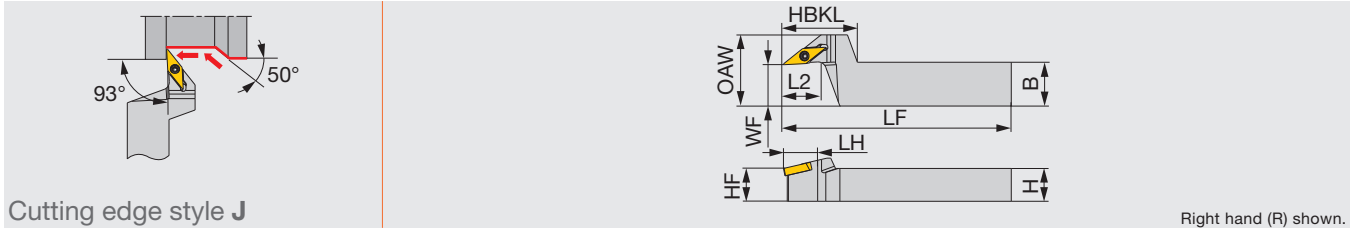

Cutting edge style J

Right hand (R) shown.

Inch	H	B	LF	L2	HBKL	LH	HF	WF	OAW	RE**	Insert	Torque
JSVJXR087-F10	0.500	0.625	4.750	0.500	1.125	0.750	0.500	0.625	1	0.008	VXGU09T2**L...	0.66
JSVJXR107-F10	0.625	0.750	4.750	0.500	1.125	0.750	0.500	0.625	1	0.008	VXGU09T2**L...	0.66
Metric	H	B	LF	L2	HBKL	LH	HF	WF	OAW	RE**	Insert	Torque*
JSVJXR1016X09-F15	10	16	120	12	27	19	10	15	26	0.2	VXGU09T2**L...	0.9
JSVJXR1216F09-F15	12	16	85	12	27	19	12	15	26	0.2	VXGU09T2**L...	0.9
JSVJXR1216X09-F15	12	16	120	12	27	19	12	15	26	0.2	VXGU09T2**L...	0.9
JSVJXR1620X09-F15	16	20	120	12	27	19	16	15	26	0.2	VXGU09T2**L...	0.9

Torque: Recommended clamping torque: lbs-ft (**N-m) **RE: Standard corner radius
Use right-hand toolholders (R) with left-hand inserts (L).

SPARE PARTS

Designation	Clamping screw	Wrench
JSVJXR**-F...	SR34-508	T-7F

INSERT SELECTION

P	Application	Finishing	M	Application	Finishing
	Grade	SH725		Grade	SH725
	Chipbreaker shape	JRP		Chipbreaker shape	JRP
	Cutting conditions	C143		Cutting conditions	C143

Reference pages: JSVJXR-F: Inserts → **B158**
Standard cutting conditions → **C143**

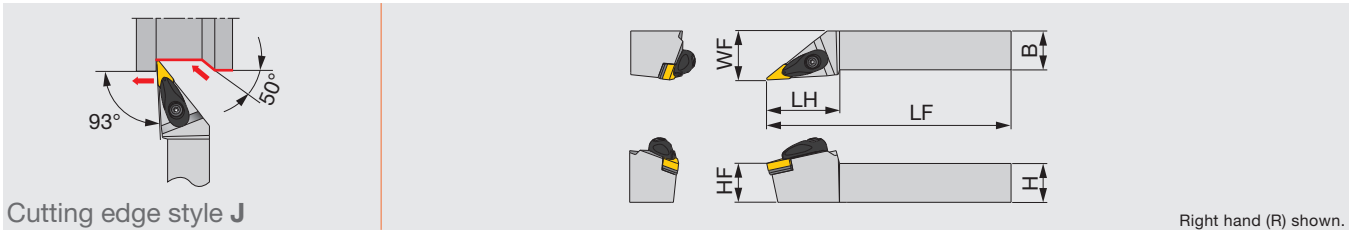

Cutting edge style J

Right hand (R) shown.

Inch	H	B	LF	LH	HF	WF	RE**	Insert	Torque
AVJNR/L123-A	0.750	0.750	4.500	1.750	0.750	1.000	0.031	V/YN**33...	2.2
AVJNR/L163-A	1.000	1.000	6.000	1.870	1.000	1.250	0.031	V/YN**33...	2.2

Metric	H	B	LF	LH	HF	WF	RE**	Insert	Torque*
AVJNR/L2020K16-A	20	20	125	43	20	25	0.8	V/YN**1604...	3
AVJNR/L2525M16-A	25	25	150	46	25	32	0.8	V/YN**1604...	3

Torque: Recommended clamping torque: lbs-ft (*N-m)

**RE: Standard corner radius

SPARE PARTS

Designation	Clamp	Clamp screw	Spring	Spring pin	Shim	Shim screw	Wrench
AVJNR/L**3-A, 16-A	ACP3L	ACS-5W	BP-7	SP-2.5	ASV322	CSTB-3.5	T-15F

INSERT SELECTION

Application	Precision finishing	Finishing	Medium cutting
	Grade	NS9530	GT9530
Chipbreaker shape	TF	TSF	TM
Cutting conditions	B008		

Application	Finishing	Medium cutting
	Grade	T6120
Chipbreaker shape	SF	SM
Cutting conditions	B010	

Application	Finishing	Medium cutting	Medium to heavy cutting
	Grade	T515	T515
Chipbreaker shape	All-round	All-round	All-round
Cutting conditions	B012		

Application	Precision finishing
	Grade
Chipbreaker shape	T-DIA with rake
Cutting conditions	B014

Application	Precision finishing	Finishing	Medium cutting
	Grade	BX480	AH8005
Chipbreaker shape	T-CBN	HRF	HRM
Cutting conditions	B016		

Application	Precision finishing	Finishing
	Grade	BXM10
Chipbreaker shape	T-CBN	T-CBN
Cutting conditions	B018	

Reference pages: AVJNR/L: Inserts → B096 -, B109, CBN → B180, PCD → B194

Lever-lock toolholder with 93° approach angle, for negative 35° and 25° rhombic inserts, with high pressure coolant capability

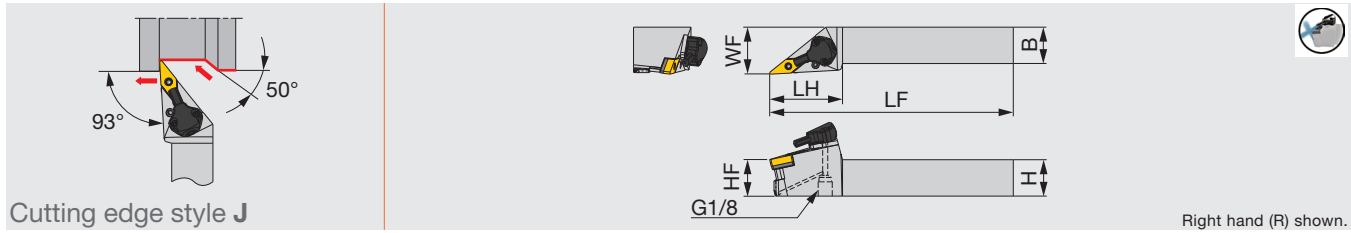

Inch	H	B	LF	LH	HF	WF	RE**	Insert	Torque
PVJNR/L123-CHP	0.750	0.750	4.500	1.969	0.750	1.250	0.031	V/YN**33...	1.48
PVJNR/L163-CHP	1.000	1.000	6.000	1.969	1.000	1.250	0.031	V/YN**33...	1.48

Metric	H	B	LF	LH	HF	WF	RE**	Insert	Torque*
PVJNR/L2020K16-CHP	20	20	125	50	20	32	0.8	V/YN**1604...	2
PVJNR/L2525M16-CHP	25	25	150	50	25	32	0.8	V/YN**1604...	2

Torque: Recommended clamping torque: lbs-ft (*N-m) **RE: Standard corner radius

SPARE PARTS

Designation	Shim	Clamping screw	Wrench1	Spring pin	Lever
PVJNR/L*-CHP	LSV317	LCS3V	P-2.5	LSP3	LCL3V

SPARE PARTS

Designation	Coolant unit	Mounting screw	Wrench2	O-ring	Coolant screw	Wrench3
PVJNR/L*-CHP	CU-V-CHP	SRM3	T-8F	OR6.4X0.9N	SRM4X4TL360	P-2

INSERT SELECTION

Application	Precision finishing	Finishing	Medium cutting
	Grade	NS9530	GT9530
Chipbreaker shape	TF	TSF	TM
Cutting conditions	B008		

Application	Finishing	Medium cutting
	Grade	T6120
Chipbreaker shape	SF	SM
Cutting conditions	B010	

Application	Finishing	Medium cutting	Medium to heavy cutting
	Grade	T515	T515
Chipbreaker shape	All-round	All-round	All-round
Cutting conditions	B012		

Application	Precision finishing
	Grade
Chipbreaker shape	T-DIA <small>with rake</small>
Cutting conditions	B014

Application	Precision finishing	Finishing	Medium cutting
	Grade	BX480	AH8005
Chipbreaker shape	T-CBN	HRF	HRM
Cutting conditions	B016		

Application	Precision finishing	Finishing
	Grade	BXM10
Chipbreaker shape	T-CBN	T-CBN
Cutting conditions	B018	

Reference pages: PVJNR/L-CHP: Inserts → **B096 -**, **B109**, CBN → **B180**, PCD → **B194**
 Parts for coolant hose → **C142**



Lever-lock toolholder with TungCap connection, with 93° approach angle, for negative 35° and 25° inserts, with high pressure coolant capability

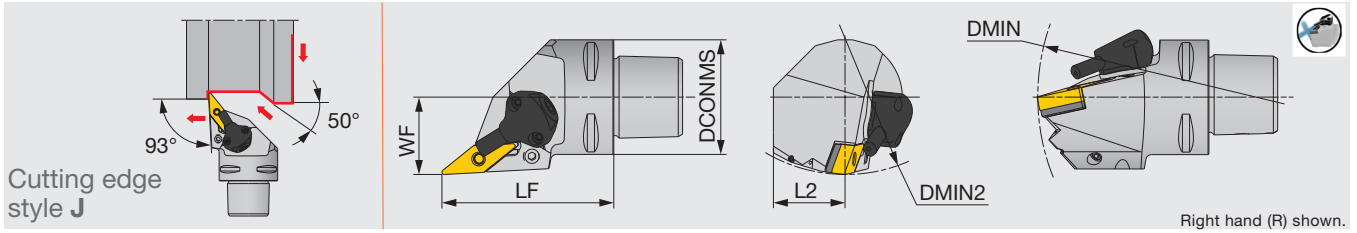

Inch	DCONMS	LF	L2	WF	DMIN	DMIN2	RE**	Insert
C4PVJNR/L27060-1204-CHP	1.575	2.362	0.787	1.063	5.512	3.543	0.031	VN**2.33**E...
C4PVJNR/L27060-16-CHP	1.575	2.362	-	1.063	5.512	4.331	0.031	V/YN**33...
C6PVJNR/L45065-1204-CHP	2.480	2.559	1.240	1.772	7.480	3.189	0.031	VN**2.33**E...
C6PVJNR/L45065-16-CHP	2.480	2.559	-	1.772	7.480	3.189	0.031	V/YN**33...

Metric	DCONMS	LF	L2	WF	DMIN	DMIN2	RE**	Insert
C4PVJNR/L27060-1204-CHP	40	60	20	27	140	90	0.8	VN**1204...
C4PVJNR/L27060-16-CHP	40	60	-	27	140	110	0.8	V/YN**1604...
C6PVJNR/L45065-1204-CHP	63	65	31.5	45	190	81	0.8	VN**1204...
C6PVJNR/L45065-16-CHP	63	65	-	45	190	81	0.8	V/YN**1604...

Applicable for 14 MPa coolant
**RE: Standard corner radius

SPARE PARTS

Designation	Shim	Clamping screw	Wrench1	Wrench2	Spring pin	Lever
C*PVJNR/L**-1204-CHP	LSV212	LCS3V	P-2.5	P-3	LSP3	LCL3V
C*PVJNR/L**-16-CHP	LSV317	LCS3V	P-2.5	-	LSP3	LCL3V

SPARE PARTS

Designation	Coolant unit	Mounting screw	Wrench3	O-ring
C*PVJNR/L**-CHP	CU-V-CHP	SRM3	T-8F	OR6.4X0.9N

INSERT SELECTION

P

Application	Precision finishing	Finishing	Medium cutting
Grade	NS9530	GT9530	T9215
Chipbreaker shape	TF	TSF	TM
Cutting conditions	B008		

M

Application	Finishing	Medium cutting
Grade	T6120	T6130
Chipbreaker shape	SF	SM
Cutting conditions	B010	

K

Application	Finishing	Medium cutting	Medium to heavy cutting
Grade	T515	T515	T515
Chipbreaker shape	All-round	All-round	All-round
Cutting conditions	B012		

N

Application	Precision finishing
Grade	DX120
Chipbreaker shape	T-DIA <small>with rake</small>
Cutting conditions	B014

S

Application	Precision finishing	Finishing	Medium cutting
Grade	BX470	AH8005	AH8005
Chipbreaker shape	T-CBN	HRF	HRM
Cutting conditions	B016		

H

Application	Precision finishing	Finishing
Grade	BXM10	BXM20
Chipbreaker shape	T-CBN	T-CBN
Cutting conditions	B018	

Reference pages: C-PVJNR/L-CHP: Insert → **B096 -**, **B109**, CBN → **B180**, PCD → **B194**
Parts for coolant hose → **C142**

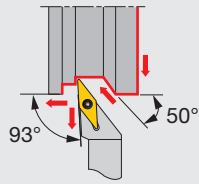

Cutting edge style J

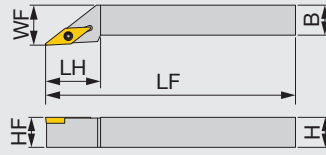

Right hand (R) shown.

Inch	H	B	LF	LH	HF	WF	RE**	Insert	Torque
SVJBR/L122	0.750	0.750	4.500	1.180	0.750	1.000	0.016	VB**22...	0.89
SVJBR/L123	0.750	0.750	4.500	1.180	0.750	1.000	0.032	VB**33...	0.89
SVJBR/L163	1.000	1.000	5.000	1.500	1.000	1.250	0.032	VB**33...	0.89

Torque: Recommended clamping torque: lbs-ft
**RE: Standard corner radius

SPARE PARTS



Designation	Clamping screw	Wrench
SVJBR/L122	CSTB-2.5	T-8F
SVJBR/L123, 163	CSTB-3.5	T-15F

INSERT SELECTION

Application	Finish cutting	Medium to finish cutting	Medium to finish cutting
	SH725	AH725	SH725
Grade	JS	JS	J10
Chipbreaker shape			
Cutting conditions	G068		

Application	Finish cutting	Medium to finish cutting	Medium to finish cutting
	SH725	AH725	SH725
Grade	JS	JS	J10
Chipbreaker shape			
Cutting conditions	G068		

Application	Medium to finish cutting
	T515
Grade	CM
Chipbreaker shape	
Cutting conditions	B024

Application	Finish cutting	Medium to finish cutting
	SH725	AH725
Grade	JS	JS
Chipbreaker shape		
Cutting conditions	G068	

Application	Precision finishing	Finish cutting
	BXM10	BXM10
Grade	T-CBN	T-CBN
Chipbreaker shape		
Cutting conditions	B030	

Screw-on toolholder with 93° approach angle, for positive 35° rhombic inserts

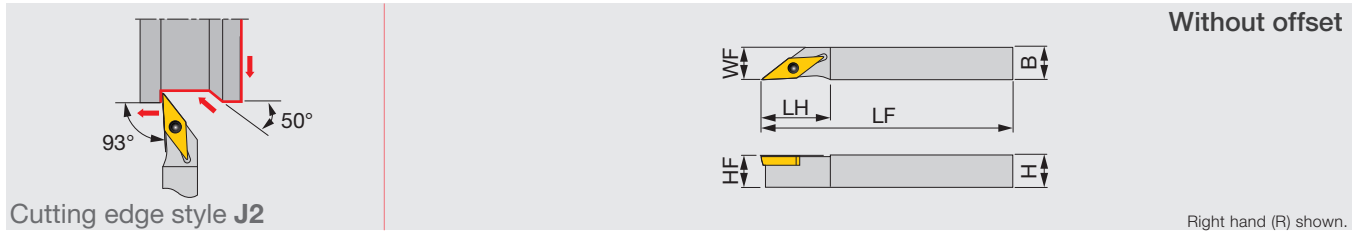

Inch	H	B	LF	LH	HF	WF	RE**	Insert	Torque
JSVJ2BR/L062	0.375	0.375	5.000	0.813	0.375	0.375	0.008	VB**22...	0.89
JSVJ2BR/L082	0.500	0.500	5.000	0.813	0.500	0.500	0.008	VB**22...	0.89
JSVJ2BR/L102	0.625	0.625	5.000	0.813	0.625	0.625	0.008	VB**22...	0.89

Metric	H	B	LF	LH	HF	WF	RE**	Insert	Torque*
JSVJ2BR/L1010X11	10	10	120	21	10	10	0.2	VB**1103...	1.2
JSVJ2BR/L1212F11	12	12	85	21	12	12	0.2	VB**1103...	1.2
JSVJ2BR/L1212X11	12	12	120	21	12	12	0.2	VB**1103...	1.2
JSVJ2BR/L1616X11	16	16	120	21	16	16	0.2	VB**1103...	1.2

Torque: Recommended clamping torque: lbs-ft (*N-m)
 **RE: Standard corner radius

SPARE PARTS

Designation	Clamping screw	Wrench
JSVJ2BR/L...	CSTB-2.5	T-8F

INSERT SELECTION

P	Application	Finish cutting	Medium to finish cutting	Medium to finish cutting
	Grade	SH725	AH725	SH725
Chipbreaker shape	JS	JS	J10	
Cutting conditions	G068			

M	Application	Finish cutting	Medium to finish cutting	Medium to finish cutting
	Grade	SH725	AH725	SH725
Chipbreaker shape	JS	JS	J10	
Cutting conditions	G068			

K	Application	Medium to finish cutting
	Grade	T515
Chipbreaker shape	CM	
Cutting conditions	B024	

S	Application	Finish cutting	Medium to finish cutting
	Grade	SH725	AH725
Chipbreaker shape	JS	JS	
Cutting conditions	G068		

H	Application	Precision finishing	Finish cutting
	Grade	BXM10	BXM10
Chipbreaker shape	T-CBN	T-CBN	
Cutting conditions	B030		

Reference pages: JSVJ2BR/L: Inserts → B152 -, CBN → B191 -

Screw-on toolholder with 93° approach angle, for positive 35° rhombic inserts, with high pressure coolant capability

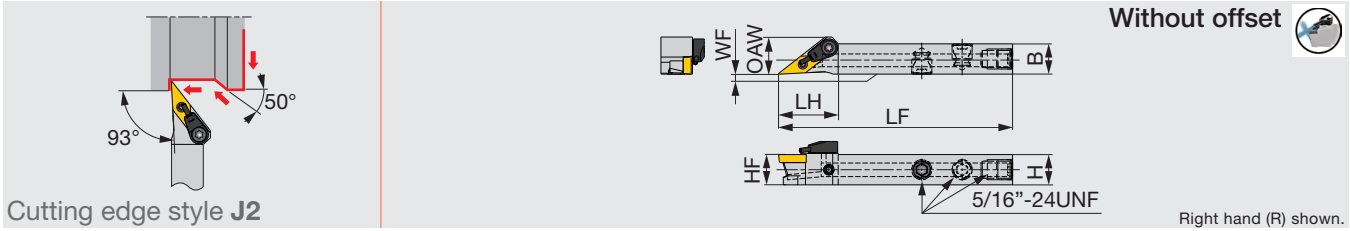

Inch	H	B	LF	LH	HF	WF	OAW	RE**	Insert	Torque
JSVJ2BR/L082-CHP	0.500	0.500	3.344	0.930	0.500	0	0.610	0.008	VB**22...	0.89
JSVJ2BR082X-CHP	0.500	0.500	4.750	0.929	0.500	0	0.575	0.008	VB**22...	0.89
JSVJ2BR102X-CHP	0.625	0.625	4.750	0.929	0.625	0	0.625	0.008	VB**22...	0.89

Metric	H	B	LF	LH	HF	WF	OAW	RE**	Insert	Torque*
JSVJ2BR/L1212F11-CHP	12	12	85	23.6	12	0	14.7	0.2	VB**1103...	1.2
JSVJ2BR1212X11-CHP	12	12	120	23.6	12	0	14.7	0.2	VB**1103...	1.2
JSVJ2BR1616X11-CHP	16	16	120	23.6	16	0	16	0.2	VB**1103...	1.2

Torque: Recommended clamping torque: lbs-ft (*N-m)
 **RE: Standard corner radius

SPARE PARTS

Designation	Clamping screw	Coolant unit	Wrench	Coolant plug	Wrench	DirectJet plug	Wrench
JSVJ2BR/L082-CHP JSVJ2BR/L1212F11-CHP	CSTB-2.5	S-CU-CHP	T-8F	-	-	-	-
JSVJ2BR**2X-CHP JSVJ2BR**X11-CHP	CSTB-2.5	S-CU-CHP	T-8F	SR5/16UNFTL360	P-4	SSHM4-6-TB	P-2

INSERT SELECTION

P

Application	Finishing	Finishing to medium cutting
Grade	NS9530	T9215
Chipbreaker shape	PSS	PS
Cutting conditions	B020	

M

Application	Finishing	Finishing to medium cutting
Grade	AH725	AH630
Chipbreaker shape	PSF	PSS
Cutting conditions	B022	

K

Application	Finishing to medium cutting
Grade	T515
Chipbreaker shape	CM
Cutting conditions	B024

S

Application	Finishing	Finishing to medium cutting
Grade	AH8015	AH8015
Chipbreaker shape	PSS	PS
Cutting conditions	B028	

H

Application	Precision finishing	Finishing
Grade	BXM10	BXM20
Chipbreaker shape	T-CBN	T-CBN
Cutting conditions	B030	

Reference pages: JSVJ2BR/L-CHP: Inserts → **B152 -**, CBN → **B191 -**
 Parts for coolant hose → **C142**



SVJCR/L

Screw-on toolholder with 93° approach angle, for positive 35° rhombic inserts

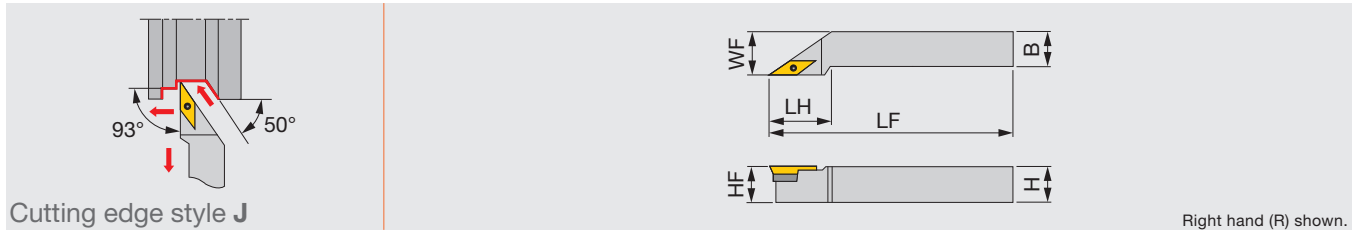

Right hand (R) shown.

Inch	H	B	LF	LH	HF	WF	RE**	Insert
SVJCR/L103	0.625	0.625	4.500	1.000	0.625	0.725	0.031	VC**33...
SVJCR/L123	0.750	0.750	4.500	1.250	0.750	0.955	0.031	VC**33...
SVJCR/L163	1.000	1.000	6.000	1.500	1.000	1.250	0.031	VC**33...

Metric	H	B	LF	LH	HF	WF	RE**	Insert
SVJCR/L1616H16	16	16	100	32	16	20	0.8	VC**1604...
SVJCR/L2020K16	20	20	125	32	20	25	0.8	VC**1604...
SVJCR/L2525M16	25	25	150	40	25	32	0.8	VC**1604...

**RE: Standard corner radius

SPARE PARTS

Designation	Clamping screw	Shim screw	Shim	Wrench1	Wrench2
SVJCR/L...	CSTB-3.5L	DTS5-3.5	SSV32	P-3.5	T-15F

INSERT SELECTION

P	Application	Finishing	Finishing to medium cutting	M	Application	Finishing	Finishing to medium cutting	Medium cutting
	Grade	NS9530	T9215		Grade	AH725	AH630	T6130
	Chipbreaker shape	PSS	PS		Chipbreaker shape	PSF	PSS	PM
	Cutting conditions	B020			Cutting conditions	B022		
K	Application	Finishing to medium cutting	N	Application	Precision finishing	Finishing	Medium cutting	
	Grade	T515		Grade	DX120	DX140	KS05F	
	Chipbreaker shape	CM		Chipbreaker shape	T-DIA	with rake T-DIA	AL	
	Cutting conditions	B024		Cutting conditions	B026			
S	Application	Finishing	Finishing to medium cutting	H	Application	Precision finishing	Finishing	
	Grade	AH8015	AH8015		Grade	BXM10	BXM20	
	Chipbreaker shape	PSS	PS		Chipbreaker shape	T-CBN	T-CBN	
	Cutting conditions	B028			Cutting conditions	B030		

Reference pages: SVJCR/L:Inserts → **B155 -**, CBN → **B192**, PCD → **B196**

Y-PRO SERIES

SYJBR/L

Screw-on toolholder with 93° approach angle, for positive 25° rhombic inserts

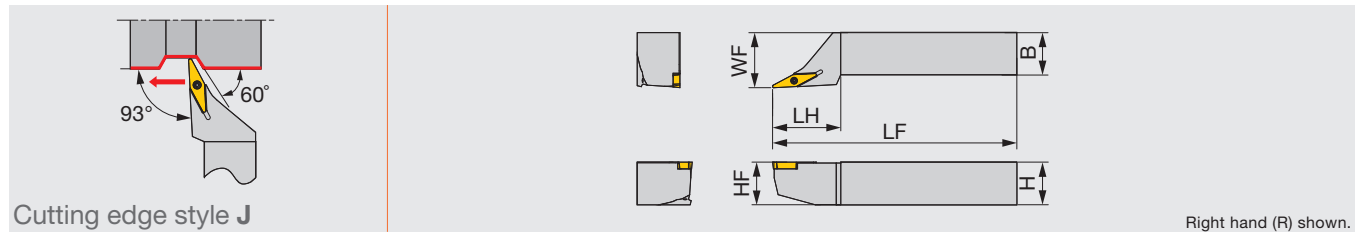

Right hand (R) shown.

Inch	H	B	LF	LH	HF	WF	RE**	Insert
SYJBR/L123	0.750	0.750	4.500	1.350	0.750	1.000	0.031	YWMT16T3...
SYJBR/L163	1.000	1.000	6.000	1.500	1.000	1.250	0.031	YWMT16T3...
Metric	H	B	LF	LH	HF	WF	RE**	Insert
SYJBR/L2020K16	20	20	125	35	20	25	0.8	YWMT16T3...
SYJBR/L2525M16	25	25	150	40	25	32	0.8	YWMT16T3...

**RE: Standard corner radius

SPARE PARTS

Designation	Clamping screw	Wrench
SYJBR/L...	CSTB-2.5L080	T-8F

INSERT SELECTION

P	Application	Finishing to medium cutting	K	Application	Finishing to medium cutting
	Grade	T9225		Grade	GT9530
Chipbreaker shape	ZM		Chipbreaker shape	ZM	
Cutting conditions	B008		Cutting conditions	B012	

Reference pages: SYJBR/L: Inserts → **B163**

Double-clamp toolholder with 63° approach angle, for negative 55° rhombic ceramic inserts with dimple

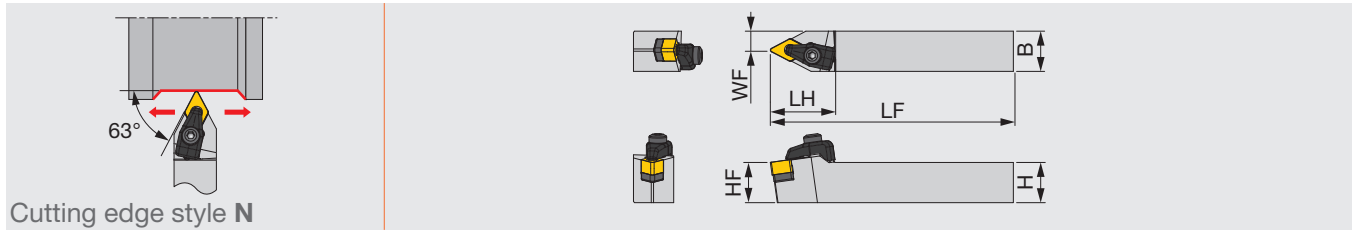

Metric	H	B	LF	LH	HF	WF	RE**	Insert	Torque
CDNNN2525M1507-RD	25	25	150	40	25	12.5	1.2	DN*D1507...	4

Torque: Recommended clamping torque: N·m
 **RE: Standard corner radius

SPARE PARTS

Designation	Clamp	Clamp screw	Shim	Shim screw	Spring	Wrench1	Wrench2
CDNNN2525M1507-RD	CCP4-A	CCS4-A	CD44-A	BH5-10-A	BP-5-A	P-3	P-4

- L
- J
- N**
- V
- P
- A
- G
- BR
- X
- D
- S
- K
- F
- QH
- Special

INSERT SELECTION

K	Application	Finishing to medium cutting
	Grade	FX105
	Chipbreaker shape	
	Cutting conditions	C144

Reference pages: CDNNN-RD: Inserts → **B075**
 Standard cutting conditions → **C144**

SDNCN

Screw-on toolholder with 62.5° approach angle, for positive 55° rhombic inserts

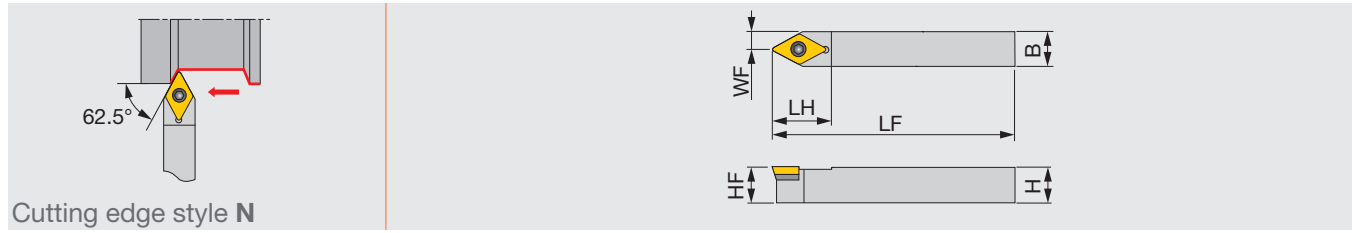

Metric	H	B	LF	LH	HF	WF	RE**	Insert
SDNCN1616H11	16	16	100	21	16	8	0.8	DC**11T3...
SDNCN2020K11	20	20	125	21	20	10	0.8	DC**11T3...
SDNCN2525M11	25	25	150	21	25	12.5	0.8	DC**11T3...

**RE: Standard corner radius

SPARE PARTS

Designation	Clamping screw	Shim screw	Shim	Wrench1	Wrench2
SDNCN...	CSTB-3.5L	DTS5-3.5	SSD32	P-3.5	T-15F

INSERT SELECTION

Application	Finishing	Finishing to medium cutting	Medium cutting
	Grade	NS9530	T9215
Chipbreaker shape	PSS	PS	PM
Cutting conditions	B020		

Application	Precision finishing	Finishing	Finishing to medium cutting	Medium cutting
	Grade	GH330	AH725	AH630
Chipbreaker shape	W**	PSF	PSS	PM
Cutting conditions	B022			

Application	Finishing to medium cutting
Grade	T515
Chipbreaker shape	CM
Cutting conditions	B024

Application	Precision finishing	Finishing	Medium cutting
	Grade	DX120	DX140
Chipbreaker shape	T-DIA	with rake T-DIA	AL
Cutting conditions	B026		

Application	Finishing	Finishing to medium cutting
	Grade	AH8015
Chipbreaker shape	PSS	PS
Cutting conditions	B028	

Application	Precision finishing	Finishing
	Grade	BXM10
Chipbreaker shape	T-CBN	T-CBN
Cutting conditions	B030	

Reference pages: SDNCN:Inserts → B121 -, CBN → B184 -, PCD → B196 -

Grade
Insert
Ext. Toolholder
Int. Toolholder
Threading
Grooving
Milling Cutter
Miniature Tool
Endmill
Drilling Tool
User's Guide
Tooling System
Index



Double-clamp toolholder with 72.5° approach angle, for negative 35° rhombic inserts

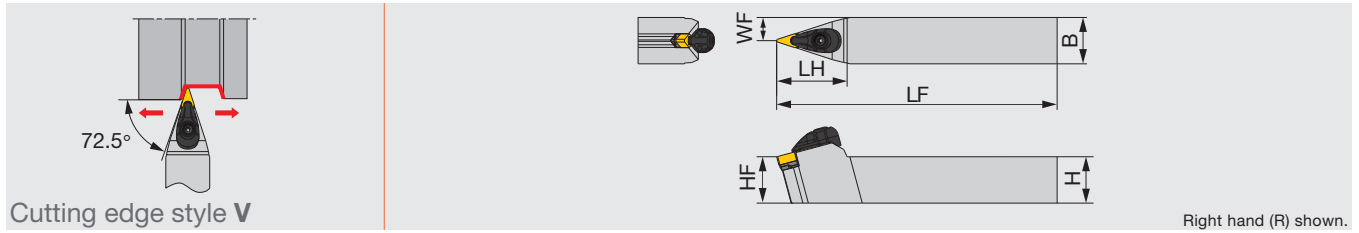

Inch	H	B	LF	LH	HF	WF	RE**	Insert	Torque
AVVNN122.33-A	0.750	0.750	4.500	1.500	0.750	0.375	0.031	VN**2.33**E...	2.2
AVVNN162.33-A	1.000	1.000	6.000	1.500	1.000	0.500	0.031	VN**2.33**E...	2.2

Metric	H	B	LF	LH	HF	WF	RE**	Insert	Torque*
AVVNN2020K1204-A	20	20	125	38	20	10	0.8	VN**1204...	3
AVVNN2525M1204-A	25	25	150	38	25	13	0.8	VN**1204...	3

Torque: Recommended clamping torque: lbs-ft (*N-m) **RE: Standard corner radius

SPARE PARTS							
Designation	Clamp	Clamp screw	Spring	Spring pin	Shim	Shim screw	Wrench
AVVNN**-A	ACP3L-E	ACS-5W	BP-7	SP-2.5	ASV222	CSTB-3.0	T-15F

Lever-lock toolholder with 72.5° approach angle, for negative 35° rhombic inserts

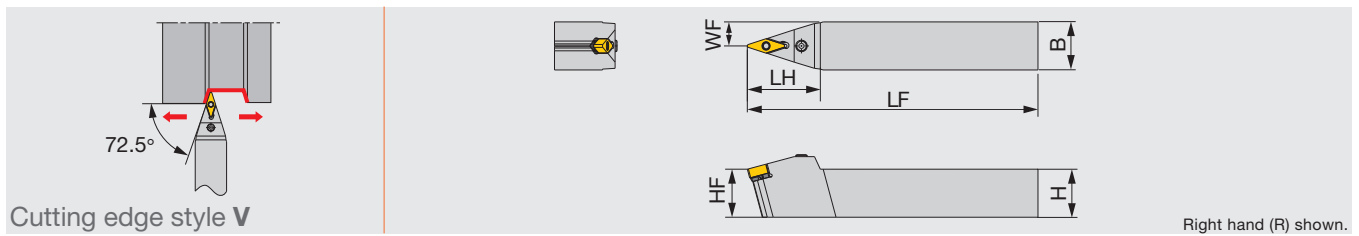

Metric	H	B	LF	LH	HF	WF	RE**	Insert	Torque
PVVNN2020K1204	20	20	125	38	20	10	0.8	VN**1204...	2
PVVNN2525M1204	25	25	150	38	25	12.5	0.8	VN**1204...	2

Torque: Recommended clamping torque: N-m **RE: Standard corner radius

SPARE PARTS					
Designation	Shim	Clamping screw	Wrench	Spring pin	Lever
PVVNN**1204	LSV212	LCS3V	P-2.5	LSP3	LCL3V

INSERT SELECTION

P	Application	Finishing	Medium cutting	M	Application	Finishing	Medium cutting
	Grade	T9215	T9215		T6120	T6130	
Chipbreaker shape	TSF	TM	SS	SM			
Chipbreaker shape							
Cutting conditions	B008		B010				

Reference pages: AVVNN-Eco, PVVNN-Eco: Inserts → **B097 -**

Double-clamp toolholder with 72.5° approach angle, for negative 35° and 25° rhombic inserts

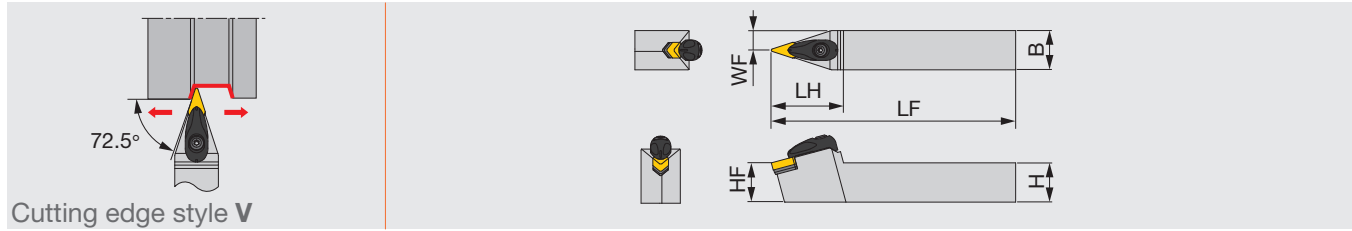

Inch	H	B	LF	LH	HF	WF	RE**	Insert	Torque
AVVNN123-A	0.750	0.750	4.500	1.870	0.750	0.375	0.031	V/YN**33...	2.2
AVVNN163-A	1.000	1.000	6.000	1.870	1.000	0.500	0.031	V/YN**33...	2.2

Metric	H	B	LF	LH	HF	WF	RE**	Insert	Torque*
AVVNN2020K16-A	20	20	125	46	20	10	0.8	V/YN**1604...	3
AVVNN2525M16-A	25	25	150	46	25	12.5	0.8	V/YN**1604...	3

Torque: Recommended clamping torque: lbs-ft (*N·m)
 **RE: Standard corner radius

SPARE PARTS							
Designation	Clamp	Clamp screw	Spring	Spring pin	Shim	Shim screw	Wrench
AVVNN**3-A, 16-A	ACP3L	ACS-5W	BP-7	SP-2.5	ASV322	CSTB-3.5	T-15F

INSERT SELECTION

P	Application	Precision finishing	Finishing	Medium cutting	M	Application	Finishing	Medium cutting	
	Grade	NS9530	GT9530	T9215		Grade	T6120	T6130	
	Chipbreaker shape	TF	TSF	TM		Chipbreaker shape	SF	SM	
Cutting conditions				B008	Cutting conditions				B010
K	Application	Finishing	Medium cutting	Medium to heavy cutting	N	Application	Precision finishing		
	Grade	T515	T515	T515		Grade	DX120		
	Chipbreaker shape	All-round	All-round	All-round		Chipbreaker shape	T-DIA	with rake	
Cutting conditions				B012	Cutting conditions				B014
S	Application	Precision finishing	Finishing	Medium cutting	H	Application	Precision finishing	Finishing	
	Grade	BX480	AH8005	AH8005		Grade	BXM10	BXM20	
	Chipbreaker shape	T-CBN	HRF	HRM		Chipbreaker shape	T-CBN	T-CBN	
Cutting conditions				B016	Cutting conditions				B018

Reference pages: AVVNN: Inserts → **B096 -**, **B109**, CBN → **B180**, PCD → **B194**



Double-clamp toolholder with 72.5° approach angle, for negative 35° rhombic ceramic inserts with dimple

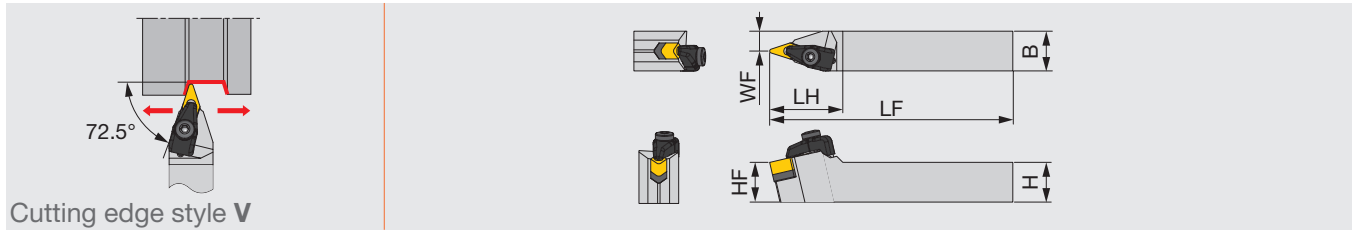

Metric	H	B	LF	LH	HF	WF	RE**	Insert	Torque
CVVNN2525M1607-RD	25	25	150	46	25	12.5	1.2	VN*D160712	4

Torque: Recommended clamping torque: N·m
 **RE: Standard corner radius

SPARE PARTS

Designation	Clamp	Clamp screw	Shim	Shim screw	Spring	Wrench1	Wrench2
CVVNN2525M1607-RD	CCP4-A	CCS4-A	CV34-A	BH-4-10-A	BP-5-A	P-3	P-4

- L
- J
- N
- V**
- P
- A
- G
- BR
- X
- D
- S
- K
- F
- QH
- Special

INSERT SELECTION

K	Application	Finishing to medium cutting
	Grade	FX105
	Chipbreaker shape	
	Cutting conditions	C144

Reference pages: CVVNN-RD: Inserts → **B101**,
 Standard cutting conditions → **C144**

SVVCN

Screw-on toolholder with 72.5° approach angle, for positive 35° rhombic inserts

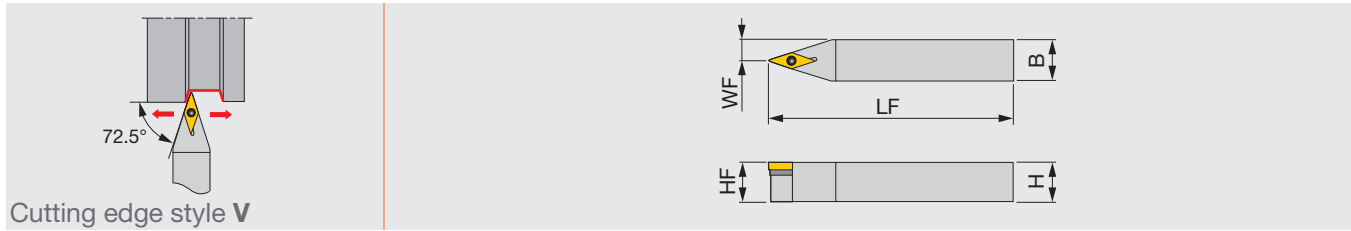

Metric	H	B	LF	HF	WF	RE**	Insert
SVVCN2020K16	20	20	125	20	10	0.8	VC**1604...
SVVCN2525M16	25	25	150	25	12.5	0.8	VC**1604...

**RE: Standard corner radius

SPARE PARTS

Designation	Clamping screw	Shim screw	Shim	Wrench1	Wrench2
SVVCN...	CSTB-3.5L	DTS5-3.5	SSV32	P-3.5	T-15F

INSERT SELECTION

P	Application	Finishing	Finishing to medium cutting	M	Application	Finishing	Finishing to medium cutting	Medium cutting									
	Grade	NS9530	T9215		Grade	AH725	AH630	T6130									
	Chipbreaker shape	PSS	PS		Chipbreaker shape	PSF	PSS	PM									
Cutting conditions				B020					Cutting conditions				B022				
K	Application	Finishing to medium cutting	N	Application	Precision finishing	Finishing	Medium cutting										
	Grade	T515		Grade	DX120	DX140	KS05F										
	Chipbreaker shape	CM		Chipbreaker shape	T-DIA	with rake T-DIA	AL										
Cutting conditions				B024					Cutting conditions				B026				
S	Application	Finishing	Finishing to medium cutting	H	Application	Precision finishing	Finishing										
	Grade	AH8015	AH8015		Grade	BXM10	BXM20										
	Chipbreaker shape	PSS	PS		Chipbreaker shape	T-CBN	T-CBN										
Cutting conditions				B028					Cutting conditions				B030				

Reference pages: SVVCN: Inserts → **B155** -, CBN → **B192**, PCD → **B196**

Double-clamp toolholder with 62.5° approach angle, for negative 55° rhombic inserts

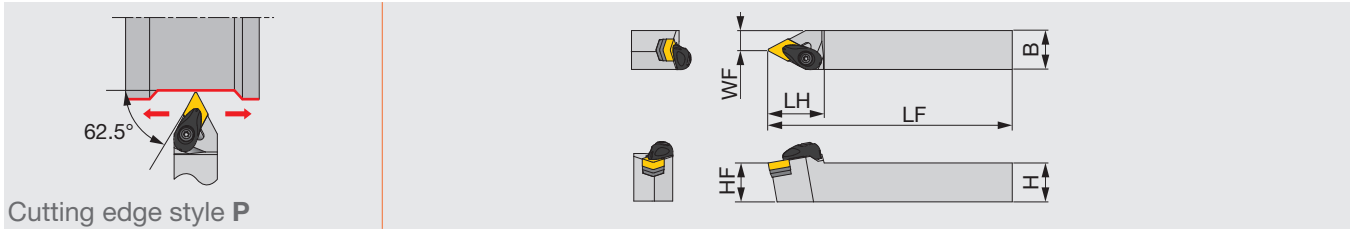

Inch	H	B	LF	LH	HF	WF	RE**	Insert	Torque
ADPNN124-A	0.750	0.750	4.500	1.500	0.750	0.375	0.031	DN**43...	2.2
ADPNN164-A	1.000	1.000	6.000	1.500	1.000	0.500	0.031	DN**43...	2.2

Metric	H	B	LF	LH	HF	WF	RE**	Insert	Torque*
ADPNN2020K15-A	20	20	125	36	20	7.5	0.8	DN**1504...	3
ADPNN2525M15-A	25	25	150	36	25	12.5	0.8	DN**1504...	3

Torque: Recommended clamping torque: lbs-ft (*N·m)
 **RE: Standard corner radius

SPARE PARTS

Designation	Clamp	Clamp screw	Spring	Spring pin	Shim	Shim screw	Wrench
ADPNN*4-A, 15-A	ACP4S	ACS-5W	BP-7	SP-2.5	ASD432	CSTB-3.5	T-15F

INSERT SELECTION

Application	Precision finishing	Finishing	Medium cutting	Medium to heavy cutting
	Grade	NS9530	GT9530	T9215
Chipbreaker shape	TF	TSF	TM	TH
Cutting conditions	B008			

Application	Finishing	Medium cutting	Medium to heavy cutting
	Grade	T6120	T6130
Chipbreaker shape	SF	SM	SH
Cutting conditions	B010		

Application	Finishing	Medium cutting	Medium to heavy cutting
	Grade	T515	T515
Chipbreaker shape	All-round	All-round	All-round
Cutting conditions	B012		

Application	Precision finishing	Finishing	Medium cutting
	Grade	DX120	DX140
Chipbreaker shape	T-DIA	with rake T-DIA	P
Cutting conditions	B014		

Application	Precision finishing	Finishing	Medium cutting
	Grade	BX470	AH8005
Chipbreaker shape	T-CBN	HRF	HRM
Cutting conditions	B016		

Application	Precision finishing	Finishing
	Grade	BXM10
Chipbreaker shape	T-CBN	T-CBN
Cutting conditions	B018	

Reference pages: ADPNN: Inserts → B067 -, CBN → B174 -, PCD → B194 -

PDPNN

Lever-lock toolholder with 62.5° approach angle, for negative 55° rhombic inserts

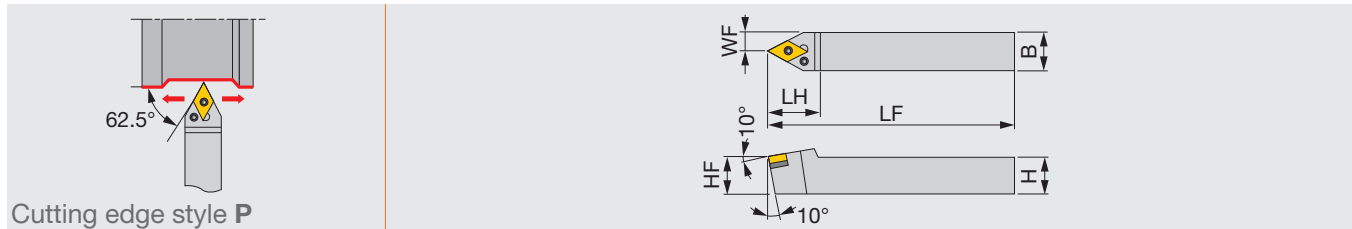

Metric	H	B	LF	LH	HF	WF	RE**	Insert
PDPNN2525	25	25	150	36	25	12.5	0.8	DN**1504...
PDPNN2525M15E	25	25	150	36	25	12.5	0.8	DN**1506...

**RE: Standard corner radius

SPARE PARTS					
Designation	Shim	Clamping screw	Wrench	Spring pin	Lever
PDPNN2525	LSD42	LCS4	P-3	LSP4	LCL4
PDPNN2525M15E	ELSD42	ELCS4	P-3	LSP4S	LCL44

INSERT SELECTION

P

Application	Precision finishing	Finishing	Medium cutting	Medium to heavy cutting
Grade	NS9530	GT9530	T9215	T9215
Chipbreaker shape	TF	TSF	TM	TH
Images				
Cutting conditions	B008			

M

Application	Finishing	Medium cutting	Medium to heavy cutting
Grade	T6120	T6130	T6130
Chipbreaker shape	SF	SM	SH
Images			
Cutting conditions	B010		

K

Application	Finishing	Medium cutting	Medium to heavy cutting
Grade	T515	T515	T515
Chipbreaker shape	All-round	All-round	All-round
Images			
Cutting conditions	B012		

N

Application	Precision finishing	Finishing	Medium cutting
Grade	DX120	DX140	TH10
Chipbreaker shape	T-DIA	with rake T-DIA	P
Images			
Cutting conditions	B014		

S

Application	Precision finishing	Finishing	Medium cutting
Grade	BX470	AH8005	AH8005
Chipbreaker shape	T-CBN	HRF	HRM
Images			
Cutting conditions	B016		

H

Application	Precision finishing	Finishing
Grade	BXM10	BXM20
Chipbreaker shape	T-CBN	T-CBN
Images		
Cutting conditions	B018	

Reference pages: PDPNN: Inserts → **B067** -, CBN → **B174** -, PCD → **B194** -

Grade **A**
 Insert **B**
 Ext. Toolholder **C**
 Int. Toolholder **D**
 Threading **E**
 Grooving **F**
 Milling Cutter Miniature Tool **G**
 Endmill **H**
 Drilling Tool **J**
 User's Guide Tooling System **K**
 Index **M**

SRACR/L

Screw-on toolholder with 91° approach angle, for positive round inserts

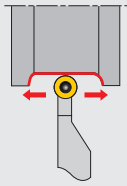

Cutting edge style A

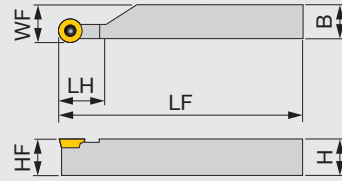

Right hand (R) shown.

Metric	H	B	LF	LH	HF	WF	Insert
SRACR1010H05	10	10	100	10	10	10.3	RCMT0502...
SRACR/L1212H05	12	12	100	10	12	12.3	RCMT0502...
SRACR/L1212H06	12	12	100	12	12	12.4	RC*T0602...
SRACR1616H05	16	16	100	10	16	16.3	RCMT0502...
SRACR/L1616H06	16	16	100	12	16	16.4	RC*T0602...
SRACR/L1616H08	16	16	100	16	16	16.5	RC*T0803...
SRACR/L2020K05	20	20	125	10	20	20.3	RCMT0502...
SRACR/L2020K06	20	20	125	12	20	20.4	RC*T0602...
SRACR/L2020K08	20	20	125	16	20	20.5	RC*T0803...
SRACR/L2525M05	25	25	150	10	25	25.3	RCMT0502...
SRACR/L2525M06	25	25	150	12	25	25.4	RC*T0602...
SRACR/L2525M08	25	25	150	16	25	25.5	RC*T0803...

SPARE PARTS



Designation	Clamping screw	Wrench
SRACR/L1*1*H05	CSTB-2.2R	T-7F
SRACR/L1212H06	CSTB-2.5	T-8F
SRACR1616H05	CSTB-2.2R	T-7F
SRACR/L1616H06	CSTB-2.5	T-8F
SRACR/L1616H08	CSTB-3	T-9F
SRACR/L2020K05	CSTB-2.2R	T-7F
SRACR/L2020K06	CSTB-2.5	T-8F
SRACR/L2020K08	CSTB-3	T-9F
SRACR/L2525M05	CSTB-2.2R	T-7F
SRACR/L2525M06	CSTB-2.5	T-8F
SRACR/L2525M08	CSTB-3	T-9F

INSERT SELECTION

Application	Finishing to medium cutting		heavy cutting
	T9215		T9215
Grade	T9215		T9215
Chipbreaker shape	RS	61	
Cutting conditions	B020		

Application	heavy cutting
Grade	T9215
Chipbreaker shape	61
Cutting conditions	B022

Application	heavy cutting
Grade	T9215
Chipbreaker shape	61
Cutting conditions	B024

Application	Finishing to medium cutting
Grade	KS05F
Chipbreaker shape	AL
Cutting conditions	B026

Application	Finishing to medium cutting		heavy cutting
	AH8015		AH8015
Grade	AH8015		AH8015
Chipbreaker shape	RS	61	
Cutting conditions	B028		

Reference pages: SRACR/L: Inserts → B131 -

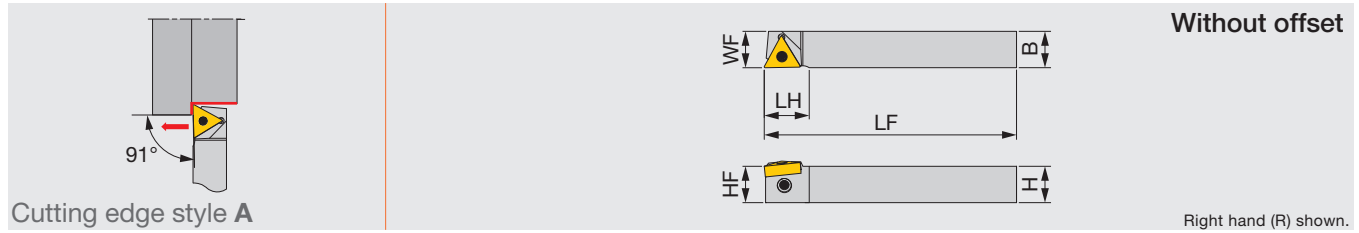

Metric	H	B	LF	LH	HF	WF	RE**	Insert	Torque
JTTANR/L1216K16	12	16	125	19.8	12	16	0.4	TN**1604...	1.2
JTTANR/L1616K16	16	16	125	19.8	16	16	0.4	TN**1604...	1.2

Torque: Recommended clamping torque: N·m

**RE: Standard corner radius

SPARE PARTS

Designation	Clamp	Clamping screw	Wrench
JTTANR/L...	JCP-3N	JDS-5040	P-2.5F

INSERT SELECTION

P	Application	Precision finishing	M	Application	Precision finishing	
	Grade	SH725		Grade	SH725	
	Chipbreaker shape	01		Chipbreaker shape	01	
	Cutting conditions	B008		Cutting conditions	B010	
K	Application	Finishing to medium cutting	N	Application	Precision finishing	
	Grade	T515		Grade	DX120	
	Chipbreaker shape	CM		Chipbreaker shape	T-DIA <small>with rake</small>	
	Cutting conditions	B012		Cutting conditions	B014	
S	Application	Precision finishing	H	Application	Precision finishing	Finishing
	Grade	BX470		Grade	BXM10	BXM20
	Chipbreaker shape	T-CBN		Chipbreaker shape	T-CBN	T-CBN
	Cutting conditions	B016		Cutting conditions	B018	

Reference pages: JTTANR/L: Inserts → B086 -, CBN → B178 -, PCD → B194 -

Screw-on toolholder with 91° approach angle, for positive 60° triangular inserts

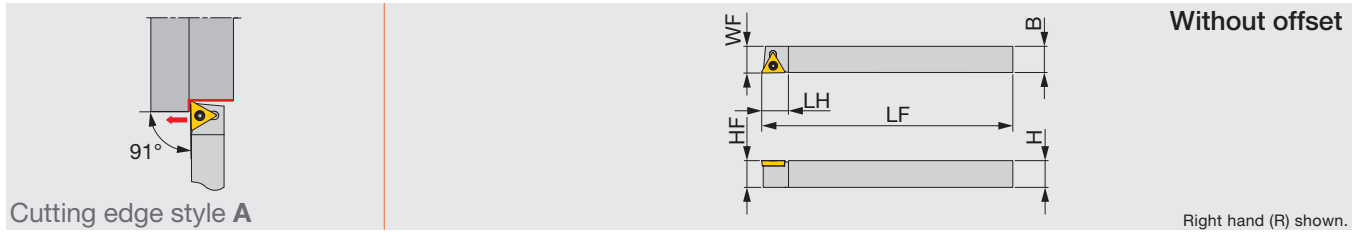

Metric	H	B	LF	LH	HF	WF	RE**	Insert	Torque
JSTACR/L0808K08	8	8	125	10	8	8	0.2	TC**0802...	0.6
JSTACR/L1010K08	10	10	125	10	10	10	0.2	TC**0802...	0.6
JSTACR/L1212K11	12	12	125	12	12	12	0.4	TC**1102...	1.2
JSTACR/L1616H11	16	16	100	12	16	16	0.4	TC**1102...	1.2

SPARE PARTS

Designation	Clamping screw	Wrench
JSTACR/L**K08	CSTB-2L	T-6F
JSTACR/L**11	CSTB-2.5	T-8F

Torque: Recommended clamping torque: N·m
 **RE: Standard corner radius

Back-clamp toolholder with 91° approach angle, for positive 60° triangular inserts

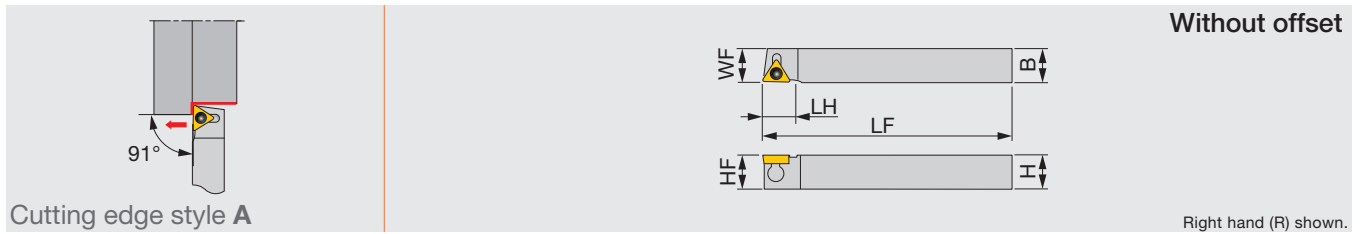

Metric	H	B	LF	LH	HF	WF	RE**	Insert	Torque
JTTACL0810K08	8	10	125	10	8	10	0.2	TC**0802...	0.9
JTTACR/L1212M11	12	12	150	12	12	12	0.4	TC**1102...	0.9
JTTACR/L1616M11	16	16	150	12	16	16	0.4	TC**1102...	0.9

SPARE PARTS

Designation	Clamp	Clamping screw	Wrench
JTTACL0810K08	JCP-1	JDS-3525	P-2F
JTTACR/L**M11	JCP-2	JDS-3525	P-2F

Torque: Recommended clamping torque: N·m
 **RE: Standard corner radius

INSERT SELECTION

P

Application	Precision finishing	Finishing	Finishing to medium cutting	Medium cutting
Grade	SH725	SH725	T9215	T9215
Chipbreaker shape	01	JS	PS	PM
Cutting conditions	B020			

M

Application	Precision finishing	Finishing	Finishing to medium cutting	Medium cutting
Grade	SH725	SH725	T9215	T9215
Chipbreaker shape	01	JS	PS	PM
Cutting conditions	B022			

K

Application	Finishing to medium cutting
Grade	T515
Chipbreaker shape	CM
Cutting conditions	B024

N

Application	Precision finishing	Medium cutting
Grade	DX120	KS05F
Chipbreaker shape	T-DIA with rake	AL
Cutting conditions	B026	

Reference pages: JSTACR/L, JTTACR/L: Inserts → B139 -, PCD → B196

STACR/L

Screw-on toolholder with 91° approach angle, for positive 60° triangular inserts

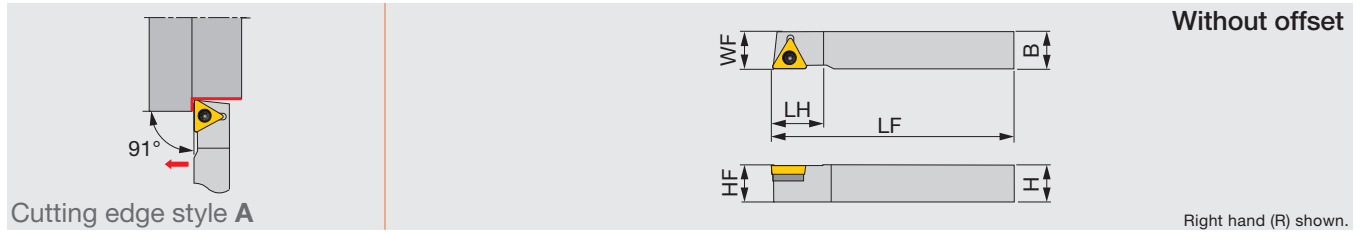

Metric	H	B	LF	LH	HF	WF	RE**	Insert
STACR/L1616H16	16	16	100	22.5	16	16	0.8	TC**16T3...

**RE: Standard corner radius

SPARE PARTS

Designation	Clamping screw	Shim screw	Shim	Wrench1	Wrench2
STACR/L...	CSTB-3.5L	DTS5-3.5	SST32	P-3.5	T-15F

INSERT SELECTION

Application	Precision finishing	Finishing	Finishing to medium cutting	Medium cutting
	Grade	Grade	Grade	Grade
	NS9530	NS9530	T9215	T9215
Chipbreaker shape	01	PSS	PS	PM
Cutting conditions	B020			

Application	Finishing	Medium cutting
	Grade	Grade
	AH725	T6130
Chipbreaker shape	PSF	PM
Cutting conditions	B022	

Application	Finishing to medium cutting
	Grade
	T515
Chipbreaker shape	CM
Cutting conditions	B024

Application	Precision finishing
	Grade
	DX120
Chipbreaker shape	T-DIA with rake
Cutting conditions	B026

Reference pages: STACR/L: Inserts → **B139** -

Screw-on toolholder for roughing with 93° approach angle, for negative tangential inserts

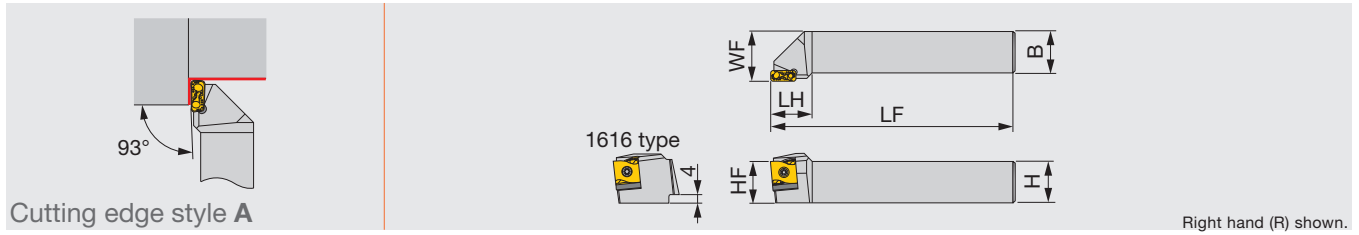

Inch	H	B	LF	LH	HF	WF	Insert
TLANR/L10-12	0.625	0.625	4.000	0.790	0.625	0.750	LNMX1204**R/L...
TLANR/L12-12	0.750	0.750	4.500	0.790	0.750	1.000	LNMX1204**R/L...
TLANR/L12-16	0.750	0.750	4.500	1.000	0.750	1.000	LNMX1606**R/L...
TLANR/L16-12	1.000	1.000	6.000	0.790	1.000	1.250	LNMX1204**R/L...
TLANR/L16-16	1.000	1.000	6.000	1.000	1.000	1.180	LNMX1606**R/L...
TLANR/L20-16	1.250	1.250	6.000	1.380	1.250	1.460	LNMX1606**R/L...
TLANR/L20-24	1.250	1.250	6.000	1.380	1.250	1.500	LNMX2410**R/L...
TLANR/L24-16	1.500	1.500	7.000	1.380	1.500	1.700	LNMX1606**R/L...
TLANR/L24-24	1.500	1.500	7.000	1.380	1.500	1.700	LNMX2410**R/L...
TLANR/L32-24	2.000	2.000	8.000	1.380	2.000	2.275	LNMX2410**R/L...

SPARE PARTS

Designation	Clamping screw	Shim screw	Shim	Spring	Wrench 1	Wrench 2
TLANR**-12	CSTB-3.5L115-S	CSTF-2L055-S	TSL12R	-	KEYV-T10	T-6F-S
TLANL**-12	CSTB-3.5L115-S	CSTF-2L055-S	TSL12L	-	KEYV-T10	T-6F-S
TLANR**-16	CSTB-4L115-S	-	TSL16R	PSP-16	KEYV-T15	-
TLANL**-16	CSTB-4L115-S	-	TSL16L	PSP-16	KEYV-T15	-
TLANR**-24	CSTB-5L163-S	-	TSL24R	PSP-16	KEYV-T20	-
TLANL**-24	CSTB-5L163-S	-	TSL24L	PSP-16	KEYV-T20	-

Reference pages: TLANR/L: Inserts → **C083**
Standard cutting conditions → **C144**

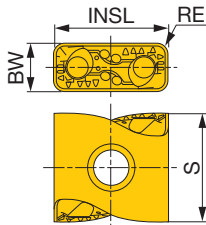

P	Steel	★	★	★																
M	Stainless				☆															
K	Cast iron	☆	☆	☆																
N	Non-ferrous																			
S	Superalloys																			
H	Hard materials																			

★ : First choice
☆ : Second choice

Designation	HAND	RE (in)	Coated										BW (in)	INSL (in)	S (in)			
			T9115	T9125	AH725													
LNMX120408R-TDR	R	0.031	●	●												0.189	0.473	0.457
LNMX120408L-TDR	L	0.031	●	●												0.189	0.473	0.457
LNMX120412R-TDR	R	0.047	●	●												0.189	0.473	0.457
LNMX120412L-TDR	L	0.047	●	●												0.189	0.473	0.457
LNMX160608R-TDR	R	0.031	●	●												0.252	0.638	0.532
LNMX160608L-TDR	L	0.031	●	●												0.252	0.638	0.532
LNMX160612R-TDR	R	0.047	●	●												0.252	0.638	0.532
LNMX160612L-TDR	L	0.047	●	●												0.252	0.638	0.532
LNMX160616R-TDR	R	0.063	●	●												0.252	0.638	0.532
LNMX160616L-TDR	L	0.063	●	●												0.252	0.638	0.532
LNMX241016R-TDR	R	0.063	●	●												0.370	0.945	0.807
LNMX241016L-TDR	L	0.063	●	●												0.370	0.945	0.807
LNMX241024R-TDR	R	0.094	●	●												0.370	0.945	0.807
LNMX241024L-TDR	L	0.094	●	●												0.370	0.945	0.807
LNMX160608R-MDR	R	0.031	●	●	●											0.252	0.638	0.532
LNMX160608L-MDR	L	0.031	●	●	●											0.252	0.638	0.532
LNMX160612R-MDR	R	0.047	●	●	●											0.252	0.638	0.532
LNMX160612L-MDR	L	0.047	●	●	●											0.252	0.638	0.532
LNMX160608R-TWR	R	0.031	●	●												0.252	0.638	0.532
LNMX160608L-TWR	L	0.031	●	●												0.252	0.638	0.532
LNMX160612R-TWR	R	0.047	●	●												0.252	0.638	0.532
LNMX160612L-TWR	L	0.047	●	●												0.252	0.638	0.532

● : Line up

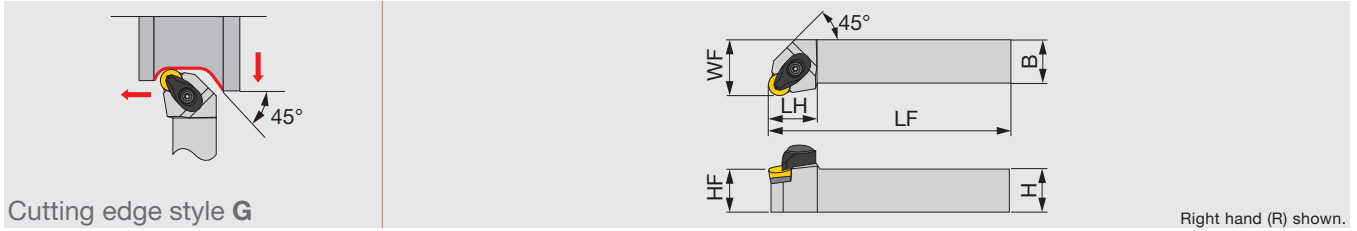

Cutting edge style G

Right hand (R) shown.

Inch	H	B	LF	LH	HF	WF	RE**	Insert	Torque
ARGNR/L164-A	1.000	1.000	6.000	1.125	1.000	1.250	0.250	RN**43...	2.2
Metric	H	B	LF	LH	HF	WF	RE**	Insert	Torque*
ARGNR/L2525M12-A	25	25	150	28	25	32	6.35	RN**120400	3

Torque: Recommended clamping torque: lb-ft (*N·m)

**RE: Standard corner radius

SPARE PARTS

Designation	Clamp	Clamp screw	Spring	Spring pin	Shim	Shim screw	Wrench
ARGNR/L...	ACP4S	ACS-5W	BP-7	SP-2.5	ASR420	CSTB-3.5	T-15F

INSERT SELECTION

P	Application	Semi-finishing to medium cutting
	Grade	T9225
	61	
	Chipbreaker Shape	
	Cutting conditions	B008

PRGNR/L

Lever-lock toolholder with 91° approach angle, for negative round inserts

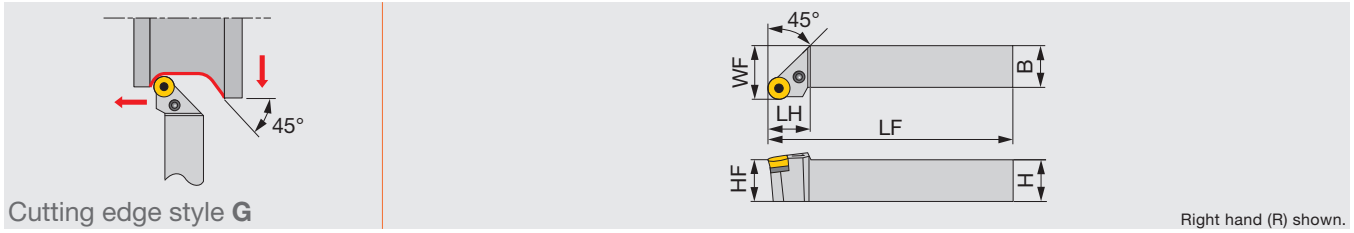

Right hand (R) shown.

Metric	H	B	LF	LH	HF	WF	RE**	Insert
PRGNR/L2020	20	20	125	19	20	25	4.76	RNMG090300-61
PRGNR/L2525M4	25	25	150	25	25	32	6.35	RN**120400

**RE: Standard corner radius

SPARE PARTS

Designation	Shim	Clamping screw	Wrench	Spring pin	Lever
PRGNR/L2020	LSR32	LCS3	P-2.5	LSP3	LCL3
PRGNR/L2525M4	LSR42	LCS4	P-3	LSP4	LCL4

INSERT SELECTION

P	Application	Heavy cutting	M	Application	Heavy cutting
	Grade	T9215		Grade	T9215
	Chipbreaker Shape	61		Chipbreaker Shape	61
	Cutting conditions	B008		Cutting conditions	B010
K	Application	Heavy cutting	N	Application	Heavy cutting
	Grade	T9215		Grade	TH10
	Chipbreaker Shape	61		Chipbreaker Shape	61
	Cutting conditions	B012		Cutting conditions	B014
S	Application	Heavy cutting	H	Application	Finishing to medium cutting
	Grade	TH10		Grade	LX11
	Chipbreaker Shape	61		Chipbreaker Shape	
	Cutting conditions	B016		Cutting conditions	B018

Reference pages: PRGNR/L: Inserts → **B076**

Grade
Insert
Toolholder
Ext. Toolholder
Int. Toolholder
Threading
Grooving
Milling Cutter
Miniature Tool
Endmill
Drilling Tool
Tooling System
User's Guide
Index



DRG NR/L

"One-Double" toolholder with 91° approach angle, for negative round inserts

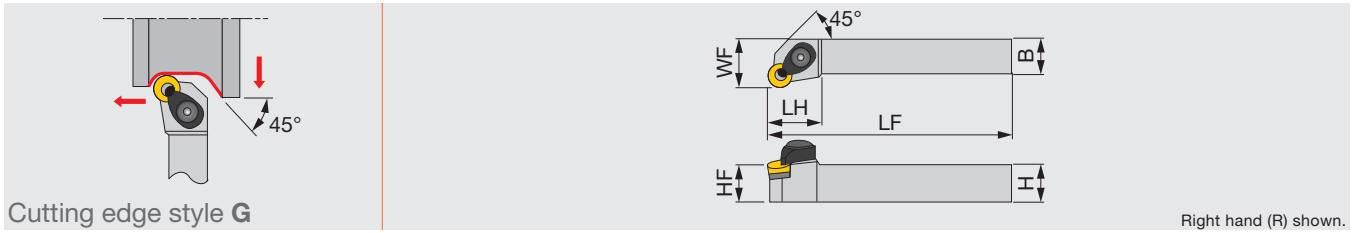

Metric	H	B	LF	LH	HF	WF	RE**	Insert
DRG NR/L2525M12	25	25	150	28	25	32	6.35	RN**120400

**RE: Standard corner radius

SPARE PARTS									
Designation	Clamp	Lever	Piston	Clamp screw	Shim	Spring	Spring pin	Wrench 1	Wrench 2
DRG NR/L...	DCPM-43	DLCL43	DPIS43	DLCS43	LSR42	BP-10	LSP4	P-3	P-4

- L
- J
- N
- V
- P
- A
- G**
- B-R
- X
- D
- S
- K
- F
- QH
- Special

INSERT SELECTION

P	Application	Semi-finishing to medium cutting
	Grade	T9215
	Chipbreaker Shape	61
	Cutting conditions	B008

Reference pages: DRG NR/L: Inserts → **B076**

PRGCR/L

Lever-lock toolholder with 91° approach angle, for positive round inserts

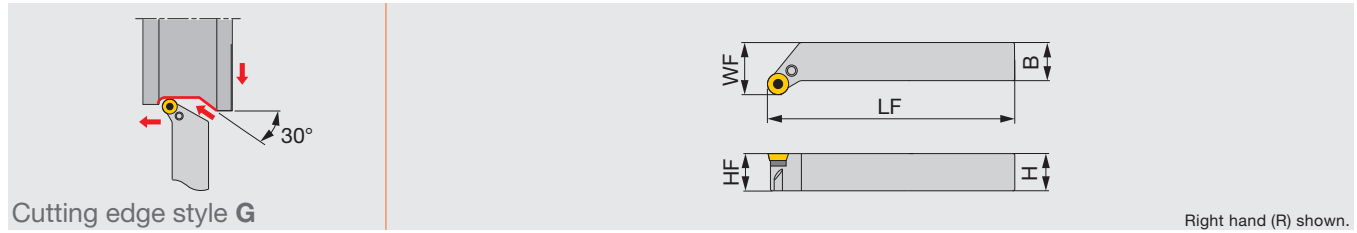

Cutting edge style **G**

Right hand (R) shown.

Metric	H	B	LF	HF	WF	Insert
PRGCR/L2020K10	20	20	125	20	25	RCMM1003...
PRGCR/L2525M12	25	25	150	25	32	RCM*1204...
PRGCR/L3225P16	32	25	170	32	32	RCM*1606...
PRGCR/L3232P20	32	32	170	32	40	RCM*2006...

SPARE PARTS

Designation	Shim	Clamping screw	Wrench	Spring pin	Lever
PRGCR/L2020K10	LSR32C	LCS2	P-2	LSP3	LCL3C
PRGCR/L2525M12	LSR42C	LCS3	P-2.5	LSP3	LCL4C
PRGCR/L3225P16	LSR53C	LCS5	P-3	LSP4	LCL5C
PRGCR/L3232P20	LSR63C	LCS5	P-3	LSP6C	LCL6C

INSERT SELECTION

P	Application	Finishing to medium cutting	Heavy cutting	M	Application	Heavy cutting
	Grade	T9215			Grade	T9215
	Chipbreaker Shape	RS	61		Chipbreaker Shape	61
Cutting conditions		B020		Cutting conditions		B022
K	Application	Heavy cutting		N	Application	Finishing to medium cutting
	Grade	T9215			Grade	KS05F
	Chipbreaker Shape	61			Chipbreaker Shape	AL
Cutting conditions		B024		Cutting conditions		B026
S	Application	Finishing to medium cutting	Heavy cutting			
	Grade	AH8015	AH8015			
	Chipbreaker Shape	RS	61			
Cutting conditions		B028				

Reference pages: PRGCR/L: Inserts → **B131 -**

SRGCR/L

Screw-on toolholder with 91° approach angle, for positive round inserts

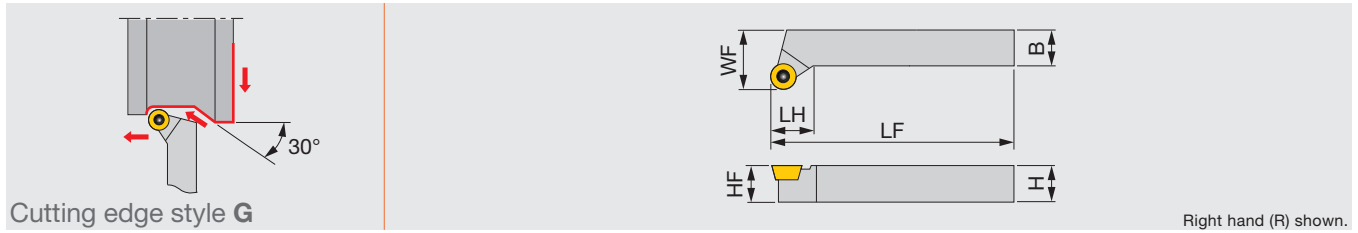

Right hand (R) shown.

Metric	H	B	LF	LH	HF	WF	Insert
SRGCR1212H05	12	12	100	9.5	12	16	RCMT0502...
SRGCR/L1212H06	12	12	100	10	12	16	RC*T0602...
SRGCR/L1616H05	16	16	100	9.5	16	20	RCMT0502...
SRGCR/L1616H06	16	16	100	10	16	20	RC*T0602...
SRGCR/L1616H08	16	16	100	11	16	20	RC*T0803...
SRGCR/L2020K05	20	20	125	11.2	20	25	RCMT0502...
SRGCR/L2020K06	20	20	125	12	20	25	RC*T0602...
SRGCR/L2020K08	20	20	125	12.7	20	25	RC*T0803...
SRGCR/L2020K10	20	20	125	14	25	25	RC*T1003...
SRGCR/L2525M05	25	25	150	14.7	25	32	RCMT0502...
SRGCR/L2525M06	25	25	150	15	25	32	RC*T0602...
SRGCR/L2525M08	25	25	150	16.2	25	32	RC*T0803...
SRGCR/L2525M10	25	25	150	17.5	25	32	RC*T1003...

SPARE PARTS

Designation	Clamping screw	Shim screw	Shim	Wrench 1	Wrench 2
SRGCR1212H05	CSTB-2.2R	-	-	-	T-7F
SRGCR/L1212H06	CSTB-2.5	-	-	-	T-8F
SRGCR/L1616H05	CSTB-2.2R	-	-	-	T-7F
SRGCR/L1616H06	CSTB-2.5	-	-	-	T-8F
SRGCR/L1616H08	CSTB-3	-	-	-	T-9F
SRGCR/L2020K05	CSTB-2.2R	-	-	-	T-7F
SRGCR/L2020K06	CSTB-2.5	-	-	-	T-8F
SRGCR/L2020K08	CSTB-3	-	-	-	T-9F
SRGCR/L2020K10	CSTB-3.5L	DTS5-3.5	SSR32	P-3.5	T-15F
SRGCR/L2525M05	CSTB-2.2R	-	-	-	T-7F
SRGCR/L2525M06	CSTB-2.5	-	-	-	T-8F
SRGCR/L2525M08	CSTB-3	-	-	-	T-9F
SRGCR/L2525M10	CSTB-3.5L	DTS5-3.5	SSR32	P-3.5	T-15F

INSERT SELECTION

P	Application	Finishing to medium cutting	Heavy cutting	M	Application	Heavy cutting	S	Application	Finishing to medium cutting	Heavy cutting
	Grade	T9215	T9215		Grade	T9215		Grade	AH8015	AH8015
	Chipbreaker Shape	RS	61		Chipbreaker Shape	61		Chipbreaker Shape	RS	61
Cutting conditions		B020		Cutting conditions		B022	Cutting conditions		B028	
K	Application	Heavy cutting	N	Application	Finishing to medium cutting					
	Grade	T9215		Grade	KS05F					
	Chipbreaker Shape	61		Chipbreaker Shape	AL					
Cutting conditions		B024		Cutting conditions		B026				

Reference pages: SRGCR/L: Inserts → B131 -

Screw-on toolholder with 91° approach angle, for positive round inserts

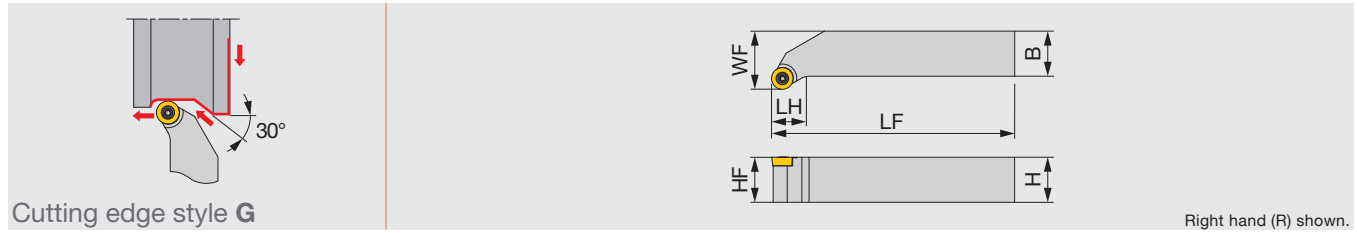

Inch	H	B	LF	LH	HF	WF	Insert	Torque
SRGCR/L164-6F	1.00	1.00	6.00	0.69	1.00	1.25	RCMT1204M0-6RS/-6RM	2.21

Metric	H	B	LF	LH	HF	WF	Insert	Torque*
SRGCR/L2525M12-6F	25	25	150	18.6	25	32	RCMT1204M0-6RS/-6RM	3

Torque: Recommended clamping torque: lb-ft (*N·m)

SPARE PARTS

Designation	Clamping screw	Lubricant	Wrench
SRGCR/L164-6F, SRGCR/L2525M12-6F	CSTB-4	M-1000	T-15F

INSERT

RCMT

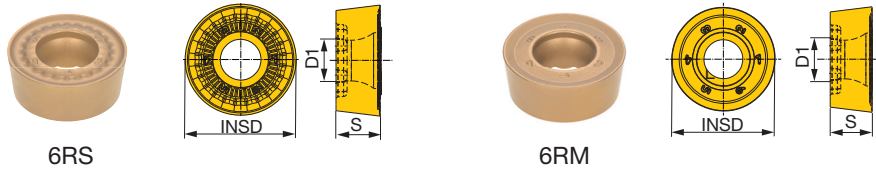

Designation	Coated				Cermet	INSD (in)	S (in)	D1 (in)
	T9225	T9215	T9115	T9125	NS9530			
RCMT1204M0-6RS	●	●	●	●	●	0.472	0.187	0.203
RCMT1204M0-6RM	●	●	●	●	●	0.472	0.187	0.203

★ : First choice
☆ : Second choice

● : Line up

Lever-lock toolholder with 91° approach angle, for negative triangular inserts

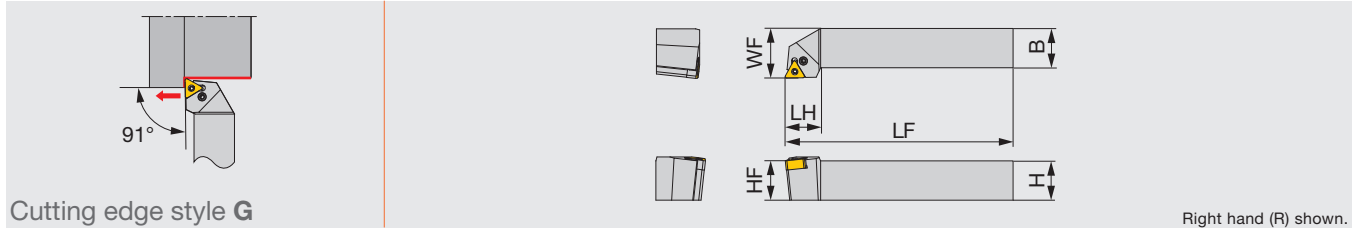

Inch	H	B	LF	LH	HF	WF	RE**	Insert	Torque
PTGNR/L1223	0.750	0.750	4.500	0.750	0.750	1.000	0.031	TN**23...	1.5
PTGNR/L1623	1.000	1.000	6.000	0.750	1.000	1.250	0.031	TN**23...	1.5

Metric	H	B	LF	LH	HF	WF	RE**	Insert	Torque*
PTGNR/L2020K1104	20	20	125	20	20	25	0.8	TN**1104...	2
PTGNR/L2525M1104	25	25	150	20	25	32	0.8	TN**1104...	2

Torque: Recommended clamping torque: lbs-ft (*N-m) **RE: Standard corner radius

SPARE PARTS

Designation	Clamping screw	Wrench	Lever
PTGNR/L...	LCS23A	P-2.5	LCL23

INSERT SELECTION

Application	Finishing	Medium cutting
	Grade	T9215
Chipbreaker Shape	TSF 	TM
Cutting conditions	B008	

Application	Finishing	Medium cutting
	Grade	T6120
Chipbreaker Shape	SS 	SM
Cutting conditions	B010	

Reference pages: PTGNR/L-Eco: Inserts → **B086** -

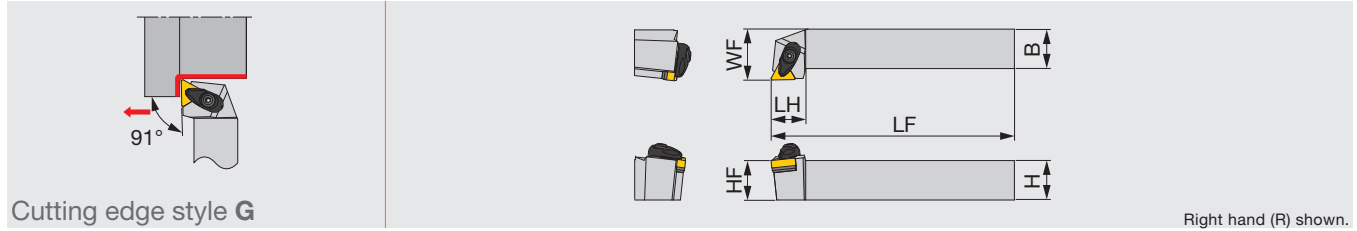

Inch	H	B	LF	LH	HF	WF	RE**	Insert	Torque
ATGNR/L123-A	0.750	0.750	4.500	0.875	0.750	1.000	0.031	TN**33...	2.2
ATGNR/L163-A	1.000	1.000	6.000	0.875	1.000	1.250	0.031	TN**33...	2.2
ATGNR/L164-A	1.000	1.000	6.000	1.000	1.000	1.250	0.031	TN**43...	2.2

Metric	H	B	LF	LH	HF	WF	RE**	Insert	Torque*
ATGNR/L2020K16-A	20	20	125	22	20	25	0.8	TN**1604...	3
ATGNR/L2525M16-A	25	25	150	22	25	32	0.8	TN**1604...	3
ATGNR/L2525M22-A	25	25	150	26	25	32	0.8	TN**2204...	3

Torque: Recommended clamping torque: lbs-ft (*N·m)
 **RE: Standard corner radius

SPARE PARTS							
Designation	Clamp	Clamp screw	Spring	Spring pin	Shim	Shim screw	Wrench
ATGNR/L**3-A, 16-A	ACP3S	ACS-5W	BP-7	SP-2.5	AST322	CSTB-3.5	T-15F
ATGNR/L**4-A, 22-A	ACP4S	ACS-5W	BP-7	SP-2.5	AST422	CSTB-3.5	T-15F

INSERT SELECTION

P	Application	Precision finishing	Finishing	Medium cutting	Medium to heavy cutting
	Grade	NS9530	GT9530	T9215	T9215
Chipbreaker Shape	TF	TSF	TM	TH	
Cutting conditions	B008				

M	Application	Finishing	Medium cutting
	Grade	T6120	T6130
Chipbreaker Shape	SF	SM	
Cutting conditions	B010		

K	Application	Finishing	Medium cutting	Medium to heavy cutting
	Grade	T515	T515	T515
Chipbreaker Shape	All-round	All-round	All-round	
Cutting conditions	B012			

N	Application	Precision finishing	Finishing	Medium cutting
	Grade	DX120	DX140	TH10
Chipbreaker Shape	T-DIA	with rake T-DIA	P	
Cutting conditions	B014			

S	Application	Precision finishing	Finishing	Medium cutting
	Grade	BX470	AH8005	AH8005
Chipbreaker Shape	T-CBN	HRF	HRM	
Cutting conditions	B016			

H	Application	Precision finishing	Finishing
	Grade	BXM10	BXM20
Chipbreaker Shape	T-CBN	T-CBN	
Cutting conditions	B018		

Reference pages: ATGNR/L: Inserts → B086 -, CBN → B178 -, PCD → B194 -



Lever-lock toolholders with 91° approach angle, for negative 60° triangular inserts, with high pressure coolant capability

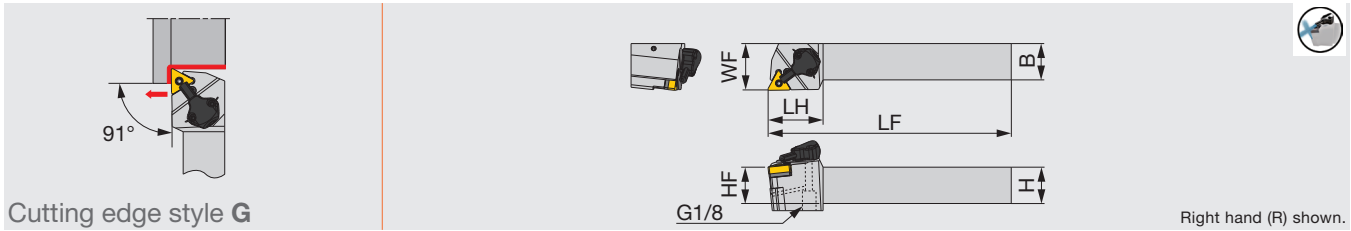

Inch	H	B	LF	LH	HF	WF	RE**	Insert	Torque
PTGNR/L1223-CHP	0.750	0.750	4.500	1.500	0.750	1.250	0.031	TN**23...	1.5
PTGNR/L123-CHP	0.750	0.750	4.500	1.500	0.750	1.250	0.031	TN**33...	1.5
PTGNR/L1623-CHP	1.000	1.000	6.000	1.500	1.000	1.250	0.031	TN**23...	1.5
PTGNR/L163-CHP	1.000	1.000	6.000	1.500	1.000	1.250	0.031	TN**33...	1.5

Metric	H	B	LF	LH	HF	WF	RE**	Insert	Torque*
PTGNR/L2020K1104-CHP	20	20	125	38	20	32	0.8	TN**1104...	2
PTGNR/L2020K16-CHP	20	20	125	38	20	32	0.8	TN**1604...	2
PTGNR/L2525M1104-CHP	25	25	150	38	25	32	0.8	TN**1104...	2
PTGNR/L2525M16-CHP	25	25	150	38	25	32	0.8	TN**1604...	2

Torque: Recommended clamping torque: lbs-ft (*N-m)
**RE: Standard corner radius

SPARE PARTS

Designation	Shim	Clamping screw	Wrench 1	Spring pin	Lever
PTGNR/L**23-CHP, PTGNR/L**1104-CHP	-	LCS23A	P-2.5	LSP3	LCL23
PTGNR/L1*3-CHP, PTGNR/L**16-CHP	LST317	LCS3	P-2.5	LSP3	LCL3

SPARE PARTS

Designation	Coolant unit	Mounting screw	Wrench 2	O-ring	Coolant screw	Wrench 3
PTGNR/L**23-CHP, PTGNR/L**1104-CHP	CU-CW-CHP	SRM3	T-8F	OR6.4X0.9N	SRM4X4TL360	P-2
PTGNR/L1*3-CHP, PTGNR/L**16-CHP	CU-CW-CHP	SRM3	T-8F	OR6.4X0.9N	SRM4X4TL360	P-2

INSERT SELECTION

P

Application	Precision finishing	Finishing	Medium cutting	Medium to heavy cutting
Grade	NS9530	GT9530	T9215	T9215
Chipbreaker Shape	TF	TSF	TM	TH
Cutting conditions	B008			

M

Application	Finishing	Medium cutting
Grade	T6120	T6130
Chipbreaker Shape	SF	SM
Cutting conditions	B010	

K

Application	Finishing	Medium cutting	Medium to heavy cutting
Grade	T515	T515	T515
Chipbreaker Shape	All-round	All-round	All-round
Cutting conditions	B012		

N

Application	Precision finishing	Finishing	Medium cutting
Grade	DX120	DX140	TH10
Chipbreaker Shape	T-DIA	with rake T-DIA	P
Cutting conditions	B014		

S

Application	Precision finishing	Finishing	Medium cutting
Grade	BX470	AH8005	AH8005
Chipbreaker Shape	T-CBN	HRF	HRM
Cutting conditions	B016		

H

Application	Precision finishing	Finishing
Grade	BXM10	BXM20
Chipbreaker Shape	T-CBN	T-CBN
Cutting conditions	B018	

Reference pages: PTGNR/L-CHP: Inserts → B086 -, CBN → B178 -, PCD → B194 -
Parts for coolant hose → C142

PTGNR/L

Lever-lock toolholder with 91° approach angle, for negative 60° triangular inserts

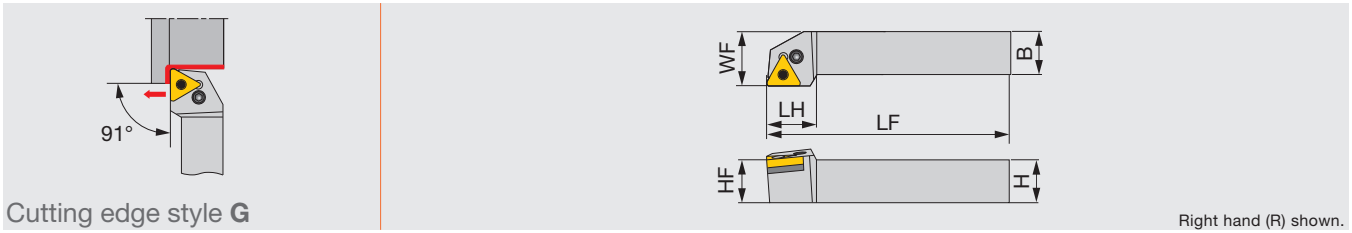

Cutting edge style **G**

Right hand (R) shown.

Metric	H	B	LF	LH	HF	WF	RE**	Insert
PTGNR/L1616	16	16	100	22	16	20	0.8	TN**1604...
PTGNR/L2020	20	20	125	22	20	25	0.8	TN**1604...
PTGNR/L2525M3	25	25	150	22	25	32	0.8	TN**1604...
PTGNR/L2525M4	25	25	150	28	25	32	0.8	TN**2204...
PTGNR3225P4	32	25	170	28	32	32	0.8	TN**2204...

**RE: Standard corner radius

SPARE PARTS

Designation	Shim	Clamping screw	Wrench	Spring pin	Lever
PTGNR/L1616, 2020	LST317	LCS3	P-2.5	LSP3	LCL3
PTGNR/L2525M3	LST317	LCS3	P-2.5	LSP3	LCL3
PTGNR/L2525M4	LST42	LCS4	P-3	LSP4	LCL4
PTGNR3225P4	LST42	LCS4	P-3	LSP4	LCL4

INSERT SELECTION

Application	Precision finishing	Finishing	Medium cutting	Medium to heavy cutting
	Grade	NS9530	GT9530	T9215
Chipbreaker Shape	TF	TSF	TM	TH
Cutting conditions	B008			

Application	Finishing	Medium cutting
	Grade	T6120
Chipbreaker Shape	SF	SM
Cutting conditions	B010	

Application	Finishing	Medium cutting	Medium to heavy cutting
	Grade	T515	T515
Chipbreaker Shape	All-round	All-round	All-round
Cutting conditions	B012		

Application	Precision finishing	Finishing	Medium cutting
	Grade	DX120	DX140
Chipbreaker Shape	T-DIA	with rake T-DIA	P
Cutting conditions	B014		

Application	Precision finishing	Finishing	Medium cutting
	Grade	BX470	AH8005
Chipbreaker Shape	T-CBN	HRF	HRM
Cutting conditions	B016		

Application	Precision finishing	Finishing
	Grade	BXM10
Chipbreaker Shape	T-CBN	T-CBN
Cutting conditions	B018	

Reference pages: PTGNR/L: Inserts → **B086 -**, CBN → **B178 -**, PCD → **B194 -**



DTGNR/L

"One-Double" toolholder with 91° approach angle, for negative 60° triangular inserts

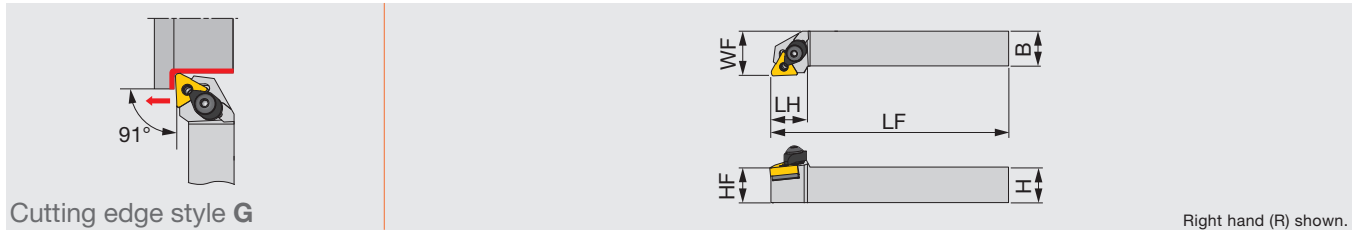

Cutting edge style G

Right hand (R) shown.

Metric	H	B	LF	LH	HF	WF	RE**	Insert
DTGNR/L2020K16	20	20	125	21	20	25	0.8	TN**1604...
DTGNR/L2525M16	25	25	150	21	25	32	0.8	TN**1604...
DTGNR/L2525M22	25	25	150	28	25	32	0.8	TN**2204...

Except for 57-type chipbreaker inserts
**RE: Standard corner radius

SPARE PARTS

Designation	Clamp	Lever	Piston	Clamp screw	Shim	Spring	Spring pin	Wrench 1	Wrench 2
DTGNR/L**16	DCPM-33	LCL33	DPIS33	DLCS33	LST317	BP-9	LSP3	P-2.5	P-3
DTGNR/L**22	DCPM-43	DLCL43	DPIS43	DLCS43	LST42	BP-10	LSP4	P-3	P-4

INSERT SELECTION

Application	Precision finishing	Finishing	Medium cutting	Medium to heavy cutting
Grade	NS9530	GT9530	T9215	T9215
Chipbreaker Shape	TF	TSF	TM	TH
Cutting conditions	B008			

Application	Finishing	Medium cutting
Grade	T6120	T6130
Chipbreaker Shape	SF	SM
Cutting conditions	B010	

Application	Finishing	Medium cutting	Medium to heavy cutting
Grade	T515	T515	T515
Chipbreaker Shape	All-round	All-round	All-round
Cutting conditions	B012		

Application	Precision finishing	Finishing	Medium cutting
Grade	DX120	DX140	TH10
Chipbreaker Shape	T-DIA	with rake T-DIA	P
Cutting conditions	B014		

Application	Precision finishing	Finishing	Medium cutting
Grade	BX470	AH8005	AH8005
Chipbreaker Shape	T-CBN	HRF	HRM
Cutting conditions	B016		

Application	Precision finishing	Finishing
Grade	BXM10	BXM20
Chipbreaker Shape	T-CBN	T-CBN
Cutting conditions	B018	

Reference pages: DTGNR/L: Inserts → B086 -, CBN → B178 -, PCD → B194 -

STGCR/L

Screw-on system toolholder with 91° approach angle for positive 60° triangular inserts

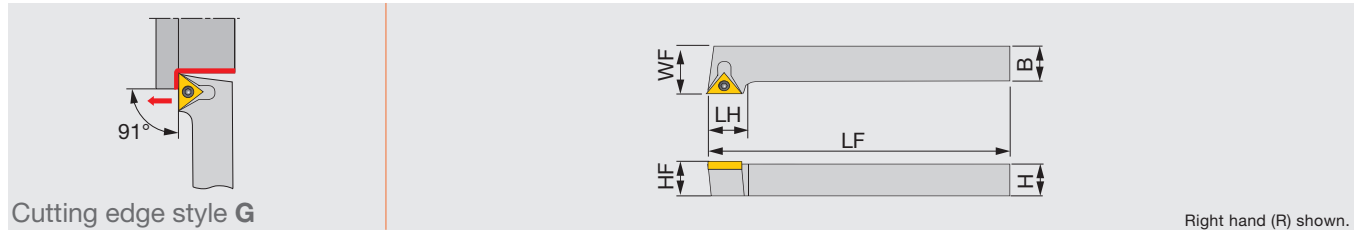

Inch	H	B	LF	LH	HF	WF	Insert
STGCR/L062	0.375	0.375	2.500	0.625	0.375	0.500	TC**21.5...
STGCR/L082	0.500	0.500	3.500	0.625	0.500	0.625	TC**21.5...
STGCR/L103	0.625	0.625	4.000	0.750	4.000	0.750	TC**32.5...
STGCR/L123	0.750	0.750	4.500	0.750	4.500	1.000	TC**32.5...

Except for 57-type chipbreaker inserts

SPARE PARTS				
Designation	Shim	Shim screw	Clamp screw	Wrench
STGCR/L0...	-	-	CSTB2.5	T-7F
STGCR/L1...	SKTP-343	SRS-3	CSTB3.5	T-15F

INSERT SELECTION

Application	Precision finishing	Finishing	Finishing to medium cutting	Medium cutting
	Grade	SH725	SH725	T9215
Chipbreaker shape	01	JS	PS	PM
Cutting conditions	B020			

Application	Precision finishing	Finishing	Finishing to medium cutting	Medium cutting
	Grade	SH725	SH725	T9215
Chipbreaker shape	01	JS	PS	PM
Cutting conditions	B022			

Application	Finishing to medium cutting
	Grade
Chipbreaker shape	CM
Cutting conditions	B024

Application	Precision finishing	Medium cutting
	Grade	DX120
Chipbreaker shape	T-DIA	with rake AL
Cutting conditions	B026	

Reference pages: STGCR/L: Inserts → **B139 -**, PCD → **B196**



PCBNR/L

Lever-lock toolholder with 75° approach angle, for negative 80° rhombic inserts

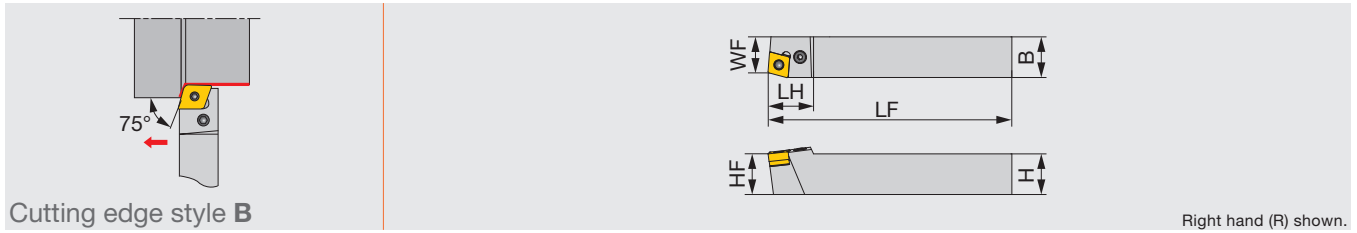

Metric	H	B	LF	LH	HF	WF	RE**	Insert
PCBNR/L2525	25	25	150	28	25	22	0.8	CN**1204...

100° corner is used.
**RE: Standard corner radius

SPARE PARTS					
Designation	Shim	Clamping screw	Wrench	Spring pin	Lever
PCBNR/L2525	LSC42	LCS4	P-3	LSP4	LCL4

INSERT SELECTION

P	Application	Precision finishing	Finishing	Medium cutting	Medium to heavy cutting
	Grade	NS9530	GT9530	T9215	T9215
	Chipbreaker Shape	TF	TSF	TM	TH
	Cutting conditions	B008			

M	Application	Finishing	Medium cutting	Medium to heavy cutting
	Grade	T6120	T6130	T6130
	Chipbreaker Shape	SF	SM	SH
	Cutting conditions	B010		

K	Application	Finishing	Medium cutting	Medium to heavy cutting
	Grade	T515	T515	T515
	Chipbreaker Shape	All-round	All-round	All-round
	Cutting conditions	B012		

N	Application	Medium cutting
	Grade	TH10
	Chipbreaker Shape	P
	Cutting conditions	B014

S	Application	Finishing	Medium cutting
	Grade	AH8005	AH8005
	Chipbreaker Shape	HRF	HRM
	Cutting conditions	B016	

Reference pages: PCBNR/L: Inserts → B056 -, CBN → B172 -, PCD → B194 -

Screw-on toolholder for roughing with 75° approach angle, for negative tangential inserts

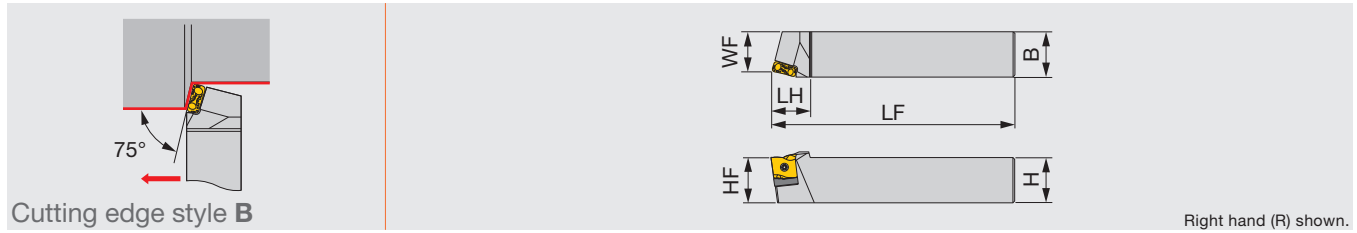

Inch	H	B	LF	LH	HF	WF	Insert
TLBNR/L24-24	1.500	1.500	7.874	1.378	1.500	1.378	LNMX2410**R/L...

SPARE PARTS

Designation	Clamping screw	Shim	Spring pin	Wrench
TLBNR24-24	CSTB-5L163-S	TSL24R	PSP-16	KEYV-T20
TLBNL24-24	CSTB-5L163-S	TSL24L	PSP-16	KEYV-T20

INSERT

LNMX12/16/24

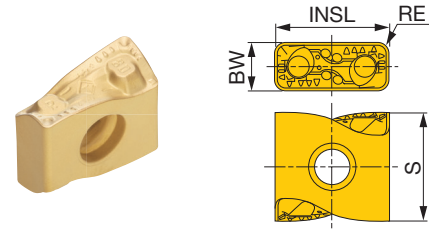

P Steel	★	★	★			
M Stainless			☆			
K Cast iron	☆	☆	☆			
N Non-ferrous						
S Superalloys						
H Hard materials						

★ : First choice
☆ : Second choice

Designation	HAND	RE (in)	Coated			BW (in)	INSL (in)	S (in)
			T9115	T9125	AH725			
LNMX120408R-TDR	R	0.031	●	●		0.189	0.472	0.457
LNMX120408L-TDR	L	0.031	●	●		0.189	0.472	0.457
LNMX120412R-TDR	R	0.047	●	●		0.189	0.472	0.457
LNMX120412L-TDR	L	0.047	●	●		0.189	0.472	0.457
LNMX160608R-TDR	R	0.031	●	●		0.252	0.638	0.531
LNMX160608L-TDR	L	0.031	●	●		0.252	0.638	0.531
LNMX160612R-TDR	R	0.047	●	●		0.252	0.638	0.531
LNMX160612L-TDR	L	0.047	●	●		0.252	0.638	0.531
LNMX160616R-TDR	R	0.063	●	●		0.252	0.638	0.531
LNMX160616L-TDR	L	0.063	●	●		0.252	0.638	0.531
LNMX241016R-TDR	R	0.063	●	●		0.370	0.945	0.807
LNMX241016L-TDR	L	0.063	●	●		0.370	0.945	0.807
LNMX241024R-TDR	R	0.094	●	●		0.370	0.945	0.807
LNMX241024L-TDR	L	0.094	●	●		0.370	0.945	0.807
LNMX160608R-MDR	R	0.031	●	●	●	0.252	0.638	0.531
LNMX160608L-MDR	L	0.031	●	●	●	0.252	0.638	0.531
LNMX160612R-MDR	R	0.047	●	●	●	0.252	0.638	0.531
LNMX160612L-MDR	L	0.047	●	●	●	0.252	0.638	0.531
LNMX160608R-TWR	R	0.031	●	●		0.252	0.638	0.531
LNMX160608L-TWR	L	0.031	●	●		0.252	0.638	0.531
LNMX160612R-TWR	R	0.047	●	●		0.252	0.638	0.531
LNMX160612L-TWR	L	0.047	●	●		0.252	0.638	0.531

● : Line up

Reference pages:
Standard cutting conditions → **C144**

Double-clamp toolholder with 75° approach angle, for negative square inserts

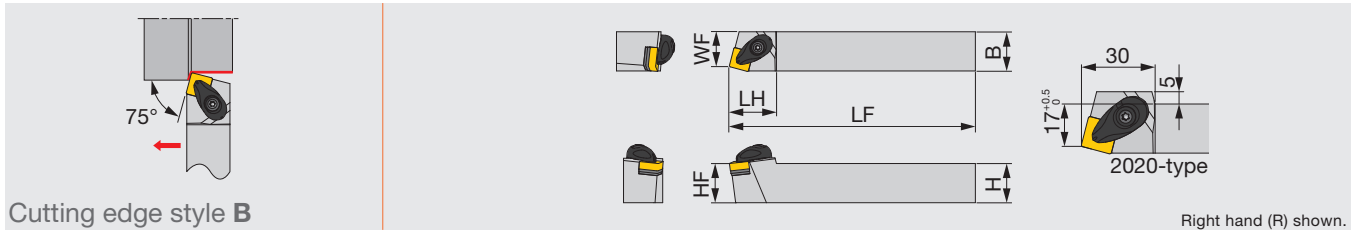

Right hand (R) shown.

Inch	H	B	LF	LH	HF	WF	RE**	Insert	Torque
ASBNR/L124-A	0.750	0.750	4.500	1.180	0.750	0.625	0.031	SN**43...	2.2
ASBNR/L164-A	1.000	1.000	6.000	1.180	1.000	0.875	0.031	SN**43...	2.2
ASBNR/L205-A	1.250	1.250	7.000	1.500	1.250	1.100	0.031	SN**54...	4.7
ASBNR/L245-A	1.500	1.500	8.000	1.500	1.500	1.350	0.031	SN**54...	4.7
ASBNR/L206-A	1.250	1.250	7.000	1.625	1.250	1.100	0.031	SN**64...	4.7
ASBNR/L246-A	1.500	1.500	8.000	1.625	1.500	1.350	0.031	SN**64...	4.7

Metric	H	B	LF	LH	HF	WF	RE**	Insert	Torque*
ASBNR/L2020K12-A	20	20	125	30	20	17	0.8	SN**1204...	3
ASBNR/L2525M12-A	25	25	150	30	25	22	0.8	SN**1204...	3
ASBNR/L2525M15-A	25	25	150	42.5	25	22	1.2	SN**1506...	6.4
ASBNR/L3232P15-A	32	32	170	42.5	32	27	1.2	SN**1506...	6.4
ASBNR/L3232P19-A	32	32	170	47.5	32	27	1.2	SN**1906...	6.4
ASBNR/L4040S19-A	40	40	250	47.5	40	35	1.2	SN**1906...	6.4

Torque: Recommended clamping torque: lbs-ft (*N-m)

**RE: Standard corner radius

SPARE PARTS

Designation	Clamp	Clamp screw	Spring	Spring pin	Shim	Shim screw	Wrench 1	Wrench 2
ASBNR/L**4-A, 12-A	ACP4S	ACS-5W	BP-7	SP-2.5	ASS422	CSTB-3.5	T-15F	-
ASBNR/L**5-A, 15-A	ACP5S	ACS-6W	BP-8.8	SP-2.5	ASS533	CSTB-5	-	KEYV-T20
ASBNR/L**6-A, 19-A	ACP6S	ACS-6W	BP-8.8	SP-2.5	ASS634	CSTB-5	-	KEYV-T20

INSERT SELECTION

Application	Precision finishing	Finishing	Medium cutting	Medium to heavy cutting
	Grade	Grade	Grade	Grade
	NS9530	GT9530	T9215	T9215
Chipbreaker Shape	TF	TSF	TM	TH
Cutting conditions	B008			

Application	Finishing	Medium cutting	Medium to heavy cutting
	Grade	Grade	Grade
	T6120	T6130	T6130
Chipbreaker Shape	SF	SM	SH
Cutting conditions	B010		

Application	Finishing	Medium cutting	Medium to heavy cutting
	Grade	Grade	Grade
	T515	T515	T515
Chipbreaker Shape	All-round	All-round	All-round
Cutting conditions	B012		

Application	Finishing	Medium cutting
	Grade	Grade
	DX140	TH10
Chipbreaker Shape	T-DIA	P
Cutting conditions	B014	

Application	Precision finishing	Finishing	Medium cutting
	Grade	Grade	Grade
	BX480	AH8005	AH8005
Chipbreaker Shape	T-CBN	HRF	HRM
Cutting conditions	B016		

Reference pages: ASBNR/L: Inserts → B077 -, CBN → B177, PCD → B195

PSBNR/L

Lever-lock toolholder with 75° approach angle, for negative square inserts

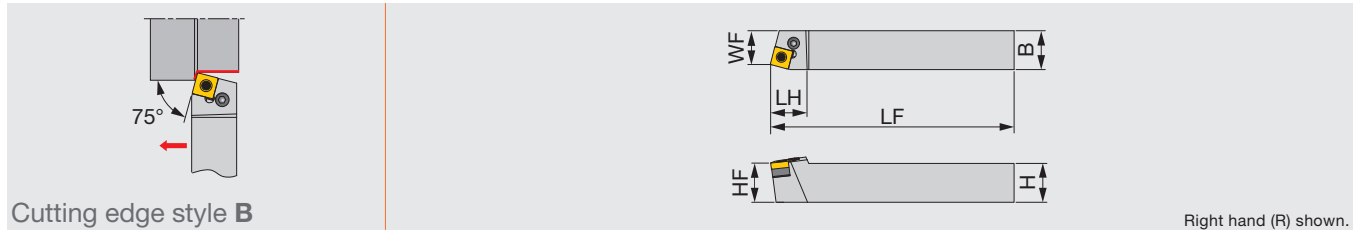

Metric	H	B	LF	LH	HF	WF	RE**	Insert
PSBNR/L1616	16	16	100	22	16	13	0.8	SN**0903...
PSBNR/L2020	20	20	125	28	20	17	0.8	SN**1204...
PSBNR/L2525	25	25	150	24	25	22	0.8	SN**1204...
PSBNR/L3232	32	32	170	40	32	27	1.2	SN**1906...

**RE: Standard corner radius

SPARE PARTS

Designation	Shim	Clamping screw	Wrench	Spring pin	Lever
PSBNR/L1616	LSS33	LCS3	P-2.5	LSP3L	LCL3
PSBNR/L2*2*	LSS42	LCS4	P-3	LSP4	LCL4
PSBNR/L3232	LSS63	LCS6	P-4	LSP6	LCL6

DSBNR/L

"One-Double" toolholder with 75° approach angle, for negative square inserts

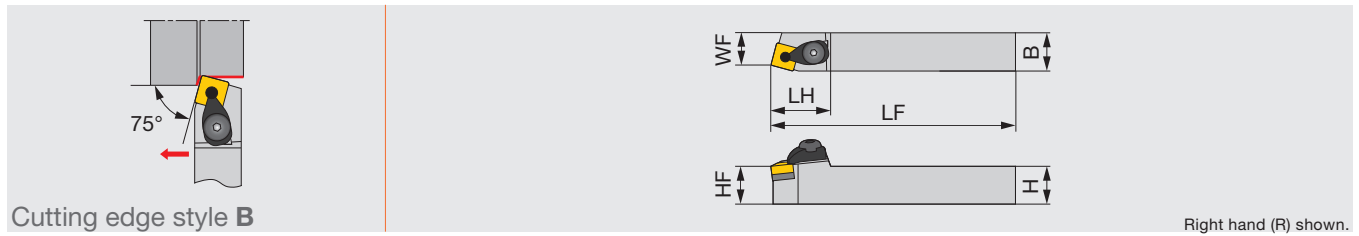

Metric	H	B	LF	LH	HF	WF	RE**	Insert
DSBNR/L2020K12	20	20	125	35	20	17	0.8	SN**1204...
DSBNR/L2525M12	25	25	150	35	25	22	0.8	SN**1204...

Except for 57-type chipbreaker inserts **RE: Standard corner radius

SPARE PARTS

Designation	Clamp	Lever	Piston	Clamp screw	Shim	Spring	Spring pin	Wrench 1	Wrench 2
DSBNR/L...	DCPM-43	DLCL43	DPIS43	DLCS43	LSS42	BP-10	LSP4	P-3	P-4

INSERT SELECTION

P	Application	Precision finishing	Finishing	Medium cutting	Medium to heavy cutting
	Grade	NS9530	GT9530	T9215	T9215
	Chipbreaker Shape	TF	TSF	TM	TH
	Cutting conditions	B008			

M	Application	Finishing	Medium cutting	Medium to heavy cutting
	Grade	T6120	T6130	T6130
	Chipbreaker Shape	SF	SM	SH
	Cutting conditions	B010		

K	Application	Finishing	Medium cutting	Medium to heavy cutting
	Grade	T515	T515	T515
	Chipbreaker Shape	All-round	All-round	All-round
	Cutting conditions	B012		

N	Application	Finishing	Medium cutting
	Grade	DX140	TH10
	Chipbreaker Shape	T-DIA	P
	Cutting conditions	B014	

S	Application	Precision finishing	Finishing	Medium cutting
	Grade	BX480	AH8005	AH8005
	Chipbreaker Shape	T-CBN	HRF	HRM
	Cutting conditions	B016		

Reference pages: PSBNR/L, DSBNR/L:
 Inserts → **B077 -**, CBN → **B177**, PCD → **B195**



Double-clamp toolholder with 75° approach angle, for negative 80° rhombic inserts

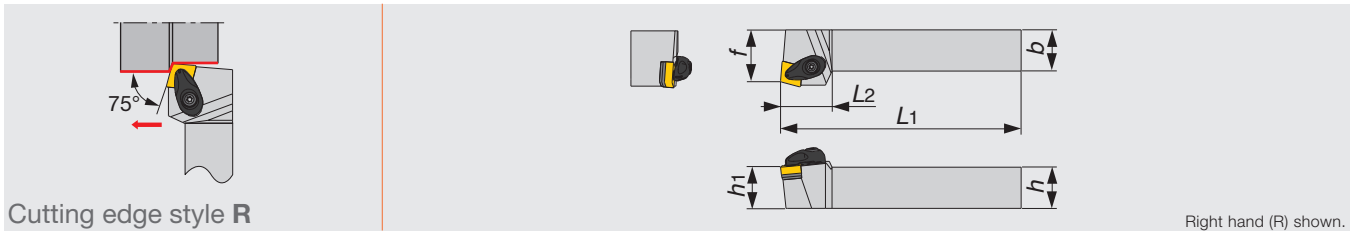

Right hand (R) shown.

Inch	H	B	LF	LH	HF	WF	RE**	Insert	Torque
ACRNR/L164-A	1.000	1.000	6.000	1.25	1.000	1.25	0.032	CN**43...	2.2

Torque: Recommended clamping torque: lbs-ft
 **RE: Standard corner radius

SPARE PARTS

Designation	Clamp	Clamp screw	Spring	Spring pin	Shim	Shim screw	Wrench 1
ACRNR/L164-A	ACP4S	ACS-5W	BP-7	SP-2.5	ASC422	CSTB-3.5	T-15F

INSERT SELECTION

Application	Precision finishing	Finishing	Medium cutting	Medium to heavy cutting
Grade	NS9530	GT9530	T9215	T9215
Chipbreaker shape	TF	TSF	TM	TH
Cutting conditions	B008			

Application	Finishing	Medium cutting	Medium to heavy cutting
Grade	T6120	T6130	T6130
Chipbreaker shape	SF	SM	SH
Cutting conditions	B010		

Application	Finishing	Medium cutting	Medium to heavy cutting
Grade	T515	T515	T515
Chipbreaker shape	All-round	All-round	All-round
Cutting conditions	B012		

Application	Precision finishing	Finishing	Medium cutting
Grade	DX120	DX140	TH10
Chipbreaker shape	T-DIA	with rake T-DIA	P
Cutting conditions	B014		

Application	Precision finishing	Finishing	Medium cutting
Grade	BX470	AH8005	AH8005
Chipbreaker shape	T-CBN	HRF	HRM
Cutting conditions	B016		

Application	Precision finishing	Finishing
Grade	BXM10	BXM20
Chipbreaker shape	T-CBN	T-CBN
Cutting conditions	B018	

Reference pages: ACRNR/L: Inserts → B056 -, CBN → B172 -, PCD → B194 -

HSRNR/L

Retract-pin toolholder with 75° approach angle, for negative square inserts

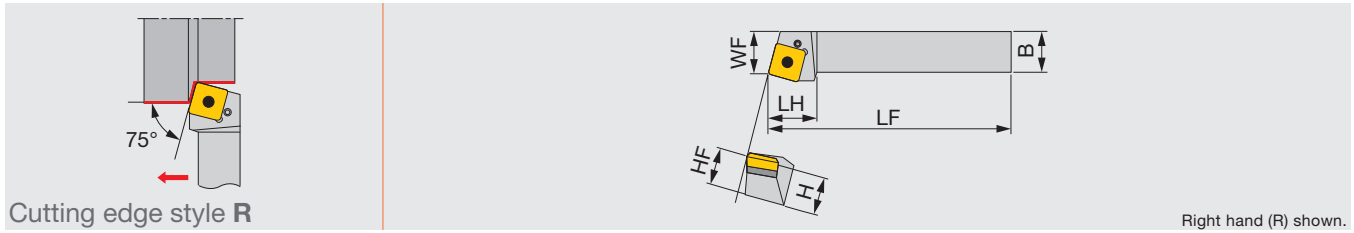

Metric	H	B	LF	LH	HF	WF	RE**	Insert
HSRNR/L4040R	40	40	200	50	40	43	1.6	SNMM3109...
HSRNR/L5050S	50	50	250	60	50	53	1.6	SNMM3109...

**RE: Standard corner radius

SPARE PARTS

Designation	Pin	Clamping screw	Shim	Wrench
HSRNR/L...	SW99	LS-8	NAS-04	P-4

INSERT SELECTION

Application	Precision finishing	Finishing	Medium cutting	Medium to heavy cutting
	Grade	NS9530	GT9530	T9215
Chipbreaker Shape	TF	TSF	TM	TH
Cutting conditions	B008			

Application	Finishing	Medium cutting	Medium to heavy cutting
	Grade	T6120	T6130
Chipbreaker Shape	SF	SM	SH
Cutting conditions	B010		

Application	Finishing	Medium cutting	Medium to heavy cutting
	Grade	T515	T515
Chipbreaker Shape	All-round	All-round	All-round
Cutting conditions	B012		

Application	Finishing	Medium cutting
	Grade	DX140
Chipbreaker Shape	T-DIA	P
Cutting conditions	B014	

Application	Precision finishing	Finishing	Medium cutting
	Grade	BX480	AH8005
Chipbreaker Shape	T-CBN	HRF	HRM
Cutting conditions	B016		

Reference pages: HSRNR/L: Inserts → B083

Lever-lock toolholder with 48.5° approach angle, for negative 108° pentagonal inserts

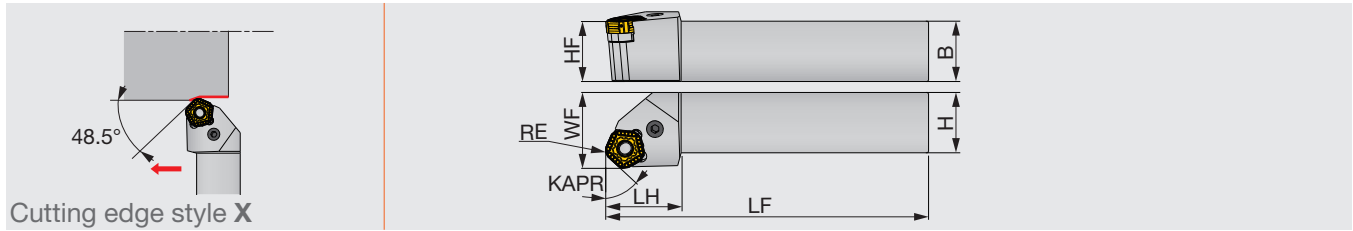

Cutting edge style X

Inch	H	B	LF	LH	HF	WF	KAPR	RE	Insert
PPXOR/L165-HD	1.000	1.000	6.000	1.380	1.000	1.260	48.5°	0.047	POMG110612
PPXOR/L206-HD	1.250	1.250	7.000	1.500	1.250	1.510	48.5°	0.047	POMG130612

Metric	H	B	LF	LH	HF	WF	KAPR	RE	Insert
PPXOR/L2525M11-HD	25	25	150	35	25	32	48.5°	1.2	POMG110612
PPXOR/L3232P13-HD	32	32	170	40	32	40	48.5°	1.2	POMG130612

SPARE PARTS					
Designation	Shim	Spring pin	Lever	Clamping screw	Wrench
PPXOR/L165-HD PPXOR/L2525M11-HD	LSP053	LSP5	LCL5	LCS5	P-3
PPXOR/L206-HD PPXOR/L3232P13-HD	LSP063	LSP6	LCL6	LCS6	P-4

Lever-lock toolholder with 22.5° approach angle, for negative 108° pentagonal inserts

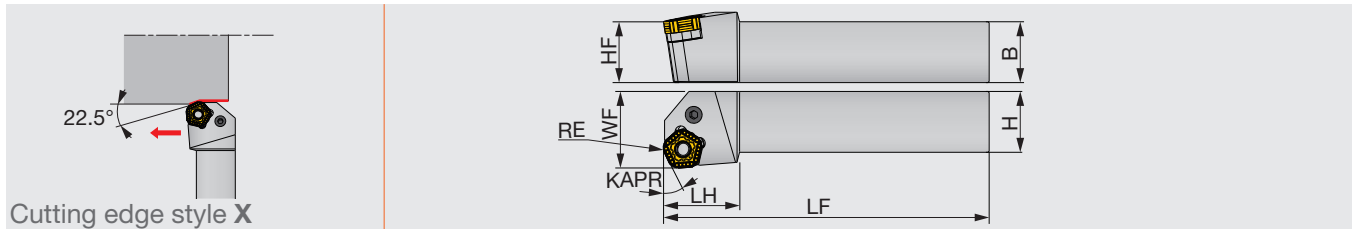

Cutting edge style X

Inch	H	B	LF	LH	HF	WF	KAPR	RE	Insert
PPXOR/L165-HF	1.000	1.000	6.000	1.380	1.000	1.260	22.5°	0.047	POMG110612
PPXOR/L206-HF	1.250	1.250	7.000	1.500	1.250	1.510	22.5°	0.047	POMG130612

Metric	H	B	LF	LH	HF	WF	KAPR	RE	Insert
PPXOR/L2525M11-HF	25	25	150	35	25	32	22.5°	1.2	POMG110612
PPXOR/L3232P13-HF	32	32	170	40	32	40	22.5°	1.2	POMG130612

SPARE PARTS					
Designation	Shim	Spring pin	Lever	Clamping screw	Wrench
PPXOR/L165-HF PPXOR/L2525M11-HF	LSP053	LSP5	LCL5	LCS5	P-3
PPXOR/L206-HF PPXOR/L3232P13-HF	LSP063	LSP6	LCL6	LCS6	P-4

Note : Since the corner angle of TurnTenFeed insert is 108°, the workpiece corner may require additional post-process to remove stock to achieve a right angle.

Reference pages: Inserts → **C103**, Standard cutting conditions → **C143**

INSERT

POMG-MNW

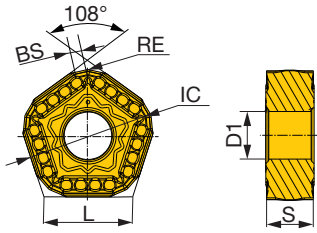

P Steel	★	★	★					
M Stainless				☆				
K Cast iron	☆	☆	☆					
N Non-ferrous								
S Superalloys				★				
H Hard materials								

★ : First choice
☆ : Second choice

Designation	RE (in)	Coated				IC (in)	L (in)	BS (in)	S (in)	D1 (in)
		T9225	T9215	T9125	AH8015					
POMG110612-MNW	0.047	●	●	●	●	0.625	0.454	0.059	0.250	0.047
POMG130612-MNW	0.047	●	●	●	●	0.750	0.545	0.079	0.250	0.047

● : Line up

Grade
Insert
Ext. Toolholder
Int. Toolholder
Threading
Grooving
Miniature Tool
Milling Cutter
Endmill
Drilling Tool
Tooling System
User's Guide
Index



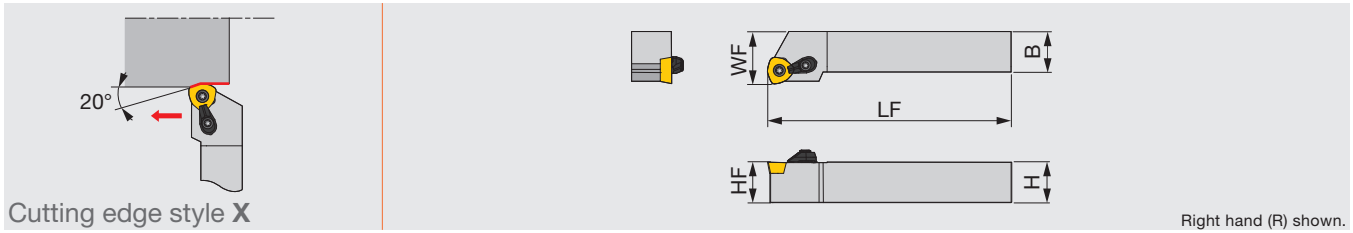

Right hand (R) shown.

Inch	H	B	LF	HF	WF	Insert
XWXPR/L16-09	1.000	1.000	6.000	1.000	1.250	WPMT090725ZPR/L-ML
XWXPR/L20-09	1.250	1.250	7.000	1.250	1.500	WPMT090725ZPR/L-ML
XWXPR/L24-09	1.500	1.500	7.000	1.500	2.000	WPMT090725ZPR/L-ML

SPARE PARTS



Designation	Clamp set	Clamping screw	Wrench
XWXPR/L...	CSY-20	CSPB-5	IP-20T

Each insert is either right- or left-handed. Please be sure not to use a wrong insert.

INSERT

WPMT09-ML

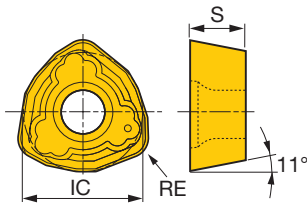

P	Steel	★	★	★	★	★						
M	Stainless					☆						
K	Cast iron	☆	☆	☆	☆	☆						
N	Non-ferrous											
S	Superalloys											
H	Hard materials											

★ : First choice
☆ : Second choice

Designation	Max. ap (in)	RE (in)	Coated					IC (in)	S (in)
			T9225	T9215	T9115	T9125	AH120		
WPMT090725ZPR-ML	0.118	0.098	●	●	●	●	●	0.059	0.276
WPMT090725ZPL-ML	0.118	0.098	●	●	●	●	●	0.059	0.276

● : Line up

PRDCN

Lever-lock toolholder with 45° approach angle, for positive round inserts

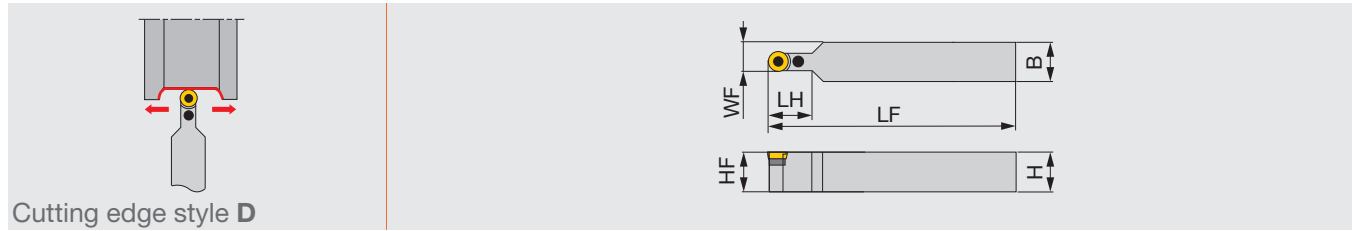

Metric	H	B	LF	LH	HF	WF	Insert
PRDCN2020K10	20	20	125	22	20	15	RCMM1003...
PRDCN2525M12	25	25	150	24	25	18.5	RCM*1204...
PRDCN3225P12	32	25	170	24	32	18.5	RCM*1204...
PRDCN3225P16	32	25	170	28	32	20.5	RCM*1606...
PRDCN3232P20	32	32	170	32	32	26	RCM*2006...
PRDCN4040R25	40	40	200	42	40	32.5	RCM*2507...

SPARE PARTS

Designation	Shim	Clamping screw	Wrench	Spring pin	Lever
PRDCN2020K10	LSR32C	LCS2	P-2	LSP3	LCL3C
PRDCN**25*12	LSR42C	LCS3	P-2.5	LSP3	LCL4C
PRDCN3225P16	LSR53C	LCS5	P-3	LSP4	LCL5C
PRDCN3232P20	LSR63C	LCS5	P-3	LSP6C	LCL6C
PRDCN4040R25	LSR84C	LCS8C	P-4	LSP6	LCL8C

INSERT SELECTION

P	Application	Finishing to medium cutting	Heavy cutting	M	Application	Heavy cutting
	Grade	T9215			Grade	T9215
	Chipbreaker Shape	RS	61		Chipbreaker Shape	61
Cutting conditions		B020		Cutting conditions		B022
K	Application	Heavy cutting		N	Application	Finishing to medium cutting
	Grade	T9215			Grade	KS05F
	Chipbreaker Shape	61			Chipbreaker Shape	AL
Cutting conditions		B024		Cutting conditions		B026
S	Application	Finishing to medium cutting	Heavy cutting			
	Grade	AH8015	AH8015			
	Chipbreaker Shape	RS	61			
Cutting conditions		B028				

Reference pages: PRDCN: Inserts → **B131** -

Grade A
 Insert B
 Ext. Toolholder C
 Int. Toolholder D
 Threading E
 Grooving F
 Milling Cutter G
 Miniature Tool H
 Endmill I
 Drilling Tool J
 User's Guide Tooling System K
 Index L, M

SRDCN

Screw-on toolholder with 45° approach angle, for positive round inserts

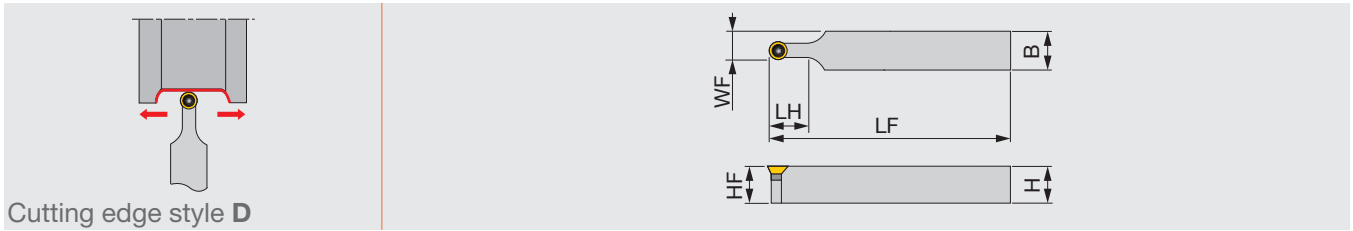

Cutting edge style D







Metric	H	B	LF	LH	HF	WF	Insert
SRDCN2020K06	20	20	125	12	20	13	RC*T0602...
SRDCN2020K08	20	20	125	16	20	14	RC*T0803...
SRDCN2020K10	20	20	125	20.3	25	15	RC*T1003...
SRDCN2525M06	25	25	150	12	25	15.5	RC*T0602...
SRDCN2525M08	25	25	150	16	25	16.5	RC*T0803...
SRDCN2525M10	25	25	150	20.3	25	17.5	RC*T1003...

SPARE PARTS



Designation	Clamping screw	Shim screw	Shim	Wrench 1	Wrench 2
SRDCN2020K06	CSTB-2.5	-	-	-	T-8F
SRDCN2020K08	CSTB-3	-	-	-	T-9F
SRDCN2020K10	CSTB-3.5L	DTS5-3.5	SSR32	P-3.5	T-15F
SRDCN2525M06	CSTB-2.5	-	-	-	T-8F
SRDCN2525M08	CSTB-3	-	-	-	T-9F
SRDCN2525M10	CSTB-3.5L	DTS5-3.5	SSR32	P-3.5	T-15F

INSERT SELECTION

P	Application	Finishing to medium cutting	Heavy cutting	M	Application	Heavy cutting
	Grade	T9215	T9215		Grade	T9215
	Chipbreaker Shape	RS 	61 		Chipbreaker Shape	61 
	Cutting conditions	B020			Cutting conditions	B022
K	Application	Heavy cutting		N	Application	Finishing to medium cutting
	Grade	T9215			Grade	KS05F
	Chipbreaker Shape	61 			Chipbreaker Shape	AL 
	Cutting conditions	B024			Cutting conditions	B026
S	Application	Finishing to medium cutting	Heavy cutting			
	Grade	AH8015	AH8015			
	Chipbreaker Shape	RS 	61 			
	Cutting conditions	B028				

Reference pages: SRDCN: Inserts → **B131** -

Screw-on toolholder with 45° approach angle, for positive round inserts

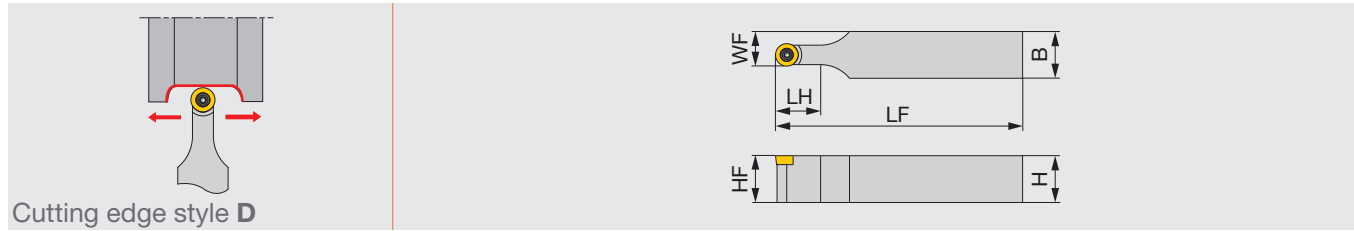

Inch	H	B	LF	LH	HF	WF	Insert	Torque
SRDCN164-6F	1.00	1.00	6.00	0.95	1.00	0.74	RCMT1204M0-6RS/-6RM	2.21
Metric	H	B	LF	LH	HF	WF	Insert	Torque*
SRDCN2525M12-6F	25	25	150	24.1	25	18.5	RCMT1204M0-6RS/-6RM	3

Torque: Recommended clamping torque: lb-ft (*N·m)

SPARE PARTS

Designation	Clamping screw	Lubricant	Wrench
SRDCN164-6F, SRDCN2525M12-6F	CSTB-4	M-1000	T-15F

INSERT

RCMT

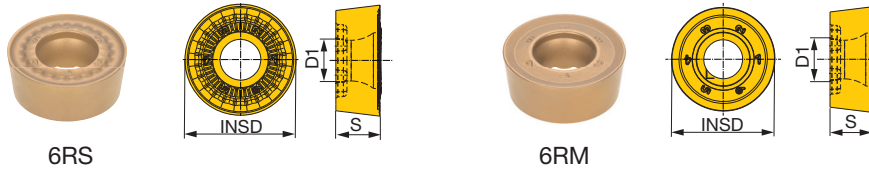

Designation	Coated				Cermet	INSD (in)	S (in)	D1 (in)
	T9225	T9215	T9115	T9125	NS9530			
RCMT1204M0-6RS	●	●	●	●	●	0.472	0.187	0.203
RCMT1204M0-6RM	●	●	●	●	●	0.472	0.187	0.203

★ : First choice
☆ : Second choice

● : Line up



Double-clamp toolholder with 45° approach angle, for negative square inserts

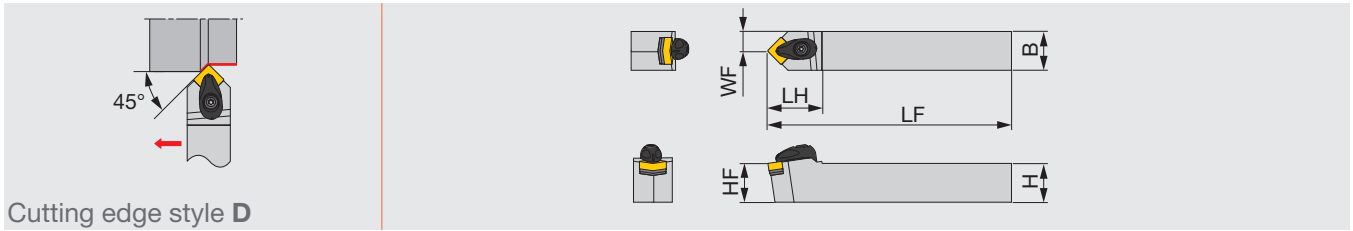

Inch	H	B	LF	LH	HF	WF	RE**	Insert	Torque
ASDNN124-A	0.750	0.750	4.500	1.380	0.750	0.375	0.031	SN**43...	2.2
ASDNN164-A	1.000	1.000	6.000	1.380	1.000	0.500	0.031	SN**43...	2.2

Metric	H	B	LF	LH	HF	WF	RE**	Insert	Torque*
ASDNN2020K12-A	20	20	125	35	20	10	0.8	SN**1204...	3
ASDNN2525M12-A	25	25	150	35	25	12.5	0.8	SN**1204...	3

Torque: Recommended clamping torque: lbs-ft (*N·m) **RE: Standard corner radius

SPARE PARTS

Designation	Clamp	Clamp screw	Spring	Spring pin	Shim	Shim screw	Wrench
ASDNN**4-A, 12-A	ACP4S	ACS-5W	BP-7	SP-2.5	ASS422	CSTB-3.5	T-15F

PSDNN

Lever-lock toolholder with 45° approach angle, for positive round inserts

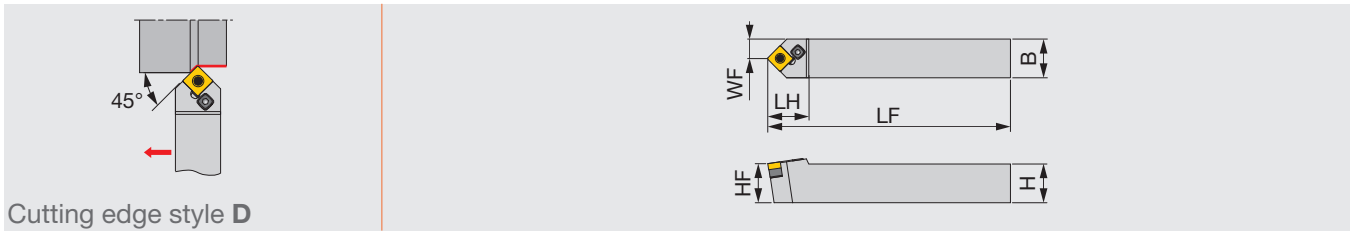

Metric	H	B	LF	LH	HF	WF	RE**	Insert
PSDNN1616	16	16	100	22	16	8	0.8	SN**0903...
PSDNN2020	20	20	125	30	20	10.3	0.8	SN**1204...
PSDNN2525	25	25	150	30	25	12.8	0.8	SN**1204...

**RE: Standard corner radius

SPARE PARTS

Designation	Shim	Clamping screw	Wrench	Spring pin	Lever
PSDNN1616	LSS33	LCS3	P-2.5	LSP3L	LCL3
PSDNN2020	LSS42	LCS4	P-3	LSP4	LCL4
PSDNN2525	LSS42	LCS4	P-3	LSP4	LCL4

DSDNN

One-Double toolholder with 45° approach angle, for negative square inserts

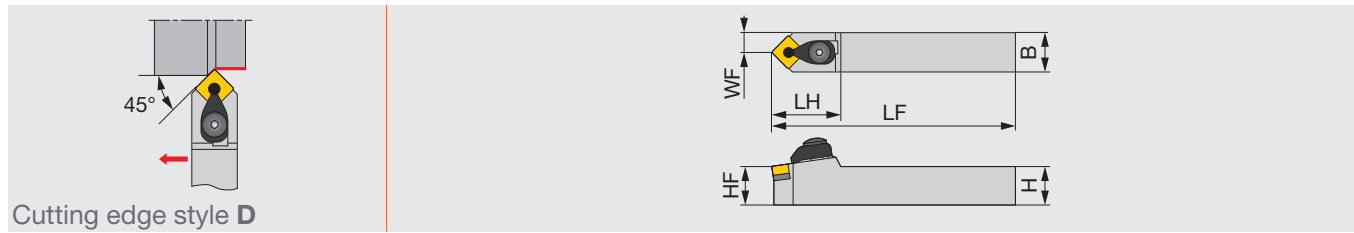

Metric	H	B	LF	LH	HF	WF	RE**	Insert
DSDNN2020K12	20	20	125	36	20	10	0.8	SN**1204...
DSDNN2525M12	25	25	150	36	25	12.5	0.8	SN**1204...

Except for 57-type chipbreaker inserts

**RE: Standard corner radius

SPARE PARTS									
Designation	Clamp	Lever	Piston	Clamp screw	Shim	Spring	Spring pin	Wrench 1	Wrench 2
DSDNN...	DCPM-43	DLCL43	DPIS43	DLCS43	LSS42	BP-10	LSP4	P-3	P-4

INSERT SELECTION

Application	Precision finishing	Finishing	Medium cutting	Medium to heavy cutting
	Grade	NS9530	GT9530	T9215
Chipbreaker Shape				
Cutting conditions	B008			

Application	Finishing	Medium cutting	Medium to heavy cutting
	Grade	T6120	T6130
Chipbreaker Shape			
Cutting conditions	B010		

Application	Finishing	Medium cutting	Medium to heavy cutting
	Grade	T515	T515
Chipbreaker Shape			
Cutting conditions	B012		

Application	Finishing	Medium cutting
	Grade	DX140
Chipbreaker Shape		
Cutting conditions	B014	

Application	Precision finishing	Finishing	Medium cutting
	Grade	BX480	AH8005
Chipbreaker Shape			
Cutting conditions	B016		

Reference pages: DSDNN: Inserts → B077 -, CBN → B177, PCD → B195

SSDC/PN

Screw-on toolholder with 45° approach angle, for positive square inserts

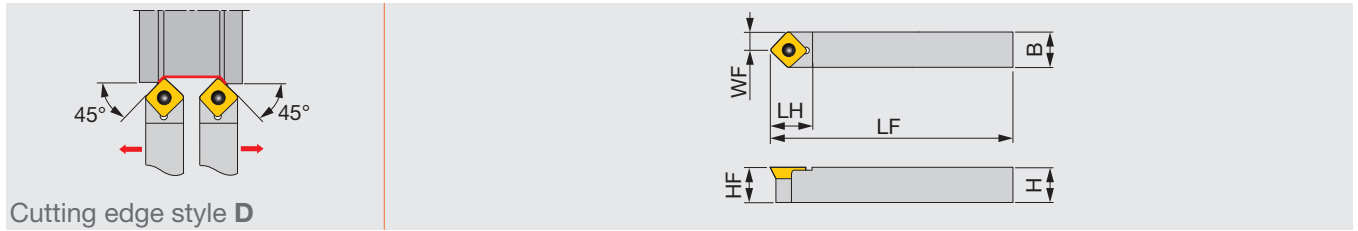

Cutting edge style **D**

Metric	H	B	LF	LH	HF	WF	RE**	Insert
SSDCN1010K07	10	10	125	12	10	5	0.4	SC**0702...
SSDPN1010H	10	10	100	12	10	5	0.4	SP**P042...
SSDCN1212K09	12	12	125	15	12	6	0.8	SC**09T3...
SSDPN1212H	12	12	100	12	12	6	0.4	SP**P042...
SSDCN1616H09	16	16	100	15	16	8	0.8	SC**09T3...
SSDPN1616H	16	16	100	14	16	8	0.8	SP**M322...

**RE: Standard corner radius

SPARE PARTS					
Designation	Clamping screw	Shim screw	Shim	Wrench 1	Wrench 2
SSDCN1010K07	CSTB-3	-	-	-	T-9F
SSDPN1010H	CSTA-NO3	-	-	-	T-9F
SSDCN1212K09	CSTB-4	-	-	-	T-15F
SSDPN1212H	CSTA-NO3	-	-	-	T-9F
SSDCN1616H09	CSTB-3.5L	DTS5-3.5	SSS32	P-3.5	T-15F
SSDPN1616H	CSTA-NO5	-	-	-	T-9F

INSERT SELECTION

P	Application	Finishing to medium cutting	Medium cutting	M	Application	Medium cutting
	Grade	T9215	T9215		Grade	T6130
	Chipbreaker Shape	PS	PM		Chipbreaker Shape	PM
Cutting conditions		B020		Cutting conditions		B022
K	Application	Finishing to medium cutting				
	Grade	T515				
	Chipbreaker Shape	CM				
Cutting conditions		B024				

Reference pages: SSDC/PN: Inserts → **B135**, **J092**

Double-clamp toolholder with 45° approach angle, for negative 120° hexagonal ceramic inserts with dimple

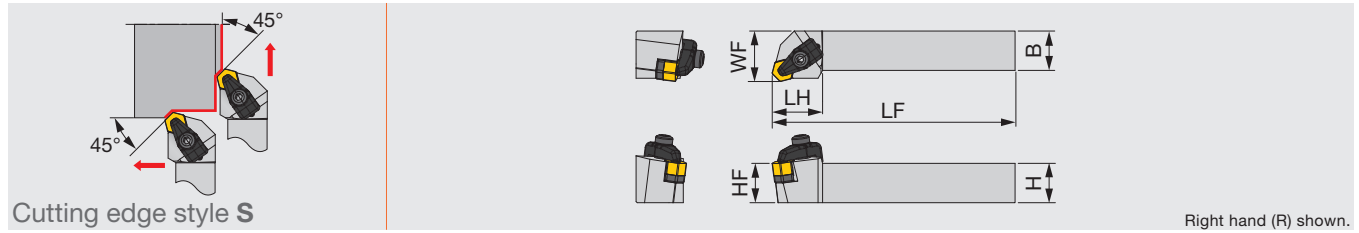

Inch	H	B	LF	LH	HF	WF	RE**	Insert	Torque
CHSNR16M45-RD	1.000	1.000	6.000	1.260	1.000	1.250	0.047	HNGD45...	3.0

Torque: Recommended clamping torque: lb-ft
 **RE: Standard corner radius

SPARE PARTS							
Designation	Clamp	Clamp screw	Shim	Shim screw	Spring	Wrench 1	Wrench 2
CHSNR16M45-RD	CCP4-A	CCS4-A	CH44-A	BH-40050-A	BP-5-A	P-3	P-4

INSERT SELECTION

K	Application	Finishing to medium cutting
	Grade	FX105
	Chipbreaker Shape	
	Cutting conditions	C144

Reference pages: CHSNR-RD: Inserts → **B110**
 Standard cutting conditions → **C144**

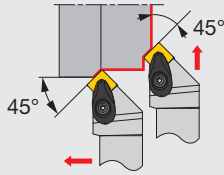

Cutting edge style S

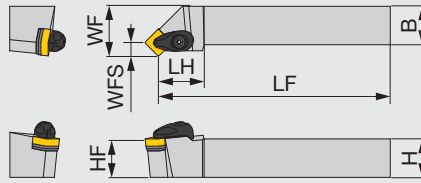

Right hand (R) shown.

Inch	H	B	LF	LH	HF	WF	WFS	RE**	Insert	Torque
ASSNR/L124-A	0.750	0.750	4.500	1.250	0.750	1.000	0.327	0.031	SN**43...	2.2
ASSNR/L164-A	1.000	1.000	6.000	1.250	1.000	1.250	0.327	0.031	SN**43...	2.2
ASSNR/L205-A	1.250	1.250	7.000	1.500	1.250	1.500	0.406	0.031	SN**54...	4.7
ASSNR/L245-A	1.500	1.500	8.000	1.500	1.500	1.750	0.406	0.031	SN**54...	4.7
ASSNR/L206-A	1.250	1.250	7.000	1.500	1.250	1.500	0.492	0.031	SN**64...	4.7
ASSNR/L246-A	1.500	1.500	8.000	1.500	1.500	1.750	0.492	0.031	SN**64...	4.7

Metric	H	B	LF	LH	HF	WF	WFS	RE**	Insert	Torque*
ASSNR/L2020K12-A	20	20	125	30	20	25	8.3	0.8	SN**1204...	3
ASSNR/L2525M12-A	25	25	150	30	25	32	8.3	0.8	SN**1204...	3
ASSNR/L2525M15-A	25	25	150	25	25	32	10.3	1.2	SN**1506...	6.4
ASSNR/L3232P15-A	32	32	170	25	32	40	10.3	1.2	SN**1506...	6.4
ASSNR/L3232P19-A	32	32	170	27.5	32	40	12.5	1.2	SN**1906...	6.4
ASSNR/L4040S19-A	40	40	250	27.5	40	50	12.5	1.2	SN**1906...	6.4

Torque: Recommended clamping torque: lbs-ft (*N·m)

**RE: Standard corner radius

SPARE PARTS

Designation	Clamp	Clamp screw	Spring	Spring pin	Shim	Shim screw	Wrench 1	Wrench 2
ASSNR/L**4-A, 12-A	ACP4S	ACS-5W	BP-7	SP-2.5	ASS422	CSTB-3.5	T-15F	-
ASSNR/L**5-A, 15-A	ACP5S	ACS-6W	BP-8.8	SP-2.5	ASS533	CSTB-5	-	KEYV-T20
ASSNR/L**6-A, 19-A	ACP6S	ACS-6W	BP-8.8	SP-2.5	ASS634	CSTB-5	-	KEYV-T20

INSERT SELECTION

Application	Precision finishing	Finishing	Medium cutting	Medium to heavy cutting
	Grade	Grade	Grade	Grade
	NS9530	GT9530	T9215	T9215
Chipbreaker Shape	TF	TSF	TM	TH
Cutting conditions	B008			

Application	Finishing	Medium cutting	Medium to heavy cutting
	Grade	Grade	Grade
	T6120	T6130	T6130
Chipbreaker Shape	SF	SM	SH
Cutting conditions	B010		

Application	Finishing	Medium cutting	Medium to heavy cutting
	Grade	Grade	Grade
	T515	T515	T515
Chipbreaker Shape	All-round	All-round	All-round
Cutting conditions	B012		

Application	Medium cutting
Grade	TH10
Chipbreaker Shape	P
Cutting conditions	B014

Application	Precision finishing	Finishing	Medium cutting
	Grade	Grade	Grade
	BX480	AH8005	AH8005
Chipbreaker Shape	T-CBN	HRF	HRM
Cutting conditions	B016		

Reference pages: ASSNR/L: Inserts → B077 -, CBN → B177, PCD → B195

PSSNR/L

Lever-lock toolholder with 45° approach angle, for positive round inserts

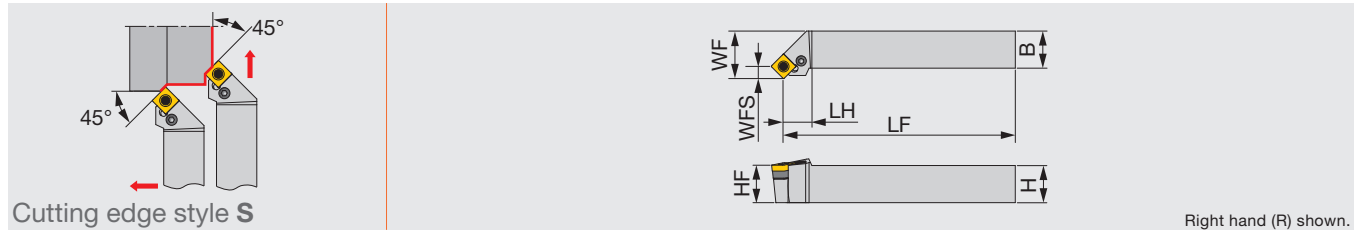

Metric	H	B	LF	LH	HF	WF	WFS	RE**	Insert
PSSNR/L1616	16	16	94	16	16	20	6.1	0.8	SN**0903...
PSSNR/L2020	20	20	116	21	20	25	8.3	0.8	SN**1204...
PSSNR/L2525	25	25	141	21	25	32	8.3	0.8	SN**1204...
PSSNR3225	32	25	161	21	32	32	8.3	0.8	SN**1204...
PSSNR/L3232	32	32	157.5	27.5	32	40	12.5	1.2	SN**1906...

**RE: Standard corner radius

SPARE PARTS

Designation	Shim	Clamping screw	Wrench	Spring pin	Lever
PSSNR/L1616	LSS33	LCS3	P-2.5	LSP3L	LCL3
PSSNR/L2020	LSS42	LCS4	P-3	LSP4	LCL4
PSSNR/L**25	LSS42	LCS4	P-3	LSP4	LCL4
PSSNR/L3232	LSS63	LCS6	P-4	LSP6	LCL6

INSERT SELECTION

Application	Precision finishing	Finishing	Medium cutting	Medium to heavy cutting
	Grade	NS9530	GT9530	T9215
Chipbreaker Shape	TF	TSF	TM	TH
Cutting conditions	B008			

Application	Finishing	Medium cutting	Medium to heavy cutting
	Grade	T6120	T6130
Chipbreaker Shape	SF	SM	SH
Cutting conditions	B010		

Application	Finishing	Medium cutting	Medium to heavy cutting
	Grade	T515	T515
Chipbreaker Shape	All-round	All-round	All-round
Cutting conditions	B012		

Application	Medium cutting
Grade	TH10
Chipbreaker Shape	P
Cutting conditions	B014

Application	Precision finishing	Finishing	Medium cutting
	Grade	BX480	AH8005
Chipbreaker Shape	T-CBN	HRF	HRM
Cutting conditions	B016		

Reference pages: PSSNR/L: Inserts → B077 -, CBN → B177, PCD → B195



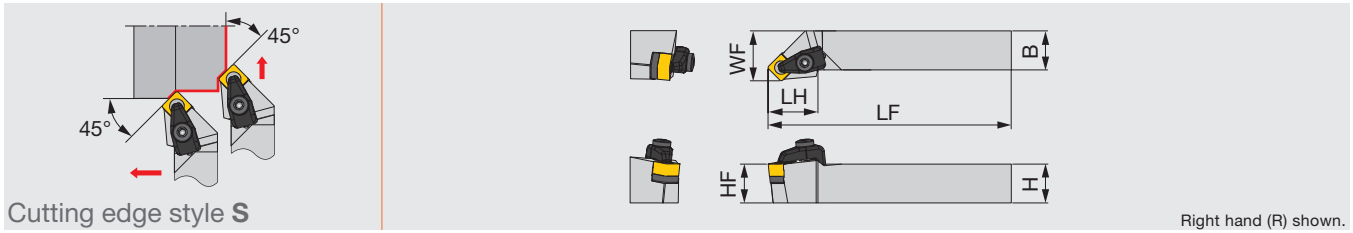

Inch	H	B	LF	LH	HF	WF	RE**	Insert	Torque
CSSNR/L16M45-RD	1.000	1.000	6.000	1.260	1.000	1.250	0.047	SNGD45...	3.0

Torque: Recommended clamping torque: lb-ft
 **RE : Standard corner radius

SPARE PARTS

Designation	Clamp	Clamp screw	Shim	Shim screw	Spring	Wrench 1	Wrench 2
CSSNR/L16M45-RD	CCP4-A	CCS4-A	CS44-A	BH5-10-A	BP-5-A	P-3	P-4

INSERT SELECTION

K	Application	Finishing to medium cutting
	Grade	FX105
	Chipbreaker Shape	
	Cutting conditions	C144

DSSNR/L

"One-Double" toolholder with 45° approach angle, for negative square inserts

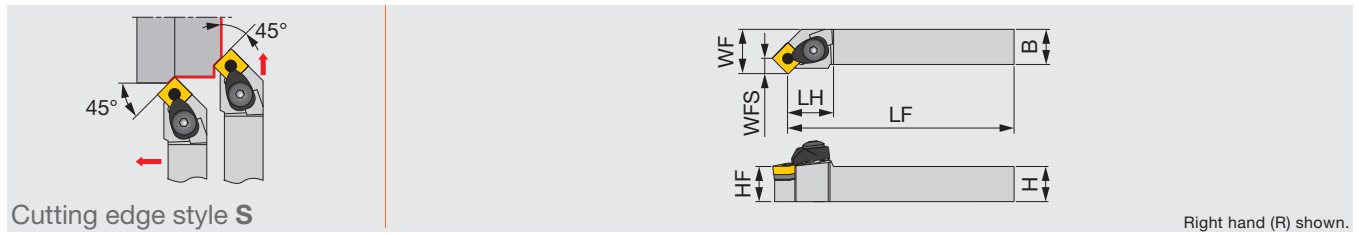

Metric	H	B	LF	LH	HF	WF	WFS	RE**	Insert
DSSNR/L2020K12	20	20	125	34.3	20	25	8.3	0.8	SN**1204...
DSSNR/L2525M12	25	25	150	34.3	25	32	8.3	0.8	SN**1204...

Except for 57-type chipbreaker inserts

**RE : Standard corner radius

SPARE PARTS									
Designation	Clamp	Lever	Piston	Clamp screw	Shim	Spring	Spring pin	Wrench 1	Wrench 2
DSSNR/L...	DCPM-43	DLCL43	DPIS43	DLCS43	LSS42	BP-10	LSP4	P-3	P-4

TURNING

ASKNR/L

Double-clamp toolholder with 75° approach angle, for negative square inserts

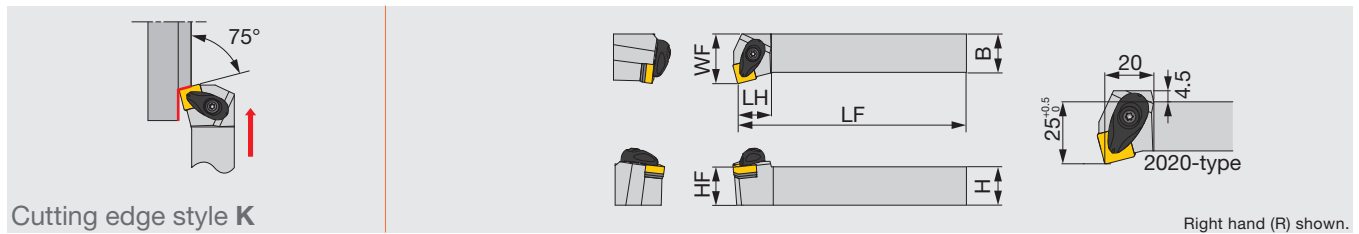

Inch	H	B	LF	LH	HF	WF	RE**	Insert	Torque
ASKNR/L124-A	0.750	0.750	4.500	0.875	0.750	1.000	0.031	SN**43...	2.21
ASKNR/L164-A	1.000	1.000	6.000	1.000	1.000	1.260	0.031	SN**43...	2.21

Torque: Recommended clamping torque: lbs-ft

**RE : Standard corner radius

SPARE PARTS							
Designation	Clamp	Clamp screw	Spring	Spring pin	Shim	Shim screw	Wrench
ASKNR/L*4-A	ACP4S	ACS-5W	BP-7	SP-2.5	ASS422	CSTB-3.5	T-15F

INSERT SELECTION

P	Application	Precision finishing	Finishing	Medium cutting	Medium to heavy cutting
	Grade	NS9530	GT9530	T9215	T9215
Chipbreaker Shape	TF	TSF	TM	TH	
Cutting conditions	B008				

M	Application	Finishing	Medium cutting	Medium to heavy cutting
	Grade	T6120	T6130	T6130
Chipbreaker Shape	SF	SM	SH	
Cutting conditions	B010			

K	Application	Finishing	Medium cutting	Medium to heavy cutting
	Grade	T515	T515	T515
Chipbreaker Shape	All-round	All-round	All-round	
Cutting conditions	B012			

N	Application	Finishing	Medium cutting
	Grade	DX140	TH10
Chipbreaker Shape	T-DIA	P	
Cutting conditions	B014		

S	Application	Precision finishing	Finishing	Medium cutting
	Grade	BX480	AH8005	AH8005
Chipbreaker Shape	T-CBN	HRF	HRM	
Cutting conditions	B016			

Reference pages: DSSNR/L, ASKNR/L:

Inserts → B077 -, CBN → B177, PCD → B195



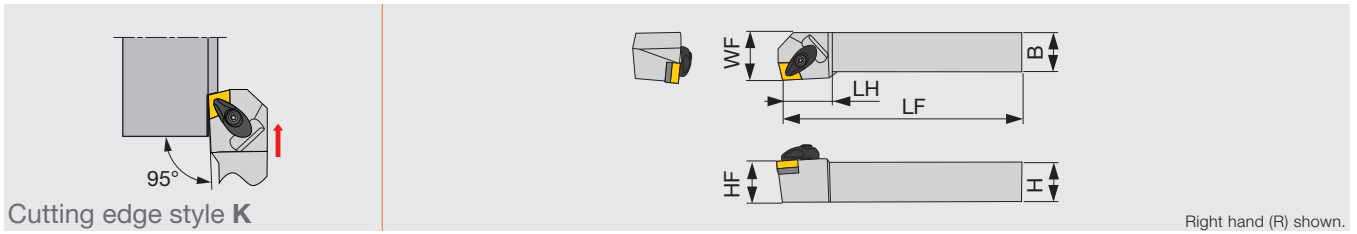

Inch	H	B	LF	LH	HF	WF	RE**	Insert	Torque
ACKNR/L164-A	1.000	1.000	6.000	1.375	1.000	1.312	0.032	CN**43...	2.2

Torque: Recommended clamping torque: lbs-ft
 **RE : Standard corner radius

SPARE PARTS							
Designation	Clamp	Clamp screw	Spring	Spring pin	Shim	Shim screw	Wrench 1
ACKNR/L164-A	ACP4S	ACS-5W	BP-7	SP-2.5	ASC422	CSTB-3.5	T-15F

INSERT SELECTION

P	Application	Precision finishing	Finishing	Medium cutting	Medium to heavy cutting
	Grade	NS9530	GT9530	T9215	T9215
	Chipbreaker shape	TF	TSF	TM	TH
	Cutting conditions	B008			

M	Application	Finishing	Medium cutting	Medium to heavy cutting
	Grade	T6120	T6130	T6130
	Chipbreaker shape	SF	SM	SH
	Cutting conditions	B010		

K	Application	Finishing	Medium cutting	Medium to heavy cutting
	Grade	T515	T515	T515
	Chipbreaker shape	All-round	All-round	All-round
	Cutting conditions	B012		

N	Application	Precision finishing	Finishing	Medium cutting
	Grade	DX120	DX140	TH10
	Chipbreaker shape	T-DIA	with rake T-DIA	P
	Cutting conditions	B014		

S	Application	Precision finishing	Finishing	Medium cutting
	Grade	BX470	AH8005	AH8005
	Chipbreaker shape	T-CBN	HRF	HRM
	Cutting conditions	B016		

H	Application	Precision finishing	Finishing
	Grade	BXM10	BXM20
	Chipbreaker shape	T-CBN	T-CBN
	Cutting conditions	B018	

Reference pages: ACKNR/L: Inserts → B056 -, CBN → B172 -, PCD → B194 -

PSKNR/L

Lever-lock toolholder with 75° approach angle, for negative square inserts

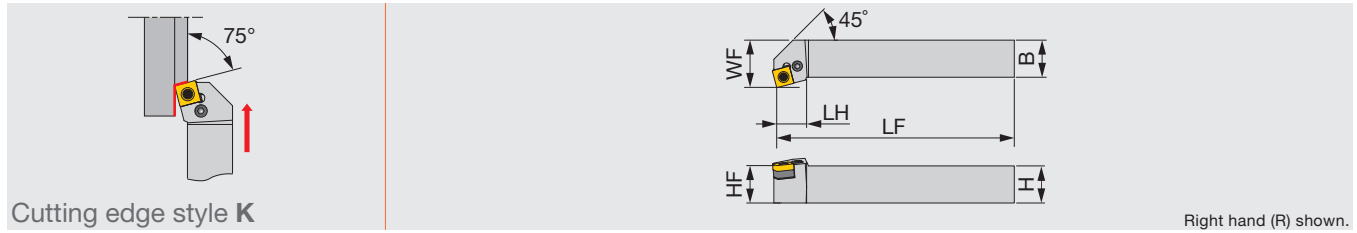

Metric	H	B	LF	LH	HF	WF	RE**	Insert
PSKNR/L1616	16	16	100	17	16	25	0.8	SN**0903...
PSKNR/L2020	20	20	125	22	20	25	0.8	SN**1204...
PSKNR/L2525	25	25	150	22	25	32	0.8	SN**1204...
PSKNR3232	32	32	170	40	32	40	1.2	SN**1906...

**RE : Standard corner radius

SPARE PARTS					
Designation	Shim	Clamping screw	Wrench	Spring pin	Lever
PSKNR/L1616	LSS33	LCS3	P-2.5	LSP3L	LCL3
PSKNR/L2*2*	LSS42	LCS4	P-3	LSP4	LCL4
PSKNR3232	LSS63	LCS6	P-4	LSP6	LCL6

INSERT SELECTION

P	Application	Precision finishing	Finishing	Medium cutting	Medium to heavy cutting
	Grade	NS9530	GT9530	T9215	T9215
Chipbreaker Shape	TF	TSF	TM	TH	
Cutting conditions	B008				

M	Application	Finishing	Medium cutting	Medium to heavy cutting
	Grade	T6120	T6130	T6130
Chipbreaker Shape	SF	SM	SH	
Cutting conditions	B010			

K	Application	Finishing	Medium cutting	Medium to heavy cutting
	Grade	T515	T515	T515
Chipbreaker Shape	All-round	All-round	All-round	
Cutting conditions	B012			

N	Application	Finishing	Medium cutting
	Grade	DX140	TH10
Chipbreaker Shape	T-DIA	P	
Cutting conditions	B014		

S	Application	Precision finishing	Finishing	Medium cutting
	Grade	BX480	AH8005	AH8005
Chipbreaker Shape	T-CBN	HRF	HRM	
Cutting conditions	B016			

Reference pages: PSKNR/L: Inserts → **B077 -**, CBN → **B177**, PCD → **B195**

DSKNR/L

"One-Double" toolholder with 75° approach angle, for negative square inserts

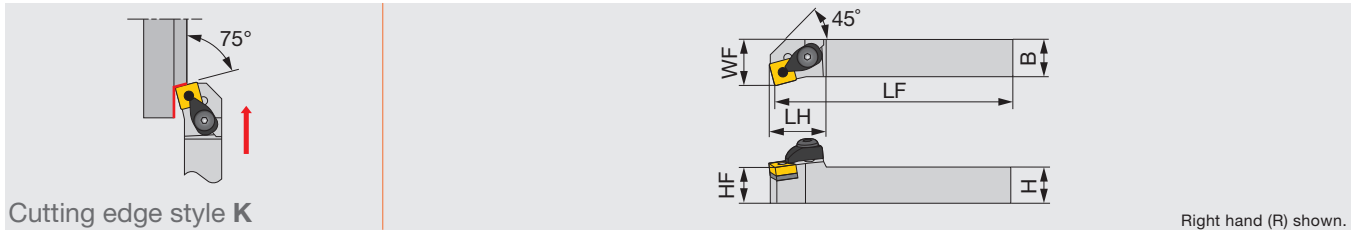

Cutting edge style K

Right hand (R) shown.

Metric	H	B	LF	LH	HF	WF	RE**	Insert
DSKNR/L2020K12	20	20	125	31	20	25	0.8	SN**1204...
DSKNR/L2525M12	25	25	150	31	25	32	0.8	SN**1204...

Except for 57-type chipbreaker inserts
**RE : Standard corner radius

SPARE PARTS									
Designation	Clamp	Lever	Piston	Clamp screw	Shim	Spring	Spring pin	Wrench 1	Wrench 2
DSKNR/L...	DCPM-43	DLCL43	DPIS43	DLCS43	LSS42	BP-10	LSP4	P-3	P-4

INSERT SELECTION

P	Application	Precision finishing	Finishing	Medium cutting	Medium to heavy cutting
	Grade	NS9530	GT9530	T9215	T9215
Chipbreaker Shape	TF	TSF	TM	TH	
Cutting conditions	B008				

M	Application	Finishing	Medium cutting	Medium to heavy cutting
	Grade	T6120	T6130	T6130
Chipbreaker Shape	SF	SM	SH	
Cutting conditions	B010			

K	Application	Finishing	Medium cutting	Medium to heavy cutting
	Grade	T515	T515	T515
Chipbreaker Shape	All-round	All-round	All-round	
Cutting conditions	B012			

N	Application	Finishing	Medium cutting
	Grade	DX140	TH10
Chipbreaker Shape	T-DIA	P	
Cutting conditions	B014		

S	Application	Precision finishing	Finishing	Medium cutting
	Grade	BX480	AH8005	AH8005
Chipbreaker Shape	T-CBN	HRF	HRM	
Cutting conditions	B016			

Reference pages: DSKNR/L: Inserts → B077 -, CBN → B177, PCD → B195

PCFNR/L

Lever-lock type toolholder for facing with 91° approach angle, for negative 80° rhombic inserts

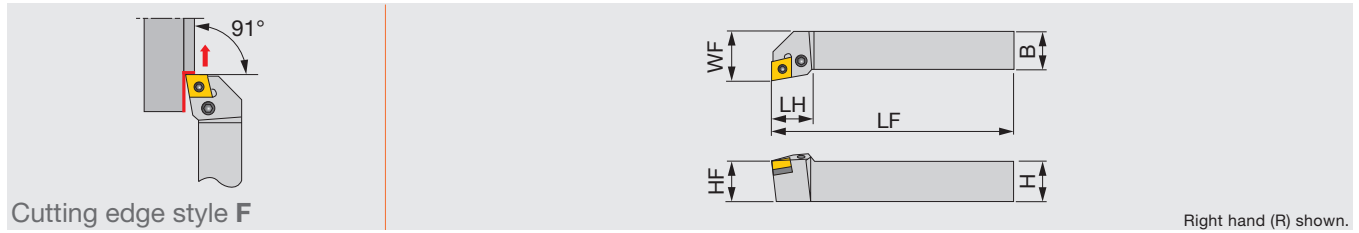

Metric	H	B	LF	LH	HF	WF	RE**	Insert
PCFNR/L2020	20	20	125	28	20	25	0.8	CN**1204...
PCFNR/L2525	25	25	150	28	25	32	0.8	CN**1204...

**RE : Standard corner radius

SPARE PARTS

Designation	Shim	Clamping screw	Wrench	Spring pin	Lever
PCFNR/L...	LSC42 D30	LCS4	P-3	LSP4	LCL4

INSERT SELECTION

Application	Precision finishing	Finishing	Medium cutting	Medium to heavy cutting
	Grade	NS9530	GT9530	T9215
Chipbreaker Shape	TF	TSF	TM	TH
Cutting conditions	B008			

Application	Finishing	Medium cutting	Medium to heavy cutting
	Grade	T6120	T6130
Chipbreaker Shape	SF	SM	SH
Cutting conditions	B010		

Application	Finishing	Medium cutting	Medium to heavy cutting
	Grade	T515	T515
Chipbreaker Shape	All-round	All-round	All-round
Cutting conditions	B012		

Application	Precision finishing	Finishing	Medium cutting
	Grade	DX120	DX140
Chipbreaker Shape	T-DIA	with rake T-DIA	P
Cutting conditions	B014		

Application	Precision finishing	Finishing	Medium cutting
	Grade	BX470	AH8005
Chipbreaker Shape	T-CBN	HRF	HRM
Cutting conditions	B016		

Application	Precision finishing	Finishing
	Grade	BXM10
Chipbreaker Shape	T-CBN	T-CBN
Cutting conditions	B018	

Reference pages: PCFNR/L: Inserts → B056 -, CBN → B172 -, PCD → B194 -

Screw-on toolholder for roughing with 93° approach angle, for negative tangential inserts

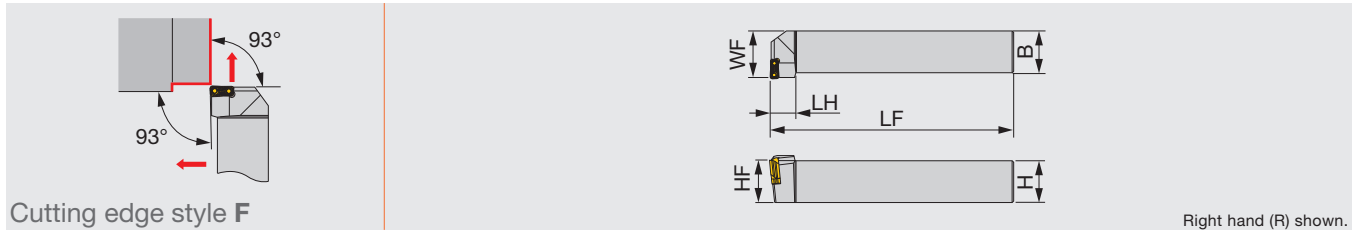

Inch	H	B	LF	LH	HF	WF	Insert
TLFNR/L16-16	1.000	1.000	6.000	0.780	1.000	1.000	LNMX1606**L/R...
TLFNR/L20-16	1.250	1.300	6.000	0.780	1.250	1.000	LNMX1606**L/R...

Use right-hand toolholders (R) with left-hand inserts (L); and left-hand toolholders (L) with right-hand inserts (R).

SPARE PARTS

Designation	Clamping screw	Shim	Spring pin	Wrench
TLFNR16-16	CSTB-4L115-S	TSL16L	PSP-16	KEYV-T15
TLFNL16-16	CSTB-4L115-S	TSL16R	PSP-16	KEYV-T15
TLFNR20-16	CSTB-4L115-S	TSL16L	PSP-16	KEYV-T15
TLFNL20-16	CSTB-4L115-S	TSL16R	PSP-16	KEYV-T15

INSERT

LNMX16

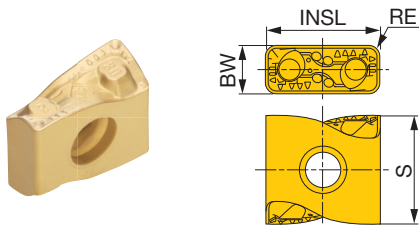

	P	M	K	N	S	H
Steel	★	★	★			
Stainless			☆			
Cast iron		☆	☆			
Non-ferrous						
Superalloys						
Hard materials						

★ : First choice
☆ : Second choice

Designation	HAND	RE (in)	Coated			BW (in)	INSL (in)	S (in)
			T9115	T9125	AH725			
LNMX160608R-TDR	R	0.031	●	●		0.252	0.638	0.532
LNMX160608L-TDR	L	0.031	●	●		0.252	0.638	0.532
LNMX160612R-TDR	R	0.047	●	●		0.252	0.638	0.532
LNMX160612L-TDR	L	0.047	●	●		0.252	0.638	0.532
LNMX160616R-TDR	R	0.063	●	●		0.252	0.638	0.532
LNMX160616L-TDR	L	0.063	●	●		0.252	0.638	0.532
LNMX160608R-MDR	R	0.031	●	●	●	0.252	0.638	0.532
LNMX160608L-MDR	L	0.031	●	●	●	0.252	0.638	0.532
LNMX160612R-MDR	R	0.047	●	●	●	0.252	0.638	0.532
LNMX160612L-MDR	L	0.047	●	●	●	0.252	0.638	0.532
LNMX160608R-TWR	R	0.031	●	●		0.252	0.638	0.532
LNMX160608L-TWR	L	0.031	●	●		0.252	0.638	0.532
LNMX160612R-TWR	R	0.047	●	●		0.252	0.638	0.532
LNMX160612L-TWR	L	0.047	●	●		0.252	0.638	0.532

● : Line up

Reference pages: TLFNR/L: Standard cutting conditions → C144

Lever-lock toolholder with 91° approach angle, for negative triangular inserts

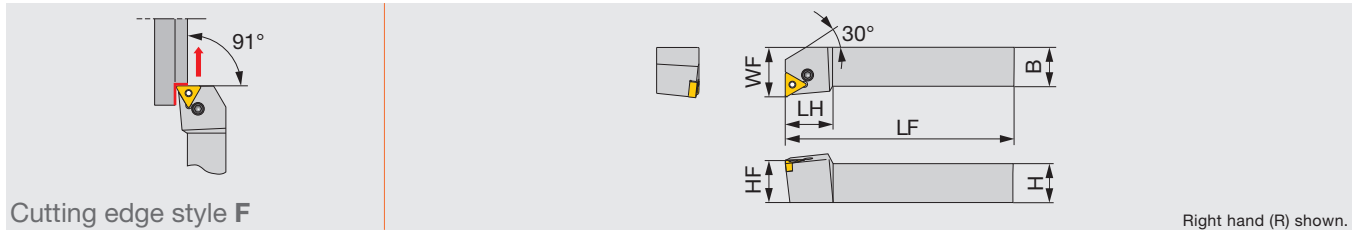

Cutting edge style F

Right hand (R) shown.

Metric	H	B	LF	LH	HF	WF	RE**	Insert	Torque
PTFNR/L2020K1104	20	20	125	16	20	25	0.8	TN**1104...	2
PTFNR/L2525M1104	25	25	150	22	25	32	0.8	TN**1104...	2

Torque: Recommended clamping torque: N·m

**RE : Standard corner radius

SPARE PARTS

Designation	Clamping screw	Wrench	Lever
PTFNR/L**1104	LCS23A	P-2.5	LCL23

Grade
Insert
Ext. Toolholder
Int. Toolholder
Threading
Grooving
Milling Cutter
Miniature Tool
Endmill
Drilling Tool
Tooling System
User's Guide
Index



INSERT SELECTION

Application	Finishing	Medium cutting
	Grade	T9215
Chipbreaker Shape	TSF	TM
Cutting conditions	B008	

Application	Finishing	Medium cutting
	Grade	T6120
Chipbreaker Shape	SS	SM
Cutting conditions	B010	

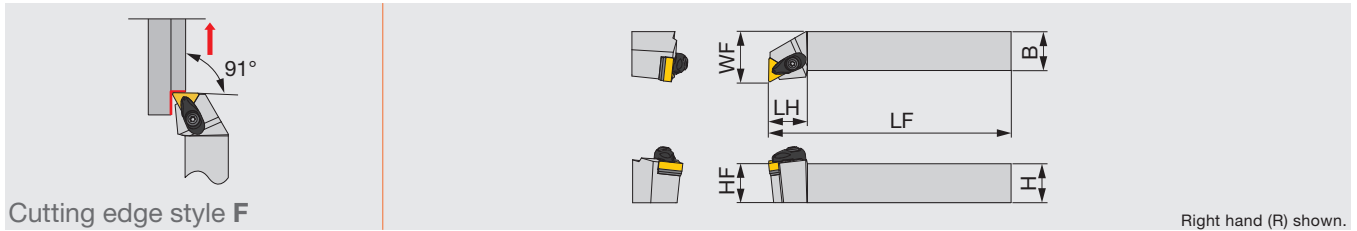

Right hand (R) shown.

Inch	H	B	LF	LH	HF	WF	RE**	Insert	Torque
ATFNR/L123-A	0.750	0.750	4.500	1.000	0.750	1.000	0.032	TN**33...	2.2
ATFNR/L163-A	1.000	1.000	6.000	1.000	1.000	1.250	0.032	TN**33...	2.2

Metric	H	B	LF	LH	HF	WF	RE**	Insert	Torque*
ATFNR/L2020K16-A	20	20	125	25	20	25	0.8	TN**1604...	3
ATFNR/L2525M16-A	25	25	150	25	25	32	0.8	TN**1604...	3
ATFNR/L2525M22-A	25	25	150	29	25	32	0.8	TN**2204...	3

Torque: Recommended clamping torque: lbs-ft (**N·m)

**RE : Standard corner radius

SPARE PARTS

Designation	Clamp	Clamp screw	Spring	Spring pin	Shim	Shim screw	Wrench
ATFNR/L**3-A, 16-A	ACP3S	ACS-5W	BP-7	SP-2.5	AST322	CSTB-3.5	T-15F
ATFNR/L**22-A	ACP4S	ACS-5W	BP-7	SP-2.5	AST422	CSTB-3.5	T-15F

INSERT SELECTION

Application	Precision finishing	Finishing	Medium cutting	Medium to heavy cutting
	Grade	NS9530	GT9530	T9215
Chipbreaker Shape	TF	TSF	TM	TH
Cutting conditions	B008			

Application	Finishing	Medium cutting
	Grade	T6120
Chipbreaker Shape	SF	SM
Cutting conditions	B010	

Application	Finishing	Medium cutting	Medium to heavy cutting
	Grade	T515	T515
Chipbreaker Shape	All-round	All-round	All-round
Cutting conditions	B012		

Application	Precision finishing	Finishing	Medium cutting
	Grade	DX120	DX140
Chipbreaker Shape	T-DIA	with rake T-DIA	P
Cutting conditions	B014		

Application	Precision finishing	Finishing	Medium cutting
	Grade	BX470	AH8005
Chipbreaker Shape	T-CBN	HRF	HRM
Cutting conditions	B016		

Application	Precision finishing	Finishing
	Grade	BXM10
Chipbreaker Shape	T-CBN	T-CBN
Cutting conditions	B018	

Reference pages: ATFNR/L: Inserts → B086 -, CBN → B178 -, PCD → B194 -

PTFNR/L

Lever-lock toolholder with 91° approach angle, for negative 60° triangular inserts

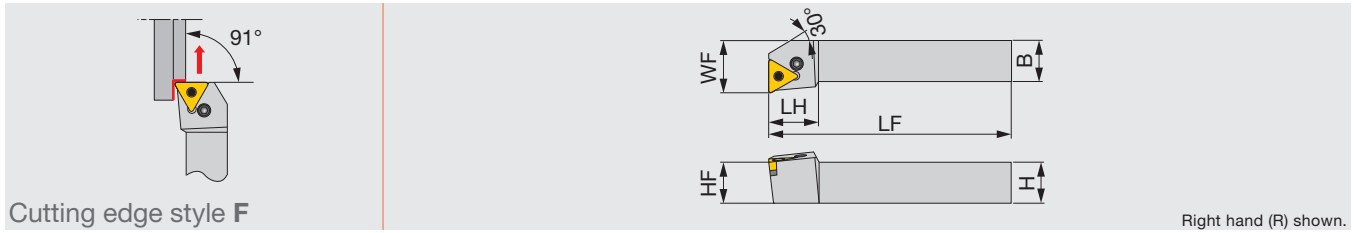

Metric	H	B	LF	LH	HF	WF	RE**	Insert
PTFNR/L1616	16	16	100	22	16	20	0.8	TN**1604...
PTFNR/L2020	20	20	125	22	20	25	0.8	TN**1604...
PTFNR/L2525M3	25	25	150	22	25	32	0.8	TN**1604...
PTFNR/L2525M4	25	25	150	28	25	32	0.8	TN**2204...
PTFNR/L3225P4	32	25	170	28	32	32	0.8	TN**2204...

**RE : Standard corner radius

SPARE PARTS					
Designation	Shim	Clamping screw	Wrench	Spring pin	Lever
PTFNR/L1616, 2020	LST317	LCS3	P-2.5	LSP3	LCL3
PTFNR/L2525M3	LST317	LCS3	P-2.5	LSP3	LCL3
PTFNR/L**25*4	LST42	LCS4	P-3	LSP4	LCL4

INSERT SELECTION

Application	Precision finishing	Finishing	Medium cutting	Medium to heavy cutting
	Grade	NS9530	GT9530	T9215
Chipbreaker Shape	TF	TSF	TM	TH
Cutting conditions	B008			

Application	Finishing	Medium cutting
	Grade	T6120
Chipbreaker Shape	SF	SM
Cutting conditions	B010	

Application	Finishing	Medium cutting	Medium to heavy cutting
	Grade	T515	T515
Chipbreaker Shape	All-round	All-round	All-round
Cutting conditions	B012		

Application	Precision finishing	Finishing	Medium cutting
	Grade	DX120	DX140
Chipbreaker Shape	T-DIA	with rake T-DIA	P
Cutting conditions	B014		

Application	Precision finishing	Finishing	Medium cutting
	Grade	BX470	AH8005
Chipbreaker Shape	T-CBN	HRF	HRM
Cutting conditions	B016		

Application	Precision finishing	Finishing
	Grade	BXM10
Chipbreaker Shape	T-CBN	T-CBN
Cutting conditions	B018	

Reference pages: PTFNR/L: Inserts → B086 -, CBN → B178 -, PCD → B194 -

DTFNR/L

"One-Double" toolholder with 91° approach angle, for negative 60° triangular inserts

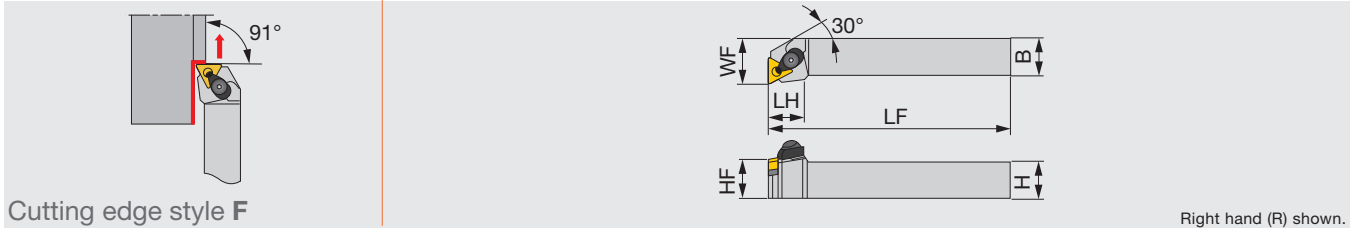

Cutting edge style F

Right hand (R) shown.

Metric	H	B	LF	LH	HF	WF	RE**	Insert
DTFNR/L2020K16	20	20	125	23	20	25	0.8	TN**1604...
DTFNR/L2525M16	25	25	150	23	25	32	0.8	TN**1604...
DTFNR/L2525M22	25	25	150	31	25	32	0.8	TN**2204...

Except for 57-type chipbreaker inserts
 **RE : Standard corner radius

SPARE PARTS									
Designation	Clamp	Lever	Piston	Clamp screw	Shim	Spring	Spring pin	Wrench 1	Wrench 2
DTFNR/L**16	DCPM-33	LCL33	DPIS33	DLCS33	LST317	BP-9	LSP3	P-2.5	P-3
DTFNR/L**22	DCPM-43	DLCL43	DPIS43	DLCS43	LST42	BP-10	LSP4	P-3	P-4

INSERT SELECTION

P	Application	Precision finishing	Finishing	Medium cutting	Medium to heavy cutting
	Grade	NS9530	GT9530	T9215	T9215
	Chipbreaker Shape				
	Cutting conditions	B008			

M	Application	Finishing	Medium cutting
	Grade	T6120	T6130
	Chipbreaker Shape		
	Cutting conditions	B010	

K	Application	Finishing	Medium cutting	Medium to heavy cutting
	Grade	T515	T515	T515
	Chipbreaker Shape	All-round	All-round	All-round
	Cutting conditions	B012		

N	Application	Precision finishing	Finishing	Medium cutting
	Grade	DX120	DX140	TH10
	Chipbreaker Shape	T-DIA	with rake T-DIA	P
	Cutting conditions	B014		

S	Application	Precision finishing	Finishing	Medium cutting
	Grade	BX470	AH8005	AH8005
	Chipbreaker Shape	T-CBN	HRF	HRM
	Cutting conditions	B016		

H	Application	Precision finishing	Finishing
	Grade	BXM10	BXM20
	Chipbreaker Shape	T-CBN	T-CBN
	Cutting conditions	B018	

Reference pages: DTFNR/L: Inserts → B086 -, CBN → B178 -, PCD → B194 -

Double-clamp toolholder with 107.5° approach angle, for negative 55° rhombic inserts

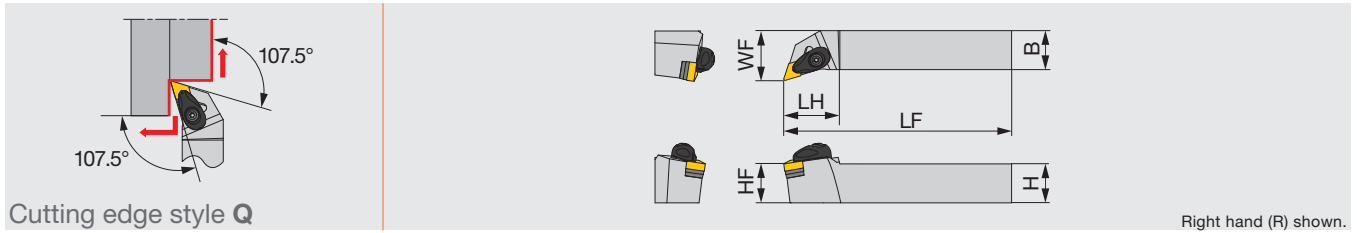

Inch	H	B	LF	LH	HF	WF	RE**	Insert	Torque
ADQNR/L1233-A	0.750	0.750	4.500	1.150	0.750	1.000	0.031	DN**33...	2.2
ADQNR/L1633-A	1.000	1.000	6.000	1.150	1.000	1.250	0.031	DN**33...	2.2
Metric	H	B	LF	LH	HF	WF	RE**	Insert	Torque*
ADQNR/L2020K1104-A	20	20	125	30	20	25	0.8	DN**1104...	3
ADQNR/L2525M1104-A	25	25	150	30	25	32	0.8	DN**1104...	3

Torque: Recommended clamping torque: lbs-ft (*N-m)
 **RE : Standard corner radius

SPARE PARTS							
Designation	Clamp	Clamp screw	Spring	Spring pin	Shim	Shim screw	Wrench
ADQNR/L**-A	ACP3S-E	ACS-5W	BP-7	SP-2.5	ASD322	CSTB-3.5	T-15F

INSERT SELECTION

P	Application	Finishing	Medium cutting
	Grade	T9215	T9215
Chipbreaker Shape	TSF	TM	TM
Cutting conditions	B008		

M	Application	Finishing	Medium cutting
	Grade	T6120	T6130
Chipbreaker Shape	SS	SM	SM
Cutting conditions	B010		

K	Application	Medium cutting
	Grade	T515
Chipbreaker Shape	TM	
Cutting conditions	B012	

Reference pages: ADQNR/L-Eco: Inserts → **B067** -

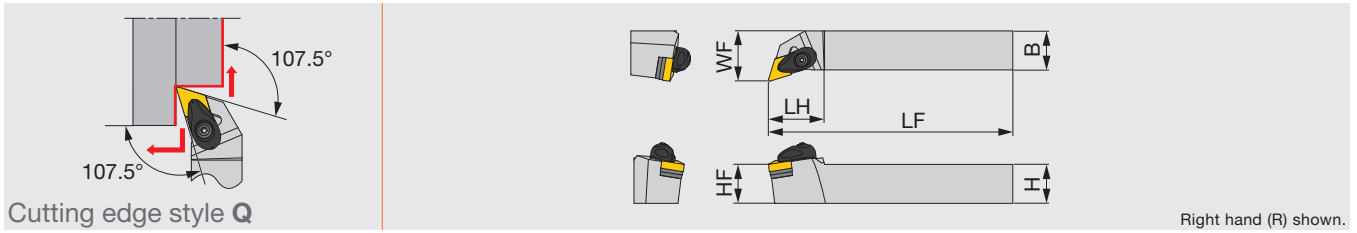

Cutting edge style Q

Right hand (R) shown.

Inch	H	B	LF	LH	HF	WF	RE**	Insert	Torque
ADQNR/L124-A	0.750	0.750	4.500	1.250	0.750	1.000	0.031	DN**43...	2.2
ADQNR/L164-A	1.000	1.000	6.000	1.500	1.000	1.250	0.031	DN**43...	2.2

Metric	H	B	LF	LH	HF	WF	RE**	Insert	Torque*
ADQNR/L2020K15-A	20	20	125	32	20	25	0.8	DN**1504...	3
ADQNR/L2020K1506-A	20	20	125	32	20	25	0.8	DN**1506...	3
ADQNR/L2525M15-A	25	25	150	36	25	32	0.8	DN**1504...	3
ADQNR/L2525M1506-A	25	25	150	36	25	32	0.8	DN**1506...	3

Torque: Recommended clamping torque: lbs-ft (**N·m)

**RE : Standard corner radius

SPARE PARTS

Designation	Clamp	Clamp screw	Spring	Spring pin	Shim	Shim screw	Wrench
ADQNR/L**4-A, 15-A	ACP4S	ACS-5W	BP-7	SP-2.5	ASD432	CSTB-3.5	T-15F
ADQNR/L**1506-A	ACP4S	ACS-5W	BP-7	SP-2.5	ASD423	CSTB-3.5	T-15F

INSERT SELECTION

Application	Precision finishing	Finishing	Medium cutting	Medium to heavy cutting
	Grade	Grade	Grade	Grade
	NS9530	GT9530	T9215	T9215
Chipbreaker Shape	TF	TSF	TM	TH
Cutting conditions	B008			

Application	Finishing	Medium cutting	Medium to heavy cutting
	Grade	Grade	Grade
	T6120	T6130	T6130
Chipbreaker Shape	SF	SM	SH
Cutting conditions	B010		

Application	Finishing	Medium cutting	Medium to heavy cutting
	Grade	Grade	Grade
	T515	T515	T515
Chipbreaker Shape	All-round	All-round	All-round
Cutting conditions	B012		

Application	Precision finishing	Finishing	Medium cutting
	Grade	Grade	Grade
	DX120	DX140	TH10
Chipbreaker Shape	T-DIA	with rake T-DIA	P
Cutting conditions	B014		

Application	Precision finishing	Finishing	Medium cutting
	Grade	Grade	Grade
	BX470	AH8005	AH8005
Chipbreaker Shape	T-CBN	HRF	HRM
Cutting conditions	B016		

Application	Precision finishing	Finishing
	Grade	Grade
	BXM10	BXM20
Chipbreaker Shape	T-CBN	T-CBN
Cutting conditions	B018	

Reference pages: ADQNR/L: Inserts → B067 -, CBN → B174 -, PCD → B194 -

PDQNR/L

Lever-lock toolholder with 107.5° approach angle, for negative 55° rhombic inserts

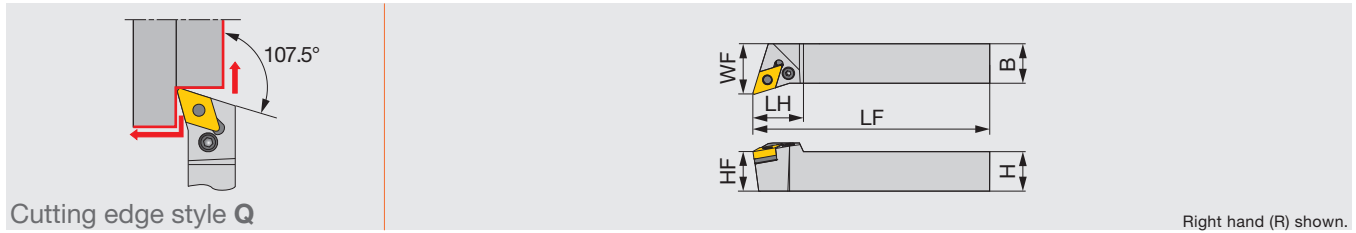

Cutting edge style Q

Right hand (R) shown.

Metric	H	B	LF	LH	HF	WF	RE**	Insert
PDQNR/L2525	25	25	150	32	25	32	0.8	DN**1504...

**RE : Standard corner radius

SPARE PARTS

Designation	Shim	Clamping screw	Wrench	Spring pin	Lever
PDQNR/L...	LSD42 D30	LCS4	P-3	LSP4	LCL4

INSERT SELECTION

Application	Precision finishing	Finishing	Medium cutting	Medium to heavy cutting
	Grade	NS9530	GT9530	T9215
Chipbreaker Shape	TF	TSF	TM	TH
Cutting conditions	B008			

Application	Finishing	Medium cutting	Medium to heavy cutting
	Grade	T6120	T6130
Chipbreaker Shape	SF	SM	SH
Cutting conditions	B010		

Application	Finishing	Medium cutting	Medium to heavy cutting
	Grade	T515	T515
Chipbreaker Shape	All-round	All-round	All-round
Cutting conditions	B012		

Application	Precision finishing	Finishing	Medium cutting
	Grade	DX120	DX140
Chipbreaker Shape	T-DIA	with rake T-DIA	P
Cutting conditions	B014		

Application	Precision finishing	Finishing	Medium cutting
	Grade	BX470	AH8005
Chipbreaker Shape	T-CBN	HRF	HRM
Cutting conditions	B016		

Application	Precision finishing	Finishing
	Grade	BXM10
Chipbreaker Shape	T-CBN	T-CBN
Cutting conditions	B018	

Reference pages: PDQNR/L: Inserts → B067 -, CBN → B174 -, PCD → B194 -

DDQNR/L

"One-Double" toolholder with 107.5° approach angle, for negative 55° rhombic inserts

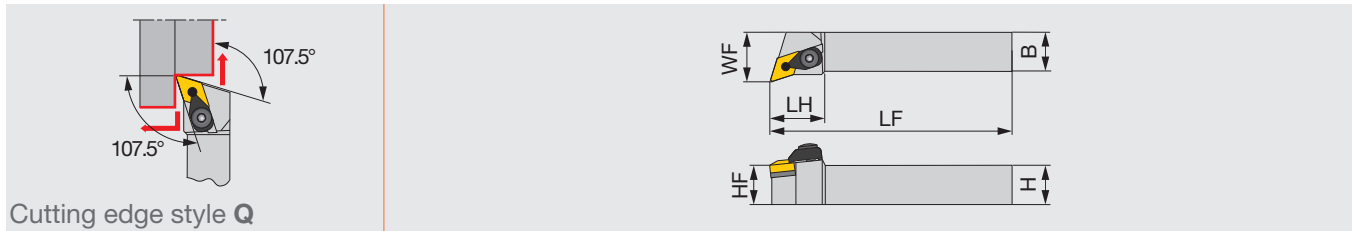

Cutting edge style Q

Metric	H	B	LF	LH	HF	WF	RE**	Insert
DDQNR/L2020K15	20	20	125	35	20	25	0.8	DN**1504...
DDQNR/L2020K1506	20	20	125	35	20	25	0.8	DN**1506...
DDQNR/L2525M15	25	25	150	35	25	32	0.8	DN**1504...
DDQNR/L2525M1506	25	25	150	35	25	32	0.8	DN**1506...
DDQNR/L3225P15	32	25	170	35	32	32	0.8	DN**1504...
DDQNR/L3225P1506	32	25	170	35	32	32	0.8	DN**1506...

Except for 57-type chipbreaker inserts
 **RE : Standard corner radius

SPARE PARTS									
Designation	Clamp	Lever	Piston	Clamp screw	Shim	Spring	Spring pin	Wrench 1	Wrench 2
DDQNR/L**15	DCPM-43	DLCL43	DPIS43	DLCS43	LSD42	BP-10	LSP4	P-3	P-4
DDQNR/L**1506	DCPM-43	DLCL43	DPIS44	DLCS43	LSD42	BP-10	LSP4	P-3	P-4

INSERT SELECTION

P	Application	Precision finishing	Finishing	Medium cutting	Medium to heavy cutting
	Grade	NS9530	GT9530	T9215	T9215
Chipbreaker Shape	TF	TSF	TM	TH	
Cutting conditions	B008				

M	Application	Finishing	Medium cutting	Medium to heavy cutting
	Grade	T6120	T6130	T6130
Chipbreaker Shape	SF	SM	SH	
Cutting conditions	B010			

K	Application	Finishing	Medium cutting	Medium to heavy cutting
	Grade	T515	T515	T515
Chipbreaker Shape	All-round	All-round	All-round	
Cutting conditions	B012			

N	Application	Precision finishing	Finishing	Medium cutting
	Grade	DX120	DX140	TH10
Chipbreaker Shape	T-DIA	with rake T-DIA	P	
Cutting conditions	B014			

S	Application	Precision finishing	Finishing	Medium cutting
	Grade	BX470	AH8005	AH8005
Chipbreaker Shape	T-CBN	HRF	HRM	
Cutting conditions	B016			

H	Application	Precision finishing	Finishing
	Grade	BXM10	BXM20
Chipbreaker Shape	T-CBN	T-CBN	
Cutting conditions	B018		

Reference pages: DDQNR/L: Inserts → B067 -, CBN → B174 -, PCD → B194 -

SDQCR/L

Screw-on toolholder with 107.5° approach angle, for positive 55° rhombic inserts

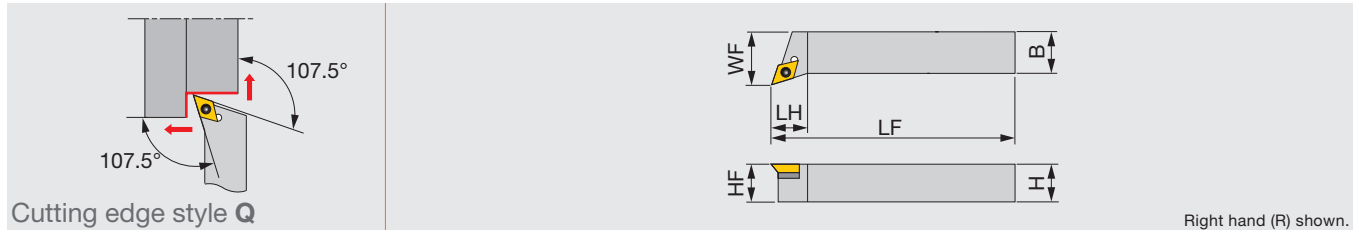

Metric	H	B	LF	LH	HF	WF	RE**	Insert
SDQCR/L2020K11	20	20	125	20.5	20	25	0.8	DC**11T3...
SDQCR2525M11	25	25	150	21.5	25	32	0.8	DC**11T3...

**RE : Standard corner radius

SPARE PARTS

Designation	Clamping screw	Shim screw	Shim	Wrench 1	Wrench 2
SDQCR/L...	CSTB-3.5L	DTS5-3.5	SSD32	P-3.5	T-15F

INSERT SELECTION

P	Application	Finishing	Finishing to medium cutting	Medium cutting	
	Grade	NS9530	T9215	T9215	
	Chipbreaker Shape	PSS	PS	PM	
	Cutting conditions	B020			
M	Application	Precision finishing	Finishing	Finishing to medium cutting	Medium cutting
	Grade	GH330	AH725	AH630	T6130
	Chipbreaker Shape	W**	PSF	PSS	PM
	Cutting conditions	B022			
K	Application	Finishing to medium cutting			
	Grade	T515			
	Chipbreaker Shape	CM			
	Cutting conditions	B024			
N	Application	Precision finishing	Finishing	Medium cutting	
	Grade	DX120	DX140	KS05F	
	Chipbreaker Shape	T-DIA	with rake T-DIA	AL	
	Cutting conditions	B026			
S	Application	Finishing	Finishing to medium cutting		
	Grade	AH8015	AH8015		
	Chipbreaker Shape	PSS	PS		
	Cutting conditions	B028			
H	Application	Precision finishing	Finishing		
	Grade	BXM10	BXM20		
	Chipbreaker Shape	T-CBN	T-CBN		
	Cutting conditions	B030			

Reference pages: SDQCR/L: Inserts → B121 -, CBN → B184 -, PCD → B196 -

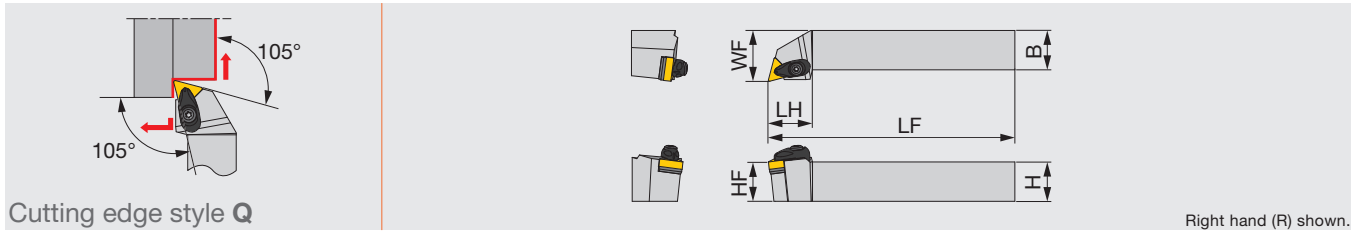

Cutting edge style Q

Right hand (R) shown.

Inch	H	B	LF	LH	HF	WF	RE**	Insert	Torque
ATQNR/L123-A	0.750	0.750	4.500	1.125	0.750	1.000	0.031	TN**33...	2.2
ATQNR/L163-A	1.000	1.000	6.000	1.125	1.000	1.250	0.031	TN**33...	2.2

Metric	H	B	LF	LH	HF	WF	RE**	Insert	Torque*
ATQNR/L2020K16-A	20	20	125	28	20	25	0.8	TN**1604...	3
ATQNR/L2525M16-A	25	25	150	28	25	32	0.8	TN**1604...	3

Torque: Recommended clamping torque: lbs-ft (*N-m)

**RE : Standard corner radius

SPARE PARTS

Designation	Clamp	Clamp screw	Spring	Spring pin	Shim	Shim screw	Wrench
ATQNR/L**3-A, 16-A	ACP3S	ACS-5W	BP-7	SP-2.5	AST322	CSTB-3.5	T-15F

INSERT SELECTION

Application	Precision finishing	Finishing	Medium cutting	Medium to heavy cutting
	Grade	NS9530	GT9530	T9215
Chipbreaker Shape	TF	TSF	TM	TH
Cutting conditions	B008			

Application	Finishing	Medium cutting
	Grade	T6120
Chipbreaker Shape	SF	SM
Cutting conditions	B010	

Grade Application	Finishing	Medium cutting	Medium to heavy cutting
	Chipbreaker Shape	T515 All-round	T515 All-round
Cutting conditions	B012		

Application	Precision finishing	Finishing	Medium cutting
	Grade	DX120	DX140
Chipbreaker Shape	T-DIA	with rake T-DIA	P
Cutting conditions	B014		

Application	Precision finishing	Finishing	Medium cutting
	Grade	BX470	AH8005
Chipbreaker Shape	T-CBN	HRF	HRM
Cutting conditions	B016		

Application	Precision finishing	Finishing
	Grade	BXM10
Chipbreaker Shape	T-CBN	T-CBN
Cutting conditions	B018	

Reference pages: ATQNR/L: Inserts → B086 -, CBN → B178 -, PCD → B194 -

Double-clamp toolholder with 117.5° approach angle, for negative 35° rhombic inserts

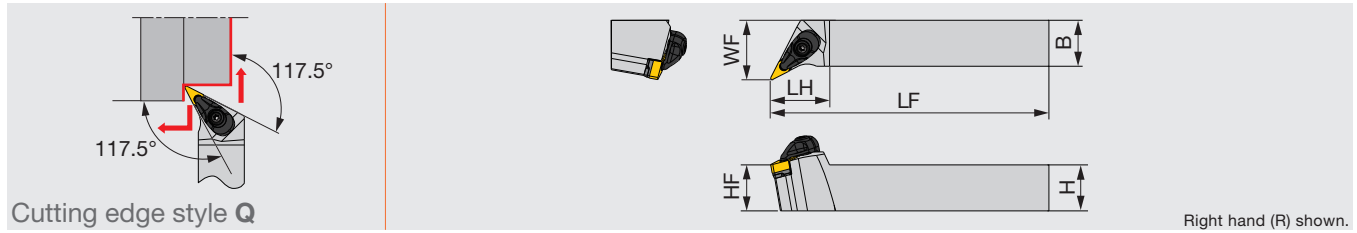

Inch	H	B	LF	LH	HF	WF	RE**	Insert	Torque
AVQNR/L122.33-A	0.750	0.750	4.500	1.250	0.750	1.000	0.031	VN**2.33...	2.21
AVQNR/L162.33-A	1.000	1.000	6.000	1.250	1.000	1.250	0.031	VN**2.33...	2.21

Metric	H	B	LF	LH	HF	WF	RE**	Insert	Torque*
AVQNR/L2020K1204-A	20	20	125	32	20	25	0.8	VN**1204...	3
AVQNR/L2525M1204-A	25	25	150	32	25	32	0.8	VN**1204...	3

Torque: Recommended clamping torque: lbs-ft (*N-m) **RE: Standard corner radius

SPARE PARTS							
Designation	Clamp	Clamp screw	Spring	Spring pin	Shim	Shim screw	Wrench
AVQNR/L**A	ACP3L-E	ACS-5W	BP-7	SP-2.5	ASV222	CSTB-3.0	T-15F

Lever-lock toolholder with 117.5° approach angle, for negative 35° rhombic inserts

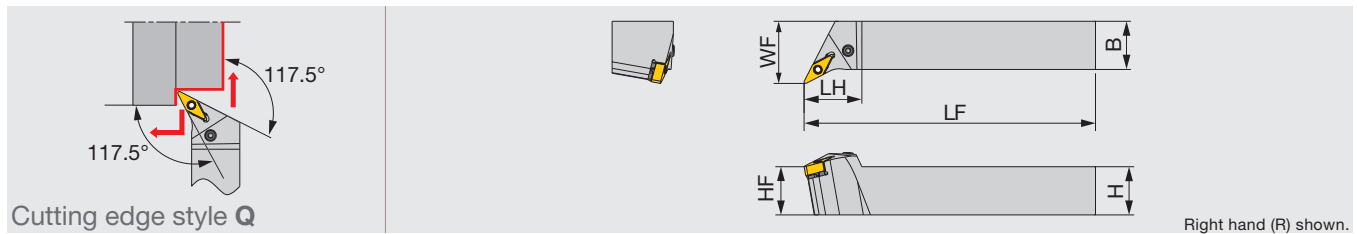

Metric	H	B	LF	LH	HF	WF	RE**	Insert	Torque
PVQNR/L2020K1204	20	20	125	30	20	25	0.8	VN**1204...	2
PVQNR/L2525M1204	25	25	150	30	25	32	0.8	VN**1204...	2

Torque: Recommended clamping torque: N-m **RE: Standard corner radius

SPARE PARTS					
Designation	Shim	Clamping screw	Wrench	Spring pin	Lever
PVQNR/L**1204	LSV212	LCS3V	P-2.5	LSP3	LCL3V

INSERT SELECTION

P	Application	Finishing	Medium cutting
	Grade	T9215	T9215
Chipbreaker Shape	TSF	TM	
Cutting conditions	B008		

M	Application	Finishing	Medium cutting
	Grade	T6120	T6130
Chipbreaker Shape	SS	SM	
Cutting conditions	B010		

Grade
Insert
Toolholder
Ext. Toolholder
Int. Toolholder
Threading
Grooving
Miniature Tool
Milling Cutter
Endmill
Drilling Tool
Tooling System
User's Guide
Index



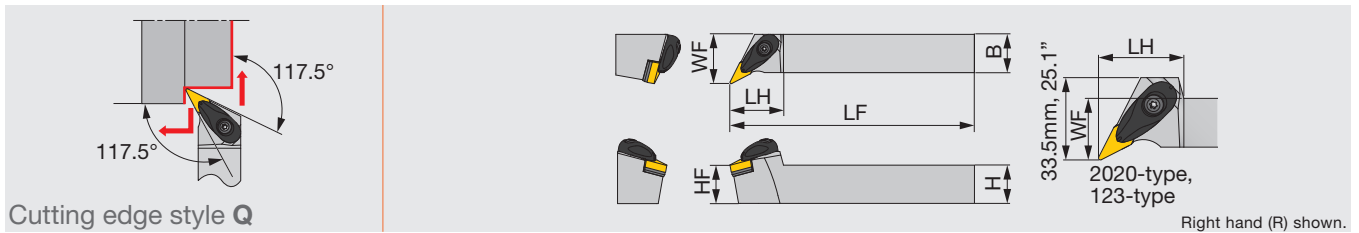

Cutting edge style Q

Right hand (R) shown.

Inch	H	B	LF	LH	HF	WF	RE**	Insert	Torque
AVQNR/L123-A	0.750	0.750	4.500	1.380	0.750	1.000	0.031	V/YN**33...	2.2
AVQNR/L163-A	1.000	1.000	6.000	1.380	1.000	1.250	0.031	V/YN**33...	2.2

Metric	H	B	LF	LH	HF	WF	RE**	Insert	Torque*
AVQNR/L2020K16-A	20	20	125	35	20	25	0.8	V/YN**1604...	3
AVQNR/L2525M16-A	25	25	150	35	25	32	0.8	V/YN**1604...	3

Torque: Recommended clamping torque: lbs-ft (*N-m)

**RE : Standard corner radius

SPARE PARTS

Designation	Clamp	Clamp screw	Spring	Spring pin	Shim	Shim screw	Wrench
AVQNR/L...	ACP3L	ACS-5W	BP-7	SP-2.5	ASV322	CSTB-3.5	T-15F

INSERT SELECTION

Application	Precision finishing	Finishing	Medium cutting
	Grade	NS9530	GT9530
Chipbreaker Shape	TF	TSF	TM
Cutting conditions	B008		

Application	Finishing	Medium cutting
	Grade	T6120
Chipbreaker Shape	SF	SM
Cutting conditions	B010	

Application	Finishing	Medium cutting	Medium to heavy cutting
	Grade	T515	T515
Chipbreaker Shape	All-round	All-round	All-round
Cutting conditions	B012		

Application	Precision finishing
Grade	DX120
Chipbreaker Shape	T-DIA with rake
Cutting conditions	B014

Application	Precision finishing	Finishing	Medium cutting
	Grade	BX480	AH8005
Chipbreaker Shape	T-CBN	HRF	HRM
Cutting conditions	B016		

Application	Precision finishing	Finishing
	Grade	BXM10
Chipbreaker Shape	T-CBN	T-CBN
Cutting conditions	B018	

Reference pages: AVQNR/L: Inserts → B096 -, B109, CBN → B180, PCD → B194

Lever-lock toolholders with 117.5° approach angle, for negative 35° and 25° rhombic inserts, with high pressure coolant capability

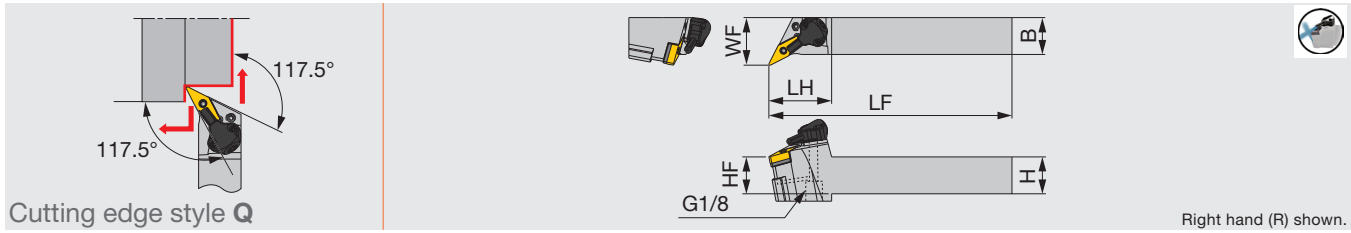

Inch	H	B	LF	LH	HF	WF	RE**	Insert	Torque
PVQNR/L123-CHP	0.750	0.750	4.500	1.688	0.750	1.250	0.031	V/YN**33...	1.48
PVQNR/L163-CHP	1.000	1.000	6.000	1.688	1.000	1.250	0.031	V/YN**33...	1.48

Metric	H	B	LF	LH	HF	WF	RE**	Insert	Torque*
PVQNR/L2020K16-CHP	20	20	125	42.5	20	32	0.8	V/YN**1604...	2
PVQNR/L2525M16-CHP	25	25	150	42.5	25	32	0.8	V/YN**1604...	2

Torque: Recommended clamping torque: lbs-ft (*N-m)
 **RE : Standard corner radius

SPARE PARTS

Designation	Shim	Clamping screw	Wrench 1	Spring pin	Lever
PVQNR/L**-CHP	LSV317	LCS3V	P-2.5	LSP3	LCL3V

SPARE PARTS

Designation	Coolant unit	Mounting screw	Wrench 2	O-ring	Coolant screw	Wrench 3
PVQNR/L**-CHP	CU-V-CHP	SRM3	T-8F	OR6.4X0.9N	SRM4X4TL360	P-2

INSERT SELECTION

Application	Precision finishing	Finishing	Medium cutting
	Grade	NS9530	GT9530
Chipbreaker Shape	TF	TSF	TM
Cutting conditions	B008		

Application	Finishing	Medium cutting
	Grade	T6120
Chipbreaker Shape	SF	SM
Cutting conditions	B010	

Application	Finishing	Medium cutting	Medium to heavy cutting
	Grade	T515	T515
Chipbreaker Shape	All-round	All-round	All-round
Cutting conditions	B012		

Application	Precision finishing
	Grade
Chipbreaker Shape	T-DIA with rake
Cutting conditions	B014

Application	Precision finishing	Finishing	Medium cutting
	Grade	BX480	AH8005
Chipbreaker Shape	T-CBN	HRF	HRM
Cutting conditions	B016		

Application	Precision finishing	Finishing
	Grade	BXM10
Chipbreaker Shape	T-CBN	T-CBN
Cutting conditions	B018	

Reference pages: PVQNR/L-CHP: Inserts → **B096 - , B109**, CBN → **B180**, PCD → **B194**
 Parts for coolant hose → **C142**



SVQCR/L

Screw-on toolholder with 117.5° approach angle, for positive 35° rhombic inserts

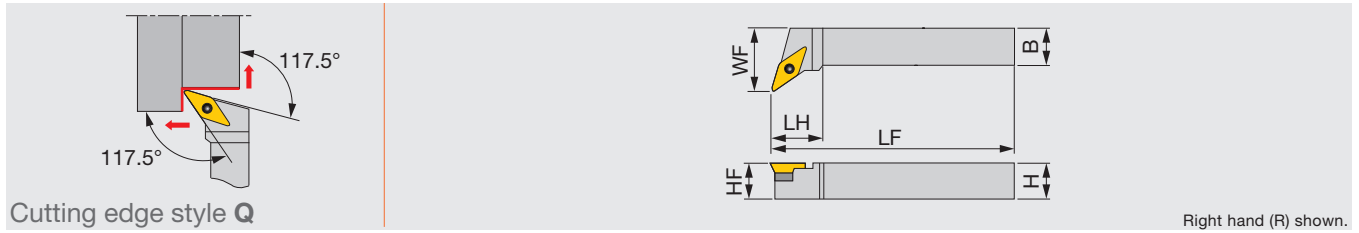

Right hand (R) shown.

Inch	H	B	LF	LH	HF	WF	RE**	Insert
SVQCR/L163	1.00	1.00	6.00	1.50	1.00	1.25	0.031	VC**33...
Metric	H	B	LF	LH	HF	WF	RE**	Insert
SVQCR/L2020K16	20	20	125	35	20	27	0.8	VC**1604...
SVQCR/L2525M16	25	25	150	35	25	32	0.8	VC**1604...

**RE : Standard corner radius

SPARE PARTS

Designation	Clamping screw	Shim screw	Shim	Wrench 1	Wrench 2
SVQCR/L...	CSTB-3.5L	DTS5-3.5	SSV32	P-3.5	T-15F

INSERT SELECTION

P	Application	Finishing	Finishing to medium cutting	M	Application	Finishing	Finishing to medium cutting	Medium cutting							
	Grade	NS9530	T9215		Grade	AH725	AH630	T6130							
	Chipbreaker Shape	PSS	PS		Chipbreaker Shape	PSF	PSS	PM							
Cutting conditions				B020				Cutting conditions				B022			
K	Application	Finishing to medium cutting	N	Application	Precision finishing	Finishing	Medium cutting								
	Grade	T515		Grade	DX120	DX140	KS05F								
	Chipbreaker Shape	CM		Chipbreaker Shape	T-DIA	with rake T-DIA	AL								
Cutting conditions				B024				Cutting conditions				B026			
S	Application	Finishing	Finishing to medium cutting	H	Application	Precision finishing	Finishing								
	Grade	AH8015	AH8015		Grade	BXM10	BXM20								
	Chipbreaker Shape	PSS	PS		Chipbreaker Shape	T-CBN	T-CBN								
Cutting conditions				B028				Cutting conditions				B030			

Reference pages: SVQCR/L: Inserts → B155 -, CBN → B192, PCD → B196

SVHCR/L

Screw-on toolholder with 107.5° approach angle, for positive 35° rhombic inserts

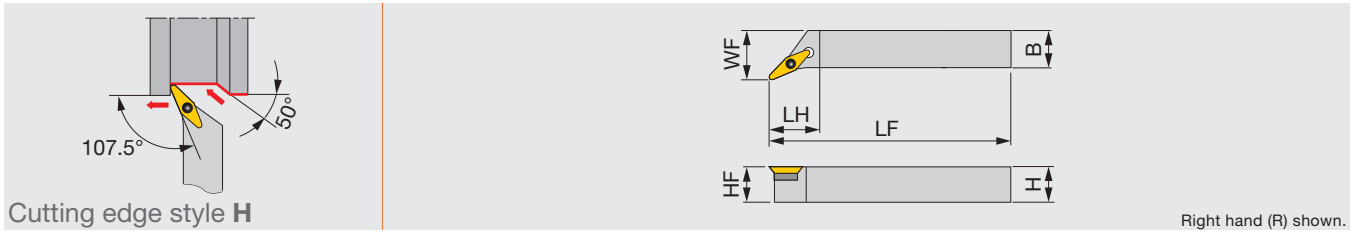

Metric	H	B	LF	LH	HF	WF	RE**	Insert
SVHCR/L2525M22	25	25	150	33.8	25	32	0.8	VCG*2205...

**RE : Standard corner radius

SPARE PARTS

Designation	Clamping screw	Shim screw	Shim	Wrench 1	Wrench 2
SVHCR/L2525M22	CSTB-4.5L110P	DTS6-4.5	SSV42	P-4.5	T-15F

INSERT SELECTION

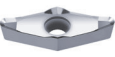
K	Application	Finishing to medium cutting
	Grade	KS05F
	Chipbreaker Shape	AL 
	Cutting conditions	B024

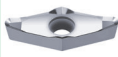
N	Application	Finishing to medium cutting
	Grade	KS05F
	Chipbreaker Shape	AL 
	Cutting conditions	B026

S	Application	Finishing to medium cutting
	Grade	KS05F
	Chipbreaker Shape	AL 
	Cutting conditions	B028

Reference pages: SVHCR/L: Inserts → **B156**

Grade
Insert
Ext. Toolholder
Int. Toolholder
Threading
Grooving
Milling Cutter
Miniature Tool
Endmill
Drilling Tool
Tooling System
User's Guide
Index



Y-PRO SERIES

SYQBR/L

Screw-on toolholder with 122.5° approach angle, for positive 25° rhombic inserts

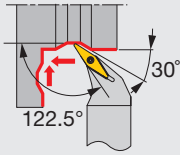

Cutting edge style Q

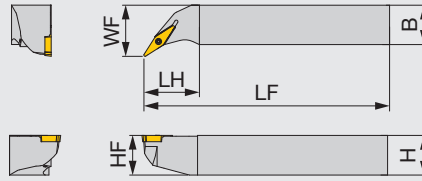

Right hand (R) shown.

Inch	H	B	LF	LH	HF	WF	RE**	Insert
SYQBR/L123	0.750	0.750	4.500	1.350	0.750	1.000	0.031	YWMT16T3...
SYQBR/L163	1.000	1.000	6.000	1.500	1.000	1.250	0.031	YWMT16T3...
Metric	H	B	LF	LH	HF	WF	RE**	Insert
SYQBR/L2020K16	20	20	125	35	20	27	0.8	YWMT16T3...
SYQBR/L2525M16	25	25	150	35	25	32	0.8	YWMT16T3...

**RE : Standard corner radius

SPARE PARTS

Designation	Clamping screw	Wrench
SYQBR/L...	CSTB-2.5L080	T-8F

Y-PRO SERIES

SYHBR/L

Screw-on toolholder with 100° approach angle, for positive 25° rhombic inserts

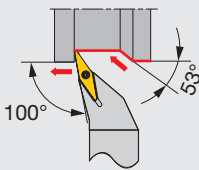

Cutting edge style H

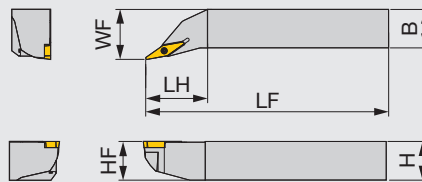

Right hand (R) shown.

Inch	H	B	LF	LH	HF	WF	RE**	Insert
SYHBR/L123	0.750	0.750	4.500	1.350	0.750	1.000	0.031	YWMT16T3...
SYHBR/L163	1.000	1.000	6.000	1.500	1.000	1.250	0.031	YWMT16T3...
Metric	H	B	LF	LH	HF	WF	RE**	Insert
SYHBR/L2020K16	20	20	125	35	20	27	0.8	YWMT16T3...
SYHBR/L2525M16	25	25	150	40	25	32	0.8	YWMT16T3...

**RE : Standard corner radius

SPARE PARTS

Designation	Clamping screw	Wrench
SYHBR/L...	CSTB-2.5L080	T-8F

INSERT SELECTION

P	Application	Finishing to medium cutting	K	Application	Finishing to medium cutting
	Grade	T9225		Grade	GT9530
	Chipbreaker Shape	ZM		Chipbreaker Shape	ZM
	Cutting conditions	B008		Cutting conditions	B012

Reference pages: SYQBR/L, SYHBR/L: Inserts → B163

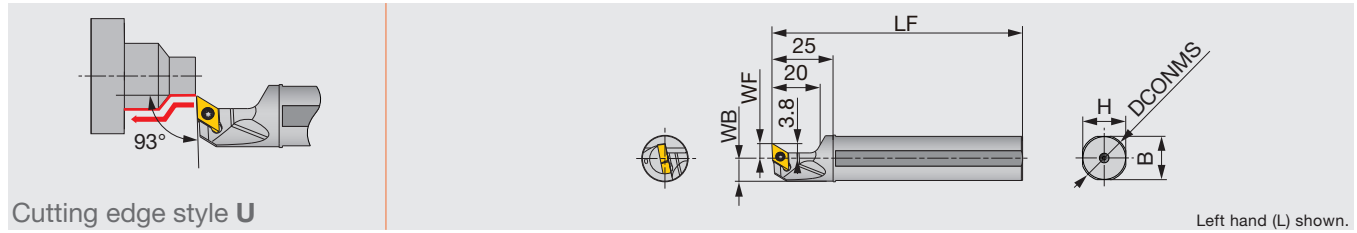

Cutting edge style U

Inch	DCONMS	WF	LF	H	B	WB	RE**	Insert	Torque
JS159F-SDUXL07	0.625	0.236	3.346	0.591	0.591	0.303	0.008	DXGU0703**L...	0.66
JS19G-SDUXL07	0.750	0.236	3.543	0.709	0.709	0.365	0.008	DXGU0703**L...	0.66
JS19X-SDUXL07	0.750	0.236	4.724	0.709	0.709	0.365	0.008	DXGU0703**L...	0.66
JS254X-SDUXL07	1.000	0.394	4.724	0.945	0.945	0.490	0.008	DXGU0703**L...	0.66
Metric	DCONMS	WF	LF	H	B	WB	RE**	Insert	Torque*
JS14H-SDUXL07	14	6	100	13	13	6.75	0.2	DXGU0703**L...	0.9
JS159F-SDUXL07	15.875	6	85	15	15	7.687	0.2	DXGU0703**L...	0.9
JS16F-SDUXL07	16	6	85	15	15	7.75	0.2	DXGU0703**L...	0.9
JS19G-SDUXL07	19.05	6	90	18	18	9.275	0.2	DXGU0703**L...	0.9
JS19X-SDUXL07	19.05	6	120	18	18	9.275	0.2	DXGU0703**L...	0.9
JS20G-SDUXL07	20	6	90	19	19	9.75	0.2	DXGU0703**L...	0.9
JS20X-SDUXL07	20	6	120	19	19	9.75	0.2	DXGU0703**L...	0.9
JS22X-SDUXL07	22	10	120	21	21	10.75	0.2	DXGU0703**L...	0.9
JS25H-SDUXL07	25	10	100	24	24	12.25	0.2	DXGU0703**L...	0.9
JS254X-SDUXL07	25.4	10	120	24	24	12.45	0.2	DXGU0703**L...	0.9

Torque: Recommended clamping torque: lbs-ft (*N·m) **RE: Standard corner radius
Use left-hand toolholders (L) with left-hand inserts (L).

SPARE PARTS

Designation	Clamping screw	Wrench
JS**-SDUXL07	SR34-514	T-7F

INSERT SELECTION

Swiss lathes

P	Application	Finishing	Medium cutting	M	Application	Finishing	Medium cutting
	Grade	SH725	AH725		SH725	AH725	
Chipbreaker Shape	JSS	JTS	JSS	JTS			
Cutting conditions	C143		C143				

Small CNC lathes

P	Application	Finishing	Medium cutting	M	Application	Finishing	Medium cutting
	Grade	AH725	AH725		AH8015	AH8015	
Chipbreaker Shape	SS	TS	SS	TS			
Cutting conditions	C143		C143				

Reference pages: JS-SDUXL: Inserts → **B127** -
Standard cutting conditions → **C143**



Screw-on round-shank toolholder with 93° approach angle, for VXGU inserts

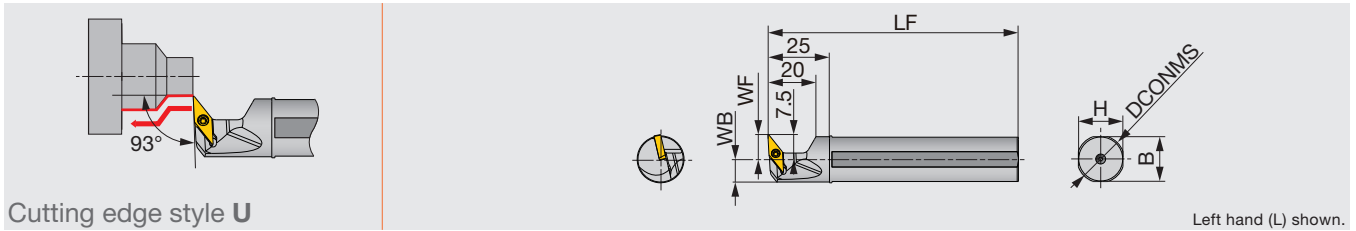

Cutting edge style U

Left hand (L) shown.

Inch	DCONMS	WF	LF	H	B	WB	RE**	Insert	Torque
JS159F-SVUXL09	0.625	0.394	3.346	0.591	0.591	0.303	0.008	VXGU09T2**L...	0.66
JS19G-SVUXL09	0.750	0.394	3.543	0.709	0.709	0.362	0.008	VXGU09T2**L...	0.66
JS19X-SVUXL09	0.750	0.394	4.724	0.709	0.709	0.362	0.008	VXGU09T2**L...	0.66
JS254X-SVUXL09	1.000	0.394	4.724	0.945	0.945	0.488	0.008	VXGU09T2**L...	0.66

Metric	DCONMS	WF	LF	H	B	WB	RE**	Insert	Torque*
JS159F-SVUXL09	15.875	10	85	15	15	7.7	0.2	VXGU09T2**L...	0.9
JS16F-SVUXL09	16	10	85	15	15	7.7	0.2	VXGU09T2**L...	0.9
JS19G-SVUXL09	19.05	10	90	18	18	9.2	0.2	VXGU09T2**L...	0.9
JS19X-SVUXL09	19.05	10	120	18	18	9.2	0.2	VXGU09T2**L...	0.9
JS20G-SVUXL09	20	10	90	19	19	9.7	0.2	VXGU09T2**L...	0.9
JS20X-SVUXL09	20	10	120	19	19	9.7	0.2	VXGU09T2**L...	0.9
JS22X-SVUXL09	22	10	120	21	21	10.7	0.2	VXGU09T2**L...	0.9
JS25H-SVUXL09	25	10	100	24	24	12.2	0.2	VXGU09T2**L...	0.9
JS254X-SVUXL09	25.4	10	120	24	24	12.4	0.2	VXGU09T2**L...	0.9

Torque: Recommended clamping torque: lbs-ft (*N-m) **RE: Standard corner radius
Use left-hand toolholders (L) with left-hand inserts (L).

SPARE PARTS



Designation	Clamping screw	Wrench
JS**-SVUXL09	SR34-508	T-7F

INSERT SELECTION

Swiss lathes

P	Application	Finishing	M	Application	Finishing
	Grade	SH725		Grade	SH725
	Chipbreaker Shape	JRP		Chipbreaker Shape	JRP
	Cutting conditions	C143		Cutting conditions	C143

Small CNC lathes

P	Application	Finishing	M	Application	Finishing
	Grade	SH725		Grade	SH725
	Chipbreaker Shape	JRP		Chipbreaker Shape	JRP
	Cutting conditions	C143		Cutting conditions	C143

Reference pages: JS-SVUXL: Inserts → **B158**
Standard cutting conditions → **C143**

Y-PRO SERIES

SYIBN

Screw-on toolholder with 77.5° approach angle, for positive 25° rhombic inserts

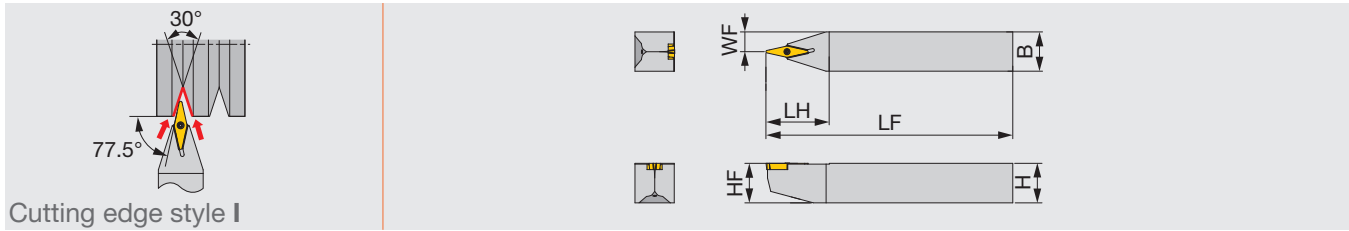

Inch	H	B	LF	LH	HF	WF	RE**	Insert
SYIBN123	0.750	0.750	4.500	1.250	0.750	0.375	0.031	YWMT16T3...
SYIBN163	1.000	1.000	6.000	1.500	1.000	0.500	0.031	YWMT16T3...

Metric	H	B	LF	LH	HF	WF	RE**	Insert
SYIBN2020K16	20	20	125	32	20	10	0.8	YWMT16T3...
SYIBN2525M16	25	25	150	40	25	12.5	0.8	YWMT16T3...

**RE : Standard corner radius

SPARE PARTS

Designation	Clamping screw	Wrench
SYIBN...	CSTB-2.5L080	T-8F

INSERT SELECTION

P	Application	Finishing to medium cutting	K	Application	Finishing to medium cutting
	Grade	T9225		Grade	GT9530
	Chipbreaker Shape	ZM		Chipbreaker Shape	ZM
	Cutting conditions	B008		Cutting conditions	B012

Reference pages: SYIBN: Inserts → **B163**

Lever-lock toolholder with TungCap connection, for negative 80° rhombic inserts, with high pressure coolant capability

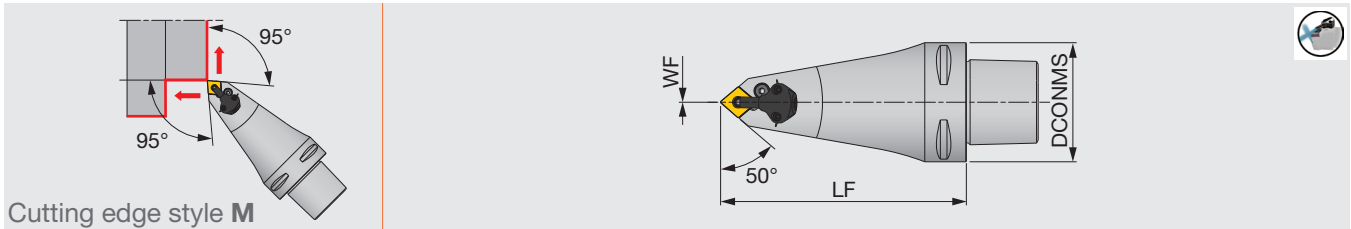

Metric	DCONMS	LF	WF	RE	Insert
C6PCMNN00130-12-CHP	63	115	0	0.8	CN/GN**1204...

Applicable for 14 MPa coolant
**RE : Standard corner radius

For external turning only

SPARE PARTS

Designation	Shim	Clamping screw	Wrench 1	Spring pin	Lever
C6PCMNN00130-12-CHP	LSC42	LCS4	P-3	LSP4	LCL4

SPARE PARTS

Designation	Coolant unit	Mounting screw	Wrench 2	O-ring
C6PCMNN00130-12-CHP	CU-CW-CHP	SRM3	T-8F	OR6.4X0.9N

INSERT SELECTION

Application	Precision finishing	Finishing	Medium cutting	Medium to heavy cutting
Grade	NS9530	GT9530	T9215	T9215
Chipbreaker Shape	TF	TSF	TM	TH
Cutting conditions	B008			

Application	Finishing	Medium cutting	Medium to heavy cutting
Grade	T6120	T6130	T6130
Chipbreaker Shape	SF	SM	SH
Cutting conditions	B010		

Application	Finishing	Medium cutting	Medium to heavy cutting
Grade	T515	T515	T515
Chipbreaker Shape	All-round	All-round	All-round
Cutting conditions	B012		

Application	Precision finishing	Finishing	Medium cutting
Grade	DX120	DX140	TH10
Chipbreaker Shape	T-DIA	with rake T-DIA	P
Cutting conditions	B014		

Application	Precision finishing	Finishing	Medium cutting
Grade	BX470	AH8005	AH8005
Chipbreaker Shape	T-CBN	HRF	HRM
Cutting conditions	B016		

Application	Precision finishing	Finishing
Grade	BXM10	BXM20
Chipbreaker Shape	T-CBN	T-CBN
Cutting conditions	B018	

Reference pages: C-PCMNN-CHP: Inserts → **B056 -**, CBN → **B172 -**, PCD → **B194 -**
Parts for coolant hose → **C142**

Lever-lock toolholder with TungCap connection, for negative 55° rhombic inserts, with high pressure coolant capability

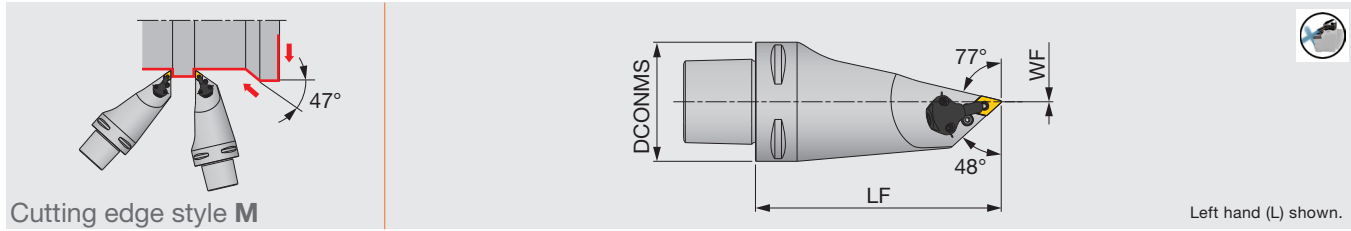

Metric	DCONMS	LF	WF	RE**	Insert
C6PDMNL00130-1104-CHP	63	130	0	0.8	DN**1104...

Applicable for 14 MPa coolant
**RE : Standard corner radius

For external turning only

SPARE PARTS

Designation	Shim	Clamping screw	Wrench 1	Spring pin	Lever
C6PDMNL00130-1104-CHP	ELSD32	LCS3	P-2.5	LSP3	LCL33L

SPARE PARTS

Designation	Coolant unit	Mounting screw	Wrench 2	O-ring
C6PDMNL00130-1104-CHP	CU-D-CHP	SRM3	T-8F	OR6.4X0.9N

INSERT SELECTION

Application	Finishing	Medium cutting
	Grade	T9215
Chipbreaker Shape	TSF	TM
Cutting conditions	B008	

Application	Finishing	Medium cutting
	Grade	T6120
Chipbreaker Shape	SS	SM
Cutting conditions	B010	

Application	Medium cutting
Grade	T515
Chipbreaker Shape	TM
Cutting conditions	B012

Reference pages: C-PDMNL-CHP: Inserts → **B067** -
Parts for coolant hose → **C142**

Grade
Insert
Ext. Toolholder
Int. Toolholder
Threading
Grooving
Milling Cutter
Miniature Tool
Endmill
Drilling Tool
User's Guide
Tooling System
Index



Technical Guide

PARTS FOR COOLANT HOSE

Connecting hose

Fig. 1

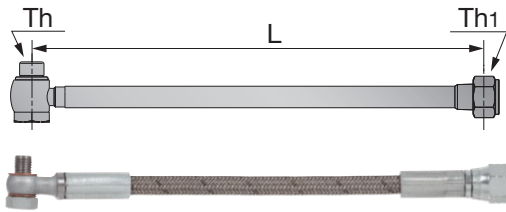
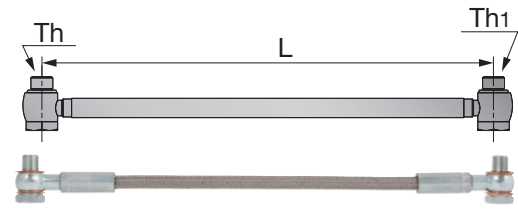
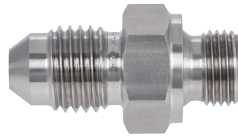
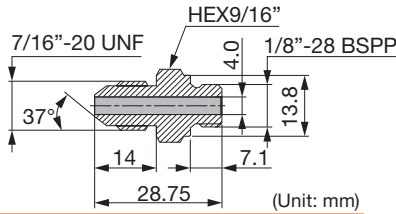

Fig. 2



Metric	L	Th	Th1	Max. pressure (Mpa)	Fig.
CHP-HOSE-G1/8-7/16-200BS	200	G1/8"-28 BSPP	7/16"-20 UNF	26	1
CHP-HOSE-G1/8-7/16-250BS	250	G1/8"-28 BSPP	7/16"-20 UNF	26	1
CHP-HOSE-5/16-7/16-200BS	200	5/16"-24UNF	7/16"-20 UNF	20	1
CHP-HOSE-5/16-G1/8-200BS	200	5/16"-24UNF	G1/8"-28 BSPP	20	1
CHP-HOSE-G1/8-G1/8-200BB	200	G1/8"-28 BSPP	G1/8"-28 BSPP	26	2
CHP-HOSE-G1/8-G1/8-250BB	250	G1/8"-28 BSPP	G1/8"-28 BSPP	26	2

Connector



Metric
CHP-NIPPLE-G1/8-7/16UNF

Seal washer

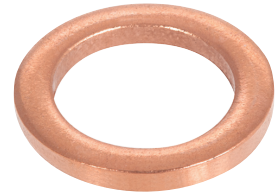
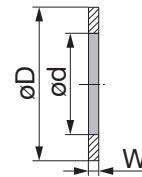

Metric	øD	ød	W
CHP-COPPER-SEAL1/8	15	10	1
CHP-COPPER-SEAL5/16	11	8	1
CHP-COPPER-SEAL5/16-2.5	11	8	2.5

Connector for small lathe with seal washer

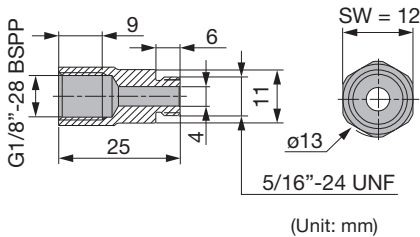

Metric	L	Fig.
CHP-CONNECTOR/5/16-G1/8	2.5	1
CHP-CONNECTOR-G1/8-R1/8	2.54	2

STANDARD CUTTING CONDITIONS



ISO	Workpiece material	Chipbreaker	Grade	Cutting Speed Vc (sfm)	Depth of cut ap (in)	Feed f (ipr)
P	Steels 1045, etc.	6RS	T9215	492 - 984	0.020 - 0.079	0.020 - 0.039
		6RS	T9225	394 - 820	0.020 - 0.079	0.020 - 0.039
		6RS	NS9530	492 - 820	0.020 - 0.079	0.020 - 0.039
		6RM	T9215	492 - 984	0.039 - 0.118	0.020 - 0.039
		6RM	T9225	394 - 820	0.039 - 0.118	0.020 - 0.039
		6RM	NS9530	492 - 820	0.039 - 0.118	0.020 - 0.039

Reference pages: SRGCR/L → C089, SRDCN → C107

STANDARD CUTTING CONDITIONS

MINIFORCE TURN

Applications	ISO	Workpiece material	Priority	Chipbreaker	Grade	Cutting speed Vc (sfm)	Depth of cut ap (in)	Feed f (ipr)
Swiss lathes	P	Low carbon steels , Carbon steels 1045, etc.	First choice	JS	SH725	164 - 590	0.004 - 0.118	0.001 - 0.004
		Low alloy steels, Alloy steels 4140, etc.	Sharpness	JSS	SH725	164 - 590	0.004 - 0.059	0.001 - 0.004
	M	Stainless steels (Austenitic) 304, etc.	First choice	JS	SH725	164 - 590	0.004 - 0.049	0.001 - 0.004
		Stainless steels (Martensitic and ferritic) 430, etc. Stainless steels (Precipitation hardened) 174, etc.	Sharpness	JSS	SH725	164 - 590	0.004 - 0.059	0.001 - 0.004
Small CNC lathes	P	Low carbon steels, Carbon steels 1045, etc. Low alloy steels, Alloy steels 4140, etc.	First choice	SS	AH725	164 - 590	0.006 - 0.059	0.002 - 0.008
				TS	AH725	164 - 590	0.012 - 0.079	0.003 - 0.012
			Surface quality	SS	NS9530	164 - 656	0.006 - 0.059	0.002 - 0.008
				TS	NS9530	164 - 656	0.012 - 0.079	0.003 - 0.012
	Wear resistance	SS	GT9530	164 - 820	0.006 - 0.059	0.002 - 0.008		
		TS	GT9530	164 - 820	0.012 - 0.079	0.003 - 0.012		
M	Stainless steels (Austenitic) 304, etc. Stainless steels (Martensitic and ferritic) 430, etc. Stainless steels (Precipitation hardened) 174, etc.	First choice	SS	AH725	164 - 492	0.006 - 0.059	0.002 - 0.008	
		Fracture resistance	TS	AH725	164 - 492	0.012 - 0.079	0.003 - 0.012	

TURNFEED

For HD holder (High Depth of Cut)

ISO	Insert	Depth of cut ap (in)	Feed f (ipr)	Cutting speed: Vc (sfm)		
				T9215	T9125	T9225
P	POMG110612-MNW	0.031 - 0.217	0.016 - 0.047	150 - 400	80 - 180	120 - 300
	POMG130612-MNW	0.039 - 0.051	0.016 - 0.051	150 - 400	80 - 180	120 - 300

For HF holder (High Feed)

ISO	Insert	Depth of cut ap (in)	Feed f (ipr)	Cutting speed: Vc (sfm)		
				T9215	T9125	T9225
P	POMG110612-MNW	0.039 - 0.098	0.020 - 0.059	150 - 400	80 - 180	120 - 300
	POMG130612-MNW	0.039 - 0.118	0.020 - 0.079	150 - 400	80 - 180	120 - 300

TURNFEED

ISO	Workpiece material	Grade	Chipbreaker	Cutting speed Vc (sfm)	Depth of cut ap (in)	Feed f (ipr)
P	Mild and low carbon steels 400SS, 1025, etc. < 180 HB	T9225	ML	330 - 990	0.025 - 0.100	0.025 - 0.100
	Carbon and alloy steels 1049, 4142, etc. < 300HB	T9215	ML	390 - 1150	0.025 - 0.100	0.025 - 0.100
M	Stainless steels 304, 316, etc. < 250 HB	T9225	ML	330 - 990	0.025 - 0.100	0.025 - 0.100
K	Gray and ductile cast irons No35B, 60-40-18, etc.	AH120	ML	330 - 820	0.025 - 0.100	0.025 - 0.100

When the side cutting edge is used for facing, the maximum feed is limited to within 0.040 ipr.

Reference pages: JSWL2XR/L, JSWLXR/L, JSWL2XR/L-CHP, JPWL2XR/L, JSWLXR-F → **C033 - C036**
 JSDJ2XR/L, JSDJXR/L, JSDJ2XR/L-CHP, JPDJ2XR/L, JSDJXR-F → **C042 - C045**
 JSVJ2XR/L, JSVJXR/L, JSVJ2XR/L-CHP, JPVJ2XR/L, JSVJXR-F → **C059 - C061**
 PPXOR/L-HD, PPXOR/L-HF → **C102**, XWXPR/L → **C104**
 JS-SDUXL, JS-SVUXL → **C137 - C138**

Technical Guide

STANDARD CUTTING CONDITIONS

TURNTEC

LNMX1204

*Values in red are for facing.

ISO	Workpiece material	Chip breaker	Grade	Cutting speed Vc (sfm)	Depth of cut: ap (in)		Feed: f (ipr)	
					RE : 0.031	RE : 0.047	RE : 0.031	RE : 0.047
P	Steels 1045, 4130, etc.	TDR	T9115	390 - 820	0.020 - 0.195 0.020 - 0.086	0.031 - 0.195 0.031 - 0.086	0.006 - 0.024	0.010 - 0.031
		TDR	T9125	260 - 590	0.020 - 0.195 0.020 - 0.086	0.031 - 0.195 0.031 - 0.086	0.006 - 0.024	0.010 - 0.031
M	Stainless steels 304, 316, etc.	TDR	T9115	330 - 590	0.020 - 0.195 0.020 - .086	0.031 - 0.195 0.031 - 0.086	0.006 - 0.024	0.010 - 0.031
		TDR	T9125	260 - 590	0.020 - 0.195 0.020 - 0.086	0.031 - 0.195 0.031 - 0.086	0.006 - 0.024	0.010 - 0.031

LNMX1606

ISO	Workpiece material	Chip breaker	Grade	Cutting speed Vc (sfm)	Depth of cut: ap (in)			Feed: f (ipr)		
					RE : 0.031	RE : 0.047	RE : 0.063	RE : 0.031	RE : 0.047	RE : 0.063
P	Steels 1045, 4130, etc.	TDR	T9115	390 - 820	0.020 - 0.197 0.020 - 0.126	0.031 - 0.236 .031 - 0.126	0.039 - 0.315 0.039 - 0.126	0.006 - 0.024	0.010 - 0.031	0.012 - 0.039
		TDR	T9125	260 - 590	0.020 - 0.197 0.020 - 0.126	0.031 - 0.236 .031 - 0.126	0.039 - 0.315 0.039 - 0.126	0.006 - 0.024	0.010 - 0.031	0.012 - 0.039
		TWR	T9115	390 - 820	0.020 - 0.197 0.020 - 0.126	0.031 - 0.236 0.031 - 0.126	-	0.006 - 0.024	0.010 - 0.031	-
		TWR	T9125	260 - 590	0.020 - 0.197 0.020 - 0.126	0.031 - 0.236 0.031 - 0.126	-	0.006 - 0.024	0.010 - 0.031	-
M	Stainless steels 304, 316, etc.	TDR	T9115	330 - 590	0.020 - 0.197 0.020 - 0.126	0.031 - 0.236 0.031 - 0.126	0.039 - 0.315 0.039 - 0.126	0.006 - 0.024	0.010 - 0.031	0.012 - 0.039
		TDR	T9125	260 - 590	0.020 - 0.197 0.020 - 0.126	0.031 - 0.236 0.031 - 0.126	0.039 - 0.315 0.039 - 0.126	0.006 - 0.024	0.010 - 0.031	0.012 - 0.039
		MDR	T9115	330 - 490	0.059 - 0.236 0.020 - 0.126	0.059 - 0.276 0.031 - 0.126	-	0.004 - 0.020	0.006 - 0.028	-
		MDR	AH725	160 - 490	0.059 - 0.236 0.020 - 0.126	0.059 - 0.276 0.031 - 0.126	-	0.004 - 0.020	0.006 - 0.028	-
		TWR	T9115	330 - 590	0.020 - 0.197 0.020 - 0.126	0.031 - 0.236 0.031 - 0.126	-	0.006 - 0.024	0.010 - 0.031	-
		TWR	T9125	260 - 590	0.020 - 0.197 0.020 - 0.126	0.031 - 0.236 0.031 - 0.126	-	0.006 - 0.024	0.010 - 0.031	-

LNMX2410

ISO	Workpiece material	Chip breaker	Grade	Cutting speed Vc (sfm)	Depth of cut: ap (in)		Feed: f (ipr)	
					RE : 0.063	RE : 0.094	RE : 0.063	RE : 0.094
P	Steels 1045, 4130, etc.	TDR	T9115	390 - 820	0.156 - 0.585 0.039 - 0.176	0.195 - 0.585 0.039 - 0.176	0.012 - 0.039	0.012 - 0.043
		TDR	T9125	260 - 490	0.156 - 0.585 0.039 - 0.176	0.195 - 0.585 0.039 - 0.176	0.012 - 0.039	0.012 - 0.043
M	Stainless steels 304, 316, etc.	TDR	T9115	330 - 590	0.156 - 0.585 0.039 - 0.176	0.195 - 0.585 0.039 - 0.176	0.012 - 0.039	0.012 - 0.043
		TDR	T9125	260 - 490	0.156 - 0.585 0.039 - 0.176	0.195 - 0.585 0.039 - 0.176	0.012 - 0.039	0.012 - 0.043

DIMPLEFX

ISO	Workpiece material	Grade	Cutting speed Vc (sfm)	Depth of cut ap (in)	Feed f (ipr)
K	Gray cast irons	FX105	2300 (1000 - 3300)	0.040 (0.002 - 0.120)	0.012 (0.002 - 0.024)
	Ductile cast irons	FX105	650 (330 - 1000)	0.040 (0.002 - 0.120)	0.008 (0.002 - 0.016)

Reference pages: CCLNR/L-RD → **C024**, CDNNN-RD → **C070**, CVVNN-RD → **C074**
 TLANR/L → **C082**, TLBNR/L → **C097**, CHSNR/L → **C111**
 CSSNR/L → **C114**, TLFNR/L → **C120**

Internal Toolholder



Internal Toolholder - Content structure

- Indexable toolholders are listed by cutting edge shape.
- In the same cutting edge shape, the inserts are sorted alphabetically.
The order of the list: CN□□ insert → DN□□ insert → RN□□ insert → SN□□ insert → TN□□ insert → VN□□ insert → WN□□ insert
- Toolholders in the catalog are our standard stock items.

How to use the page

- Method ① Select the approach angle described at the left end of each page, jump to the page on the left index, and choose a designation you need ④ in the dimension table ③. Applicable inserts are shown in ⑥ and ⑧.
- Method ② Select the approach angle on D003 and check the details on the product page.
- Method ③ Select the series name of a toolholder on D003 and check the details on each page.
- Method ④ Select an item from Quick Guide on D006 - D011.

2 MINI FURN
A/E-SWLXR/L
Screw-on boring bar, for WXGU inserts

1 Cutting edge style L

inch	Material	DMIN	DCONMS	WF	LF	LH	H	GAMP	GAMP RE**	Insert	Torque
A06-SWLXR/L2-D08	Steel	0.500	0.375	0.281	5.000	0.750	0.350	-10°	-14°	WXGU402°L/R	0.66
A08-SWLXR/L2-D11	Steel	0.688	0.500	0.406	5.000	1.000	0.475	-10°	-10°	WXGU402°L/R	0.66
A10-SWLXR/L2-D14	Steel	0.875	0.625	0.531	7.000	1.250	0.600	-10°	-8°	WXGU402°L/R	0.66
A12-SWLXR/L2-D16	Steel	1.000	0.750	0.593	7.000	1.438	0.725	-10°	-7°	WXGU402°L/R	0.66
A16-SWLXR/L2-D20	Steel	1.250	1.000	0.625	7.000	1.438	0.938	-10°	-7°	WXGU402°L/R	0.66
E06-SWLXR/L2-D08	Carbide	0.500	0.375	0.281	5.000	1.000	0.350	-10°	-14°	WXGU402°L/R	0.66
E08-SWLXR/L2-D11	Carbide	0.688	0.500	0.406	5.000	1.063	0.475	-10°	-10°	WXGU402°L/R	0.66
E10-SWLXR/L2-D14	Carbide	0.875	0.625	0.531	7.000	1.250	0.600	-10°	-8°	WXGU402°L/R	0.66
E12-SWLXR/L2-D16	Carbide	1.000	0.750	0.593	7.000	1.438	0.725	-10°	-7°	WXGU402°L/R	0.66
E16-SWLXR/L2-D20	Carbide	1.250	1.000	0.625	10.000	1.812	0.938	-10°	-7°	WXGU402°L/R	0.66

4 SPARE PARTS

Designation	Clamping screw	Wrench	Lever	Oil supply, alternative	Screw for flange
A16M-PWLNR/L0604-D200	LC533	P-2F	LCL33N	-	SHM5-4
A200-PWLNR/L0604-D250	LC533	P-2F	LCL33N	EA.20	SHM5-4

8 INSERT SELECTION

Application	Finishing	Medium cutting	Application	Finishing	Medium cutting
Grade	TS215	TM	Grade	TS120	TM
Breaker Shape	TS	TM	Breaker Shape	TS	TM
Cutting conditions	D105	D105	Cutting conditions	B010	B010

Reference pages: A/E-SWLXR/L: Insert → B161 - Standard cutting conditions → D105

D034 www.tungaloy.com/us

2 ISO ETURN
A-PWLNR/L-Eco
Lever-lock boring bar, for negative 80° trigon inserts

1 Cutting edge style L

inch	Material	DMIN	DCONMS	WF	LF	LH	H	GAMP	GAMP RE**	Insert	Torque
A16M-PWLNR/L0604-D200	Steel	20	16	11	150	32	15	3	-8°	-17°	0.8 WLN*054L 1.7
A200-PWLNR/L0604-D250	Steel	25	20	13	150	36	18	3	-8°	-14°	0.8 WLN*054L 1.7

4 SPARE PARTS

Designation	Clamping screw	Wrench	Lever	Oil supply, alternative	Screw for flange
A16M-PWLNR/L0604-D200	LC533	P-2F	LCL33N	-	SHM5-4
A200-PWLNR/L0604-D250	LC533	P-2F	LCL33N	EA.20	SHM5-4

8 INSERT SELECTION

Application	Finishing	Medium cutting	Application	Finishing	Medium cutting
Grade	TS215	TM	Grade	TS120	TM
Breaker Shape	TS	TM	Breaker Shape	TS	TM
Cutting conditions	D006	D105	Cutting conditions	B010	B010

Reference pages: A-PWLNR/L-Eco: Insert → B101 -

Tungaloy D035









- ① : Cutting edge shape
- ② : Series name of indexable boring bars
- ③ : Dimension table
- ④ : Toolholder designation
e.g. To select right-handed steel shank for minimum machining diameter $\phi 0.750''$
- ⑤ : Applicable insert
- ⑥ : Dimension drawing (conforming to ISO13399)
- ⑦ : Spare parts
- ⑧ : Insert selection
- ⑨ : Reference pages

→ **A12-SCLCR3-D16**

When ordering

- Please specify the designation and quantity.
e.g. **A12-SCLCR/L3-D16 ... 1** (one boring bar per package)
- * Inserts are not included. Please order those separately.

Main products

L 95°		D020
X 100°		D040
J 142°		D043
K 75°		D045
F 91°		D049
U 93°		D056
Q 107.5°		D085
Z 93°		D093
OTHERS		D100

			Inch	Metric
	BOREMEISTER Boring head suitable for L/D=10 Shank $\varnothing 0.625'' - \varnothing 2.500''$	D018	<input checked="" type="checkbox"/>	<input type="checkbox"/>
	MINIFORCE Economical double-sided inserts with excellent sharpness Shank $\varnothing 0.500'' - \varnothing 1.250''$ ($\varnothing 10$ mm - 20 mm)	D034, D042, D093	<input checked="" type="checkbox"/>	<input checked="" type="checkbox"/>
	ISO ETURN Small-sized "Eco" insert series for maximized profits Shank $\varnothing 1.000'' - \varnothing 1.250''$ ($\varnothing 16$ mm - 32 mm)	D028 D035, D036 D052, D062 D069, D080	<input checked="" type="checkbox"/>	<input checked="" type="checkbox"/>
	STREAMJETBAR Highly rigid toolholders providing good chip evacuation Shank $\varnothing 0.157'' - \varnothing 1.000''$ ($\varnothing 4$ mm - 50 mm)	D019	<input checked="" type="checkbox"/>	<input checked="" type="checkbox"/>
	Y-PRO SERIES Inserts with 25° corner angle for profiling Shank $\varnothing 0.500'' - \varnothing 0.625''$ ($\varnothing 12$ mm - 16 mm)	D084, D092	<input checked="" type="checkbox"/>	<input checked="" type="checkbox"/>
	TURNINGA Highly rigid clamping system with excellent repeatability Shank $\varnothing 1.000'' - \varnothing 2.000''$	D039, D048 D055, D065 D082	<input checked="" type="checkbox"/>	<input type="checkbox"/>
	TUNG TJET Toolholders for high pressure coolant supply	D031, D065	<input checked="" type="checkbox"/>	<input checked="" type="checkbox"/>
	Sleeve	D103 - D104	<input type="checkbox"/>	<input checked="" type="checkbox"/>

Designation system for Toolholders

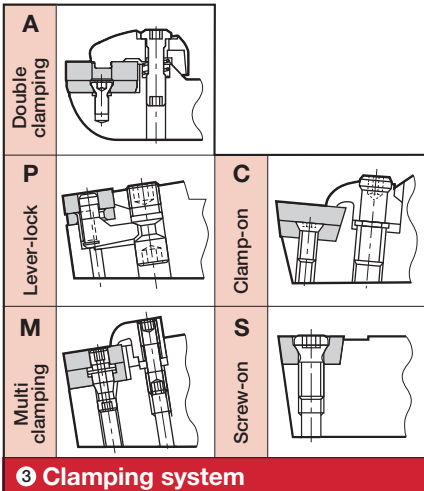

C		80° Rhombic
D		55° Rhombic
K		55° Parallelogram
R		Round
S		Square
T		Triangular
V		35° Rhombic
Y		25° Rhombic (Non ISO)
W		Trigon

4 Insert shape



1 Bar composition

A	Steel shank with oil hole
E	Carbide shank with steel head & oil hole
C	Carbide shank with steel head
S	Steel shank

2 Bar diameter (in)

06	0.375
08	0.500
10	0.625
12	0.750
16	1.000
20	1.250

Metric: The diameter of the bar is shown in mm.

ANSI Designation

Symbol	Style	Offset						
A		Without	G		With	S		With
			J		Without	V		Without
B		Without	K		With	U		With
			L		Without	X*		With
C		Without	N		Without	Y		With
D		Without	P*		Without	Z		Without
E		Without	Q*		With	Note *mark: Tungaloy standard No mark: ISO standard		
F		With						

N	0°
B	5°
C	7°
D	15°
E	20°
P	11°

6 Cutting edge style

6 Relief angle of insert

5 L 6 C 7 R 8 4 - 9 D14

7 Hand of tool	
R	
L	
N	Neutral

8 Insert size I.C.	
Symbol	Inscribed circle (in)
3	0.375
4	0.500
5	0.625
6	0.750

9 Min. bore diameter (in)	
Stream Jet Bar	
D14	14/16 (ø0.875)

Grade
Insert
Ext. Toolholder
Int. Toolholder
Threading
Grooving
Miniature Tool
Endmill
Drilling Tool
System
Index

A
B
C
D
E
F
G
H
I
J
K
L
M

Designation system for Toolholders

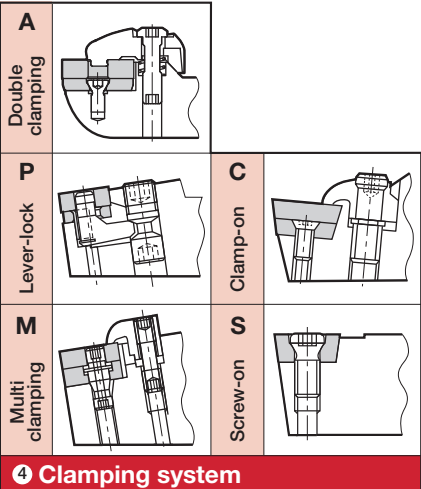

C		80° Rhombic
D		55° Rhombic
K		55° Parallelogram
R		Round
S		Square
T		Triangular
V		35° Rhombic
Y		25° Rhombic (Non ISO)
W		Trigon

5 Insert shape



1 Bar composition

A	Steel shank with oil hole
E	Carbide shank with steel head & oil hole
C	Carbide shank with steel head
S	Steel shank
T	Steel shank reinforced with carbide plates ("Tsuppari-Ichiban")
JS	J series Steel shank

2 Bar diameter

Bar diameter is shown in mm.

3 Toolholder length (mm)

F	80
G	90
H	100
J	110
K	125
L	130
M	150
P	170
Q	180
R	200
S	250
T	300
U	350

ISO Designation

Symbol	Style	Offset				
A		Without	G		With	S
					Without	V
B		Without	J		With	U
					Without	X*
C		Without	K		With	Y
					Without	Z
D		Without	L		With	
					Without	
E		Without	N		With	
					Without	
F		With	P*		Without	Note *mark: Tungaloy standard No mark: ISO standard
					With	
					With	

C	
B	
N	
P	
X	Special

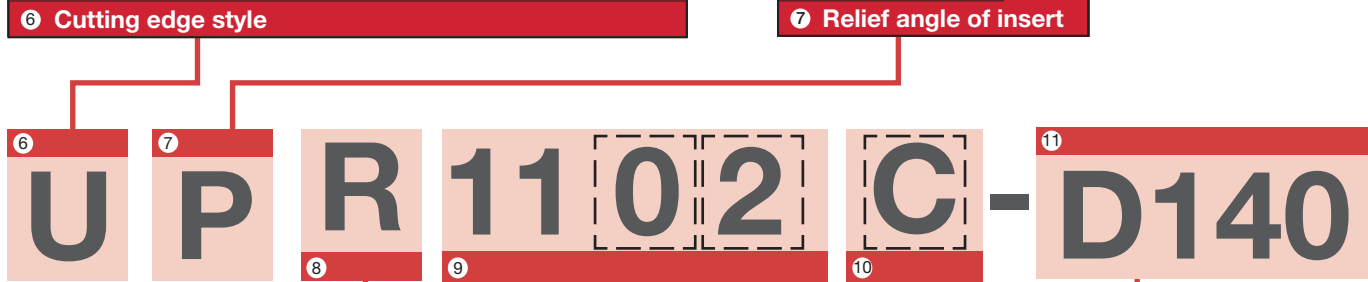

8 Hand of tool	
R	
L	

9 Insert size

For M, S, & C types conformed to ISO

"In ISO metric system, a two digit number indicates the edge length (L) of the insert to be used in mm.
If the insert thickness is different for the same edge length, add the thickness symbol (S) (two digit number).
In above example, TP□□1102□□"

10 Oil hole







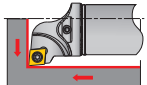

Only "Tsuppari-Ichiban" holder

11 Min. bore diameter (mm)			
Stream Jet Bar		Tsuppari-Ichiban	
D140	ø14.0	D14	ø14.0

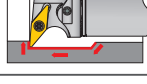
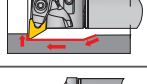
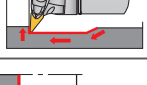
Internal Toolholder - Quick Guide

Positive type

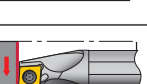
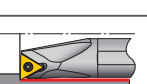
Inch

Style	Designation & Application	ISO Insert	Material	Toolholder	Min. bore diameter DMIN (in)					Page
					0	0.375	0.750	1.125	1.500	
	S-SCLCR/L-H Boring & internal facing Insert : CC□□	✓	Steel	✓			ø0.787"	ø1.968"		D020
	S-SDUCR/L-H Boring & internal profiling Insert : DC□□	✓	Steel	✓			ø0.787"	ø1.968"		D056
	S-SVUCR/L-H Boring & internal profiling Insert : VC□□	✓	Steel	✓			ø1.063"	ø1.260"		D074
	S-SVLCR/L-H Boring & internal profiling Insert : VC□□	✓	Steel	✓			ø1.260"	ø1.575"		D032
	S-DDUNR/L-H Boring & internal profiling Insert : DN□□	✓	Steel	✓			ø1.575"	ø1.968"		D060
	S-DVUNR/L-H Boring & internal profiling Insert : VN□□	✓	Steel	✓			ø1.575"			D078
	SEXPR/L Boring & internal facing Insert : EP□□	✓	Steel Carbide	✓			ø0.250"	ø0.250"		D040
	SCLCR/L Boring & internal facing Insert : CC□□	✓	Steel Carbide	✓			ø0.500"	ø1.250"		D022
	STUPR/L Boring Insert : TP□□	✓	Steel Carbide	✓			ø0.438"	ø1.250"		D066
	STFPR/L Blind hole boring Insert : TP□□	✓	Carbide	✓			ø0.500"	ø1.000"		D050
	SCLPR/L Boring & internal facing Insert : CP□□	✓	Steel Carbide	✓			ø0.500"	ø0.875"		D025
	STFCR/L Blind hole boring Insert : TC□□	✓	Carbide	✓			ø0.500"	ø1.000"		D049

Positive type

Inch

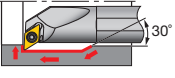
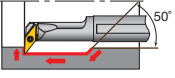
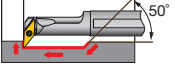
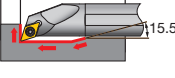
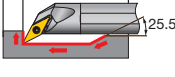
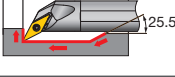
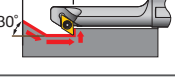
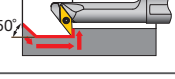
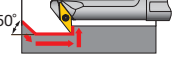
Style	Designation & Application	ISO Insert	Material	Toolholder	Min. bore diameter DMIN (in)					Page	
					0	0.375	0.750	1.125	1.500		2.000
	SDUCR/L Boring & internal profiling Insert : DC□□	✓	Steel Carbide	✓		0.625"	0.750"	1.000"			D058
	SVUCR/L Boring & internal profiling Insert : VC□□	✓	Steel	✓		0.875"	1.000"				D076
	SVUBR/L Boring & internal profiling Insert : VB□□	✓	Steel	✓				1.000"			D072
	SDQCR/L Boring & internal profiling Insert : DC□□	✓	Steel	✓		0.625"	0.875"				D085
	SVQCR/L Boring & internal profiling Insert : VC□□	✓	Steel	✓		0.688"	1.000"				D090
	SVQBR/L Boring & internal profiling Insert : VB□□	✓	Steel	✓				1.000"			D088
	SDZCR/L Back boring Insert : DC□□	✓	Steel	✓				0.875"			D094
	SVZCR/L Back boring Insert : VC□□	✓	Steel	✓		0.750"	1.000"				D099
	SVZBR/L Back boring Insert : VB□□	✓	Steel	✓				1.000"			D098

Grade
Insert
Ext. Toolholder
Int. Toolholder
Threading
Grooving
Miniature Tool
Milling Cutter
Endmill
Drilling Tool
Tooling System
Index



Internal Toolholder - Quick Guide

Positive type

Inch

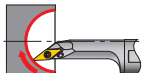
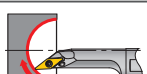
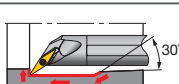
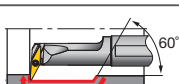
Style	Designation & Application	ISO Insert Y-PRO SERIES	Material	BOREMEISTER STREAMJETBAR MINIFURN Toolholder	Min. bore diameter DMIN (in)						Page
					0	0.375	0.750	1.125	1.500	2.000	
	SVJCR/L Internal sphere cutting Insert : VC□□	✓	Steel	✓						ø1.000"	D044
	SVJBR/L Internal sphere cutting Insert : VB□□	✓	Steel	✓						ø1.000"	D043
	SYQBR/L Boring, undercutting & profiling Insert : YW□□	✓	Steel Carbide	✓			ø0.750"			ø0.875"	D092
	SYUBR/L Boring & internal profiling Insert : YW□□	✓	Steel Carbide	✓						ø1.000" ø0.875" ø1.000"	D084

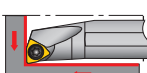
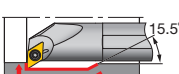
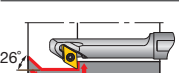
Style	Designation & Application	Material	MINIFURN Insert, Toolholder	Min. bore diameter DMIN (in)						Page	
				0	0.375	0.750	1.125	1.500	2.000		
	SWLXR/L Boring & internal facing Insert : WXGU	Steel Carbide	✓							ø0.500" ø1.250" ø0.500" ø1.250"	D034
	SDXXR/L Boring & internal profiling Insert : DXGU	Steel Carbide	✓							ø0.625" ø1.250" ø0.625" ø1.250"	D042
	SDZXR/L Back boring Insert : DXGU	Steel	✓							ø0.625" ø0.875"	D093

Positive type

Metric

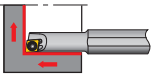
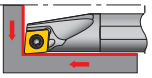
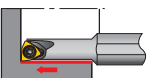
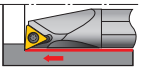
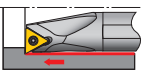
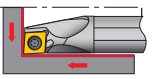
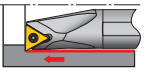
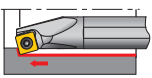
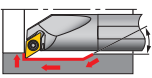
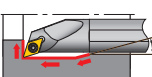
Style	Designation & Application	ISO Insert	Material	Toolholder	Min. bore diameter DMIN (mm)					Page	
					0	10	20	30	40		50
	SEXPR/L Boring & internal facing Insert : EP□□	✓	Steel Carbide	✓	ø4.5	ø7					D040 D041
	SCLCR/L Boring & internal facing Insert : CC□□	✓	Steel Carbide Reinforced	✓	ø5	ø27					D023 D024
	SWUBR/L Boring Insert : WB□□	✓	Steel Carbide	✓	ø6	ø8					D083
	STUPR/L Boring Insert : TP□□	✓	Steel Carbide Reinforced	✓	ø8	ø34					D067 D068
	STFPR/L Blind hole boring Insert : TP□□	✓	Steel Carbide	✓	ø10	ø27					D050
	SCLPR/L Boring & internal facing Insert : CP□□	✓	Steel Carbide Reinforced	✓	ø10	ø27					D026 D027
	STFCR/L Blind hole boring Insert : TC□□	✓	Steel Carbide	✓	ø12	ø18					D049
	SSKPR Through boring Insert : SP□□	✓	Steel	✓		ø20	ø31				D045
	SDUCR/L Boring & internal profiling Insert : DC□□	✓	Steel Carbide	✓	ø13	ø32					D058
	SDUPR/L Boring & internal profiling Insert : DPMT□□		Steel Carbide	✓	ø15	ø22					D059





Index User's Guide Tooling System Drilling Tool Endmill Milling Cutter Miniature Tool Grooving Threading Int. Toolholder Ext. Toolholder Insert Grade

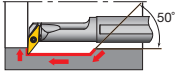
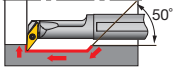
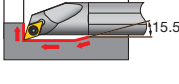
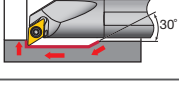

Internal Toolholder - Quick Guide

Positive type

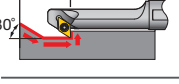
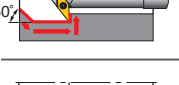
Metric

Style	Designation & Application	ISO Insert Y-PRO SERIES	Material	BOREMEISTER STREAMJETBAR MINIFURN	Min. bore diameter DMIN (mm)					Page	
					0	10	20	30	40		50
	SVUCR/L Boring & internal profiling Insert : VC□□	✓	Steel Carbide Reinforced	✓		ø16	ø32				D076 D077
	SVUBR/L Boring & internal profiling Insert : VB□□	✓	Steel Carbide Reinforced	✓		ø20	ø32	ø24.5	ø34	ø25	D072 D073
	SDQCR/L Boring & internal profiling Insert : DC□□	✓	Steel Carbide Reinforced	✓		ø13	ø30	ø13	ø25	ø20	D085 D086
	SDQPR/L Boring & internal profiling Insert : DPMT□□		Steel Carbide	✓		ø15	ø22	ø15	ø22		D087
	SVQCR/L Boring & internal profiling Insert : VC□□	✓	Steel Carbide Reinforced	✓		ø13.5	ø21.5	ø13.5	ø21.5	ø32	D090 D091
	SVQBR/L Boring & internal profiling Insert : VB□□	✓	Steel Carbide Reinforced	✓		ø17	ø30.5	ø17	ø30.5	ø25	D088 D089
	SDZCR/L Back boring Insert : DC□□	✓	Steel Carbide	✓		ø14	ø25	ø18	ø22		D094
	SVZCR/L Back boring Insert : VC□□	✓	Steel	✓		ø16					D099
	SVZBR/L Back boring Insert : VB□□	✓	Steel	✓		ø20	ø40				D098

Positive type

Metric

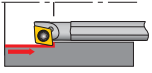
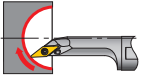
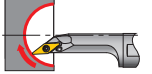
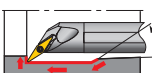
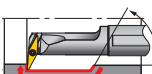
Style	Designation & Application	ISO Insert	Material	Toolholder	Min. bore diameter DMIN (mm)						Page
					0	10	20	30	40	50	
	SEZPR/L Back boring Insert : EP□□	✓	Steel Carbide	✓	0	10	20	30	40	50	D097
	SVJCR/L Internal sphere cutting Insert : VC□□	✓	Steel	✓	0	10	20	30	40	50	D044
	SVJBR/L Internal sphere cutting Insert : VB□□	✓	Steel	✓	0	10	20	30	40	50	D043
	SYQBR/L Boring, undercutting & profiling Insert : YW□□	✓	Steel Carbide	✓	0	10	20	30	40	50	D092
	SYUBR/L Boring & internal profiling Insert : YW□□	✓	Steel Carbide	✓	0	10	20	30	40	50	D084

Clamp on

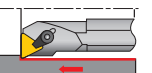
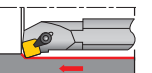
Style	Designation & Application	ISO Insert	Material	Toolholder	Min. bore diameter DMIN (mm)						Page
					0	10	20	30	40	50	
	CTFPR/L Blind hole boring Insert : TP□□ (without hole)	✓	Steel Carbide	✓	0	10	20	30	40	50	D051
	CSKPR/L Through boring Insert : SP□□ (without hole)	✓	Steel	✓	0	10	20	30	40	50	D046

Grade
Insert
Ext. Toolholder
Int. Toolholder
Threading
Grooving
Miniature Tool
Milling Cutter
Endmill
Drilling Tool
Tooling System
Index



Internal Toolholder - Quick Guide

Positive double side

Metric

MINIFURN

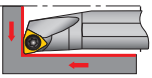
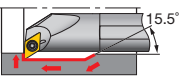
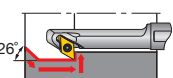
Style	Designation & Application	Material	Insert, Toolholder	Min. bore diameter DMIN (mm)						Page
				0	10	20	30	40	50	
	SWLXR/L Boring & internal facing Insert : WXGU	Steel Carbide	✓	0	10	20	30	40	50	D034
	SDXXR/L Boring & internal profiling Insert : DXGU	Steel Carbide	✓	0	10	20	30	40	50	D042
	SDZXR/L Back boring Insert : DXGU	Steel Carbide	✓	0	10	20	30	40	50	D093

Negative type

Inch

Lever lock

ISO Insert
ISO FURN

STREAMJETBAR

TUNGJET

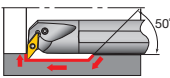
Style	Designation & Application	ISO Insert		Material	STREAMJETBAR		TUNGJET		Min. bore diameter DMIN (in)						Page	
		Insert	Toolholder		0	0.375	0.750	1.125	1.500	2.000						
	PVUNR/L Boring & internal profiling Insert : V/YN□□	✓	✓	Steel	✓											D080 D081

Negative type

Inch

Double clamp

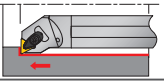
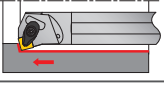
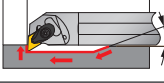
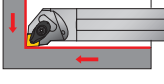
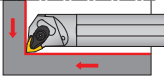
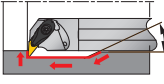
Style	Designation & Application	ISO Insert		Material	STREAMJETBAR TURNING A		Min. bore diameter DMIN (in)					Page	
		Insert			Toolholder		0.750	1.125	1.500	2.000	2.500		3.000
	ATFNR/L Boring Insert : TN□□	✓		Steel	✓		ø1.250"		ø1.560"				D055
	ASKNR/L Boring Insert : SN□□	✓		Steel	✓		ø1.250"		ø1.500"				D048
	ADUNR/L Boring & internal profiling Insert : DN□□	✓	✓	Steel	✓		ø1.250"		ø2.000"				D062 D065
	ACLNR/L Boring & internal facing Insert : CN□□, GN□□	✓	✓	Steel	✓		ø1.250"		ø2.500"				D028 D031
	AWLNR/L Boring & internal facing Insert : WN□□	✓	✓	Steel	✓		ø1.250"		ø2.500"				D036 D039
	AVUNR/L Boring & internal profiling Insert : VN□□	✓		Steel	✓		ø1.560"		ø2.000"				D082

Screw-on

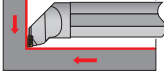
Style	Designation & Application	Material	TURNTEC		Min. bore diameter DMIN (in)					Page		
			Insert, Toolholder		0.750	1.125	1.500	2.000	2.500		3.000	
	S-TLANR/L Boring & internal facing Insert : LNMX□□	Steel	✓					ø2.090"		ø3.350"		D100

Grade
Insert
Ext. Toolholder
Int. Toolholder
Threading
Grooving
Miniature Tool
Milling Cutter
Endmill
Drilling Tool
Tooling System
User's Guide
Index



Internal Toolholder - Quick Guide

Negative type

Metric

Lever lock

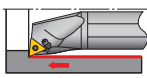
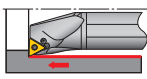
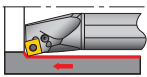
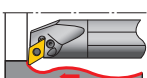
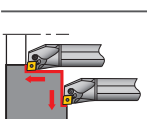
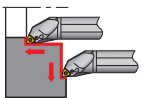
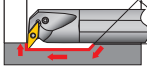
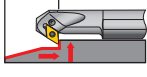
Style	Designation & Application	ISO Insert		Material	Toolholder		Min. bore diameter DMIN (mm)					Page		
		ISO Insert	ISO ETURN		STREAMJETBAR	TUNGJET	20	30	40	50	60		70	
	PTUNR/L Boring Insert : TN□□	✓	✓	Steel Reinforced	✓		ø20		ø40					D069 - D071
	PTFNR/L Boring Insert : TN□□	✓	✓	Steel	✓		ø32						ø63	D052 - D054
	PSKNR/L Through boring Insert : SN□□	✓		Steel	✓				ø40				ø63	D047
	PDUNR/L Boring & internal profiling Insert : DN□□	✓	✓	Steel Reinforced	✓	✓	ø25						ø63	D062 - D064
	PCLNR/L Boring & internal facing Insert : CN□□	✓	✓	Steel Reinforced	✓	✓	ø20						ø63	D028 - D030
	PWLNR/L Boring & internal facing Insert : WN□□	✓	✓	Steel	✓		ø20						ø50	D035 D037 D038
	PVUNR/L Boring & internal profiling Insert : V/YN□□	✓	✓	Steel	✓				ø37				ø50	D080 D081
	PDZNR/L Back boring Insert : DN□□	✓		Steel	✓				ø40				ø63	D095

Negative type

Metric

Screw-on

TURANTEC

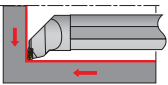
Style	Designation & Application	Material	Insert, Toolholder	Min. bore diameter DMIN (mm)						Page
				40	50	60	70	80	90	
	S-TLANR/L Boring & internal facing Insert : LNMX□□	Steel	✓	ø53	[Orange bar]			ø85	D100	

Grade

Insert

Ext. Toolholder

Int. Toolholder

Threading

Grooving

Miniature Tool

Milling Cutter

Endmill

Drilling Tool

Tooling System

User's Guide

Index

A
B
C
D
E
F
G
H
I
J
K
L
M



Unique anti-vibration mechanism in the tool body reduces vibration during deep hole boring with long overhangs of up to **L/D = 10**

Vibration Dampening Mechanism

When cutting forces create vibration on boring bar set ups with long overhangs, the bar's dampening mechanism counters the tool's motion and cancels the vibration.

The dampening mechanism consists of a weight supported by spring elements. The vibrations die out quickly eliminating noise and chatter marks.

- Concept image of dampening

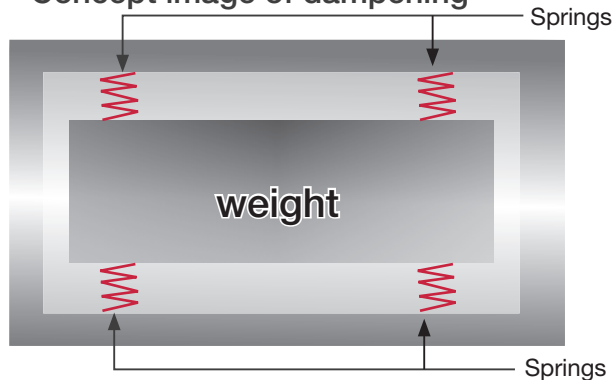

- Tool vibrations with and without vibration damper

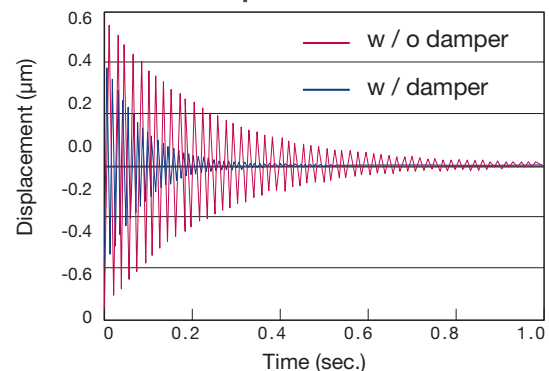

Standard Lineup

BoreMeister is comprised of the anti-vibration bar and interchangeable boring head, featuring serrated interfaces for high precision indexing. They are connected by screws, allowing the fitting of a wide range of cutting heads for great flexibility.

- Minimum bore diameter : $\varnothing 0.787''$

Anti-vibration bar

Boring head

Serration

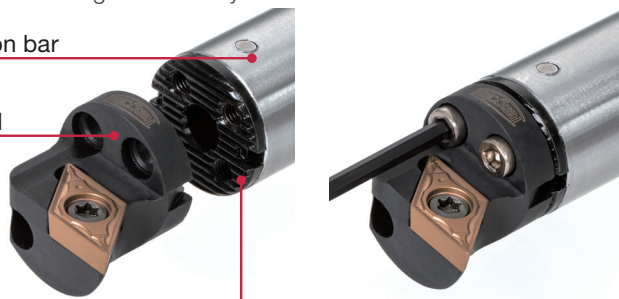

Reference pages: **D020 - D021, D032 - D033, D056 - D057, D060 - D061, D074 - D075, D078 - D079**

STREAMJETBAR



Engineered for tool strength and optimal chip evacuation

■ Tool body of special alloy steel, designed to reduce chatter!



Chatter

Competitor



Excellent surface quality with no chatter

STREAMJETBAR

■ Minimum bore diameter from $\varnothing 0.177"$ ($\varnothing 4.5$ mm)

■ Steel and carbide shank available

■ New pocket design for excellent chip evacuation

Cutting performance

The excellent chip evacuation minimizes tool failure caused by recutting chips and poor chip control. Damage to the work surface from chips is also eliminated.

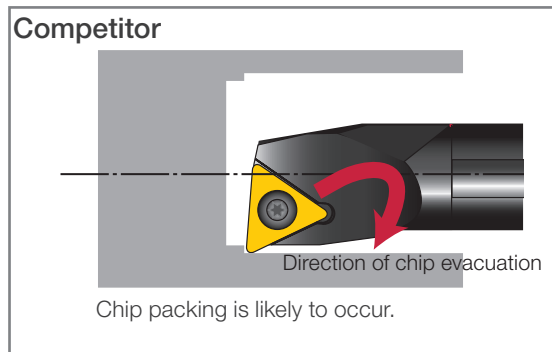
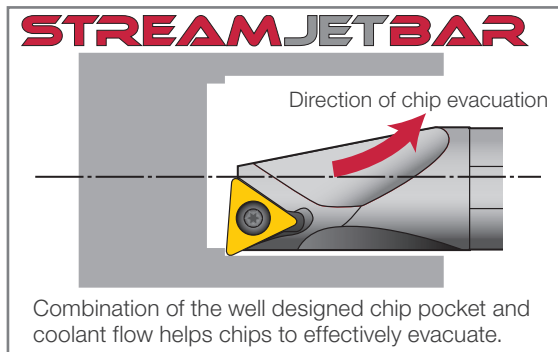

Reference pages: **D022 - D023, D025 - D026, D029, D037, D040, D043 - D045, D047, D049 - D050, D053, D058 - D059, D063, D066 - D067, D070, D072, D076, D081, D083, D085, D087 - D088, D090, D094 - D095, D097 - D099, D102**

Screw-on exchangeable boring head, for positive 80° rhombic inserts

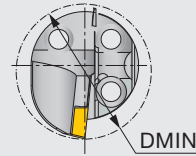
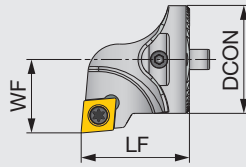
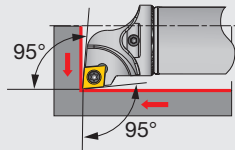

Cutting edge style L

Right hand (R) shown.

Inch	DMIN	DCON	WF	LF	Shank size	Insert
S16-SCLCR/L06-H	0.787	0.630	0.433	0.787	D/G.625	CC**0602...
S20-SCLCR/L09-H	0.984	0.787	0.512	0.787	D/G.750	CC**09T3...
S25-SCLCR/L09-H	1.260	0.984	0.669	0.787	D1.00	CC**09T3...
S32-SCLCR/L09-H	1.575	1.260	0.866	1.260	D1.25	CC**09T3...
S40-SCLCR/L12T-H	1.968	1.575	1.063	1.496	D1.50, D2.00, D2.50	CC**1204...

When using a right or left hand insert, the right hand insert (R) is used for the left hand toolholders (SCLCL** type), and the left hand insert (L) is used for the right hand toolholders (SCLCR** type).

SPARE PARTS



Designation	Clamping screw	Wrench	Shim	Shim screw
S16-SCLCR/L06-H	SR14-548	T-7/5	-	-
S20-SCLCR/L09-H	SR16-236	T-15/5	-	-
S25-SCLCR/L09-H	SR16-236	T-15/5	-	-
S32-SCLCR/L09-H	SR16-236	T-15/5	-	-
S40-SCLCR/L12T-H	SR16-212	T-20/5	TCC4-2	SRTC-4

INSERT SELECTION

Application	Precision finishing	Finishing	Finishing to medium cutting	Medium cutting
Grade	NS9530	NS9530	T9215	T9215
Breaker Shape	01	PSS	PS	PM

Cutting conditions B020

Application	Finishing to medium cutting
Grade	T515
Breaker Shape	CM

Cutting conditions B024

Application	Finishing	Finishing to medium cutting
Grade	AH8015	AH8015
Breaker Shape	PSS	PS

Cutting conditions B028

Application	Precision finishing	Finishing	Finishing to medium cutting	Medium cutting
Grade	GH330	AH725	AH630	T6130
Breaker Shape	W**	PSF	PSS	PM

Cutting conditions B022

Application	Precision finishing	Finishing	Medium cutting
Grade	DX120	DX140	KS05F
Breaker Shape	T-DIA	with rake T-DIA	AL

Cutting conditions B026

Application	Precision finishing	Finishing
Grade	BXM10	BXM20
Breaker Shape	T-CBN	T-CBN

Cutting conditions B030

Reference pages: S-SCLCR/L-H: Insert → B111 -, CBN → B182, PCD → B196 -

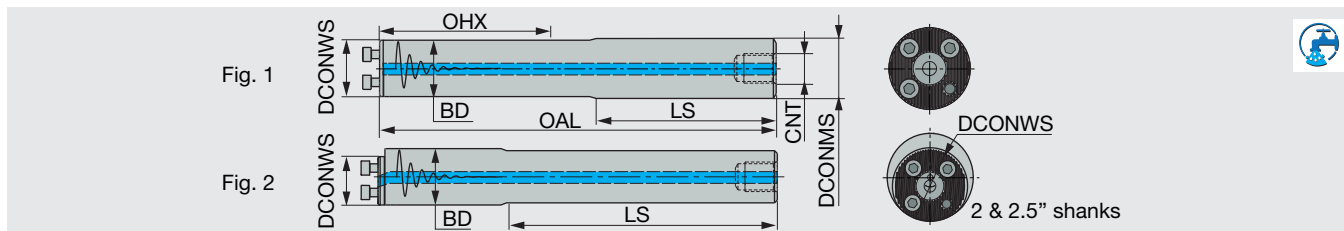

Inch	Material	DCONWS	DCONMS	BD	OAL	LS	OHX	CNT	Fig.
D.625-L6.14-7D-C	Steel	0.630	0.625	0.630	6.140	3.600	3.500	G1/8	1
G.625-L8.03-10D-E	Carbide	0.630	0.625	0.630	8.030	5.220	5.500	-	1
D.750-L7.87-7D-C	Steel	0.787	0.750	0.787	7.870	4.940	4.400	G1/4	1
G.750-L10.24-10D-E	Carbide	0.787	0.750	0.787	10.240	6.770	7.000	-	1
D1.00-L10.2-7D-C	Steel	0.984	1.000	0.984	10.200	6.830	6.200	G1/4	1
D1.00-L13.21-10D-C	Steel	0.984	1.000	0.984	13.210	8.650	9.200	G1/4	1
D1.25-L12.48-7D-C	Steel	1.260	1.250	1.260	12.480	7.370	7.500	G3/8	1
D1.25-L16.24-10D-C	Steel	1.260	1.250	1.260	16.240	9.670	11.200	G3/8	1
D1.50-L15.26-7D-C	Steel	1.575	1.500	1.575	15.260	9.130	9.200	G1/2	1
D1.50-L19.8-10D-C	Steel	1.575	1.500	1.575	19.800	13.350	13.700	G1/2	1
D2.00-L20.74-7D-C	Steel	1.575	2.000	2.000	20.740	-	12.700	G1/2	2
D2.00-L26.73-10D-C	Steel	1.575	2.000	2.000	26.730	-	18.700	G1/2	2
D2.50-L26.2-7D-C	Steel	1.575	2.500	2.500	26.200	-	16.200	G3/4	2
D2.50-L33.72-10D-C	Steel	1.575	2.500	2.500	33.720	-	23.700	G3/4	2

SPARE PARTS



Designation	Clamping screw	Wrench
D.625..., G.625...	SRM3X10DIN912	HW2.5
D.750..., G.750...	SRM3.5X10DIN912	HW2.5
D1.00...	SRM4X12DIN912	HW3.0
D1.25...	SRM5X12DIN912	HW4.0
D1.50..., D2.00... D2.50...	SRM6X16DIN912-12.9	HW5.0



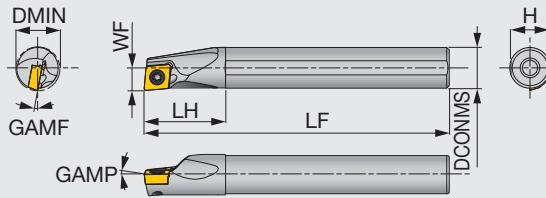
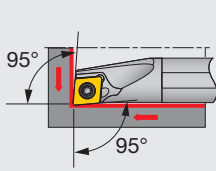

Right hand (R) shown.

Cutting edge style L

Inch	Material	DMIN	DCONMS	WF	LF	LH	H	GAMP	GAMF	RE**	Insert	Torque
A06-SCLCR/L2-D08	Steel	0.500	0.375	0.281	5.000	0.750	0.350	0°	-9°	0.016	CC**21.5...	0.89
A08-SCLCR/L2-D11	Steel	0.687	0.500	0.406	5.000	1.000	0.475	0°	-6°	0.016	CC**21.5...	0.89
A10-SCLCR/L3-D14	Steel	0.875	0.625	0.531	7.000	1.250	0.600	0°	-7°	0.016	CC**32.5...	2.2
A12-SCLCR/L3-D16	Steel	1.000	0.750	0.594	7.000	1.438	0.725	0°	-5°	0.031	CC**32.5...	2.2
A16-SCLCR/L3-D20	Steel	1.250	1.000	0.687	7.000	1.750	0.975	0°	-4°	0.031	CC**32.5...	2.2
E06-SCLCR/L2-D08	Carbide	0.500	0.375	0.281	5.000	0.750	0.350	0°	-9°	0.016	CC**21.5...	0.89
E08-SCLCR/L2-D11	Carbide	0.688	0.500	0.406	5.000	1.000	0.475	0°	-6°	0.016	CC**21.5...	0.89
E10-SCLCR/L2-D14	Carbide	0.875	0.625	0.531	7.000	1.250	0.600	0°	-7°	0.016	CC**21.5...	0.89
E10-SCLCR/L3-D14	Carbide	0.875	0.625	0.531	7.000	1.250	0.600	0°	-7°	0.016	CC**32.5...	2.2
E12-SCLCR/L3-D16	Carbide	1.000	0.750	0.594	7.000	1.438	0.725	0°	-5°	0.031	CC**32.5...	2.2
E16-SCLCR/L3-D20	Carbide	1.250	1.000	0.687	10.000	1.750	0.975	0°	-4°	0.031	CC**32.5...	2.2

Torque: Recommended clamping torque: lbs-ft

**RE: Standard corner radius

Use right-hand toolholders (SCLCR**) with left-hand inserts (L); and left-hand toolholders (SCLCL**) with right-hand inserts (R).

SPARE PARTS



Designation	Clamping screw	Wrench
A**-SCLCR/L2-D...	CSTB-2.5S	T-8F
A**-SCLCR/L3-D...	CSTB-4S	T-15F
E06-SCLCR/L2-D08	CSTB-2.5S	T-8F
E**-SCLCR/L2-D...	CSTB-2.5B	T-8F
E**-SCLCR/L3-D...	CSTB-4S	T-15F

INSERT SELECTION

P	Application	Precision finishing	Finishing	Finishing to medium cutting	Medium cutting
	Grade	NS9530	NS9530	T9215	T9215
Breaker Shape	01	PSS	PS	PM	
Cutting conditions					B020

K	Application	Finishing to medium cutting
	Grade	T515
Breaker Shape	CM	
Cutting conditions		B024

S	Application	Finishing	Finishing to medium cutting	
	Grade	AH8015	AH8015	
Breaker Shape	PSS	PS		
Cutting conditions				B028

M	Application	Precision finishing	Finishing	Finishing to medium cutting	Medium cutting
	Grade	GH330	AH725	AH630	T6130
Breaker Shape	W**	PSF	PSS	PM	
Cutting conditions					B022

N	Application	Precision finishing	Finishing	Medium cutting
	Grade	DX120	DX140	KS05F
Breaker Shape	T-DIA	with rake T-DIA	AL	
Cutting conditions				B026

H	Application	Precision finishing	Finishing	
	Grade	BXM10	BXM20	
Breaker Shape	T-CBN	T-CBN		
Cutting conditions				B030

Reference pages: A/E-SCLCR/L: Insert → B111 -, CBN → B182, PCD → B196 -

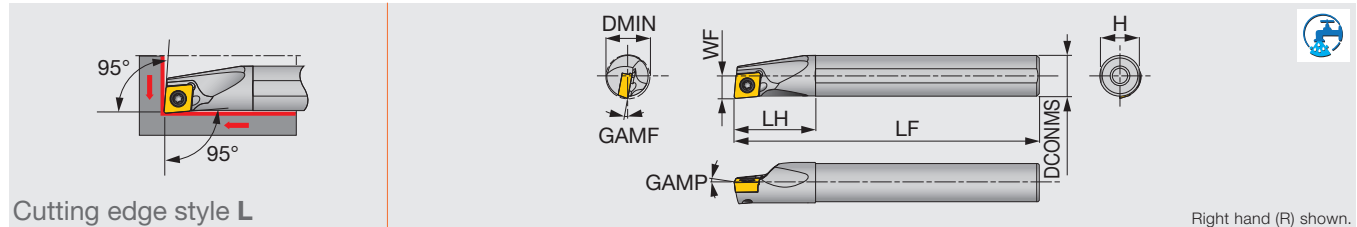

Cutting edge style L

Right hand (R) shown.

Metric	Material	DMIN	DCONMS	WF	LF	LH	H	GAMP	GAMF	RE**	Insert	Torque
A04F-SCLCR/L03-D050	Steel	5	4	2.5	80	8	3.8	0°	-15°	0.2	CC**03X1...	0.6
A05F-SCLCR/L03-D060	Steel	6	5	3	80	9	4.8	0°	-13°	0.2	CC**03X1...	0.6
A06G-SCLCR/L04-D070	Steel	7	6	3.5	90	11	5.75	0°	-13°	0.2	CC**04T1...	0.6
A07G-SCLCR/L04-D080	Steel	8	7	4	90	12	6.75	0°	-11°	0.2	CC**04T1...	0.6
A08H-SCLCR/L06-D100	Steel	10	8	5.5	100	16	7.5	0°	-13°	0.4	CC**0602...	1.2
A10F-SCLCR06-D120	Steel	12	10	6	80	20	9	0°	-10°	0.4	CC**0602...	1.2
A10K-SCLCR/L06-D120	Steel	12	10	6	125	20	9	0°	-10°	0.4	CC**0602...	1.2
A12H-SCLCR06-D140	Steel	14	12	7	100	24	11	0°	-8°	0.4	CC**0602...	1.2
A12M-SCLCR/L06-D140	Steel	14	12	7	150	24	11	0°	-8°	0.4	CC**0602...	1.2
A12H-SCLCR06-D160	Steel	16	12	9	100	24	11	0°	-7°	0.4	CC**0602...	1.2
A12M-SCLCR/L06-D160	Steel	16	12	9	150	24	11	0°	-7°	0.4	CC**0602...	1.2
A16K-SCLCR09-D180	Steel	18	16	9	125	32	15	0°	-9°	0.8	CC**09T3...	3
A16Q-SCLCR/L09-D180	Steel	18	16	9	180	32	15	0°	-10°	0.8	CC**09T3...	3
A16K-SCLCR09-D200	Steel	20	16	11	125	32	15	0°	-9°	0.8	CC**09T3...	3
A16Q-SCLCR/L09-D200	Steel	20	16	11	180	32	15	0°	-9°	0.8	CC**09T3...	3
A20R-SCLCR/L09-D220	Steel	22	20	11	200	32	18	0°	-8°	0.8	CC**09T3...	3
A25S-SCLCR/L09-D270	Steel	27	25	13.5	250	45	23	0°	-6°	0.8	CC**09T3...	3
E04G-SCLCR/L03-D050	Carbide	5	4	2.5	90	9	3.8	0°	-15°	0.2	CC**03X1...	0.6
E05G-SCLCR/L03-D060	Carbide	6	5	3	90	10	4.8	0°	-13°	0.2	CC**03X1...	0.6
E06H-SCLCR/L04-D070	Carbide	7	6	3.5	100	12	5.75	0°	-13°	0.2	CC**04T1...	0.6
E07H-SCLCR/L04-D080	Carbide	8	7	4	100	14	6.75	0°	-11°	0.2	CC**04T1...	0.6
E08G-SCLCR06-D100	Carbide	10	8	5.5	90	22	7.5	0°	-13°	0.4	CC**0602...	1.2
E08K-SCLCR/L06-D100	Carbide	10	8	5.5	125	22	7.5	0°	-13°	0.4	CC**0602...	1.2
E10F-SCLCR06-D120	Carbide	12	10	6	80	25	9	0°	-10°	0.4	CC**0602...	1.2
E10H-SCLCR06-D120	Carbide	12	10	6	100	25	9	0°	-10°	0.4	CC**0602...	1.2
E10M-SCLCR/L06-D120	Carbide	12	10	6	150	25	9	0°	-10°	0.4	CC**0602...	1.2
E12G-SCLCR06-D140	Carbide	14	12	7	90	27	11	0°	-8°	0.4	CC**0602...	1.2
E12J-SCLCR06-D140	Carbide	14	12	7	110	27	11	0°	-8°	0.4	CC**0602...	1.2
E12Q-SCLCR/L06-D140	Carbide	14	12	7	180	27	11	0°	-8°	0.4	CC**0602...	1.2
E12G-SCLCR06-D160	Carbide	16	12	9	90	27	11	0°	-7°	0.4	CC**0602...	1.2
E12J-SCLCR06-D160	Carbide	16	12	9	110	27	11	0°	-7°	0.4	CC**0602...	1.2
E12Q-SCLCR/L06-D160	Carbide	16	12	9	180	27	11	0°	-7°	0.4	CC**0602...	1.2
E16H-SCLCR09-D180	Carbide	18	16	9	100	32	15	0°	-10°	0.8	CC**09T3...	3
E16L-SCLCR09-D180	Carbide	18	16	9	130	32	15	0°	-10°	0.8	CC**09T3...	3
E16R-SCLCR/L09-D180	Carbide	18	16	9	200	32	15	0°	-10°	0.8	CC**09T3...	3
E16H-SCLCR09-D200	Carbide	20	16	11	100	32	15	0°	-9°	0.8	CC**09T3...	3
E16L-SCLCR09-D200	Carbide	20	16	11	130	32	15	0°	-9°	0.8	CC**09T3...	3
E16R-SCLCR/L09-D200	Carbide	20	16	11	200	32	15	0°	-9°	0.8	CC**09T3...	3
E20S-SCLCR09-D220	Carbide	22	20	11	250	36	18	0°	-8°	0.8	CC**09T3...	3
E25T-SCLCR09-D270	Carbide	27	25	13.5	300	45	23	0°	-6°	0.8	CC**09T3...	3

Torque: Recommended clamping torque: N·m

**RE: Standard corner radius

Use right-hand toolholders (SCLCR**) with left-hand inserts (L); and left-hand toolholders (SCLCL**) with right-hand inserts (R).

SPARE PARTS



Designation	Clamping screw	Wrench
A/E**-SCLCR/L03-D...	CSTA-1.6	T-6F
A/E**-SCLCR/L04-D...	CSTB-2	T-6F
A/E**-SCLCR/L06-D...	CSTB-2.5S	T-8F
E16*-SCLCR/L09-D...	CSTB-4L060	T-15F
A/E2**-SCLCR/L09-D...	CSTB-4S	T-15F



T-SCLCR/L

Screw-on boring bar, for positive 80° rhombic inserts (Tsuppari-Ichiban)

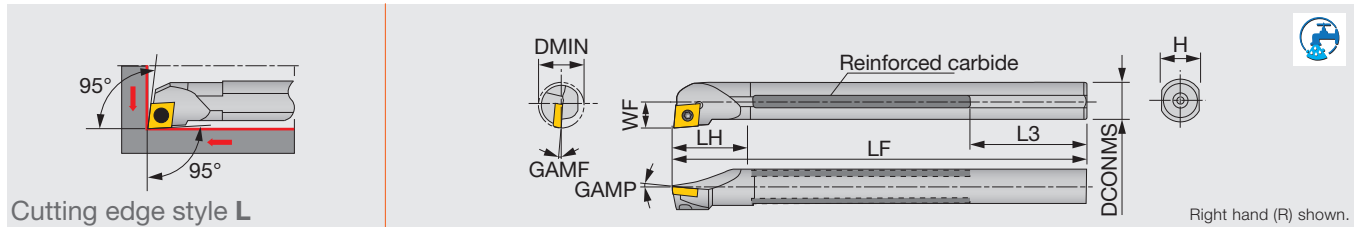

Metric	Material	DMIN	CNT	DCONMS	WF	LF	LH	L3	H	GAMF	GAMP	RE**	Insert	Torque
T12M-SCLCR/L06	Reinforced	16	-	12	9	150	22	59	11	-10°	0°	0.4	CC**0602...	1.2
T16Q-SCLCR/L09	Reinforced	20	-	16	11	180	27	59	15	-10°	0°	0.8	CC**09T3...	3
T20R-SCLCR/L09C	Reinforced	25	Rc1/4	20	13	200	35	49	18	-8°	0°	0.8	CC**09T3...	3
T25S-SCLCR/L09C	Reinforced	32	Rc1/4	25	17	250	40	64	23	-6°	0°	0.8	CC**09T3...	3

Torque: Recommended clamping torque: N·m

**RE: Standard corner radius

The hole specification of applicable inserts conforms to ISO standard.

Use right-hand toolholders (SCLCR**) with left-hand inserts (L); and left-hand toolholders (SCLCL**) with right-hand inserts (R).

SPARE PARTS

Designation	Clamping screw	Wrench
T12M-SCLCR/L06	CSTB-2.5	T-8F
T16Q-SCLCR/L09	CSTB-4S	T-15F
T20R-SCLCR/L09C	CSTB-4S	T-15F
T25S-SCLCR/L09C	CSTB-4S	T-15F

INSERT SELECTION

P	Application	Precision finishing	Finishing	Finishing to medium cutting	Medium cutting
	Grade	SH725	SH725	T9215	T9215
	Breaker Shape	01	JS	PS	PM
	Cutting conditions	B020			
K	Application	Finishing to medium cutting			
	Grade	T515			
	Breaker Shape	CM			
	Cutting conditions	B024			
S	Application	Precision finishing	Finishing to medium cutting		
	Grade	BX470	AH8005		
	Breaker Shape	T-CBN	PS		
	Cutting conditions	B028			
M	Application	Precision finishing	Finishing	Finishing to medium cutting	Medium cutting
	Grade	SH725	SH725	T9215	T9215
	Breaker Shape	01	JS	PS	PM
	Cutting conditions	B022			
N	Application	Precision finishing	Finishing	Medium cutting	
	Grade	DX120	TH10	KS05F	
	Breaker Shape	T-DIA with rake W20	AL		
	Cutting conditions	B026			
H	Application	Precision finishing	Finishing		
	Grade	BXM10	BXM20		
	Breaker Shape	T-CBN	T-CBN		
	Cutting conditions	B030			

Reference pages: T-SCLCR/L: Insert → B111 -, CBN → B182, PCD → B196 -

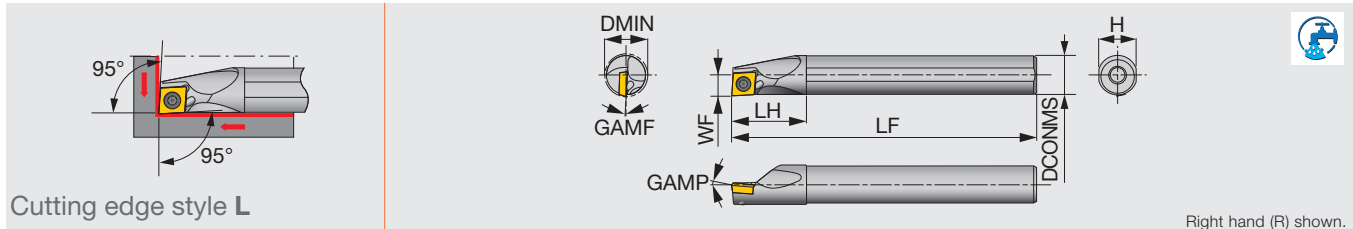

Cutting edge style L

Right hand (R) shown.

Inch	Material	DMIN	DCONMS	WF	LF	LH	H	GAMP	GAMF	RE**	Insert	Torque
A06-SCLPR/L2-D08	Steel	0.500	0.375	0.281	5.000	0.750	0.350	5°	-5°	0.016	CP**21.5...	0.89
A08-SCLPR/L2-D11	Steel	0.687	0.500	0.406	5.000	1.000	0.475	5°	-2°	0.016	CP**21.5...	0.89
A10-SCLPR/L3-D14	Steel	0.875	0.625	0.531	7.000	1.250	0.600	5°	-2°	0.016	CP**32.5...	2.21
E06-SCLPR/L2-D08	Carbide	0.500	0.375	0.281	5.000	0.750	0.350	0°	-9°	0.016	CP**21.5...	0.89
E08-SCLPR/L2-D11	Carbide	0.688	0.500	0.406	5.000	1.000	0.475	0°	-6°	0.016	CP**21.5...	0.89
E10-SCLPR/L3-D14	Carbide	0.875	0.625	0.531	7.000	1.250	0.600	0°	-7°	0.032	CP**32.5...	2.21

Torque: Recommended clamping torque: lbs-ft

**RE: Standard corner radius

When using a right or left hand insert, the right hand insert (R) is used for the left hand toolholders (SCLPL** type), and the left hand insert (L) is used for the right hand toolholders (SCLPR** type).

SPARE PARTS



Designation	Clamping screw	Wrench
A06-SCLPR/L2-D08	CSTB-2.5L042	T-8F
A08-SCLPR/L2-D11	CSTB-2.5S	T-8F
A10-SCLPR/L3-D14	CSTB-4L070	T-15F
E06-SCLPR/L2-D08	CSTB-2.5S	T-8F
E08-SCLPR/L2-D11	CSTB-2.5B	T-8F
E10-SCLPR/L3-D14	CSTB-4S	T-15F

INSERT SELECTION

Application	Finishing to medium cutting		Medium cutting
	Grade	Grade	
Grade	T9215	T9215	T9215
Breaker Shape	PS	PM	PM
Cutting conditions	B020		

Application	Finishing to medium cutting		Medium cutting
	Grade	Grade	
Grade	T9215	T9215	T9215
Breaker Shape	PS	PM	PM
Cutting conditions	B022		

Application	Finishing to medium cutting	
	Grade	Grade
Grade	T515	T515
Breaker Shape	CM	CM
Cutting conditions	B024	

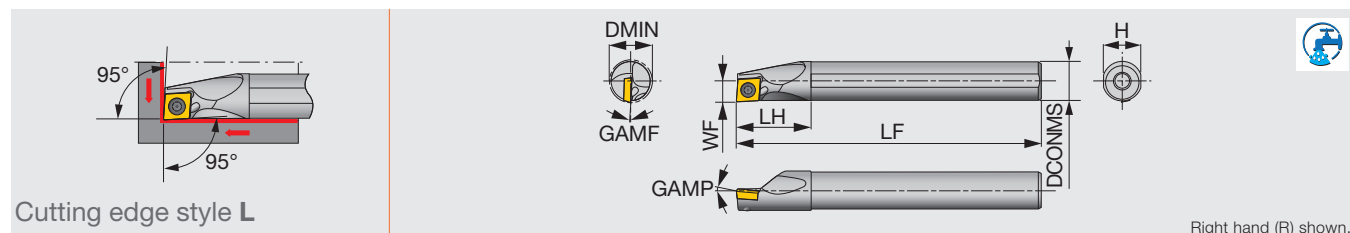

Right hand (R) shown.

Metric	Material	DMIN	DCONMS	WF	LF	LH	H	GAMP	GAMF	RE**	Insert	Torque
A08H-SCLPR/L06-D100	Steel	10	8	5.5	100	16	7.5	5°	-8°	0.4	CP**0602...	1.2
A10K-SCLPR/L06-D120	Steel	12	10	6	125	20	9	5°	-5°	0.4	CP**0602...	1.2
A10K-SCLPR/L08-D120	Steel	12	10	6	125	20	9	5°	-5°	0.4	CP**0802...	1.4
A12M-SCLPR/L06-D140	Steel	14	12	7	150	24	11	5°	-4°	0.4	CP**0602...	1.2
A12M-SCLPR/L08-D140	Steel	14	12	7	150	24	11	5°	-4°	0.4	CP**0802...	1.4
A12M-SCLPR/L08-D160	Steel	16	12	9	150	24	11	5°	-3°	0.4	CP**0802...	1.4
A16Q-SCLPR/L09-D180	Steel	18	16	9	180	32	15	5°	-3.5°	0.8	CP**0903...	3
A16Q-SCLPR/L09-D200	Steel	20	16	11	180	32	15	5°	-3°	0.8	CP**0903...	3
A20R-SCLPR/L09-D220	Steel	22	20	11	200	36	18	5°	-2°	0.8	CP**0903...	3
A25S-SCLPR/L09-D270	Steel	27	25	13.5	250	45	23	5°	-1°	0.8	CP**0903...	3
E08K-SCLPR/L06-D100	Carbide	10	8	5.5	125	22	7.5	5°	-8°	0.4	CP**0602...	1.2
E10M-SCLPR/L06-D120	Carbide	12	10	6	150	25	9	5°	-5°	0.4	CP**0602...	1.2
E10H-SCLPR08-D120	Carbide	12	10	6	100	25	9	5°	-5°	0.4	CP**0802...	1.4
E10M-SCLPR/L08-D120	Carbide	12	10	6	150	25	9	5°	-5°	0.4	CP**0802...	1.4
E12Q-SCLPR/L06-D140	Carbide	14	12	7	180	27	11	5°	-4°	0.4	CP**0602...	1.2
E12G-SCLPR08-D140	Carbide	14	12	7	90	27	11	5°	-4°	0.4	CP**0802...	1.4
E12J-SCLPR08-D140	Carbide	14	12	7	110	27	11	5°	-4°	0.4	CP**0802...	1.4
E12Q-SCLPR/L08-D140	Carbide	14	12	7	180	27	11	5°	-4°	0.4	CP**0802...	1.4
E12G-SCLPR08-D160	Carbide	16	12	9	90	27	11	5°	-3°	0.4	CP**0802...	1.4
E12J-SCLPR08-D160	Carbide	16	12	9	110	27	11	5°	-3°	0.4	CP**0802...	1.4
E12Q-SCLPR/L08-D160	Carbide	16	12	9	180	27	11	5°	-3°	0.4	CP**0802...	1.4
E16H-SCLPR09-D180	Carbide	18	16	9	100	32	15	5°	-3.5°	0.8	CP**0903...	3
E16L-SCLPR09-D180	Carbide	18	16	9	130	32	15	5°	-3.5°	0.8	CP**0903...	3
E16R-SCLPL09-D180	Carbide	18	16	9	200	32	15	5°	-3.5°	0.8	CP**0903...	3
E16H-SCLPR09-D200	Carbide	20	16	11	100	32	15	5°	-3°	0.8	CP**0903...	3
E16L-SCLPR09-D200	Carbide	20	16	11	130	32	15	5°	-3°	0.8	CP**0903...	3
E16R-SCLPL09-D200	Carbide	20	16	11	200	32	15	5°	-3°	0.8	CP**0903...	3

Torque: Recommended clamping torque: N·m

**RE: Standard corner radius

Use right-hand toolholders (SCLPR**) with left-hand inserts (L); and left-hand toolholders (SCLPL**) with right-hand inserts (R).

SPARE PARTS



Designation	Clamping screw	Wrench
A**-SCLPR/L06-D...	CSTB-2.5S	T-8F
A10K-SCLPR/L08-D120	CSTB-3L042	T-9F
A12M-SCLPR/L08-D...	CSTB-3L050	T-9F
A**-SCLPR/L09-D...	CSTB-4L060	T-15F
E**-SCLPR/L06-D...	CSTB-2.5S	T-8F
E10*-SCLPR/L08-D...	CSTB-3L042	T-9F
E12*-SCLPR/L08-D...	CSTB-3L050	T-9F
E16*-SCLPR/L09-D...	CSTB-4L060	T-15F

T-SCLPR/L

Screw-on boring bar, for positive 80° rhombic inserts (Tsuppari-Ichiban)

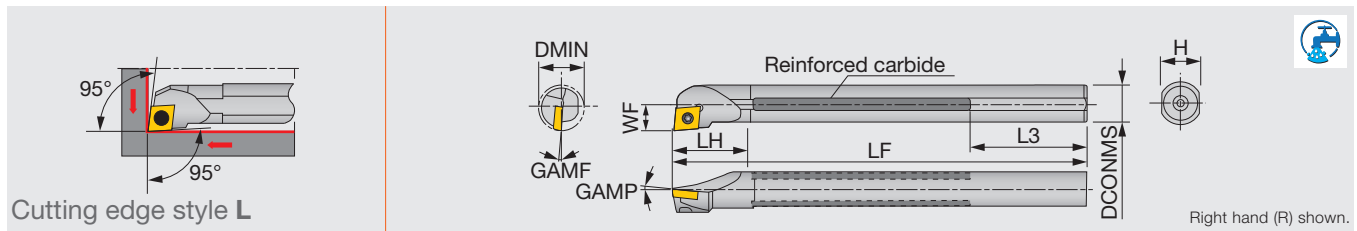

Metric	Material	DMIN	CNT	DCONMS	WF	LF	LH	L3	H	GAMF	GAMP	RE**	Insert	Torque
T12M-SCLPR08-D14	Reinforced	14	-	12	7	150	22	59	11	-4°	5°	0.4	CP**0802...	1.4
T12M-SCLPR/L08	Reinforced	16	-	12	9	150	25	59	11	-3°	5°	0.4	CP**0802...	1.4
T16Q-SCLPR09-D18	Reinforced	18	-	16	9	180	27	59	15	-3.5°	5°	0.8	CP**0903...	3
T16Q-SCLPR/L09	Reinforced	20	-	16	11	180	30	59	15	-4°	5°	0.8	CP**0903...	3
T20R-SCLPR09C-D22	Reinforced	22	Rc1/4	20	11	200	35	49	18	-2°	5°	0.8	CP**0903...	3
T20R-SCLPR/L09	Reinforced	25	-	20	13	200	35	49	18	-2°	5°	0.8	CP**0903...	3
T25S-SCLPR09C-D27	Reinforced	27	Rc1/4	25	13.5	250	40	64	23	-1°	5°	0.8	CP**0903...	3
T25S-SCLPR/L09	Reinforced	32	-	25	17	250	40	64	23	0°	5°	0.8	CP**0903...	3

Torque: Recommended clamping torque: N·m

**RE: Standard corner radius

Use right-hand toolholders (SCLPR**) with left-hand inserts (L); and left-hand toolholders (SCLPL**) with right-hand inserts (R).

SPARE PARTS



Designation	Clamping screw	Wrench
T12M-SCLPR/L08...	CSTB-3L050	T-9F
T16Q-SCLPR09-D18	CSTB-4L060	T-15F
T16Q-SCLPR/L09	CSTB-4S	T-15F
T20R-SCLPR09C-D22	CSTB-4L060	T-15F
T20R-SCLPR/L09	CSTB-4S	T-15F
T25S-SCLPR09C-D27	CSTB-4L060	T-15F
T25S-SCLPR/L09	CSTB-4S	T-15F

INSERT SELECTION

P	Application	Finishing	Finishing to medium cutting	Medium cutting	M	Application	Finishing	Finishing to medium cutting	Medium cutting
	Grade	NS9530	T9215	T9215		Grade	AH725	AH630	T6130
	Breaker Shape	PSS	PS	PM		Breaker Shape	PSF	PSS	PM
Cutting conditions					B020				
K	Application	Finishing to medium cutting			N	Application	Finishing		
	Grade	T515				Grade	DX140		
	Breaker Shape	CM				Breaker Shape	T-DIA		
Cutting conditions					B024				
S	Application	Finishing	Finishing to medium cutting						
	Grade	AH8015	AH8015						
	Breaker Shape	PSS	PS						
Cutting conditions					B028				

Reference pages: T-SCLPR/L: Insert → B118 -



Lever-lock boring bar, for negative 80° rhombic inserts

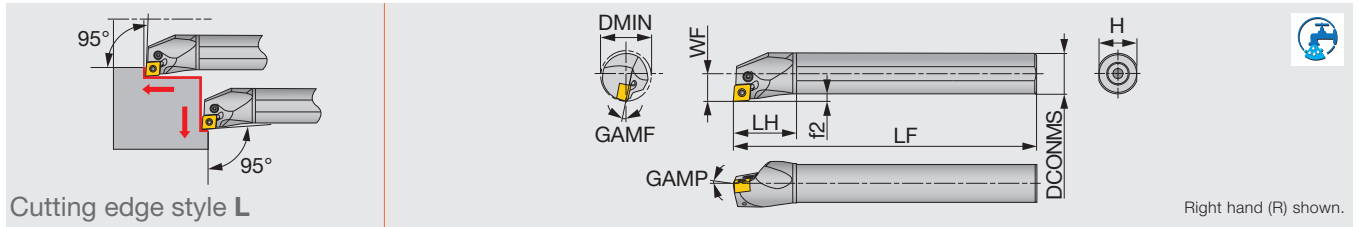

Right hand (R) shown.

Metric	Material	DMIN	DCONMS	WF	LF	LH	H	f2	GAMP	GAMF	RE**	Insert	Torque
A16M-PCLNR/L0904-D200	Steel	20	16	11	150	32	15	3	-6°	-16°	0.8	CN**0904...	1.7
A20Q-PCLNR/L0904-D250	Steel	25	20	13	180	36	18	3	-6°	-12°	0.8	CN**0904...	1.7

Torque: Recommended clamping torque: N·m
 **RE: Standard corner radius

SPARE PARTS

Designation	Clamping screw	Wrench	Lever	Oil supply attachment*	Screw for oil hole*
A16M-PCLNR/L0904-D200	LCS33	P-2F	LCL33N	-	SSHM3-4
A20Q-PCLNR/L0904-D250	LCS33	P-2F	LCL33N	EA-20	SSHM3-4

*Optional

Double-clamp boring bar, for negative 80° rhombic inserts

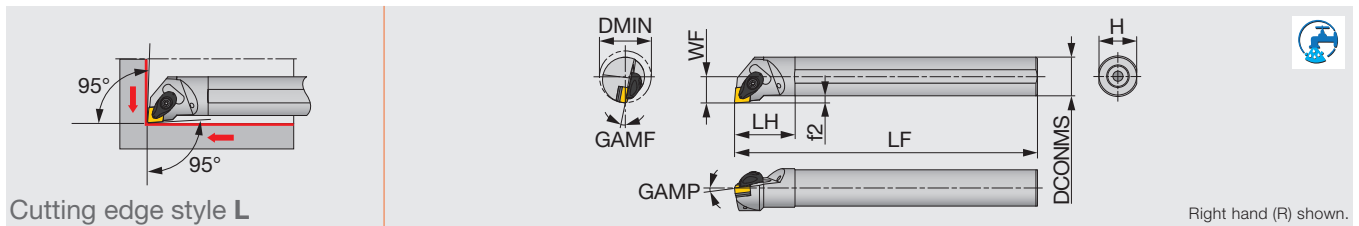

Right hand (R) shown.

Inch	Material	DMIN	DCONMS	WF	LF	LH	H	f2	GAMP	GAMF	RE**	Insert	Torque
A16-ACLNR/L33-D20	Steel	1.250	1.000	0.672	12.000	1.750	0.906	0.172	-6°	-13°	0.031	CN**33...	2.21
A20-ACLNR/L33-D25	Steel	1.560	1.250	0.859	14.000	1.938	1.188	0.234	-6°	-10°	0.031	CN**33...	2.21

Torque: Recommended clamping torque: lbs·ft
 **RE: The holder measurements are true with this insert radius

SPARE PARTS

Designation	Clamp	Clamp screw	Spring	Spring pin	Shim	Shim screw	Wrench
A**-ACLNR/L33...	ACP3S-E	ACS-5W	BP-7	SP-2.5	ASC322	CSTB-3.5	T-15F

INSERT SELECTION

P	Application	Finishing	Medium cutting
	Grade	T9215	T9215
Breaker Shape	TSF	TM	
Cutting conditions		B020	

M	Application	Finishing	Medium cutting
	Grade	T6120	T6130
Breaker Shape	SS	SM	
Cutting conditions		B022	

K	Application	Medium cutting
	Grade	T515
Breaker Shape	TM	
Cutting conditions		B024

S	Application	Medium cutting
	Grade	AH8015
Breaker Shape	TM	
Cutting conditions		B028

Reference pages: A-PCLNR/L-Eco, A-ACLNR/L-Eco: Insert → **B056** -

Lever-lock boring bar, for negative 80° rhombic inserts

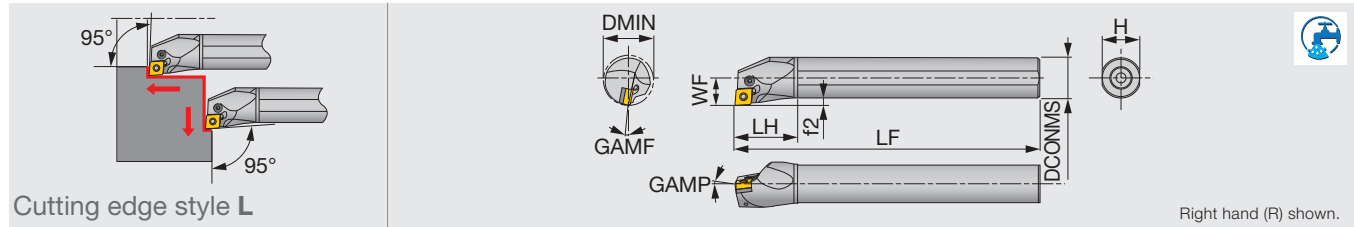

Metric	Material	DMIN	DCONMS	WF	LF	LH	H	f2	GAMP	GAMF	RE**	Insert	Torque
A16M-PCLNR/L09-D200	Steel	20	16	11	150	32	15	3	-6°	-14°	0.8	CN**0903...	1.7
A20Q-PCLNR/L09-D250	Steel	25	20	13	180	36	18	3	-6°	-12°	0.8	CN**0903...	1.7
A25R-PCLNR/L09-D320	Steel	32	25	17	200	45	23	4.5	-6°	-11°	0.8	CN**0903...	1.7
A25R-PCLNR/L12-D320	Steel	32	25	17	200	45	23	4.5	-6°	-13°	0.8	CN**1204...	2.7
A32S-PCLNR/L12-D400	Steel	40	32	22	250	50	30	6	-6°	-11°	0.8	CN**1204...	4.8
A40T-PCLNR/L12-D500	Steel	50	40	27	300	60	37	7	-6°	-10°	0.8	CN**1204...	4.8
A50U-PCLNR/L12-D630	Steel	63	50	35	350	65	47	10	-6°	-8°	0.8	CN**1204...	4.8

Torque: Recommended clamping torque: N·m

**RE: Standard corner radius

Use right-hand toolholders (PCLNR**) with left-hand inserts (L); and left-hand toolholders (PCLNL**) with right-hand inserts (R).

SPARE PARTS									
Designation	Shim	Clamping screw 1	Clamping screw 2	Wrench 1	Wrench 2	Spring pin	Lever	Oil supply attachment*	Screw for oil hole*
A**-PCLNR/L09-D**0	-	LCS22A	-	P-2F	-	-	LCL32N	EA-25	SSHM5-6
A25R-PCLNR/L12-D320	-	LCS43	-	-	P-2.5	-	LCL43N	EA-32	SSHM5-6
A32S-PCLNR/L12-D400	LSC42BR/L	-	LCS4	-	P-3	LSP4	LCL4	EA-32	SSHM5-6
A40T-PCLNR/L12-D500	LSC42BR/L	-	LCS4	-	P-3	LSP4	LCL4	-	SSHM6-6
A50U-PCLNR/L12-D630	LSC42BR/L	-	LCS4	-	P-3	LSP4	LCL4	-	SSHM6-6

*Optional

INSERT SELECTION

P	Application	Precision finishing	Finishing	Medium cutting	Medium to heavy cutting
	Grade	NS9530	GT9530	T9215	T9215
	Breaker Shape				
	Cutting conditions	B008			
K	Application	Finishing	Medium cutting	Medium to heavy cutting	
	Grade	T515	T515	T515	
	Breaker Shape				
	Cutting conditions	B012			
S	Application	Precision finishing	Finishing	Medium cutting	
	Grade	BX470	AH8005	AH8005	
	Breaker Shape				
	Cutting conditions	B016			

M	Application	Finishing	Medium cutting	Medium to heavy cutting
	Grade	T6120	T6130	T6130
	Breaker Shape			
	Cutting conditions	B010		
N	Application	Precision finishing	Finishing	Medium cutting
	Grade	DX120	DX140	TH10
	Breaker Shape			
	Cutting conditions	B014		
H	Application	Precision finishing	Finishing	
	Grade	BXM10	BXM20	
	Breaker Shape			
	Cutting conditions	B018		

Reference pages: A-PCLNR/L: Insert → B056 -, CBN → B172 -, PCD → B194 -

Grade
Insert
Toolholder
Ext. Toolholder
Int. Toolholder
Threading
Grooving
Miniature Tool
Endmill
Drilling Tool
Tooling System
User's Guide
Index



T-PCLNR

Lever-lock boring bar, for negative 80° rhombic inserts (Tsuppari-Ichiban)

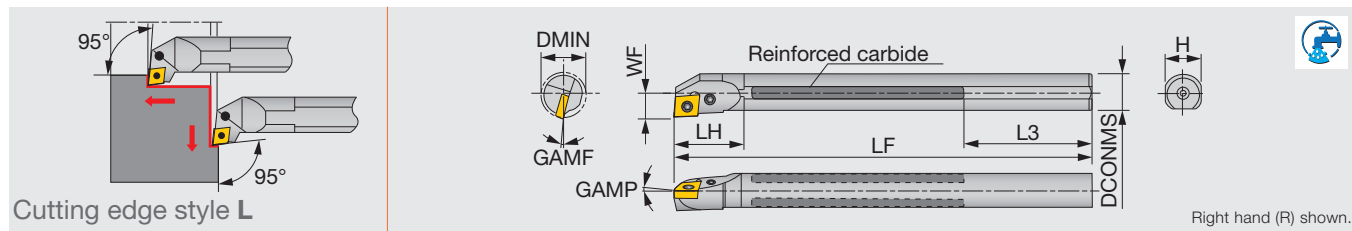

Metric	Material	DMIN	CNT	DCONMS	WF	LF	LH	L3	H	GAMP	GAMF	RE**	Insert	Torque
T16Q-PCLNR09	Reinforced	20	-	16	11	180	27	59	15	-6°	-14°	0.8	CN**0903...	1.7
T20R-PCLNR09C	Reinforced	25	Rc1/4	20	13	200	35	49	18	-6°	-12°	0.8	CN**0903...	1.7
T25S-PCLNR09C	Reinforced	32	Rc1/4	25	17	250	40	64	23	-6°	-11°	0.8	CN**0903...	1.7
T32U-PCLNR12C	Reinforced	40	Rc1/2	32	22	350	50	103	30	-6°	-11°	0.8	CN**1204...	4.8
T40V-PCLNR12C	Reinforced	50	Rc1/2	40	27	400	55	88	37	-6°	-10°	0.8	CN**1204...	4.8
T50W-PCLNR12C	Reinforced	63	Rc1/2	50	35	450	65	63	47	-6°	-8°	0.8	CN**1204...	4.8

Torque: Recommended clamping torque: N·m

**RE: Standard corner radius

Use right-hand toolholders (R) with left-hand inserts (L); and left-hand toolholders (L) with right-hand inserts (R).

SPARE PARTS	Shim	Clamping screw 1	Clamping screw 2	Wrench 1	Wrench 2	Spring pin	Lever
Designation	Shim	Clamping screw 1	Clamping screw 2	Wrench 1	Wrench 2	Spring pin	Lever
T**-PCLNR09...	-	LCS22A	-	P-2F	-	-	LCL32N
T**-PCLNR12C	LSC42BR	-	LCS4	-	P-3	LSP4	LCL4

S-PCLNR/L

Lever-lock boring bar, for negative 80° rhombic inserts

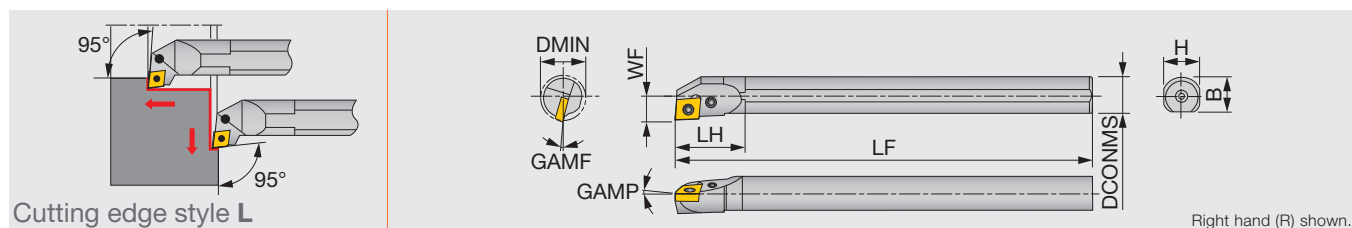

Metric	Material	DMIN	DCONMS	WF	LF	LH	H	B	GAMP	GAMF	RE**	Insert	Torque
S16M-PCLNR/L09	Steel	20	16	11	150	30	15	15.5	-6°	-14°	0.8	CN**0903...	1.7
S20Q-PCLNR/L09	Steel	25	20	13	180	35	18	19	-6°	-12°	0.8	CN**0903...	1.7
S25R-PCLNR/L09	Steel	32	25	17	200	40	23	24	-6°	-11°	0.8	CN**0903...	1.7
S32S-PCLNR/L12	Steel	40	32	22	250	50	30	29.5	-6°	-11°	0.8	CN**1204...	4.8
S40T-PCLNR/L12	Steel	50	40	27	300	55	37	37.5	-6°	-10°	0.8	CN**1204...	4.8
S50U-PCLNR/L12	Steel	63	50	35	350	65	47	47.5	-6°	-8°	0.8	CN**1204...	4.8

Torque: Recommended clamping torque: N·m

**RE: Standard corner radius

Use right-hand toolholders (R) with left-hand inserts (L); and left-hand toolholders (L) with right-hand inserts (R).

SPARE PARTS	Shim	Clamping screw 1	Clamping screw 2	Wrench 1	Wrench 2	Spring pin	Lever
Designation	Shim	Clamping screw 1	Clamping screw 2	Wrench 1	Wrench 2	Spring pin	Lever
S**-PCLNR/L09	-	LCS22A	-	P-2F	-	-	LCL32N
S**-PCLNR/L12	LSC42BR/L	-	LCS4	-	P-3	LSP4	LCL4

Reference pages: T-PCLNR, S-PCLNR/L: Insert → **B056 -**, CBN → **B172 -**, PCD → **B194 -**

Double-clamp boring bar, for negative 80° rhombic inserts

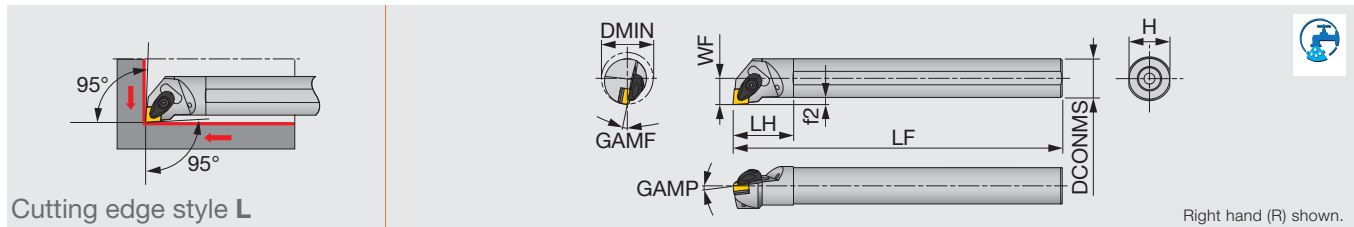

Inch	Material	DMIN	DCONMS	WF	LF	LH	H	f2	GAMP	GAMF	RE**	Insert	Torque
A16-ACLNR/L4-D20	Steel	1.250	1.000	0.640	12.000	1.750	0.906	0.177	-6°	-13°	0.031	CN**43...	2.21
A20-ACLNR/L4-D25	Steel	1.560	1.250	0.770	14.000	1.930	1.180	0.236	-6°	-10°	0.031	CN**43...	2.21
A24-ACLNR/L4-D32	Steel	2.000	1.500	0.890	14.000	2.160	1.450	0.275	-6°	-8°	0.031	CN**43...	2.21
A32-ACLNR/L4-D40	Steel	2.500	2.000	1.280	16.000	2.550	1.850	0.393	-6°	-7°	0.031	CN**43...	2.21

Torque: Recommended clamping torque: lbs-ft

**RE: Standard corner radius

SPARE PARTS

Designation	Clamp	Clamp screw	Spring	Spring pin	Shim	Shim screw	Wrench
A*-ACLNR/L4-D...	ACP4S	ACS-5W	BP-7	SP-2.5	ASC422	CSTB-3.5	T-15F

TUNG T^{URN}JET

C-PCLNL-CHP

Lever-lock boring bar with TungCap connection, with 95° approach angle, for negative 80° rhombic inserts, with high pressure coolant capability

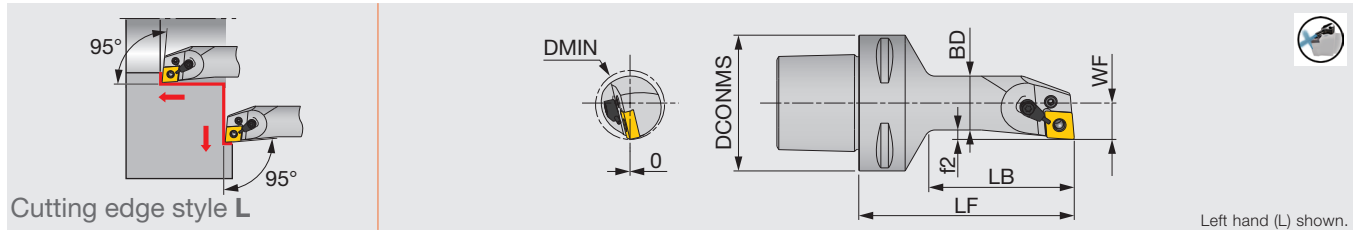

Metric	DMIN	DCONMS	BD	LF	LB	WF	f2	RE**	Insert
C6PCLNL17100-12-CHP	32	63	25	100	67.5	17	4.5	0.8	CN**1204...

Applicable for 14 MPa coolant

**RE: Standard corner radius

SPARE PARTS

Designation	Clamping screw	Coolant unit	Wrench	Lever
C6PCLNL17100-12-CHP	LCS43	S-CU-CHP	P-2.5F	LCL43N

INSERT SELECTION

P	Application	Precision finishing	Finishing	Medium cutting	Medium to heavy cutting	
	Grade	NS9530	GT9530	T9215	T9215	
Breaker Shape	TF	TSF	TM	TH		
Cutting conditions						B008
K	Application	Finishing	Medium cutting	Medium to heavy cutting		
	Grade	T515	T515	T515		
Breaker Shape	All-round	All-round	All-round			
Cutting conditions						B012
S	Application	Precision finishing	Finishing	Medium cutting		
	Grade	BX470	AH8005	AH8005		
Breaker Shape	T-CBN	HRF	HRM			
Cutting conditions						B016

M	Application	Finishing	Medium cutting	Medium to heavy cutting	
	Grade	T6120	T6130	T6130	
Breaker Shape	SF	SM	SH		
Cutting conditions					B010
N	Application	Precision finishing	Finishing	Medium cutting	
	Grade	DX120	DX140	TH10	
Breaker Shape	T-DIA	with rake T-DIA	P		
Cutting conditions					B014
H	Application	Precision finishing	Finishing		
	Grade	BXM10	BXM20		
Breaker Shape	T-CBN	T-CBN			
Cutting conditions					B018

Reference pages: A-ACLNR/L, C-PCLNL-CHP: Insert → B056 -, CBN → B172 -, PCD → B194 -

Screw-on exchangeable boring head, for positive 35° rhombic inserts

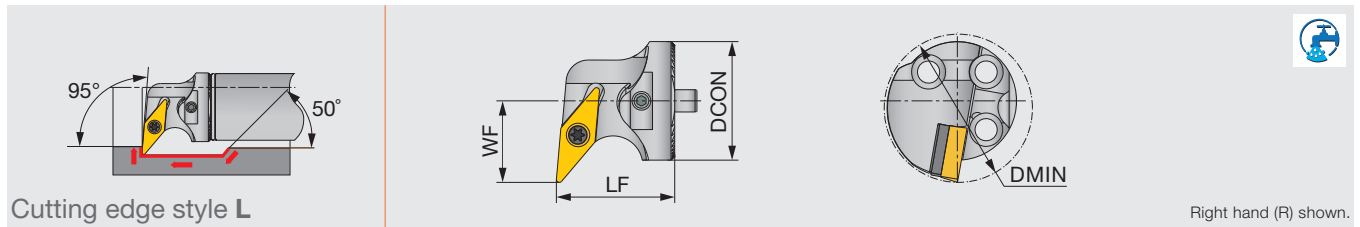

Cutting edge style L

Right hand (R) shown.

Inch	DMIN	DCON	WF	LF	Shank size	Insert
S32-SVLCR/L16T-H	1.575	1.260	0.866	1.260	D1.25	VC**1604...
S40-SVLCR/L16T-H	1.968	1.575	1.063	1.260	D1.50, D2.00, D2.50	VC**1604...

When using a right or left hand insert, the right hand insert (R) is used for the left hand toolholders (SVLCL** type), and the left hand insert (L) is used for the right hand toolholders (SVLCR** type).

SPARE PARTS

Designation	Clamping screw	Wrench	Shim	Shim screw
S**-SVLCL/L16T-H	SR16-236P	T-15/5	TVC 3-1P	SRTC-3P

INSERT SELECTION

P	Application	Finishing	Finishing to medium cutting	M	Application	Finishing	Finishing to medium cutting	Medium cutting
	Grade	NS9530	T9215		Grade	AH725	AH630	T6130
	Breaker Shape	PSS	PS		Breaker Shape	PSF	PSS	PM
	Cutting conditions	B020			Cutting conditions	B022		
K	Application	Finishing to medium cutting	N	Application	Precision finishing	Finishing	Medium cutting	
	Grade	T515		Grade	DX120	DX140	KS05F	
	Breaker Shape	CM		Breaker Shape	T-DIA	with rake T-DIA	AL	
	Cutting conditions	B024		Cutting conditions	B026			
S	Application	Finishing	Finishing to medium cutting	H	Application	Precision finishing	Finishing	
	Grade	AH8015	AH8015		Grade	BXM10	BXM20	
	Breaker Shape	PSS	PS		Breaker Shape	T-CBN	T-CBN	
	Cutting conditions	B028			Cutting conditions	B030		

Reference pages: S-SVLCL/L-H: Insert → **B155** -, CBN → **B192** -, PCD → **B196** -

Anti-vibration bar for exchangeable turning heads, with through coolant

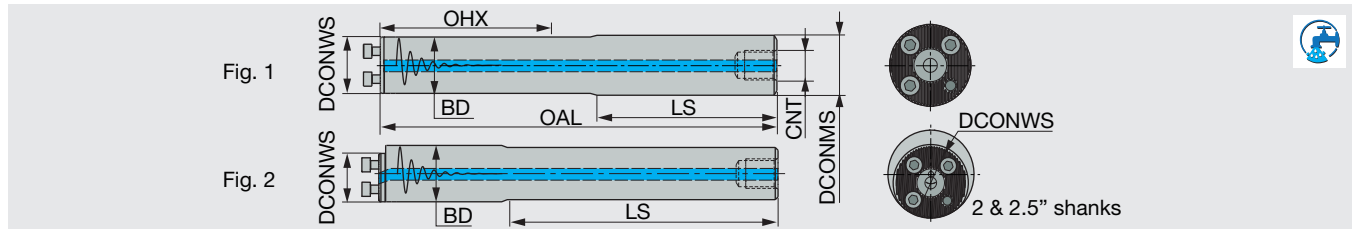

Inch	Material	DCONWS	DCONMS	BD	OAL	LS	OHX	CNT	Fig.
D.625-L6.14-7D-C	Steel	0.630	0.625	0.630	6.140	3.600	3.500	G1/8	1
G.625-L8.03-10D-E	Carbide	0.630	0.625	0.630	8.030	5.220	5.500	-	1
D.750-L7.87-7D-C	Steel	0.787	0.750	0.787	7.870	4.940	4.400	G1/4	1
G.750-L10.24-10D-E	Carbide	0.787	0.750	0.787	10.240	6.770	7.000	-	1
D1.00-L10.2-7D-C	Steel	0.984	1.000	0.984	10.200	6.830	6.200	G1/4	1
D1.00-L13.21-10D-C	Steel	0.984	1.000	0.984	13.210	8.650	9.200	G1/4	1
D1.25-L12.48-7D-C	Steel	1.260	1.250	1.260	12.480	7.370	7.500	G3/8	1
D1.25-L16.24-10D-C	Steel	1.260	1.250	1.260	16.240	9.670	11.200	G3/8	1
D1.50-L15.26-7D-C	Steel	1.575	1.500	1.575	15.260	9.130	9.200	G1/2	1
D1.50-L19.8-10D-C	Steel	1.575	1.500	1.575	19.800	13.350	13.700	G1/2	1
D2.00-L20.74-7D-C	Steel	1.575	2.000	2.000	20.740	-	12.700	G1/2	2
D2.00-L26.73-10D-C	Steel	1.575	2.000	2.000	26.730	-	18.700	G1/2	2
D2.50-L26.2-7D-C	Steel	1.575	2.500	2.500	26.200	-	16.200	G3/4	2
D2.50-L33.72-10D-C	Steel	1.575	2.500	2.500	33.720	-	23.700	G3/4	2

SPARE PARTS



Designation	Clamping screw	Wrench
D.625..., G.625...	SRM3X10DIN912	HW2.5
D.750..., G.750...	SRM3.5X10DIN912	HW2.5
D1.00...	SRM4X12DIN912	HW3.0
D1.25...	SRM5X12DIN912	HW4.0
D1.50..., D2.00..., D2.50...	SRM6X16DIN912-12.9	HW5.0

Grade
Insert
Toolholder
Ext. Toolholder
Int. Toolholder
Threading
Grooving
Tool
Miniature Tool
Milling Cutter
Endmill
Drilling Tool
Tooling System
User's Guide
Index



Screw-on boring bar, for WXGU inserts

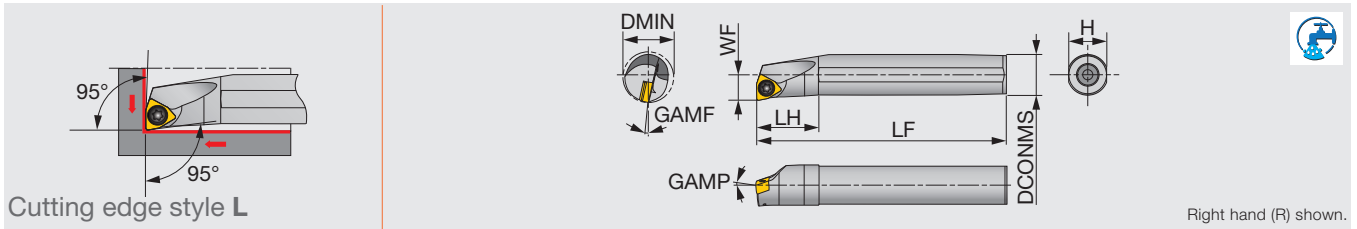

Right hand (R) shown.

Inch	Material	DMIN	DCONMS	WF	LF	LH	H	GAMP	GAMF	RE**	Insert	Torque
A06-SWLXR/L2-D08	Steel	0.500	0.375	0.281	5.000	0.750	0.350	-10°	-14°	0.016	WXGU0403**L/R...	0.66
A08-SWLXR/L2-D11	Steel	0.688	0.500	0.406	5.000	1.000	0.475	-10°	-10°	0.016	WXGU0403**L/R...	0.66
A10-SWLXR/L2-D14	Steel	0.875	0.625	0.531	7.000	1.250	0.600	-10°	-8°	0.016	WXGU0403**L/R...	0.66
A12-SWLXR/L2-D16	Steel	1.000	0.750	0.593	7.000	1.438	0.725	-10°	-7°	0.016	WXGU0403**L/R...	0.66
A16-SWLXR/L2-D20	Steel	1.250	1.000	0.625	7.000	1.438	0.938	-10°	-7°	0.016	WXGU0403**L/R...	0.66
E06-SWLXR/L2-D08	Carbide	0.500	0.375	0.281	5.000	1.000	0.350	-10°	-14°	0.016	WXGU0403**L/R...	0.66
E08-SWLXR/L2-D11	Carbide	0.688	0.500	0.406	5.000	1.063	0.475	-10°	-10°	0.016	WXGU0403**L/R...	0.66
E10-SWLXR/L2-D14	Carbide	0.875	0.625	0.531	7.000	1.250	0.600	-10°	-8°	0.016	WXGU0403**L/R...	0.66
E12-SWLXR/L2-D16	Carbide	1.000	0.750	0.593	7.000	1.438	0.725	-10°	-7°	0.016	WXGU0403**L/R...	0.66
E16-SWLXR/L2-D20	Carbide	1.250	1.000	0.625	10.000	1.812	0.938	-10°	-7°	0.016	WXGU0403**L/R...	0.66

Metric	Material	DMIN	DCONMS	WF	LF	LH	H	GAMP	GAMF	RE**	Insert	Torque*
A10K-SWLXR/L04-D120	Steel	12	10	6	125	20	9	-10°	-16°	0.4	WXGU0403**L/R...	0.9
A12M-SWLXR/L04-D140	Steel	14	12	7	150	24	11	-10°	-14°	0.4	WXGU0403**L/R...	0.9
A16Q-SWLXR/L04-D180	Steel	18	16	9	180	32	15	-10°	-11°	0.4	WXGU0403**L/R...	0.9
A20R-SWLXR/L04-D220	Steel	22	20	11	200	36	18	-10°	-10°	0.4	WXGU0403**L/R...	0.9
E10M-SWLXR/L04-D120	Carbide	12	10	6	150	25	9	-10°	-16°	0.4	WXGU0403**L/R...	0.9
E12Q-SWLXR/L04-D140	Carbide	14	12	7	180	27	11	-10°	-14°	0.4	WXGU0403**L/R...	0.9
E16R-SWLXR/L04-D180	Carbide	18	16	9	200	32	15	-10°	-11°	0.4	WXGU0403**L/R...	0.9
E20S-SWLXR/L04-D220	Carbide	22	20	11	250	36	18	-10°	-10°	0.4	WXGU0403**L/R...	0.9

Torque: Recommended clamping torque: lbs-ft (*N·m)

**RE: Standard corner radius

Use right-hand toolholders (R) with left-hand inserts (L); and left-hand toolholders (L) with right-hand inserts (R)

SPARE PARTS

Designation	Clamping screw	Wrench
A/E**-SWLXR/L...	SR34-514	T-7F

INSERT SELECTION

P	Application	Finishing	Medium cutting	M	Application	Finishing	Medium cutting
	Grade	NS9530	AH725		Grade	AH8015	AH8015
	Breaker Shape	SS	TS		Breaker Shape	SS	TS
	Cutting conditions		D105		Cutting conditions		D105
K	Application	Finishing	Medium cutting	N	Application	Finishing	Medium cutting
	Grade	NS9530	AH725		Grade	KS05F	KS05F
	Breaker Shape	SS	TS		Breaker Shape	SS	TS
	Cutting conditions		D105		Cutting conditions		D105

Reference pages: A/E-SWLXR/L: Insert → **B161** -
Standard cutting conditions → **D105**

Lever-lock boring bar, for negative 80° trigon inserts

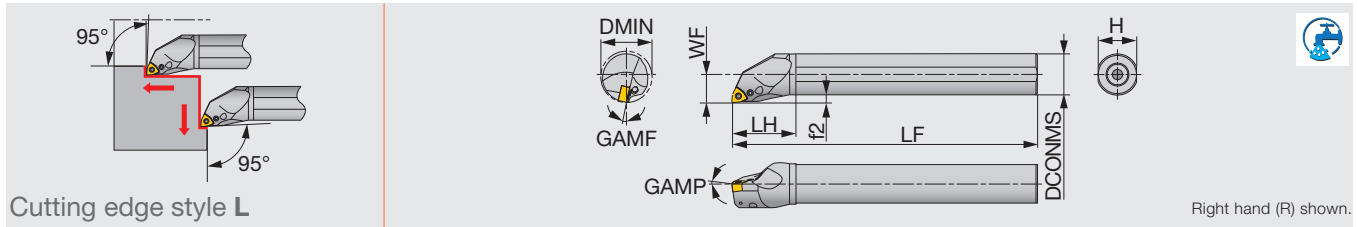

Metric	Material	DMIN	DCONMS	WF	LF	LH	H	f2	GAMP	GAMF	RE**	Insert	Torque
A16M-PWLNR/L0604-D200	Steel	20	16	11	150	32	15	3	-8°	-17°	0.8	WN**0604...	1.7
A20Q-PWLNR/L0604-D250	Steel	25	20	13	180	36	18	3	-6°	-14°	0.8	WN**0604...	1.7

Torque: Recommended clamping torque: N·m
 **RE: Standard corner radius

SPARE PARTS

Designation	Clamping screw	Wrench	Lever	Oil supply attachment*	Screw for oil hole*
A16M-PWLNR/L0604-D200	LCS33	P-2F	LCL33N	-	SSHM3-4
A20Q-PWLNR/L0604-D250	LCS33	P-2F	LCL33N	EA-20	SSHM3-4

*Optional

INSERT SELECTION

P	Application	Finishing	Medium cutting
	Grade	T9215	T9215
	Breaker Shape	TSF	TM
Cutting conditions		B008	

M	Application	Finishing	Medium cutting
	Grade	T6120	T6130
	Breaker Shape	SS	SM
Cutting conditions		B010	

K	Application	Medium cutting
	Grade	T515
	Breaker Shape	TM
Cutting conditions		B012

Double-clamp boring bar, for negative 80° trigon inserts

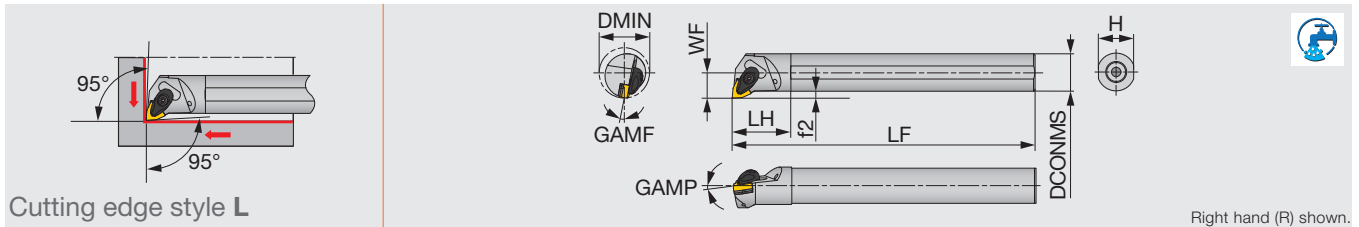

Right hand (R) shown.

Inch	Material	DMIN	DCONMS	WF	LF	LH	H	f2	GAMP	GAMF	RE**	Insert	Torque
A16-AWLNR/L33-D20	Steel	1.250	1.000	0.672	12.000	1.750	0.906	0.172	-6°	-13°	0.031	WN**33...	2.21
A20-AWLNR/L33-D25	Steel	1.560	1.250	0.859	14.000	1.938	1.188	0.234	-6°	-10°	0.031	WN**33...	2.21

Torque: Recommended clamping torque: lbs-ft

**RE: Standard corner radius

SPARE PARTS

Designation	Clamp	Clamp screw	Spring	Spring pin	Shim	Shim screw	Wrench
A**-AWLNR/L33...	ACP3S-E	ACS-5W	BP-7	SP-2.5	ASW322	CSTB-3.5	T-15F

INSERT SELECTION

Application	Finishing	Medium cutting
	Grade	T9215
Breaker Shape	TSF	TM
Cutting conditions		B008

Application	Finishing	Medium cutting
	Grade	T6120
Breaker Shape	SS	SM
Cutting conditions		B010

Application	Medium cutting	
Grade	T515	
Breaker Shape	TM	
Cutting conditions		B012

Reference pages: A-AWLNR/L-Eco: Insert → **B101** -

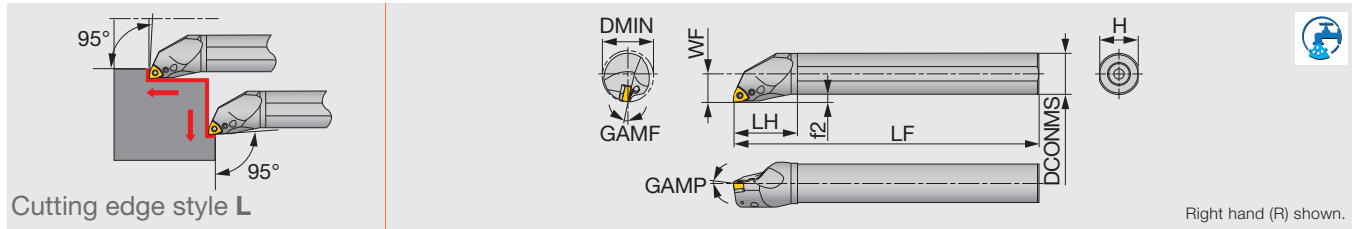

Metric	Material	DMIN	DCONMS	WF	LF	LH	H	f2	GAMP	GAMP	RE**	Insert	Torque
A16M-PWLNRL/L06-D200	Steel	20	16	11	150	32	15	3	-8°	-17°	0.8	WN**0604...	1.7
A20Q-PWLNRL/L06-D250	Steel	25	20	13	180	36	18	3	-6°	-14°	0.8	WN**0604...	1.7
A25R-PWLNRL/L06-D320	Steel	32	25	17	200	45	23	4.5	-6°	-12°	0.8	WN**0604...	2.7
A32S-PWLNRL/L06-D400	Steel	40	32	22	250	50	30	6	-6°	-11°	0.8	WN**0604...	2.7
A25R-PWLNRL/L08-D320	Steel	32	25	17	200	45	23	4.5	-6°	-13°	0.8	WN**0804...	2.7
A32S-PWLNRL/L08-D400	Steel	40	32	22	250	50	30	6	-6°	-11°	0.8	WN**0804...	4.8
A40T-PWLNRL/L08-D500	Steel	50	40	27	300	60	37	7	-6°	-10°	0.8	WN**0804...	4.8

Torque: Recommended clamping torque: N·m **RE: Standard corner radius
Use right-hand toolholders (PWLNR**) with left-hand inserts (L); and left-hand toolholders (PWLNL**) with right-hand inserts (R).

SPARE PARTS	Shim	Clamping screw 1	Clamping screw 2	Wrench 1	Wrench 2	Spring pin	Lever	Oil supply attachment*	Screw for oil hole*
A16M-PWLNRL/L06-D200	-	LCS33	-	P-2F	-	-	LCL33N	-	SSHM3-4
A20Q-PWLNRL/L06-D250	-	LCS33	-	P-2F	-	-	LCL33N	EA-20	SSHM3-4
A25R-PWLNRL/L06-D320	LSW312BR/L	-	LCS3B	-	P-2.5	LSP3	LCL3	EA-25	SSHM4-5
A32S-PWLNRL/L06-D400	LSW312BR/L	-	LCS3	-	P-2.5	LSP3	LCL3	EA-32	SSHM4-5
A25R-PWLNRL/L08-D320	-	LCS43	-	-	P-2.5	-	LCL43N	EA-25	SSHM4-5
A32S-PWLNRL/L08-D400	LSW42BR/L	-	LCS4	-	P-3	LSP4	LCL4	EA-32	SSHM4-5
A40T-PWLNRL/L08-D500	LSW42BR/L	-	LCS4	-	P-3	LSP4	LCL4	-	SSHM4-5

*Optional

INSERT SELECTION

P	Application	Precision finishing	Finishing	Medium cutting	Medium to heavy cutting
	Grade	NS9530	GT9530	T9215	T9215
Breaker Shape	TF	TSF	TM	TH	
Cutting conditions B008					
K	Application	Finishing	Medium cutting	Medium to heavy cutting	
	Grade	T515	T515	T515	
Breaker Shape	All-round	All-round	All-round		
Cutting conditions B012					
H	Application	Precision finishing	Finishing		
	Grade	BXM10	BXM20		
Breaker Shape	T-CBN	T-CBN			
Cutting conditions B018					

M	Application	Finishing	Medium cutting	Medium to heavy cutting
	Grade	T6120	T6130	T6130
Breaker Shape	SF	SM	SH	
Cutting conditions B010				
S	Application	Precision finishing	Finishing	Medium cutting
	Grade	BX480	AH8005	AH8005
Breaker Shape	T-CBN	HRF	HRM	
Cutting conditions B016				

Reference pages: A-PWLNRL: Insert → B101 -, CBN → B181



S-PWLNLR/L

Lever-lock boring bar, for negative 80° trigon inserts

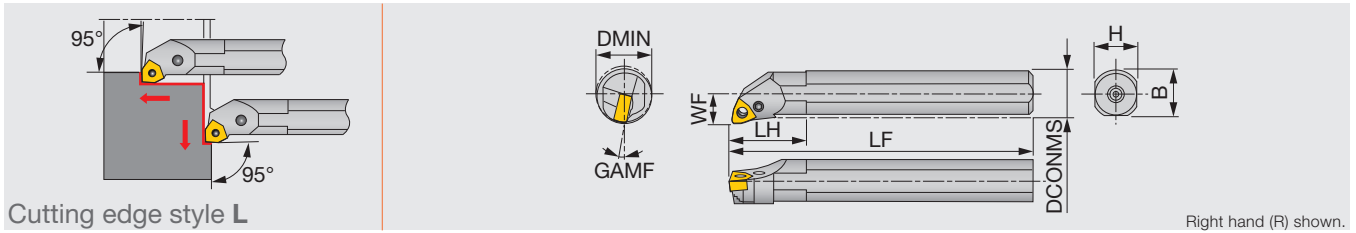

Metric	Material	DMIN	DCONMS	WF	LF	LH	H	B	GAMF	RE**	Insert
S16M-PWLNLR/L06	Steel	20	16	11	150	30	15	15.5	-17°	0.8	WN**0604...
S20Q-PWLNLR/L06	Steel	25	20	13	180	35	18	19	-14°	0.8	WN**0604...
S25R-PWLNLR/L06	Steel	32	25	17	200	40	23	24	-12°	0.8	WN**0604...

**RE : Standard corner radius

Use right-hand toolholders (R) with left-hand inserts (L); and left-hand toolholders (L) with right-hand inserts (R).

SPARE PARTS

Designation	Shim	Clamping screw 1	Clamping screw 2	Wrench 1	Wrench	Spring pin	Lever
S*-PWLNLR/L06	-	LCS33	-	P-2F	-	-	LCL33N
S25R-PWLNLR06	LSW312BR	-	LCS3B	-	P-2.5	LSP3	LCL3
S25R-PWLNLR06	LSW312BL	-	LCS3B	-	P-2.5	LSP3	LCL3

INSERT SELECTION

P

Application	Precision finishing	Finishing	Medium cutting	Medium to heavy cutting
Grade	NS9530	GT9530	T9215	T9215
Breaker Shape	TF	TSF	TM	TH
Cutting conditions	B008			

M

Application	Finishing	Medium cutting	Medium to heavy cutting
Grade	T6120	T6130	T6130
Breaker Shape	SF	SM	SH
Cutting conditions	B010		

K

Application	Finishing	Medium cutting	Medium to heavy cutting
Grade	T515	T515	T515
Breaker Shape	All-round	All-round	All-round
Cutting conditions	B012		

S

Application	Precision finishing	Finishing	Medium cutting
Grade	BX480	AH8005	AH8005
Breaker Shape	T-CBN	HRF	HRM
Cutting conditions	B016		

H

Application	Precision finishing	Finishing
Grade	BXM10	BXM20
Breaker Shape	T-CBN	T-CBN
Cutting conditions	B018	

Reference pages: S-PWLNLR/L: Insert → B101 -, CBN → B181 -

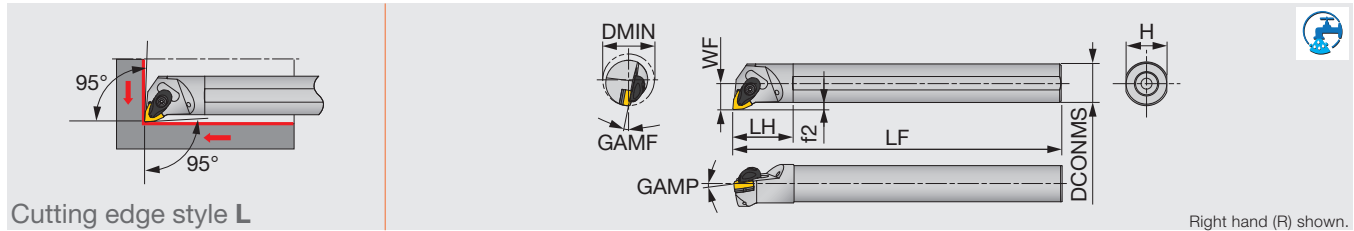

Inch	Material	DMIN	DCONMS	WF	LF	LH	H	f2	GAMP	GAMF	RE**	Insert	Torque
A16-AWLNR/L3-D20	Steel	1.250	1.000	0.672	12.000	1.770	0.906	0.177	-6°	-13°	0.031	WN**33...	2.21
A20-AWLNR/L3-D25	Steel	1.560	1.250	0.859	14.000	1.960	1.180	0.236	-6°	-10°	0.031	WN**33...	2.21
A16-AWLNR/L4-D20	Steel	1.250	1.000	0.672	12.000	1.770	0.906	0.177	-6°	-13°	0.031	WN**43...	2.21
A20-AWLNR/L4-D25	Steel	1.560	1.250	0.859	14.000	1.960	1.180	0.236	-6°	-10°	0.031	WN**43...	2.21
A24-AWLNR/L4-D32	Steel	2.000	1.500	1.060	14.000	2.160	1.460	0.275	-6°	-8°	0.031	WN**43...	2.21
A32-AWLNR/L4-D40	Steel	2.500	2.000	1.370	16.000	2.550	1.850	0.393	-6°	-7°	0.031	WN**43...	2.21

Torque: Recommended clamping torque: lbs-ft

**RE: Standard corner radius

SPARE PARTS

Designation	Clamp	Clamp screw	Spring	Spring pin	Shim	Shim screw	Wrench
A*-AWLNR/L3-D...	ACP3S	ACS-5W	BP-7	SP-2.5	ASW322	CSTB-3.5	T-15F
A*-AWLNR/L4-D...	ACP4S	ACS-5W	BP-7	SP-2.5	ASW422	CSTB-3.5	T-15F

INSERT SELECTION

Application	Precision finishing	Finishing	Medium cutting	Medium to heavy cutting
	Grade	Grade	Grade	Grade
Grade	NS9530	GT9530	T9215	T9215
Breaker Shape	TF	TSF	TM	TH
Images				
Cutting conditions	B008			

Application	Finishing	Medium cutting	Medium to heavy cutting
	Grade	Grade	Grade
Grade	T6120	T6130	T6130
Breaker Shape	SF	SM	SH
Images			
Cutting conditions	B010		

Application	Finishing	Medium cutting	Medium to heavy cutting
	Grade	Grade	Grade
Grade	T515	T515	T515
Breaker Shape	All-round	All-round	All-round
Images			
Cutting conditions	B012		

Application	Precision finishing	Finishing	Medium cutting
	Grade	Grade	Grade
Grade	BX480	AH8005	AH8005
Breaker Shape	T-CBN	HRF	HRM
Images			
Cutting conditions	B016		

Application	Precision finishing	Finishing
	Grade	Grade
Grade	BXM10	BXM20
Breaker Shape	T-CBN	T-CBN
Images		
Cutting conditions	B018	

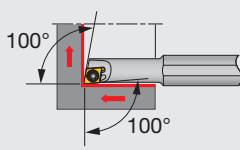

Cutting edge style X

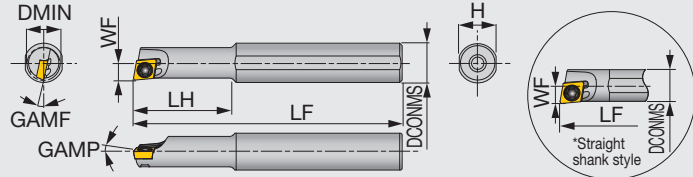

Right hand (R) shown.

Inch	Material	DMIN	DCONMS	WF	LF	LH	H	GAMP	GAMF	RE**	Insert	Torque
A05-SEXPR/L04-D04	Steel	0.250	0.313	0.125	5.000	0.812	0.287	0°	-12°	0.016	EPGT52...	0.44
E05-SEXPR04-D04	Carbide	0.250	0.313	0.125	5.000	1.562	0.287	0°	-12°	0.016	EPGT52...	0.44
Metric	Material	DMIN	DCONMS	WF	LF	LH	H	GAMP	GAMF	RE**	Insert	Torque*
*A04F-SEXPR/L03-D045	Steel	4.5	4	2.3	80	8	3.8	0°	-15°	0.2	EP**03X1...	0.6
*A04F-SEXPR/L03-D050	Steel	5	4	2.5	80	8	3.8	0°	-13°	0.2	EP**03X1...	0.6
*A05F-SEXPR/L04-D055	Steel	5.5	5	2.75	80	9	4.8	0°	-12°	0.4	EP**0401...	0.6
*A06G-SEXPR/L04-D070	Steel	7	6	3.6	90	11	5.75	0°	-12°	0.4	EP**0401...	0.6
A08H-SEXPR/L04-D055	Steel	5.5	8	2.75	100	16	7.5	0°	-12°	0.4	EP**0401...	0.6
A08H-SEXPR/L04-D070	Steel	7	8	3.6	100	20	7.5	0°	-12°	0.4	EP**0401...	0.6
*E04G-SEXPR/L03-D045	Carbide	4.5	4	2.3	90	9	3.8	0°	-15°	0.2	EP**03X1...	0.6
*E04G-SEXPR/L03-D050	Carbide	5	4	2.5	90	9	3.8	0°	-13°	0.2	EP**03X1...	0.6
*E05G-SEXPR/L04-D055	Carbide	5.5	5	2.75	90	10	4.8	0°	-12°	0.4	EP**0401...	0.6
*E06H-SEXPR/L04-D070	Carbide	7	6	3.6	100	12	5.75	0°	-12°	0.4	EP**0401...	0.6
E08K-SEXPR/L04-D055	Carbide	5.5	8	2.75	125	28	7.5	0°	-12°	0.4	EP**0401...	0.6
E08K-SEXPR/L04-D070	Carbide	7	8	3.6	125	40	7.5	0°	-12°	0.4	EP**0401...	0.6

Torque: Recommended clamping torque: lbs-ft (*N·m)

**RE : Standard corner radius

Use right-hand toolholders (SEXPR**) with left-hand inserts (L); and left-hand toolholders (SEXPL**) with right-hand inserts (R).

SPARE PARTS



Designation	Clamping screw	Wrench
A**-SEXPR/L03-D...	CSTA-1.6	T-6F
A**-SEXPR/L04-D...	CSTB-2	T-6F
E**-SEXPR/L03-D...	CSTA-1.6	T-6F
E**-SEXPR/L04-D...	CSTB-2	T-6F

INSERT SELECTION

P	Application	Finishing	M	Application	Finishing	K	Application	Finishing
	Grade	SH725		Grade	SH725		Grade	SH725
	JS			JS			JS	
	Breaker Shape			Breaker Shape			Breaker Shape	
	Cutting conditions	B020		Cutting conditions	B022		Cutting conditions	B024
N	Application	Precision finishing	Finishing	H	Application	Precision finishing		
	Grade	DX140	W08		Grade	BX310	T-CBN	
	Breaker Shape				Breaker Shape			
	Cutting conditions	B026			Cutting conditions	B030		

Reference pages: A/E-SEXPR/L: Insert → **B129** -, CBN → **B186**, PCD → **B197**

Screw-on boring bar, for positive 75° rhombic inserts

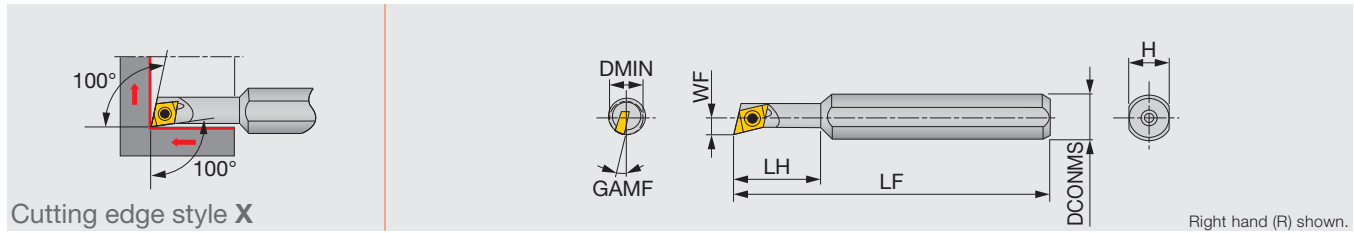

Metric	Material	DMIN	DCONMS	WF	LF	LH	H	GAMF	RE**	Insert	Torque
JS08H-SEXPR045	Steel	5.5	8	2.7	100	16	7	12°	0.4	EP**0401...	0.6
JS08H-SEXPR047	Steel	7	8	3.6	100	20	7	12°	0.4	EP**0401...	0.6

SPARE PARTS

Designation	Clamping screw	Wrench
JS08H-SEXPR04...	CSTB-2	T-6F

Torque: Recommended clamping torque: N·m

**RE : Standard corner radius

Use right-hand toolholders (SEXPR**) with left-hand inserts (L); and left-hand toolholders (SEXPL**) with right-hand inserts (R).

INSERT SELECTION

P	Application	Finishing	M	Application	Finishing	K	Application	Finishing
	Grade	SH725		Grade	SH725		Grade	SH725
	JS			JS			JS	
	Breaker Shape			Breaker Shape			Breaker Shape	
	Cutting conditions	B020		Cutting conditions	B022		Cutting conditions	B024
N	Application	Precision finishing	Finishing	H	Application	Precision finishing		
	Grade	DX140	GH110		Grade	BX310		
	T-DIA	W08			T-CBN			
	Breaker Shape				Breaker Shape			
	Cutting conditions	B026			Cutting conditions	B030		

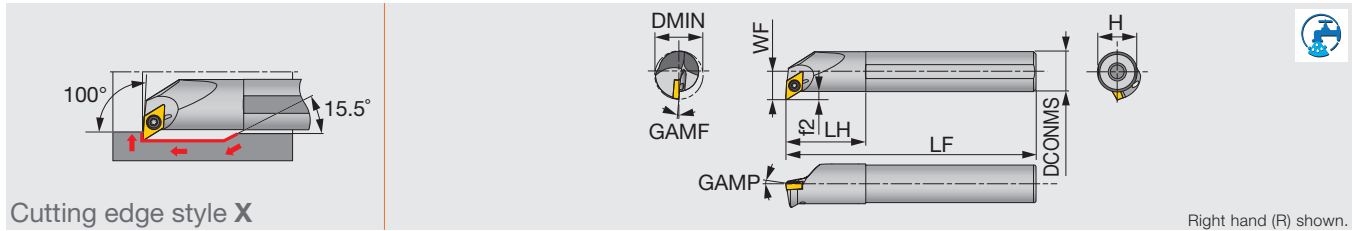

Cutting edge style X

Right hand (R) shown.

Inch	Material	DMIN	DCONMS	WF	LF	LH	H	f2	GAMP	GAMF	RE**	Insert	Torque
A06-SDXXR/L2-D10	Steel	0.625	0.375	0.406	5.000	0.750	0.350	0.213	-14°	-12°	0.016	DXGU0703**L/R...	0.66
A08-SDXXR/L2-D11	Steel	0.688	0.500	0.406	5.000	1.000	0.475	0.151	-13.5°	-11°	0.016	DXGU0703**L/R...	0.66
A10-SDXXR/L2-D14	Steel	0.875	0.625	0.531	7.000	1.250	0.600	0.213	-13°	-9°	0.016	DXGU0703**L/R...	0.66
A12-SDXXR/L2-D16	Steel	1.000	0.750	0.593	7.000	1.438	0.725	0.213	-13°	-8°	0.016	DXGU0703**L/R...	0.66
A16-SDXXR/L2-D20	Steel	1.250	1.000	0.625	7.000	1.438	0.938	0.120	-13°	-8°	0.016	DXGU0703**L/R...	0.66
E06-SDXXR/L2-D10	Carbide	0.625	0.375	0.406	5.000	1.000	0.350	0.213	-14°	-12°	0.016	DXGU0703**L/R...	0.66
E08-SDXXR/L2-D11	Carbide	0.688	0.500	0.406	5.000	1.063	0.475	0.151	-13.5°	-11°	0.016	DXGU0703**L/R...	0.66
E10-SDXXR/L2-D14	Carbide	0.875	0.625	0.531	7.000	1.250	0.600	0.213	-13°	-9°	0.016	DXGU0703**L/R...	0.66
E12-SDXXR/L2-D16	Carbide	1.000	0.750	0.593	7.000	1.438	0.725	0.213	-13°	-8°	0.016	DXGU0703**L/R...	0.66
E16-SDXXR/L2-D20	Carbide	1.250	1.000	0.625	10.000	1.812	0.938	0.120	-13°	-8°	0.016	DXGU0703**L/R...	0.66

Metric	Material	DMIN	DCONMS	WF	LF	LH	H	f2	GAMP	GAMF	RE**	Insert	Torque*
A10K-SDXXR/L07-D130	Steel	13	10	7.6	125	20	9	2.6	-14°	-16°	0.4	DXGU0703**L/R...	0.9
A12M-SDXXR/L07-D160	Steel	16	12	8.6	150	24	11	2.6	-14°	-14°	0.4	DXGU0703**L/R...	0.9
A16Q-SDXXR/L07-D200	Steel	20	16	10.6	180	32	15	2.6	-13°	-13°	0.4	DXGU0703**L/R...	0.9
A20R-SDXXR/L07-D240	Steel	24	20	12.6	200	36	18	2.6	-13°	-12°	0.4	DXGU0703**L/R...	0.9
E10M-SDXXR/L07-D130	Carbide	13	10	7.6	150	25	9	2.6	-14°	-16°	0.4	DXGU0703**L/R...	0.9
E12Q-SDXXR/L07-D160	Carbide	16	12	8.6	180	27	11	2.6	-14°	-14°	0.4	DXGU0703**L/R...	0.9
E16R-SDXXR/L07-D200	Carbide	20	16	10.6	200	32	15	2.6	-13°	-13°	0.4	DXGU0703**L/R...	0.9
E20S-SDXXR/L07-D240	Carbide	24	20	12.6	250	36	18	2.6	-13°	-12°	0.4	DXGU0703**L/R...	0.9

Torque: Recommended clamping torque: lbs-ft (*N-m) **RE : Standard corner radius

Use right-hand toolholders (R) with left-hand inserts (L); and left-hand toolholders (L) with right-hand inserts (R)

SPARE PARTS

Designation	Clamping screw	Wrench
A/E**-SDXXR/L...	SR34-514	T-7F

INSERT SELECTION

Swiss lathes

P	Application	Finishing	Medium cutting	M	Application	Finishing	Medium cutting
	Grade	SH725	AH725		Grade	SH725	AH725
Breaker Shape	JSS	JTS	Breaker Shape	JSS	JTS		
Cutting conditions	D105		Cutting conditions	D105			

Small CNC lathes

P	Application	Finishing	Medium cutting	M	Application	Finishing	Medium cutting
	Grade	AH725	AH725		Grade	AH8015	AH8015
Breaker Shape	SS	TS	Breaker Shape	SS	TS		
Cutting conditions	D105		Cutting conditions	D105			

Reference pages: A/E-SDXXR/L: Insert → **B127** -
Standard cutting conditions → **D105**

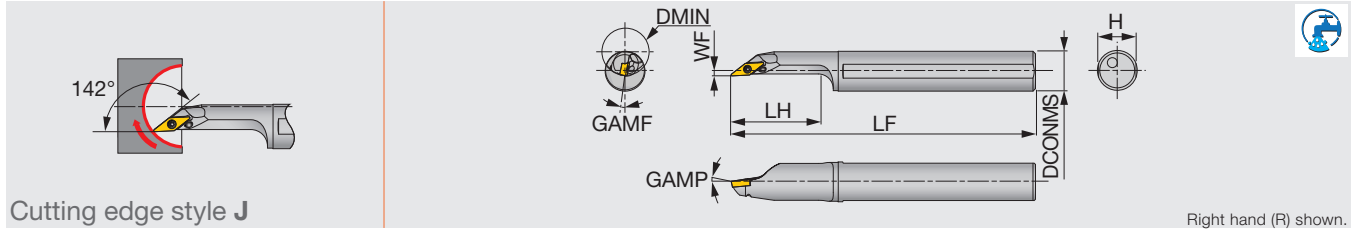

Inch	Material	DMIN	DCONMS	WF	LF	LH	H	GAMP	GAMF	RE**	Insert	Torque
A10-SVJBR/L2-D16	Steel	1.000	0.625	0.156	7.000	1.250	0.600	-5°	-6°	0.016	VB**22...	0.89

Metric	Material	DMIN	DCONMS	WF	LF	LH	H	GAMP	GAMF	RE**	Insert	Torque*
A20R-SVJBR/L11-D250	Steel	25	20	2	200	40	18	-5°	-5°	0.4	VB**1103...	1.2
A25S-SVJBR/L11-D300	Steel	30	25	3.5	250	50	23	-5°	-5°	0.4	VB**1103...	1.2

Torque: Recommended clamping torque: lbs-ft (*N-m)

**RE : Standard corner radius

Use right-hand toolholders (SVJBR**) with left-hand inserts (L); and left-hand toolholders (SVJBL**) with right-hand inserts (R).

SPARE PARTS

Designation	Clamping screw	Wrench
A**-SVJB*11-D...	CSTB-2.5	T-8F

INSERT SELECTION

P

Application	Finishing	Finishing to medium cutting
Grade	SH725	T9215
Breaker Shape	JS	PS
Cutting conditions	B020	

M

Application	Finishing	Finishing to medium cutting
Grade	SH725	T9215
Breaker Shape	JS	PS
Cutting conditions	B022	

K

Application	Finishing to medium cutting
Grade	T515
Breaker Shape	CM
Cutting conditions	B024

H

Application	Precision finishing	Finishing
Grade	BXM10	BXM20
Breaker Shape	T-CBN	T-CBN
Cutting conditions	B030	



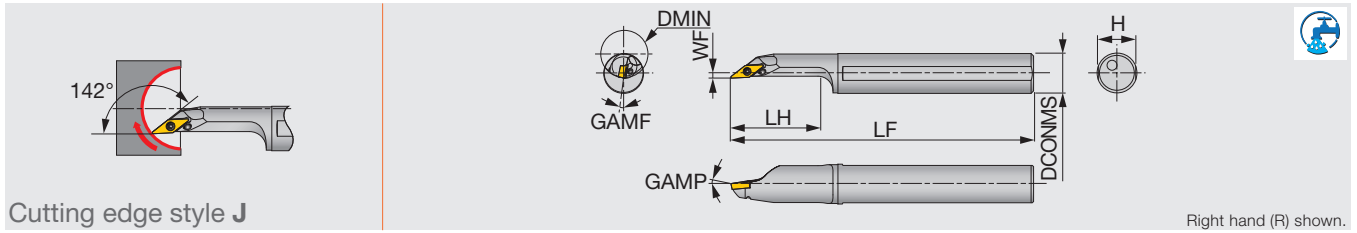

Cutting edge style J

Right hand (R) shown.

Inch	Material	DMIN	DCONMS	WF	LF	LH	H	GAMP	GAMF	RE**	Insert	Torque
A10-SVJCR2-D16	Steel	1.000	0.625	0.156	7.000	1.750	0.600	-5°	-6°	0.016	VC**22..	0.89

Metric	Material	DMIN	DCONMS	WF	LF	LH	H	GAMP	GAMF	RE**	Insert	Torque*
A12M-SVJCR/L08-D160	Steel	16	12	2	150	28	11	-5°	-5°	0.4	VC**0802...	0.6
A16Q-SVJCR/L08-D200	Steel	20	16	2	180	35	15	-5°	-5°	0.4	VC**0802...	0.6

Torque: Recommended clamping torque: lbs-ft (*N·m)

**RE : Standard corner radius

Use right-hand toolholders (SVJCR**) with left-hand inserts (L); and left-hand toolholders (SVJCL**) with right-hand inserts (R).

SPARE PARTS

Designation	Clamping screw	Wrench
A**-SVJC*08-D...	CSTB-2L	T-6F

INSERT SELECTION

P	Application	Finishing to medium cutting	M	Application	Finishing to medium cutting	
	Grade	T9215		Grade	T9215	
	Breaker Shape			Breaker Shape		
	Cutting conditions	B020		Cutting conditions	B022	
K	Application	Finishing to medium cutting	N	Application	Precision finishing	Medium cutting
	Grade	T515		Grade	DX120	KS05F
	Breaker Shape			Breaker Shape		
	Cutting conditions	B024		Cutting conditions	B026	
S	Application	Finishing to medium cutting	H	Application	Precision finishing	Finishing
	Grade	AH8005		Grade	BXM10	BXM20
	Breaker Shape			Breaker Shape		
	Cutting conditions	B028		Cutting conditions	B030	

Reference pages: A-SVJCR/L: Insert → B155 -

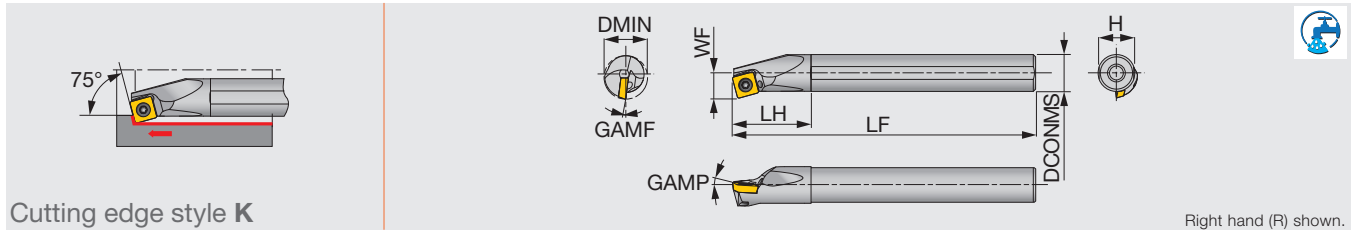

Cutting edge style K

Right hand (R) shown.

Metric	Material	DMIN	DCONMS	WF	LF	LH	H	GAMP	GAMF	RE**	Insert	Torque
A16Q-SSKPR09-D200	Steel	20	16	11	180	32	15	5°	-6°	0.8	SP**0903...	3
A20R-SSKPR09-D240	Steel	24	20	13	200	36	18	5°	-2°	0.8	SP**0903...	3
A25S-SSKPR12-D310	Steel	31	25	17	250	45	23	5°	-2°	0.8	SP**1204...	6

Torque: Recommended clamping torque: N·m

**RE : Standard corner radius

Note: Use right-hand toolholders (SSKPR**) with left-hand inserts (L); and left-hand toolholders (SSKPL**) with right-hand inserts (R).

SPARE PARTS



Designation	Clamping screw	Wrench
A**-SSKPR09-D2*0	CSTB-4L060	T-15F
A25S-SSKPR12-D310	CSTB-5S	T-20F

INSERT SELECTION

P Application: Finishing to medium cutting
 Grade: T9215
 Breaker Shape: PS
 Cutting conditions: B020

M Application: Finishing to medium cutting
 Grade: T9215
 Breaker Shape: PS
 Cutting conditions: B022

K Application: Finishing to medium cutting
 Grade: T515
 Breaker Shape: CM
 Cutting conditions: B024



S-CSKPR/L

Clamp-on boring bar, for positive square inserts

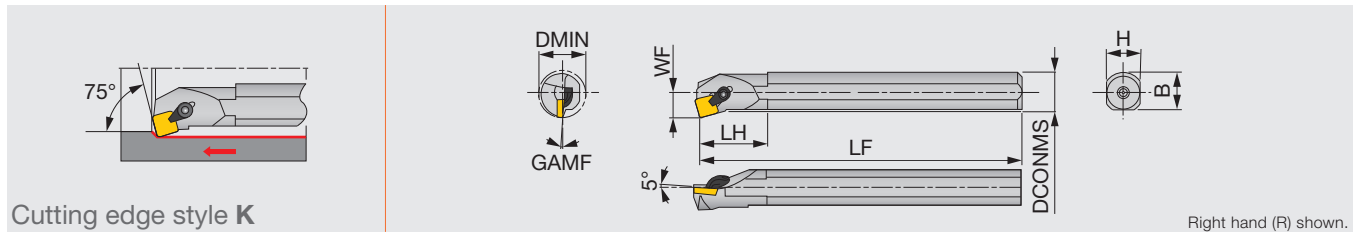

Metric	Material	DMIN	DCONMS	WF	LF	LH	H	B	GAMF	RE**	Insert
S16Q-CSKPR09	Steel	20	16	11	180	30	15	15	-4°	0.8	SP**0903...
S20R-CSKPR/L09	Steel	25	20	13	200	40	18	18.5	-2°	0.8	SP**0903...
S25S-CSKPR12	Steel	32	25	17	250	45	23	22.5	0°	0.8	SP**1203...





**RE : Standard corner radius

Use right-hand toolholders (R) with left-hand inserts (L); and left-hand toolholders (L) with right-hand inserts (R).

SPARE PARTS

Designation	Clamp set	Wrench
S16Q-CSKPR09	CSG-5S	P-2.5
S20R-CSKPR/L09	CSG-5	P-2.5
S25S-CSKPR12	CSG-6	P-3

INSERT SELECTION

P	Application	Finishing to medium cutting	M	Application	Medium cutting
	Grade	T9215		Grade	T6130
	Breaker Shape	PS 		Breaker Shape	PM 
Cutting conditions		B020	Cutting conditions		B022
K	Application	Finishing to medium cutting	N	Application	Finishing
	Grade	T515		Grade	DX140
	Breaker Shape	CM 		Breaker Shape	T-DIA 
Cutting conditions		B024	Cutting conditions		B026

Reference pages: S-CSKPR/L: Insert → **B136 -**, CBN → **B186**, PCD → **B197**

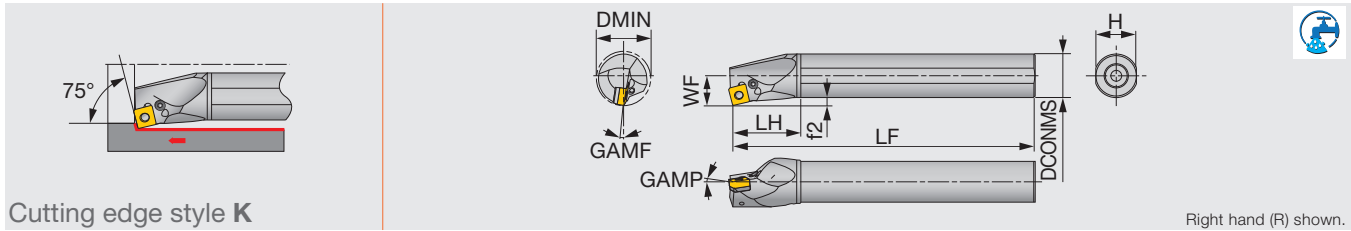

Cutting edge style K

Right hand (R) shown.

Metric	Material	DMIN	DCONMS	WF	LF	LH	H	f2	GAMP	GAMF	RE**	Insert	Torque
A32S-PSKNR/L12-D400	Steel	40	32	22	250	50	30	6	-6°	-10°	0.8	SN**1204...	4.8
A40T-PSKNR/L12-D500	Steel	50	40	27	300	60	37	7	-6°	-10°	0.8	SN**1204...	4.8
A50U-PSKNR/L12-D630	Steel	63	50	35	350	65	47	10	-6°	-8°	0.8	SN**1204...	4.8

Torque: Recommended clamping torque: N·m

**RE : Standard corner radius

Use right-hand toolholders (PSKNR**) with left-hand inserts (L); and left-hand toolholders (PSKNL**) with right-hand inserts (R).

SPARE PARTS

Designation	Shim	Screw	Wrench	Spring pin	Lever	Oil supply attachment*	Screw for oil hole*
A32S-PSKNR/L12-D400	LSS42BR/L	LCS4	P-3	LSP4	LCL4	EA-32	SSHM4-5
A40T-PSKNR/L12-D500	LSS42BR/L	LCS4	P-3	LSP4	LCL4	-	SSHM6-6
A50U-PSKNR/L12-D630	LSS42BR/L	LCS4	P-3	LSP4	LCL4	-	SSHM6-6

*Optional

INSERT SELECTION

Application	Precision finishing	Finishing	Medium cutting	Medium to heavy cutting
	Grade	Grade	Grade	Grade
Grade	NS9530	GT9530	T9215	T9215
Breaker Shape	TF	TSF	TM	TH
Cutting conditions	B008			

Application	Finishing	Medium cutting	Medium to heavy cutting
	Grade	Grade	Grade
Grade	T6120	T6130	T6130
Breaker Shape	SF	SM	SH
Cutting conditions	B010		

Application	Finishing	Medium cutting	Medium to heavy cutting
	Grade	Grade	Grade
Grade	T515	T515	T515
Breaker Shape	All-round	All-round	All-round
Cutting conditions	B012		

Application	Finishing	Medium cutting
	Grade	Grade
Grade	DX140	TH10
Breaker Shape	T-DIA	P
Cutting conditions	B014	

Application	Precision finishing	Finishing	Medium cutting
	Grade	Grade	Grade
Grade	BX480	AH8005	AH8005
Breaker Shape	T-CBN	HRF	HRM
Cutting conditions	B016		

Reference pages: A-PSKNR/L: Insert → **B077 -**, CBN → **B177**, PCD → **B195**

S-PSKNR

Lever-lock boring bar, for negative square inserts

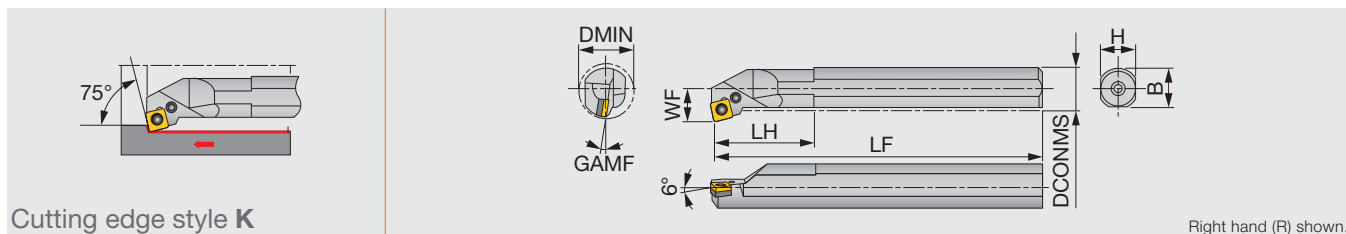

Metric	Material	DMIN	DCONMS	WF	LF	LH	H	B	GAMF	RE**	Insert
S32S-PSKNR12	Steel	40	32	22	250	50	30	29.5	-10°	0.8	SN**1204...
S40T-PSKNR12	Steel	50	40	27	300	55	37	37.5	-10°	0.8	SN**1204...
S50U-PSKNR12	Steel	63	50	35	350	65	47	47.5	-8°	0.8	SN**1204...

**RE : Standard corner radius

Use right-hand toolholders (R) with left-hand inserts (L); and left-hand toolholders (L) with right-hand inserts (R).

SPARE PARTS

Designation	Shim	Clamping screw	Wrench	Spring pin	Lever
S**-PSKNR12	LSS42BR	LCS4	P-3	LSP4	LCL4

TURNINGA

A-ASKNR/L

Double-clamp boring bar, for negative square inserts

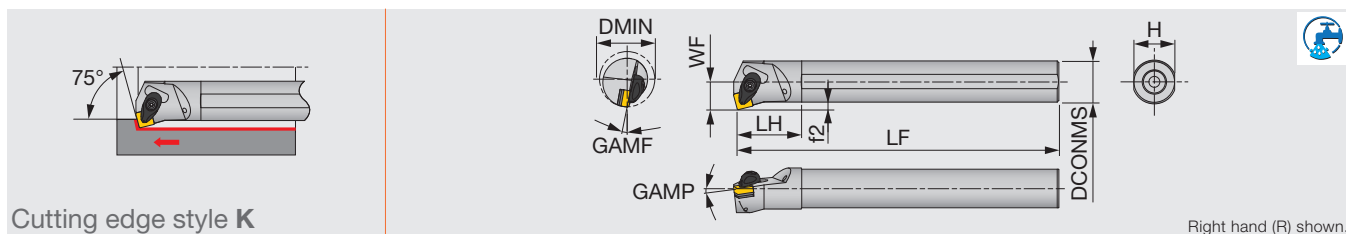

Inch	Material	DMIN	DCONMS	WF	LF	LH	H	f2	GAMP	GAMF	RE**	Insert	Torque
A16-ASKNR/L4-D20	Steel	1.250	1.000	0.672	12.000	1.770	0.906	0.177	-6°	-13°	0.031	SN**43...	2.21
A20-ASKNR/L4-D25	Steel	1.500	1.250	0.859	14.000	1.960	1.180	0.236	-6°	-10°	0.031	SN**43...	2.21

Torque: Recommended clamping torque: lbs-ft

**RE : Standard corner radius

SPARE PARTS

Designation	Clamp	Clamp screw	Spring	Spring pin	Shim	Shim screw	Wrench
A**-ASKNR/L4-D...	ACP4S	ACS-5W	BP-7	SP-2.5	ASS422	CSTB-3.5	T-15F

INSERT SELECTION

Application	Precision finishing	Finishing	Medium cutting	Medium to heavy cutting
	Grade	NS9530	GT9530	T9215
Breaker Shape	TF	TSF	TM	TH
Cutting conditions	B008			

Application	Finishing	Medium cutting	Medium to heavy cutting
	Grade	T6120	T6130
Breaker Shape	SF	SM	SH
Cutting conditions	B010		

Application	Finishing	Medium cutting	Medium to heavy cutting
	Grade	T515	T515
Breaker Shape	All-round	All-round	All-round
Cutting conditions	B012		

Application	Finishing	Medium cutting
	Grade	DX140
Breaker Shape	T-DIA	P
Cutting conditions	B014	

Application	Precision finishing	Finishing	Medium cutting
	Grade	BX480	AH8005
Breaker Shape	T-CBN	HRF	HRM
Cutting conditions	B016		

Reference pages: S-PSKNR, A-ASKNR/L:

Insert → B077 -, CBN → B177, PCD → B195

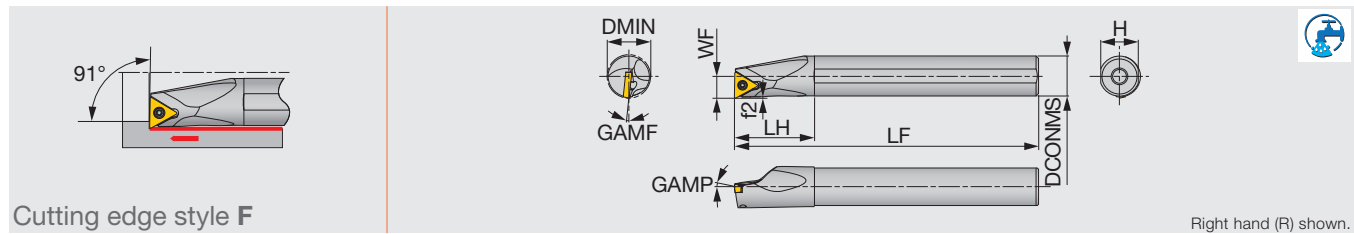

Cutting edge style F

Right hand (R) shown.

Inch	Material	DMIN	DCONMS	WF	LF	LH	H	f2	GAMP	GAMF	RE**	Insert	Torque
E06-STFCR/L2-D08	Carbide	0.500	0.375	0.281	5.000	1.000	0.350	-	0°	-9°	0.016	TC**21.5...	0.89
E08-STFCR2-D11	Carbide	0.688	0.500	0.406	5.000	1.062	0.475	-	0°	-6°	0.016	TC**21.5...	0.89
E10-STFCR2-D14	Carbide	0.875	0.625	0.531	7.000	1.250	0.600	-	0°	-5°	0.016	TC**21.5...	0.89
E12-STFCR3-D16	Carbide	1.000	0.750	0.594	7.000	1.438	0.750	-	0°	-5°	0.032	TC**32.5...	2.2

Metric	Material	DMIN	DCONMS	WF	LF	LH	H	f2	GAMP	GAMF	RE**	Insert	Torque*
A10K-STFCR/L1103-D120	Steel	12	10	6.5	125	20	9	0.6	0°	-13°	0.4	TC**1103...	1.2
A12M-STFCR/L1103-D140	Steel	14	12	7	150	24	11	0.5	0°	-10°	0.4	TC**1103...	1.2
A16Q-STFCR/L1103-D180	Steel	18	16	9	180	32	15	0.5	0°	-7°	0.4	TC**1103...	1.2
E10M-STFCR/L1103-D120	Carbide	12	10	6.5	150	25	9	0.7	0°	-13°	0.4	TC**1103...	1.2
E12Q-STFCR/L1103-D140	Carbide	14	12	7	180	27	11	0.5	0°	-10°	0.4	TC**1103...	1.2
E16R-STFCR/L1103-D180	Carbide	18	16	9	200	32	15	0.5	0°	-7°	0.4	TC**1103...	1.2

Torque: Recommended clamping torque: lbs-ft (**N·m)

**RE : Standard corner radius

Use right-hand toolholders (STFCR**) with left-hand inserts (L); and left-hand toolholders (STFCL**) with right-hand inserts (R).

SPARE PARTS

Designation	Clamping screw	Wrench
E**-STFCR/L2-D...	CSTB-2.5	T-8F
E12-STFCR3-D16	CSTB-4S	T15-F
A**-STFCR/L1103-D...	CSTB-2.5	T-8F
E**-STFCR/L1103-D...	CSTB-2.5	T-8F

INSERT SELECTION

P	Application	Precision finishing	Finishing	Finishing to medium cutting	Medium cutting
	Grade	SH725	SH725	T9215	T9215
	Breaker Shape	01	JS	PS	PM
	Cutting conditions	B020			

M	Application	Precision finishing	Finishing	Finishing to medium cutting	Medium cutting
	Grade	SH725	SH725	T9215	T9215
	Breaker Shape	01	JS	PS	PM
	Cutting conditions	B022			

K	Application	Finishing to medium cutting
	Grade	T515
	Breaker Shape	CM
	Cutting conditions	B024

N	Application	Precision finishing	Medium cutting
	Grade	DX120	KS05F
	Breaker Shape	T-DIA	AL with rake
	Cutting conditions	B026	

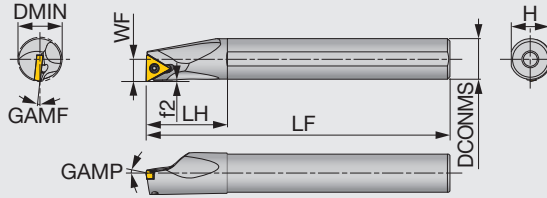
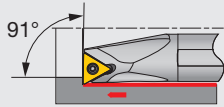

Cutting edge style F

Right hand (R) shown.

Inch	Material	DMIN	DCONMS	WF	LF	LH	H	f2	GAMP	GAMF	RE**	Insert	Torque
E06-STFPR2-D08	Carbide	0.500	0.375	0.281	5.000	1.000	0.350	-	0°	-5°	0.016	TP**21.5...	0.89
E08-STFPR2-D11	Carbide	0.688	0.500	0.406	5.000	1.062	0.475	-	0°	-3°	0.016	TP**21.5...	0.89
E10-STFPR2-D14	Carbide	0.875	0.625	0.531	7.000	1.250	0.605	-	0°	-2°	0.016	TP**21.5...	0.89
E12-STFPR/L3-D16	Carbide	1.000	0.750	0.594	7.000	1.438	0.725	-	0°	-2°	0.032	TP**32.5...	2.2
Metric	Material	DMIN	DCONMS	WF	LF	LH	H	f2	GAMP	GAMF	RE**	Insert	Torque*
A08H-STFPR/L09-D100	Steel	10	8	5.5	100	16	7.5	0.7	5°	-8°	0.4	TP**0902...	0.9
A10K-STFPR/L1102-D120	Steel	12	10	6.5	125	20	9	0.7	5°	-6°	0.4	TP**1102...	1.2
A12M-STFPR/L1102-D140	Steel	14	12	7.0	150	24	11	0.6	5°	-4°	0.4	TP**1102...	1.2
A16Q-STFPR/L13-D180	Steel	18	16	9	180	32	15	0.7	5°	-2°	0.4	TP**1303...	1.4
A20R-STFPR13-D220	Steel	22	20	11	200	36	18	0.8	5°	-2°	0.4	TP**1303...	1.4
A25S-STFPR16-D270	Steel	27	25	13.5	250	45	23	0.6	5°	-1°	0.4	TP**16T3...	3
E08K-STFPR/L09-D100	Carbide	10	8	5.5	125	22	7.5	0.7	5°	-8°	0.4	TP**0902...	0.9
E10M-STFPR/L1102-D120	Carbide	12	10	6.5	150	25	9	0.7	5°	-6°	0.4	TP**1102...	1.2
E12Q-STFPR/L1102-D140	Carbide	14	12	7	180	27	11	0.6	5°	-4°	0.4	TP**1102...	1.2
E16R-STFPR13-D180	Carbide	18	16	9	200	32	15	0.7	5°	-2°	0.4	TP**1303...	1.4
E20S-STFPR13-D220	Carbide	22	20	11	250	36	18	0.8	5°	-2°	0.4	TP**1303...	1.4

Torque: Recommended clamping torque: lbs-ft (*N-m) **RE : Standard corner radius

Use right-hand toolholders (STFPR**) with left-hand inserts (L); and left-hand toolholders (STFPL**) with right-hand inserts (R).

(1) TPGH, TPGM, and TPGA inserts cannot be used.

INCH SPARE PARTS

Designation	Clamping screw	Wrench
E06-STFPR2-D08	CSTB-2.5B	T-8F
E08/10-STFPR2-D1...	CSTB-2.5	T-8F
E12-STFPR/L3-D16	CSTB-4S	T15-F

METRIC SPARE PARTS

Designation	Clamping screw	Wrench
A08H-STFPR/L09-D100	CSTB-2.2S	T-7F
A10K-STFPR/L1102-D120	CSTB-2.5B	T-8F
A12M-STFPR/L1102-D140	CSTB-2.5	T-8F
A16Q-STFPR/L13-D180	CSTB-3S	T-9F
A20R-STFPR13-D220	CSTB-3	T-9F
A25S-STFPR16-D270	CSTB-4M	T-15F
E08K-STFPR/L09-D100	CSTB-2.2S	T-7F
E10M-STFPR/L1102-D120	CSTB-2.5B	T-8F
E12Q-STFPR/L1102-D140	CSTB-2.5	T-8F
E16R-STFPR13-D180	CSTB-3S	T-9F
E20S-STFPR13-D220	CSTB-3	T-9F

INSERT SELECTION

P

Application	Finishing	Finishing to medium cutting	Medium cutting
Grade	SH725	T9215	T9215
Breaker Shape	JS	PS	PM
Cutting conditions	B020		

M

Application	Finishing	Finishing to medium cutting	Medium cutting
Grade	SH725	T9215	T9215
Breaker Shape	JS	PS	PM
Cutting conditions	B022		

K

Application	Finishing to medium cutting
Grade	T515
Breaker Shape	CM
Cutting conditions	B024

N

Application	Precision finishing
Grade	DX120
Breaker Shape	T-DIA with rake
Cutting conditions	B026

S

Application	Precision finishing
Grade	BX470
Breaker Shape	T-CBN
Cutting conditions	B028

H

Application	Precision finishing	Finishing
Grade	BXM10	BXM20
Breaker Shape	T-CBN	T-CBN
Cutting conditions	B030	

Reference pages: A/E-STFPR/L: Insert → B144 -, CBN → B188 -, PCD → B198

S/C-CTFPR/L

Clamp-on boring bar, for positive 60° triangular inserts

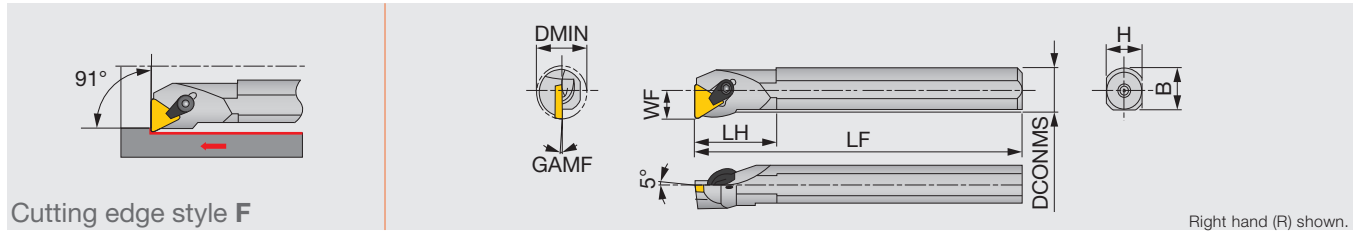

Metric	Material	DMIN	DCONMS	WF	LF	LH	H	B	GAMF	RE**	Insert
S12M-CTFPR/L11	Steel	16	12	9	150	25	11	11.5	-6°	0.4	TP**1103...
S16Q-CTFPR/L11	Steel	20	16	11	180	30	15	15	-4°	0.4	TP**1103...
S20R-CTFPR/L16	Steel	25	20	13	200	40	18	18.5	-2°	0.8	TP**1603...
S25S-CTFPR/L16	Steel	32	25	17	250	45	23	22.5	0°	0.8	TP**1603...
S32T-CTFPR/L16	Steel	40	32	22	300	50	30	29.5	0°	0.8	TP**1603...
C12Q-CTFPR/L11	Carbide	16	12	9	180	-	11	-	-6°	0.4	TP**1103...
C16R-CTFPR/L11	Carbide	20	16	11	200	-	15	-	-4°	0.4	TP**1103...

**RE : Standard corner radius

*The hole specification of applicable inserts conforms to ISO standard.

Use right-hand toolholders (R) with left-hand inserts (L); and left-hand toolholders (L) with right-hand inserts (R).

SPARE PARTS					
Designation	Clamp set 1	Clamp set 2	Wrench	Shim	Shim screw
S12M-CTFPR/L11	CSW-00	-	P-2.5	-	-
S16Q-CTFPR/L11	-	CSG-5S	P-2.5	-	-
S20R-CTFPR/L16	-	CSG-6S	P-3	-	-
S25S-CTFPR/L16	-	CSG-6	P-3	-	-
S32T-CTFPR/L16	-	CSG-6	P-3	PAT-32	M3X0.5X6
C12Q-CTFPR/L11	CSW-00	-	P-2.5	-	-
C16R-CTFPR/L11	-	CSG-5S	P-2.5	-	-

INSERT SELECTION

P	Application	Precision finishing	Finishing	Finishing to medium cutting	Medium cutting
	Grade	NS9530	NS9530	T9215	T9215
	Breaker Shape	01	PSS	PS	PM
Cutting conditions		B020			
M	Application	Finishing	Finishing to medium cutting	Medium cutting	
	Grade	AH725	AH630	T6130	
	Breaker Shape	PSF	PSS	PM	
Cutting conditions		B022			
K	Application	Finishing to medium cutting			
	Grade	T515			
	Breaker Shape	CM			
Cutting conditions		B024			
N	Application	Finishing			
	Grade	DX140			
	Breaker Shape	T-DIA			
Cutting conditions		B026			
H	Application	Precision finishing	Finishing		
	Grade	BXM10	BXM20		
	Breaker Shape	T-CBN	T-CBN		
Cutting conditions		B030			

Reference pages: S/C-CTFPR/L: Insert → B144 -, CBN → B188 -, PCD → B198

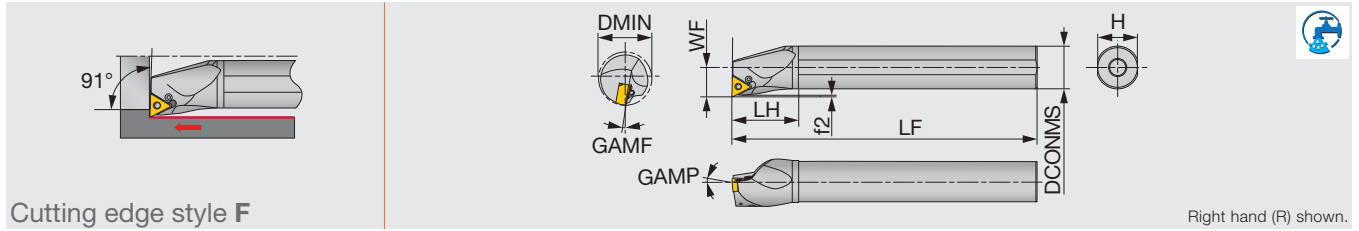

Cutting edge style F

Right hand (R) shown.

Metric	Material	DMIN	DCONMS	WF	LF	LH	H	f2	GAMP	GAMF	RE**	Insert	Torque
A25R-PTFNR/L1104-D320	Steel	32	25	17	200	45	23	1.31	-6°	-12°	0.8	TN**1104...	2
A32S-PTFNR/L1104-D400	Steel	40	32	22	250	50	30	1.25	-6°	-10°	0.8	TN**1104...	2

Torque: Recommended clamping torque: N·m
 **RE: Standard corner radius

SPARE PARTS

Designation	Clamping screw	Wrench	Lever	Oil supply attachment*	Screw for oil hole*
A25R-PTFNR/L...	LCS23A	P-2.5	LCL23	EA-25	SSH4-5
A32S-PTFNR/L...	LCS23A	P-2.5	LCL23	EA-32	SSH4-5

*Optional

INSERT SELECTION

Application	Finishing	Medium cutting
	Grade	T9215
Breaker Shape	TSF	TM
Cutting conditions	B008	

Application	Finishing	Medium cutting
	Grade	T6120
Breaker Shape	SS	SM
Cutting conditions	B010	

Reference pages: A-PTFNR/L-Eco: Insert → **B087** -

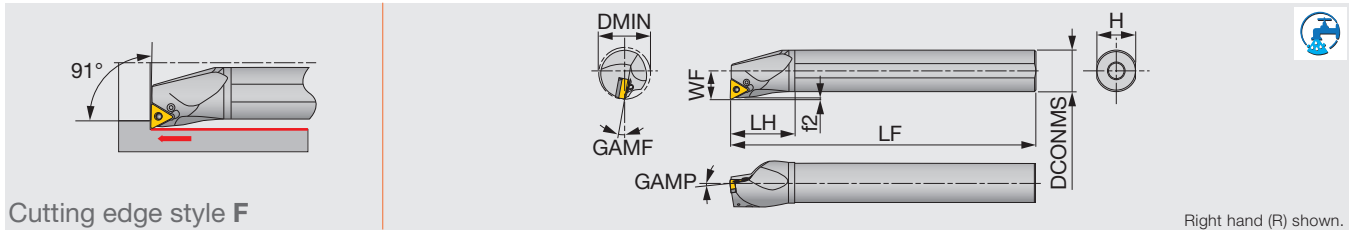

Cutting edge style F

Right hand (R) shown.

Metric	Material	DMIN	DCONMS	WF	LF	LH	H	f2	GAMP	GAMF	RE**	Insert	Torque
A25R-PTFNR/L16-D320	Steel	32	25	17	200	45	23	1.2	-6°	-12°	0.8	TN**1604...	2.7
A32S-PTFNR/L16-D400	Steel	40	32	22	250	50	30	1.1	-6°	-10°	0.8	TN**1604...	2.7
A40T-PTFNR/L16-D500	Steel	50	40	27	300	60	37	1.1	-6°	-10°	0.8	TN**1604...	2.7
A50U-PTFNR/L16-D630	Steel	63	50	35	350	65	47	1.1	-6°	-8°	0.8	TN**1604...	2.7

Torque: Recommended clamping torque: N·m

**RE : Standard corner radius

Note: Use right-hand toolholders (PTFNR**) with left-hand inserts (L); and left-hand toolholders (PTFNL**) with right-hand inserts (R).

SPARE PARTS

Designation	Shim	Clamping screw	Wrench	Spring pin	Lever	Oil supply attachment*	Screw for oil hole*
A25R-PTFNR/L16-D320	ELST317BR/L	LCS3	P-2.5	LSP3	LCL33	EA-25	SSHM4-5
A32S-PTFNR/L16-D400	LST317BR/L	LCS3	P-2.5	LSP3	LCL3	EA-32	SSHM4-5
A40T-PTFNR/L16-D500	LST317BR/L	LCS3	P-2.5	LSP3	LCL3	-	SSHM6-6
A50U-PTFNR/L16-D630	LST317BR/L	LCS3	P-2.5	LSP3	LCL3	-	SSHM6-6

*Optional

INSERT SELECTION

Application	Precision finishing	Finishing	Medium cutting	Medium to heavy cutting
	Grade	NS9530	GT9530	T9215
Breaker Shape	TF	TSF	TM	TH
Cutting conditions	B008			

Application	Finishing	Medium cutting
	Grade	T6120
Breaker Shape	SF	SM
Cutting conditions	B010	

Application	Finishing	Medium cutting	Medium to heavy cutting
	Grade	T515	T515
Breaker Shape	All-round	All-round	All-round
Cutting conditions	B012		

Application	Precision finishing	Finishing	Medium cutting
	Grade	DX120	DX140
Breaker Shape	T-DIA	with rake T-DIA	P
Cutting conditions	B014		

Application	Precision finishing	Finishing	Medium cutting
	Grade	BX470	AH8005
Breaker Shape	T-CBN	HRF	HRM
Cutting conditions	B016		

Application	Precision finishing	Finishing
	Grade	BXM10
Breaker Shape	T-CBN	T-CBN
Cutting conditions	B018	

Reference pages: A-PTFNR/L: Insert → B086 -, CBN → B178 -, PCD → B194 -



S-PTFNR/L

Lever-lock boring bar, for negative 60° triangular inserts

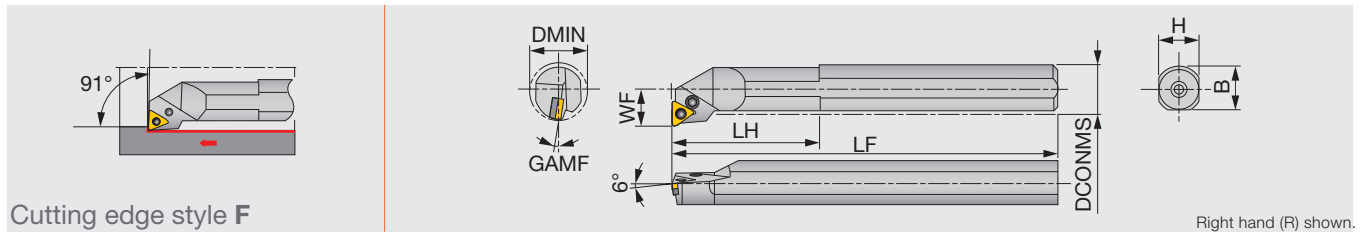

Right hand (R) shown.

Metric	Material	DMIN	DCONMS	WF	LF	LH	H	B	GAMF	RE**	Insert	Torque
S32S-PTFNR/L16	Steel	40	32	22	250	50	30	29.5	-10°	0.8	TN**1604...	2.7
S40T-PTFNR/L16	Steel	50	40	27	300	55	37	37.5	-10°	0.8	TN**1604...	2.7
S50U-PTFNR16	Steel	63	50	35	350	65	47	47.5	-8°	0.8	TN**1604...	2.7

Torque: Recommended clamping torque: N·m

**RE : Standard corner radius

Use right-hand toolholders (R) with left-hand inserts (L); and left-hand toolholders (L) with right-hand inserts (R).

SPARE PARTS

Designation	Shim	Clamping screw	Wrench	Spring pin	Lever
S32S-PTFNR16	LST317BR	LCS3	P-2.5	LSP3	LCL3
S32S-PTFNL16	LST317BL	LCS3	P-2.5	LSP3	LCL3
S40T-PTFNR16	LST317BR	LCS3	P-2.5	LSP3	LCL3
S40T-PTFNL16	LST317BL	LCS3	P-2.5	LSP3	LCL3
S50U-PTFNR16	LST317BR	LCS3	P-2.5	LSP3	LCL3

INSERT SELECTION

Application	Precision finishing	Finishing	Medium cutting	Medium to heavy cutting
Grade	NS9530	GT9530	T9215	T9215
Breaker Shape	TF	TSF	TM	TH
Cutting conditions	B008			

Application	Finishing	Medium cutting
Grade	T6120	T6130
Breaker Shape	SF	SM
Cutting conditions	B010	

Application	Finishing	Medium cutting	Medium to heavy cutting
Grade	T515	T515	T515
Breaker Shape	All-round	All-round	All-round
Cutting conditions	B012		

Application	Precision finishing	Finishing	Medium cutting
Grade	DX120	DX140	TH10
Breaker Shape	T-DIA	with rake T-DIA	P
Cutting conditions	B014		

Application	Precision finishing	Finishing	Medium cutting
Grade	BX470	AH8005	AH8005
Breaker Shape	T-CBN	HRF	HRM
Cutting conditions	B016		

Application	Precision finishing	Finishing
Grade	BXM10	BXM20
Breaker Shape	T-CBN	T-CBN
Cutting conditions	B018	

Reference pages: S-PTFNR/L: Insert → **B086 -**, CBN → **B178 -**, PCD → **B194 -**

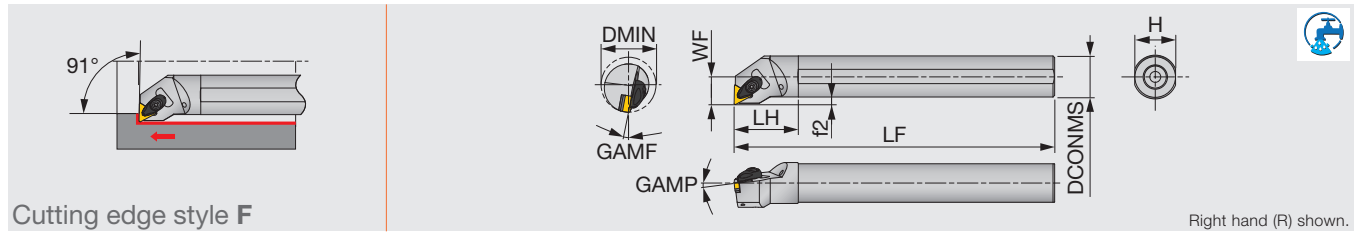

Cutting edge style F

Right hand (R) shown.

Inch	Material	DMIN	DCONMS	WF	LF	LH	H	f2	GAMP	GAMF	RE**	Insert	Torque
A16-ATFNR/L3-D20	Steel	1.250	1.000	0.672	12.000	1.770	0.906	0.177	-6°	-13°	0.031	TN**33...	2.21
A20-ATFNR/L3-D25	Steel	1.560	1.250	0.859	14.000	1.960	1.180	0.236	-6°	-10°	0.031	TN**33...	2.21

Torque: Recommended clamping torque: lbs-ft

**RE : Standard corner radius

SPARE PARTS

Designation	Clamp	Clamp screw	Spring	Spring pin	Shim	Shim screw	Wrench
A**-ATFNR/L3-D...	ACP3S	ACS-5W	BP-7	SP-2.5	AST322	CSTB-3.5	T-15F

INSERT SELECTION

Application	Precision finishing	Finishing	Medium cutting	Medium to heavy cutting
	Grade	NS9530	GT9530	T9215
Breaker Shape	TF	TSF	TM	TH
Cutting conditions	B008			

Application	Finishing	Medium cutting
	Grade	T6120
Breaker Shape	SF	SM
Cutting conditions	B010	

Application	Finishing	Medium cutting	Medium to heavy cutting
	Grade	T515	T515
Breaker Shape	All-round	All-round	All-round
Cutting conditions	B012		

Application	Precision finishing	Finishing	Medium cutting
	Grade	DX120	DX140
Breaker Shape	T-DIA	with rake T-DIA	P
Cutting conditions	B014		

Application	Precision finishing	Finishing	Medium cutting
	Grade	BX470	AH8005
Breaker Shape	T-CBN	HRF	HRM
Cutting conditions	B016		

Application	Precision finishing	Finishing
	Grade	BXM10
Breaker Shape	T-CBN	T-CBN
Cutting conditions	B018	

Reference pages: A-ATFNR/L: Insert → **B086 -**, CBN → **B178 -**, PCD → **B194 -**



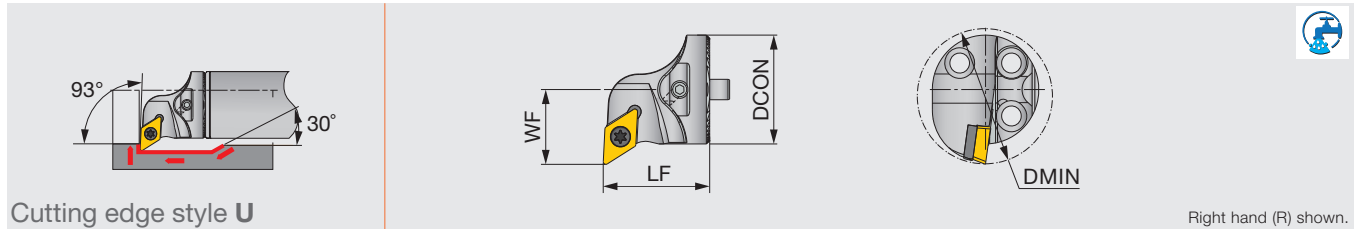

Cutting edge style U

Right hand (R) shown.

Inch	DMIN	DCON	WF	LF	Shank size	Insert
S16-SDUCR/L07-H	0.787	0.630	0.433	0.787	D/G.625	DC**0702...
S20-SDUCR/L11-H	0.984	0.787	0.512	0.787	D/G.750	DC**11T3...
S25-SDUCR/L11-H	1.260	0.984	0.669	0.787	D1.00	DC**11T3...
S32-SDUCR/L11T-H	1.575	1.260	0.866	1.260	D1.25	DC**11T3...
S40-SDUCR/L11T-H	1.969	1.575	1.063	1.260	D1.50, D2.00, D2.50	DC**11T3...

When using a right or left hand insert, the right hand insert (R) is used for the left hand toolholders (SDUCL** type), and the left hand insert (L) is used for the right hand toolholders (SDUCR** type).

SPARE PARTS

Designation	Clamping screw	Wrench	Shim	Shim screw
S16-SDUCR/L07-H	SR14-548	T-7/5	-	-
S20-SDUCR/L11-H	SR16-236P	T-15/5	-	-
S25-SDUCR/L11-H	SR16-236P	T-15/5	-	-
S32-SDUCR/L11T-H	SR16-236P	T-15/5	TDC3-1P	SRTC-3P
S40-SDUCR/L11T-H	SR16-236P	T-15/5	TDC3-1P	SRTC-3P

INSERT SELECTION

Application	Finishing	Finishing to medium cutting	Medium cutting
	Grade	NS9530	T9215
Breaker Shape	PSS	PS	PM
Cutting conditions	B020		

Application	Precision finishing	Finishing	Finishing to medium cutting	Medium cutting
	Grade	GH330	AH725	AH630
Breaker Shape	W**	PSF	PSS	PM
Cutting conditions	B022			

Application	Finishing to medium cutting
Grade	T515
Breaker Shape	CM
Cutting conditions	B024

Application	Precision finishing	Finishing	Medium cutting
Grade	DX120	DX140	KS05F
Breaker Shape	T-DIA	with rake T-DIA	AL
Cutting conditions	B026		

Application	Finishing	Finishing to medium cutting
Grade	AH8015	AH8015
Breaker Shape	PSS	PS
Cutting conditions	B028	

Application	Precision finishing	Finishing
Grade	BXM10	BXM20
Breaker Shape	T-CBN	T-CBN
Cutting conditions	B030	

Reference pages: S-SDUCR/L-H: Insert → B121 -, CBN → B184, PCD → B196 -

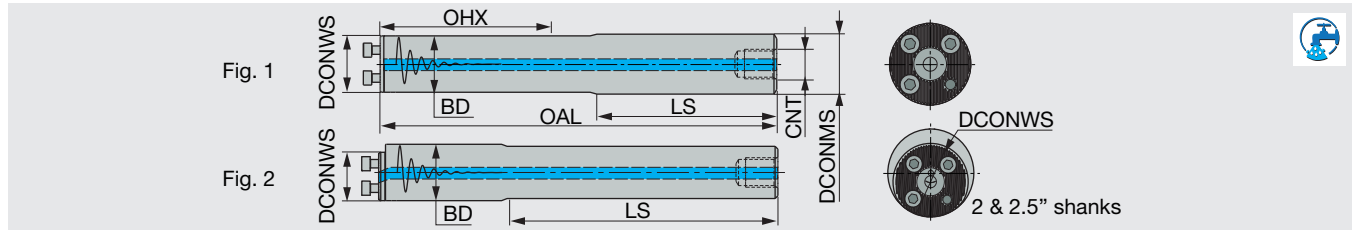

Inch	Material	DCONWS	DCONMS	BD	OAL	LS	OHX	CNT	Fig.
D.625-L6.14-7D-C	Steel	0.630	0.625	0.630	6.140	3.600	3.500	G1/8	1
G.625-L8.03-10D-E	Carbide	0.630	0.625	0.630	8.030	5.220	5.500	-	1
D.750-L7.87-7D-C	Steel	0.787	0.750	0.787	7.870	4.940	4.400	G1/4	1
G.750-L10.24-10D-E	Carbide	0.787	0.750	0.787	10.240	6.770	7.000	-	1
D1.00-L10.2-7D-C	Steel	0.984	1.000	0.984	10.200	6.830	6.200	G1/4	1
D1.00-L13.21-10D-C	Steel	0.984	1.000	0.984	13.210	8.650	9.200	G1/4	1
D1.25-L12.48-7D-C	Steel	1.260	1.250	1.260	12.480	7.370	7.500	G3/8	1
D1.25-L16.24-10D-C	Steel	1.260	1.250	1.260	16.240	9.670	11.200	G3/8	1
D1.50-L15.26-7D-C	Steel	1.575	1.500	1.575	15.260	9.130	9.200	G1/2	1
D1.50-L19.8-10D-C	Steel	1.575	1.500	1.575	19.800	13.350	13.700	G1/2	1
D2.00-L20.74-7D-C	Steel	1.575	2.000	2.000	20.740	-	12.700	G1/2	2
D2.00-L26.73-10D-C	Steel	1.575	2.000	2.000	26.730	-	18.700	G1/2	2
D2.50-L26.2-7D-C	Steel	1.575	2.500	2.500	26.200	-	16.200	G3/4	2
D2.50-L33.72-10D-C	Steel	1.575	2.500	2.500	33.720	-	23.700	G3/4	2

SPARE PARTS



Designation	Clamping screw	Wrench
D.625..., G.625...	SRM3X10DIN912	HW2.5
D.750..., G.750...	SRM3.5X10DIN912	HW2.5
D1.00...	SRM4X12DIN912	HW3.0
D1.25...	SRM5X12DIN912	HW4.0
D1.50..., D2.00... D2.50...	SRM6X16DIN912-12.9	HW5.0

Grade
Insert
Toolholder
Ext. Toolholder
Int. Toolholder
Threading
Grooving
Tool
Miniature Tool
Milling Cutter
Endmill
Drilling Tool
Tooling System
User's Guide
Index

A
B
C
D
E
F
G
H
I
J
K
L
M

Screw-on boring bar, for positive 55° rhombic inserts

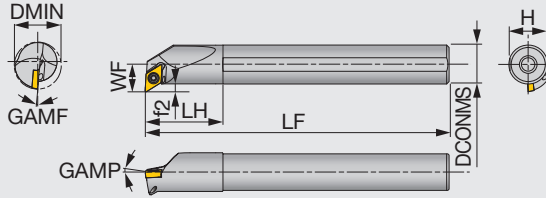
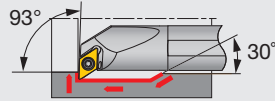

Cutting edge style U

Right hand (R) shown.

Inch	Material	DMIN	DCONMS	WF	LF	LH	H	f2	GAMP	GAMF	RE**	Insert	Torque
A06-SDUCR2-D10	Steel	0.625	0.375	0.406	5.000	0.750	0.350	0.218	0°	-8°	0.016	DC**21.5...	0.89
A08-SDUCR/L2-D11	Steel	0.688	0.500	0.406	5.000	1.000	0.475	0.156	0°	-6°	0.016	DC**21.5...	0.89
A10-SDUCR2-D14	Steel	0.875	0.625	0.531	7.000	1.250	0.600	0.218	0°	-4°	0.016	DC**21.5...	0.89
A12-SDUCR/L3-D16	Steel	1.000	0.750	0.594	10.000	1.500	0.700	0.218	0°	-2°	0.032	DC**32.5...	2.2
E06-SDUCR2-D10	Carbide	0.625	0.375	0.406	5.000	1.000	0.375	0.218	0°	-7°	0.016	DC**21.5...	0.89
E08-SDUCR2-D11	Carbide	0.688	0.500	0.406	5.000	1.062	0.475	0.156	0°	-6°	0.016	DC**21.5...	0.89
E10-SDUCR2-D14	Carbide	0.875	0.625	0.531	7.000	1.250	0.600	0.218	0°	-4°	0.016	DC**21.5...	0.89
E12-SDUCR/L3-D16	Carbide	1.000	0.750	0.594	7.000	1.438	0.750	0.218	0°	-5°	0.032	DC**32.5...	2.2

Metric	Material	DMIN	DCONMS	WF	LF	LH	H	f2	GAMP	GAMF	RE**	Insert	Torque*
A10K-SDUCR/L07-D130	Steel	13	10	7	125	20	9	2	0°	-10°	0.4	DC**0702...	1.2
A12M-SDUCR/L07-D160	Steel	16	12	9.3	150	24	11	3.3	0°	-6°	0.4	DC**0702...	1.2
A16Q-SDUCR/L07-D200	Steel	20	16	11.3	180	32	15	3.3	0°	-5°	0.4	DC**0702...	1.2
A20R-SDUCR/L11-D270	Steel	27	20	16.1	200	36	18	6.1	0°	-5°	0.8	DC**11T3...	3
A25S-SDUCR/L11-D320	Steel	32	25	18.6	250	45	23	6.1	0°	-4°	0.8	DC**11T3...	3
E10H-SDUCR07-D130	Carbide	13	10	7	100	25	9	1.9	5°	-3.5°	0.4	DC**0702...	1.2
E10M-SDUCR/L07-D130	Carbide	13	10	7	150	25	9	2	0°	-10°	0.4	DC**0702...	1.2
E12J-SDUCR07-D160	Carbide	16	12	9.3	110	27	11	3.2	0°	-6°	0.4	DC**0702...	1.2
E12Q-SDUCR/L07-D160	Carbide	16	12	9.3	180	27	11	3.3	0°	-6°	0.4	DC**0702...	1.2
E16L-SDUCR07-D200	Carbide	20	16	11.3	130	32	15	3.2	0°	-5°	0.4	DC**0702...	1.2
E16R-SDUCR/L07-D200	Carbide	20	16	11.3	200	32	15	3.3	0°	-5°	0.4	DC**0702...	1.2
E20S-SDUCR11-D270	Carbide	27	20	16.1	250	36	18	6.1	0°	-5°	0.8	DC**11T3...	3

Torque: Recommended clamping torque: lbs-ft (*N-m) **RE : Standard corner radius

Use right-hand toolholders (SDUCR**) with left-hand inserts (L); and left-hand toolholders (SDUCL**) with right-hand inserts (R).

INCH SPARE PARTS



Designation	Clamping screw	Wrench
A/E06-SDUCR2-D10, A/E10-SDUCR2-D14	CSTB-2.5	T-8F
A08-SDUCR/L2-D11, E08-SDUCR2-D11	CSTB-2.5B	T-8F
A12-SDUCR/L3-D16	CSTB-3.5	T-15F
E12-SDUCR/L3-D16	CSTB-4S	T15-F

METRIC SPARE PARTS



Designation	Clamping screw	Wrench
A1**-SDUCR/L07-D1*0	CSTB-2.5S	T-8F
A16Q-SDUCR/L07-D200	CSTB-2.5	T-8F
A2**-SDUCR/L11-D**0	CSTB-4S	T-15F
E1**-SDUCR/L07-D1*0	CSTB-2.5S	T-8F
E16*-SDUCR/L07-D200	CSTB-2.5	T-8F
E20S-SDUCR11-D270	CSTB-4S	T-15F

INSERT SELECTION

P

Application	Precision finishing	Finishing	Finishing to medium cutting	Medium cutting
Grade	SH725	SH725	T9215	T9215
Breaker Shape	01	JS	PS	PM
Cutting conditions	B020			

M

Application	Precision finishing	Finishing	Finishing to medium cutting	Medium cutting
Grade	SH725	SH725	T9215	T9215
Breaker Shape	01	JS	PS	PM
Cutting conditions	B022			

K

Application	Finishing to medium cutting
Grade	T515
Breaker Shape	CM
Cutting conditions	B024

N

Application	Precision finishing	Medium cutting
Grade	DX120	KS05F
Breaker Shape	T-DIA	with rake AL
Cutting conditions	B026	

S

Application	Precision finishing	Finishing to medium cutting
Grade	BX470	AH8005
Breaker Shape	T-CBN	PS
Cutting conditions	B028	

H

Application	Precision finishing	Finishing
Grade	BXM10	BXM20
Breaker Shape	T-CBN	T-CBN
Cutting conditions	B030	

Reference pages: A/E-SDUCR/L: Insert → B121 -, CBN → B184, PCD → B196 -

Screw-on boring bar, for positive 55° rhombic inserts

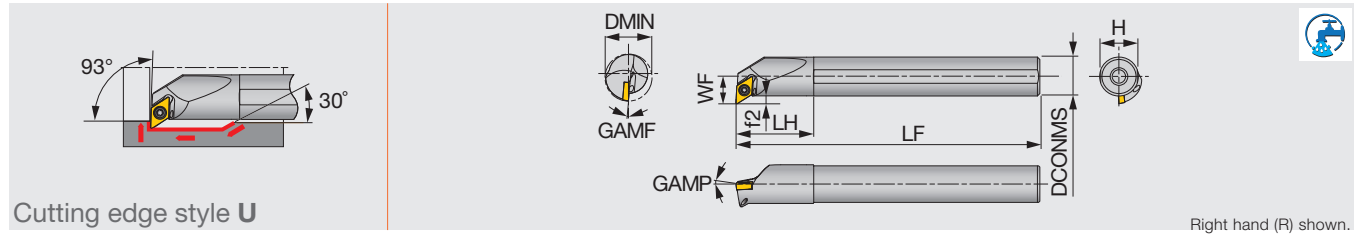

Cutting edge style U

Right hand (R) shown.

Metric	Material	DMIN	DCONMS	WF	LF	LH	H	f2	GAMP	GAMF	RE***	Insert	Torque
A12M-SDUPR07-D150-P	Special alloy steel*	15	12	8.3	150	24	11	2.3	5°	0°	0.4	DPMT0702...	1.2
A12M-SDUPL07-D150-P	Special alloy steel*	15	12	8.3	150	24	11	2.3	5°	0°	0.4	DPMT0702...	1.2
A12M-SDUPR07-D180-P	Special alloy steel*	18	12	10.3	150	24	11	4.3	5°	0°	0.4	DPMT0702...	1.2
A12M-SDUPL07-D180-P	Special alloy steel*	18	12	10.3	150	24	11	4.3	5°	0°	0.4	DPMT0702...	1.2
A16Q-SDUPR07-D220-P	Special alloy steel*	22	16	12.3	180	32	15	4.3	5°	0°	0.4	DPMT0702...	1.2
A16Q-SDUPL07-D220-P	Special alloy steel*	22	16	12.3	180	32	15	4.3	5°	0°	0.4	DPMT0702...	1.2
E12Q-SDUPR07-D150	Carbide	15	12	8.3	180	27	11	2.3	5°	0°	0.4	DPMT0702...	1.2
E12Q-SDUPL07-D150	Carbide	15	12	8.3	180	27	11	2.3	5°	0°	0.4	DPMT0702...	1.2
E12Q-SDUPR07-D180	Carbide	18	12	10.3	180	27	11	4.3	5°	0°	0.4	DPMT0702...	1.2
E12Q-SDUPL07-D180	Carbide	18	12	10.3	180	27	11	4.3	5°	0°	0.4	DPMT0702...	1.2
E16R-SDUPR07-D220	Carbide	22	16	12.3	200	32	15	4.3	5°	0°	0.4	DPMT0702...	1.2
E16R-SDUPL07-D220	Carbide	22	16	12.3	200	32	15	4.3	5°	0°	0.4	DPMT0702...	1.2

*Special alloy steel: Exclusively selected material is used to reduce chattering.

Torque: Recommended clamping torque: N·m

***RE : Standard corner radius

Use right-hand toolholders (SCLPR**) with left-hand inserts (L); and left-hand toolholders (SCLPL**) with right-hand inserts (R).

SPARE PARTS

Designation	Clamping screw	Wrench
A**-SDUPR/L07-D**0-P	CSTB-2.5S	T-8F
E**-SDUPR/L07-D**0	CSTB-2.5S	T-8F

INSERT SELECTION

P	Application	Finishing to medium cutting	
	Grade	T9225	NS9530
	Breaker Shape	PS	PS
	Cutting conditions	B020	

S	Application	Finishing to medium cutting	
	Grade	AH8015	
	Breaker Shape	PS	
	Cutting conditions	B028	

Reference pages: A/E-SDUPR/L: Insert → **B127**



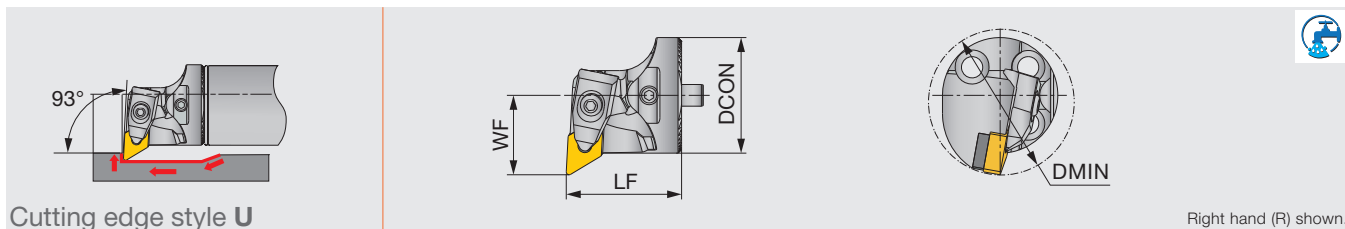

Right hand (R) shown.

Inch	DMIN	DCON	WF	LF	Shank size	Insert
S32-DDUNR/L11T-H	1.575	1.260	0.866	1.260	D1.25	DN**33...
S40-DDUNR/L15T-H	1.968	1.575	1.063	1.496	D1.50, D2.00, D2.50	DN**43/44...

When using a right or left hand insert, the right hand insert (R) is used for the left hand toolholders (DDUNL** type), and the left hand insert (L) is used for the right hand toolholders (DDUNR** type).

SPARE PARTS

Designation	Shim	Shim screw	Clamp	Clamping screw	Spring	Wrench
S32-DDUNR/L11T-H	RDT3-2	SR40085I	LCGR-3	SRRC3	KSP3	HW2.5
S40-DDUNR/L15T-H	RDT433	SR14-506	DLM4	DLS4	DSP4	HW3.0
S40-DDUNR/L15T-H	RDT443	SR14-506	DLM4	DLS4	DSP4	HW3.0

INSERT SELECTION

Application	Precision finishing	Finishing	Medium cutting	Medium to heavy cutting
	Grade	NS9530	GT9530	T9215
Breaker Shape	TF	TSF	TM	TH
Cutting conditions	B008			

Application	Finishing	Medium cutting	Medium to heavy cutting
	Grade	T6120	T6130
Breaker Shape	SF	SM	SH
Cutting conditions	B010		

Application	Finishing	Medium cutting	Medium to heavy cutting
	Grade	T515	T515
Breaker Shape	All-round	All-round	All-round
Cutting conditions	B012		

Application	Precision finishing	Finishing	Medium cutting
	Grade	DX120	DX140
Breaker Shape	T-DIA	with rake T-DIA	P
Cutting conditions	B014		

Application	Precision finishing	Finishing	Medium cutting
	Grade	BX470	AH8005
Breaker Shape	T-CBN	HRF	HRM
Cutting conditions	B016		

Application	Precision finishing	Finishing
	Grade	BXM10
Breaker Shape	T-CBN	T-CBN
Cutting conditions	B018	

Reference pages: S-DDUNR/L-H: Insert → **B067** -, CBN → **B174** -, PCD → **B194** -

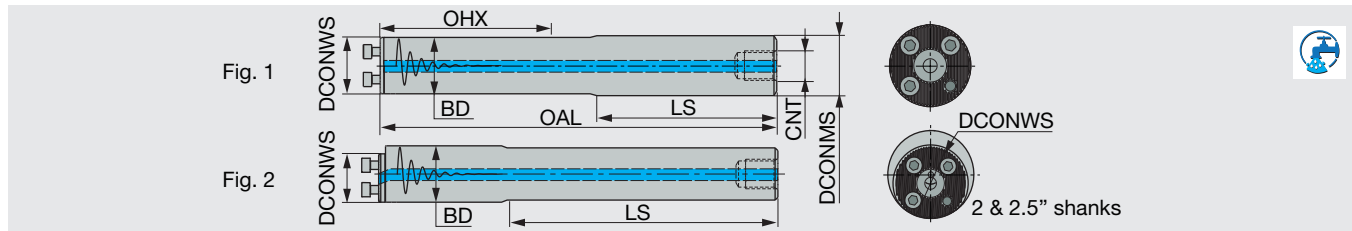

Inch	Material	DCONWS	DCONMS	BD	OAL	LS	OHX	CNT	Fig.
D.625-L6.14-7D-C	Steel	0.630	0.625	0.630	6.140	3.600	3.500	G1/8	1
G.625-L8.03-10D-E	Carbide	0.630	0.625	0.630	8.030	5.220	5.500	-	1
D.750-L7.87-7D-C	Steel	0.787	0.750	0.787	7.870	4.940	4.400	G1/4	1
G.750-L10.24-10D-E	Carbide	0.787	0.750	0.787	10.240	6.770	7.000	-	1
D1.00-L10.2-7D-C	Steel	0.984	1.000	0.984	10.200	6.830	6.200	G1/4	1
D1.00-L13.21-10D-C	Steel	0.984	1.000	0.984	13.210	8.650	9.200	G1/4	1
D1.25-L12.48-7D-C	Steel	1.260	1.250	1.260	12.480	7.370	7.500	G3/8	1
D1.25-L16.24-10D-C	Steel	1.260	1.250	1.260	16.240	9.670	11.200	G3/8	1
D1.50-L15.26-7D-C	Steel	1.575	1.500	1.575	15.260	9.130	9.200	G1/2	1
D1.50-L19.8-10D-C	Steel	1.575	1.500	1.575	19.800	13.350	13.700	G1/2	1
D2.00-L20.74-7D-C	Steel	1.575	2.000	2.000	20.740	-	12.700	G1/2	2
D2.00-L26.73-10D-C	Steel	1.575	2.000	2.000	26.730	-	18.700	G1/2	2
D2.50-L26.2-7D-C	Steel	1.575	2.500	2.500	26.200	-	16.200	G3/4	2
D2.50-L33.72-10D-C	Steel	1.575	2.500	2.500	33.720	-	23.700	G3/4	2

SPARE PARTS



Designation	Clamping screw	Wrench
D.625..., G.625...	SRM3X10DIN912	HW2.5
D.750..., G.750...	SRM3.5X10DIN912	HW2.5
D1.00...	SRM4X12DIN912	HW3.0
D1.25...	SRM5X12DIN912	HW4.0
D1.50..., D2.00... D2.50...	SRM6X16DIN912-12.9	HW5.0

Grade
Insert
Toolholder
Ext. Toolholder
Int. Toolholder
Threading
Grooving
Tool
Miniature Tool
Endmill
Drilling Tool
Tooling System
User's Guide
Index



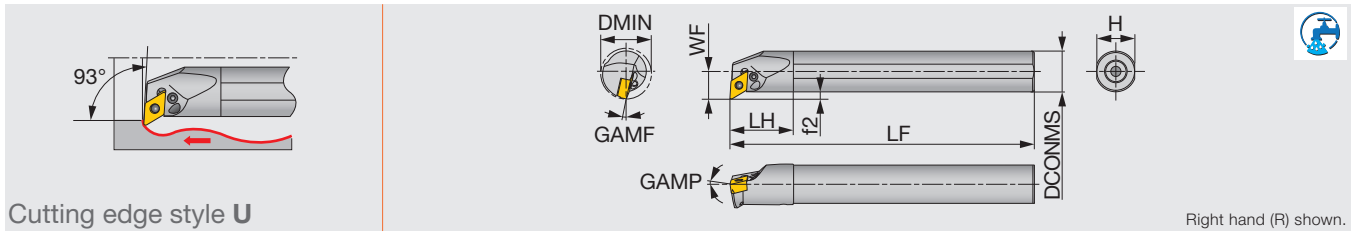

Metric	Material	DMIN	DCONMS	WF	LF	LH	H	f2	GAMP	GAMF	RE**	Insert	Torque
A20Q-PDUNR/L1104-D250	Steel	25	20	13	180	36	18	3	-6°	-14°	0.8	DN**1104...	1.7

Torque: Recommended clamping torque: N·m

**RE : Standard corner radius

Use right-hand toolholders (PDUNR**) with left-hand inserts (L); and left-hand toolholders (PDUNL**) with right-hand inserts (R).

Designation	Clamping screw	Wrench	Lever	Oil supply attachment*	Screw for oil hole*
A20Q-PDUNR/L1104-D250	LCS22A	P-2F	LCL33NL	EA-20	SSHM2.5-3

*Optional

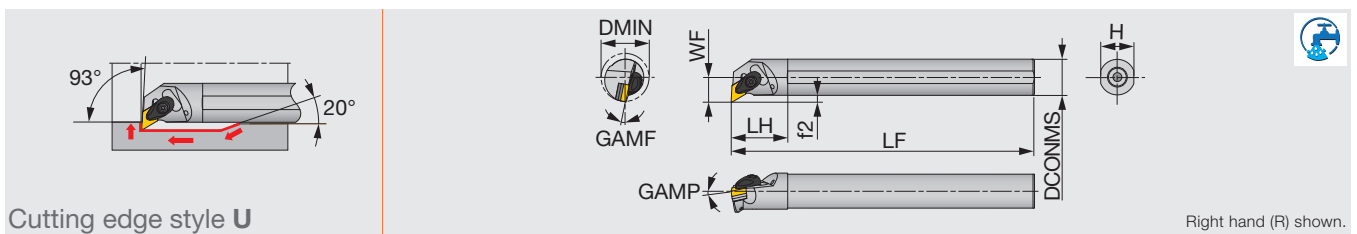

Inch	Material	DMIN	DCONMS	WF	LF	LH	H	f2	GAMP	GAMF	RE**	Insert	Torque
A16-ADUNR/L33-D20	Steel	1.250	1.000	0.672	12.000	1.750	0.906	0.172	-6°	-13°	0.031	DN**33...	2.21
A20-ADUNR/L33-D25	Steel	1.560	1.250	0.859	14.000	1.938	1.188	0.234	-6°	-11°	0.031	DN**33...	2.21

Torque: Recommended clamping torque: lbs·ft

**RE: Standard corner radius

Designation	Clamp	Clamp screw	Spring	Spring pin	Shim	Shim screw	Wrench
A**-ADUNR/L...	ACP3S-E	ACS-5W	BP-7	SP-2.5	ASD322	CSTB-3.5	T-15F

INSERT SELECTION

Application	Finishing	Medium cutting
	Grade	T9215
Breaker Shape	TSF	TM
Cutting conditions		B008

Application	Finishing	Medium cutting
	Grade	T6120
Breaker Shape	SS	SM
Cutting conditions		B010

Application	Medium cutting	
Grade	T515	
Breaker Shape	TM	
Cutting conditions		B012

Reference pages: A-PDUNR/L-Eco, A-ADUNR/L-Eco: Insert → **B067 -**, CBN → **B174 -**, PCD → **B194 -**

A-PDUNR/L

Lever-lock boring bar, for negative 55° rhombic inserts

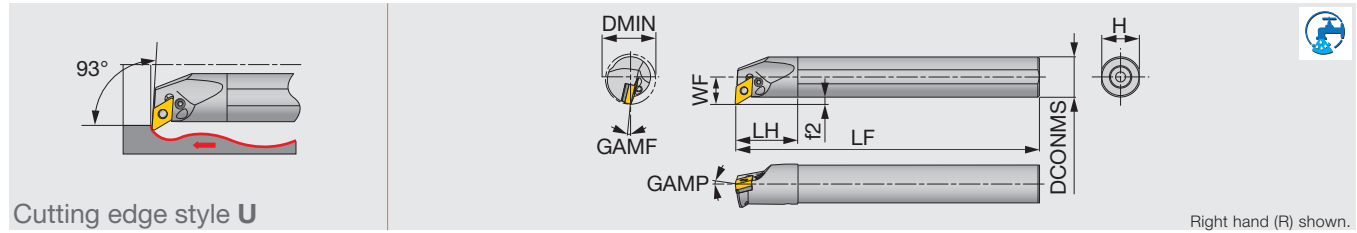

Metric	Material	DMIN	DCONMS	WF	LF	LH	H	f2	GAMP	GAMF	RE**	Insert	Torque
A20Q-PDUNR/L11-D250	Steel	25	20	13	180	36	18	3	-6°	-14°	0.8	DN**1104...	1.7
A25R-PDUNR/L11-D320	Steel	32	25	17	200	45	23	4.5	-6°	-12°	0.8	DN**1104...	2.7
A32S-PDUNR/L15-D400	Steel	40	32	22	250	50	30	6	-6°	-13°	0.8	DN**1504...	4.8
A40T-PDUNR/L15-D500	Steel	50	40	27	300	60	37	7	-6°	-10°	0.8	DN**1504...	4.8
A50U-PDUNR/L15-D630	Steel	63	50	35	350	65	47	10	-6°	-8°	0.8	DN**1504...	4.8
A32S-PDUNR/L1506-D400	Steel	40	32	22	250	50	30	6	-6°	-13°	0.8	DN**1506...	4.8
A40T-PDUNR/L1506-D500	Steel	50	40	27	300	60	37	7	-6°	-11°	0.8	DN**1506...	4.8
A50U-PDUNR/L1506-D630	Steel	63	50	35	350	65	47	10	-6°	-10°	0.8	DN**1506...	4.8

Torque: Recommended clamping torque: N·m **RE : Standard corner radius

SPARE PARTS

Designation	Shim	Clamping screw 1	Clamping screw 2	Wrench 1	Wrench 2	Spring pin	Lever	Oil supply attachment*	Screw for oil hole*
A20Q-PDUNR/L11-D250	-	LCS22A	-	P-2F	-	-	LCL33NL	EA-20	SSHM2.5-3
A25R-PDUNR/L11-D320	ELSD317BR/L	-	LCS3	-	P-2.5	LSP3	LCL33L	EA-25	SSHM3-4
A32S-PDUNR/L15-D400	LSD42BR/L	-	LCS4	-	P-3	LSP4	LCL4	EA-32	SSHM5-6
A40T-PDUNR/L15-D500	LSD42BR/L	-	LCS4	-	P-3	LSP4	LCL4	-	SSHM6-6
A50U-PDUNR/L15-D630	LSD42BR/L	-	LCS4	-	P-3	LSP4	LCL4	-	SSHM6-6
A32S-PDUNR/L1506-D400	ELSD42	-	ELCS4	-	P-3	LSP4S	LCL44	EA-20	SSHM5-6
A40T-PDUNR/L1506-D500	ELSD42	-	ELCS4	-	P-3	LSP4S	LCL44	-	SSHM6-6
A50U-PDUNR/L1506-D630	ELSD42	-	ELCS4	-	P-3	LSP4S	LCL44	-	SSHM6-6

*Optional

INSERT SELECTION

P	Application	Precision finishing	Finishing	Medium cutting	Medium to heavy cutting
	Grade	NS9530	GT9530	T9215	T9215
	Breaker Shape	TF	TSF	TM	TH
	Cutting conditions	B008			
M	Application	Finishing	Medium cutting	Medium to heavy cutting	
	Grade	T6120	T6130	T6130	
	Breaker Shape	SF	SM	SH	
	Cutting conditions	B010			
K	Application	Finishing	Medium cutting	Medium to heavy cutting	
	Grade	T515	T515	T515	
	Breaker Shape	All-round	All-round	All-round	
	Cutting conditions	B012			
N	Application	Precision finishing	Finishing	Medium cutting	
	Grade	DX120	DX140	TH10	
	Breaker Shape	T-DIA	with rake T-DIA	P	
	Cutting conditions	B014			
S	Application	Precision finishing	Finishing	Medium cutting	
	Grade	BX470	AH8005	AH8005	
	Breaker Shape	T-CBN	HRF	HRM	
	Cutting conditions	B016			
H	Application	Precision finishing	Finishing		
	Grade	BXM10	BXM20		
	Breaker Shape	T-CBN	T-CBN		
	Cutting conditions	B018			

Reference pages: A-PDUNR/L: Insert → B067 -, CBN → B174 -, PCD → B194 -

T-PDUNR

Lever-lock boring bar, for negative 55° rhombic inserts (Tsuppari-Ichiban)

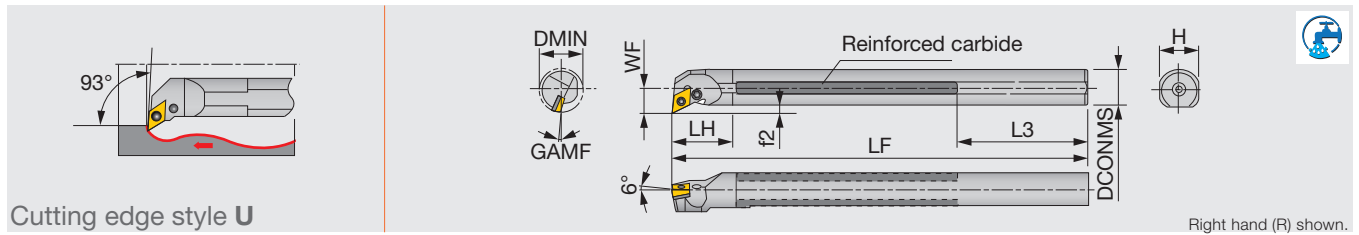

Metric	Material	DMIN	CNT	DCONMS	WF	LF	LH	L3	H	f2	GAMF	RE**	Insert
T32U-PDUNR15C	Reinforced	40	Rc1/2	32	22	350	50	103	30	6	-13°	0.8	DN**1504...
T40V-PDUNR15C	Reinforced	50	Rc1/2	40	27	400	55	88	37	7	-10°	0.8	DN**1504...
T50W-PDUNR15C	Reinforced	63	Rc1/2	50	35	450	65	63	47	10	-8°	0.8	DN**1504...

**RE : Standard corner radius

Use right-hand toolholders (R) with left-hand inserts (L); and left-hand toolholders (L) with right-hand inserts (R).

SPARE PARTS

Designation	Shim	Clamping screw	Wrench	Spring pin	Lever
T**-PDUNR15C	LSD42BR	LCS4	P-3	LSP4	LCL4

S-PDUNR/L

Lever-lock boring bar, for negative 55° rhombic inserts

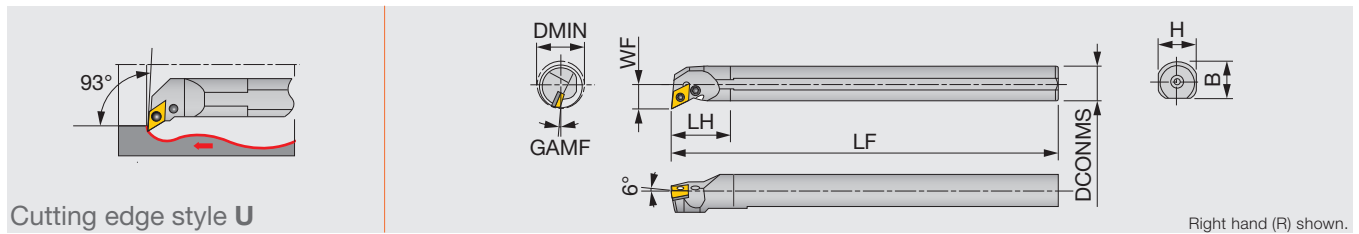

Metric	Material	DMIN	DCONMS	WF	LF	LH	H	B	GAMF	RE**	Insert
S20Q-PDUNR/L11	Steel	25	20	13	180	35	18	19	-14°	0.8	DN**1104...
S25R-PDUNR/L11	Steel	32	25	17	200	40	23	24	-12°	0.8	DN**1104...
S32S-PDUNR/L15	Steel	40	32	22	250	50	30	29.5	-13°	0.8	DN**1504...
S40T-PDUNR/L15	Steel	50	40	27	300	55	37	37.5	-10°	0.8	DN**1504...
S50U-PDUNR/L15	Steel	63	50	35	350	65	47	47.5	-8°	0.8	DN**1504...

**RE : Standard corner radius

Use right-hand toolholders (R) with left-hand inserts (L); and left-hand toolholders (L) with right-hand inserts (R).

SPARE PARTS

Designation	Shim	Clamping screw 1	Clamping screw 2	Wrench 1	Wrench 2	Spring pin	Lever
S20Q-PDUNR/L11	-	LCS22A	-	P-2F	-	-	LCL33NL
S25R-PDUNR11	ELSD317BR	-	LCS3	-	P-2.5	LSP3	LCL33L
S25R-PDUNL11	ELSD317BL	-	LCS3	-	P-2.5	LSP3	LCL33L
S32S-PDUNR15	LSD42BR	-	LCS4	-	P-3	LSP4	LCL4
S32S-PDUNL15	LSD42BL	-	LCS4	-	P-3	LSP4	LCL4
S40T-PDUNR15	LSD42BR	-	LCS4	-	P-3	LSP4	LCL4
S40T-PDUNL15	LSD42BL	-	LCS4	-	P-3	LSP4	LCL4
S50U-PDUNR15	LSD42BR	-	LCS4	-	P-3	LSP4	LCL4
S50U-PDUNL15	LSD42BL	-	LCS4	-	P-3	LSP4	LCL4

Reference pages: T-PDUNR, S-PDUNR/L: Insert → **B067 -**, CBN → **B174 -**, PCD → **B194 -**

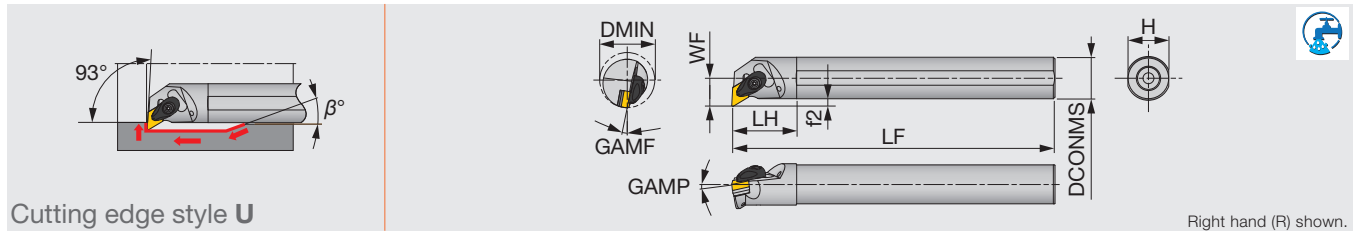

Inch	Material	DMIN	DCONMS	WF	LF	LH	H	f2	GAMP	GAMF	β°	RE**	Insert	Torque
A16-ADUNR/L4-D20	Steel	1.250	1.000	0.672	12.000	1.770	0.906	0.177	-6°	-13°	30	0.031	DN**43...	2.21
A20-ADUNR/L4-D25	Steel	1.500	1.250	0.859	14.000	1.960	1.180	0.236	-6°	-11°	20	0.031	DN**43...	2.21
A24-ADUNR/L4-D32	Steel	2.000	1.500	1.063	14.000	2.160	1.450	0.275	-6°	-8°	15	0.031	DN**43...	2.21

Torque: Recommended clamping torque: lbs-ft (*N-m) **RE : Standard corner radius

SPARE PARTS							
Designation	Clamp	Clamp screw	Spring	Spring pin	Shim	Shim screw	Wrench
A*-ADUNR/L4-D...	ACP4S	ACS-5W	BP-7	SP-2.5	ASD432	CSTB-3.5	T-15F

TUNG T^{URN}JET

C-PDUNL-CHP

Lever-lock boring bar with TungCap connection, with 93° approach angle, for negative 55° rhombic inserts, with high pressure coolant capability

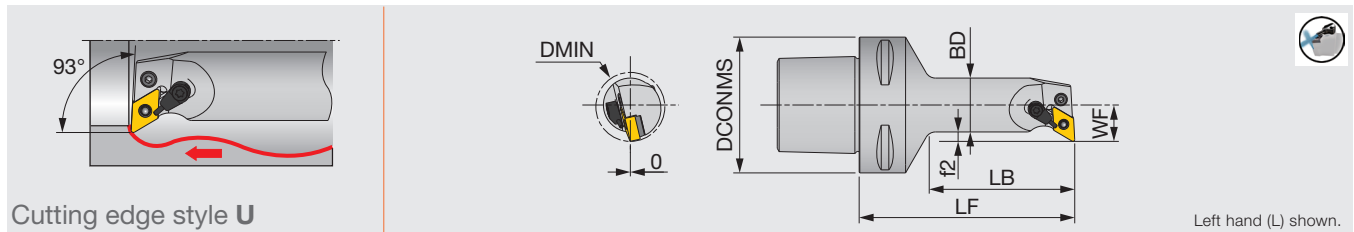

Metric	DMIN	DCONMS	BD	LF	LB	WF	f2	RE**	Insert
C6PDUNL17100-1104-CHP	32	63	25	100	67.5	17	4.5	0.8	DN**1104...

Applicable for 14 MPa coolant
**RE : Standard corner radius

SPARE PARTS						
Designation	Shim	Clamping screw	Coolant unit	Wrench	Spring pin	Lever
C6PDUNL17100-1104-CHP	ELSD317BL	LCS43	S-CU-CHP	P-2.5	LSP3	LCL33L

INSERT SELECTION

P	Application	Precision finishing	Finishing	Medium cutting	Medium to heavy cutting	M	Application	Finishing	Medium cutting	Medium to heavy cutting
	Grade	NS9530	GT9530	T9215	T9215		Grade	T6120	T6130	T6130
	Breaker Shape						Breaker Shape			
	Cutting conditions	B008					Cutting conditions	B010		
K	Application	Finishing	Medium cutting	Medium to heavy cutting	N	Application	Precision finishing	Finishing	Medium cutting	
	Grade	T515	T515	T515		Grade	DX120	DX140	TH10	
	Breaker Shape					Breaker Shape				
	Cutting conditions	B012				Cutting conditions	B014			
S	Application	Precision finishing	Finishing	Medium cutting	H	Application	Precision finishing	Finishing		
	Grade	BX470	AH8005	AH8005		Grade	BXM10	BXM20		
	Breaker Shape					Breaker Shape				
	Cutting conditions	B016				Cutting conditions	B018			

Reference pages: A-ADUNR/L, C-PDUNL-CHP Insert → B067 -, CBN → B174 -, PCD → B194 -

A/E-STUPR/L

Screw-on boring bar, for positive 60° triangular inserts

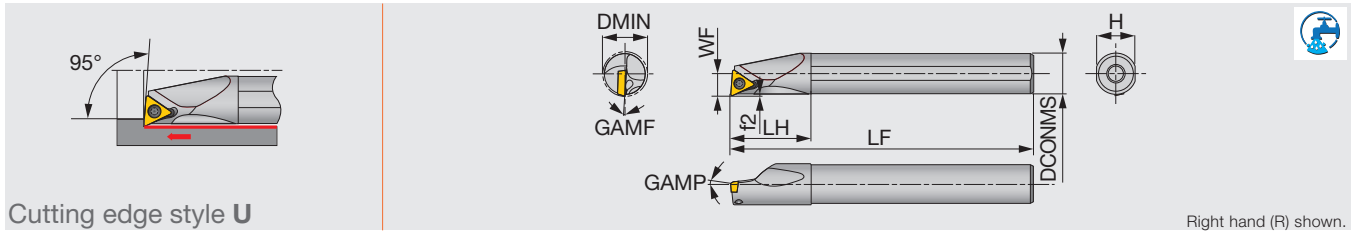

Cutting edge style U

Right hand (R) shown.

Inch	Material	DMIN	DCONMS	WF	LF	LH	H	f2	GAMP	GAMF	RE**	Insert	Torque
A05-STUPR/L7-D07	Steel	0.438	0.313	0.250	5.00	0.625	2.880	-	5°	-7°	0.016	TP**73...	0.66
A06-STUPR/L2-D08	Steel	0.500	0.375	0.281	5.00	0.750	0.350	-	5°	-5°	0.016	TP**21.5...	0.89
A08-STUPR/L2-D11	Steel	0.688	0.500	0.406	5.00	1.000	0.475	-	5°	-3°	0.016	TP**21.5...	0.89
A10-STUPR/L2-D14	Steel	0.875	0.625	0.531	7.00	1.250	0.600	-	5°	-2°	0.016	TP**21.5...	1.00
A10-STUPR/L2.5-D14	Steel	0.875	0.625	0.531	7.00	1.250	0.600	-	5°	-2°	0.016	TP**22...	1.00
A12-STUPR/L3-D16	Steel	1.000	0.750	0.594	7.00	1.437	0.725	-	5°	-2°	0.032	TP**32.5...	1.00
A16-STUPR/L3-D20	Steel	1.250	1.000	0.688	7.00	1.750	0.975	-	5°	0°	0.032	TP**32.5...	2.20
E05-STUPR7-D07	Carbide	0.438	0.313	0.250	5.00	0.625	2.880	-	5°	-7°	0.016	TP**73...	0.66
E06-STUPR2-D08	Carbide	0.500	0.375	0.281	5.00	0.750	0.350	-	5°	-5°	0.016	TP**21.5...	0.89
E08-STUPR2-D11	Carbide	0.688	0.500	0.406	5.00	1.000	0.475	-	5°	-3°	0.016	TP**21.5...	0.89
E10-STUPR2.5-D14	Carbide	0.875	0.625	0.531	7.00	1.250	0.600	-	5°	-2°	0.016	TP**22...	1.00

Torque: Recommended clamping torque: lbs-ft

**RE : Standard corner radius

Use right-hand toolholders (STUPR**) with left-hand inserts (L); and left-hand toolholders (STUPL**) with right-hand inserts (R).

SPARE PARTS



Designation	Clamping screw	Wrench
A05-STUPR/L7-D07	CSTB-2.2S	T-7F
A06-STUPR/L2-D08	CSTB-2.5S	T-8F
A08-STUPR/L2-D11	CSTB-2.5B	T-8F
A10-STUPR/L2-D14	CSTB-2.5	T-8F
A10-STUPR/L2.5-D14	CSTB-2.5	T-8F
A12-STUPR/L3-D16	CSTB-4M	T-15F
A16-STUPR/L3-D20	CSTB-4M	T-15F
E05-STUPR7-D07	CSTB-2.2S	T-7F
E06-STUPR2-D08	CSTB-2.5S	T-8F
E08-STUPR2-D11	CSTB-2.5B	T-8F
E10-STUPR2.5-D14	CSTB-3	T-9F

INSERT SELECTION

P

Application	Finishing	Finishing to medium cutting	Medium cutting
Grade	SH725	T9215	T9215
Breaker Shape	JS	PS	PM
Cutting conditions	B020		

M

Application	Finishing	Finishing to medium cutting	Medium cutting
Grade	SH725	T9215	T9215
Breaker Shape	JS	PS	PM
Cutting conditions	B022		

K

Application	Finishing to medium cutting
Grade	T515
Breaker Shape	CM
Cutting conditions	B024

N

Application	Precision finishing
Grade	DX120
Breaker Shape	T-DIA with rake
Cutting conditions	B026

S

Application	Precision finishing
Grade	BX470
Breaker Shape	T-CBN
Cutting conditions	B028

H

Application	Precision finishing	Finishing
Grade	BXM10	BXM20
Breaker Shape	T-CBN	T-CBN
Cutting conditions	B030	

Reference pages: A/E-STUPR/L: Insert → B144 -, CBN → B187 -, PCD → B198

A/E-STUPR/L

Screw-on boring bar, for positive 60° triangular inserts

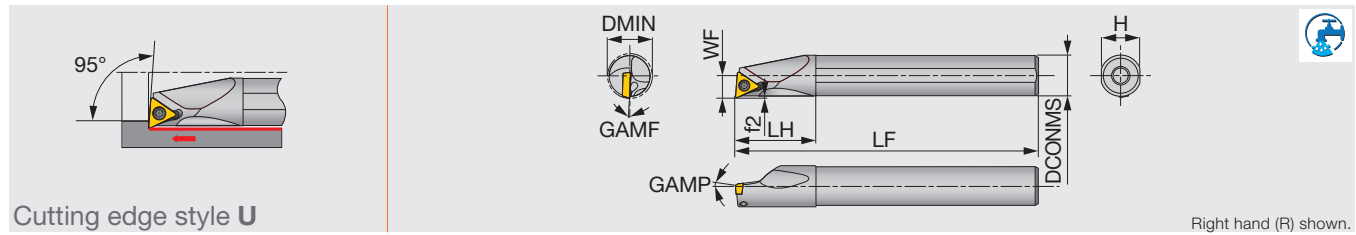

Cutting edge style U

Right hand (R) shown.

Metric	Material	DMIN	DCONMS	WF	LF	LH	H	f2	GAMP	GAMP	RE**	Insert	Torque
A07G-STUPR/L07-D080	Steel	8	7	4	90	12	6.75	0.4	5°	-10°	0.4	TP**0701...	0.9
A08H-STUPR/L07-D080	Steel	8	8	4	100	19.5	7.5	0.5	5°	-10°	0.4	TP**0701...	0.9
A08H-STUPR/L09-D100	Steel	10	8	5.5	100	16	7.5	0.6	5°	-8°	0.4	TP**0902... ⁽¹⁾	0.9
A10F-STUPR1102-D120	Steel	12	10	6.5	80	20	9	1.4	5°	-6°	0.4	TP**1102... ⁽¹⁾	1.2
A10K-STUPR/L1102-D120	Steel	12	10	6.5	125	20	9	0.7	5°	-6°	0.4	TP**1102... ⁽¹⁾	1.2
A10K-STUPR/L1103-D120	Steel	12	10	6.5	125	20	9	0.6	5°	-10°	0.4	TP**1103... ⁽¹⁾	1.4
A12H-STUPR1102-D140	Steel	14	12	7	100	24	11	0.8	5°	-4°	0.4	TP**1102... ⁽¹⁾	1.2
A12M-STUPR/L1102-D140	Steel	14	12	7	150	24	11	0.8	5°	-4°	0.4	TP**1102... ⁽¹⁾	1.2
A12M-STUPR/L1103-D140	Steel	14	12	7	150	24	11	0.6	5°	-6°	0.4	TP**1103... ⁽¹⁾	1.4
A12H-STUPR1102-D160	Steel	16	12	9	100	24	11	0.6	5°	-3°	0.4	TP**1102... ⁽¹⁾	1.2
A12M-STUPR/L1102-D160	Steel	16	12	9	150	24	11	0.6	5°	-3°	0.4	TP**1102... ⁽¹⁾	1.2
A16K-STUPR13-D180	Steel	18	16	9	125	32	15	0.8	5°	-3°	0.4	TP**1303... ⁽¹⁾	1.4
A16Q-STUPR/L1103-D180	Steel	18	16	9	180	32	15	0.8	5°	-4°	0.4	TP**1103... ⁽¹⁾	1.4
A16Q-STUPR/L13-D180	Steel	18	16	9	180	32	15	0.8	5°	-3°	0.4	TP**1303... ⁽¹⁾	1.4
A16K-STUPR13-D200	Steel	20	16	11	125	32	15	0.6	5°	-3°	0.4	TP**1303... ⁽¹⁾	1.4
A16Q-STUPR/L13-D200	Steel	20	16	11	180	32	15	0.6	5°	-3°	0.4	TP**1303... ⁽¹⁾	1.4
A20R-STUPR/L1103-D220	Steel	22	20	11	200	36	18	0.7	5°	-2°	0.4	TP**1103... ⁽¹⁾	1.4
A20R-STUPR/L13-D220	Steel	22	20	11	200	36	18	0.7	5°	-2°	0.4	TP**1303... ⁽¹⁾	1.4
A25S-STUPR/L16-D270	Steel	27	25	13.5	250	45	23	0.5	5°	-1°	0.8	TP**16T3... ⁽¹⁾	3
A32T-STUPR/L16-D340	Steel	34	32	17	300	50	30	0.7	5°	0°	0.8	TP**16T3...	3
E07H-STUPR/L07-D080	Carbide	8	7	4	100	14	6.75	0.3	5°	-10°	0.4	TP**0701... ⁽¹⁾	0.9
E08G-STUPR07-D080	Carbide	8	8	4	90	44.5	7.5	0.5	5°	-10°	0.4	TP**0701...	0.9
E08K-STUPR/L07-D080	Carbide	8	8	4	125	44.5	7.5	0.5	5°	-10°	0.4	TP**0701... ⁽¹⁾	0.9
E08G-STUPR09-D100	Carbide	10	8	5.5	90	22	7	0.6	5°	-8°	0.4	TP**0902... ⁽¹⁾	0.9
E08K-STUPR/L09-D100	Carbide	10	8	5.5	125	22	7	0.6	5°	-8°	0.4	TP**0902... ⁽¹⁾	0.9
E10F-STUPR1102-D120	Carbide	12	10	6.5	80	25	9	0.5	5°	-6°	0.4	TP**1102... ⁽¹⁾	1.2
E10H-STUPR1102-D120	Carbide	12	10	6.5	100	25	9	0.6	5°	-6°	0.4	TP**1102... ⁽¹⁾	1.2
E10M-STUPR/L1102-D120	Carbide	12	10	6.5	150	25	9	0.6	5°	-6°	0.4	TP**1102... ⁽¹⁾	1.2
E10M-STUPR/L1103-D120	Carbide	12	10	6.5	150	25	9	0.7	5°	-10°	0.4	TP**1103... ⁽¹⁾	1.4
E12G-STUPR1102-D140	Carbide	14	12	7	90	27	11	0.8	5°	-4°	0.4	TP**1102... ⁽¹⁾	1.2
E12J-STUPR1102-D140	Carbide	14	12	7	110	27	11	0.8	5°	-4°	0.4	TP**1102... ⁽¹⁾	1.2
E12Q-STUPR/L1102-D140	Carbide	14	12	7	180	27	11	0.8	5°	-4°	0.4	TP**1102... ⁽¹⁾	1.2
E12Q-STUPR/L1103-D140	Carbide	14	12	7	180	27	11	0.7	5°	-6°	0.4	TP**1103... ⁽¹⁾	1.4
E12G-STUPR1102-D160	Carbide	16	12	9	90	27	11	0.6	5°	-3°	0.4	TP**1102... ⁽¹⁾	1.2
E12J-STUPR1102-D160	Carbide	16	12	9	110	27	11	0.6	5°	-3°	0.4	TP**1102... ⁽¹⁾	1.2
E12Q-STUPR/L1102-D160	Carbide	16	12	9	180	27	11	0.6	5°	-3°	0.4	TP**1102... ⁽¹⁾	1.2
E16H-STUPR13-D180	Carbide	18	16	9	100	32	15	0.9	5°	-3°	0.4	TP**1303... ⁽¹⁾	1.4
E16R-STUPR/L1103-D180	Carbide	18	16	9	200	32	15	0.8	5°	-3°	0.4	TP**1103... ⁽¹⁾	1.4
E16L-STUPR13-D180	Carbide	18	16	9	130	32	15	0.6	5°	-3°	0.4	TP**1303... ⁽¹⁾	1.4
E16R-STUPR/L13-D180	Carbide	18	16	9	200	32	15	0.6	5°	-3°	0.4	TP**1303... ⁽¹⁾	1.4
E16H-STUPR13-D200	Carbide	20	16	11	100	32	15	0.6	5°	-3°	0.4	TP**1303... ⁽¹⁾	1.4
E16L-STUPR13-D200	Carbide	20	16	11	130	32	15	0.6	5°	-3°	0.4	TP**1303... ⁽¹⁾	1.4
E16R-STUPR13-D200	Carbide	20	16	11	200	32	15	0.6	5°	-3°	0.4	TP**1303... ⁽¹⁾	1.4
E20S-STUPR1103-D220	Carbide	22	20	11	250	36	18	0.7	5°	-2°	0.4	TP**1103... ⁽¹⁾	1.4
E20S-STUPR13-D220	Carbide	22	20	11	250	36	18	0.6	5°	-2°	0.4	TP**1303... ⁽¹⁾	1.4
E25T-STUPR16-D270	Carbide	27	25	13.5	300	45	23	0.5	5°	-1°	0.8	TP**16T3...	3

SPARE PARTS



Designation	Clamping screw	Wrench
A/E07*-STUPR/L07-...	CSTB-2.2L038	T-7F
A/E08*-STUPR/L07-...	CSTB-2.2L038	T-7F
A/E08*-STUPR/L09-...	CSTB-2.2L038	T-7F
A/E10*-STUPR/L1102-...	CSTB-2.5S	T-8F
A/E10*-STUPR/L1103-...	CSTB-3L050	T-9F
A/E12*-STUPR/L1102-...	CSTB-2.5B	T-8F
A/E12*-STUPR/L1103-...	CSTB-3L050	T-9F
A/E16*-STUPR/L1103-...	CSTB-3S	T-9F
A/E16*-STUPR/L13-...	CSTB-3S	T-9F
A/E20*-STUPR/L1103-...	CSTB-3S	T-9F
A/E20*-STUPR/L13-...	CSTB-3	T-9F
A/E25*-STUPR/L16-...	CSTB-4M	T-15F
A32*-STUPR/L16-...	CSTB-4M	T-15F

Torque: Recommended clamping torque: N·m

**RE : Standard corner radius

Use right-hand toolholders (STUPR**) with left-hand inserts (L); and left-hand toolholders (STUPL**) with right-hand inserts (R).

(1) TPGH, TPGM, and TPGA inserts cannot be used.

Reference pages: A/E-STUPR/L: Insert → **B144 -**,
CBN → **B187 -**, PCD → **B198**

T-STUPR/L

Screw-on boring bar, for positive 60° triangular inserts (Tsuppari-Ichiban)

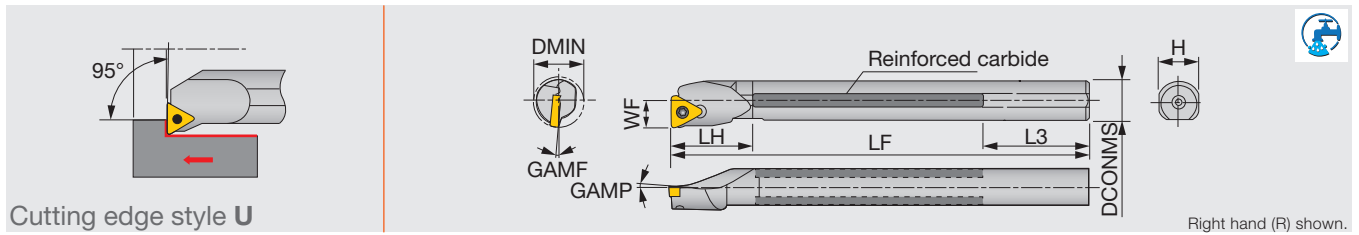

Metric	Material	DMIN	CNT***	DCONMS	WF	LF	LH	L3	H	GAMP	GAMF	RE**	Insert	Torque
T12M-STUPR11-D14	Reinforced	14	-	12	7	150	24	59	11	5°	-4°	0.4	TP**1102...	1.2
T12M-STUPR/L11	Reinforced	16	-	12	9	150	25	58	11	5°	-4°	0.4	TP**1102...	1.2
T16Q-STUPR13-D18	Reinforced	18	-	16	9	180	30	59	15	5°	-3.5°	0.4	TP**1303...	1.4
T16Q-STUPR/L13	Reinforced	20	-	16	11	180	30	59	15	5°	-3°	0.4	TP**1303...	1.4
T20R-STUPR13C-D22	Reinforced	22	Rc1/4	20	11	200	35	49	18	5°	-2°	0.4	TP**1303...	1.4
T20R-STUPR/L13	Reinforced	24	-	20	13	200	40	49	18	5°	-2°	0.4	TP**1303...	1.4
T25S-STUPR16C-D27	Reinforced	27	Rc1/4	25	13.5	250	40	64	23	5°	-1°	0.8	TP**16T3...	3
T25S-STUPR/L16	Reinforced	31	-	25	17	250	45	64	23	5°	0°	0.8	TP**16T3...	3

Torque: Recommended clamping torque: N·m

**RE : Standard corner radius

***CNT : Threading size at the tail port

Use right-hand toolholders (STUPR**) with left-hand inserts (L); and left-hand toolholders (STUPL**) with right-hand inserts (R).

SPARE PARTS

Designation	Clamping screw	Wrench
T12M-STUPR11-D14	CSTB-2.5B	T-8F
T12M-STUPR/L11	CSTB-2.5	T-8F
T16Q-STUPR13-D18	CSTB-3S	T-9F
T16Q-STUPR/L13	CSTB-3	T-9F
T20R-STUPR13C-D22	CSTB-3S	T-9F
T20R-STUPR/L13	CSTB-3	T-9F
T25S-STUPR/L16...	CSTB-4S	T-15F

INSERT SELECTION

P

Application	Precision finishing	Finishing	Finishing to medium cutting	Medium cutting
Grade	NS9530	NS9530	T9215	T9215
Breaker Shape	01	PSS	PS	PM
Cutting conditions	B020			

M

Application	Finishing	Finishing to medium cutting	Medium cutting
Grade	AH725	AH630	T6130
Breaker Shape	PSF	PSS	PM
Cutting conditions	B022		

K

Application	Finishing to medium cutting
Grade	T515
Breaker Shape	CM
Cutting conditions	B024

N

Application	Finishing
Grade	DX140
Breaker Shape	T-DIA
Cutting conditions	B026

H

Application	Precision finishing	Finishing
Grade	BXM10	BXM20
Breaker Shape	T-CBN	T-CBN
Cutting conditions	B030	

Reference pages: T-STUPR/L: Insert → B144 -, CBN → B187 -, PCD → B198

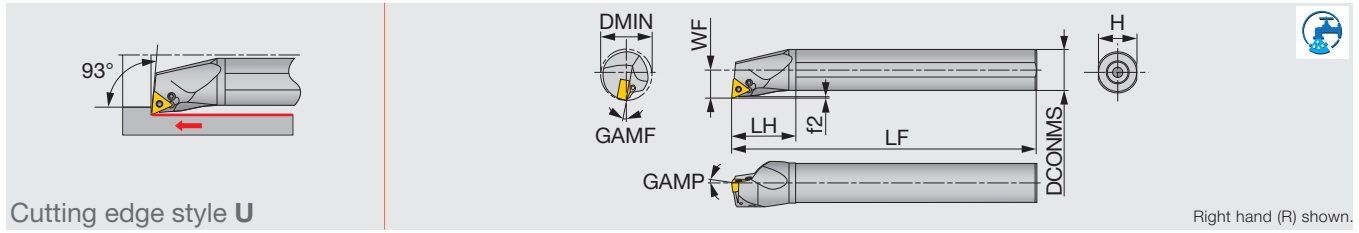

Metric	Material	DMIN	DCONMS	WF	LF	LH	H	f2	GAMP	GAMP	RE**	Insert	Torque
A25R-PTUNR/L1104-D320	Steel	32	25	17	200	45	23	1.22	-6°	-12°	0.8	TN**1104...	2
A32S-PTUNR/L1104-D400	Steel	40	32	22	250	50	30	1.16	-6°	-10°	0.8	TN**1104...	2

Torque: Recommended clamping torque: N·m

**RE: Standard corner radius

SPARE PARTS

Designation	Clamping screw	Wrench	Lever	Oil supply attachment*	Screw for oil hole*
A25R-PTUNR/L1104-D320	LCS23A	P-2.5	LCL23	EA-25	SSHM4-5
A32S-PTUNR/L1104-D400	LCS23A	P-2.5	LCL23	EA-32	SSHM4-5

*Optional

INSERT SELECTION

P	Application	Finishing	Medium cutting
	Grade	T9215	T9215
Breaker Shape	TSF	TM	
Cutting conditions	B008		

M	Application	Finishing	Medium cutting
	Grade	T6120	T6130
Breaker Shape	SS	SM	
Cutting conditions	B010		

A-PTUNR/L

Lever-lock boring bar, for negative 60° triangular inserts

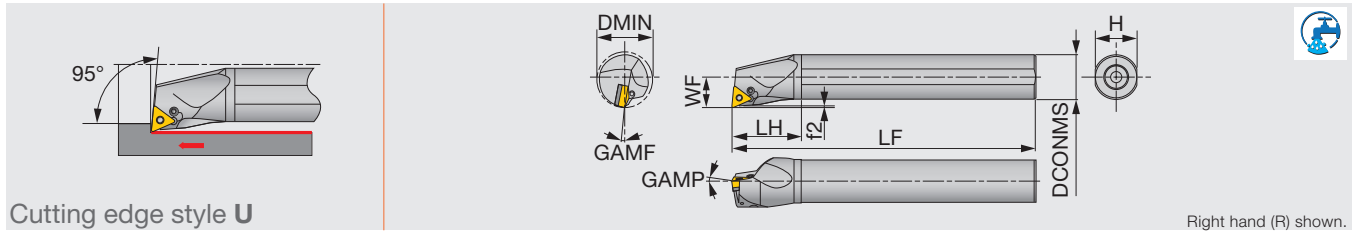

Cutting edge style U

Right hand (R) shown.

Metric	Material	DMIN	DCONMS	WF	LF	LH	H	f2	GAMP	GAMF	RE**	Insert	Torque
A16M-PTUNR/L11-D200	Steel	20	16	11	150	32	15	1	-6°	-14°	0.4	TN**1103...	1.7
A20Q-PTUNR/L11-D250	Steel	25	20	13	180	36	18	1	-6°	-12°	0.4	TN**1103...	1.7
A25R-PTUNR/L16-D320	Steel	32	25	17	200	45	23	1.4	-6°	-12°	0.8	TN**1604...	2.7
A32S-PTUNR/L16-D400	Steel	40	32	22	250	50	30	1.3	-6°	-10°	0.8	TN**1604...	2.7

Torque: Recommended clamping torque: N·m

**RE : Standard corner radius

*The hole specification of applicable inserts conforms to ISO standard.

Toolholder length may not conform to ISO standard.

Use right-hand toolholders (PTUNR**) with left-hand inserts (L); and left-hand toolholders (PTUNL**) with right-hand inserts (R).

SPARE PARTS

Designation	Shim	Clamping screw 1	Clamping screw 2	Wrench 1	Wrench 2	Spring pin	Lever	Oil supply attachment*	Screw for oil hole*
A16M-PTUNR/L11-D200	-	LCS22A	-	P-2F	-	-	LCL22N	-	SSHM3-4
A20Q-PTUNR/L11-D250	-	LCS22A	-	P-2F	-	-	LCL22N	EA-20	SSHM3-4
A25R-PTUNR/L16-D320	ELST317BR/L	-	LCS3	-	P-2.5	LSP3	LCL33	EA-25	SSHM4-5
A32S-PTUNR/L16-D400	LST317BR/L	-	LCS3	-	P-2.5	LSP3	LCL3	EA-32	SSHM4-5

*Optional

T-PTUNR

Lever-lock boring bar, for negative 60° triangular inserts (Tsuppari-Ichiban)

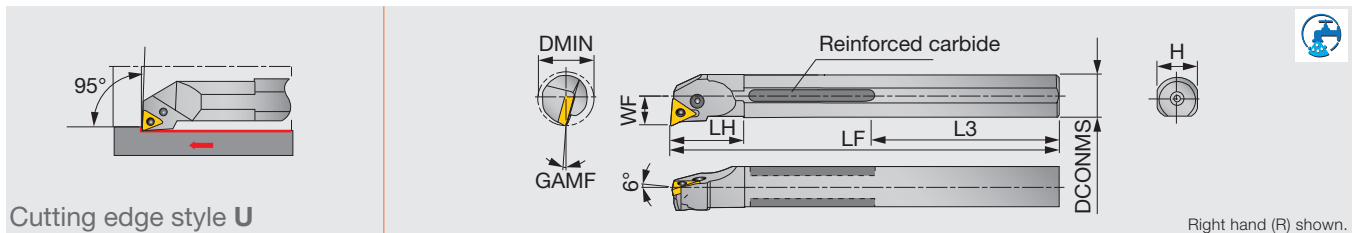

Cutting edge style U

Right hand (R) shown.

Metric	Material	DMIN	CNT***	DCONMS	WF	LF	LH	L3	H	GAMF	RE**	Insert	Torque
T16Q-PTUNR11	Reinforced	20	-	16	11	180	27	59	15	-14°	0.4	TN**1103...	1.7
T20R-PTUNR11C	Reinforced	25	Rc1/4	20	13	200	35	49	18	-12°	0.4	TN**1103...	1.7
T25S-PTUNR16C	Reinforced	32	Rc1/4	25	17	250	40	64	23	-12°	0.8	TN**1604...	2.7
T32U-PTUNR16C	Reinforced	40	Rc1/2	32	22	350	50	103	30	-10°	0.8	TN**1604...	2.7
T40V-PTUNR16C	Reinforced	50	Rc1/2	40	27	400	55	88	37	-10°	0.8	TN**1604...	2.7
T50W-PTUNR16C	Reinforced	63	Rc1/2	50	35	450	65	63	47	-8°	0.8	TN**1604...	2.7

Torque: Recommended clamping torque: N·m

**RE : Standard corner radius

***CNT : Threading size at the tail port

*The hole specification of applicable inserts conforms to ISO standard.

Toolholder length may not conform to ISO standard.

Use right-hand toolholders (R) with left-hand inserts (L); and left-hand toolholders (L) with right-hand inserts (R).

SPARE PARTS

Designation	Shim	Clamping screw 1	Clamping screw 2	Wrench 1	Wrench 2	Spring pin	Lever
T**-PTUNR11...	-	LCS22A	-	P-2F	-	-	LCL22N
T25S-PTUNR16C	ELST317BR	-	LCS3	-	P-2.5	LSP3	LCL33
T**-PTUNR16C	LST317BR	-	LCS3	-	P-2.5	LSP3	LCL3

Reference pages: A-PTUNR/L, T-PTUNR: Insert → **B086 -**, CBN → **B178 -**, PCD → **B194 -**

A/S-PTUNR/L

Lever-lock boring bar, for negative 60° triangular inserts

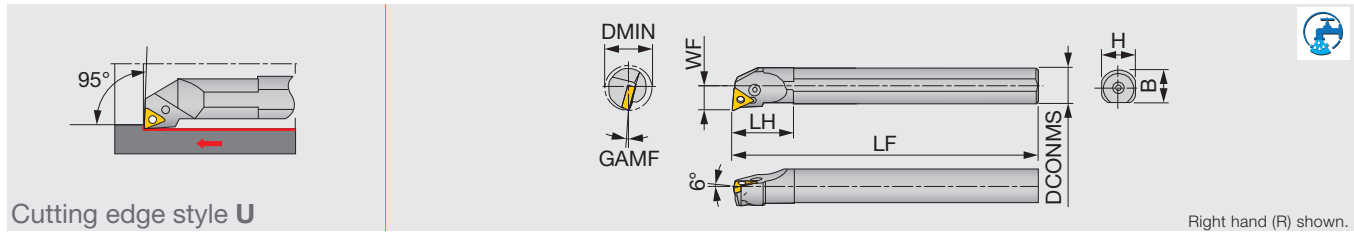

Metric	Material	DMIN	DCONMS	WF	LF	LH	H	B	GAMF	RE**	Insert	Torque
S16M-PTUNR/L11	Steel	20	16	11	150	30	15	15.5	-14°	0.4	TN**1103...	1.7
S20Q-PTUNR/L11	Steel	25	20	13	180	35	18	19	-12°	0.4	TN**1103...	1.7
S25R-PTUNR/L16	Steel	32	25	17	200	40	23	24	-12°	0.8	TN**1604...	2.7
A32S-PTUNR/L16	Steel	40	32	22	250	50	30	29.5	-12°	0.8	TN**1604...	2.7

Torque: Recommended clamping torque: N·m

**RE : Standard corner radius

*The hole specification of applicable inserts conforms to ISO standard.

Toolholder length may not conform to ISO standard.

Use right-hand toolholders (R) with left-hand inserts (L); and left-hand toolholders (L) with right-hand inserts (R).

SPARE PARTS								
Designation	Shim	Clamping screw 1	Clamping screw 2	Wrench 1	Wrench 2	Spring pin	Lever	Oil supply attachment*
S**-PTUNR/L11	-	LCS22A	-	P-2F	-	-	LCL22N	-
S25R-PTUNR16	ELST317BR	-	LCS3	-	P-2.5	LSP3	LCL33	-
S25R-PTUNL16	ELST317BL	-	LCS3	-	P-2.5	LSP3	LCL33	-
A32S-PTUNR16	LST317BR	-	LCS3	-	P-2.5	LSP3	LCL3	EA-32
A32S-PTUNL16	LST317BL	-	LCS3	-	P-2.5	LSP3	LCL3	EA-32

*Optional

INSERT SELECTION

P	Application	Precision finishing	Finishing	Medium cutting	Medium to heavy cutting
	Grade	NS9530	GT9530	T9215	T9215
	Breaker Shape				
	Cutting conditions	B008			

M	Application	Finishing	Medium cutting
	Grade	T6120	T6130
	Breaker Shape		
	Cutting conditions	B010	

K	Application	Finishing	Medium cutting	Medium to heavy cutting
	Grade	T515	T515	T515
	Breaker Shape			
	Cutting conditions	B012		

N	Application	Precision finishing	Finishing	Medium cutting
	Grade	DX120	DX140	TH10
	Breaker Shape			
	Cutting conditions	B014		

S	Application	Precision finishing	Finishing	Medium cutting
	Grade	BX470	AH8005	AH8005
	Breaker Shape			
	Cutting conditions	B016		

H	Application	Precision finishing	Finishing
	Grade	BXM10	BXM20
	Breaker Shape		
	Cutting conditions	B018	

Reference pages: A/S-PTUNR/L: Insert → B086 -, CBN → B178 -, PCD → B194 -

Grade
Insert
Toolholder
Ext. Toolholder
Int. Toolholder
Threading
Grooving
Miniature Tool
Endmill
Drilling Tool
Tooling System
User's Guide
Index



STREAMJETBAR

A/E-SVUBR/L

Screw-on boring bar, for positive 35° rhombic inserts

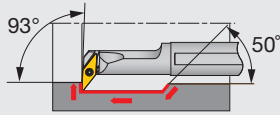

Cutting edge style U

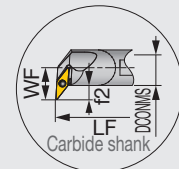
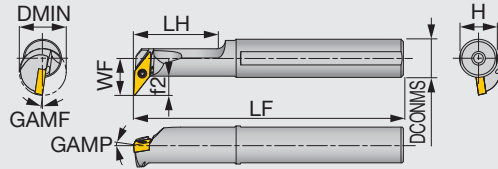

Right hand (R) shown.

Inch	Material	DMIN	DCONMS	WF	LF	LH	H	f2	GAMP	GAMF	RE**	Insert	Torque
A12-SVUBR2-D16	Steel	1.000	0.750	0.594	10.000	1.425	0.725	0.218	-0°	-6°	0.016	VB**22...	0.89

Metric	Material	DMIN	DCONMS	WF	LF	LH	H	f2	GAMP	GAMF	RE**	Insert	Torque*
A16Q-SVUBR/L11-D200	Steel	20	16	15.5	180	35	15	8	0°	-8°	0.4	VB**1103...	1.2
A20R-SVUBR/L11-D250	Steel	25	20	17.5	200	40	19	8	0°	-7°	0.4	VB**1103...	1.2
A25S-SVUBR/L16-D320	Steel	32	25	20.5	250	50	23	8.5	0°	-6°	0.8	VB**1604...	3
E16R-SVUBR/L11-D245	Carbide	24.5	16	16	200	-	15	8	0°	-8°	0.4	VB**1103...	1.2
E20S-SVUBR/L11-D285	Carbide	28.5	20	18	250	-	19	8	0°	-7°	0.4	VB**1103...	1.2
E25T-SVUBR/L16-D340	Carbide	34	25	21	300	-	23	8.5	0°	-6°	0.8	VB**1604...	3

Torque: Recommended clamping torque: lbs-ft (*N-m)

**RE : Standard corner radius

Use right-hand toolholders (SVUBR**) with left-hand inserts (L); and left-hand toolholders (SVUBL**) with right-hand inserts (R).

SPARE PARTS



Designation	Clamping screw	Wrench
A12-SVUBR2-D16	CSTB-2.5	T-8F
A**-SVUBR/L11-D2*0	CSTB-2.5	T-8F
A25S-SVUBR/L16-D320	CSTB-3.5	T-15F
E**-SVUBR/L11-D2*5	CSTB-2.5	T-8F
E25T-SVUBR/L16-D340	CSTB-3.5	T-15F

INSERT SELECTION

P	Application	Finishing	Finishing to medium cutting
	Grade	SH725	T9215
Breaker Shape	JS	PS	
Cutting conditions		B020	

M	Application	Finishing	Finishing to medium cutting
	Grade	SH725	T9215
Breaker Shape	JS	PS	
Cutting conditions		B022	

K	Application	Finishing to medium cutting
	Grade	T515
Breaker Shape	CM	
Cutting conditions		B024

H	Application	Precision finishing	Finishing
	Grade	BXM10	BXM20
Breaker Shape	T-CBN	T-CBN	
Cutting conditions		B030	

Reference pages: A/E-SVUBR/L: Insert → **B152 -**, CBN → **B191**

T-SVUBR

Screw-on boring bar, for positive 35° rhombic inserts (Tsuppari-Ichiban)

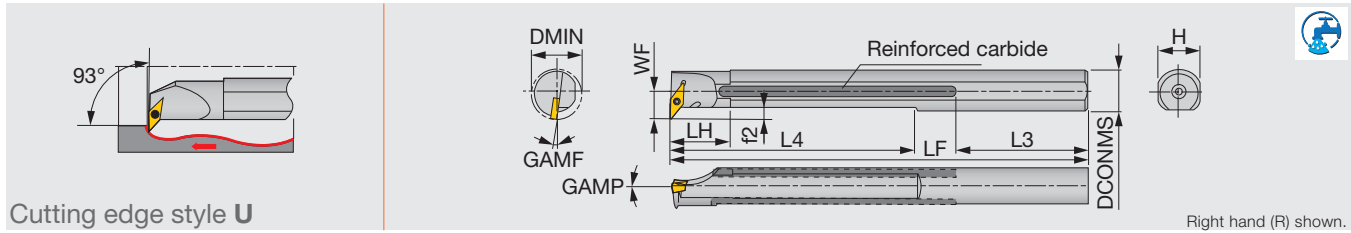

Metric	Material	DMIN	CNT***	DCONMS	WF	LF	LH	L3	L4	H	f2	GAMP	GAMF	RE**	Insert	Torque
T20R-SVUBR11C	Reinforced	25	Rc1/4	20	14	200	30	59	121	18	4	0°	-8°	0.4	VB**1103...	1.2

Torque: Recommended clamping torque: N·m
 **RE : Standard corner radius
 ***CNT : Threading size at the tail port
 Use right-hand toolholders (SVUBR**) with left-hand inserts (L).

SPARE PARTS

Designation	Clamping screw	Wrench
T20R-SVUBR11C	CSTB-2.5	T-8F

INSERT SELECTION

P

Application	Finishing	Finishing to medium cutting
Grade	NS9530	T9215
Breaker Shape	PSS	PS
Cutting conditions	B020	

M

Application	Finishing	Finishing to medium cutting
Grade	AH725	AH630
Breaker Shape	PSF	PSS
Cutting conditions	B022	

K

Application	Finishing to medium cutting
Grade	T515
Breaker Shape	CM
Cutting conditions	B024

S

Application	Finishing	Finishing to medium cutting
Grade	AH8015	AH8015
Breaker Shape	PSS	PS
Cutting conditions	B028	

H

Application	Precision finishing	Finishing
Grade	BXM10	BXM20
Breaker Shape	T-CBN	T-CBN
Cutting conditions	B030	

Reference pages: T-SVUBR: Insert → B152 -, CBN → B191



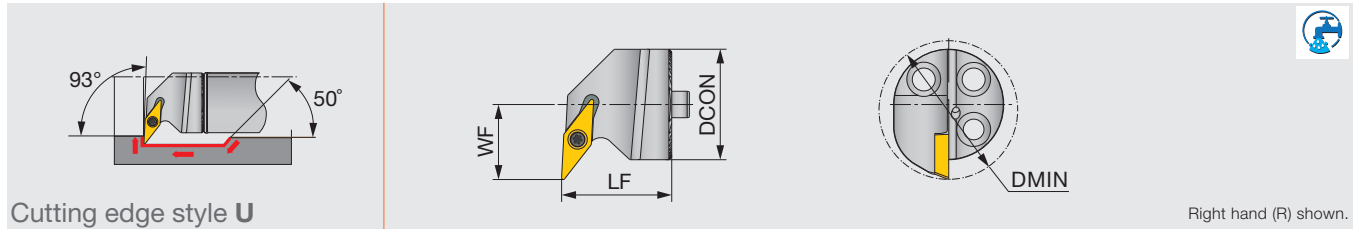

Cutting edge style U

Right hand (R) shown.

Inch	DMIN	DCON	WF	LF	Shank size	Insert
S20-SVUCR/L11-H	1.063	0.787	0.630	0.787	D/G.750	VC**1103...
S25-SVUCR/L11-H	1.260	0.984	0.669	0.984	D1.00	VC**1103...

When using a right or left hand insert, the right hand insert (R) is used for the left hand toolholders (SVUCL** type), and the left hand insert (L) is used for the right hand toolholders (SVUCR** type).

SPARE PARTS



Designation	Clamping screw	Wrench
S**-SVUCR/L11-H	SR14-560	T-8/5

INSERT SELECTION

P	Application	Finishing	Finishing to medium cutting
	Grade	NS9530	T9215
Breaker Shape	PSS	PS	
Cutting conditions		B020	

M	Application	Finishing	Finishing to medium cutting	Medium cutting
	Grade	AH725	AH630	T6130
Breaker Shape	PSF	PSS	PM	
Cutting conditions		B022		

K	Application	Finishing to medium cutting
	Grade	T515
Breaker Shape	CM	
Cutting conditions		B024

N	Application	Precision finishing	Finishing	Medium cutting
	Grade	DX120	DX140	KS05F
Breaker Shape	T-DIA	with rake T-DIA	AL	
Cutting conditions		B026		

S	Application	Finishing	Finishing to medium cutting
	Grade	AH8015	AH8015
Breaker Shape	PSS	PS	
Cutting conditions		B028	

H	Application	Precision finishing	Finishing
	Grade	BXM10	BXM20
Breaker Shape	T-CBN	T-CBN	
Cutting conditions		B030	

Reference pages: S-SVUCR/L-H: Insert → **B155 -**

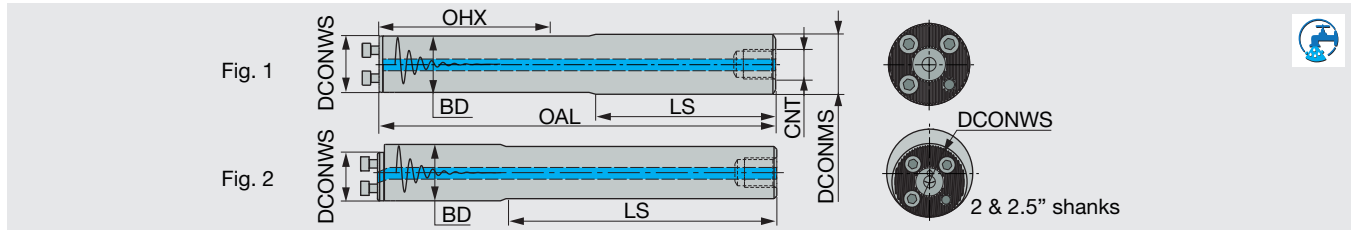

Inch	Material	DCONWS	DCONMS	BD	OAL	LS	OHX	CNT	Fig.
D.625-L6.14-7D-C	Steel	0.630	0.625	0.630	6.140	3.600	3.500	G1/8	1
G.625-L8.03-10D-E	Carbide	0.630	0.625	0.630	8.030	5.220	5.500	-	1
D.750-L7.87-7D-C	Steel	0.787	0.750	0.787	7.870	4.940	4.400	G1/4	1
G.750-L10.24-10D-E	Carbide	0.787	0.750	0.787	10.240	6.770	7.000	-	1
D1.00-L10.2-7D-C	Steel	0.984	1.000	0.984	10.200	6.830	6.200	G1/4	1
D1.00-L13.21-10D-C	Steel	0.984	1.000	0.984	13.210	8.650	9.200	G1/4	1
D1.25-L12.48-7D-C	Steel	1.260	1.250	1.260	12.480	7.370	7.500	G3/8	1
D1.25-L16.24-10D-C	Steel	1.260	1.250	1.260	16.240	9.670	11.200	G3/8	1
D1.50-L15.26-7D-C	Steel	1.575	1.500	1.575	15.260	9.130	9.200	G1/2	1
D1.50-L19.8-10D-C	Steel	1.575	1.500	1.575	19.800	13.350	13.700	G1/2	1
D2.00-L20.74-7D-C	Steel	1.575	2.000	2.000	20.740	-	12.700	G1/2	2
D2.00-L26.73-10D-C	Steel	1.575	2.000	2.000	26.730	-	18.700	G1/2	2
D2.50-L26.2-7D-C	Steel	1.575	2.500	2.500	26.200	-	16.200	G3/4	2
D2.50-L33.72-10D-C	Steel	1.575	2.500	2.500	33.720	-	23.700	G3/4	2

SPARE PARTS



Designation	Clamping screw	Wrench
D.625..., G.625...	SRM3X10DIN912	HW2.5
D.750..., G.750...	SRM3.5X10DIN912	HW2.5
D1.00...	SRM4X12DIN912	HW3.0
D1.25...	SRM5X12DIN912	HW4.0
D1.50..., D2.00... D2.50...	SRM6X16DIN912-12.9	HW5.0

A/E-SVUCR/L

Screw-on boring bar, for positive 35° rhombic inserts

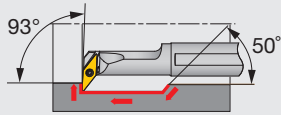

Cutting edge style U

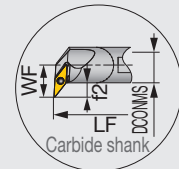
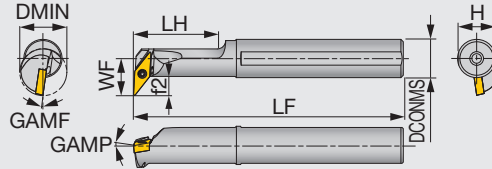

Right hand (R) shown.

Inch	Material	DMIN	DCONMS	WF	LF	LH	H	f2	GAMP	GAMF	RE**	Insert	Torque
A10-SVUCR6-D14	Steel	0.875	0.625	0.531	7.000	1.250	0.600	0.218	0°	-5°	0.016	VC**63...	0.44
A12-SVUCR2-D16	Steel	1.000	0.750	0.594	10.000	1.420	0.725	0.218	0°	-5°	0.016	VC**22...	1.0

Metric	Material	DMIN	DCONMS	WF	LF	LH	H	f2	GAMP	GAMF	RE**	Insert	Torque*
A12M-SVUCR/L08-D160	Steel	16	12	11	150	30	11	5.5	0°	-8°	0.4	VC**0802...	0.6
A25S-SVUCR/L16-D320	Steel	32	25	19	250	45	23	6.5	0°	-5°	0.8	VC**1604...	3
E12Q-SVUCR/L08-D180	Carbide	18	12	11.5	180	-	11	5.5	0°	-8°	0.4	VC**0802...	0.6
E25T-SVUCR/L16-D320	Carbide	32	25	19	300	-	23	6.5	0°	-5°	0.8	VC**1604...	3

Torque: Recommended clamping torque: lbs-ft (*N·m)

**RE : Standard corner radius

Use right-hand toolholders (SVUCR**) with left-hand inserts (L); and left-hand toolholders (SVUCL**) with right-hand inserts (R).

SPARE PARTS



Designation	Clamping screw	Wrench
A10-SVUCR6-D14	CSTB-2L	T-6F
A12-SVUCR2-D16	CSTB-2.5	T-8F
A12M-SVUCR/L08-D160	CSTB-2L	T-6F
A25S-SVUCR/L16-D320	CSTB-3.5	T-15F
E12Q-SVUCR/L08-D180	CSTB-2L	T-6F
E25T-SVUCR/L16-D320	CSTB-3.5	T-15F

INSERT SELECTION

P	Application	Finishing to medium cutting	M	Application	Finishing to medium cutting	
	Grade	T9215		Grade	T9215	
	Breaker Shape			Breaker Shape		
	Cutting conditions	B020		Cutting conditions	B022	
K	Application	Finishing to medium cutting	N	Application	Precision finishing	Medium cutting
	Grade	T515		Grade	DX120	KS05F
	Breaker Shape			Breaker Shape		
	Cutting conditions	B024		Cutting conditions	B026	
S	Application	Finishing to medium cutting	H	Application	Precision finishing	Finishing
	Grade	AH8005		Grade	BXM10	BXM20
	Breaker Shape			Breaker Shape		
	Cutting conditions	B028		Cutting conditions	B030	

Reference pages: A/E-SVUCR/L: Insert → **B155 -**, CBN → **B192**, PCD → **B196 -**

T-SVUCR

Screw-on boring bar, for positive 35° rhombic inserts (Tsuppari-Ichiban)

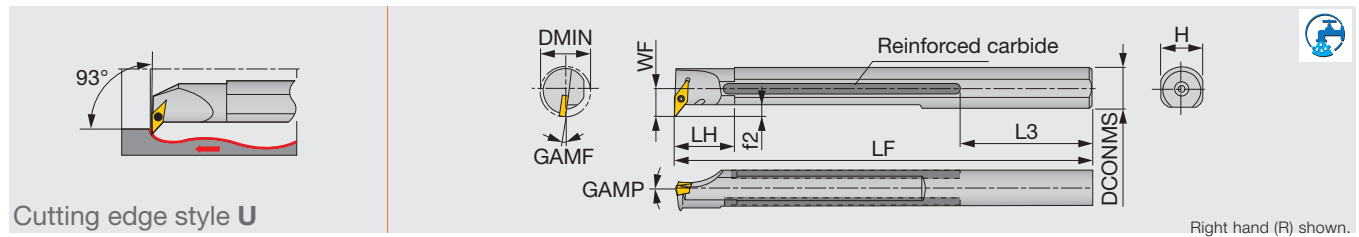

Metric	Material	DMIN	CNT***	DCONMS	WF	LF	LH	L3	H	f2	GAMP	GAMF	RE**	Insert	Torque
T25S-SVUCR16C	Reinforced	32	Rc1/4	25	19	250	40	64	23	6.5	0°	-5°	0.8	VC**1604...	3

Torque: Recommended clamping torque: N·m

**RE : Standard corner radius

***CNT : Threading size at the tail port

*The hole specification of applicable inserts conforms to ISO standard.

Use right-hand toolholders (SVUCR**) with left-hand inserts (L).

SPARE PARTS

Designation	Clamping screw	Wrench
T25S-SVUCR16C	CSTB-3.5L	T-15F

INSERT SELECTION

P	Application	Finishing	Finishing to medium cutting	M	Application	Finishing	Finishing to medium cutting	Medium cutting							
	Grade	NS9530	T9215		Grade	AH725	AH630	T6130							
	Breaker Shape	PSS	PS		Breaker Shape	PSF	PSS	PM							
Cutting conditions				B020				Cutting conditions				B022			
K	Application	Finishing to medium cutting	N	Application	Precision finishing	Finishing	Medium cutting								
	Grade	T515		Grade	DX120	DX140	KS05F								
	Breaker Shape	CM		Breaker Shape	T-DIA	with rake T-DIA	AL								
Cutting conditions				B024				Cutting conditions				B026			
S	Application	Finishing	Finishing to medium cutting	H	Application	Precision finishing	Finishing								
	Grade	AH8015	AH8015		Grade	BXM10	BXM20								
	Breaker Shape	PSS	PS		Breaker Shape	T-CBN	T-CBN								
Cutting conditions				B028				Cutting conditions				B030			

Reference pages: T-SVUCR: Insert → B155 -, CBN → B192, PCD → B196 -



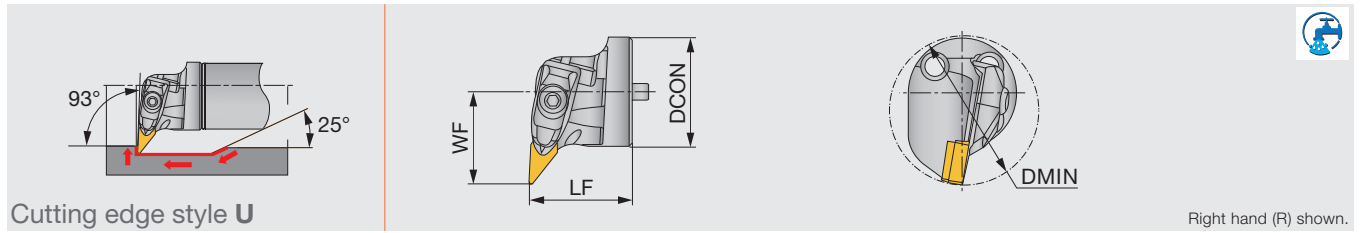

Cutting edge style U

Right hand (R) shown.

Inch	DMIN	DCON	WF	LF	Shank size	Insert
S40-DVUNR/L16T-H	2.205	1.575	1.339	1.496	D1.50, D2.00, D2.50	VN**33...

SPARE PARTS

Designation	Shim	Shim screw	Clamp	Clamping screw	Spring	Wrench
S40-DVUNR/L16T-H	ASV322	SR35080I	DLM3V	SR10402267	KSP5	HW4.0

INSERT SELECTION

Application	Precision finishing	Finishing	Medium cutting
	Grade	NS9530	GT9530
Breaker Shape	TF	TSF	TM
Cutting conditions	B008		

Application	Finishing	Medium cutting
	Grade	T6120
Breaker Shape	SF	SM
Cutting conditions	B010	

Application	Finishing	Medium cutting	Medium to heavy cutting
	Grade	T515	T515
Breaker Shape	All-round	All-round	All-round
Cutting conditions	B012		

Application	Precision finishing
	Grade
Breaker Shape	T-DIA
Cutting conditions	B014

Application	Precision finishing	Finishing	Medium cutting
	Grade	BX470	AH8005
Breaker Shape	T-CBN	HRF	HRM
Cutting conditions	B016		

Application	Precision finishing	Finishing
	Grade	BXM10
Breaker Shape	T-CBN	T-CBN
Cutting conditions	B018	

Reference pages: S-DVUNR/L-H: Insert → **B096 -**, CBN → **B180**, PCD → **B194**

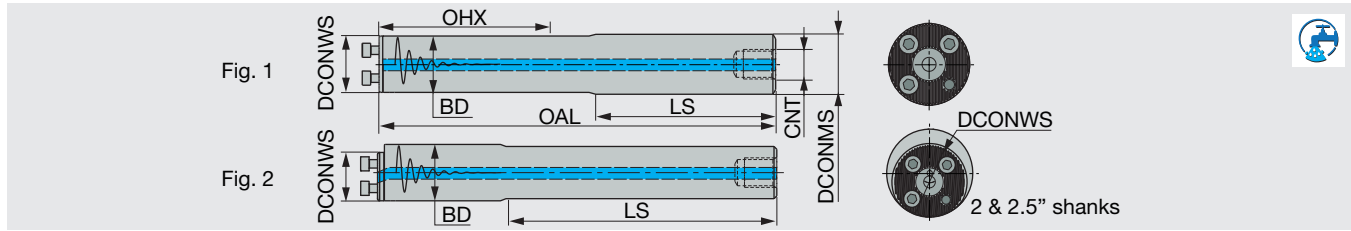

Inch	Material	DCONWS	DCONMS	BD	OAL	LS	OHX	CNT	Fig.
D.625-L6.14-7D-C	Steel	0.630	0.625	0.630	6.140	3.600	3.500	G1/8	1
G.625-L8.03-10D-E	Carbide	0.630	0.625	0.630	8.030	5.220	5.500	-	1
D.750-L7.87-7D-C	Steel	0.787	0.750	0.787	7.870	4.940	4.400	G1/4	1
G.750-L10.24-10D-E	Carbide	0.787	0.750	0.787	10.240	6.770	7.000	-	1
D1.00-L10.2-7D-C	Steel	0.984	1.000	0.984	10.200	6.830	6.200	G1/4	1
D1.00-L13.21-10D-C	Steel	0.984	1.000	0.984	13.210	8.650	9.200	G1/4	1
D1.25-L12.48-7D-C	Steel	1.260	1.250	1.260	12.480	7.370	7.500	G3/8	1
D1.25-L16.24-10D-C	Steel	1.260	1.250	1.260	16.240	9.670	11.200	G3/8	1
D1.50-L15.26-7D-C	Steel	1.575	1.500	1.575	15.260	9.130	9.200	G1/2	1
D1.50-L19.8-10D-C	Steel	1.575	1.500	1.575	19.800	13.350	13.700	G1/2	1
D2.00-L20.74-7D-C	Steel	1.575	2.000	2.000	20.740	-	12.700	G1/2	2
D2.00-L26.73-10D-C	Steel	1.575	2.000	2.000	26.730	-	18.700	G1/2	2
D2.50-L26.2-7D-C	Steel	1.575	2.500	2.500	26.200	-	16.200	G3/4	2
D2.50-L33.72-10D-C	Steel	1.575	2.500	2.500	33.720	-	23.700	G3/4	2

SPARE PARTS



Designation	Clamping screw	Wrench
D.625..., G.625...	SRM3X10DIN912	HW2.5
D.750..., G.750...	SRM3.5X10DIN912	HW2.5
D1.00...	SRM4X12DIN912	HW3.0
D1.25...	SRM5X12DIN912	HW4.0
D1.50..., D2.00... D2.50...	SRM6X16DIN912-12.9	HW5.0

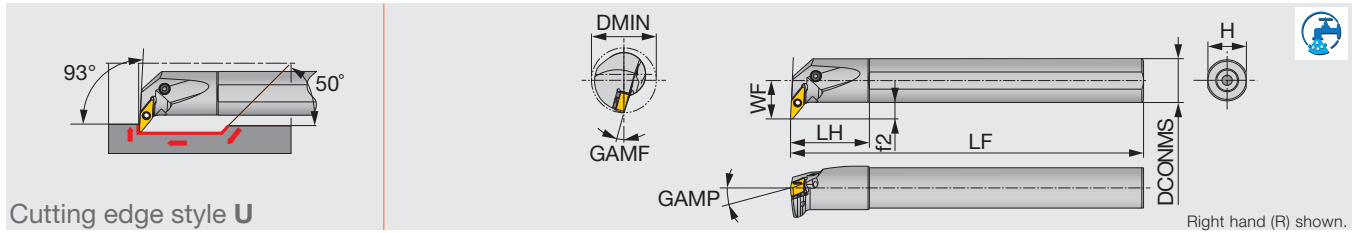

Cutting edge style U

Right hand (R) shown.

Inch	Material	DMIN	DCONMS	WF	LF	LH	H	f2	GAMP	GAMF	RE**	Insert	Torque
A16-PVUNR/L2.33-D20	Steel	1.250	1.000	0.672	12.000	1.750	0.906	0.197	-6°	-13°	0.031	VN**2.33**E...	2.2
A16-PVUNR/L2.33-D24	Steel	1.500	1.000	0.859	12.000	1.750	0.906	0.315	-6°	-10°	0.031	VN**2.33**E...	2.2
A20-PVUNR/L2.33-D26	Steel	1.650	1.250	0.859	14.000	2.000	1.188	0.217	-6°	-10°	0.031	VN**2.33**E...	2.2

Metric	Material	DMIN	DCONMS	WF	LF	LH	H	f2	GAMP	GAMF	RE**	Insert	Torque*
A25R-PVUNR/L1204-D320	Steel	32	25	18	200	45	23	5.0	-5°	-15°	0.8	VN**1204...	3
A25R-PVUNR/L1204-D370	Steel	37	25	22	200	45	23	8.0	-4°	-15°	0.8	VN**1204...	3
A32S-PVUNR/L1204-D400	Steel	40	32	22	250	50	30	5.5	-6°	-12°	0.8	VN**1204...	3

Torque: Recommended clamping torque: lbs-ft (*N-m)

**RE: Standard corner radius

SPARE PARTS

Designation	Clamping screw	Wrench	Lever	Shim	Spring pin	Oil supply attachment*	Screw for oil hole*
A16-PVUNR/L2.33-D... A25R-PVUNR/L1204-D...	LCS3V	P-2.5	LCL3V	LSV212	LSP3	EA-25	SSHM4-5
A20-PVUNR/L2.33-D26, A32S-PVUNR/L1204-D400	LCS3V	P-2.5	LCL3V	LSV212	LSP3	EA-32	SSHM4-5

*Optional

INSERT SELECTION

Application	Finishing	Medium cutting
	T9215	T9215
Grade	T9215	T9215
Breaker Shape	TSF	TM
Cutting conditions	B008	

Application	Finishing	Medium cutting
	T6120	T6130
Grade	T6120	T6130
Breaker Shape	SS	SM
Cutting conditions	B010	

Reference pages: A-PVUNR/L-Eco: Insert → **B097** -

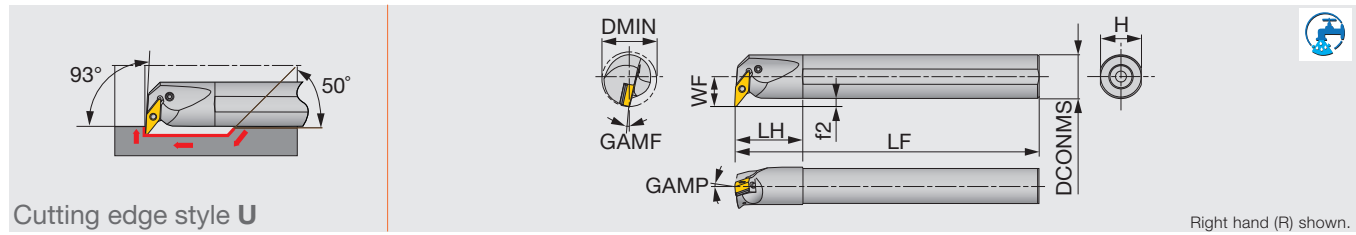

Metric	Material	DMIN	DCONMS	WF	LF	LH	H	f2	GAMP	GAMF	RE**	Insert	Torque
A25R-PVUNR/L16-D370	Steel	37	25	22	200	45	23	9.5	-5°	-14°	0.8	V/YN**1604...	2.7
A32S-PVUNR/L16-D400	Steel	40	32	22	250	50	30	6	-5°	-12°	0.8	V/YN**1604...	2.7
A40T-PVUNR/L16-D500	Steel	50	40	27	300	60	37	7	-5°	-10°	0.8	V/YN**1604...	2.7

Torque: Recommended clamping torque: N·m

**RE: Standard corner radius

SPARE PARTS

Designation	Shim	Clamping screw	Wrench	Spring pin	Lever	Oil supply attachment*	Screw for oil hole*
A25R-PVUNR/L16-D370	LSV317BR/L	LCS3V	P-2.5	LSP3	LCL3V	EA-25	SSHM4-5
A32S-PVUNR/L16-D400	LSV317BR/L	LCS3V	P-2.5	LSP3	LCL3V	EA-32	SSHM4-5
A40T-PVUNR/L16-D500	LSV317BR/L	LCS3V	P-2.5	LSP3	LCL3V	-	SSHM5-6

*Optional

INSERT SELECTION

P	Application	Precision finishing	Finishing	Medium cutting	M	Application	Finishing	Medium cutting	
	Grade	NS9530	GT9530	T9215		Grade	T6120	T6130	
	Breaker Shape	TF	TSF	TM		Breaker Shape	SF	SM	
Cutting conditions				B008	Cutting conditions				B010
K	Application	Finishing	Medium cutting	Medium to heavy cutting	N	Application	Precision finishing		
	Grade	T515	T515	T515		Grade	DX120		
	Breaker Shape	All-round	All-round	All-round		Breaker Shape	T-DIA	with rake	
Cutting conditions				B012	Cutting conditions				B014
S	Application	Precision finishing	Finishing	Medium cutting	H	Application	Precision finishing	Finishing	
	Grade	BX470	AH8005	AH8005		Grade	BXM10	BXM20	
	Breaker Shape	T-CBN	HRF	HRM		Breaker Shape	T-CBN	T-CBN	
Cutting conditions				B016	Cutting conditions				B018

Reference pages: A-PVUNR/L: Insert → **B096 -**, **B109**, CBN → **B180**, PCD → **B194**



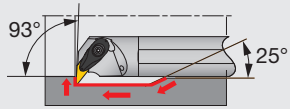

Cutting edge style U

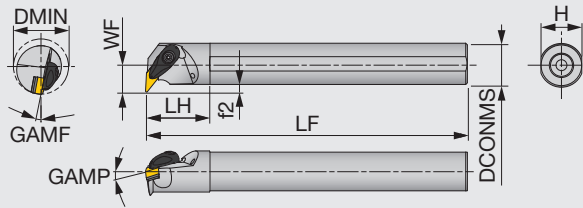

Right hand (R) shown.

Inch	Material	DMIN	DCONMS	WF	LF	LH	H	f2	GAMP	GAMF	RE**	Insert	Torque
A20-AVUNR/L3-D25	Steel	1.560	1.250	0.859	14.000	1.960	1.180	0.236	-6	-10	0.031	V/YN**33...	2.21
A24-AVUNR/L3-D32	Steel	2.000	1.500	1.060	14.000	2.160	1.440	0.275	-6	-8	0.031	V/YN**33...	2.21

Torque: Recommended clamping torque: lbs-ft
 **RE : Standard corner radius

SPARE PARTS

Designation	Clamp	Clamp screw	Spring	Spring pin	Shim	Shim screw	Wrench
A*-AVUNR/L3-D...	ACP3L	ACS-5W	BP-7	SP-2.5	ASV322	CSTB-3.5	T-15F

INSERT SELECTION

Application	Precision finishing	Finishing	Medium cutting
	Grade	NS9530	GT9530
Breaker Shape	TF	TSF	TM
Cutting conditions	B008		

Application	Finishing	Medium cutting
	Grade	T6120
Breaker Shape	SF	SM
Cutting conditions	B010	

Application	Finishing	Medium cutting	Medium to heavy cutting
	Grade	T515	T515
Breaker Shape	All-round	All-round	All-round
Cutting conditions	B012		

Application	Precision finishing
	Grade
Breaker Shape	T-DIA with rake
Cutting conditions	B014

Application	Precision finishing	Finishing	Medium cutting
	Grade	BX470	AH8005
Breaker Shape	T-CBN	HRF	HRM
Cutting conditions	B016		

Application	Precision finishing	Finishing
	Grade	BXM10
Breaker Shape	T-CBN	T-CBN
Cutting conditions	B018	

Reference pages: A-AVUNR/L: Insert → B096 -, B109, CBN → B180, PCD → B194

A/E-SWUBR/L

Screw-on boring bar, for positive 80° trigon inserts

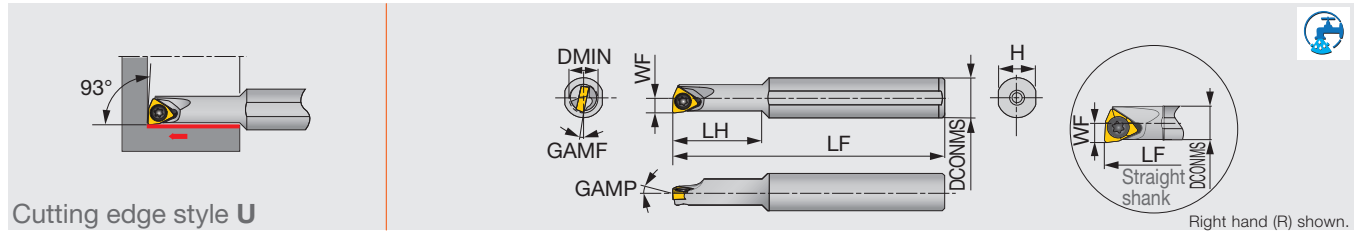

Cutting edge style U

Metric	Material	DMIN	DCONMS	WF	LF	LH	H	GAMP	GAMF	RE**	Insert	Torque
A05F-SWUBR/L03-D060	Steel	6	5	3	80	9	4.8	0°	-13°	0.4	WB**0301...	0.6
A06G-SWUBR/L03-D070	Steel	7	6	3.5	90	11	5.75	0°	-12°	0.4	WB**0301...	0.6
A07G-SWUBR/L03-D080	Steel	8	7	4	90	12	6.75	0°	-11°	0.4	WB**0301...	0.6
A08H-SWUBR03-D060	Steel	6	8	3.1	100	18	7.5	0°	-12°	0.4	WB**0301...	0.6
A08H-SWUBR03-D070	Steel	7	8	3.6	100	20	7.5	0°	-12°	0.4	WB**0301...	0.6
E05G-SWUBR/L03-D060	Carbide	6	5	3	90	10	4.8	0°	-13°	0.4	WB**0301...	0.6
E06H-SWUBR/L03-D070	Carbide	7	6	3.5	100	12	5.75	0°	-12°	0.4	WB**0301...	0.6
E07H-SWUBR/L03-D080	Carbide	8	7	4	100	14	6.75	0°	-11°	0.4	WB**0301...	0.6
E08K-SWUBR03-D060	Carbide	6	8	3.1	125	30	7.5	0°	-12°	0.4	WB**0301...	0.6
E08K-SWUBR03-D070	Carbide	7	8	3.6	125	40	7.5	0°	-12°	0.4	WB**0301...	0.6

Torque: Recommended clamping torque: N·m

**RE : Standard corner radius

Use right-hand toolholders (SVUCR*) with left-hand inserts (L); and left-hand toolholders (SWUBL**) with right-hand inserts (R).

SPARE PARTS

Designation	Clamping screw	Wrench
A/E**SWUBR/L...	CSTB-2	T-6F

INSERT SELECTION

P	Application	Finishing	M	Application	Finishing	K	Application	Finishing	N	Application	Finishing
	Grade	SH725		Grade	SH725		Grade	TH10		Grade	GH110
	Breaker Shape	W08		Breaker Shape	W08		Breaker Shape	W08		Breaker Shape	W08
Cutting conditions		B008	Cutting conditions		B010	Cutting conditions		B012	Cutting conditions		B014

Reference pages: A/E-SWUBR/L: Insert → **B159 -**

Y-PRO SERIES

A/E-SYUBR/L

Screw-on boring bar, for positive 25° rhombic inserts

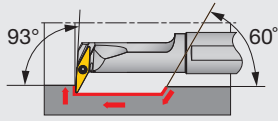

Cutting edge style U

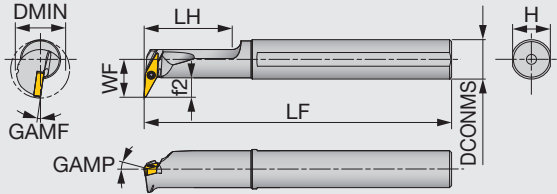

Right hand (R) shown.

Inch	Material	DMIN	DCONMS	WF	LF	LH	H	f2	GAMP	GAMF	RE**	Insert	Torque
A10-SYUBR/L2-D16	Steel	1.000	0.625	0.625	7.000	1.250	0.600	0.312	0°	-8°	0.016	YW**11T2...	0.44
E08-SYUBR/L2-D14	Carbide	0.875	0.500	0.563	5.000	1.060	0.475	0.307	0°	-8°	0.016	YW**11T2...	0.44
E10-SYUBR/L2-D16	Carbide	1.000	0.625	0.625	7.000	1.250	0.600	0.307	0°	-8°	0.016	YW**11T2...	0.44

Metric	Material	DMIN	DCONMS	WF	LF	LH	H	f2	GAMP	GAMF	RE**	Insert	Torque*
A16Q-SYUBR/L11-D200	Steel	20	16	15.5	180	35	15	8	0°	-8°	0.4	YW**11T2...	0.6
E12Q-SYUBR/L11-D200	Carbide	20	12	13.5	180	27	11	7.5	0°	-8°	0.4	YW**11T2...	0.6
E16R-SYUBR/L11-D245	Carbide	24.5	16	16	200	32	15	8	0°	-8°	0.4	YW**11T2...	0.6

Torque: Recommended clamping torque: lbs-ft (*N·m)

**RE : Standard corner radius

SPARE PARTS



Designation	Clamping screw	Wrench
A10-SYUBR/L2-D16	CSTB-2L	T-6F
E**-SYUBR/L2-D...	CSTB-2L	T-6F
A16Q-SYUBR/L11-D200	CSTB-2L	T-6F
E**-SYUBR/L11-D...	CSTB-2L	T-6F

INSERT SELECTION



Application	Finishing to medium cutting
Grade	T9225
Breaker Shape	ZM
Cutting conditions	B020



Application	Finishing to medium cutting
Grade	GT9530
Breaker Shape	ZM
Cutting conditions	B024

Reference pages: A/E-SYUBR/L: Insert → **B163**

A/E-SDQCR/L

Screw-on boring bar, for positive 55° rhombic inserts

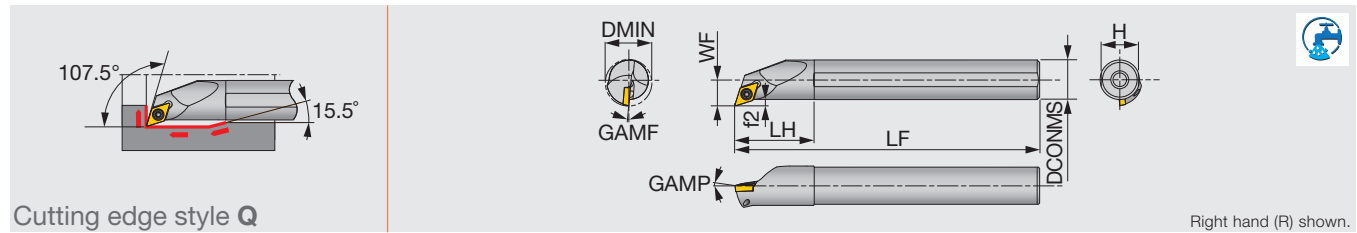

Inch	Material	DMIN	DCONMS	WF	LF	LH	H	f2	GAMP	GAMF	RE**	Insert	Torque
A06-SDQCR2-D10	Steel	0.625	0.375	0.406	5.000	0.750	0.350	-	0°	-7°	0.016	DC**21.5...	0.89
A08-SDQCR2-D11	Steel	0.688	0.500	0.406	5.000	1.000	0.475	-	0°	-6°	0.016	DC**21.5...	0.89
A10-SDQCR2-D14	Steel	0.875	0.625	0.531	7.000	1.250	0.600	-	0°	-4°	0.016	DC**21.5...	0.89

Metric	Material	DMIN	DCONMS	WF	LF	LH	H	f2	GAMP	GAMF	RE**	Insert	Torque*
A10K-SDQCR/L07-D130	Steel	13	10	7.6	125	20	9	2.6	0°	-8°	0.4	DC**0702...	1.2
A12M-SDQCR/L07-D160	Steel	16	12	8.6	150	24	11	2.6	0°	-6°	0.4	DC**0702...	1.2
A16Q-SDQCR/L07-D200	Steel	20	16	10.6	180	32	15	2.6	0°	-5°	0.4	DC**0702...	1.2
A20R-SDQCR/L11-D250	Steel	25	20	13.7	200	36	18	3.7	0°	-7°	0.8	DC**11T3...	3
A25S-SDQCR/L11-D300	Steel	30	25	16.2	250	45	23	3.7	0°	-4°	0.8	DC**11T3...	3
E10H-SDQCR07-D130	Carbide	13	10	7.6	100	25	9	2.5	0°	-8°	0.4	DC**0702...	1.2
E10M-SDQCR/L07-D130	Carbide	13	10	7.6	150	25	9	2.6	0°	-8°	0.4	DC**0702...	1.2
E12J-SDQCR07-D160	Carbide	16	12	8.6	110	27	11	2.5	0°	-6°	0.4	DC**0702...	1.2
E12Q-SDQCR/L07-D160	Carbide	16	12	8.6	180	27	11	2.6	0°	-6°	0.4	DC**0702...	1.2
E16L-SDQCR07-D200	Carbide	20	16	10.6	130	32	15	2.5	0°	-5°	0.4	DC**0702...	1.2
E16R-SDQCR/L07-D200	Carbide	20	16	10.6	200	32	15	2.6	0°	-5°	0.4	DC**0702...	1.2
E20S-SDQCR/L11-D250	Carbide	25	20	13.7	250	36	18	3.7	0°	-7°	0.8	DC**11T3...	3

Torque: Recommended clamping torque: lbs-ft (*N·m)

**RE : Standard corner radius

Use right-hand toolholders (SDQCR**) with left-hand inserts (L); and left-hand toolholders (SDQCL**) with right-hand inserts (R).

SPARE PARTS

Designation	Clamping screw	Wrench
A**-SDQCR2-D...	CSTB-2.5B	T-8F
A1**-SDQCR/L07-D**0	CSTB-2.5S	T-8F
A2**-SDQCR/L11-D**0	CSTB-4S	T-15F
E1**-SDQCR/L07-D**0	CSTB-2.5S	T-8F
E20S-SDQCR/L11-D250	CSTB-4S	T-15F

INSERT SELECTION

Application	Precision finishing	Finishing	Finishing to medium cutting	Medium cutting
	SH725	SH725	T9215	T9215
Grade	01	JS	PS	PM
Breaker Shape				
Cutting conditions	B020			

Application	Precision finishing	Finishing	Finishing to medium cutting	Medium cutting
	SH725	SH725	T9215	T9215
Grade	01	JS	PS	PM
Breaker Shape				
Cutting conditions	B022			

Application	Finishing to medium cutting
	T515
Grade	CM
Breaker Shape	
Cutting conditions	B024

Application	Precision finishing	Medium cutting
	DX120	KS05F
Grade	T-DIA	with rake AL
Breaker Shape		
Cutting conditions	B026	

Application	Precision finishing	Finishing to medium cutting
	BX470	AH8005
Grade	T-CBN	PS
Breaker Shape		
Cutting conditions	B028	

Application	Precision finishing	Finishing
	BXM10	BXM20
Grade	T-CBN	T-CBN
Breaker Shape		
Cutting conditions	B030	

Reference pages: A/E-SDQCR/L: Insert → **B121** -, CBN → **B184**, PCD → **B196** -



T-SDQCR/L

Screw-on boring bar, for positive 55° rhombic inserts (Tsuppari-Ichiban)

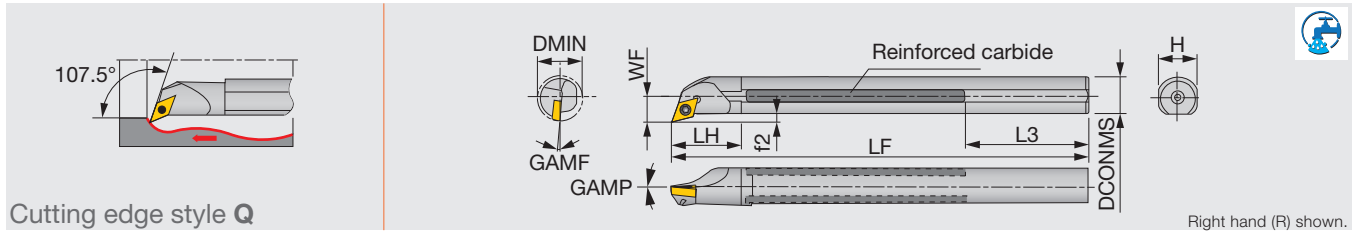

Metric	Material	DMIN	CNT***	DCONMS	WF	LF	LH	L3	H	f2	GAMP	GAMF	RE**	Insert	Torque
T16Q-SDQCR/L07	Reinforced	20	-	16	11	180	27	59	15	3	0°	-6°	0.4	DC**0702...	1.2
T20R-SDQCR/L11C	Reinforced	25	Rc1/4	20	13	200	35	49	18	3	0°	-6°	0.8	DC**11T3...	3
T25S-SDQCR/L11C	Reinforced	32	Rc1/4	25	17	250	40	64	23	4.5	0°	-4°	0.8	DC**11T3...	3

Torque: Recommended clamping torque: N·m

**RE : Standard corner radius

***CNT : Threading size at the tail port

*The hole specification of applicable inserts conforms to ISO standard.

Use right-hand toolholders (SDQCR**) with left-hand inserts (L); and left-hand toolholders (SDQCL**) with right-hand inserts (R).

SPARE PARTS

Designation	Clamping screw	Wrench
T16Q-SDQCR/L07	CSTB-2.5	T-8F
T20R-SDQCR/L11C	CSTB-4M	T-15F
T25S-SDQCR/L11C	CSTB-4	T-15F

INSERT SELECTION

P	Application	Finishing	Finishing to medium cutting	Medium cutting
	Grade	NS9530	T9215	T9215
Breaker Shape	PSS	PS	PM	
Cutting conditions	B020			

M	Application	Precision finishing	Finishing	Finishing to medium cutting	Medium cutting
	Grade	GH330	AH725	AH630	T6130
Breaker Shape	W**	PSF	PSS	PM	
Cutting conditions	B022				

K	Application	Finishing to medium cutting
	Grade	T515
Breaker Shape	CM	
Cutting conditions	B024	

N	Application	Precision finishing	Finishing	Medium cutting
	Grade	DX120	DX140	KS05F
Breaker Shape	T-DIA	with rake T-DIA	AL	
Cutting conditions	B026			

S	Application	Finishing	Finishing to medium cutting
	Grade	AH8015	AH8015
Breaker Shape	PSS	PS	
Cutting conditions	B028		

H	Application	Precision finishing	Finishing
	Grade	BXM10	BXM20
Breaker Shape	T-CBN	T-CBN	
Cutting conditions	B030		

Reference pages: T-SDQCR/L: Insert → **B121** -, CBN → **B184**, PCD → **B196** -

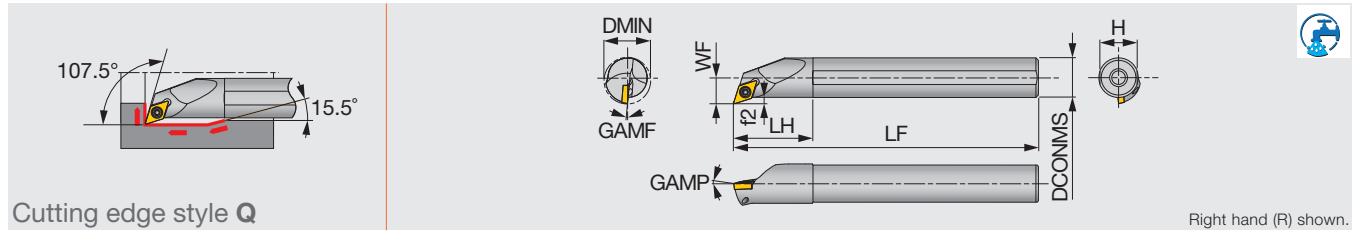

Metric	Material	DMIN	DCONMS	WF	LF	LH	H	f2	GAMP	GAMF	RE***	Insert	Torque
A12M-SDQPR07-D150-P	Special alloy steel*	15	12	8.3	150	24	11	2.3	5°	0°	0.40	DPMT0702...	1.2
A12M-SDQPL07-D150-P	Special alloy steel*	15	12	8.3	150	24	11	2.3	5°	0°	0.40	DPMT0702...	1.2
A12M-SDQPR07-D180-P	Special alloy steel*	18	12	9.6	150	24	11	3.6	5°	0°	0.40	DPMT0702...	1.2
A12M-SDQPL07-D180-P	Special alloy steel*	18	12	9.6	150	24	11	3.6	5°	0°	0.40	DPMT0702...	1.2
A16Q-SDQPR07-D220-P	Special alloy steel*	22	16	11.6	180	32	15	3.6	5°	0°	0.40	DPMT0702...	1.2
A16Q-SDQPL07-D220-P	Special alloy steel*	22	16	11.6	180	32	15	3.6	5°	0°	0.40	DPMT0702...	1.2
E12Q-SDQPR07-D150	Carbide	15	12	8.3	180	27	11	2.3	5°	0°	0.40	DPMT0702...	1.2
E12Q-SDQPL07-D150	Carbide	15	12	8.3	180	27	11	2.3	5°	0°	0.40	DPMT0702...	1.2
E12Q-SDQPR07-D180	Carbide	18	12	9.6	180	27	11	3.6	5°	0°	0.40	DPMT0702...	1.2
E12Q-SDQPL07-D180	Carbide	18	12	9.6	180	27	11	3.6	5°	0°	0.40	DPMT0702...	1.2
E16R-SDQPR07-D220	Carbide	22	16	11.6	200	32	15	3.6	5°	0°	0.40	DPMT0702...	1.2
E16R-SDQPL07-D220	Carbide	22	16	11.6	200	32	15	3.6	5°	0°	0.40	DPMT0702...	1.2

*Special alloy steel: Exclusively selected material is used to reduce chattering.

Torque: Recommended clamping torque: N·m

***RE : Standard corner radius

Use right-hand toolholders (SDQCR**) with left-hand inserts (L); and left-hand toolholders (SDQCL**) with right-hand inserts (R).

SPARE PARTS

Designation	Clamping screw	Wrench
A**-SDQPR/L07-D**0-P	CSTB-2.5S	T-8F
E**-SDQPR/L07-D**0	CSTB-2.5S	T-8F

INSERT SELECTION

P

Application	Finishing to medium cutting	
Grade	T9225	NS9530
Breaker Shape	PS	PS
Cutting conditions	B020	

S

Application	Finishing to medium cutting	
Grade	AH8015	
Breaker Shape	PS	
Cutting conditions	B028	



A/E-SVQBR/L

Screw-on boring bar, for positive 35° rhombic inserts

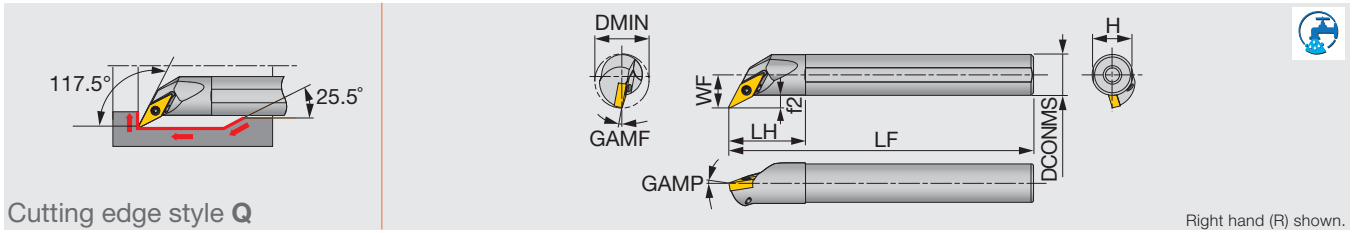

Inch	Material	DMIN	DCONMS	WF	LF	LH	H	f2	GAMP	GAMF	RE**	Insert	Torque
A10-SVQBR2-D16	Steel	1.000	0.625	0.500	7.000	1.250	0.600	0.188	-5°	-6°	0.016	VB**1103...	0.89
Metric	Material	DMIN	DCONMS	WF	LF	LH	H	f2	GAMP	GAMF	RE**	Insert	Torque*
A12M-SVQBR/L11-D170	Steel	17	12	10.5	150	24	11	4.5	-5°	-10°	0.4	VB**1103...	1.2
A16Q-SVQBR/L11-D215	Steel	21.5	16	13	180	30	15	5	-5°	-8°	0.4	VB**1103...	1.2
A20R-SVQBR/L11-D255	Steel	25.5	20	15	200	36	18	5	-5°	-6°	0.4	VB**1103...	1.2
A25S-SVQBR/L16-D305	Steel	30.5	25	17.5	250	45	23	5	-5°	-8°	0.8	VB**1604...	3
E12Q-SVQBR/L11-D170	Carbide	17	12	10.5	180	27	11	4.5	-5°	-10°	0.4	VB**1103...	1.2
E16R-SVQBR/L11-D215	Carbide	21.5	16	13	200	32	15	5	-5°	-8°	0.4	VB**1103...	1.2
E20S-SVQBR/L11-D255	Carbide	25.5	20	15	250	36	18	5	-5°	-6°	0.4	VB**1103...	1.2
E25T-SVQBR/L16-D305	Carbide	30.5	25	17.5	300	45	23	5	-5°	-8°	0.8	VB**1604...	3

Torque: Recommended clamping torque: lbs-ft (*N·m)

**RE : Standard corner radius

Use right-hand toolholders (SVQBR**) with left-hand inserts (L); and left-hand toolholders (SVQL**) with right-hand inserts (R).

SPARE PARTS

Designation	Clamping screw	Wrench
A10-SVQBR2-D16	CSTB-2.5	T-8F
A**-SVQBR/L11-D...	CSTB-2.5	T-8F
A25S-SVQBR/L16-D305	CSTB-3.5	T-15F
E**-SVQBR/L11-D...	CSTB-2.5	T-8F
E25T-SVQBR/L16-D305	CSTB-3.5	T-15F

INSERT SELECTION

Application	Finishing	Finishing to medium cutting
	SH725	T9215
Grade	JS	PS
Breaker Shape		
Cutting conditions	B020	

Application	Finishing	Finishing to medium cutting
	SH725	T9215
Grade	JS	PS
Breaker Shape		
Cutting conditions	B022	

Application	Finishing to medium cutting
	T515
Grade	CM
Breaker Shape	
Cutting conditions	B024

Application	Precision finishing	Finishing
	BXM10	BXM20
Grade	T-CBN	T-CBN
Breaker Shape		
Cutting conditions	B030	

Reference pages: A/E-SVQBR/L: Insert → **B152 -**, CBN → **B191**

T-SVQBR

Screw-on boring bar, for positive 35° rhombic inserts (Tsuppari-Ichiban)

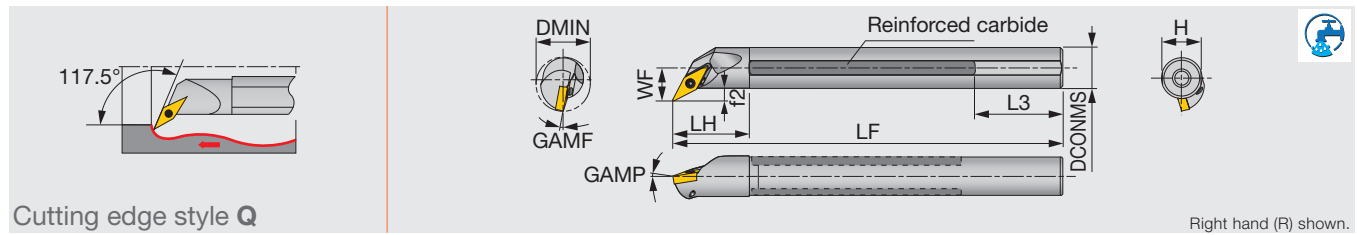

Cutting edge style Q

Right hand (R) shown.

Metric	Material	DMIN	CNT***	DCONMS	WF	LF	LH	L3	H	f2	GAMP	GAMF	RE**	Insert	Torque
T20R-SVQBR11C	Reinforced	25	Rc1/4	20	14	200	30	59	18	4	-5°	-7°	0.4	VB**1103...	1.2

Torque: Recommended clamping torque: N·m

**RE : Standard corner radius

***CNT : Threading size at the tail port

*The hole specification of applicable inserts conforms to ISO standard.

Use right-hand toolholders (R) with left-hand inserts (L); and left-hand toolholders (L) with right-hand inserts (R).

SPARE PARTS

Designation	Clamping screw	Wrench
T20R-SVQBR11C	CSTB-2.5	T-8F

INSERT SELECTION

P

Application	Finishing	Finishing to medium cutting
Grade	NS9530	T9215
Breaker Shape	PSS	PS
Cutting conditions	B020	

M

Application	Finishing	Finishing to medium cutting
Grade	AH725	AH630
Breaker Shape	PSF	PSS
Cutting conditions	B022	

K

Application	Finishing to medium cutting
Grade	T515
Breaker Shape	CM
Cutting conditions	B024

S

Application	Finishing	Finishing to medium cutting
Grade	AH8015	AH8015
Breaker Shape	PSS	PS
Cutting conditions	B028	

H

Application	Precision finishing	Finishing
Grade	BXM10	BXM20
Breaker Shape	T-CBN	T-CBN
Cutting conditions	B030	

Reference pages: T-SVQBR: Insert → B152 -, CBN → B191



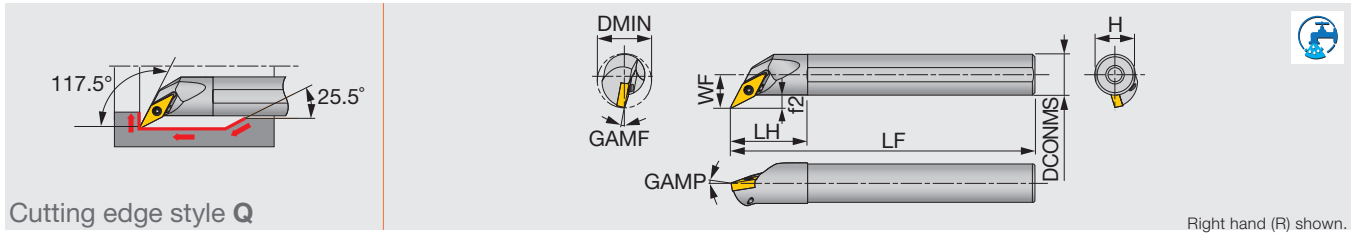

Right hand (R) shown.

Inch	Material	DMIN	DCONMS	WF	LF	LH	H	f2	GAMP	GAMF	RE**	Insert	Torque
A08-SVQCR6-D11	Steel	0.688	0.5	0.375	5.000	1.000	0.475	0.125	-5°	-8°	0.016	VC**0802...	0.44
A10-SVQCR2-D16	Steel	1.000	0.625	0.500	10.000	1.250	0.600	0.188	-5°	-8°	0.016	VC**1103...	0.89
Metric	Material	DMIN	DCONMS	WF	LF	LH	H	f2	GAMP	GAMF	RE**	Insert	Torque*
A10K-SVQCR/L08-D135	Steel	13.5	10	8	125	20	9	3	-5°	-8°	0.4	VC**0802...	0.6
A16Q-SVQCR/L11-D215	Steel	21.5	16	13	180	30	15	4.9	-5°	-8°	0.4	VC**1103...	1.2
E10M-SVQCR/L08-D135	Carbide	13.5	10	8	150	25	9	3	-5°	-8°	0.4	VC**0802...	0.6
E16R-SVQCR/L11-D215	Carbide	21.5	16	13	200	32	15	4.9	-5°	-8°	0.4	VC**1103...	1.2

Torque: Recommended clamping torque: lbs-ft (*N·m)

**RE : Standard corner radius

Use right-hand toolholders (SVQCR**) with left-hand inserts (L); and left-hand toolholders (SVQCL**) with right-hand inserts (R).

SPARE PARTS

Designation	Clamping screw	Wrench
A08-SVQCR6-D11	CSTB-2L	T-6F
A10-SVQCR2-D16	CSTB-2.5	T-8F
A10K-SVQCR/L08-D135	CSTB-2L	T-6F
A16Q-SVQCR/L11-D215	CSTB-2.5	T-8F
E10M-SVQCR/L08-D135	CSTB-2L	T-6F
E16R-SVQCR/L11-D215	CSTB-2.5	T-8F

INSERT SELECTION

P	Application	Finishing to medium cutting	M	Application	Finishing to medium cutting	
	Grade	T9215		Grade	T9215	
	Breaker Shape			Breaker Shape		
	Cutting conditions	B020		Cutting conditions	B022	
K	Application	Finishing to medium cutting	N	Application	Precision finishing	Medium cutting
	Grade	T515		Grade	DX120	KS05F
	Breaker Shape			Breaker Shape		
	Cutting conditions	B024		Cutting conditions	B026	
S	Application	Finishing to medium cutting	H	Application	Precision finishing	Finishing
	Grade	AH8005		Grade	BXM10	BXM20
	Breaker Shape			Breaker Shape		
	Cutting conditions	B028		Cutting conditions	B030	

Reference pages: A/E-SVQCR/L: Insert → **B155 -**

T-SVQCR

Screw-on boring bar, for positive 35° rhombic inserts (Tsuppari-Ichiban)

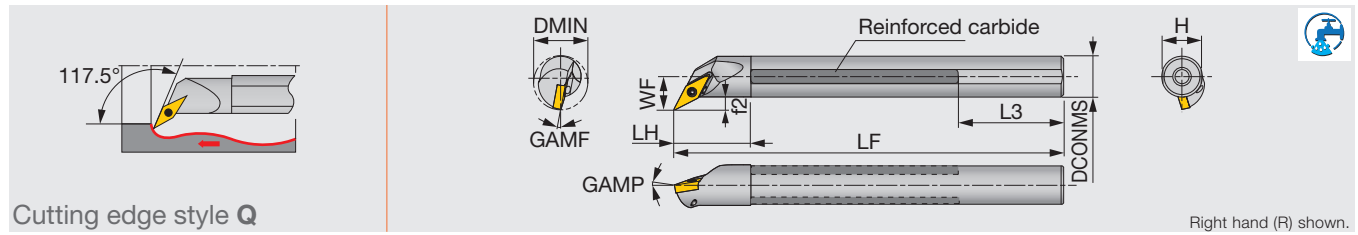

Metric	Material	DMIN	CNT***	DCONMS	WF	LF	LH	L3	H	f2	GAMP	GAMF	RE**	Insert	Torque
T25S-SVQCR16C	Reinforced	32	Rc1/4	25	17	250	40	64	23	8	0°	-5°	0.8	VC**1604...	3

Torque: Recommended clamping torque: N·m
 **RE : Standard corner radius
 ***CNT : Threading size at the tail port
 *The hole specification of applicable inserts conforms to ISO standard.
 Use right-hand toolholders (R) with left-hand inserts (L); and left-hand toolholders (L) with right-hand inserts (R).

SPARE PARTS

Designation	Clamping screw	Wrench
T25S-SVQCR16C	CSTB-3.5L	T-15F

INSERT SELECTION

P	Application	Finishing	Finishing to medium cutting	M	Application	Finishing	Finishing to medium cutting	Medium cutting			
	Grade	NS9530	T9215		Grade	AH725	AH630	T6130			
	Breaker Shape	PSS	PS		Breaker Shape	PSF	PSS	PM			
Cutting conditions				B020				B022			
K	Application	Finishing to medium cutting		N	Application	Precision finishing	Finishing	Medium cutting			
	Grade	T515			Grade	DX120	DX140	KS05F			
	Breaker Shape	CM			Breaker Shape	T-DIA	T-DIA with rake	AL			
Cutting conditions				B024				B026			
S	Application	Finishing	Finishing to medium cutting	H	Application	Precision finishing	Finishing				
	Grade	AH8015	AH8015		Grade	BXM10	BXM20				
	Breaker Shape	PSS	PS		Breaker Shape	T-CBN	T-CBN				
Cutting conditions				B028				B030			

Reference pages: T-SVQCR: Insert → B155 -, CBN → B192, PCD → B196 -



Y-PRO SERIES

A/E-SYQBR/L

Screw-on boring bar, for positive 25° rhombic inserts

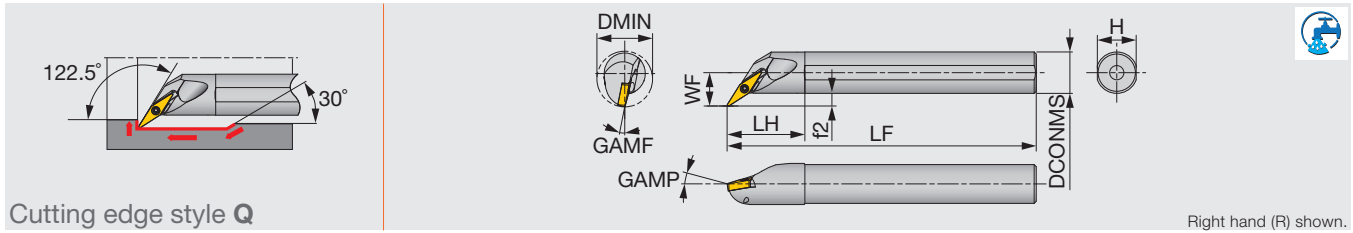

Cutting edge style Q

Right hand (R) shown.

Inch	Material	DMIN	DCONMS	WF	LF	LH	H	f2	GAMP	GAMF	RE**	Insert	Torque
A08-SYQBR2-D12	Steel	0.750	0.500	0.438	5.000	1.000	0.475	0.188	-5°	-10°	0.016	YW**11T2...	0.44
A10-SYQBR2-D14	Steel	0.875	0.625	0.500	7.000	1.250	0.600	0.188	-5°	-8°	0.016	YW**11T2...	0.44
E08-SYQBR2-D12	Carbide	0.750	0.500	0.438	5.000	1.000	0.475	0.188	-5°	-10°	0.016	YW**11T2...	0.44
E10-SYQBR2-D14	Carbide	0.875	0.625	0.500	7.000	1.250	0.600	0.188	-5°	-8°	0.016	YW**11T2...	0.44

Metric	Material	DMIN	DCONMS	WF	LF	LH	H	f2	GAMP	GAMF	RE**	Insert	Torque*
A12M-SYQBR/L11-D170	Steel	17	12	10.5	150	24	11	4.5	-5°	-10°	0.4	YW**11T2...	0.6
A16Q-SYQBR/L11-D215	Steel	21.5	16	13	180	30	15	5	-5°	-8°	0.4	YW**11T2...	0.6
E12Q-SYQBR/L11-D170	Carbide	17	12	10.5	180	27	11	4.5	-5°	-10°	0.4	YW**11T2...	0.6
E16R-SYQBR/L11-D215	Carbide	21.5	16	13	200	32	15	5	-5°	-8°	0.4	YW**11T2...	0.6

Torque: Recommended clamping torque: lbs-ft (*N·m)

**RE : Standard corner radius

SPARE PARTS

Designation	Clamping screw	Wrench
A/E**-SYQBR/L2-D...	CSTB-2L	T-6F
A/E**-SYQBR/L11-D...	CSTB-2L	T-6F

INSERT SELECTION

P	Application	Finishing to medium cutting	K	Application	Finishing to medium cutting
	Grade	T9225		Grade	GT9530
	Breaker Shape	ZM		Breaker Shape	ZM
	Cutting conditions	B020		Cutting conditions	B024

Reference pages: A/E-SYQBR/L: Insert → B163

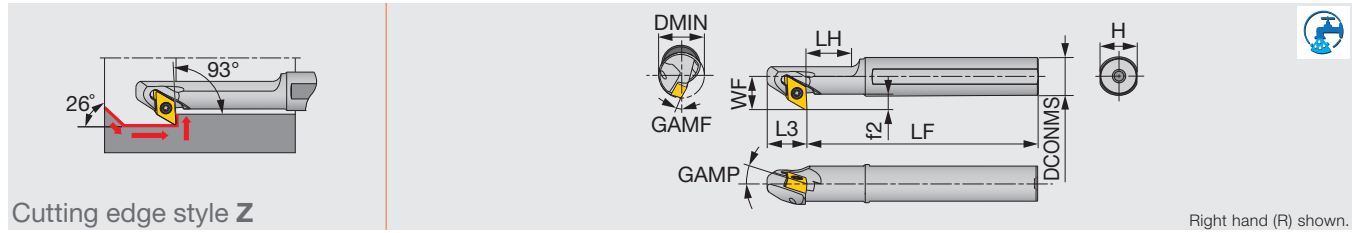

Inch	Material	DMIN	DCONMS	WF	LF	LH	L3	H	f2	GAMP	GAMF	RE**	Insert	Torque
A08-SDZXR/L2-D10	Steel	0.625	0.500	0.438	5.000	1.125	0.500	0.475	0.188	-10°	-14°	0.016	DXGU0703**R/L...	0.66
A10-SDZXR/L2-D11	Steel	0.688	0.625	0.500	7.000	1.250	0.500	0.600	0.188	-10°	-12.5°	0.016	DXGU0703**R/L...	0.66
A12-SDZXR/L2-D14	Steel	0.875	0.750	0.563	7.000	1.375	0.500	0.725	0.188	-10°	-10.5°	0.016	DXGU0703**R/L...	0.66

Metric	Material	DMIN	DCONMS	WF	LF	LH	L3	H	f2	GAMP	GAMF	RE**	Insert	Torque*
A12M-SDZXR/L07-D140	Steel	14	12	10.5	150	30	13	11	4.5	-10°	-14°	0.4	DXGU0703**R/L...	0.9
A16Q-SDZXR/L07-D160	Steel	16	16	12.5	180	35	13	15	4.5	-10°	-12.5°	0.4	DXGU0703**R/L...	0.9
A20R-SDZXR/L07-D200	Steel	20	20	14.5	200	40	13	18	4.5	-10°	-10.5°	0.4	DXGU0703**R/L...	0.9
E12Q-SDZXR/L07-D180	Carbide	18	12	10.5	180	-	13	11	4.5	-11°	-11°	0.4	DXGU0703**R/L...	0.9
E16R-SDZXR/L07-D220	Carbide	22	16	12.5	200	-	13	15	4.5	-11°	-9°	0.4	DXGU0703**R/L...	0.9

Torque: Recommended clamping torque: lbs-ft (*N-m) **RE : Standard corner radius
 Use right-hand toolholders (R) with right-hand inserts (R); and left-hand toolholders (L) with left-hand inserts (L).

SPARE PARTS

Designation	Clamping screw	Wrench
A/E**-SDZXR/L...	SR34-514	T-7F

INSERT SELECTION

P	Application	Finishing	Medium cutting	M	Application	Finishing	Medium cutting
	Grade	NS9530	AH725		Grade	AH8015	AH8015
	Breaker Shape	SS	TS		Breaker Shape	SS	TS
	Cutting conditions	D105			Cutting conditions	D105	

K	Application	Finishing	Medium cutting	N	Application	Finishing	Medium cutting
	Grade	NS9530	AH725		Grade	KS05F	KS05F
	Breaker Shape	SS	TS		Breaker Shape	SS	TS
	Cutting conditions	D105			Cutting conditions	D105	

Reference pages: A/E-SDZXR/L: Insert → **B127** -
 Standard cutting conditions → **D105**

STREAMJETBAR

A/E-SDZCR/L

Screw-on boring bar, for positive 55° rhombic inserts

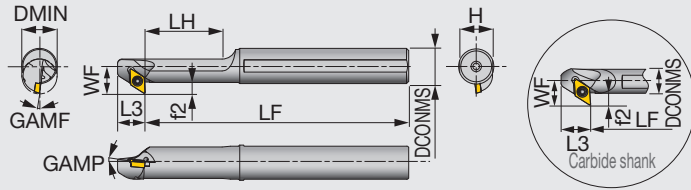
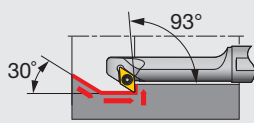

Right hand (R) shown.

Cutting edge style Z

Inch	Material	DMIN	DCONMS	WF	LF	LH	L3	H	f2	GAMP	GAMF	RE**	Insert	Torque
A10-SDZCR2-D14	Steel	0.875	0.625	0.531	7.000	1.250	0.500	0.600	0.219	0°	-4°	0.016	DC**0702...	0.89
Metric	Material	DMIN	DCONMS	WF	LF	LH	L3	H	f2	GAMP	GAMF	RE**	Insert	Torque*
A12M-SDZCR/L07-D140	Steel	14	12	10.5	150	30	12.5	11	4.5	0°	-9°	0.4	DC**0702...	1.2
A16Q-SDZCR/L07-D160	Steel	16	16	12.5	180	35	12.5	15	4.5	0°	-8°	0.4	DC**0702...	1.2
A20R-SDZCR/L11-D200	Steel	20	20	15.5	200	40	15.0	18	5.5	0°	-8°	0.8	DC**11T3...	3
A25S-SDZCR/L11-D250	Steel	25	25	18	250	50	15	23	5.5	0°	-6°	0.8	DC**11T3...	3
E12Q-SDZCR/L07-D180	Carbide	18	12	10.5	180	-	12.5	11	4.5	0°	-8°	0.4	DC**0702...	1.2
E16R-SDZCR/L07-D220	Carbide	22	16	12.5	200	-	12.5	15	4.5	0°	-6°	0.4	DC**0702...	1.2

Torque: Recommended clamping torque: lb-ft (*N·m)

**RE : Standard corner radius

Use right-hand toolholders (SDZCR**) with right-hand inserts (R); and left-hand toolholders (SDZCL**) with left-hand inserts (L).

SPARE PARTS



Designation	Clamping screw	Wrench
A10-SDZCR2-D14	CSTB-2.5	T-8F
A1**-SDZCR/L07-D1*0	CSTB-2.5	T-8F
A2**-SDZCR/L11-D2*0	CSTB-4S	T-15F
E1**-SDZCR/L07-D**0	CSTB-2.5	T-8F

INSERT SELECTION

Application	Precision finishing	Finishing	Finishing to medium cutting	Medium cutting
	SH725	SH725	T9215	T9215
Grade	01	JS	PS	PM
Breaker Shape				
Cutting conditions	B020			

Application	Precision finishing	Finishing	Finishing to medium cutting	Medium cutting
	SH725	SH725	T9215	T9215
Grade	01	JS	PS	PM
Breaker Shape				
Cutting conditions	B022			

Application	Finishing to medium cutting
	T515
Grade	CM
Breaker Shape	
Cutting conditions	B024

Application	Precision finishing	Medium cutting
	DX120	KS05F
Grade	T-DIA	with rake AL
Breaker Shape		
Cutting conditions	B026	

Application	Precision finishing	Finishing to medium cutting
	BX470	AH8005
Grade	T-CBN	PS
Breaker Shape		
Cutting conditions	B028	

Application	Precision finishing	Finishing
	BXM10	BXM20
Grade	T-CBN	T-CBN
Breaker Shape		
Cutting conditions	B030	

Reference pages: A/E-SDZCR/L: Insert → B121 -, CBN → B184, PCD → B196 -

A-PDZNR/L

Lever-lock boring bar, for negative 55° rhombic inserts

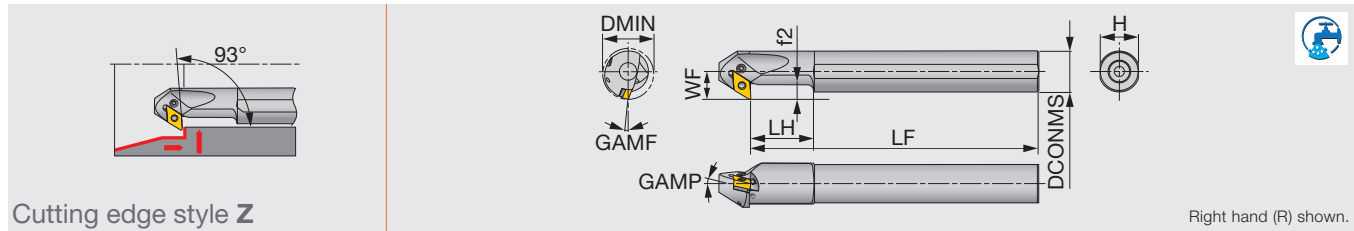

Metric	Material	DMIN	DCONMS	WF	LF	LH	H	f2	GAMP	GAMF	RE**	Insert	Torque
A32S-PDZNR/L15-D400	Steel	40	32	22	250	50	30	11.5	-6°	-13°	0.8	DN**1504...	4.8
A40T-PDZNR/L15-D500	Steel	50	40	27	300	60	37	14.5	-6°	-10°	0.8	DN**1504...	4.8
A50U-PDZNR/L15-D630	Steel	63	50	35	350	65	47	14.5	-6°	-8°	0.8	DN**1504...	4.8

Torque: Recommended clamping torque: N·m

**RE : Standard corner radius

Use right-hand toolholders (PDZNR**) with right-hand inserts (R); and left-hand toolholders (PDZNL**) with left-hand inserts (L).

Designation	Shim	Clamping screw	Wrench	Spring pin	Lever	Oil supply attachment*	Screw for oil hole*
A32S-PDZNR15-D400	LSZ42BR	LCS4	P-3	LSP4	LCL4	EA-32	SSHM4-5
A32S-PDZNL15-D400	LSZ42BL	LCS4	P-3	LSP4	LCL4	EA-32	SSHM4-5
A40T-PDZNR15-D500	LSZ42BR	LCS4	P-3	LSP4	LCL4	-	SSHM5-6
A40T-PDZNL15-D500	LSZ42BL	LCS4	P-3	LSP4	LCL4	-	SSHM5-6
A50U-PDZNR15-D630	LSZ42BR	LCS4	P-3	LSP4	LCL4	-	SSHM6-6
A50U-PDZNL15-D630	LSZ42BL	LCS4	P-3	LSP4	LCL4	-	SSHM6-6

*Optional

INSERT SELECTION

P	Application	Precision finishing	Finishing	Medium cutting	Medium to heavy cutting
	Grade	NS9530	GT9530	T9215	T9215
	Breaker Shape	TF	TSF	TM	TH
	Cutting conditions	B008			
M	Application	Finishing	Medium cutting	Medium to heavy cutting	
	Grade	T6120	T6130	T6130	
	Breaker Shape	SF	SM	SH	
	Cutting conditions	B010			
K	Application	Finishing	Medium cutting	Medium to heavy cutting	
	Grade	T515	T515	T515	
	Breaker Shape	All-round	All-round	All-round	
	Cutting conditions	B012			
N	Application	Precision finishing	Finishing	Medium cutting	
	Grade	DX120	DX140	TH10	
	Breaker Shape	T-DIA	with rake T-DIA	P	
	Cutting conditions	B014			
S	Application	Precision finishing	Finishing	Medium cutting	
	Grade	BX470	AH8005	AH8005	
	Breaker Shape	T-CBN	HRF	HRM	
	Cutting conditions	B016			
H	Application	Precision finishing	Finishing		
	Grade	BXM10	BXM20		
	Breaker Shape	T-CBN	T-CBN		
	Cutting conditions	B018			

Reference pages: A-PDZNR/L: Insert → **B067 -**, CBN → **B174 -**, PCD → **B194 -**



S-PDZNR/L

Lever-lock boring bar, for negative 55° rhombic inserts

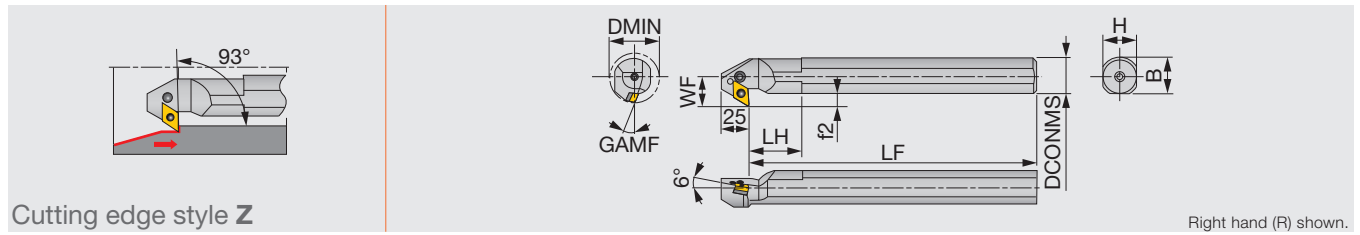

Metric	Material	DMIN	DCONMS	WF	LF	LH	H	f2	B	GAMF	RE**	Insert
S32S-PDZNR/L15	Steel	40	32	22	250	30	30	6	29.5	-13°	0.8	DN**1504...
S40T-PDZNR15	Steel	50	40	27	300	35	37	7	37.5	-10°	0.8	DN**1504...
S50U-PDZNR15	Steel	60	50	35	350	40	47	10	47.5	-8°	0.8	DN**1504...

SPARE PARTS

Designation	Shim	Clamping screw	Wrench	Spring pin	Lever
S32S-PDZNR15	LSZ42BR	LCS4	P-3	LSP4	LCL4
S32S-PDZNL15	LSZ42BL	LCS4	P-3	LSP4	LCL4
S*0*-PDZNR15	LSZ42BR	LCS4	P-3	LSP4	LCL4

**RE : Standard corner radius

Use right-hand toolholders (R) with right-hand inserts (R); and left-hand toolholders (L) with left-hand inserts (L)

INSERT SELECTION

Application	Precision finishing	Finishing	Medium cutting	Medium to heavy cutting
	Grade	NS9530	GT9530	T9215
Breaker Shape	TF	TSF	TM	TH
Cutting conditions	B008			

Application	Finishing	Medium cutting	Medium to heavy cutting
	Grade	T6120	T6130
Breaker Shape	SF	SM	SH
Cutting conditions	B010		

Application	Finishing	Medium cutting	Medium to heavy cutting
	Grade	T515	T515
Breaker Shape	All-round	All-round	All-round
Cutting conditions	B012		

Application	Precision finishing	Finishing	Medium cutting
	Grade	DX120	DX140
Breaker Shape	T-DIA	T-DIA with rake	P
Cutting conditions	B014		

Application	Precision finishing	Finishing	Medium cutting
	Grade	BX470	AH8005
Breaker Shape	T-CBN	HRF	HRM
Cutting conditions	B016		

Application	Precision finishing	Finishing
	Grade	BXM10
Breaker Shape	T-CBN	T-CBN
Cutting conditions	B018	

Reference pages: S-PDZNR/L: Insert → B067 -, CBN → B174 -, PCD → B194 -

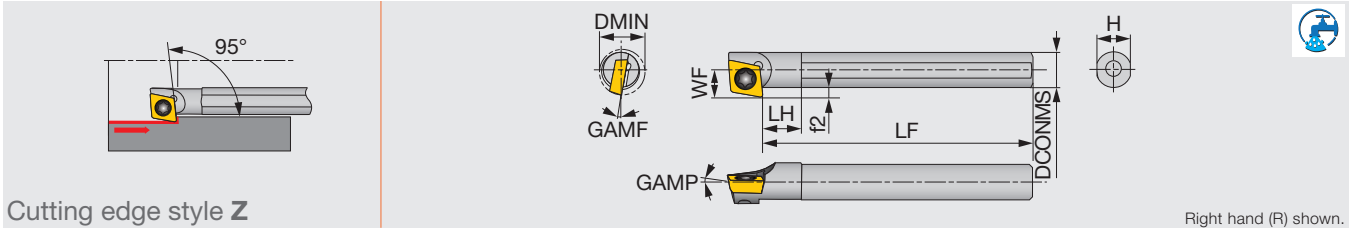

Cutting edge style Z

Right hand (R) shown.

Metric	Material	DMIN	DCONMS	WF	LF	LH	H	f2	GAMP	GAMF	RE**	Insert	Torque
A04F-SEZPR/L03-D055	Steel	5.5	4	3.2	80	4	3.8	1.2	0°	-8°	0.2	EP**03X1...	0.6
A05F-SEZPR/L03-D065	Steel	6.5	5	3.7	80	5	4.8	1.2	0°	-6°	0.2	EP**03X1...	0.6
E04G-SEZPR/L03-D055	Carbide	5.5	4	3.2	90	5	3.8	1.2	0°	-8°	0.2	EP**03X1...	0.6
E05G-SEZPR/L03-D065	Carbide	6.5	5	3.7	90	6	4.8	1.2	0°	-6°	0.2	EP**03X1...	0.6

Torque: Recommended clamping torque: N·m

**RE : Standard corner radius

Use right-hand toolholders (SEZPR**) with right-hand inserts (R); and left-hand toolholders (SEZPL**) with left-hand inserts (L).

SPARE PARTS

Designation	Clamping screw	Wrench
A**-SEZPR/L03-D...	CSTA-1.6	T-6F
E**-SEZPR/L03-D...	CSTA-1.6	T-6F

INSERT SELECTION

P	Application	Finishing	M	Application	Finishing	K	Application	Finishing
	Grade	SH725		Grade	SH725		Grade	SH725
	Breaker Shape	JS		Breaker Shape	JS		Breaker Shape	JS
Cutting conditions		B008	Cutting conditions		B010	Cutting conditions		B012
N	Application	Precision finishing	Finishing	H	Application	Precision finishing		
	Grade	DX140	GH110		Grade	BX310		
	Breaker Shape	T-DIA	W08		Breaker Shape	T-CBN		
Cutting conditions		B014		Cutting conditions		B018		

A-SVZBR/L

Screw-on boring bar, for positive 35° rhombic inserts

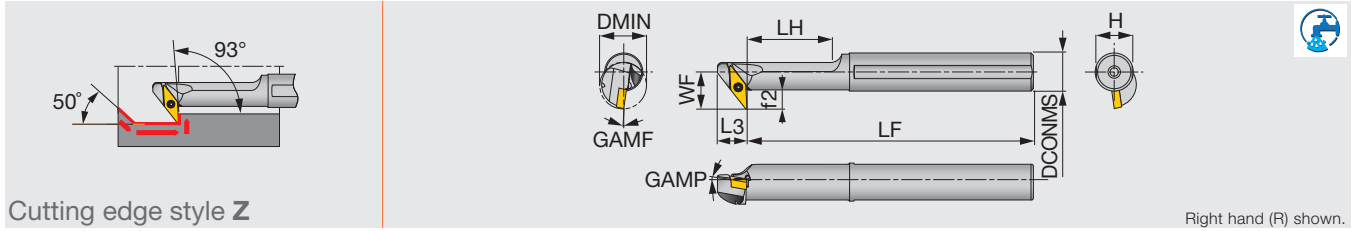

Cutting edge style Z

Right hand (R) shown.

Inch	Material	DMIN	DCONMS	WF	LF	LH	L3	H	f2	GAMP	GAMF	RE**	Insert	Torque
A12-SVZBR2-D16	Steel	1.000	0.750	0.594	10.000	1.425	0.500	0.725	0.219	0°	-5°	0.016	VB**1103...	0.89
Metric	Material	DMIN	DCONMS	WF	LF	LH	L3	H	f2	GAMP	GAMF	RE**	Insert	Torque*
A16Q-SVZBR/L11-D200	Steel	20	16	15.5	180	35	12.5	15	8	0°	-8°	0.4	VB**1103...	1.2
A20R-SVZBR/L11-D250	Steel	25	20	17.5	200	40	12.5	18	8	0°	-7°	0.4	VB**1103...	1.2
A25S-SVZBR/L16-D320	Steel	32	25	24	250	50	17.5	23	12	0°	-6°	0.8	VB**1604...	3
A32T-SVZBR/L16-D400	Steel	40	32	27.5	300	72	17.5	30	12	0°	-5°	0.8	VB**1604...	3

Torque: Recommended clamping torque: lbs-ft (*N-m)

**RE : Standard corner radius

Use right-hand toolholders (SVZBR**) with right-hand inserts (R); and left-hand toolholders (SVZBL**) with left-hand inserts (L).

SPARE PARTS

Designation	Clamping screw	Wrench
A12-SVZBR2-D16	CSTB-2.5	T-8F
A**-SVZBR/L11-D2*0	CSTB-2.5	T-8F
A25S-SVZBR/L16-D320	CSTB-3.5	T-15F
A32T-SVZBR/L16-D400	CSTB-3.5L	T-15F

INSERT SELECTION

Application	Finishing	Finishing to medium cutting
	Grade	SH725
Breaker Shape	JS	PS
Cutting conditions	B020	

Application	Finishing	Finishing to medium cutting
	Grade	SH725
Breaker Shape	JS	PS
Cutting conditions	B022	

Application	Finishing to medium cutting
	Grade
Breaker Shape	CM
Cutting conditions	B024

Application	Precision finishing	Finishing
	Grade	BXM10
Breaker Shape	T-CBN	T-CBN
Cutting conditions	B030	

Reference pages: A-SVZBR/L: Insert → B152 -, CBN → B191

A-SVZCR/L

Screw-on boring bar, for positive 35° rhombic inserts

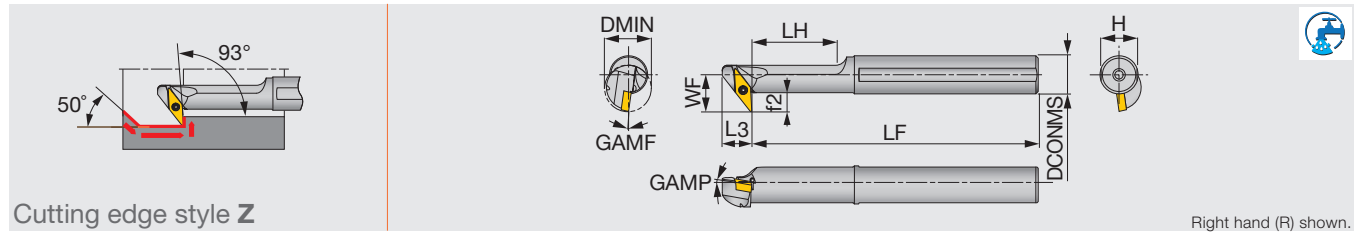

Cutting edge style Z

Right hand (R) shown.

Inch	Material	DMIN	DCONMS	WF	LF	LH	L3	H	f2	GAMP	GAMF	RE**	Insert	Torque
A08-SVZCR6-D12	Steel	0.750	0.500	0.438	5.000	1.000	0.395	0.475	0.188	0°	-6°	0.016	VC**63...	0.44
A12-SVZCR2-D16	Steel	1.000	0.750	0.593	10.000	1.425	0.500	0.725	0.218	0°	-7°	0.016	VC**22...	0.44

Metric	Material	DMIN	DCONMS	WF	LF	LH	L3	H	f2	GAMP	GAMF	RE**	Insert	Torque*
A12M-SVZCR/L08-D160	Steel	16	12	11	150	30	10	11	5.5	0°	-8°	0.4	VC**0802...	0.6

Torque: Recommended clamping torque: lbs-ft (*N-m)

**RE : Standard corner radius

Use right-hand toolholders (SVZCR**) with right-hand inserts (R); and left-hand toolholders (SVZCL**) with left-hand inserts (L).

SPARE PARTS



Designation	Clamping screw	Wrench
A08-SVZCR6-D12	CSTB-2L	T-6F
A12-SVZCR2-D16	CSTB-2.5	T-8F
A12M-SVZCR/L08-D160	CSTB-2L	T-6F

INSERT SELECTION

P	Application	Finishing to medium cutting	M	Application	Finishing to medium cutting	
	Grade	T9215		Grade	T9215	
	Breaker Shape	PS		Breaker Shape	PS	
	Cutting conditions	B020		Cutting conditions	B022	
K	Application	Finishing to medium cutting	N	Application	Precision finishing	Medium cutting
	Grade	T515		Grade	DX120	KS05F
	Breaker Shape	CM		Breaker Shape	T-DIA with rake AL	
	Cutting conditions	B024		Cutting conditions	B026	
S	Application	Finishing to medium cutting	H	Application	Precision finishing	Finishing
	Grade	AH8005		Grade	BXM10	BXM20
	Breaker Shape	PS		Breaker Shape	T-CBN	T-CBN
	Cutting conditions	B028		Cutting conditions	B030	

Reference pages: A-SVZCR/L: Insert → **B155** -



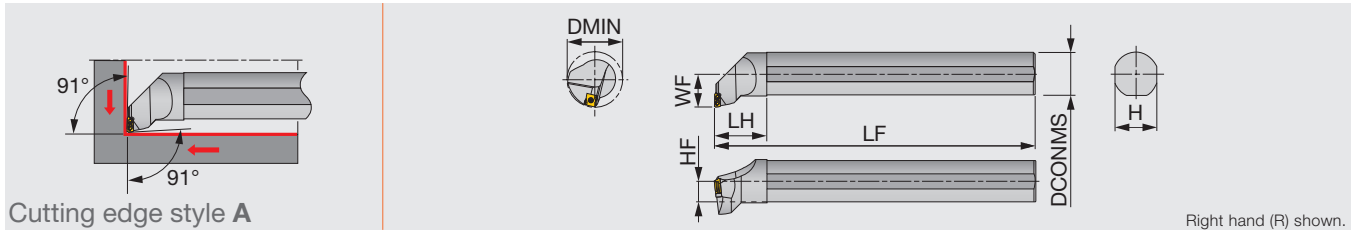

Inch	Material	DMIN	DCONMS	WF	LF	LH	H	HF	Insert
S16-TLANR/L12-D34	Steel	2.090	1.000	0.670	12.000	1.500	0.920	0.460	LNMX1204**L/R...
S20-TLANR/L12-D34	Steel	2.090	1.250	0.870	14.000	1.750	1.140	0.570	LNMX1204**L/R...
S24-TLANR/L12-D34	Steel	2.090	1.500	1.060	16.000	2.000	1.340	0.670	LNMX1204**L/R...
S32-TLANR/L16-D54	Steel	3.350	2.000	1.460	16.000	2.360	1.810	0.905	LNMX1606**L/R...

Use right-hand toolholders (TLANR**) with left-hand inserts (L); and left-hand toolholders (TLANL**) with right-hand inserts (R).

SPARE PARTS

Designation	Clamping screw	Shim screw	Shim	Spring pin	Wrench 1	Wrench 2
S**-TLANR/L12-D34	CSTB-3.5L115-S	CSTF-2L055-S	TSL12L/RI	-	KEYV-T10	T-6F-S
S32-TLANR16-D54	CSTB-4L115-S	-	TSL16LI	PSP-16	KEYV-T15	-
S32-TLANL16-D54	CSTB-4L115-S	-	TSL16RI	PSP-16	KEYV-T15	-

INSERT
LNMX12/16/24

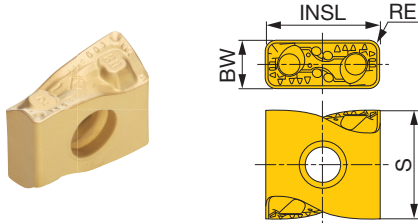

P	Steel	★	★	★							
M	Stainless			☆							
K	Cast iron	☆	☆	☆							
N	Non-ferrous										
S	Superalloys										
H	Hard materials										

★ : First choice
☆ : Second choice

Designation	HAND	RE (in)	Coated							BW (in)	INSL (in)	S (in)
			T9115	T9125	AH725							
LNMX120408R-TDR	R	0.031	●	●						0.189	0.472	0.457
LNMX120408L-TDR	L	0.031	●	●						0.189	0.472	0.457
LNMX120412R-TDR	R	0.047	●	●						0.189	0.472	0.457
LNMX120412L-TDR	L	0.047	●	●						0.189	0.472	0.457
LNMX160608R-TDR	R	0.031	●	●						0.252	0.638	0.531
LNMX160608L-TDR	L	0.031	●	●						0.252	0.638	0.531
LNMX160612R-TDR	R	0.047	●	●						0.252	0.638	0.531
LNMX160612L-TDR	L	0.047	●	●						0.252	0.638	0.531
LNMX160616R-TDR	R	0.063	●	●						0.252	0.638	0.531
LNMX160616L-TDR	L	0.063	●	●						0.252	0.638	0.531
LNMX241016R-TDR	R	0.063	●	●						0.370	0.945	0.807
LNMX241016L-TDR	L	0.063	●	●						0.370	0.945	0.807
LNMX241024R-TDR	R	0.094	●	●						0.370	0.945	0.807
LNMX241024L-TDR	L	0.094	●	●						0.370	0.945	0.807
LNMX160608R-MDR	R	0.031	●	●	●					0.252	0.638	0.531
LNMX160608L-MDR	L	0.031	●	●	●					0.252	0.638	0.531
LNMX160612R-MDR	R	0.047	●	●	●					0.252	0.638	0.531
LNMX160612L-MDR	L	0.047	●	●	●					0.252	0.638	0.531
LNMX160608R-TWR	R	0.031	●	●						0.252	0.638	0.531
LNMX160608L-TWR	L	0.031	●	●						0.252	0.638	0.531
LNMX160612R-TWR	R	0.047	●	●						0.252	0.638	0.531
LNMX160612L-TWR	L	0.047	●	●						0.252	0.638	0.531

● : Line up

Grade
Insert
Ext. Toolholder
Int. Toolholder
Threading
Grooving
Miniature Tool
Milling Cutter
Endmill
Drilling Tool
Tooling System
User's Guide
Index



Technical Guide

STREAMJETBAR

BLM sleeve

Round shank sleeve for StreamJetBar-Mini series

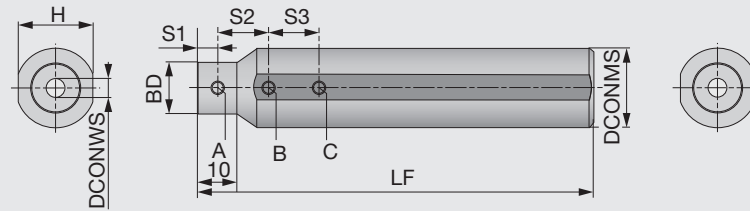

Metric	DCONMS	DCONWS	BD	LF	H	S1	S2	S3
BLM159-04	15.875 (0.625")	4	15	100	15	5	15	15
BLM159-05	15.875 (0.625")	5	15	100	15	5	15	15
BLM159-06	15.875 (0.625")	6	15	100	15	5	20	20
BLM159-07	15.875 (0.625")	7	15	100	15	5	20	20
BLM16-04	16	4	15	100	15	5	15	15
BLM16-05	16	5	15	100	15	5	15	15
BLM16-06	16	6	15	100	15	5	20	20
BLM16-07	16	7	15	100	15	5	20	20
BLM19-04	19.05 (0.750")	4	18	100	18	5	15	15
BLM19-05	19.05 (0.750")	5	18	100	18	5	15	15
BLM19-06	19.05 (0.750")	6	18	100	18	5	20	20
BLM19-07	19.05 (0.750")	7	18	100	18	5	20	20
BLM20-04	20	4	13	100	19	5	15	15
BLM20-05	20	5	14	100	19	5	15	15
BLM20-06	20	6	15	100	19	5	20	20
BLM20-07	20	7	16	100	19	5	20	20
BLM22-04	22	4	13	125	21	5	15	15
BLM22-05	22	5	14	125	21	5	15	15
BLM22-06	22	6	15	125	21	5	20	20
BLM22-07	22	7	16	125	21	5	20	20
BLM25-04	25	4	13	125	24	5	15	15
BLM25-05	25	5	14	125	24	5	15	15
BLM25-06	25	6	15	125	24	5	20	20
BLM25-07	25	7	16	125	24	5	20	20
BLM254-04	25.4 (1.000")	4	13	125	24	5	15	15
BLM254-05	25.4 (1.000")	5	14	125	24	5	15	15
BLM254-06	25.4 (1.000")	6	15	125	24	5	20	20
BLM254-07	25.4 (1.000")	7	16	125	24	5	20	20

SPARE PARTS



Designation	Clamping screw A	Clamping screw B, C	Wrench	Seal cap* (inner screw)
BLM159, 16...	SSH4-4	SSH4-4	P-2	CA-16(M6)
BLM19-04	SSH4-4	SSH4-6	P-2	CA-16(M6)
BLM19-05, 06, 07	SSH4-4	SSH4-4	P-2	CA-16(M6)
BLM20-04, 05	SSH4-4	SSH4-6	P-2	CA-16(M6)
BLM20-06, 07	SSH4-4	SSH4-4	P-2	CA-16(M6)
BLM22-...	SSH4-4	SSH4-6	P-2	CA-16(M6)
BLM25-04, 05	SSH4-4	SSH4-8	P-2	CA-16(M6)
BLM25-06	SSH4-4	SSH4-8	P-2	CA-16(M6)
BLM25-07	SSH4-4	SSH4-6	P-2	CA-16(M6)
BLM254-04, 05, 06	SSH4-4	SSH4-8	P-2	CA-16(M6)
BLM254-07	SSH4-4	SSH4-6	P-2	CA-16(M6)

*Optional

BLS sleeve

Square shank sleeve for boring bars (regular length)

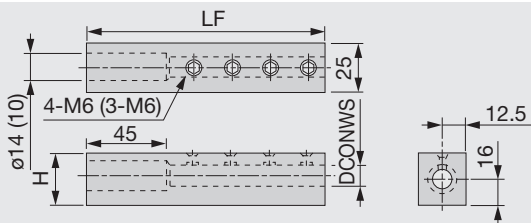

Metric	DCONWS	LF	H
BLS16-08	8	125	28
BLS16-10	10	125	28
BLS16-12	12	125	28

SPARE PARTS

Designation	Wrench
BLS16-...	P-3

BLS-C sleeve

Square shank sleeve for boring bars (short type)

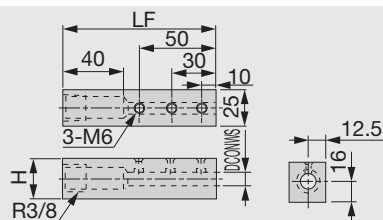

Metric	DCONWS	LF	H
BLS16-08C	8	100	28
BLS16-10C	10	100	28
BLS16-12C	12	100	28

SPARE PARTS

Designation	Wrench
BLS16-**C	P-3

BLM sleeve

Round shank sleeve for boring bars

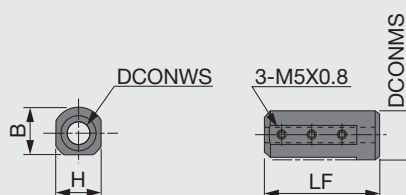

Metric	DCONWS	DCONMS	LF	H	B
BLM19-08	8	19.05	100	18	18
BLM20-08	8	20	100	18	19
BLM22-08	8	22	125	21	21
BLM254-08	8	25.4	125	24	24
BLM25-08C	8	25	55	23	24
BLM25-10C	10	25	55	23	24
BLM25-12C	12	25	55	23	24

SPARE PARTS

Designation	Wrench
BLM...	P-2.5

BLC sleeve

Round shank sleeve for boring bars

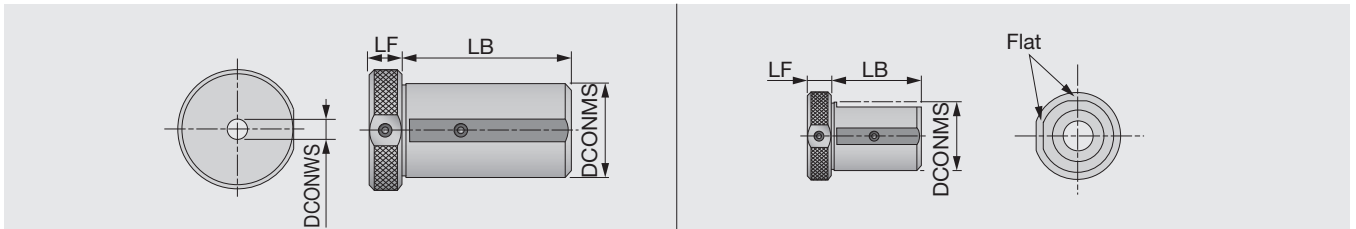

Metric	DCONWS	LB	LF	DCONMS
BLC40-8	8	73	13	40
BLC40-10	10	73	13	40
BLC40-12	12	73	13	40
BLC40-16	16	73	13	40
BLC32-8C	8	45	20	32
BLC32-10C	10	45	20	32
BLC32-12C	12	45	20	32
BLC40-8C	8	55	13	40
BLC40-10C	10	55	13	40
BLC40-12C	12	55	13	40
BLC40-16C	16	55	13	40

SPARE PARTS



Designation	Wrench
BLC40-8	P-3
BLC40-1...	P-4
BLC32-8C	P-3
BLC32-1*C	P-4
BLC40-8C	P-3
BLC40-1*C	P-4

MINIFORCE

STANDARD CUTTING CONDITIONS

Internal turning

ISO	Workpiece material	Grade			Cutting speed Vc (sfm)	Depth of cut ap (in)	Feed f (ipr)
		First Choice	For surface finish	For wear resistance (High speed)			
P	Low carbon steel 1025, etc.	AH725	-	-	164 - 180	0.012 - 0.079	0.003 - 0.012
		-	-	AH8015	164 - 656	0.012 - 0.079	0.003 - 0.012
		-	NS9530	-	262 - 820	0.012 - 0.079	0.003 - 0.012
		-	GT9530	-	262 - 984	0.012 - 0.079	0.003 - 0.012
	Carbon steel 1045, 1055, etc.	AH725	-	-	164 - 591	0.012 - 0.079	0.003 - 0.012
		-	-	AH8015	164 - 656	0.012 - 0.079	0.003 - 0.012
		-	NS9530	-	262 - 820	0.012 - 0.079	0.003 - 0.012
	Low alloy steel 4140, etc.	-	GT9530	-	262 - 984	0.012 - 0.079	0.003 - 0.012
		AH725	-	-	164 - 591	0.012 - 0.079	0.003 - 0.012
		-	-	AH8015	164 - 656	0.012 - 0.079	0.003 - 0.012
	Alloy steel 5120, etc.	-	NS9530	-	262 - 820	0.012 - 0.079	0.003 - 0.012
		-	GT9530	-	262 - 984	0.012 - 0.079	0.003 - 0.012
AH725		-	-	164 - 591	0.012 - 0.079	0.003 - 0.012	
M	Stainless steel (Austenitic) 304, etc.	-	-	AH8015	164 - 656	0.012 - 0.079	0.003 - 0.012
		AH8015	-	-	164 - 492	0.012 - 0.079	0.003 - 0.012
		-	NS9530	-	262 - 820	0.012 - 0.079	0.003 - 0.012
Stainless steel (Martensitic and ferritic) 430, etc.	-	GT9530	-	262 - 984	0.012 - 0.079	0.003 - 0.012	
	AH8015	-	-	164 - 492	0.012 - 0.079	0.003 - 0.012	
	-	NS9530	-	262 - 820	0.012 - 0.079	0.003 - 0.012	
Stainless steel (Precipitation hardening) 174, etc.	-	GT9530	-	262 - 984	0.012 - 0.079	0.003 - 0.012	
	AH8015	-	-	164 - 492	0.012 - 0.079	0.003 - 0.012	
	-	NS9530	-	262 - 820	0.012 - 0.079	0.003 - 0.012	
K	Gray cast iron No.250B, etc.	AH725	-	-	164 - 591	0.012 - 0.079	0.003 - 0.012
		-	-	AH8015	164 - 656	0.012 - 0.079	0.003 - 0.012
		-	NS9530	-	262 - 820	0.012 - 0.079	0.003 - 0.012
	Ductile cast iron 80-55-60, etc.	-	GT9530	-	262 - 984	0.012 - 0.079	0.003 - 0.012
		AH725	-	-	164 - 591	0.012 - 0.079	0.003 - 0.012
		-	-	AH8015	164 - 656	0.012 - 0.079	0.003 - 0.012
N	Non ferrous Metal Aluminum alloy, etc.	-	NS9530	-	262 - 820	0.012 - 0.079	0.003 - 0.012
		-	GT9530	-	262 - 984	0.012 - 0.079	0.003 - 0.012
S	Heat-resistant alloys Titanium alloys, etc.	KS05F	-	-	328 - 984	0.012 - 0.079	0.003 - 0.012
		KS05F	-	-	328 - 984	0.012 - 0.079	0.003 - 0.012
S	Heat-resistant alloys Nickel-base alloys	AH8015	-	-	66 - 262	0.012 - 0.079	0.003 - 0.012
		AH8015	-	-	66 - 262	0.012 - 0.079	0.003 - 0.012

Reference pages: A/E-SWLXR/L → **D034**, A/E-SDXXR/L → **D042**
A/E-SDZXR/L → **D093**



Technical Guide



STANDARD CUTTING CONDITIONS

LNMX1204

*Values in red are for facing.

ISO	Workpiece material	Chip breaker	Grade	Cutting speed Vc (sfm)	Depth of cut: ap (in)		Feed: f (ipr)	
					RE : 0.031	RE : 0.047	RE : 0.031	RE : 0.047
P	Steels 1045, 4130, etc.	TDR	T9115	390 - 820	0.020 - 0.195 0.020 - 0.086	0.031 - 0.195 0.031 - 0.086	0.006 - 0.024	0.010 - 0.031
		TDR	T9125	260 - 590	0.020 - 0.195 0.020 - 0.086	0.031 - 0.195 0.031 - 0.086	0.006 - 0.024	0.010 - 0.031
M	Stainless steels 304, 316, etc.	TDR	T9115	330 - 590	0.020 - 0.195 0.020 - .086	0.031 - 0.195 0.031 - 0.086	0.006 - 0.024	0.010 - 0.031
		TDR	T9125	260 - 590	0.020 - 0.195 0.020 - 0.086	0.031 - 0.195 0.031 - 0.086	0.006 - 0.024	0.010 - 0.031

LNMX1606

ISO	Workpiece material	Chip breaker	Grade	Cutting speed Vc (sfm)	Depth of cut: ap (in)			Feed: f (ipr)		
					RE : 0.031	RE : 0.047	RE : 0.063	RE : 0.031	RE : 0.047	RE : 0.063
P	Steels 1045, 4130, etc.	TDR	T9115	390 - 820	0.020 - 0.197 0.020 - .126	0.031 - 0.236 .031 - .126	0.039 - 0.315 0.039 - 0.126	0.006 - 0.024	0.010 - 0.031	0.012 - 0.039
		TDR	T9125	260 - 590	0.020 - 0.197 0.020 - .126	0.031 - 0.236 .031 - .126	0.039 - 0.315 0.039 - 0.126	0.006 - 0.024	0.010 - 0.031	0.012 - 0.039
		TWR	T9115	390 - 820	0.020 - 0.197 0.020 - 0.126	0.031 - 0.236 0.031 - 0.126	-	0.006 - 0.024	0.010 - 0.031	-
		TWR	T9125	260 - 590	0.020 - 0.197 0.020 - 0.126	0.031 - 0.236 0.031 - 0.126	-	0.006 - 0.024	0.010 - 0.031	-
M	Stainless steels 304, 316, etc.	TDR	T9115	330 - 590	0.020 - 0.197 0.020 - 0.126	0.031 - 0.236 0.031 - 0.126	0.039 - 0.315 0.039 - 0.126	0.006 - 0.024	0.010 - 0.031	0.012 - 0.039
		TDR	T9125	260 - 590	0.020 - 0.197 0.020 - 0.126	0.031 - 0.236 0.031 - 0.126	0.039 - 0.315 0.039 - 0.126	0.006 - 0.024	0.010 - 0.031	0.012 - 0.039
		MDR	T9115	330 - 490	0.059 - 0.236 0.020 - 0.126	0.059 - 0.276 0.031 - 0.126	-	0.004 - 0.020	0.006 - 0.028	-
		MDR	AH725	160 - 490	0.059 - 0.236 0.020 - 0.126	0.059 - 0.276 0.031 - 0.126	-	0.004 - 0.020	0.006 - 0.028	-
		TWR	T9115	330 - 590	0.020 - 0.197 0.020 - 0.126	0.031 - 0.236 0.031 - 0.126	-	0.006 - 0.024	0.010 - 0.031	-
		TWR	T9125	260 - 590	0.020 - 0.197 0.020 - 0.126	0.031 - 0.236 0.031 - 0.126	-	0.006 - 0.024	0.010 - 0.031	-

LNMX2410

ISO	Workpiece material	Chip breaker	Grade	Cutting speed Vc (sfm)	Depth of cut: ap (in)		Feed: f (ipr)	
					RE : 0.063	RE : 0.094	RE : 0.063	RE : 0.094
P	Steels 1045, 4130, etc.	TDR	T9115	390 - 820	0.156 - 0.585 0.039 - 0.176	0.195 - 0.585 0.039 - 0.176	0.012 - 0.039	0.012 - 0.043
		TDR	T9125	260 - 490	0.156 - 0.585 0.039 - 0.176	0.195 - 0.585 0.039 - 0.176	0.012 - 0.039	0.012 - 0.043
M	Stainless steels 304, 316, etc.	TDR	T9115	330 - 590	0.156 - 0.585 0.039 - 0.176	0.195 - 0.585 0.039 - 0.176	0.012 - 0.039	0.012 - 0.043
		TDR	T9125	260 - 490	0.156 - 0.585 0.039 - 0.176	0.195 - 0.585 0.039 - 0.176	0.012 - 0.039	0.012 - 0.043

Reference pages: S-TLANR/L → **D100**

Threading Tool







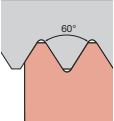
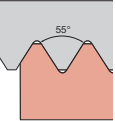
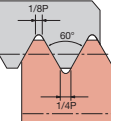
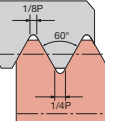
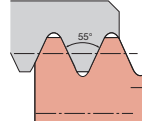
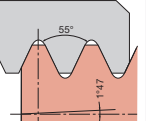
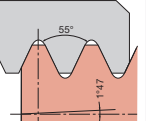
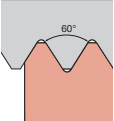
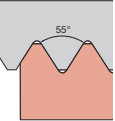
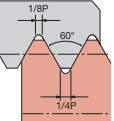
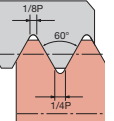
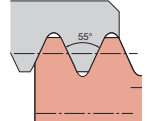
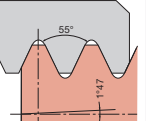
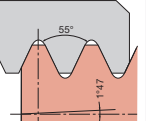

Main products

Thread form	
60°	E010
55°	E014
M (Metric)	E016
UN (Unified)	E018
W (Whitworth)	E020
BSPT (R, PT)	E021
NPT	E022
NPTF	E023
TR (Metric, 30° Trapezoidal)	E024
Round (DIN405)	E024
UNJ	E025
MJ	E025
ACME (29° Trapezoidal)	E026
STUB ACME (29° Trapezoidal)	E027
API Round	E028
API Butress	E029
API Rotary Shoulder Connection	E031

		Inch	Metric
	<h2>TUNGTHREAD</h2> <h3>Lay down insert, toolholder</h3> <p>Standard items cover a wide variety of threading inserts. Standard tool series with double-clamp system for excellent insert stability in machining API-standard threads.</p>	✓	✓
	<p>E004 - E007 E010 - E042 E053, E054</p>		
	<h3>On edge insert, toolholder</h3> <p>ACME and STUB ACME inserts can be used for the range of 16 to 3TPI with 2 types of toolholders. The special full-profile insert realizes both the fine adjustment of thread height and the minimum burr on the crest.</p>	✓	✓
	<p>E004 - E007 E026 - E030 E040 - E041</p>		
	<h3>Chaser</h3> <p>Threading tool with multiple cutting edges for highly efficient machining of API-standard round, buttress, and NPT.</p>	✓	✓
	<p>E005 - E007 E023, E028 - E031 E042</p>		
	<h2>TETRAMCUT</h2> <p>Reduced interference with tailstock in small diameter threading.</p>	✓	✓
	<p>E004 - E008 E011 E042 - E043 E055</p>		
	<h2>DUOJUST</h2> <p>Standard threading tool for Swiss machine. Shortest undercut possible between thread and workpiece face due to better accessibility.</p>	✓	
	<p>E004 - E009 E011, E048 E055</p>		
	<h2>TUNG-CLAMP</h2> <p>Tool with high clamp rigidity that firmly holds the insert with a clamp. Grooving insert and threading insert can be used with the same toolholder.</p>	✓	
	<p>E004 - E006 E012 E049 - E050 E055</p>		
	<h2>J-SERIES</h2> <p>Tool series with 3-cornered inserts. Subselection for threading on Swiss lathes. Standard tool also suitable for radial Swiss lathes.</p>	✓	✓
	<p>E004 E012 - E013 E015 E051 - E052</p>		
	<h2>TINYTURN</h2> <p>Internal threading tool suitable for the minimum machining diameter ø4. All tools have oil holes that can supply coolant from the cutting edge.</p>		✓
	<p>E006, E052, E056</p>		
	<h3>Other tool</h3> <p>TT type</p>	✓	✓
	<p>E004 - E006 E013, E015 E053 - E054</p>		

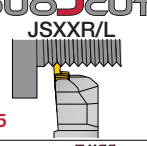
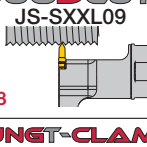
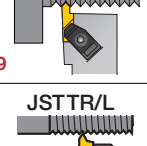
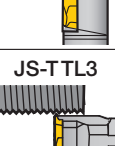
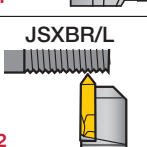
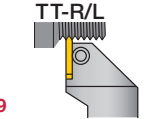
Applicable tool for each external thread type

Applicable tool for each external thread type	General purpose		General purpose		Pipe		
Thread type	National taper pipe		Full profile				
	60°	55°	ISO metric	Unified	Whitworth	Parallel pipe thread	Taper pipe thread
	-	-	M	UNC, UNF UNEF	BSW, BSF W	G BSP, PF	R, PT, BSPT
Thread form							
Tool type							
 ST type E034	0.5 ~ 6 mm (0.020" ~ 0.250") 48 ~ 4TPI E010	0.020" ~ 0.200" 48 ~ 5TPI E014	0.020" ~ 0.250" E016	32 ~ 5TPI E018	28 ~ 5TPI E020	28 ~ 11TPI E021	
 TETRAMCUT STCR/L-18 E043	0.4 ~ 3 mm (0.016" ~ 0.125") 64 ~ 8TPI E011	---	---	---	---	---	
 TETRAMCUT JS-STCL18 E044	0.4 ~ 3 mm (0.016" ~ 0.125") 64 ~ 8TPI E011	---	---	---	---	---	
 DUOJCUT JSXXR/L E045	0.2 ~ 1.5 mm (0.008" ~ 0.0625") 127 ~ 16TPI E011	---	---	---	---	---	
 DUOJCUT JS-SXXL09 E048	0.2 ~ 1.5 mm (0.008" ~ 0.0625") 127 ~ 16TPI E011	---	---	---	---	---	
 TUNG-CLAMP E049	1.27 ~ 4.23 mm (0.050" ~ 0.167") 20 ~ 6TPI E012	---	---	---	---	---	
 JSTTR/L E051	0.5 ~ 1 mm (0.021" ~ 0.025") 48 ~ 25TPI E012	0.021" ~ 0.025" 48 ~ 25TPI E015	---	---	---	---	
 JS-TTL3 E051	0.5 ~ 1 mm (0.021" ~ 0.025") 48 ~ 25TPI E012	0.021" ~ 0.025" 48 ~ 25TPI E015	---	---	---	---	
 JSXBR/L E052	0.5 ~ 1 mm (0.021" ~ 0.025") 48 ~ 25TPI E013	---	---	---	---	---	
 TT-R/L E049	~ 3 mm (~ 0.125") ~ 8TPI E013	~ 0.125" ~ 8TPI E015	---	---	---	---	

Please see the page E*** for the product details.

Applicable tool for each external thread type	Pipe		Machine parts		Aerospace
Thread type	Full profile				
	National taper pipe		30° Trapezoidal	Round DIN405	UNJ
	NPT	NPTF	TR	Rd	UNJC, UNJF
Thread form					
Tool type					
ST type E034	27 ~ 8TPI E022	27 ~ 8TPI E023	1.5 ~ 6 mm E024	8TPI, 6TPI E024	32 ~ 8TPI E025
Chaser E042	11.5TPI, 8TPI E023	—	—	—	—

Applicable tool for each external thread type	Energy					Machine parts, Pipe	
Thread type	Full profile						
	API Tubing & Casing		API Rotary Shoulder Connection			ACME	STUB ACME
	Round	Buttress	V-0.038R	V-0.040	V-0.050		
Thread form							
Tool type							
ST type E034	10TPI, 8TPI E027	5TPI (0.75TPF) E029	—	—	—	12 ~ 5TPI E026	—
Lay down (Single side) E038	—	5TPI (0.75TPF) 5TPI (1TPF) E029	—	—	—	—	—
Lay down (Double side) E039	—	—	4TPI (2TPF) 4TPI (3TPF) E031	5TPI (3TPF) E031	4TPI (2TPF) 4TPI (3TPF) E031	—	—
On edge E040	10TPI, 8TPI E028	5TPI (0.75TPF) 5TPI (1TPF) E030	—	—	—	16 ~ 3TPI E026	16 ~ 3TPI E027
Chaser E041	10TPI, 8TPI E028	5TPI (0.75TPF) E030	—	—	—	—	—

Please see the page E*** for the product details.

Grade
Insert
Toolholder
Ext. Toolholder
Int. Toolholder
Threading
Grooving
Miniature Tool
Milling Cutter
Endmill
Drilling Tool
Tooling System
User's Guide
Index



Applicable tool for each internal thread type

Applicable tool for each external thread type	General purpose		General purpose		Pipe		
Thread type	National taper pipe		Full profile				
	60°	55°	ISO metric	Unified	Whitworth	Parallel pipe thread	Taper pipe thread
	-	-	M	UNC, UNF UNEF	BSW, BSF W	G, Rp BSP, PF, PS	Rc, PT, BSPT
Thread form							
Tool type							
ST type E036	0.5 ~ 6 mm (0.020" ~ 0.250") 48 ~ 4TPI E010	0.020" ~ 0.200" 48 ~ 5TPI E014	0.020" ~ 0.250" E016	32 ~ 5TPI E018	28 ~ 5TPI E020	E021	
TINY M TURN E052	0.5 ~ 1.5 mm (0.021" ~ 0.0625") 48 ~ 16TPI E052	---	---	---	---	---	
TUNG-CLAMP E049	1.27 ~ 4.23 mm 20 ~ 6TPI E012	---	---	---	---	---	
TT-R/L E053	~ 3 mm (~ 0.125") ~ 8TPI E013	~ 0.125" ~ 8TPI E015	---	---	---	---	

Applicable tool for each external thread type	Pipe		Machine parts		Aerospace
Thread type	Full profile				
	National taper pipe		30° Trapezoidal (DIN103)	Round (DIN405)	MJ
	NPT	NPTF	TR	Rd	MJ
Thread form					
Tool type					
ST type E036	27 ~ 8TPI E022	14 ~ 8TPI E023	1.5 ~ 5 mm (0.059" ~ 0.197") E024	6TPI E024	0.039" E025
Chaser E042	11.5TPI, 8TPI E023	---	---	---	---

Please see the page E*** for the product details.

Applicable tool for each external thread type	Energy					Machine parts, Pipe	
Thread type	Full profile						
	API Tubing & Casing		API Rotary Shoulder Connection			ACME	STUB ACME
	Round	Buttress	V-0.038R	V-0.040	V-0.050		
Thread form							
Tool type							
ST type E036	10TPI, 8TPI E027	5TPI (0.75TPF) E029	—	—	—	12 ~ 5TPI E026	—
Lay down (Single side) E039	—	5TPI (0.75TPF) 5TPI (1TPF) E029	—	—	—	—	—
Lay down (Double side) E040	—	—	4TPI (2TPF) 4TPI (3TPF) E031	5TPI (3TPF) E031	4TPI (2TPF) 4TPI (3TPF) E031	—	—
On edge E041	10TPI, 8TPI E028	5TPI (0.75TPF) 5TPI (1TPF) E030	—	—	—	—	—
Chaser E042	10TPI, 8TPI E028	5TPI (0.75TPF) E030	—	—	—	—	—

Please see the page E*** for the product details.

TETRAMCUT



Unique clamping system

The unique pocket design provides accurate indexing repeatability of the cutting edge height.

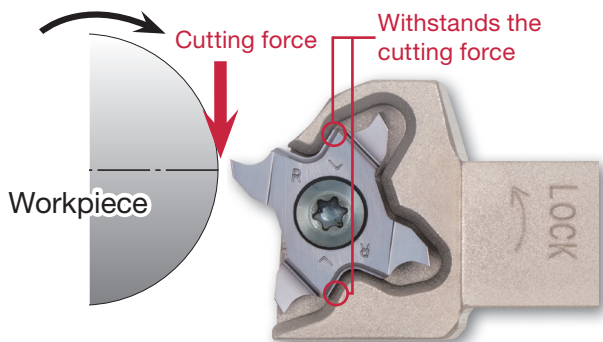

No tool interference with the tailstock when machining small parts

TETRAMCUT M16x1

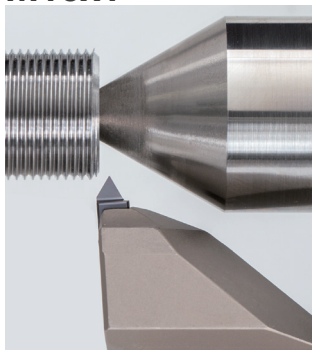

Insert: TCT18R-60N-020

Conventional M24x1

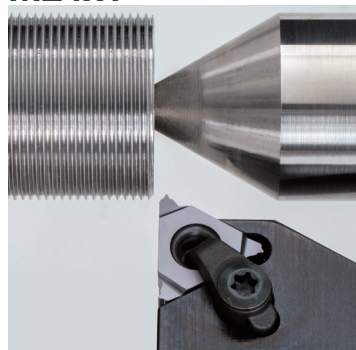

Insert: 16ER10ISO

Reference pages: Inserts → [E011](#), Toolholders → [E043 - E044](#), Standard cutting conditions → [E055](#)



Unique clamping system for highly rigid clamping

The unused cutting edge is always protected due to the innovative clamping system. Even if the first cutting edge is chipped, the other unused cutting edge can be used because the insert is clamped in the center.

Insert is secured at 3 points

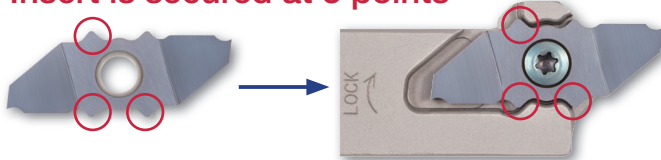

Excellent accessibility to the workpiece face

Utilizing various tools minimizes the length of undercut between the thread and work face.



	Insert shape		
	60A	60B	60N
Right hand			
Left hand			



Insert designation	PDX mm (in)	Pitch: mm (in)										
		0.2 (0.008)	0.25 (0.010)	0.35 (0.014)	0.4 (0.016)	0.5 (0.020)	0.6 (0.024)	0.8 (0.031)	1 (0.039)	1.25 (0.049)	1.5 (0.059)	
JXTG12FR-60A-000	0.25 (0.010)	Applicable area										
JXTG12FL-60A-000	0.25 (0.010)	Applicable area										
JXTG12FR-60B-000	2.25 (0.089)	Applicable area										
JXTG12FL-60B-000	2.25 (0.089)	Applicable area										
JXTG12FR-60A-005	0.6 (0.024)				Applicable area							
JXTG12FL-60A-005	0.6 (0.024)				Applicable area							
JXTG12FR-60B-005	1.9 (0.075)				Applicable area							
JXTG12FL-60B-005	1.9 (0.075)				Applicable area							
JXTG12FR-60N-010	1.25 (0.049)								Applicable area			
JXTG12FL-60N-010	1.25 (0.049)								Applicable area			
		127	72		52	32				16		
		Threads per inch (TPI)										

Reference pages: Inserts → E011, Toolholders → E045 - E048, Standard cutting conditions → E055

60° thread angle

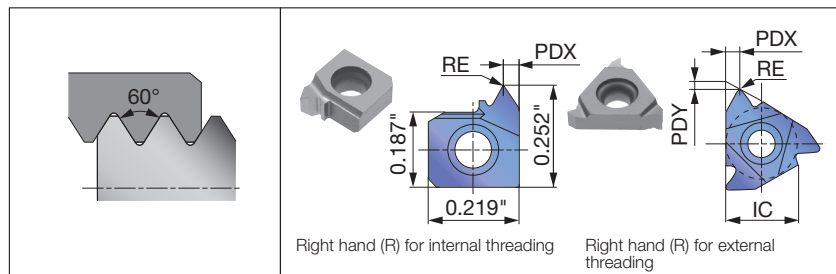

Applicable toolholder

Insert size	External	Internal
6		SNR/L000*K06SC... SNR/L000*H06...
11		SNR/L**11...
16	CER/L**16... JSER**16... JS**SEL16 B-SER/L**16 B-CER/L**16 BC-SER/L**16	TSNR/L**16 SNR/L**16... TCNR/L**16... CNR/L**16...
22	CER/L**22...	TSNR/L**22 SNR/L**22... TCNR/L**22... CNR/L**22...
27	CER/L**27...	CNR/L**27...

Partial-profile insert

Insert size	Pitch (mm)	TPI	Hand of cut	External insert (in)								Internal insert (in)														
				Designation	Grade			IC	PDX	PDY	RE	Designation	Grade			IC	PDX	PDY	RE							
					Coated	Uncoated	TH10						Coated	Uncoated	TH10											
					AH725	T313V							AH725	T313V												
6	0.5~1.5	48~16	R																6IRA60	●	●	-	0.035	-	0.0016	
11	0.5~1.5	48~16	R	11ERA60	●				0.250	0.035	0.031	0.0024	11IRA60	●	●	●	0.250	0.035	0.028	0.0016						
11	0.5~1.5	48~16	L																11ILA60	●	●	●	0.250	0.035	0.028	0.0016
16	0.5~1.5	48~16	R	16ERA60	●	●	●		0.375	0.035	0.028	0.0024	16IRA60	●	●	●	0.375	0.035	0.028	0.0016						
16	0.5~1.5	48~16	L	16ELA60	●	●	●		0.375	0.035	0.028	0.0024	16ILA60	●	●	●	0.375	0.035	0.028	0.0016						
16	0.5~3	48~8	R	16ERAG60	●	●	●		0.375	0.063	0.047	0.0024	16IRAG60	●	●	●	0.375	0.063	0.047	0.0016						
16	1.75~3	14~8	R	16ERG60	●	●	●		0.375	0.063	0.047	0.0087	16IRG60	●	●	●	0.375	0.063	0.047	0.0047						
16	1.75~3	14~8	L	16ELG60	●	●	●		0.375	0.020	0.047	0.0087	16ILG60	●	●	●	0.375	0.063	0.047	0.0047						
22	3.5~5	7~5	R	22ERN60	●	●	●		0.500	0.020	0.047	0.0173	22IRN60	●	●	●	0.500	0.098	0.067	0.0098						
22	3.5~5	7~5	L	22ELN60	●	●	●		0.500	0.020	0.047	0.0173	22ILN60	●	●	●	0.500	0.098	0.067	0.0098						
27	4~6	6~4	R	27ERZ60	●	●	●		0.625	0.035	0.028	0.0197	27IRZ60	●	●	●	0.625	0.125	0.087	0.0110						

Partial-profile insert with chipbreaker

Insert size	Pitch (mm)	TPI	Hand of cut	External insert (in)								Internal insert (in)													
				Designation	Grade		IC	PDX	PDY	RE	Designation	Grade		IC	PDX	PDY	RE								
					Coated	Cermet						Coated	Cermet												
					AH725	NS9530						AH725	NS9530												
11	0.5~1.5	48~16	R																11IRA60-B	●		0.250	0.035	0.028	0.0016
11	0.5~1.5	48~16	R																11IRA60-M		●	0.250	0.035	0.028	0.0016
16	0.5~1.5	48~16	R	16ERA60-B	●*				0.375	0.035	0.031	0.0020	16IRA60-B	●*				0.375	0.035	0.031	0.0020				
16	0.5~1.5	48~16	R	16ERA60-M		●			0.375	0.035	0.028	0.0024	16IRA60-M		●			0.375	0.063	0.043	0.0016				
16	0.5~3	48~8	R	16ERAG60-B	●*				0.375	0.067	0.047	0.0024	16IRAG60-B	●*				0.375	0.067	0.047	0.0020				
16	0.5~3	48~8	R	16ERAG60-M	●	●			0.375	0.063	0.043	0.0024	16IRAG60-M	●	●			0.375	0.063	0.047	0.0016				
16	1.75~3	14~8	R	16ERG60-B	●*				0.375	0.067	0.047	0.0067	16IRG60-B	●*				0.375	0.067	0.047	0.0039				
16	1.75~3	14~8	R	16ERG60-M		●			0.375	0.063	0.047	0.0087	16IRG60-M		●			0.375	0.063	0.047	0.0055				
22	3.5~5	7~5	R	22ERN60-B	●				0.500	0.098	0.067	0.0126	22IRN60-B	●				0.500	0.098	0.067	0.0075				

The adjustment of the cutting edge position will be needed as the dimensions of PDX and PDY are different from other inserts.

● highlighted item requires changing shims.

When using a new AH725 with chipbreaker, the conventional shim may need to be replaced with a new standard shim. Please refer to the page [E056](#).



Reference pages: Toolholders → [E032](#) - [E038](#),

Standard cutting conditions → [E054](#), [L044](#) - [L060](#)

● : Line up / 5 pieces per package

60° thread angle

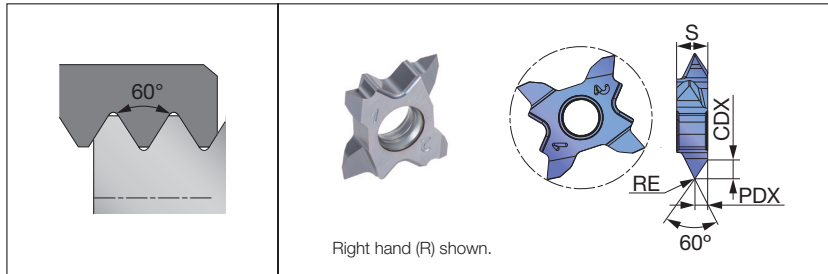

Applicable toolholder

External
STCR/L**-18
STCR/L**-18-CHP
JS**-STCL18

Partial-profile insert

Pitch (mm)	TPI	Hand of cut	Designation	External insert (in)					
				Grade		PDX	CDX	RE	S
				Coated					
SH725	AH725								
0.4 - 1	25 - 64	R	TCT18FR-60A-005	●		0.024	0.039	0.002	0.157
1 - 2	25 - 12	R	TCT18FR-60A-010	●		0.039	0.064	0.004	0.157
0.8 - 3	8 - 32	R/L	TCT18R/L-60N-010		●	0.063	0.105	0.004	0.157
1.5 - 3	8 - 16	R/L	TCT18R/L-60N-020		●	0.063	0.101	0.008	0.157

DUOJUST

INSERT

60° thread angle

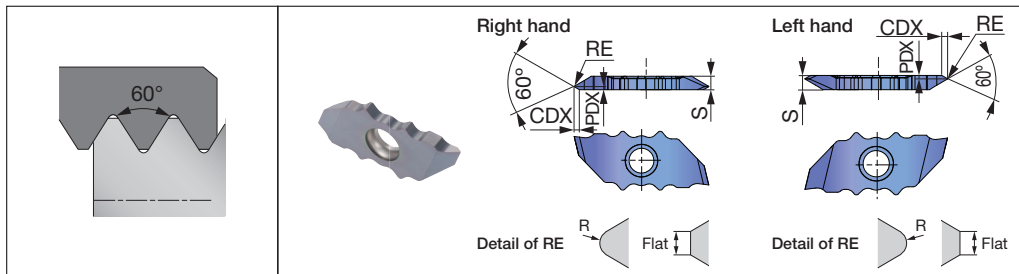

Applicable toolholder

External
JSXXR/L**09
JSXXR/L**09-CHP
JS**-SXXL09

Partial-profile insert

Insert size	Pitch (mm)	TPI	Hand of cut	Designation	External insert (in)					
					Grade		PDX	CDX	RE	S
					Coated					
R	L									
12	0.2 - 0.4	64 - 127	R/L	JXTG12FR/L-60A-000	●	●	0.010	0.016	Flat 0.002 max	0.098
12	0.2 - 0.4	64 - 127	R/L	JXTG12FR/L-60B-000	●	●	0.089	0.016	Flat 0.002 max	0.098
12	0.4 - 1	25 - 64	R/L	JXTG12FR/L-60A-005	●	●	0.024	0.039	R 0.002	0.098
12	0.4 - 1	25 - 64	R/L	JXTG12FR/L-60B-005	●	●	0.075	0.039	R 0.002	0.098
12	1 - 1.5	16 - 25	R/L	JXTG12FR/L-60N-010	●	●	0.049	0.081	R 0.004	0.098

	Insert shape		
	60A	60B	60N
Right hand			
Left hand			

Reference pages: TetraMini-Cut : Toolholders → **E043 - E044**,
Standard cutting conditions → **E055, L044 - L060**
DuoJust-Cut : Toolholders → **E045 - E048**,
Standard cutting conditions → **E055, L044 - L060**

● : Line up / 5 pieces per package



60° thread angle

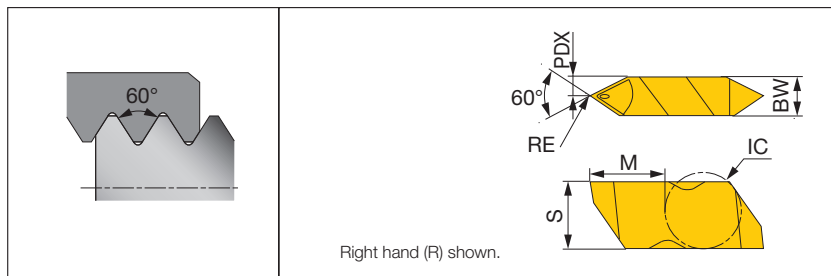

Applicable toolholder

External	Internal
FLASR/L-1616M3	A**M-FLER/L3
FLSR/L...	HS**-FLER3W

Thread form

60°

55°

M

(Metric)

UN

(Unified)

W

(Whitworth)

BSPT

(R, PT)

NPT

NPTF

TR

(Metric, 30° Trapezoidal)

Round

(DIN405)

UNJ

MJ

ACME

(29° Trapezoidal)

STUB ACME

(29° Trapezoidal)

API Round

API Butress

(API)

Rotary Shoulder Connection

Partial-profile insert for external and internal threads

External Pitch (mm)	Internal Pitch (mm)	TPI	Hand of cut	Designation	Grade	IC (in)	PDX (in)	BW (in)	RE (in)	S (in)	M (in)
					Coated						
1.27 - 4.23	2.11 - 5.08	6 - 20	R/L	FLT-3R/L-HCB	●	0.375	0.098	0.195	0.007	0.344	0.3999
2.31 - 4.23	3.175 - 5.08	11 - 20	R/L	FLT-3R/LC-HCB	●	0.375	0.098	0.195	0.014	0.344	0.3999
1.27 - 4.23	2.11 - 5.08	6 - 20	R/L	FLT-3R/L-CB	●	0.375	0.098	0.195	0.007	0.344	0.3999

J-SERIES INSERT

60° thread angle

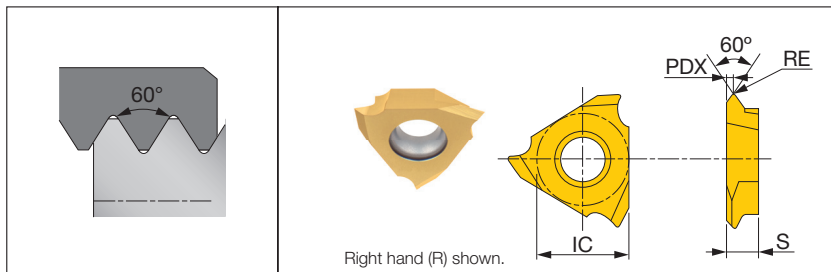

Applicable toolholder

External
JSTTR/L**3
JS**-TTL3

Partial-profile insert

Pitch (mm)	TPI	Hand of cut	Designation	External insert (in)											
				Grade								IC	PDX	S	RE
				Coated				Cermet		Uncoated					
				SH725		J740		NS9530		TH10					
R	L	R	L	R	L	R	L								
0.5 - 1	25 - 48	R/L	JTTR/L3005F	●	●	●		●		●		0.375	0.035	0.125	0.002
0.5 - 1	25 - 48	R/L	JTTR/L3010F	●	●	●		●		●		0.375	0.035	0.125	0.004

Reference pages: TungT-Clamp : Toolholders → **E049 - E050**,

Standard cutting conditions → **E055, L044 - L060**

J-Series : Toolholders → **E051 - E052**

● : Line up

60° thread angle

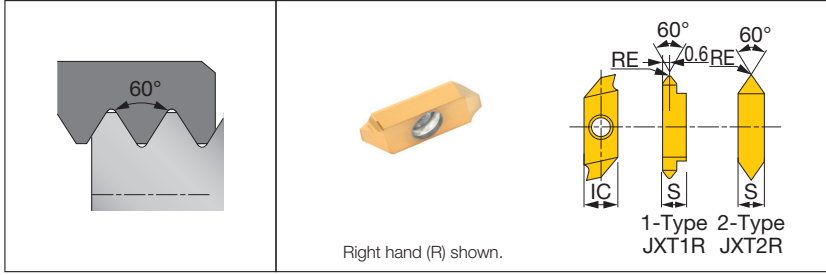

Applicable toolholder

External
JSXBR**K8
JSXBR**K8-C

Partial-profile insert

Pitch (mm)	TPI	Hand of cut	Designation	External insert (in)				
				Grade		IC	S	RE
				Coated J740	Uncoated TH10			
0.5 - 1	25 - 48	R	JXT1R6000F	●	●	0.315	0.156	0.001
0.5 - 1	25 - 48	R	JXT2R6000F	●	●	0.315	0.156	0.001

TUNGTHREAD

INSERT

TT type / 60° thread angle

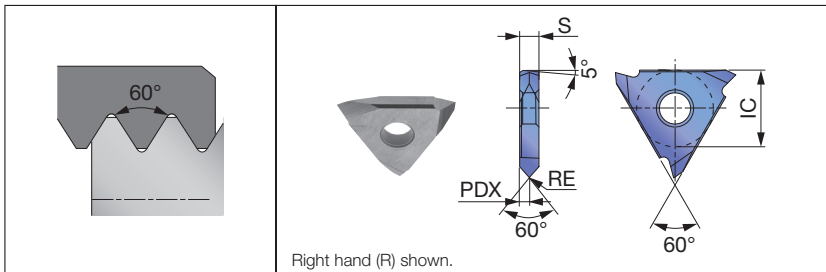

Applicable toolholder

External	Internal
TT-***RE/LI	TT-2525RI

Partial-profile insert for external and internal threads

Pitch (mm)	TPI	Hand of cut	Designation	Grade					
				Cermet	Uncoated	IC (in)	PDX (in)	S (in)	RE (in)
				NS9530	TH10				
≤ 3	≥ 8	R	TTR42M-005	●	●	0.500	0.063	0.126	0.002
≤ 3	≥ 8	L	TTL42M-005	●	●	0.500	0.063	0.126	0.002



55° thread angle (General purpose)

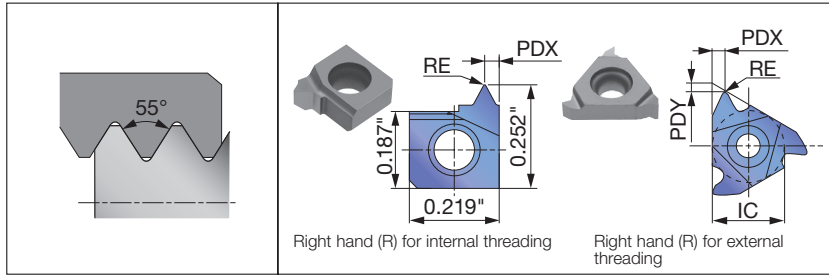

Applicable toolholder

Insert size	External	Internal
6		SNR/L000*K06SC... SNR/L000*H06...
11		SNR/L**11...
16	CER/L**16... JSER**16... JS**SEL16 B-SER/L**16 B-CER/L**16 BC-SER/L**16	TSNR/L**16 SNR/L**16... TCNR/L**16... CNR/L**16...
22	CER/L**22...	TSNR/L**22 SNR/L**22... TCNR/L**22... CNR/L**22...

Partial-profile insert

Insert size	Pitch (in)	TPI	Hand of cut	External insert (in)					Internal insert (in)																
				Designation	Grade			IC	PDX	PDY	RE	Designation	Grade			IC	PDX	PDY	RE						
					Coated	Uncoated							Coated	Uncoated											
6	0.020-0.063	48~16	R		AH725	T313V	TH10												61RA55	●	●	-	0.035	-	0.0028
11	0.020-0.063	48~16	R	11ERA55	●			0.250	0.035	0.020	0.0020	11IRA55	●	●	●	0.250	0.035	0.028	0.0028						
16	0.020-0.063	48~16	R	16ERA55	●	●	●	0.375	0.035	0.028	0.0028	16IRA55	●	●	●	0.375	0.035	0.028	0.0028						
16	0.020-0.125	48~8	R	16ERAG55	●			0.375	0.067	0.047	0.0028	16IRAG55	●			0.375	0.067	0.047	0.0028						
16	0.071-0.125	14~8	R	16ERG55	●	●	●	0.375	0.063	0.047	0.0110	16IRG55	●	●	●	0.375	0.067	0.047	0.0098						
22	0.142-0.200	7~5	R	22ERN55	●	●	●	0.500	0.098	0.067	0.0197	22IRN55	●	●	●	0.500	0.098	0.067	0.0197						

Partial-profile insert with chipbreaker

Insert size	Pitch (in)	TPI	Hand of cut	External insert (in)					Internal insert (in)										
				Designation	Grade			IC	PDX	PDY	RE	Designation	Grade			IC	PDX	PDY	RE
					Coated	Uncoated							Coated	Uncoated					
16	0.020-0.063	48~16	R	16ERAG55-B	●*			0.375	0.067	0.047	0.0028	16IRAG55-B	●*			0.375	0.067	0.047	0.0020
16	0.071-0.125	14~8	R	16ERG55-B	●*			0.375	0.067	0.047	0.0091	16IRG55-B	●*			0.375	0.067	0.047	0.0079

The adjustment of the cutting edge position will be needed as the dimensions of PDX and PDY are different from other inserts.

●* highlighted item requires changing shims.

When using a new AH725 with chipbreaker, the conventional shim may need to be replaced with a new standard shim. Please refer to the page E056.

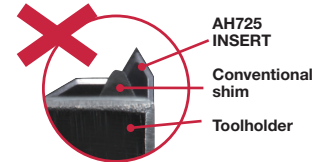

Reference pages: Toolholders → **E032 - E038**,
Standard cutting conditions → **E054, L044 - L060**

● : Line up / 5 pieces per package

55° thread angle (General purpose)

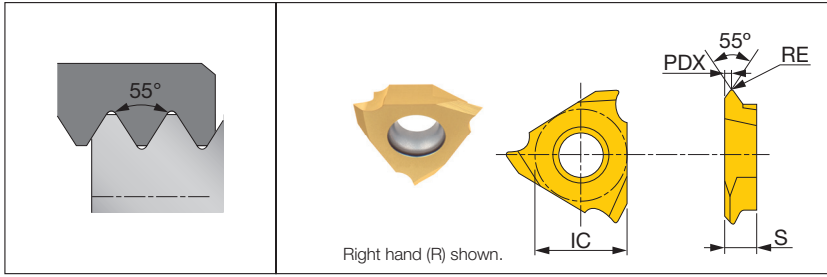

Applicable toolholder

External
JSTTR/L**3
JS**-TTL3

Partial-profile insert

Pitch (in)	TPI	Hand of cut	External insert (in)								
			Designation	Grade				IC	PDX	S	RE
				Coated							
				SH725		J740					
		R	L	R	L						
0.020-0.039	25 - 48	R/L	JTTR/L3005F-55	●		●		0.375	0.024	0.125	0.002

TUNGTHREAD

INSERT

TT type / 55° thread angle (General purpose)

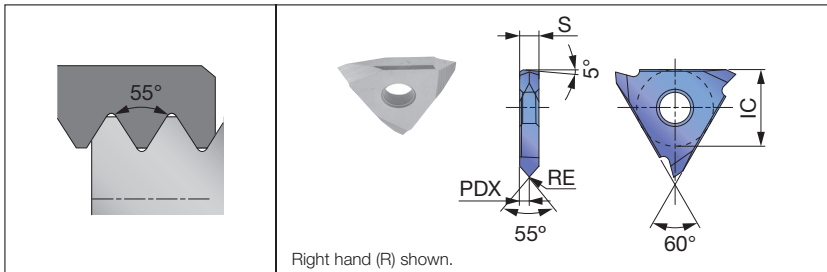

Applicable toolholder

External	Internal
TT-***RE/LI	TT-2525RI

Partial-profile insert for external and internal threads

Pitch (in)	TPI	Hand of cut	Designation	Grade		IC (in)	PDX (in)	S (in)	RE (in)
				Cermet	Uncoated				
				NS9530	TH10				
≤ 0.118	≥ 8	R	TTR42W-005	●	●	0.500	0.063	0.126	0.002
≤ 0.118	≥ 8	L	TTL42W-005	●	●	0.500	0.063	0.126	0.002

Reference pages: J-Series : Toolholders → **E051 - E052**,
TungThread : Toolholders → **E053**

● : Line up / 5 pieces per package



ISO metric (General purpose)

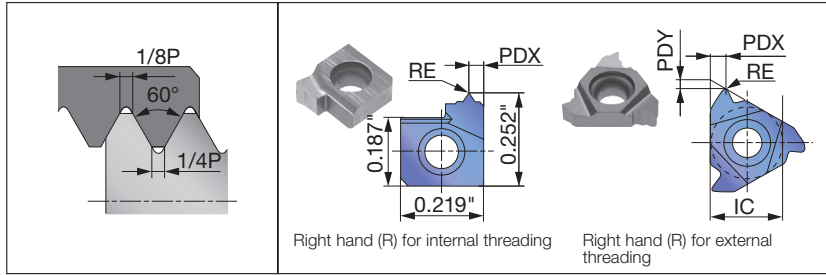

Applicable toolholder

Insert size	External	Internal
6		SNR/L000*K06SC... SNR/L000*H06...
11		SNR/L**11...
16	CER/L**16... JSER**16 JS**SEL16 B-SER/L**16 B-CER/L**16 BC-SER/L**16	TSNR/L**16... SNR/L**16... TCNR/L**16... CNR/L**16...
22	CER/L**22...	TSNR/L**22... SNR/L**22... TCNR/L**22... CNR/L**22...
27	CER/L**27...	CNR/L**27...

Full-profile insert

Insert size	Pitch (mm)	TPI	Hand of cut	External insert (in)								Internal insert (in)													
				Designation	Grade				IC	PDX	PDY	RE	Designation	Grade			IC	PDX	PDY	RE					
					Coated		Uncoated							Coated	Uncoated										
					AH725	AH8015	T313V	TH10						AH725	T313V	TH10									
6	0.75		R																						
6	1		R																						
6	1.25		R																						
6	1.5		R																						
6	1.75		R																						
6	2		R																						
11	0.35		R	11ER035ISO	●					0.25	0.016	0.024	0.0016												
11	0.5		R	11ER05ISO	●					0.25	0.024	0.024	0.0024	11IR05ISO	●	●		0.25	0.02	0.047	0.0016				
11	0.7		R	11ER07ISO	●					0.25	0.024	0.024	0.0043												
11	0.75		R	11ER075ISO	●					0.25	0.024	0.024	0.0043	11IR075ISO	●			0.25	0.02	0.047	0.002				
11	0.8		R	11ER080ISO	●					0.25	0.024	0.024	0.0047												
11	1		R	11ER10ISO	●					0.25	0.028	0.028	0.0051	11IR10ISO	●	●	●	0.25	0.035	0.028	0.0028				
11	1		L											11IL10ISO	●			0.25	0.035	0.028	0.0028				
11	1.25		R	11ER125ISO	●					0.25	0.035	0.031	0.0063	11IR125ISO	●			0.25	0.035	0.028	0.0035				
11	1.25		L											11IL125ISO	●			0.25	0.035	0.028	0.0035				
11	1.5		R	11ER15ISO	●					0.25	0.031	0.039	0.0075	11IR15ISO	●	●	●	0.25	0.035	0.028	0.0043				
11	1.5		L											11IL15ISO	●			0.25	0.035	0.028	0.0043				
11	1.75		R											11IR175ISO	●	●		0.25	0.035	0.028	0.0047				
11	1.75		L											11IL175ISO	●			0.25	0.035	0.028	0.0047				
11	2		R											11IR20ISO	●	●		0.25	0.035	0.028	0.0055				
11	2		L											11IL20ISO	●			0.25	0.035	0.028	0.0055				
16	0.5		R	16ER05ISO	●					0.375	0.02	0.047	0.0024	16IR05ISO	●			0.375	0.02	0.047	0.0016				
16	0.75		R	16ER075ISO	●		●	●		0.375	0.02	0.047	0.0035	16IR075ISO	●			0.375	0.02	0.047	0.002				
16	1		R	16ER10ISO	●		●	●		0.375	0.035	0.028	0.0051	16IR10ISO	●	●	●	0.375	0.035	0.028	0.0028				
16	1		L	16EL10ISO						0.375	0.035	0.028	0.0051	16IL10ISO	●			0.375	0.035	0.028	0.0028				
16	1.25		R	16ER125ISO	●		●			0.375	0.035	0.028	0.0063	16IR125ISO	●			0.375	0.035	0.028	0.0035				
16	1.25		L	16EL125ISO						0.375	0.035	0.028	0.0063	16IL125ISO	●			0.375	0.035	0.028	0.0035				
16	1.5		R	16ER15ISO	●		●	●		0.375	0.035	0.028	0.0075	16IR15ISO	●	●	●	0.375	0.035	0.028	0.0043				
16	1.5		L	16EL15ISO						0.375	0.035	0.028	0.0075	16IL15ISO	●			0.375	0.035	0.028	0.0043				
16	1.75		R	16ER175ISO	●		●			0.375	0.063	0.047	0.0087	16IR175ISO	●	●		0.375	0.063	0.047	0.0047				
16	2		R	16ER20ISO	●	●	●	●		0.375	0.063	0.047	0.0098	16IR20ISO	●	●	●	0.375	0.063	0.047	0.0055				
16	2		L	16EL20ISO	●					0.375	0.063	0.047	0.0098	16IL20ISO	●			9.525	0.063	0.047	0.0055				
16	2.5		R	16ER25ISO	●		●	●		0.375	0.063	0.047	0.0122	16IR25ISO	●	●	●	0.375	0.063	0.047	0.0071				
16	3		R	16ER30ISO	●		●	●		0.375	0.063	0.047	0.015	16IR30ISO	●	●	●	0.375	0.063	0.047	0.0083				
16	3		L	16EL30ISO						0.375	0.063	0.047	0.015	16IL30ISO	●			0.375	0.063	0.047	0.0083				

Reference pages: Toolholders → **E032 - E038**,

Standard cutting conditions → **E054, L044 - L060**

● : Line up / 5 pieces per package

Insert size	Pitch (mm)	TPI	Hand of cut	External insert (in)							Internal insert (in)								
				Designation	Grade			IC	PDX	PDY	RE	Designation	Grade			IC	PDX	PDY	RE
					Coated		Uncoated						Coated		Uncoated				
					AH725	T313V	TH10						AH725	T313V	TH10				
22	3.5	R	22ER35ISO	●	●		0.500	0.098	0.067	0.0173	22IR35ISO	●	●		0.500	0.098	0.067	0.0098	
22	4	R	22ER40ISO	●	●		0.500	0.098	0.067	0.0197	22IR40ISO	●	●		0.500	0.098	0.067	0.0110	
22	4.5	R	22ER45ISO	●			0.500	0.098	0.067	0.0220	22IR45ISO	●			0.500	0.098	0.067	0.0126	
22	5	R	22ER50ISO	●	●		0.500	0.098	0.067	0.0248	22IR50ISO	●	●		0.500	0.098	0.067	0.0138	
27	6	R	27ER60ISO	●	●		0.625	0.126	0.087	0.0295	27IR60ISO	●	●		0.625	0.126	0.087	0.0165	

Full-profile insert with chipbreaker

Insert size	Pitch (mm)	TPI	Hand of cut	External insert (in)							Internal insert (in)								
				Designation	Grade			IC	PDX	PDY	RE	Designation	Grade			IC	PDX	PDY	RE
					Coated		Cermet						Coated		Cermet				
					AH725	AH8015	NS9530						AH725	AH8015	NS9530				
11	0.5	R																	
11	0.5	R																	
11	0.75	R																	
11	0.75	R																	
11	1	R																	
11	1	R																	
11	1.25	R																	
11	1.25	R																	
11	1.5	R																	
11	1.5	R																	
11	1.75	R																	
11	1.75	R																	
11	2	R																	
11	2	R																	
16	0.5	R	16ER05ISO-M			●	0.375	0.020	0.047	0.0024									
16	0.75	R	16ER075ISO-B	●*			0.375	0.024	0.024	0.0031									
16	0.75	R	16ER075ISO-M			●	0.375	0.020	0.047	0.0035									
16	1	R	16ER10ISO-B	●*			0.375	0.028	0.028	0.0043	16IR10ISO-B	●*			0.375	0.028	0.024	0.0020	
16	1	R	16ER10ISO-M	●		●	0.375	0.035	0.028	0.0051	16IR10ISO-M		●	●	0.375	0.035	0.028	0.0031	
16	1.25	R	16ER125ISO-B	●*			0.375	0.035	0.031	0.0055	16IR125ISO-B	●*			0.375	0.035	0.031	0.0028	
16	1.25	R	16ER125ISO-M		●	●	0.375	0.035	0.028	0.0063	16IR125ISO-M		●		0.375	0.035	0.028	0.0039	
16	1.5	R	16ER15ISO-B	●*			0.375	0.039	0.031	0.0075	16IR15ISO-B	●*			0.375	0.039	0.031	0.0031	
16	1.5	R	16ER15ISO-M	●	●	●	0.375	0.035	0.028	0.0075	16IR15ISO-M	●	●	●	0.375	0.035	0.028	0.0047	
16	1.75	R	16ER175ISO-B	●*			0.375	0.047	0.035	0.0079	16IR175ISO-B	●*			0.375	0.047	0.035	0.0039	
16	1.75	R	16ER175ISO-M			●	0.375	0.063	0.047	0.0087	16IR175ISO-M		●		0.375	0.063	0.047	0.0055	
16	2	R	16ER20ISO-B	●*			0.375	0.051	0.039	0.0094	16IR20ISO-B	●*			0.375	0.051	0.039	0.0043	
16	2	R	16ER20ISO-M	●		●	0.375	0.063	0.047	0.0098	16IR20ISO-M		●		0.375	0.063	0.047	0.0055	
16	2.5	R	16ER25ISO-B	●*			0.375	0.059	0.043	0.0118	16IR25ISO-B	●*			0.375	0.059	0.043	0.0055	
16	2.5	R	16ER25ISO-M			●	0.375	0.063	0.047	0.0122	16IR25ISO-M		●		0.375	0.063	0.047	0.0071	
16	3	R	16ER30ISO-B	●*			0.375	0.063	0.047	0.0150	16IR30ISO-B	●*			0.375	0.059	0.043	0.0071	
16	3	R	16ER30ISO-M			●	0.375	0.063	0.047	0.0150	16IR30ISO-M		●		0.375	0.063	0.047	0.0083	
22	3.5	R	22ER35ISO-B	●			0.500	0.091	0.063	0.0189									
22	4	R	22ER40ISO-B	●			0.500	0.091	0.063	0.0205									

The adjustment of the cutting edge position will be needed as the dimensions of PDX and PDY are different from other inserts.

●* highlighted item requires changing shims.

When using a new AH725 with chipbreaker, the conventional shim may need to be replaced with a new standard shim. Please refer to the page E056.

Reference pages: Toolholders → E032 - E038,
Standard cutting conditions → E054, L044 - L060

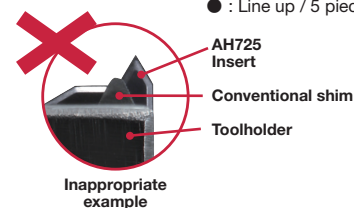

● : Line up / 5 pieces per package

AH725 Insert
Conventional shim
Toolholder

Inappropriate example

Unified (General purpose)

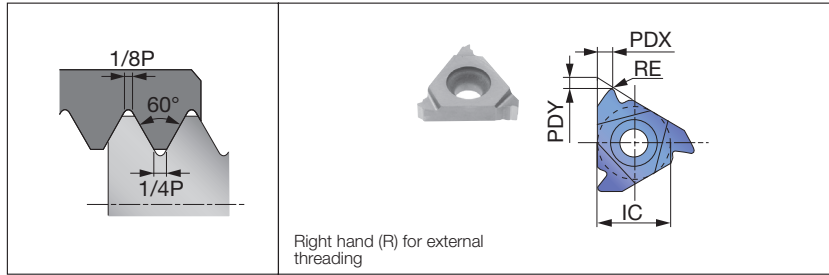

Applicable toolholder

Insert size	External	Internal
11		SNR/L**11...
16	CER/L**16... JSER**16 JS**SEL16 B-SER/L**16 B-CER/L**16 BC-SER/L**16	TSNR/L**16... SNR/L**16... TCNR/L**16... CNR/L**16...
22	CER/L**22...	TSNR/L**22... SNR/L**22... TCNR/L**22... CNR/L**22...

Full-profile insert

Insert size	Pitch (Reference) (in)	TPI	Hand of cut	External insert (in)				Internal insert (in)									
				Designation	Grade		IC	PDX	PDY	RE	Designation	Grade		IC	PDX	PDY	RE
					Coated							Coated					
					AH725	T313V						AH725	T313V				
11 (0.031)	32	R															
11 (0.036)	28	R															
11 (0.042)	24	R															
11 (0.050)	20	R															
11 (0.056)	18	R															
11 (0.063)	16	R															
11 (0.071)	14	R															
16 (0.031)	32	R		16ER32UN	●		0.375	0.020	0.047	0.0039	16IR32UN	●		0.250	0.020	0.047	0.0024
16 (0.036)	28	R		16ER28UN	●		0.375	0.020	0.047	0.0043	16IR28UN	●		0.250	0.020	0.047	0.0024
16 (0.042)	24	R		16ER24UN	●		0.375	0.035	0.028	0.0051	16IR24UN	●		0.250	0.035	0.028	0.0028
16 (0.050)	20	R		16ER20UN	●		0.375	0.035	0.028	0.0063	16IR20UN	●		0.250	0.035	0.028	0.0035
16 (0.056)	18	R		16ER18UN	●		0.375	0.035	0.028	0.0071	16IR18UN	●		0.250	0.035	0.028	0.0039
16 (0.063)	16	R		16ER16UN	●	●	0.375	0.035	0.028	0.0079	16IR16UN	●	●	0.250	0.035	0.028	0.0043
16 (0.071)	14	R		16ER14UN	●	●	0.375	0.063	0.047	0.0091	16IR14UN	●	●	0.250	0.035	0.028	0.0043
16 (0.077)	13	R		16ER13UN	●		0.375	0.063	0.047	0.0094	16IR13UN	●		0.250	0.035	0.028	0.0051
16 (0.083)	12	R		16ER12UN	●	●	0.375	0.063	0.047	0.0106	16IR12UN	●	●	0.250	0.035	0.028	0.0059
16 (0.091)	11	R		16ER11UN	●		0.375	0.063	0.047	0.0114	16IR11UN	●		0.250	0.035	0.028	0.0063
16 (0.100)	10	R		16ER10UN	●		0.375	0.063	0.047	0.0126	16IR10UN	●		0.250	0.035	0.028	0.0071
16 (0.111)	9	R		16ER9UN	●		0.375	0.063	0.047	0.0138	16IR9UN	●		0.250	0.035	0.028	0.0079
16 (0.125)	8	R		16ER8UN	●	●	0.375	0.063	0.047	0.0157	16IR8UN	●	●	0.250	0.035	0.028	0.0087
22 (0.143)	7	R		22ER7UN	●		0.500	0.098	0.067	0.0177	22IR7UN	●		0.500	0.098	0.067	0.0098
22 (0.167)	6	R		22ER6UN	●		0.500	0.098	0.067	0.0209	22IR6UN	●		0.500	0.098	0.067	0.0118
22 (0.200)	5	R		22ER5UN	●		0.500	0.098	0.067	0.0252	22IR5UN	●		0.500	0.098	0.067	0.0142

Reference pages: Toolholders → [E032 - E038](#),
Standard cutting conditions → [E054, L044 - L060](#)

● : Line up / 5 pieces per package

Full-profile insert with chipbreaker

Insert size	Pitch (Reference) (in)	TPI	Hand of cut	External insert (in)								Internal insert (in)							
				Designation	Grade		IC	PDX	PDY	RE	Designation	Grade		IC	PDX	PDY	RE		
					Coated	Cermet						Coated	Cermet						
					AH725	NS9530						AH725	NS9530						
16 (0.042)	24	R	16ER24UN-B	●*		0.375	0.031	0.028	0.0043										
16 (0.042)	24	R	16ER24UN-M		●	0.375	0.035	0.028	0.0051										
16 (0.050)	20	R	16ER20UN-B	●*		0.375	0.035	0.031	0.0055	16IR20UN-B	●*		0.375	0.035	0.031	0.0024			
16 (0.050)	20	R	16ER20UN-M		●	0.375	0.035	0.028	0.0063	16IR20UN-M		●	0.375	0.035	0.028	0.0035			
16 (0.056)	18	R	16ER18UN-B	●*		0.375	0.039	0.031	0.0059	16IR18UN-B	●*		0.375	0.039	0.031	0.0031			
16 (0.056)	18	R	16ER18UN-M		●	0.375	0.035	0.028	0.0071	16IR18UN-M		●	0.375	0.035	0.028	0.0039			
16 (0.063)	16	R	16ER16UN-B	●*		0.375	0.043	0.035	0.0071	16IR16UN-B	●*		0.375	0.043	0.035	0.0035			
16 (0.063)	16	R	16ER16UN-M		●	0.375	0.035	0.028	0.0079	16IR16UN-M		●	0.375	0.035	0.028	0.0043			
16 (0.071)	14	R	16ER14UN-B	●*		0.375	0.047	0.039	0.0087	16IR14UN-B	●*		0.375	0.047	0.035	0.0043			
16 (0.071)	14	R	16ER14UN-M		●	0.375	0.063	0.047	0.0091	16IR14UN-M		●	0.375	0.063	0.047	0.0043			
16 (0.077)	13	R	16ER13UN-B	●*		0.375	0.051	0.039	0.0094										
16 (0.083)	12	R	16ER12UN-B	●*		0.375	0.055	0.043	0.0098	16IR12UN-B	●*		0.375	0.055	0.043	0.0047			
16 (0.083)	12	R	16ER12UN-M		●	0.375	0.063	0.047	0.0106	16IR12UN-M		●	0.375	0.063	0.047	0.0059			
16 (0.125)	8	R	16ER8UN-B	●*		0.375	0.063	0.047	0.0161	16IR8UN-B	●*		0.375	0.059	0.043	0.0075			
16 (0.125)	8	R	16ER8UN-M		●	0.375	0.063	0.047	0.0157	16IR8UN-M		●	0.375	0.063	0.047	0.0087			

The adjustment of the cutting edge position will be needed as the dimensions of PDX and PDY are different from other inserts.

highlighted item requires changing shims.

When using a new AH725 with chipbreaker, the conventional shim may need to be replaced with a new standard shim. Please refer to the page E056.

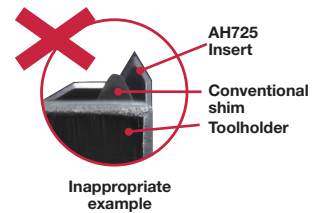

Whitworth, Parallel pipe thread

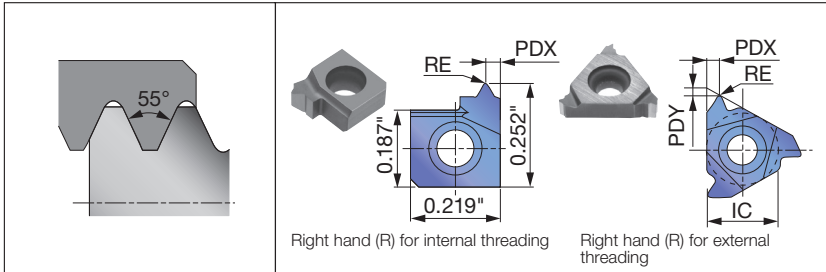

Applicable toolholder

Insert size	External	Internal
6		SNR/L000*K06SC... SNR/L000*H06...
11		SNR/L**11...
16	CER/L**16... JSER**16 JSE**SEL16 B-SER/L**16 B-CER/L**16 BC-SER/L**16	TSNR/L**16 SNR/L**16... TCNR/L**16... CNR/L**16...
22	CER/L**22...	TSNR/L**22 SNR/L**22... TCNR/L**22... CNR/L**22...

Thread form

60°

55°

M
(Metric)

UN
(Unified)

W
(Whitworth)

BSPT
(R, PT)

NPT

NPTF

TR
(Metric, 30°
Trapezoidal)

Round
(DIN405)

UNJ

MJ

Full-profile insert

Insert size	Pitch (Reference) (in)	TPI	Hand of cut	External insert (in)							Internal insert (in)										
				Designation	Grade			IC	PDX	PDY	RE	Designation	Grade			IC	PDX	PDY	RE		
					Coated	Uncoated							Coated	Uncoated							
					AH725	T313V	TH10						AH725	T313V	TH10						
6	(0.053)	19	R											6IR19W	●		●	-	0.035	-	0.0067
11	(0.053)	19	R											11IR19W	●	●	●	0.250	0.035	0.028	0.0067
11	(0.071)	14	R											11IR14W	●	●	●	0.250	0.035	0.028	0.23
16	(0.036)	28	R	16ER28W	●	●		0.375	0.035	0.028	0.0043		16IR28W	●			0.375	0.035	0.028	0.0043	
16	(0.038)	26	R	16ER26W	●			0.375	0.035	0.028	0.0047		16IR26W	●			0.375	0.035	0.028	0.0047	
16	(0.050)	20	R	16ER20W	●			0.375	0.035	0.028	0.0063		16IR20W	●			0.375	0.035	0.028	0.0063	
16	(0.053)	19	R	16ER19W	●	●		0.375	0.035	0.028	0.0067		16IR19W	●			0.375	0.035	0.028	0.0067	
16	(0.056)	18	R	16ER18W	●			0.375	0.035	0.028	0.0071		16IR18W	●			0.375	0.035	0.028	0.0071	
16	(0.063)	16	R	16ER16W	●	●		0.375	0.035	0.028	0.0079		16IR16W	●	●		0.375	0.035	0.028	0.0079	
16	(0.071)	14	R	16ER14W	●	●	●	0.375	0.063	0.047	0.0091		16IR14W	●	●	●	0.375	0.063	0.047	0.0091	
16	(0.071)	14	L	16EL14W	●			0.375	0.063	0.047	0.0091										
16	(0.083)	12	R	16ER12W	●	●		0.375	0.063	0.047	0.0106		16IR12W	●	●		0.375	0.063	0.047	0.0106	
16	(0.091)	11	R	16ER11W	●	●	●	0.375	0.063	0.047	0.0114		16IR11W	●	●	●	0.375	0.063	0.047	0.0114	
16	(0.100)	10	R	16ER10W	●	●		0.375	0.063	0.047	0.0126		16IR10W	●	●		0.375	0.063	0.047	0.0126	
16	(0.111)	9	R	16ER9W	●			0.375	0.063	0.047	0.0138		16IR9W	●			0.375	0.063	0.047	0.0138	
16	(0.125)	8	R	16ER8W	●	●		0.375	0.063	0.047	0.0157		16IR8W	●	●		0.375	0.063	0.047	0.0157	
22	(0.143)	7	R	22ER7W	●			0.500	0.098	0.067	0.0177		22IR7W	●			0.500	0.098	0.067	0.0177	
22	(0.167)	6	R	22ER6W	●			0.500	0.098	0.067	0.0209		22IR6W	●			0.500	0.098	0.067	0.0209	
22	(0.200)	5	R	22ER5W	●			0.500	0.098	0.067	0.0252		22IR5W	●			0.500	0.098	0.067	0.0252	

Full-profile insert with chipbreaker

Insert size	Pitch (Reference) (in)	TPI	Hand of cut	External insert (in)							Internal insert (in)												
				Designation	Grade			IC	PDX	PDY	RE	Designation	Grade			IC	PDX	PDY	RE				
					Coated	Cermet							Coated	Cermet									
					AH725	AH8015	NS9530						AH725	AH8015	NS9530								
16	(0.053)	19	R	16ER19W-B	●*			0.375	0.039	0.031	0.0063												
16	(0.053)	19	R	16ER19W-M		●		0.375	0.035	0.028	0.0067		16IR19W-M		●		0.375	0.035	0.028	0.0067			
16	(0.063)	16	R	16ER16W-B	●*			0.375	0.043	0.035	0.0079		16IR16W-B	●*			0.375	0.043	0.035	0.0071			
16	(0.071)	14	R	16ER14W-B	●*			0.375	0.047	0.039	0.0094		16IR14W-B	●*			0.375	0.047	0.039	0.0083			
16	(0.071)	14	R	16ER14W-M		●		0.375	0.063	0.047	0.0091		16IR14W-M		●	●	0.375	0.063	0.047	0.0091			
16	(0.091)	11	R	16ER11W-B	●*			0.375	0.059	0.043	0.0106		16IR11W-B	●*			0.375	0.059	0.043	0.0106			
16	(0.091)	11	R	16ER11W-M		●		0.375	0.063	0.047	0.0114		16IR11W-M		●		0.375	0.063	0.047	0.0114			

The adjustment of the cutting edge position will be needed as the dimensions of PDX and PDY are different from other inserts.

* highlighted item requires changing shims.

When using a new AH725 with chipbreaker, the conventional shim may need to be replaced with a new standard shim. Please refer to the page E056.

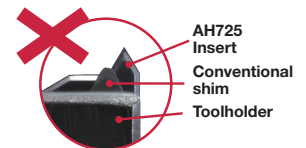

Inappropriate example

● : Line up / 5 pieces per package

Reference pages: Toolholders → E032 - E038,

Standard cutting conditions → E054, L044 - L060

BSPT (for Pipe)

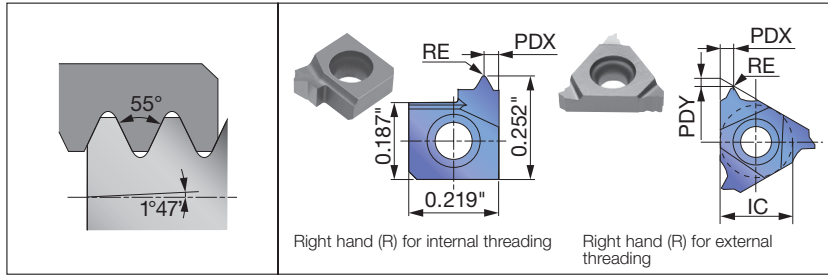

Applicable toolholder

Insert size	External	Internal
	6	
11		SNR/L**11...
16	CER/L**16... JSER**16 JSE**SEL16 B-SER/L**16 B-CER/L**16 BC-SER/L**16	TSNR/L**16 SNR/L**16... TCNR/L**16... CNR/L**16...

Full-profile insert

Insert size	Pitch (Reference) (in)	TPI	Hand of cut	External insert (in)					Internal insert (in)																							
				Designation	Grade			IC	PDX	PDY	RE	Designation	Grade			IC	PDX	PDY	RE													
					Coated	Uncoated							Coated	Uncoated																		
					AH725	T313V	TH10						AH725	T313V	TH10																	
6	(0.053)	19	R																6IR19PT	●	●	-	0.035	-	0.0055							
11	(0.053)	19	R																	11IR19PT	●	●	●	0.250	0.035	0.028	0.0055					
11	(0.071)	14	R																	11IR14PT	●	●	●	0.250	0.035	0.028	0.0063					
16	(0.036)	28	R	16ER28PT	●	●		0.375	0.035	0.028	0.0035																					
16	(0.053)	19	R	16ER19PT	●	●		0.375	0.035	0.028	0.0055	16IR19PT	●			0.375	0.035	0.028	0.0055													
16	(0.071)	14	R	16ER14PT	●	●		0.375	0.063	0.047	0.0063	16IR14PT	●	●	●	0.375	0.063	0.047	0.0063													
16	(0.091)	11	R	16ER11PT	●	●		0.375	0.063	0.047	0.0102	16IR11PT	●	●	●	0.375	0.063	0.047	0.0102													

Full-profile insert with chipbreaker

Insert size	Pitch (Reference) (in)	TPI	Hand of cut	External insert (in)					Internal insert (in)																							
				Designation	Grade		IC	PDX	PDY	RE	Designation	Grade		IC	PDX	PDY	RE															
					Coated	Cermet						Coated	Cermet																			
					AH725	NS9530						AH725	NS9530																			
16	(0.053)	19	R	16ER19PT-M		●		0.375	0.035	0.028	0.0071	16IR19PT-M		●		0.375	0.035	0.028	0.0071													
16	(0.071)	14	R	16ER14PT-B	●*			0.375	0.047	0.039	0.0083	16IR14PT-B	●*			0.375	0.039	0.047	0.0083													
16	(0.071)	14	R	16ER14PT-M		●		0.375	0.063	0.047	0.0098	16IR14PT-M		●		0.375	0.063	0.047	0.0098													
16	(0.091)	11	R	16ER11PT-B	●*			0.375	0.059	0.043	0.0110	16IR11PT-B	●*			0.375	0.059	0.043	0.0110													
16	(0.091)	11	R	16ER11PT-M		●		0.375	0.063	0.047	0.0126	16IR11PT-M		●		0.375	0.063	0.047	0.0126													

The adjustment of the cutting edge position will be needed as the dimensions of PDX and PDY are different from other inserts.

● highlighted item requires changing shims.

When using a new AH725 with chipbreaker, the conventional shim may need to be replaced with a new standard shim. Please refer to the page E056.

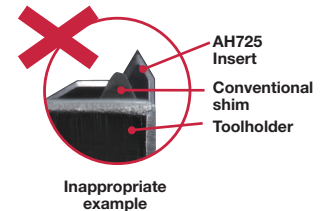

NPT (for Pipe)

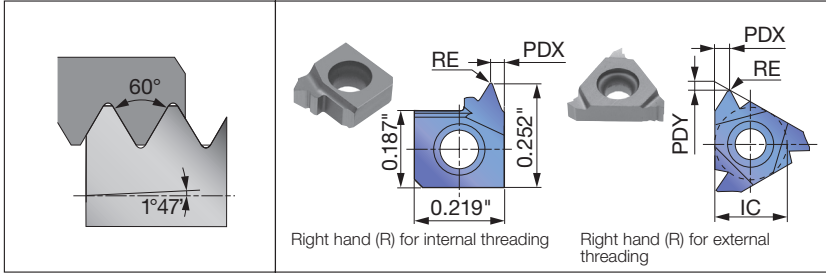

Applicable toolholder

Insert size	External	Internal
6		SNR/L000*K06SC... SNR/L000*H06...
16	CER/L**16... JSER**16 JS**SEL16 B-SER/L**16 B-CER/L**16 BC-SER/L**16	TSNR/L**16 SNR/L**16... TCNR/L**16... CNR/L**16...

Full-profile insert

Insert size	Pitch (Reference) (in)	TPI	Hand of cut	External insert (in)								Internal insert (in)																								
				Designation	Grade			IC	PDX	PDY	RE	Designation	Grade			IC	PDX	PDY	RE																	
					Coated	Uncoated							Coated	Uncoated																						
					AH725	T313V	TH10						AH725	T313V	TH10																					
6	(0.056)	18	R															6IR18NPT														-	0.035		-	0.0012
16	(0.037)	27	R	16ER27NPT					0.375	0.020	0.047	0.0008	16IR27NPT					0.375	0.020	0.047	0.0008															
16	(0.056)	18	R	16ER18NPT					0.375	0.035	0.028	0.0012	16IR18NPT					0.375	0.035	0.028	0.0012															
16	(0.071)	14	R	16ER14NPT					0.375	0.063	0.047	0.0016	16IR14NPT					0.375	0.063	0.047	0.0016															
16	(0.087)	11.5	R	16ER115NPT					0.375	0.063	0.047	0.0020	16IR115NPT					0.375	0.063	0.047	0.0020															
16	(0.125)	8	R	16ER8NPT					0.375	0.063	0.047	0.0028	16IR8NPT					0.375	0.063	0.047	0.0028															

Full-profile insert with chipbreaker

Insert size	Pitch (Reference) (in)	TPI	Hand of cut	External insert (in)								Internal insert (in)																												
				Designation	Grade		IC	PDX	PDY	RE	Designation	Grade		IC	PDX	PDY	RE																							
					Coated	Cermet						Coated	Cermet																											
					AH725	NS9530						AH725	NS9530																											
16	(0.056)	18	R	16ER18NPT-B					0.375	0.039	0.031	0.0020																												
16	(0.056)	18	R	16ER18NPT-M					0.375	0.035	0.028	0.0028	16IR18NPT-M					0.375	0.035	0.028	0.0028																			
16	(0.071)	14	R	16ER14NPT-B					0.375	0.047	0.035	0.0020	16IR14NPT-B					0.375	0.047	0.9	0.0020																			
16	(0.071)	14	R	16ER14NPT-M					0.375	0.063	0.047	0.0031	16IR14NPT-M					0.375	0.063	0.047	0.0031																			
16	(0.087)	11.5	R	16ER115NPT-B					0.375	0.059	0.043	0.0035	16IR115NPT-B					0.375	0.059	0.043	0.0035																			
16	(0.087)	11.5	R	16ER115NPT-M					0.375	0.063	0.047	0.0035	16IR115NPT-M					0.375	0.063	0.047	0.0035																			
16	(0.125)	8	R	16ER8NPT-B					0.375	0.071	0.051	0.0047	16IR8NPT-B					0.375	0.071	0.051	0.0047																			

The adjustment of the cutting edge position will be needed as the dimensions of PDX and PDY are different from other inserts.

highlighted item requires changing shims.

When using a new AH725 with chipbreaker, the conventional shim may need to be replaced with a new standard shim. Please refer to the page E056.



Reference pages: Toolholders → [E032 - E038](#),
Standard cutting conditions → [E054, L044 - L060](#)

● : Line up / 5 pieces per package

NPT (for Pipe)

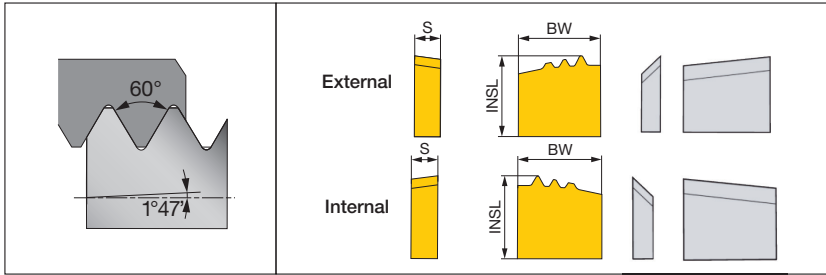

Applicable toolholder

External	Internal
CLVOR...	SI-CLHOR...

Full-profile insert (chaser)

Pitch (Reference) (mm)	TPI	External insert (mm)							Internal insert (mm)				
		Designation	Grade	BW	INSL	S	Breakerpiece	Designation	Grade	BW	INSL	S	Breakerpiece
			Coated						Coated				
			AH725						AH725				
(2.209)	11.5	CR-11.5NPT-4E	●	16	15.7	5.2	CR-8R / 10R-3E / 4E-CB	●	16	15.7	5.2	CR-8R / 10R-3I / 4I-CB	
(3.175)	8	CR-8NPT-4E	●	16	15.7	5.2	CR-8R / 10R-3E / 4E-CB	●	16	15.7	5.2	CR-8R / 10R-3I / 4I-CB	

NPTF (for Pipe)

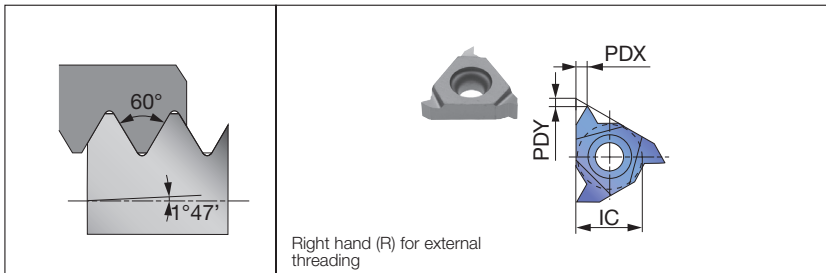

Applicable toolholder

Insert size	External	Internal
16	CER/L**16... JSER**16 JSE**SEL16 B-SER/L**16 B-CER/L**16 BC-SER/L**16	TSNR/L**16 SNR/L**16... TCNR/L**16... CNR/L**16...

Full-profile insert

Insert size	Pitch (Reference) (in)	TPI	Hand of cut	External insert (in)							Internal insert (in)				
				Designation	Grade	IC	PDX	PDY	RE	Designation	Grade	IC	PDX	PDY	RE
					Coated						Coated				
					AH725						AH725				
16 (0.037)	27	R	R	16ER27NPTF	●	0.375	0.020	0.047	-						
16 (0.056)	18	R	R	16ER18NPTF	●	0.375	0.035	0.028	-						
16 (0.071)	14	R	R	16ER14NPTF	●	0.375	0.063	0.047	-	16IR14NPTF	●	0.375	0.063	0.047	-
16 (0.087)	11.5	R	R	16ER115NPTF	●	0.375	0.063	0.047	-	16IR115NPTF	●	0.375	0.063	0.047	-
16 (0.125)	8	R	R	16ER8NPTF	●	0.375	0.063	0.047	-	16IR8NPTF	●	0.375	0.063	0.047	-

Reference pages: Toolholders → **E032 - E042**,
Standard cutting conditions → **E054, L044 - L060**

● : Line up / 5 pieces per package



30° Trapezoidal / DIN103 (for Machine parts)

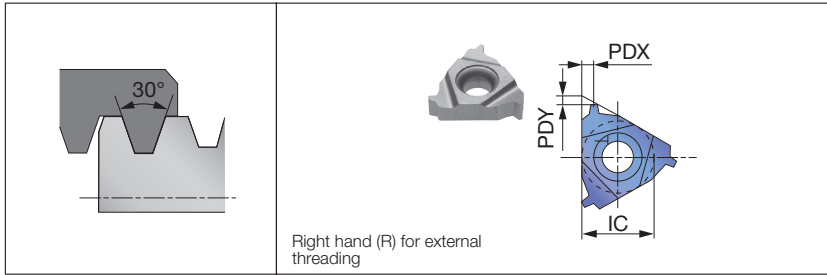

Applicable toolholder

Insert size	External	Internal
16	CER/L**16... JSER**16 JS**SEL16 B-SER/L**16 B-CER/L**16 BC-SER/L**16	TSNR/L**16 SNR/L**16... TCNR/L**16... CNR/L**16...
22	CER/L**22...	TSNR/L**22 SNR/L**22... TCNR/L**22... CNR/L**22...
27	CER/L**27...	CNR/L**27...

With the special full-profile insert (Please see the page L044)

Insert size	Pitch (mm)	TPI	Hand of cut	External insert (in)						Internal insert (in)					
				Designation	Grade		IC	PDX	PDY	Designation	Grade		IC	PDX	PDY
					Coated						Coated				
					AH725	T313V					AH725	T313V			
16	1.5	R	16ER15TR	●		0.375	0.035	0.028	16IR15TR	●		0.375	0.035	0.028	
16	2	R	16ER20TR	●	●	0.375	0.063	0.051	16IR20TR	●	●	0.375	0.063	0.051	
16	3	R	16ER30TR	●	●	0.375	0.063	0.051	16IR30TR	●	●	0.375	0.063	0.051	
22	4	R	22ER40TR	●	●	0.500	0.098	0.079	22IR40TR	●	●	0.500	0.098	0.079	
22	5	R	22ER50TR	●	●	0.500	0.098	0.079	22IR50TR	●	●	0.500	0.098	0.079	
27	6	R	27ER60TR	●	●	0.625	0.126	0.098							

Round / DIN405 (for Machine parts)

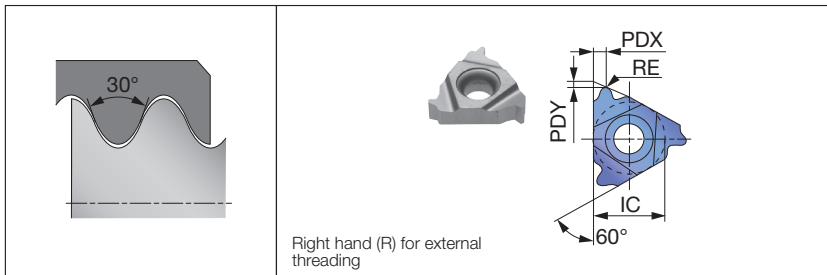

Applicable toolholder

Insert size	External	Internal
16	CER/L**16... JSER**16 JS**SEL16 B-SER/L**16 B-CER/L**16 BC-SER/L**16	TSNR/L**16 SNR/L**16... TCNR/L**16... CNR/L**16...

Full-profile insert

Insert size	Pitch (Reference) (in)	TPI	Hand of cut	External insert (in)								Internal insert (in)					
				Designation	Grade		IC	PDX	PDY	RE	Designation	Grade		IC	PDX	PDY	RE
					Coated							Coated					
					AH725							AH725					
16	(0.125)	8	R	16ER8RD-B	●		0.375	0.051	0.055	-							
16	(0.125)	6	R	16ER6RD-B	●		0.375	0.067	0.059	-	16IR6RD-B	●		0.375	0.059	0.055	-

Reference pages: Toolholders → [E032 - E042](#),
Standard cutting conditions → [E054, L044 - L060](#)

● : Line up / 5 pieces per package

UNJ (for Aerospace industry)

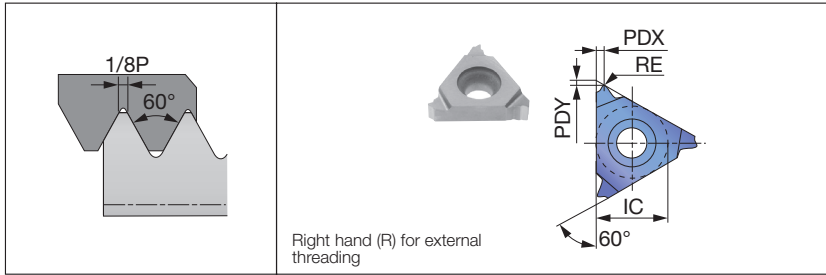

Applicable toolholder

Insert size	External
16	CER/L**16... JSER**16 JS**SEL16 B-SER/L**16 B-CER/L**16 BC-SER/L**16

Full-profile insert

Insert size	Pitch (Reference) (in)	TPI	Hand of cut	External insert (in)					
				Designation	Grade	IC	PDX	PDY	RE
					Coated AH725				
16 (0.031)	32	R	16ER32UNJ	●	0.375	0.020	0.047	0.0051	
16 (0.036)	28	R	16ER28UNJ	●	0.375	0.020	0.047	0.0059	
16 (0.042)	24	R	16ER24UNJ	●	0.375	0.035	0.028	0.0071	
16 (0.050)	20	R	16ER20UNJ	●	0.375	0.035	0.028	0.0083	
16 (0.056)	18	R	16ER18UNJ	●	0.375	0.035	0.028	0.0094	
16 (0.063)	16	R	16ER16UNJ	●	0.375	0.035	0.028	0.0102	
16 (0.071)	14	R	16ER14UNJ	●	0.375	0.063	0.047	0.0118	
16 (0.083)	12	R	16ER12UNJ	●	0.375	0.063	0.047	0.0138	
16 (0.100)	10	R	16ER10UNJ	●	0.375	0.063	0.047	0.0165	
16 (0.125)	8	R	16ER8UNJ	●	0.375	0.063	0.047	0.0209	

MJ (for Aerospace industry)

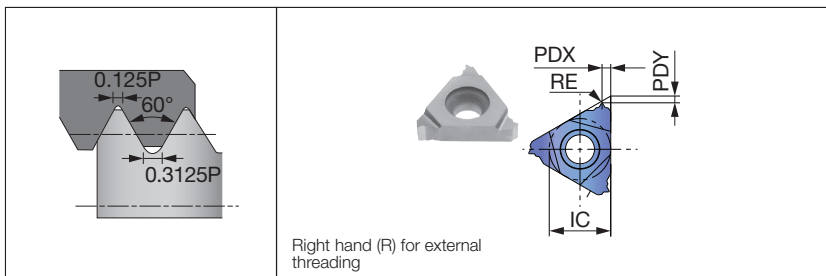

Applicable toolholder

Insert size	External	Internal
11		SNR**11...

Insert size	Pitch (in)	TPI	Hand of cut	Internal insert (in)					
				Designation	Grade	IC	PDX	PDY	RE
					Coated AH8015				
11	0.039	R	11IR10MJ	●	0.250	0.035	0.028	0.020	

Reference pages: Toolholders → **E032 - E042**,
Standard cutting conditions → **E054, L044 - L060**

● : Line up / 5 pieces per package



29° Trapezoidal / ACME (for Machine parts, Pipe)

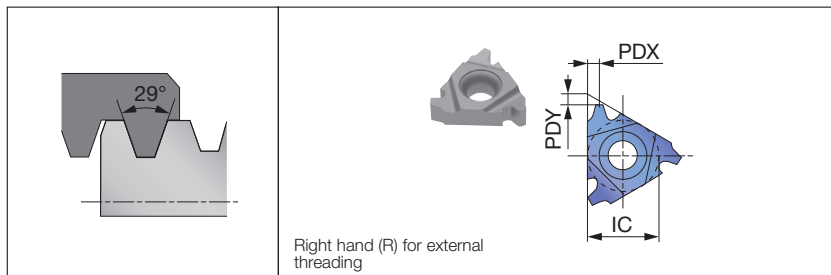

Applicable toolholder

Insert size	External	Internal
16	CER/L**16... JSER**16 JS**SEL16 B-SER/L**16 B-CER/L**16 BC-SER/L**16	TSNR/L**16 SNR/L**16... TCNR/L**16... CNR/L**16...
22	CER/L**22...	TSNR/L**22 SNR/L**22... TCNR/L**22... CNR/L**22...

With the special full-profile insert (Please see the page L044)

Insert size	Pitch (Reference) (in)	TPI	Hand of cut	External insert (in)					Internal insert (in)						
				Designation	Grade		IC	PDX	PDY	Designation	Grade		IC	PDX	PDY
					Coated						Coated				
					AH725	T313V					AH725	T313V			
16 (0.083)	12	R	16ER12ACME	●		0.375	0.063	0.051	16IR12ACME	●		0.375	0.063	0.051	
16 (0.100)	10	R	16ER10ACME	●		0.375	0.063	0.051	16IR10ACME	●		0.375	0.063	0.051	
16 (0.125)	8	R	16ER8ACME	●	●	0.375	0.063	0.051	16IR8ACME	●	●	0.375	0.063	0.051	
16 (0.100)	10	R	16ER8STACME (STACME)	●		0.375	0.063	0.051	16IR8STACME (STACME)	●		0.375	0.063	0.051	
16 (0.125)	8	R	16ER8TPI29	●		0.375	0.063	0.051	16IR8TPI29	●		0.375	0.063	0.051	
22 (0.167)	6	R	22ER6ACME	●	●	0.500	0.098	0.079	22IR6ACME	●	●	0.500	0.098	0.079	
22 (0.200)	5	R	22ER6TPI29 (STACME)	●		0.500	0.098	0.079	22IR6TPI29 (STACME)	●		0.500	0.098	0.079	
22 (0.200)	5	R	22ER5ACME	●	●	0.500	0.098	0.079	22IR5ACME	●	●	0.500	0.098	0.079	
22 (0.200)	5	R	22ER5TPI29 (STACME)	●		0.500	0.098	0.079	22IR5TPI29 (STACME)	●		0.500	0.098	0.079	

TPI29 inserts are semi-topping insert. STACME inserts are full-topping insert.

29° Trapezoidal / ACME (for Machine parts, Pipe)

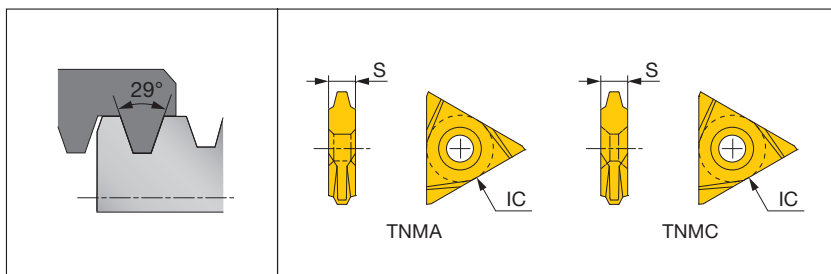

Applicable toolholder

External
MTVOR...
STVOR...

On edge

Pitch	TPI	External insert (in)			
		Designation	Grade	IC	S
			Coated		
		AH725			
16		TNMA43NT16PEXT-PT	●	0.500	0.189
14		TNMA43NT14PEXT-PT	●	0.500	0.189
12		TNMA43NT12PEXT-PT	●	0.500	0.189
10		TNMA43NT10PEXT-PT	●	0.500	0.189
8		TNMA43NT8PEXT-PT	●	0.500	0.189
6		TNMA43NT6PEXT-PT	●	0.500	0.189
5		TNMA54NT5PEXT-PT	●	0.625	0.252
4		TNMA54NT4PEXT-PT	●	0.625	0.252
3		TNMA54NT3PEXT-PT	●	0.625	0.252
16		TNMC43NT16PEXT-PT	●	0.500	0.189
14		TNMC43NT14PEXT-PT	●	0.500	0.189
12		TNMC43NT12PEXT-PT	●	0.500	0.189
10		TNMC43NT10PEXT-PT	●	0.500	0.189
8		TNMC43NT8PEXT-PT	●	0.500	0.189
6		TNMC43NT6PEXT-PT	●	0.500	0.189
5		TNMC54NT5PEXT-PT	●	0.625	0.252
4		TNMC54NT4PEXT-PT	●	0.625	0.252
3		TNMC54NT3PEXT-PT	●	0.625	0.252

● : Line up / 5 pieces per package

29° Trapezoidal/ STUB ACME (for Machine parts, Pipe)

On edge

Pitch	TPI	External insert (in)			
		Designation	Grade	IC	S
			Coated AH725		
16		TNMA43NT16PSTUBE-PT	●	0.500	0.189
14		TNMA43NT14PSTUBE-PT	●	0.500	0.189
12		TNMA43NT12PSTUBE-PT	●	0.500	0.189
10		TNMA43NT10PSTUBE-PT	●	0.500	0.189
8		TNMA43NT8PSTUBE-PT	●	0.500	0.189
6		TNMA43NT6PSTUBE-PT	●	0.500	0.189
5		TNMA54NT5PSTUBE-PT	●	0.625	0.252
4		TNMA54NT4PSTUBE-PT	●	0.625	0.252
3		TNMA54NT3PSTUBE-PT	●	0.625	0.252
16		TNMC43NT16PSTUBE-PT	●	0.500	0.189
14		TNMC43NT14PSTUBE-PT	●	0.500	0.189
12		TNMC43NT12PSTUBE-PT	●	0.500	0.189
10		TNMC43NT10PSTUBE-PT	●	0.500	0.189
8		TNMC43NT8PSTUBE-PT	●	0.500	0.189
6		TNMC43NT6PSTUBE-PT	●	0.500	0.189
5		TNMC54NT5PSTUBE-PT	●	0.625	0.252
4		TNMC54NT4PSTUBE-PT	●	0.625	0.252
3		TNMC54NT3PSTUBE-PT	●	0.625	0.252

Applicable toolholder

External
MTVOR...
STVOR...

ACME and STUB ACME can cut crest radius. Crest flat of ACME and STUB ACME need to be cut by another tool.

API Round (for Energy)

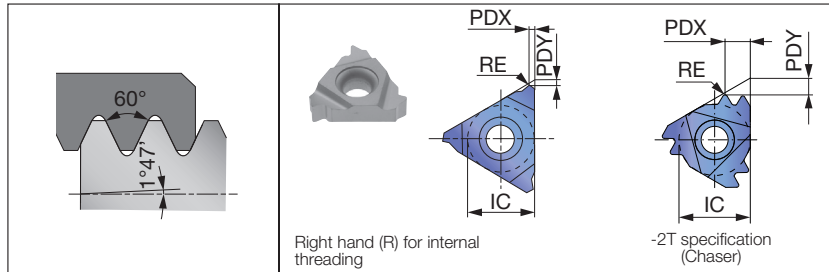

Applicable toolholder

Insert size	External	Internal
16	CER/L**16... JSER**16 JS**SEL16 B-SER/L**16 B-CER/L**16 BC-SER/L**16	TSNR/L**16 SNR/L**16... TCNR/L**16... CNR/L**16...
		TSNR/L**22 SNR/L**22... TCNR/L**22... CNR/L**22...

Full-profile insert

Insert size	Pitch (Reference) (in)	TPI	Hand of cut	External insert (in)							Internal insert (in)						
				Designation	Grade		IC	PDX	PDY	RE	Designation	Grade		IC	PDX	PDY	RE
					Coated							Coated					
					AH725	T313V						AH725	T313V				
16 (0.100)	10	R	16ER10RAPI	●		0.375	0.063	0.047	0.0142	16IR10RAPI	●	●	0.375	0.063	0.047	0.0142	
16 (0.125)	8	R	16ER8RAPI	●		0.375	0.063	0.047	0.0169	16IR8RAPI	●	●	0.375	0.063	0.047	0.0169	
22 (0.125)	8	R								22IR8RAPI-2T	●		0.500	0.177	0.118	0.0169	

Full-profile insert with chipbreaker

Insert size	Pitch (Reference) (in)	TPI	Hand of cut	External insert (in)							Internal insert (in)						
				Designation	Grade		IC	PDX	PDY	RE	Designation	Grade		IC	PDX	PDY	RE
					Coated							Coated					
					AH725							AH725					
16 (0.100)	10	R	16ER10RD-CB	●		0.375	0.047	0.059	0.0142	16IR10RD-CB	●		0.375	0.047	0.059	0.0142	
16 (0.125)	8	R	16ER8RD-CB	●		0.375	0.051	0.059	0.0169	16IR8RD-CB	●		0.375	0.051	0.059	0.0169	

Reference pages: Toolholders → **E032 - E042**,
Standard cutting conditions → **E054, L044 - L060**

● : Line up / 5 pieces per package

API Round (for Energy)

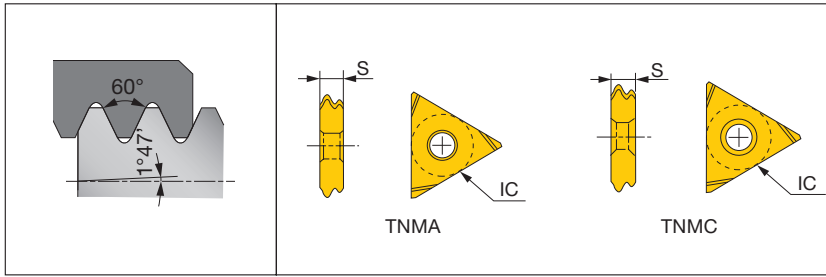

Applicable toolholder

External	Internal
MTHOR...	SI-MTHOR...
MTVOR...	SI-STHOR...
STVOR...	H**-MTHOR...
GTB...	H**M-MTHOR...

On edge

Pitch (Reference) (in)	TPI	External insert (in)				Internal insert (in)			
		Designation	Grade	IC	S	Designation	Grade	IC	S
			Coated AH725				Coated AH725		
(0.100)	10	TNMA4310RDEXT	●	0.500	0.189	TNMA4310RDINT	●	0.500	0.189
(0.125)	8	TNMA438RDEXT	●	0.500	0.189	TNMA438RDINT	●	0.500	0.189
(0.100)	10	TNMC4310RDEXT	●	0.500	0.189	TNMC4310RDINT	●	0.500	0.189
(0.125)	8	TNMC438RDEXT	●	0.500	0.189	TNMC438RDINT	●	0.500	0.189

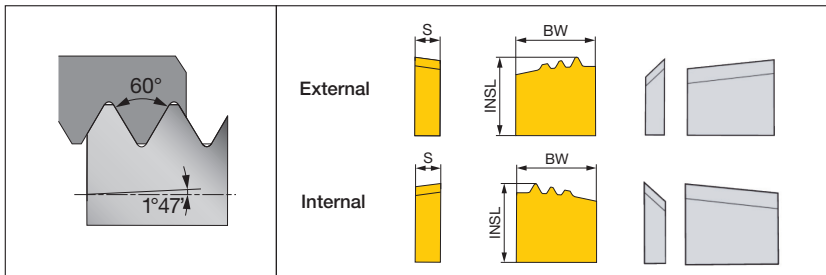

Applicable toolholder

External	Internal
CLVOR...	SI-CLHOR...

Full-profile insert (chaser)

Pitch (Reference) (mm)	TPI	External insert (mm)						Internal insert (mm)					
		Designation	Grade	BW	INSL	S	Breakerpiece	Designation	Grade	BW	INSL	S	Breakerpiece
			Coated AH725						Coated AH725				
(3.175)	8	CR-8R-3E	●	16	15	5.2	CR-8R / 10R-3E / 4E-CB	●	16	15	5.2	CR-8R / 10R-3I / 4I-CB	
(2.54)	10	CR-10R-3E	●	16	15.9	5.2	CR-8R / 10R-3E / 4E-CB	●	16	15.9	5.2	CR-8R / 10R-3I / 4I-CB	

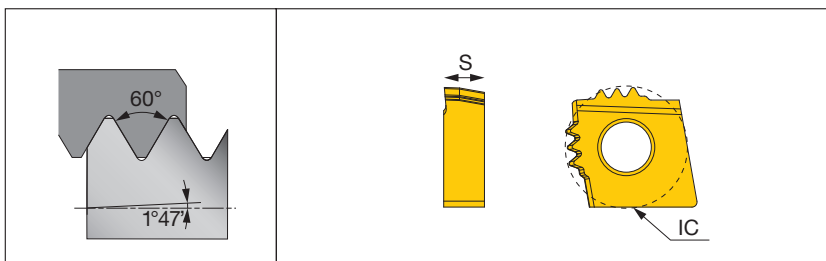

Applicable toolholder

External
PCFNR...

Full-profile insert (chaser)

Pitch (Reference) (mm)	TPI	External insert (mm)			
		Designation	Grade	IC	S
			Coated AH725		
(2.54)	10	CNGA-10R-3E	●	19.05	6.4
(3.175)	8	CNGA-8R-3E	●	19.05	6.4

Toolholders need to be customized for these types of inserts.

Reference pages: Toolholders → [E032 - E042](#),
Standard cutting conditions → [E054](#)

● : Line up / 5 pieces per package

API Round (for Energy) For tool-rotating machines

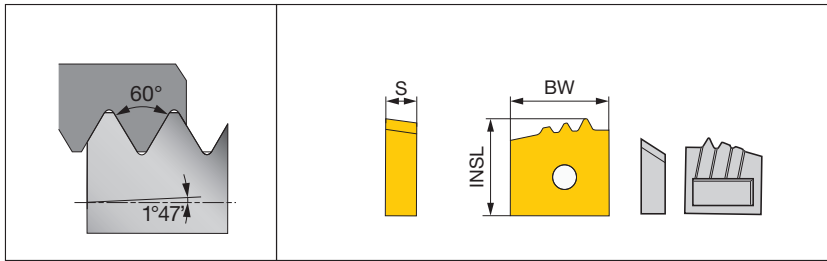

Applicable toolholder

External
CLVOR...

Full-profile insert (chaser)

Pitch (Reference) (mm)	TPI	External insert (mm)					
		Designation	Grade	BW	INSL	S	Breakerpiece
			Coated AH725				
(3.175)	8	CR-8R-3E #1	●	16	14.7	5.2	TD39318R-1-CBW/CAVITY
(3.175)	8	CR-8R-3E #2	●	16	14.9	5.2	TD39328R-2-CBW/CAVITY
(3.175)	8	CR-8R-3E #3	●	16	15	5.2	TD39338R-3-CBW/CAVITY

Toolholders need to be customized for these types of inserts.

API Buttress (for Energy industry)

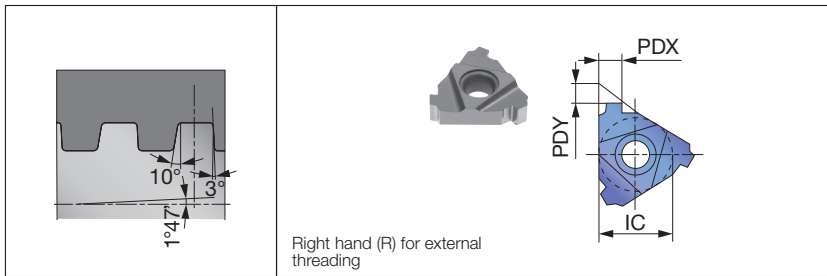

Applicable toolholder

Insert size	External	Internal
22	CER/L**22...	TSNR/L**22 SNR/L**22... TCNR/L**22... CNR/L**22...

Full-profile insert

Insert size	Pitch (Reference) (in)	TPI	Hand of cut	External insert (in)					Internal insert (in)				
				Designation	Grade	IC	PDX	PDY	Designation	Grade	IC	PDX	PDY
					Coated AH725					Coated AH725			
22	(0.200)	5	R	22ER5BAPI	●	0.500	0.146	0.087	22IR5BAPI	●	0.500	0.136	0.087

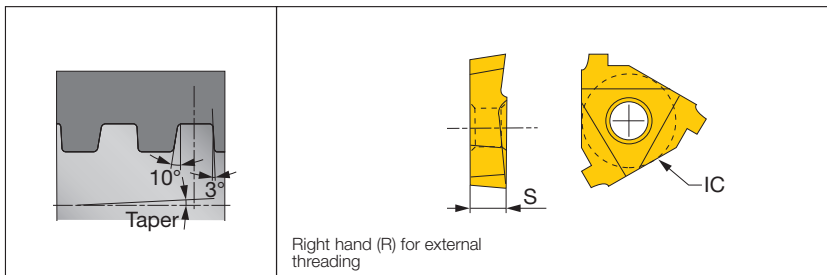

Applicable toolholder

External	Internal
MTVNR...	H**-LNFR... H**M-LNFR... HS**-LNFR...

Full-profile insert (single side)

Pitch (Reference) (mm)	TPI	Taper	External insert (mm)				Internal insert (mm)			
			Designation	Grade	IC	S	Designation	Grade	IC	S
		TPF	Coated AH725	Coated AH725						
(5.08)	5	0.75	L535B75EXT-FC	●	15.875	4.8	L535B75INT-FC	●	15.875	4.8
(5.08)	5	1	L535B1EXT-FC	●	15.875	4.8	L535B1INT-FC	●	15.875	4.8

Reference pages: Toolholders → **E032 - E042**,
Standard cutting conditions → **E054**

● : Line up / 5 pieces per package

API Buttress (for Energy industry)

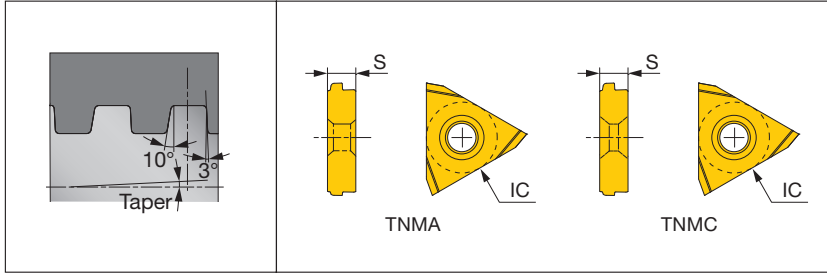

Applicable toolholder

External	Internal
MTHOR...	SI-MTHOR...
MTVOR...	SI-STHOR...
STVOR...	H**-MTHOR...
GTB...	H**M-MTHOR...

On edge

Pitch (Reference) (in)	TPI	Taper TPF	External insert (in)				Internal insert (in)			
			Designation	Grade	IC	S	Designation	Grade	IC	S
				Coated AH725				Coated AH725		
(0.200)	5	1	TNMA545B1EXT-FC	●	0.625	0.252	TNMA545B1INT-FC	●	0.625	0.252
(0.200)	5	0.75	TNMA545B75EXT-FC	●	0.625	0.252	TNMA545B75INT-FC	●	0.625	0.252
(0.200)	5	1	TNMC545B1EXT-FC	●	0.625	0.252	TNMC545B1INT-FC	●	0.625	0.252
(0.200)	5	0.75	TNMC545B75EXT-FC	●	0.625	0.252	TNMC545B75INT-FC	●	0.625	0.252

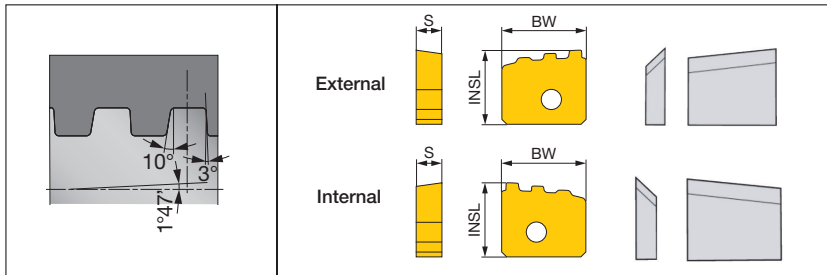

Applicable toolholder

External	Internal
CLVOR...	SI-CLHOR...

Full-profile insert (chaser)

Pitch (Reference) (mm)	TPI	External insert (mm)						Internal insert (mm)					
		Designation	Grade	BW	INSL	S	Breakerpiece	Designation	Grade	BW	INSL	S	Breakerpiece
			Coated AH725						Coated AH725				
(5.08)	5	CR-5B75-4E	●	20.4	15.9	5.1	CR-5B75 / 5B1-4E-CB	●	16	15.8	5.2	CR-8R / 10R-3I / 4I-CB	

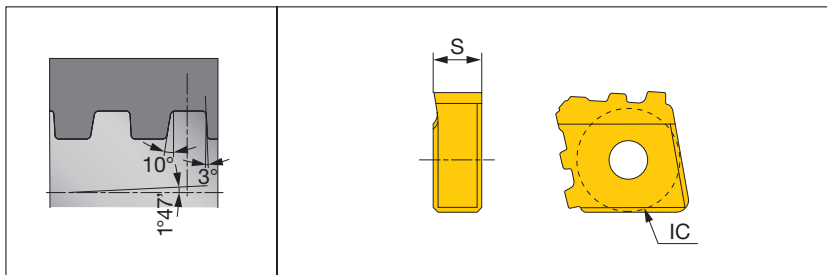

Applicable toolholder

External
PCFNR...

Full-profile insert (chaser)

Pitch (Reference) (mm)	TPI	External insert (mm)			
		Designation	Grade	IC	S
			Coated AH725		
(5.08)	5	CNGA-5B75-3E	●	19.05	6.4

Toolholders need to be customized for these types of inserts.

Reference pages: Toolholders → [E032 - E042](#),
Standard cutting conditions → [E054](#)

● : Line up / 5 pieces per package

API Buttress (for Energy industry) For tool-rotating machines

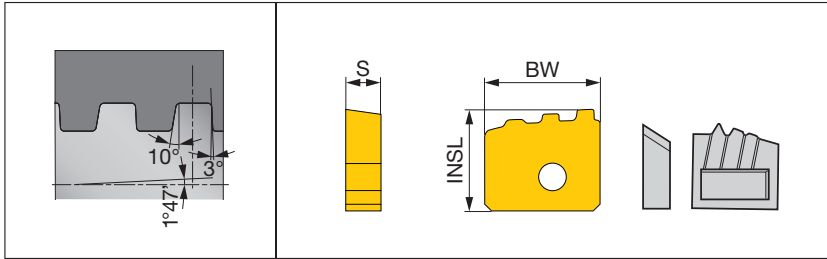

Applicable toolholder

External
CLVOR...

Full-profile insert (chaser)

Pitch (Reference) (mm)	TPI	External insert (mm)						Breakerpiece
		Designation	Grade	BW	INSL	S	RE	
			Coated AH725					
(5.08)	5	CR-5B75-3E #1	●	17	14.6	5.2	TD46015B75-1-CBW/CAVITY	
(5.08)	5	CR-5B75-3E #2	●	17	14.8	5.2	TD46025B75-2-CBW/CAVITY	
(5.08)	5	CR-5B75-3E #3	●	17	15	5.2	TD46035B75-3-CBW/CAVITY	

Toolholders need to be customized for these types of inserts.

API Rotary shoulder connection (for Energy industry)

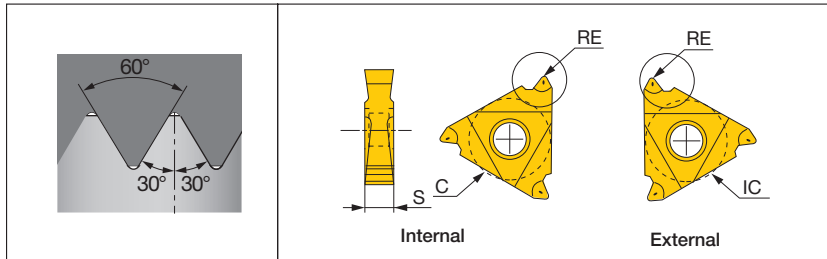

Applicable toolholder

External	Internal
MTVNR...	H**-LNFR... H**M-LNFR... HS**-LNFR...

Full-profile insert (Double side)

Pitch (Reference) (in)	TPI	Connection	Taper	Designation	Grade	IC (in)	S (in)	RE (in)
			TPF		Coated AH725			
(0.250)	4	V-0.038R	2	LDS54428FT-CB #1	●	0.625	0.252	0.038
(0.250)	4	V-0.038R	3	LDS54438FT-CB #2	●	0.625	0.252	0.038
(0.250)	4	V-0.050	2	LDS54425FT-CB #3	●	0.625	0.252	0.025
(0.250)	4	V-0.050	3	LDS54435FT-CB #4	●	0.625	0.252	0.025
(0.200)	5	V-0.040	3	LDS54530FT-CB #5	●	0.625	0.252	0.020

● : Line up / 5 pieces per package

External threading toolholder with high pressure coolant capability

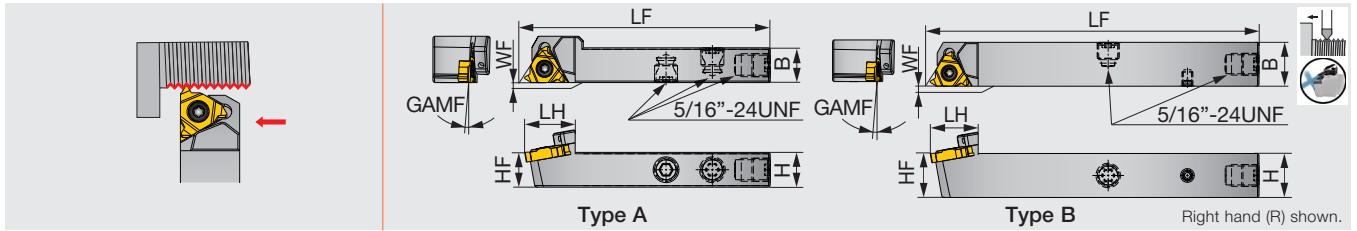

Inch	H	B	LF	LH	HF	WF	GAMF	Type	Insert
JSE2R08F16-CHP	0.500	0.500	3.344	0.748	0.500	0.000	1°	A	16ER...
JSE2R08X16-CHP	0.500	0.500	4.750	0.748	0.500	0.000	1°	B	16ER...
JSE2R10X16-CHP	0.625	0.625	4.750	0.748	0.625	0.000	1°	B	16ER...
Metric	H	B	LF	LH	HF	WF	GAMF	Type	Insert
JSE2R1212F16-CHP *	12	12	85	19	12	0	1°	A	16ER...
JSE2R1212X16-CHP	12	12	120	19	12	0	1°	B	16ER...
JSE2R1616X16-CHP	16	16	120	19	16	0	1°	B	16ER...

* Connection with external coolant tube

SPARE PARTS

Designation	Clamping screw	Wrench
JSE2R**16-CHP	CSTB-3.5	T-15F

No need for coolant tube setup.

Eliminates chip entanglement on tubes and streamlines tool replacement.

Coolant is supplied from the tool post directly to the tools

Internal thread
Optional connection with external coolant tube

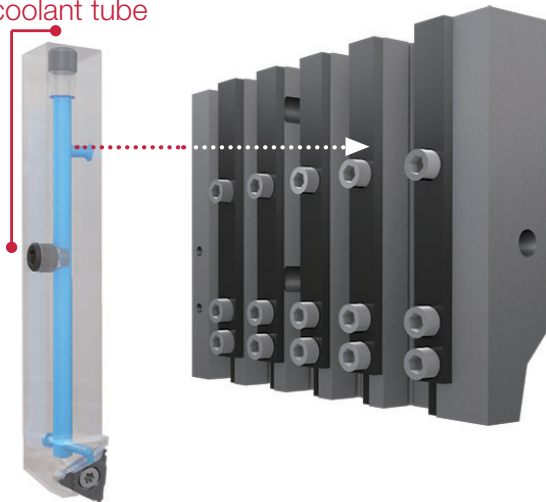

Detailed view of the coolant flow after connection

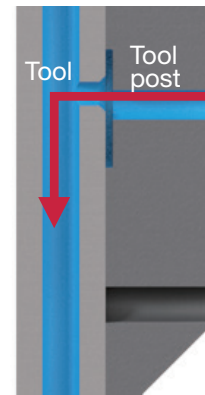

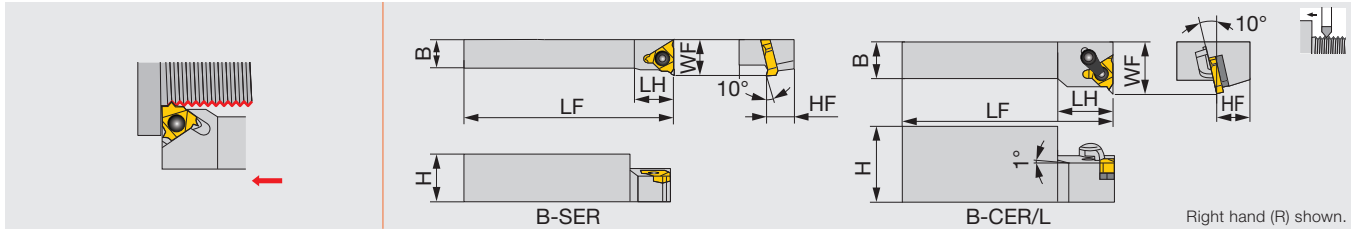

Metric	H	B	LF	LH	HF	WF	Insert
B-SER10H16	20	10	100	15	10	16	16ER...
B-SER12K16	24	12	125	18	12	18	16ER...
B-CER/L16M16	32	16	150	24	16	22	16ER/L...

SPARE PARTS

Designation	Clamp set	Shim set	Clamping screw	Wrench
B-SER**16	-	-	CSTB-3.5	T-15F
B-CER/L16M16	CSP16	A16-1	-	T-15F

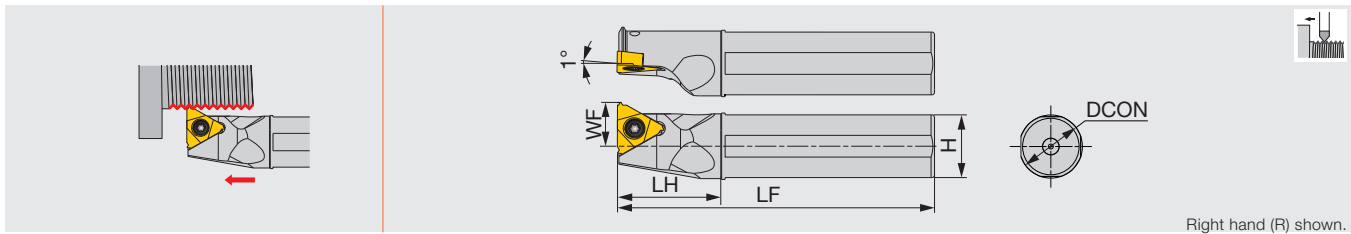

Inch	DCON	H	LF	LH	WF	Insert
JS16F-SEL16	0.630	0.591	3.346	0.984	0.433	16ER...
JS19G-SEL16	0.750	0.709	3.543	1.181	0.492	16ER...
JS19X-SEL16	0.750	0.709	4.724	1.181	0.492	16ER...
JS20G-SEL16	0.787	0.748	3.543	1.181	0.512	16ER...
JS20X-SEL16	0.787	0.748	4.724	1.181	0.512	16ER...
JS25HSEL16	0.984	0.945	3.937	1.181	0.61	16ER...
JS254X-SEL16	1.000	0.945	4.724	1.181	0.618	16ER...

Metric	DCON	H	LF	LH	WF	Insert
JS16F-SEL16	16	15	85	25	11	16ER...
JS19G-SEL16	19.05	18	90	30	12.5	16ER...
JS19X-SEL16	19.05	18	120	30	12.5	16ER...
JS20G-SEL16	20	19	90	30	13	16ER...
JS20X-SEL16	20	19	120	30	13	16ER...
JS25HSEL16	25	24	100	30	15.5	16ER...
JS254X-SEL16	25.4	24	120	30	15.7	16ER...

Use left-hand toolholders (L) with right-hand inserts (R).

SPARE PARTS

Designation	Clamping screw	Wrench
JS***-SEL16	CSTB-3.5	T-15F

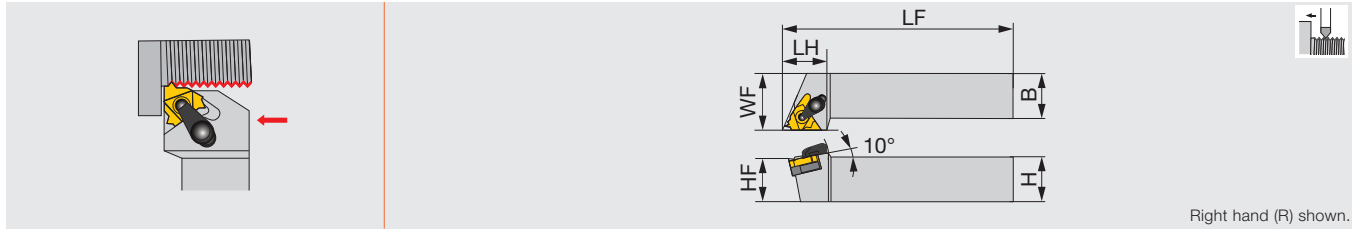

Right hand (R) shown.

Inch	H	B	LF	LH	HF	WF	Insert
CER/L123DT	0.750	0.750	5.000	0.870	0.750	1.000	16ER/L...
CER/L163DT	1.000	1.000	6.000	1.000	1.000	1.250	16ER/L...
CER203DT	1.250	1.250	6.000	1.250	1.250	1.500	16ER...
CER164DT	1.000	1.000	6.000	1.000	1.000	1.250	22ER...
CER204DT	1.250	1.250	6.000	1.250	1.250	1.500	22ER...

Metric	H	B	LF	LH	HF	WF	Insert
CER/L1212H16DT	12	12	100	24	12	16	16ER/L...
CER/L1616H16DT	16	16	100	24	16	20	16ER/L...
CER/L2020K16DT	20	20	125	24	20	25	16ER/L...
CER/L2525M16DT	25	25	150	28	25	32	16ER/L...
CER/L2525M22DT	25	25	150	31.3	25	32	22ER/L...
CER3232P16T	32	32	170	32	32	40	16ER...
CER3232P22T	32	32	170	32	32	40	22ER...
CER2525M27T	25	25	150	34	25	32	27ER...
CER3232P27T	32	32	170	34	32	40	27ER...

A clamp set consists of a clamp and a clamping screw. A shim set consists of a shim and a shim screw to secure the shim to the shank. Standard shims can be used on both right- and left-hand toolholders. Please use either of the sides depending on the tool hand. When using DT type, please remove either the clamp set or the insert clamping screw.

SPARE PARTS								
Designation	Clamp set	Clamping screw	Shim screw	Shim	Shim set	Wrench 1	Wrench 2	Wrench 3
CER/L 123-DT	CSP16	CSTB-3.5ST	DTS5 - 3.5	A16 - 1DT	-	P-3.5	T-15F	-
CER/L 163-DT	CSP16	CSTB-3.5ST	DTS5 - 3.5	A16 - 1DT	-	P-3.5	T-15F	-
CER 203-DT	CSP22	CSTB-4ST	DTS6-4	GX22-1DT	-	P-3.5	T-15F	-
CER164-DT	CSP22	CSTB-4ST	DTS6-4	GX22-1DT	-	P-4	T-20F	-
CER 204-DT	CSP22	CSTB-4ST	DTS6-4	GX22-1DT	-	P-4	T-20F	-
CER/L**16DT	CSP22	CSTB-3.5ST	DTS5-3.5	A16-1DT	-	P-3.5	T-15F	-
CER/L2525M22DT	CSP22	CSTB-4ST	DTS6-4	GX22-1DT	-	P-4	T-15F	T-20F
CER3232P16T	CSP16	-	-	-	A16-1	-	T-15F	-
CER3232P22T	CSP22	-	-	-	NXE22-1	-	T-20F	-
CER**27T	CSP27	-	-	-	NXE27-1	P-4	-	-

TUNGCAP

C-CER/L

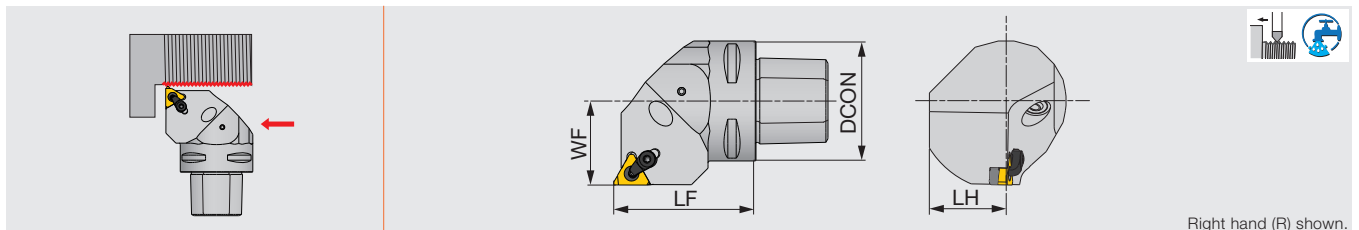

Right hand (R) shown.

Metric	DCON	LF	LH	WF	RE	Insert
C4CER/L27050-16ERN(2)	40	50	25	27	0.8	16ER/L...
C5CER/L35060-16ER(1)	50	60	32	35	0.8	16ER/L...
C5CER/L35060-16ERN(2)	50	60	32	35	0.8	16ER/L...
C6CER/L45065-16ER(1)	63	65	41	45	0.8	16ER/L...
C6CER/L45065-16ERN(2)	63	65	41	45	0.8	16ER/L...

(1) Applicable for 3 MPa coolant (2) Applicable for 7 MPa coolant

SPARE PARTS							
Designation	Clamp set	Clamping screw	Coolant parts	Shim screw	Shim	Wrench 1	Wrench 2
C5CE*35060-16ER	CSP16	CSTB-3.5ST	EZ104	DTS5-3.5	A16-1DT	P-3.5	T-15F
C5CE*35060-16ERN	CSP16	CSTB-3.5ST	SATZ-M10X1-M5	DTS5-3.5	A16-1DT	P-3.5	T-15F
C6CE*45065-16ER	CSP16	CSTB-3.5ST	EZ104	DTS5-3.5	A16-1DT	P-3.5	T-15F
C6CE*45065-16ERN	CSP16	CSTB-3.5ST	SATZ-M10X1-M5	DTS5-3.5	A16-1DT	P-3.5	T-15F

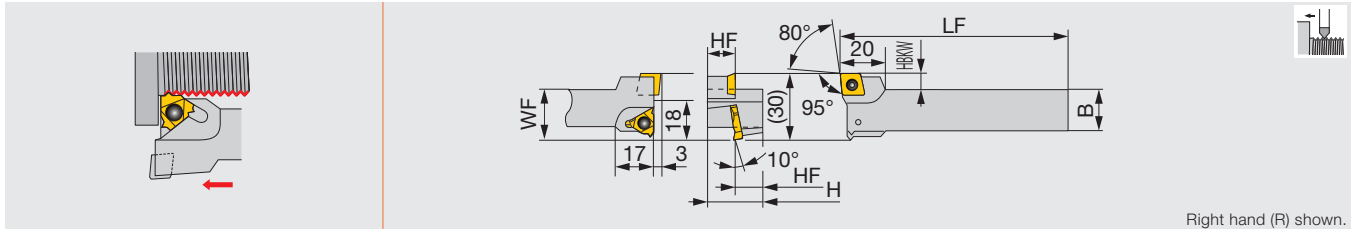

Right hand (R) shown.

Metric	H	B	LF	HF	WF	HBKW	Insert
BC-SER12K16	24	16	125	12	23	7	16ER..., CC*T09T3...

SPARE PARTS

Designation	Clamping screw	Wrench
BC-SER12K16	CSTB-3.5	T-15F

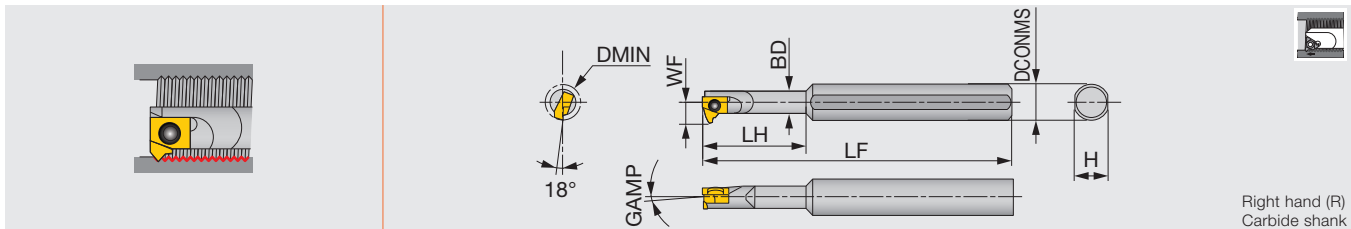

Right hand (R)
Carbide shank

Metric	Material	DMIN	DCONMS	BD	WF	LF	LH	H	GAMP	Insert
SNR0006H06-2	Steel	8	8	6	4.7	100	18	7	2°	6IR...
SNR0006H06-3	Steel	8	8	6	4.7	100	18	7	3°	6IR...
SNR0008H06-2	Steel	10	8	7.8	5.7	100	18	7	2°	6IR...
SNR0008H06-3	Steel	10	8	7.8	5.7	100	18	7	3°	6IR...
SNR0006K06SC-2	Carbide	8	8	6	4.7	125	30	7	2°	6IR...
SNR0006K06SC-3	Carbide	8	8	6	4.7	125	30	7	3°	6IR...
SNR0008K06SC-2	Carbide	10	8	7.8	5.7	125	18	7	2°	6IR...
SNR0008K06SC-3	Carbide	10	8	7.8	5.7	125	18	7	3°	6IR...

Use right-hand toolholders (R) with right-hand inserts (R).

SPARE PARTS

Designation	Clamping screw	Wrench
SNR0006H06...	CSTB-2L040	T-6F
SNR0008H06...	CSTB-2L	T-6F
SNR0006K06SC...	CSTB-2L040	T-6F
SNR0008K06SC...	CSTB-2L	T-6F

Reference pages: C-CER/L: Inserts → **E010, E014, E016 - E027**

BC-SER/L: Inserts → **B111 - (CC*T09T3...), E010, E014, E016 - E027 (16ER...)**

SNR/L-2/3: Inserts → **E016, E020 - E022**

Standard cutting conditions → **E054**

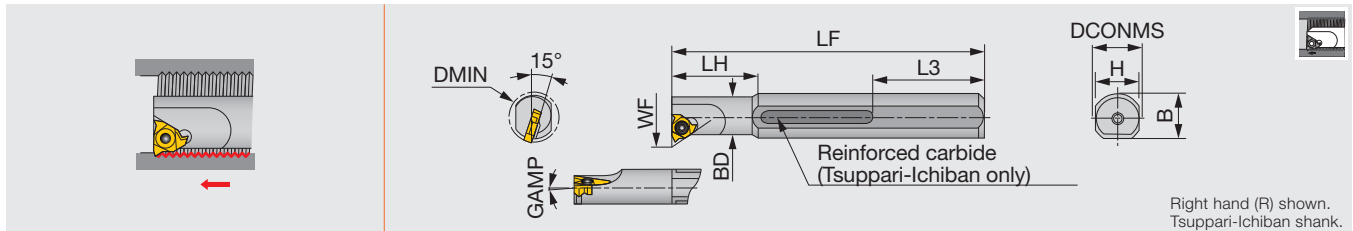

Right hand (R) shown.
Tsuppari-Ichiban shank.

Metric	Material	DMIN	DCONMS	BD	WF	LF	LH	L3	H	B	GAMP	Insert
TSNR0016Q16	Reinforced	19	16	15.5	10.6	180	40	59	15	-	1°	16IR...
TSNR0020R22	Reinforced	24	20	19.5	13.9	200	50	49	18	-	1°	22IR...
SNR/L0010K11	Steel	12	16	10	6.6	125	25	-	15	15.5	1°	11IR/L...
SNR0010K11-2	Steel	12	16	10	6.6	125	25	-	15	15.5	2°	11IR...
SNR0010K11-3	Steel	12	16	10	6.6	125	25	-	15	15.5	3°	11IR...
SNR/L0013L11	Steel	15	16	13	8.2	140	32.5	-	15	15.5	1°	11IR/L...
SNR0013L11-2	Steel	15	16	13	8.2	140	32.5	-	15	15.5	2°	11IR...
SNR0013L11-3	Steel	15	16	13	8.2	140	32.5	-	15	15.5	3°	11IR...
SNR/L0016M16	Steel	19	16	15.5	10.6	150	40	-	15	15.5	1°	16IR/L...
SNR0016M16-2	Steel	19	16	15.5	10.6	150	40	-	15	15.5	2°	16IR...
SNR0016M16-3	Steel	19	16	15.5	10.6	150	40	-	15	15.5	3°	16IR...
SNR/L0020Q22	Steel	24	20	19.5	13.9	180	50	-	18	19	1°	22IR/L...
SNR0020Q22-2	Steel	24	20	19.5	13.9	180	50	-	18	19	2°	22IR...
SNR0020Q22-3	Steel	24	20	19.5	13.9	180	50	-	18	19	3°	22IR...
SNR0010M11SC	Carbide	13	10	10.5	7.4	150	24	-	9	-	1°	11IR...
SNR0010M11SC-2	Carbide	13	10	10.5	7.4	150	24	-	9	-	2°	11IR...
SNR0010M11SC-3	Carbide	13	10	10.5	7.4	150	24	-	9	-	3°	11IR...
SNR0012P11SC	Carbide	15	12	12.4	8.5	170	28	-	11	-	1°	11IR...
SNR0012P11SC-2	Carbide	15	12	12.4	8.5	170	28	-	11	-	2°	11IR...
SNR0012P11SC-3	Carbide	15	12	12.4	8.5	170	28	-	11	-	3°	11IR...
SNR/L0016R16SC	Carbide	20	16	16.2	11.9	200	35	-	15	-	1°	16IR/L...
SNR0016R16SC-2	Carbide	20	16	16.2	11.9	200	35	-	15	-	2°	16IR...

Use right-hand toolholders (R) with right-hand inserts (R); and left-hand toolholders (L) with left-hand inserts (L).

SPARE PARTS



Designation	Clamping screw	Wrench
TSNR0016Q16	CSTB-3.5	T-15F
TSNR0020R22	CSTB-4	T-15F
SNR/L00**11...	CSTB-2.5	T-8F
SNR/L0016M16...	CSTB-3.5	T-15F
SNR/L0020Q22...	CSTB-4	T-15F
SNR00**11SC...	CSTB-2.5	T-8F
SNR/L0016R16SC...	CSTB-3.5	T-15F

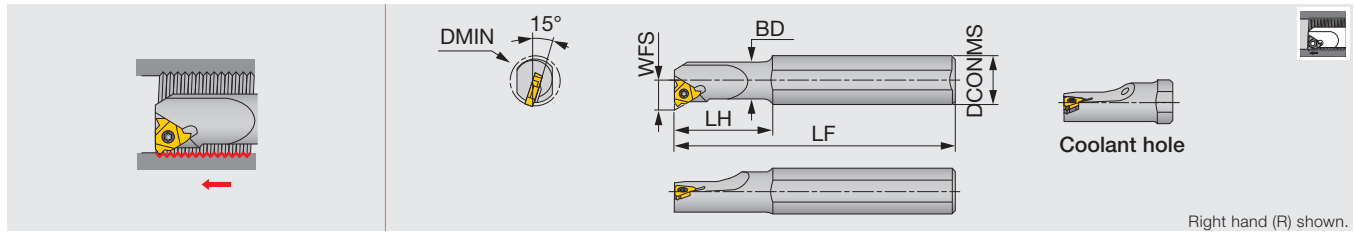

Right hand (R) shown.

Inch	Material	DMIN	DCONMS	BD	WFS	LF	LH	Coolant	Insert
SIR0500M16B	Steel	0.640	0.625	0.500	0.390	6.000	1.260	Y	16IR...
SIR0625P16B	Steel	0.750	0.750	0.625	0.450	7.000	1.570	Y	16IR...
SIR0750P16	Steel	1.000	0.750	0.750	0.510	7.000	-	N	16IR...
SIR0750P16B	Steel	0.900	0.750	0.750	0.900	7.000	-	Y	16IR...
SIR0750P22	Steel	0.950	0.750	0.750	0.510	7.000	-	N	22IR...
SIR1000R16B	Steel	1.160	1.000	1.000	0.650	8.000	-	Y	16IR...
SIR1000R22	Steel	1.200	1.000	1.000	0.710	8.000	-	N	22IR...
SIR1250S16	Steel	1.420	1.250	1.250	0.770	10.000	-	N	16IR...
SIR1250S22	Steel	1.500	1.250	1.250	0.850	10.000	-	N	22IR...
SIR 1500 T27	Steel	1.800	1.500	1.500	1.000	12.000	-	N	27IR...

SPARE PARTS

Designation	Clamping screw	Shim	Shim screw	Wrench	Seal cap
SIR0500M16B	SR5-40-L9.7-S16S	-	-	T-10/5	PL062
SIR0625P16B	SR 5-40-L9.7-S16S	-	-	T-10/5	PL 075
SIR0750P16	SR5-40-L12.2S16	Al16	SR5-40-L6.8-A16	T-10/5	-
SIR0750P16B	SR 5-40-L12.2-S16	Al16	SR 5-40-L6.8-A16	T-10/5	PL 075
SIR0750P22	SR8-32-L12-S22S	-	-	T-20/5	-
SIR1000R16B	SR 5-40-L12.2-S16	Al16	SR 5-40-L6.8-A16	T-10/5	PL 100
SIR1000R22	SR8-32-L15-S22	Al22	SR8-32-L5.8-A22	T-20/5	-
SIR1250S16	SR 5-40-L12.2-S16	Al16	SR 5-40-L6.8-A16, SR 8-32-L5.8-A22	T-10/5	-
SIR1250S22	SR8-32-L15-S22	Al22	SR8-32-L5.8-A22	T-20/5	-
SIR 1500 T27	SRM5-L22-S40	Al27	SRM5-L5.8-A27	T-25/3	-



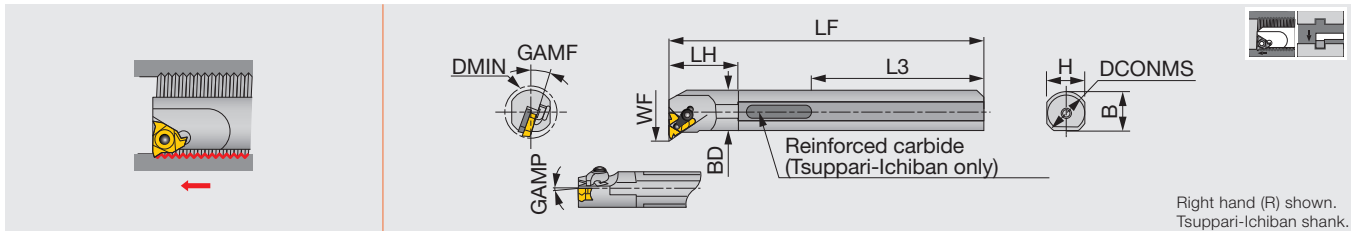

Metric	Material	DMIN	DCONMS	BD	WF	LF	LH	L3	H	B	GAMP	GAMP	Insert
TCNR0020R16DT	Reinforced	24	20	19.5	14	200	30	49	18	-	15°	1°	16IR...
TCNR0025S16DT	Reinforced	29	25	24.5	16.5	250	38	64	23	-	15°	1°	16IR...
TCNR0025S22DT	Reinforced	30	25	24.5	18.2	250	38	64	23	-	15°	1°	22IR...
CNR/L0020P16	Steel	24	20	19.5	14	170	30	-	18	19	15°	1°	16IR/L...
CNR/L0025R16	Steel	29	25	24.5	16.5	200	38	-	23	24	15°	1°	16IR/L...
CNR/L0032S16	Steel	37	32	31.5	20.1	250	48	-	30	31	15°	1°	16IR/L...
CNR/L0025R22	Steel	30	25	24.5	18.2	200	38	-	23	24	15°	1°	22IR/L...
CNR/L0032S22	Steel	38	32	31.5	21.9	250	48	-	30	31	15°	1°	22IR/L...
CNR0040T27	Steel	46	40	39.5	26.9	300	60	-	37	38.5	10°	1°	27IR ...

A clamp set consists of a clamp and a clamping screw.

A shim set consists of a shim and a shim screw to secure the shim to the shank.

Standard shims can be used on both right- and left-hand toolholders. Please use either of the sides depending on the tool hand.

When using DT type, please remove either the clamp set or the insert clamping screw.

SPARE PARTS

Designation	Clamp set	Clamping screw	Shim screw	Shim	Shim set R	Shim set L	Wrench 1	Wrench 2	Wrench 3
TCNR002**16DT	CSP16	CSTB-3.5ST	DTS5-3.5	A16-1DT	-	-	P-3.5	T-15F	-
TCNR0025S22DT	CSP22	CSTB-4ST	DTS6-4	GX22-1DT	-	-	P-4	T-15F	T-20F
CNR/L**16	CSP16	-	-	-	A16-1	A16-1	-	T-15F	-
CNR/L**22	CSP22	-	-	-	NXN22-1	NXE22-1	-	T-20F	-
CNR0040T27	CSP27	-	-	-	NXN27-1	NXE27-1	P-4	-	-

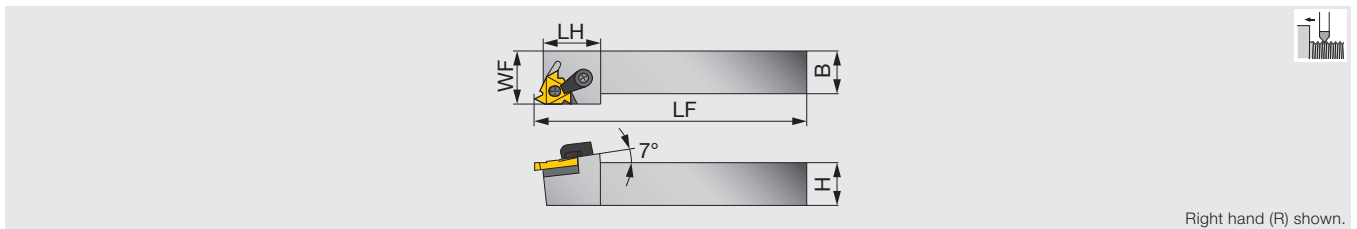

Inch	B	H	LF	LH	WF	Insert
MTVNR-2054	1-1/4	1-1/4	7.000	1.530	1.500	L535B**EXT-FC
MTVNR-2454	1.500	1.500	7.084	1.429	1.750	L535B**EXT-FC
Metric	B	H	LF	LH	WF	Insert
MTVNR-2525M5	25	25	152	39	31.8	L535B**EXT-FC
MTVNR-3232M5	32	32	178	39	38.1	L535B**EXT-FC

SPARE PARTS

Designation	Shim	Lock pin	Clamp	Clamping screw	Wrench
MTVNR...	LS53NOFORMEXT	NL-58	TC-250	STC-11	1/8HEX

Reference pages: Inserts → **E010, E014, E016 - E027**, Standard cutting conditions → **E054**

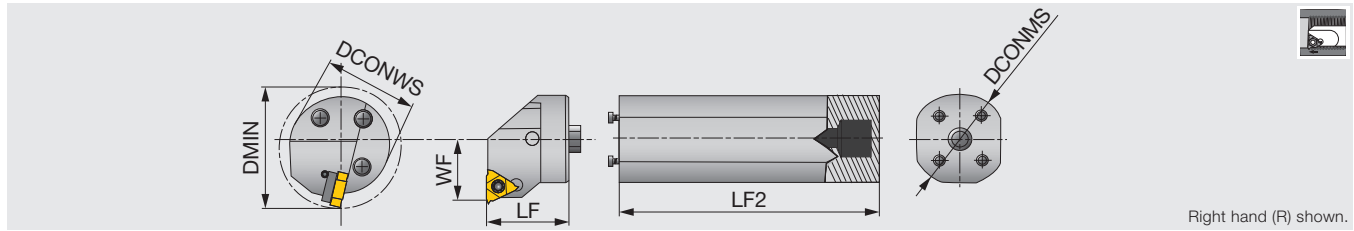

Metric	DMIN	DCONWS	WF	LF	Insert
HS40-LNFR-53	50	40	28.7	41.3	L535B**INT-FC
HS50-LNFR-53	63	50	32.7	41.3	L535B**INT-FC

SPARE PARTS

Designation	Lock pin	Clamp	Clamping screw	Wrench
HS**-LNFR-53	NL-56	TC-250	STC-11	1/8HEX

Shank

Inch	DCONMS	LF2
S-570-32-50	2.000	14.410
Metric	DCONMS	LF2
S-570-40M-40	40	273
S-570-50M-50	50	366

SPARE PARTS

Designation	Clamping screw	Wrench
S-570-40M-40	SS100	5/32HEX
S-570-50M-50	SS94	1/4EX

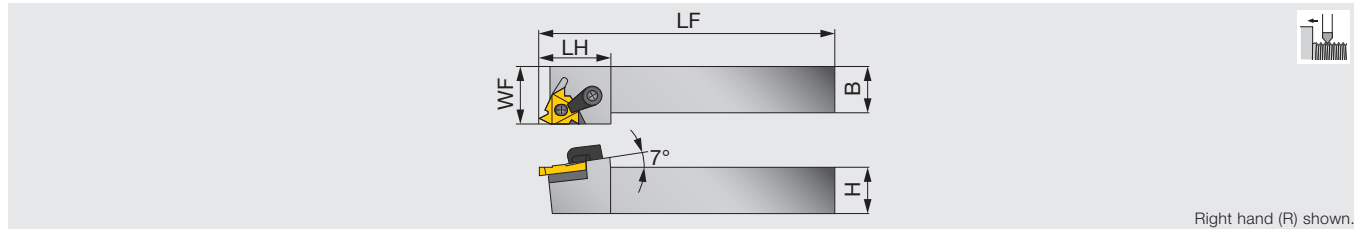

Metric	H	B	LF	LH	WF	Insert
MTVNR-3232M54	32	32	178	39	38.1	LDS54**FT-CB#...

SPARE PARTS

Designation	Shim	Lock pin	Clamp	Clamping screw	Wrench
MTVNR-3232M54	LS53NOFORMEXT	NL-58	TC-250	STC-11	1/8HEX

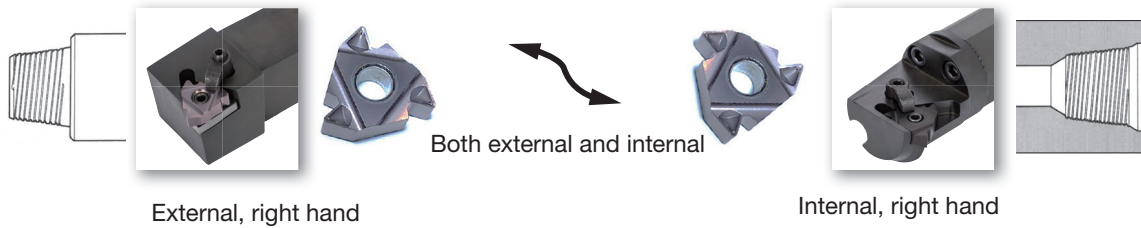

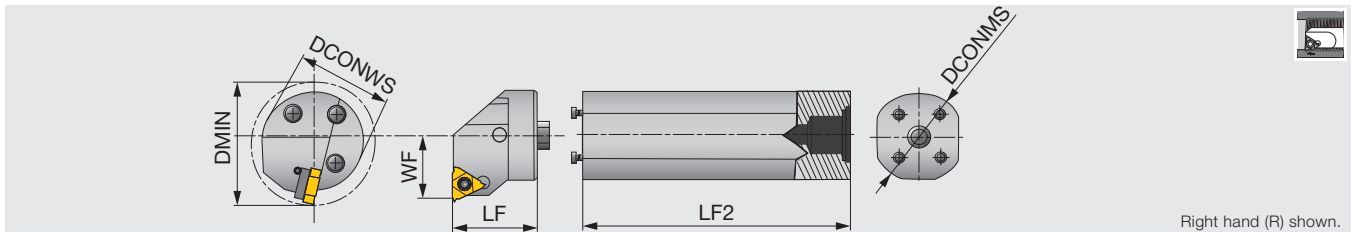

Right hand (R) shown.

Inch	DMIN	DCONWS	WF	LF	Insert
HS40-LNFR-54API	1.970	1.57	1.063	1.26	LDS54**FT-CB#...
HS50-LNFR-54API	2.480	1.97	1.378	1.57	LDS54**FT-CB#...

SPARE PARTS



Designation	Lock pin	Clamp	Clamping screw	Wrench
HS40-LNFR-54API	H410-1	TC-250	STC-11	1/8HEX
HS50-LNFR-54API	NL-56	TC-250	STC-11	1/8HEX

Shank

Inch	DCONMS	LF2
S-570-32-50	2.000	14.410
S-570-40M-40	1.575	10.750
S-570-50M-50	1.969	14.410

SPARE PARTS



Designation	Clamping screw	Wrench
S-570-40M-40	SS100	5/32HEX
S-570-50M-50	SS94	1/4EX

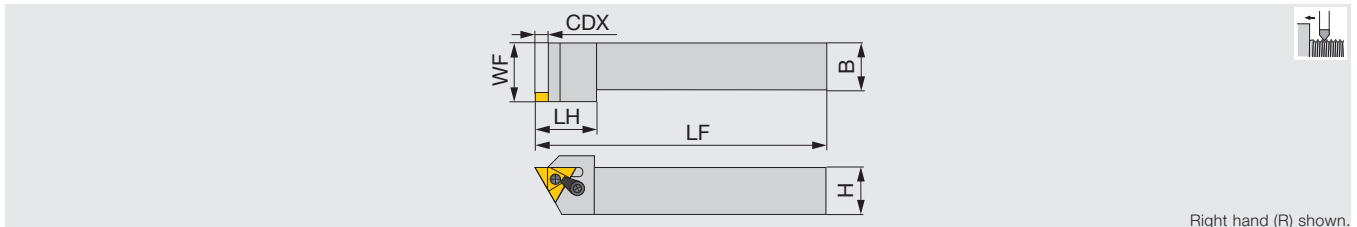

Right hand (R) shown.

Inch	H	B	LF	LH	WF	CDX	Insert
MTVOR-164	1.000	1.000	6.000	1.230	1.250	0.230	TNM*43...
MTVOR-204	1-1/4	1-1/4	7.000	1.230	1.500	0.230	TNM*43...
MTVOR-205	1-1/4	1-1/4	7.000	1.430	1.500	0.290	TNM*54...
MTVOR-206	1-1/4	1-1/4	7.000	1.620	1.500	0.370	TNM*66...
MTVOR-2069	1-1/4	1-1/4	7.000	1.620	1.500	0.370	TNM*69...

Metric	H	B	LF	LH	WF	CDX	Insert
MTVOR-2525M4	25	25	150	31	31.7	5.8	TNM*43...
MTVOR-3232M4	32	32	178	31	38.1	5.8	TNM*43...
MTVOR-2525M5	25	25	150	36	31.7	7.3	TNM*54...
MTVOR-3232M5	32	32	178	36	38.1	7.3	TNM*54...

STVOR/L is recommended for TNMC insert although the insert can be used on multi-clamp (M type) toolholder.

SPARE PARTS



Designation	Lock pin	Clamp	Clamping screw	Wrench
MTVOR-164/204, MTVOR-**M4	NL-44	TC-190	STC-5	3/32HEX
MTVOR-205, MTVOR-**M5	NL-56	TC-250	STC-11	1/8HEX
MTVOR-206	NL-66L	TC-310	STC-4	5/32HEX
MTVOR-2069	NL-66L	TC-311	STC-4	5/32HEX

Screw-on external threading toolholder, for on edge inserts

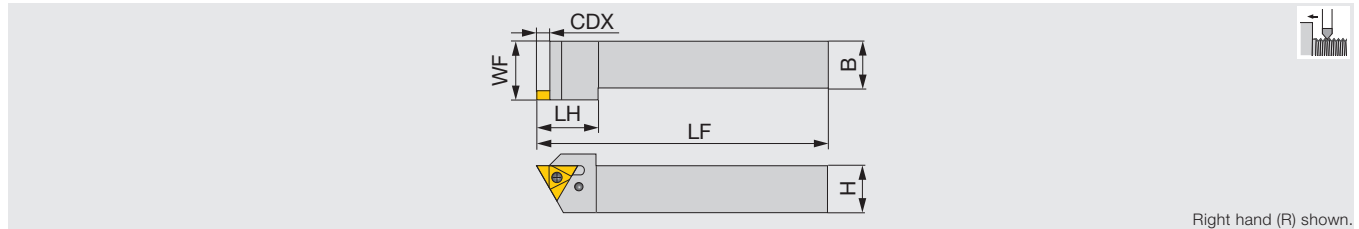

Right hand (R) shown.

Inch	H	B	LF	LH	WF	CDX	Insert
STVOR-165	1.000	1.000	6.000	1.430	1.250	0.290	TNMC54...
STVOR-206	1-1/4	1-1/4	7.000	1.620	1.500	0.370	TNMC66...

Metric	H	B	LF	LH	WF	CDX	Insert
STVOR-2525M4	25	25	150	31	31.7	5.8	TNMC43...
STVOR-3232M4	32	32	178	31	38.1	5.8	TNMC43...
STVOR-2525M5	25	25	150	36	31.7	7.3	TNMC54...
STVOR-3232M5	32	32	178	36	38.1	7.3	TNMC54...

SPARE PARTS



Designation	Clamping screw	Clamp (Optional parts)	Clamping screw (Optional parts)	Wrench	
STVOR-**M4	SD2	TC-190	STC-9	T-20TORX	3/32HEX
STVOR-165	SD3	TC-250	STC-11	T-20TORX	1/8HEX
STVOR-**M5	SD4	TC-310	STC-8	-	1/8HEX, 5/32HEX

Multi-clamp internal threading toolholder, for on edge inserts

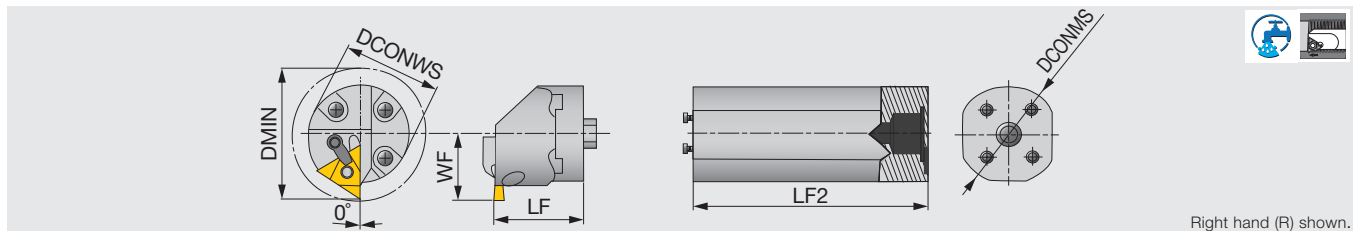

Right hand (R) shown.

Metric	DMIN	DCONWS	WF	LF	Insert
HS40-MTHOR-4	66.7	40	25.9	32	TNM*43...
HS50-MTHOR-4	73	50	35.9	40	TNM*43...
HS40-MTHOR-5	81.3	40	30.6	32	TNM*54...
HS50-MTHOR-5	82.6	50	35.9	40	TNM*54...

SPARE PARTS



Designation	Lock pin	Clamp	Clamping screw	Wrench
HS**-MTHOR-4	NL-44	TC-190	STC-5	3/32HEX
HS**-MTHOR-5	NL-56	TC-250	STC-11	1/8HEX

Shank

Designation	DCONMS	LF2	SPARE PARTS	Clamping screw	Wrench
S-570-40M-40	40	273	S-570-40M-40	SS100	5/32HEX
S-570-50M-50	50	366	S-570-50M-50	SS94	1/4EX

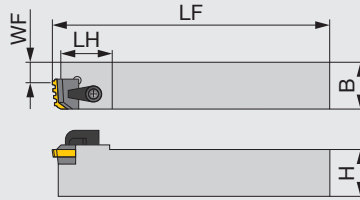

Right hand (R) shown.

Inch	WF	LF	LH	H	B	Insert
CLVOR-208	0.800	7.000	1.250	1-1/4	1-1/4	CR***
Metric	WF	LF	LH	H	B	Insert
CLVOR-25M6	16.1	177	32	25	25	CR***
CLVOR-32M6	16.1	177	32	32	32	CR***
CLVOR-40M8	29.8	179	32	40	40	CR-5B75-4E

SPARE PARTS



Designation	Shim	Shim screw	Clamp	Clamping screw	Wrench	
CLVOR-25M6	TF1207	SF80	TC-311	STC-4	T-25TORX	5/32HEX
CLVOR-32M6	TF1207	SF85	TC-311	STC-4	T-25TORX	5/32HEX
CLVOR-208	TF8132-E	SF60	TC-311	STC-4	T-20TORX	5/32HEX
CLVOR-40M8	TF8132-E	SF60	TC-311	STC-4	T-20TORX	5/32HEX

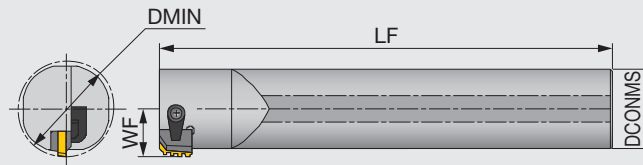

Right hand (R) shown.

Inch	DMIN	DCONMS	WF	LF	Insert
SI-CLHOR-326	2.250	2.000	1.125	14.000	CR-**I
Metric	DMIN	DCONMS	WF	LF	Insert
SI-CLHOR-40M6	50.8	40	23.16	400	CR-**I

SPARE PARTS



Designation	Clamp	Clamping screw	Wrench
SI-CLHOR-40M6	TC-311	STC-8	5/32HEX

External grooving and threading toolholder

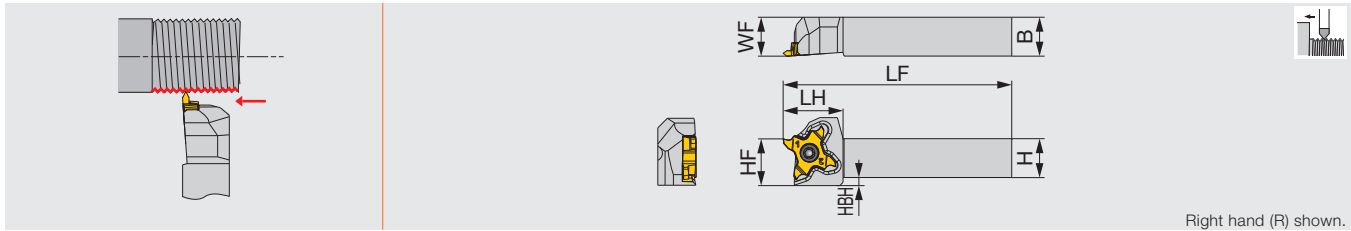

Inch	H	B	LF	LH	HF	WF	HBH	Insert
STCR/L06-18	0.375	0.375	4.750	0.730	0.375	0.375	0.177	TC*18...
STCR/L08-18	0.500	0.500	4.750	0.730	0.500	0.500	0.098	TC*18...
STCR/L10-18	0.625	0.625	4.750	0.730	0.625	0.625	-	TC*18...
STCR/L12-18	0.750	0.750	4.750	0.900	0.750	1.000	-	TC*18...
STCR/L16-18	1.000	1.000	5.500	0.900	1.000	1.250	-	TC*18...

Metric	H	B	LF	LH	HF	WF	HBH	Insert
STCR/L1010X18	10	10	120	18.5	10	10	4.5	TC*18...
STCR/L1212F18	12	12	85	18.5	12	12	2.5	TC*18...
STCR/L1212X18	12	12	120	18.5	12	12	2.5	TC*18...
STCR/L1616X18	16	16	120	18.5	16	16	-	TC*18...
STCR/L2020H18	20	20	100	18.5	20	20	-	TC*18...
STCR/L2020X18	20	20	120	23	20	25	-	TC*18...
STCR/L2525Z18	25	25	135	23	25	30	-	TC*18...

Use right-hand toolholders (R) with right-hand inserts (R); and left-hand toolholders (L) with left-hand inserts (L).

SPARE PARTS

Designation	Clamping screw	Wrench
STCR...	CSTC-4L100DL	T-1008/5
STCL...	CSTC-4L100DR	T-1008/5

TETRAMCUT

STCR/L-18-CHP



External grooving and threading toolholder, with high pressure coolant capability

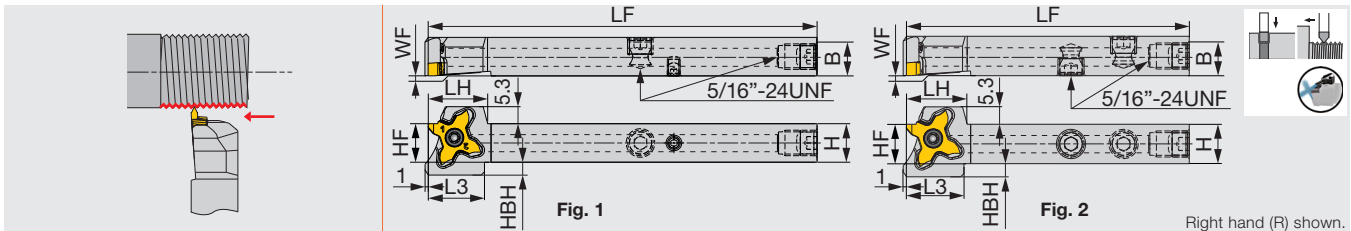

Inch	H	B	LF	LH	L3	HF	WF	HBH	Fig.	Insert	Torque
STCR/L08F18-CHP	0.500	0.500	3.344	0.728	0.689	0.500	0/0.500	0.130	2	TC*18...	0.890
STCR/L08X18-CHP ⁽¹⁾	0.500	0.500	4.750	0.728	0.689	0.500	0/0.500	0.130	1	TC*18...	0.890
STCR/L10X18-CHP ⁽¹⁾	0.625	0.625	4.750	0.728	-	0.625	0/0.625	-	1	TC*18...	0.890
STCR/L12-18-CHP	0.750	0.750	4.750	0.900	-	0.750	-	-	2	TC*18...	0.890
STCR/L16-18-CHP	1.000	1.000	5.500	0.900	-	1.000	-	-	2	TC*18...	0.890

Metric	H	B	LF	LH	L3	HF	WF	HBH	Fig.	Insert	Torque*
STCR/L1212F18-CHP	12	12	85	18.5	17.5	12	0/12	4	2	TC*18...	1.2
STCR/L1212X18-CHP	12	12	120	18.5	17.5	12	0/12	4	1	TC*18...	1.2
STCR/L1616X18-CHP	16	16	120	18.5	-	16	0/16	0	1	TC*18...	1.2

This toolholder can be used with threading and grooving inserts.

Use right-hand toolholders (R) with right-hand inserts (R); and left-hand toolholders (L) with left-hand inserts (L)

Torque: Recommended clamping torque: lbs-ft (*N-m)

SPARE PARTS

Designation	Clamping screw	Wrench
STCL**18-CHP	CSTC-4L100DR	T-1008/5
STCR**18-CHP	CSTC-4L100DL	T-1008/5

Groove width : 0.013" - 0.118"

Pitch : 0.031" - 0.118"

Reference pages: Inserts → **E011**, Standard cutting conditions → **E055**



Threading tool - for external threading with high pressure coolant capability

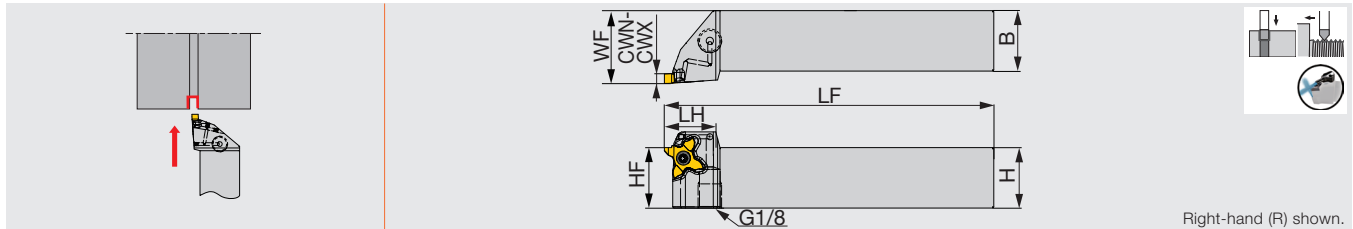

Inch	CWN	CWX	H	B	LF	LH	HBL	HF	WF	HBH	Insert	Torque
STCR/L12-18-CHP	0.013	0.118	0.750	0.750	4.750	0.900	-	0.750	1.000	-	TC*18...	0.890
STCR/L16-18-CHP	0.013	0.118	1.000	1.000	5.500	.900	-	1.000	1.250	-	TC*18...	0.890

Use the right hand insert (TC*18R...) with the right hand toolholders (STCR...). Use the left hand insert (TC*18L) with the left hand holder (STCL...).
Torque: Recommended clamping torque: lbs-ft

SPARE PARTS



Designation	Clamping screw	Wrench
STCL**18-CHP	CSTC-4L100DR	T-1008/5
STCR**18-CHP	CSTC-4L100DL	T-1008/5

TETRAMCUT

JS-STCL18

External grooving and threading toolholder with round shank

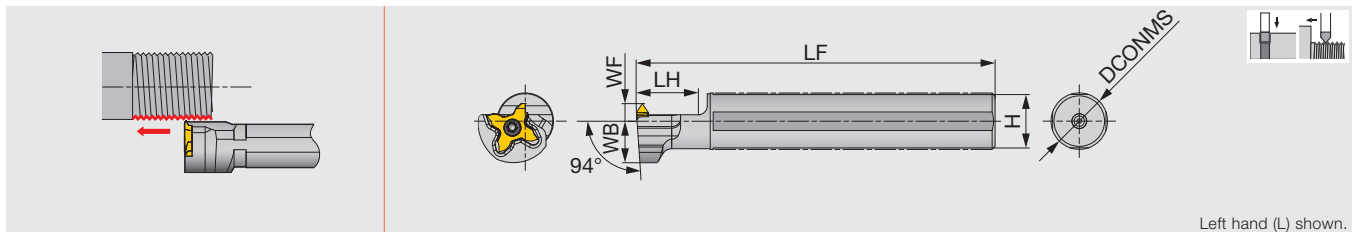

Metric	DCONMS	LF	LH	H	WB	WF	Insert
JS14H-STCL18	14	100	20	13	14	6	TC*18R...
JS159F-STCL18	15.875	85	20	15	14	6	TC*18R...
JS16F-STCL18	16	85	20	15	14	6	TC*18R...
JS19G-STCL18	19.05	90	20	18	14	6	TC*18R...
JS19X-STCL18	19.05	120	20	18	14	6	TC*18R...
JS20G-STCL18	20	90	20	19	14	6	TC*18R...
JS20X-STCL18	20	120	20	19	14	6	TC*18R...
JS22X-STCL18	22	120	20	21	12.25	10	TC*18R...
JS25H-STCL18	25	100	20	24	12.25	10	TC*18R...
JS254X-STCL18	25.4	120	20	24	12.25	10	TC*18R...

Use left-hand toolholders (L) with right-hand inserts (R).

SPARE PARTS



Designation	Clamping screw	Wrench
JS**STCL18	CSTC-4L100DL	T-1008/5

Reference pages: Inserts → **E011**, Standard cutting conditions → **E055**

Threading and parting toolholder, for Swiss lathes

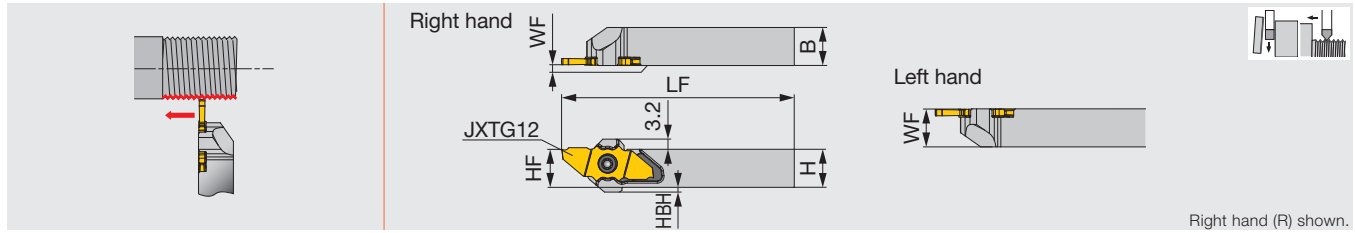

Inch	H	B	WF (R/L)	LF*	HF	HBH	Insert
JSXXR/L063	0.375	0.375	0.008 / 0.386	4.646	0.375	0.12	JX...
JSXXR/L083	0.500	0.500	0.008 / 0.386	3.268	0.500	0.06	JX...
JSXXR/L103	0.625	0.625	0.008 / 0.386	4.646	0.625	0.06	JX...

Metric	H	B	WF (R/L)	LF*	HF	HBH	Insert
JSXXR/L1010X09	10	10	0.2 / 9.8	118	10	3	JX...
JSXXR/L1212F09	12	12	0.2 / 9.8	83	12	1.5	JX...
JSXXR/L1212X09	12	12	0.2 / 9.8	118	12	1.5	JX...
JSXXR/L1616X09	16	16	0.2 / 9.8	118	16	0	JX...
JSXXR/L2020H09	20	20	0.2 / 9.8	98	20	0	JX...

*This toolholder can be used with threading and grooving inserts. With parting inserts, the dimension of LF will be different depending on the insert shape. Use right-hand toolholders (R) with right-hand inserts (R); and left-hand toolholders (L) with left-hand inserts (L)

SPARE PARTS



Designation	Clamping screw	Wrench
JSXXR****	CSTC-4L100DL	T-1008/5
JSXXL****	CSTC-4L100DR	T-1008/5

Parting toolholder, for Swiss lathes (for sub spindle)

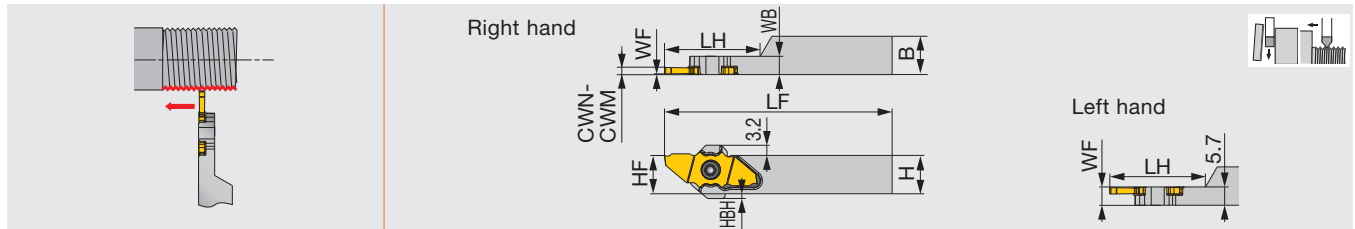

Inch	CWN	CWM	H	B	LF**	LH**	HF	WF	HBH	Insert	Torque
JSXXR/L063-S	0.039	0.079	0.375	0.375	4.750	1.030	0.383	0.008/0.217	0.120	JX*G06...,12...,16..., 20...	0.89
JSXXR/L083-S	0.039	0.079	0.500	0.500	4.750	1.030	0.500	0.008/0.217	0.060	JX*G06...,12...,16..., 20...	0.89

Metric	CWN	CWM	H	B	LF**	LH**	HF	WF	HBH	Insert	Torque*
JSXXR/L1010X09-S	1	2	10	10	120	26	10	0.2/5.5	3	JX*G06...,12...,16...	1.2
JSXXR/L1212F09-S	1	2	12	12	85	26	12	0.2/5.5	1.5	JX*G06...,12...,16...	1.2
JSXXR/L1212X09-S	1	2	12	12	120	30	12	0.2/5.5	1.5	JX*G06...,12...,16...	1.2
JSXXR/L1616X09-S	1	2	16	16	120	30	16	0.2/5.5	-	JX*G06...,12...,16...,20...	1.2

**LF (Functional Length) and LH (Head Length) values shown above are true with JXPG16... insert. LF and LH will be 0.079" shorter than the above values with JX*G12... insert, and 0.157" shorter for JXPG06... insert. LF, LH, and HBL will all be 0.079" shorter with JXPG20... insert. JXPG20... insert will not fit.

Use the right-hand insert (JX*G**R...) for a right-hand holder (JSXXR...); the left-hand insert (JX*G**L...) for a left-hand holder (JSXXL...).

Torque: Recommended clamping torque: lbs-ft (*N-m)

SPARE PARTS



Designation	Clamping screw	Wrench
JSXXR***-S	CSTC-4L055DL	T-1008/5
JSXXL***-S	CSTC-4L055DR	T-1008/5

Reference pages: Inserts → **E011**, Standard cutting conditions → **E055**



Parting and threading toolholder, with high pressure coolant capability

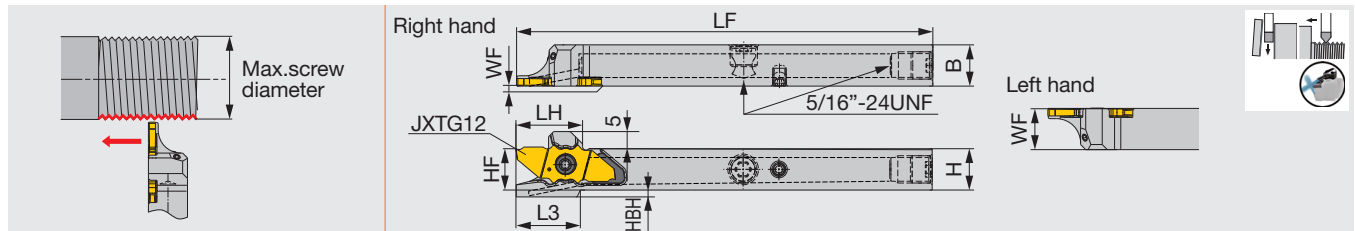

Inch	H	B	WF (R/L)	LF*	HF	HBH	LH*	L3	Insert
JSXXR/L083X-CHP	0.500	0.500	0.008/0.492	4.750	0.500	0.051	≤ 0.764	0.740	JX**06...,12...,16...
JSXXR/L103X-CHP	0.625	0.625	0.008/0.617	4.750	0.625	0	≤ 0.764	0.736	JX**06...,12...,16...
Metric	H	B	WF (R/L)	LF*	HF	HBH	LH*	L3	Insert
JSXXR/L1212X09-CHP	12	12	0.2/11.8	118	12	2	≤ 19.4	18.8	JX**06...,12...,16...
JSXXR/L1616X09-CHP***	16	16	0.2/15.8	118	16	2.5	≤ 19.4	18.7	JX**06...,12...,16...
JSXXR/L1616X09B-CHP	16	16	0.2/15.8	118	16	-	≤ 19.4	-	JX**06...,12...,16...

*This toolholder can be used with threading and grooving inserts. With parting inserts, the dimensions of LF and LH will be different depending on the insert shape.

***To be replaced with the new design

Use right-hand toolholders (R) with right-hand inserts (R); and left-hand toolholders (L) with left-hand inserts (L)

SPARE PARTS

Designation	Clamping screw	Wrench
JSXXR...	CSTC-4L100DL	T-1008/5
JSXXL...	CSTC-4L100DR	T-1008/5

Parting-off widths : 0.039" and 0.059" (for a max parting diameter of ø0.236")
: 0.059" and 0.079" (for max parting diameters of ø0.472", ø0.630" and ø0.787")

Parting-off tool for swiss lathes

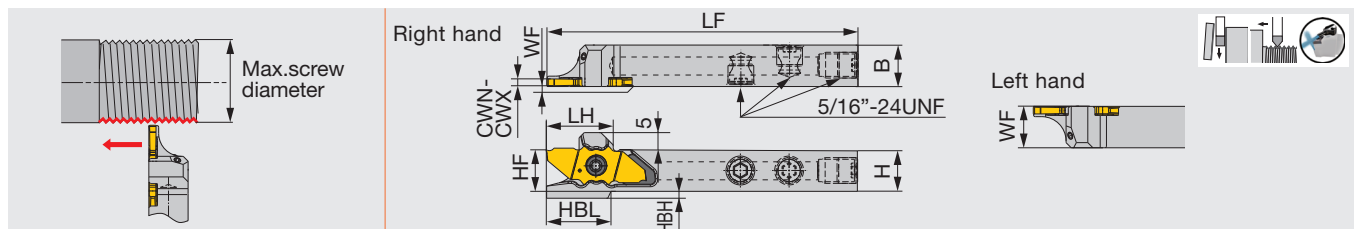

Inch	CWN	CWX	H	B	LF**	LH**	HF	WF	HLB**	HBH	Insert	Torque
JSXXR/L083F-CHP	0.039	0.079	0.500	0.500	3.344	≤ 0.764	0.5	0.008/0.492	0.736	0.051	JX*G06...,12...,16..., 20...	0.890
Metric	CWN	CWX	H	B	LF**	LH**	HF	WF	HLB**	HBH	Insert	Torque*
JSXXR/L1212F09-CHP	1	2	12	12	85	≤ 19.4	12	0.2/11.8	-	2	JX*G06...,12...,16..., 20...	1.2

**LF (Functional Length) LH (Head Length), and HBL (Head-bottom Offset Length) values shown above are true with JXPG16... insert. LF, LH, and HBL will all be 0.079" shorter than the above values with JX*G12... and JXPG20... inserts, and 0.157" shorter for JXPG06... insert.

Use the right-hand insert (JX*G**R...) for a right-hand holder (JSXXR...); the left-hand insert (JX*G**L...) for a left-hand holder (JSXXL...).

Torque: Recommended clamping torque: lb-ft (*N-m)

SPARE PARTS

Designation	Clamping screw	Wrench	Coolant plug	Wrench
JSXXR...	CSTC-4L100DL	T-1008/5	SR5/16UNFTL360	P-4
JSXXL...	CSTC-4L100DR	T-1008/5	SR5/16UNFTL360	P-4

Parting-off widths:
0.039" and 0.059" (for a max parting diameter of ø0.236")
0.059" and 0.079" (for max parting diameters of ø0.472", ø0.630" and ø0.787")

Range of threads machined pitch

Insert designation	Pitch (in)	Max.screw diameter
JXTG12FR/L-60A-000	0.008 - 0.016	Metric: M26, Unified: 1"
JXTG12FR/L-60B-000	0.008 - 0.016	Metric: M26, Unified: 1"
JXTG12FR/L-60A-005	0.016 - 0.039	Metric: M24, Unified: 15/16"
JXTG12FR/L-60B-005	0.016 - 0.039	Metric: M24, Unified: 15/16"
JXTG12FR/L-60N-010	0.039 - 0.059	Metric: M22, Unified: 7/8"

Reference pages: Inserts → **E011**, Standard cutting conditions → **E055**

Parting-off tool for sub spindle in swiss lathes with high pressure coolant capability

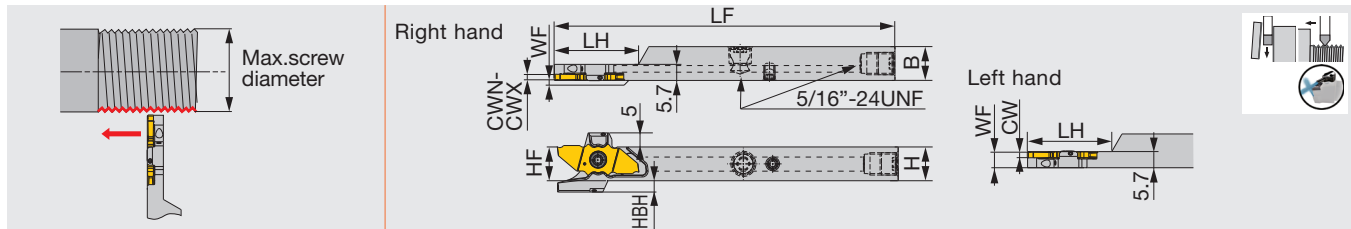

Inch	CWN	CWX	H	B	LF**	LH**	HF	WF	HBH	Insert	Torque
JSXXR/L083X-S-CHP	0.039	0.079	0.500	0.500	4.750	1.181	0.500	0.008/0.217	0.051	JX*G06...,12...,16..., 20...	0.890
JSXXR/L103X-S-CHP	0.039	0.079	0.625	0.625	4.750	1.181	0.625	0.008/0.217	0	JX*G06...,12...,16..., 20...	0.890
Metric	CWN	CWX	H	B	LF**	LH**	HF	WF	HBH	Insert	Torque*
JSXXR/L1212X09-S-CHP***	1	2	12	12	120	30	12	0.2/5.5	4	JX*G06...,12...,16..., 20...	1.2
JSXXR/L1212X09B-S-CHP	1	2	12	12	120	30	12	0.2/5.5	2	JX*G06...,12...,16..., 20...	1.2
JSXXR/L1616X09-S-CHP***	1	2	16	16	120	30	16	0.2/5.5	1.5	JX*G06...,12...,16..., 20...	1.2
JSXXR/L1616X09B-S-CHP	1	2	16	16	120	30	16	0.2/5.5	-	JX*G06...,12...,16..., 20...	1.2

**LF (Overall Tool Length) and LH (Head Length) values shown above are true with JXPG16... insert. Both LF and LH will be 0.079" shorter than the above value with JX*G12... and JXPG20... inserts; 0.157" shorter with JXPG06... insert.

***To be replaced with the new design

Use the right-hand insert (JX*G**R...) for a right-hand holder (JSXXR...); the left-hand insert (JX*G**L...) for a left-hand holder (JSXXL...).

Torque: Recommended clamping torque: lbs-ft (*N·m)

SPARE PARTS

Designation	Clamping screw	Wrench	Coolant plug	Wrench	DirectJet plug	Wrench
JSXXR***-S-CHP	CSTC-4L055DL	T-1008/5	SR5/16UNFTL360	P-4	SSHM4-6-TB	P-2
JSXXL***-S-CHP	CSTC-4L055DR	T-1008/5	SR5/16UNFTL360	P-4	SSHM4-6-TB	P-2

Parting-off widths : 0.039" and 0.059" (for a max parting diameter of ø0.236")
: 0.059" and 0.079" (for max parting diameters of ø0.472", ø0.630" and ø0.787")

Parting-off tool for sub spindle in swiss lathes

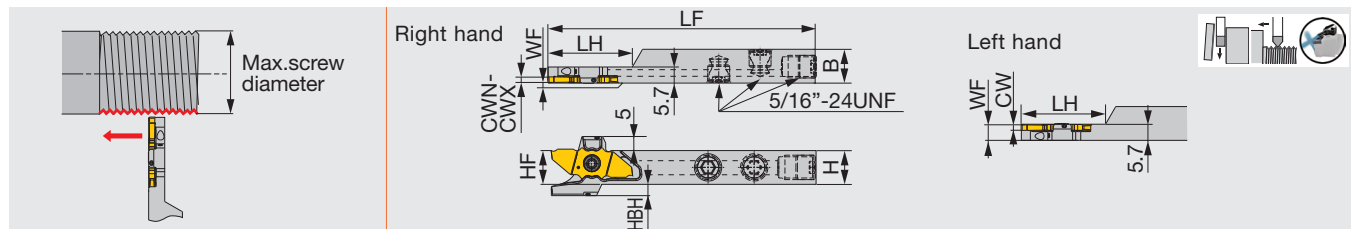

Inch	CWN	CWX	H	B	LF**	LH**	HF	WF	HBH	Insert	Torque
JSXXR/L083F-S-CHP	0.039	0.079	0.500	0.500	3.344	1.024	0.500	0.008/0.217	0.051	JX*G06...,12...,16..., 20...	0.890
Metric	CWN	CWX	H	B	LF**	LH**	HF	WF	HBH	Insert	Torque*
JSXXR/L1212F09-S-CHP***	1	2	12	12	85	26	12	0.2/5.5	4	JX*G06...,12...,16..., 20...	1.2
JSXXR/L1212F09B-S-CHP	1	2	12	12	85	30	12	0.2/5.5	2	JX*G06...,12...,16..., 20...	1.2

**LF (Overall Tool Length) and LH (Head Length) values shown above are true with JXPG16... insert. Both LF and LH will be 0.079" shorter than the above value with JX*G12... and JXPG20... inserts; 0.157" shorter with JXPG06... insert.

***To be replaced with the new design

Use the right-hand insert (JX*G**R...) for a right-hand holder (JSXXR...); the left-hand insert (JX*G**L...) for a left-hand holder (JSXXL...).

Torque: Recommended clamping torque: lb-ft (*N·m)

SPARE PARTS

Designation	Clamping screw	Wrench
JSXXR/L083F-S-CHP	CSTC-4L055DL	T-1008/5

Parting-off widths : 0.039" and 0.059" (for a max parting diameter of ø0.236")
: 0.059" and 0.079" (for max parting diameters of ø0.472", ø0.630" and ø0.787")

Range of threads machined pitch

Insert designation	Pitch (in)	Max. screw diameter
JXTG12FR/L-60A-000	0.008 - 0.016	Metric: M26, Unified: 1"
JXTG12FR/L-60B-000	0.008 - 0.016	Metric: M26, Unified: 1"
JXTG12FR/L-60A-005	0.016 - 0.039	Metric: M24, Unified: 15/16"
JXTG12FR/L-60B-005	0.016 - 0.039	Metric: M24, Unified: 15/16"
JXTG12FR/L-60N-010	0.039 - 0.059	Metric: M22, Unified: 7/8"

Reference pages: Inserts → **E011**, Standard cutting conditions → **E055**

Grade
Insert
Toolholder
Ext. Toolholder
Int. Toolholder
Threading
Grooving
Miniature Tool
Milling Cutter
Endmill
Drilling Tool
Tooling System
User's Guide
Index

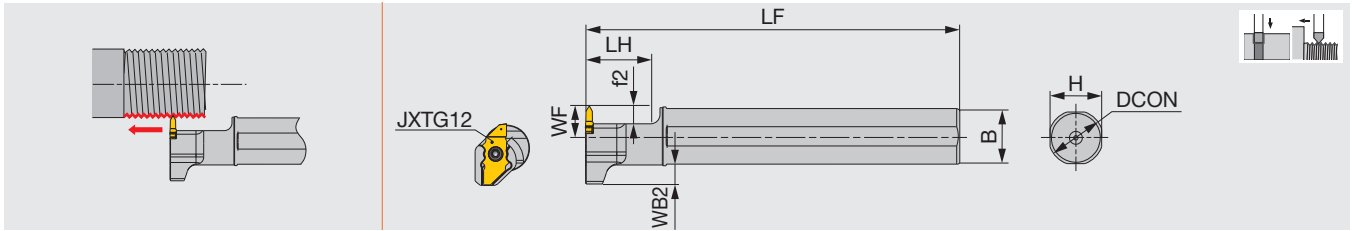

Metric	DCON	H	B	WB2	LF	LH	WF**	f2**	Insert
JS19G-SXXL09	19.05	18	18	5.9	90	21	10	6	JX*G06,12*R
JS19X-SXXL09	19.05	18	18	5.9	120	21	10	6	JX*G06,12*R
JS20G-SXXL09	20	19	19	5.4	90	21	10	6	JX*G06,12*R
JS20X-SXXL09	20	19	19	5.4	120	21	10	6	JX*G06,12*R
JS22X-SXXL09	22	21	21	4.4	120	21	10	6	JX*G06,12*R
JS25H-SXXL09	25	24	24	2.9	100	21	10	6	JX*G06,12*R
JS254X-SXXL09	25.4	24	24	2.7	120	21	10	6	JX*G06,12*R

This toolholder can be used with threading and parting inserts.

** When using JX..06... insert, both WF and f2 sizes will be 2 mm shorter than the values provided above.

SPARE PARTS



Designation	Clamping screw	Wrench
JS***-SXXL09	CSTC-4L055L	T-1008/5

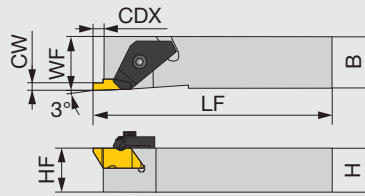

Right hand (R) shown.

Inch	CW	CDX	HF	H	B	LF	WF	Insert	Torque
FLASR/L-082B	0.031 - 0.125	0.138	1/2	1/2	1/2	6.000	0.500	FL*-3**R/L...	2.21
FLASR-102B	0.031 - 0.125	0.138	5/8	5/8	5/8	4-1/2	0.625	FL*-3**R...	2.21
FLASR/L-103B	0.031 - 0.250	0.210	0.625	0.625	0.625	4.500	0.625	FL*-3**R/L...	2.21
Metric	CW	CDX	HF	H	B	LF	WF	Insert	Torque*
FLASR/L-1212M2	1 - 3.25	3.51	12	12	12	150	12	FL*-2**R/L...	3
FLASR/L-1616M2	1 - 3.25	5.31	16	16	16	125	16	FL*-3**R/L...	3
FLASR/L-1616M3	1 - 4	5.31	16	16	16	125	16	FL*-3**R/L...	3

Use right-hand toolholders (R) with right-hand inserts (R); and left-hand toolholders (L) with left-hand inserts (L)
Torque: Recommended clamping torque: lbs-ft (*N·m)

Inch

SPARE PARTS

Designation	Clamp	Clamping screw	Wrench
FLASR-102B, FLASR-103B	TF-184	S-412	5/32HEX
FLASL-103B	TF-185	S-412	5/32HEX

Metric

SPARE PARTS

Designation	Clamp	Clamping screw	Wrench
FLASR-1212M2	TF-182	S-310	7/64HEX
FLASL-1212M2	TF-183	S-310	7/64HEX
FLASR-1616M2, FLASR-1616M3	TF-184	S-412	5/32HEX
FLASL-1616M2, FLASL-1616M3	TF-185	S-412	5/32HEX

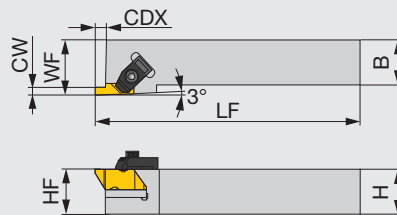

Right hand (R) shown.

Inch	CW	CDX	HF	H	B	LF	WF	Insert	Torque
FLSR/L-122B	0.031 - 0.128	0.140	0.750	0.750	0.750	4.500	1.000	FL*-3**R/L...	2.21
FLSR/L-162C	0.031 - 0.128	0.140	1.000	1.000	1.000	5.000	1.250	FL*-3**R/L...	2.21
FLSR/L-123B	0.031 - 0.250	0.210	0.750	0.750	0.750	4.500	1.000	FL*-3**R/L...	2.21
FLSR/L-163C	0.031 - 0.250	0.210	1.000	1.000	1.000	5.000	1.250	FL*-3**R/L...	2.21
FLSR/L-164D	0.125 - 0.312	0.210	1.000	1.000	1.000	6.000	1.250	FL*-3**R/L...	2.21
FLSR/L-203D	0.031 - 0.250	0.290	1.250	1.250	1.250	6.000	1.500	FL*-4**R/L...	2.21
FLSR/L-204D	0.125 - 0.312	0.290	1.250	1.250	1.250	6.000	1.500	FL*-4**R/L...	2.21
FLSR/L-206D	0.281 - 0.375	0.290	1.250	1.250	1.250	6.000	1.500	FL*-4**R/L...	2.21
FLSR/L-82V	0.031 - 0.128	0.140	0.750	1/2	1/2	3-1/2	0.750	FL*-4**R/L...	2.21
Metric	CW	CDX	HF	H	B	LF	WF	Insert	Torque*
FLSR/L-2020M3	1 - 3	4.5	20	20	20	125	32	FL*-3**R/L...	3
FLSR/L-2525M3	1 - 3	4.5	25	25	25	150	32	FL*-3**R/L...	3

Use right-hand toolholders (R) with right-hand inserts (R); and left-hand toolholders (L) with left-hand inserts (L)
Torque: Recommended clamping torque: lbs-ft (*N·m)

Inch

SPARE PARTS

Designation	Clamp	Clamping screw	Wrench
FLSR-122B, FLSR-162C, FLSR-82V	TF-74	S-310	7/64HEX
FLSL-122B, FLSL-162C, FLSL-82V	TF-75	S-310	7/64HEX
FLSR-123B, FLSR-163C, FLSR-164D, FLSR-204D	TF-72	S-412	5/32HEX
FLSL-123B, FLSL-163C, FLSR-203D	TF-73	S-412	5/32HEX

Metric

SPARE PARTS

Designation	Clamp	Clamping screw	Wrench
FLSR-***M3	TF-72	S-412	5/32HEX
FLSL-***M3	TF-73	S-412	5/32HEX

TUNGST-CLAMP

A_M-FLER/L

Internal grooving and threading toolholder

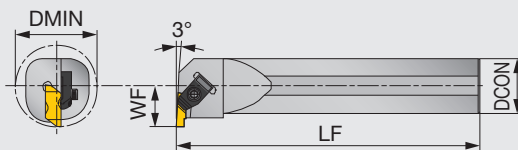

Right hand (R) shown.

Inch	Pitch	DMIN	DCON	LF	WF	Insert
A08-FLER/L2	0.031 - 0.125	0.730	0.500	8.000	0.437	FL*-2**/R...
A10-FLER2	0.031 - 0.125	1.000	0.625	10.000	0.500	FL*-2**L...
A12-FLER/L2	0.031 - 0.128	1.125	0.750	10.000	0.562	FL*-2**/R...
A16-FLER/L2	0.031 - 0.128	1.375	1.000	12.000	0.688	FL*-2**/R...
A16-FLER/L3	0.031 - 0.250	1.375	1.000	12.000	0.688	FL*-3**/R...

Metric	Pitch	DMIN	DCON	LF	WF	Insert
A25M-FLER/L3	2.11 - 5.08	34.9	25	300	17.7	FL*-3**/R...
A32M-FLER/L3	2.11 - 5.08	44.5	32	350	22.1	FL*-3**/R...
A40M-FLER3	2.11 - 5.08	50.8	40	350	24.5	FL*-3**L...

Inch SPARE PARTS



Designation	Clamp	Clamping screw	Wrench
A08-FLER2	TF-146	S-310	7/64HEX
A08-FLEL2	TF-147	S-310	7/64HEX
A10-FLER2, A12-FLER2, A16-FLER2	TF-75	S-310	7/64HEX
A12-FLEL2, A16-FLEL2	TF-74	S-310	7/64HEX
A16-FLER3	TF-73	S-412	5/32HEX
A16-FLEL3	TF-72	S-412	5/32HEX

Metric SPARE PARTS



Designation	Clamp	Clamping screw	Wrench
A**M-FLER3	TF-73	S-412	5/32HEX
A**M-FLEL3	TF-72	S-412	5/32HEX

TUNGST-CLAMP

HS-FLER/L

Head exchangeable internal grooving and threading toolholder

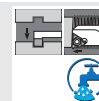
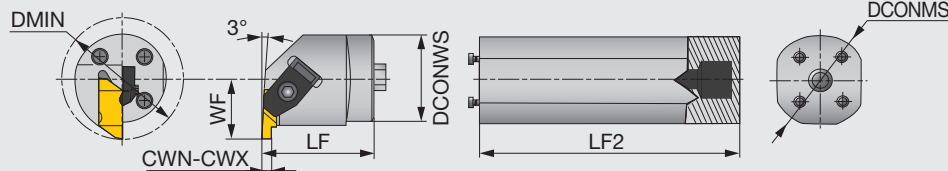

Right hand (R) shown.

Metric	CWN	CWX	DMIN	DCONWS	LF	WF	Insert	Torque
HS40-FLER3W	1	3	56.1	40	40.1	28	FL*-3**L...	3
HS50-FLER3W	1	3	70.1	50	41.9	35	FL*-3**L...	3

Use right-hand toolholders (R) with left-hand inserts (L); and left-hand toolholders (L) with right-hand inserts (R).
Torque: Recommended clamping torque: N·m

SPARE PARTS



Designation	Clamp	Clamping screw	Wrench
HS40-FLER3W	TF-73	S-412	5/32HEX
HS50-FLER3W	TF-73	S-412	5/32HEX

Shank

Inch	DCONMS	LF2
S-570-32-50	2.000	14.410

Metric	DCONMS	LF2
S-570-40M-40	40	273
S-570-50M-50	50	366

SPARE PARTS



Designation	Clamping screw	Wrench
S-570-40M-40	SS100	5/32HEX
S-570-50M-50	SS94	1/4EX

Reference pages: Inserts → E012, Standard cutting conditions → E055

J-SERIES

JSTTR/L

External toolholder for Swiss lathes

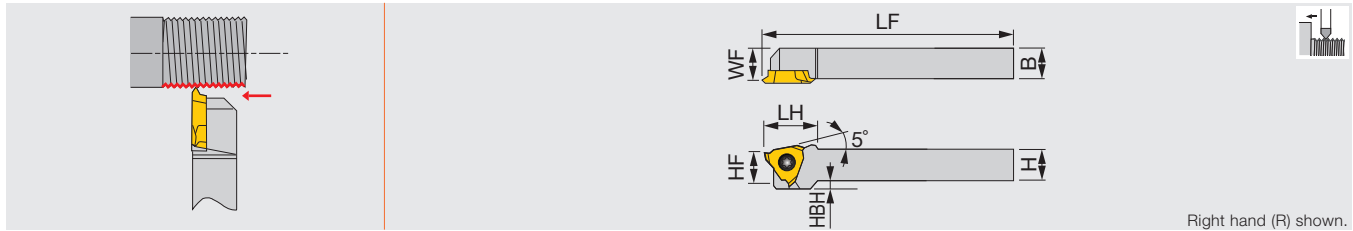

Inch	H	B	LF	LH	HF	WF	HBH	Insert
JSTTR/L063	0.375	0.375	5.000	0.6875	0.375	0.375	0.100	JTTR/L30...
JSTTR/L083	0.500	0.500	5.000	0.6875	0.500	0.500	-	JTTR/L30...
JSTTR/L103	0.625	0.625	5.000	0.6875	0.625	0.625	-	JTTR/L30...

Metric	H	B	LF	LH	HF	WF	HBH	Insert
JSTTR/L1010X3	10	10	120	18.5	10	9.5	2	JTTR/L30...
JSTTR/L1212F3	12	12	85	18.5	12	11.5	-	JTTR/L30...
JSTTR/L1212X3	12	12	120	18.5	12	11.5	-	JTTR/L30...
JSTTR/L1616X3	16	16	120	16.5	16	15.5	-	JTTR/L30...

Recommended clamping torque: 0.89 lbs-ft (1.2 N-m)

SPARE PARTS

Designation	Clamping screw	Wrench
JSTTR/L...	CSTB-4SD	T-8F

J-SERIES

JS-TTL3

External toolholder for Swiss lathes

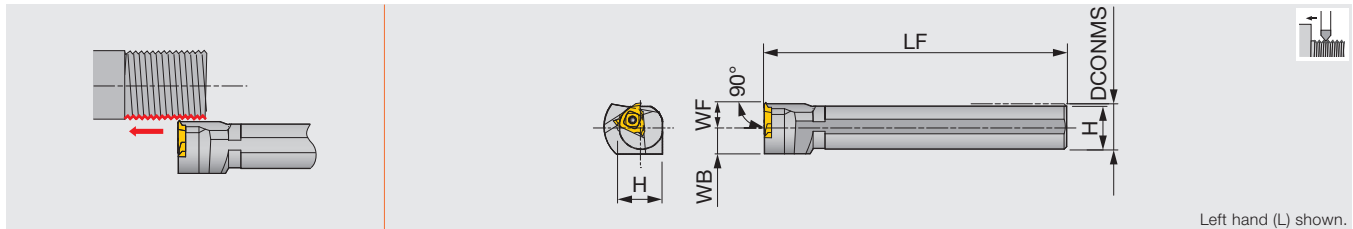

Metric	DCONMS	WF	LF	H	WB	Insert
JS19K-TTL3	19.05	10	125	18	11.5	JTTR30...
JS20K-TTL3	20	10	125	19	11.5	JTTR30...
JS22K-TTL3	22	10	125	21	11.5	JTTR30...
JS25K-TTL3	25.4	10	125	24	12.7	JTTR30...

Recommended clamping torque: 3.5 N-m

SPARE PARTS

Designation	Clamping screw	Wrench
JS*-TTL3	CSTB-4S	T-15F

Reference pages: Inserts → [E012 - E013](#)

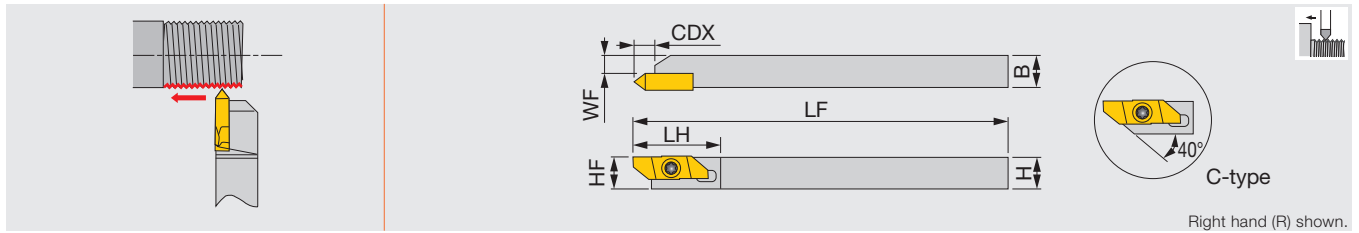

Right hand (R) shown.

Metric	H	B	LF	LH	CDX	HF	WF	Insert
JSXBR1010K8-C	10	10	125	29	6.4	10	5.7	JXT*R...
JSXBR1212K8-C	12	12	125	29	6.4	12	7.7	JXT*R...
JSXBR1616K8	16	16	125	29	6.4	16	11.7	JXT*R...
JSXBR2020K8	20	20	125	29	6.4	20	15.7	JXT*R...
JSXBR2525K8	25	25	125	29	6.4	25	20.7	JXT*R...

Can be wrenched also from the back with a double-head screw.
This toolholder can be used for JXB back-turning insert and JXT threading insert.

SPARE PARTS



Designation	Clamping screw	Wrench 1	Wrench 2 (Optional parts)
JSXBR...	CSTB-4SD	T-8F	(T-8L)

TINYM^{INI}TURN

TinyMini-Turn JBIR

Solid boring bar for internal threading

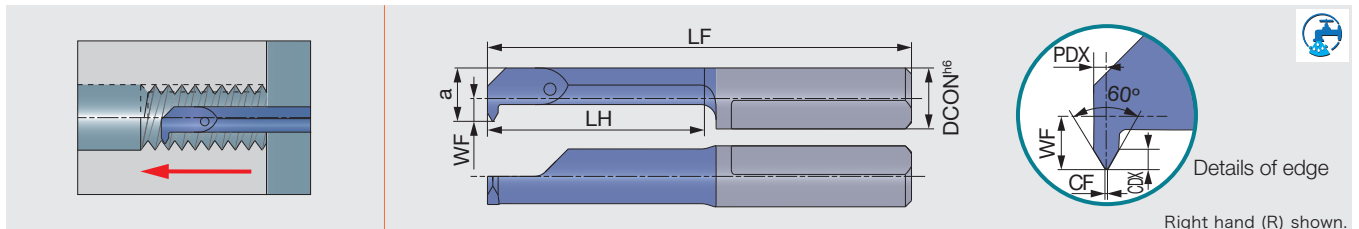

Right hand (R) shown.

Metric	Grade SH730	Pitch	DMIN	CF-0.02	DCON	WF	a	LF	LH	CDX	PDX
JBIR04140050-D040	●	0.8 - 0.5	4	0.06	4	1.5	3.5	30	14	0.3	0.35
JBIR07140050-D050	●	1.0 - 0.5	5	0.06	7	0.9	4.4	30	14	0.3	0.35
JBIR07140075-D050	●	1.0 - 0.75	5	0.09	7	0.9	4.4	30	14	0.4	0.45
JBIR07140100-D048	●	1.0	4.8	0.12	7	0.9	4.4	30	14	0.6	0.55
JBIR07140100-D060	●	1.5 - 1.0	6	0.12	7	1.8	5.3	30	14	0.6	0.55
JBIR07140125-D060	●	1.5 - 1.25	6	0.15	7	1.8	5.3	30	14	0.7	0.65
JBIR07140150-D060	●	1.5	6	0.18	7	1.8	5.3	30	14	0.8	0.75
JBIR07140150-D070	●	1.5 - 1.0	7	0.18	7	2.8	6.3	30	14	0.8	0.75

● : Line up

Reference pages: JSXBR/L: Inserts → **E012 - E013**
Standard cuttings → **E056**

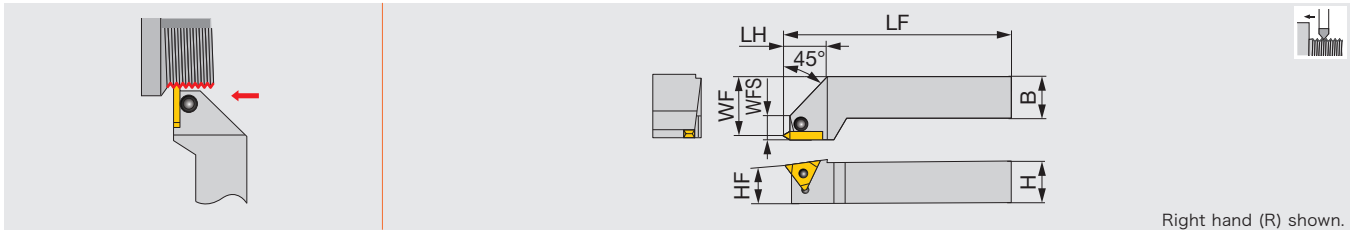

Right hand (R) shown.

Metric	H	B	LF	LH	HF	WF	WFS	Insert
TT-2525R/LE	25	25	150	25	25	32	15	TTR/L42...

SPARE PARTS

Designation	Clamp	Right-left screw	Wrench
TT-2525R/LE	CP91	DS-6	P-3

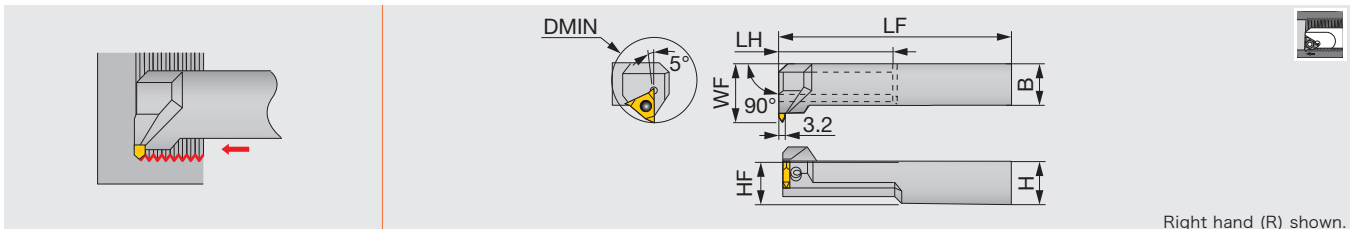

Right hand (R) shown.

Metric	DMIN	H	B	LF	LH	HF	WF	Insert
TT-2525RI	50	25	25	200	70	25	35	TTL42...

Use left-hand toolholders (L) with right-hand inserts (R).

SPARE PARTS

Designation	Clamp	Right-left screw	Wrench
TT-2525RI	CP91	DS-6	P-3

Reference pages: TungThread : Inserts → **E013, E015**
Standard cuttings → **E054**

Technical Guide

- Relationship between pitch, depth of cut and number of passes for external metric threading

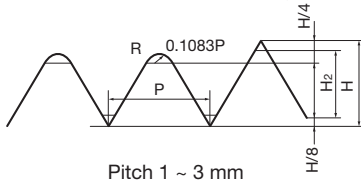

Note: Maximum machinable pitch is 3 mm.

Part assembly

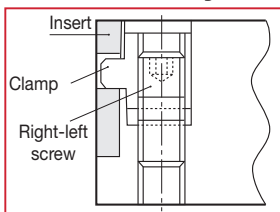

Number of passes	P	1	1.25	1.5	1.75	2	2.5	3
	H ₂	0.6	0.76	0.92	1.09	1.25	1.57	1.9
	H	0.866	1.083	1.299	1.516	1.732	2.165	2.598
1		0.25	0.3	0.3	0.3	0.35	0.4	0.4
2		0.15	0.2	0.25	0.25	0.25	0.3	0.35
3		0.1	0.1	0.15	0.2	0.2	0.25	0.28
4		0.05	0.06	0.1	0.1	0.16	0.2	0.2
5		0.05	0.06	0.05	0.1	0.1	0.15	0.2
6			0.06	0.05	0.07	0.07	0.1	0.13
7				0.02	0.05	0.05	0.07	0.1
8					0.02	0.02	0.05	0.1
9						0.02	0.03	0.05
10							0.02	0.05
11								0.02
12								0.02

Technical Guide

Designation system for TT-type insert

Insert

TT	R	42	M	-005
	①	②	③	④
	① Hand	② Insert size (mm)	③ Thread type	④ Corner radius (mm)
	R Right L Left	Inscribed circle 12.7 Thickness 3.2	M 60° thread angle W 55° thread angle	Blank 0 -005 0.05

Toolholder

TT-	20	20	R	E
	①	②	③	④
	① Shank height (mm)	② Shank width (mm)	③ Hand	④ External or Internal
			R Right L Left	E External I Internal

Designation system for ST-type insert

16	I	R	175	ISO	- B
①	②	③	④	⑤	⑥
① Insert size	② External or Internal	③ Hand of cut	④ Thread type	⑤ Thread type	⑥ Chipbreaker
Symbol I. C. dia (mm)	E External I Internal	R Right hand L Left hand	Partial-profile inserts	Partial-profile inserts	B With (Basic selection) M With CB With - Without
6 - 11 6.35 16 9.525 22 12.7 27 15.875			A Pitch: 0.5 ~ 1.5 mm TPI: 48 ~ 16 AG Pitch: 0.5 ~ 3 mm TPI: 48 ~ 8 G Pitch: 1.75 ~ 3 mm TPI: 14 ~ 8 N Pitch: 3.5 ~ 5 mm TPI: 7 ~ 5 Z Pitch: 4 ~ 6 mm TPI: 6 ~ 4	60° 60° thread angle 55° 55° thread angle TR 30° trapezoidal ACME 29° trapezoidal	
			Full-profile inserts	Full-profile inserts	
			Pitch (mm)×10 or 100 TPI (Thread Per Inch) (Examples) 05: 0.5 mm pitch×10 175: 1.75 mm pitch×100 14: 14 TPI	ISO Metric UN Unified W Whitworth PT Taper pipe NPT National taper pipe NPTF National taper pipe RAPI API round RD API round BAPI API buttress RD Round (DIN405) UNJ UNJ MJ	

Note: Please identify new designation system for internal inserts. -i.e. "N" "I"

(Example) Conventional: 16NR15ISO
New: 16IR15ISO

TUNGTHREAD

STANDARD CUTTING CONDITIONS

ISO	Workpiece material	Hardness	Cutting speed: Vc (sfm)			
			AH725	T313V	NS9530	TH10
P	Carbon steel	< 200HB	262 - 591	328 - 656	492 - 656	-
		> 200HB	197 - 525	328 - 492	656 - 558	-
M	Stainless steel	-	164 - 427	230 - 427	-	-
K	Cast iron	-	-	230 - 492	-	70 - 90
N	Non-ferrous metals	-	-	-	-	100 - 500
S	Heat-resistant alloys	-	-	-	-	10 - 40
H	Hard materials	50 ~ 60HRC	-	-	-	10 - 30

TUNG T-CLAMP STANDARD CUTTING CONDITIONS

ISO	Workpiece material	Grade	Application	Cutting speed Vc (sfm)	Pitch (in)	Threads per inch (TPI)
P	High carbon steel 1045, etc.	AH725	Threading	262 - 591	Internal 0.083 - 0.200 External 0.050 - 0.167	Internal 5 - 12 External 6 - 20
	Alloy steel 4140, etc.	AH725	Threading	197 - 525	Internal 0.083 - 0.200 External 0.050 - 0.167	Internal 5 - 12 External 6 - 20
M	Stainless steel S30400, etc.	AH725	Threading	164 - 427	Internal 0.083 - 0.200 External 0.050 - 0.167	Internal 5 - 12 External 6 - 20

TETRAMINI CUT STANDARD CUTTING CONDITIONS

TCT18R/L / TCT18FR

ISO	Workpiece material	Priority	Grade	Cutting speed Vc (sfm)	Pitch (in)	Threads per inch (TPI)
P	Low carbon steel 1015, etc.	First choice	SH725	197 - 492	0.016 - 0.079	64 - 12
		Fracture resistance	AH725	197 - 492	0.031 - 0.118	32 - 8
	Carbon steel, Alloy steel 1055, etc.	First choice	SH725	197 - 492	0.016 - 0.079	64 - 12
		Fracture resistance	AH725	197 - 492	0.031 - 0.118	32 - 8
M	Prehardened steel NAK80, PX5, etc.	First choice	SH725	197 - 492	0.016 - 0.079	64 - 12
		Fracture resistance	AH725	197 - 492	0.031 - 0.118	32 - 8
K	Stainless steel S30400, etc.	First choice	SH725	164 - 262	0.016 - 0.079	64 - 12
		Fracture resistance	AH725	164 - 262	0.031 - 0.118	32 - 8
S	Gray cast iron No.250B, No.300B, etc.	First choice	AH725	164 - 328	0.031 - 0.118	32 - 8
		Sharpness	SH725	164 - 328	0.016 - 0.079	64 - 12
	Ductile cast iron 60-40-18, 80-55-06, etc.	First choice	AH725	164 - 328	0.031 - 0.118	32 - 8
		Sharpness	SH725	164 - 328	0.016 - 0.079	64 - 12
S	Titanium alloys Ti-6Al-4V, etc.	First choice	SH725	98 - 328	0.016 - 0.079	64 - 12
		Fracture resistance	AH725	98 - 328	0.031 - 0.118	32 - 8
	Heat-resistant alloys Inconel718, etc.	First choice	SH725	98 - 328	0.016 - 0.079	64 - 12
		Fracture resistance	AH725	98 - 328	0.031 - 0.118	32 - 8

DUOJUST CUT STANDARD CUTTING CONDITIONS

ISO	Workpiece material	Grade	Cutting speed Vc (sfm)	Pitch (in)	Threads per inch (TPI)
P	Low carbon steel 1015, etc.	SH725	164 - 656	0.008 - 0.059	127 - 16
	Carbon steel, Alloy steel 1055, etc.	SH725	164 - 656	0.008 - 0.059	127 - 16
	Prehardened steel NAK80, PX5, etc.	SH725	164 - 656	0.008 - 0.059	127 - 16
M	Stainless steel S30400, etc.	SH725	164 - 656	0.008 - 0.059	127 - 16
N	Aluminum alloys 5056, 6061, etc.	SH725	490 - 660	0.008 - 0.059	127 - 16
	Copper alloys C2600, C280C, etc.	SH725	330 - 660	0.008 - 0.059	127 - 16
S	Titanium alloys Ti-6Al-4V, etc.	SH725	98 - 262	0.008 - 0.059	127 - 16
	Superalloys Inconel718, etc.	SH725	98 - 262	0.008 - 0.059	127 - 16

Reference pages: TungThread : Inserts → **E010, E013 - E031**, Toolholders → **E032 - E042**
 TungT-Clamp : Inserts → **E012**, Toolholders → **E049 - E050**
 TetraMini-Cut: Inserts → **E011**, Toolholders → **E043 - E044**
 DuoJust-Cut : Inserts → **E011**, Toolholders → **E045 - E048**



Technical Guide

TINYMINI TURN

STANDARD CUTTING CONDITIONS

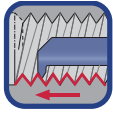

Internal threading

ISO	Workpiece materia	Grade	Cutting speed Vc (m/min)	Cutting speed Vc (sfm)	Number of passes Pitch (mm) / (in)				
					0.5 (0.020)	0.75 (0.029)	1 (0.039)	1.25 (0.049)	1.5 (0.059)
P	Low carbon steel C15, C20, etc.	SH730	40 - 140	131 - 459	6 - 8	8 - 10	10 - 12	12 - 15	15 - 18
	Carbon steel, Alloy steel C55, 42CrMoS4, etc.	SH730	40 - 140	131 - 459	6 - 8	8 - 10	10 - 12	12 - 15	15 - 18
	Prehardened steel NAK80, PX5, etc.	SH730	40 - 140	131 - 459	6 - 8	8 - 10	10 - 12	12 - 15	15 - 18
M	Stainless steel X5CrNi18-9, X5CrNiMo17-12-2, etc.	SH730	40 - 140	131 - 459	8	10	12	15	18
K	Gray cast iron 250, 300, etc.	SH730	30 - 100	98 - 328	7	9	12	14	17
	Ductile cast iron 400-15, 600-3, etc.	SH730	30 - 100	98 - 328	7	9	12	14	17
N	Aluminum alloys, copper alloys Si < 12%	SH730	90 - 200	295 - 656	6	8	10	12	15

IMPORTANT - Replacement of shim

AH 725 insert has 2 types of shims according to the chipbreaker geometry. Please find an appropriate shim in the table below. When using a wrong shim, the insert seating may become unstable or the tool life may be shortened.

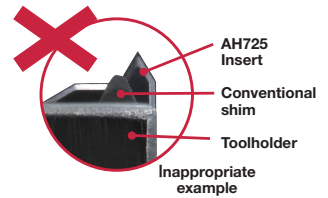

Interchangeable shim (Insert size: 16)

Toolholder screw type	Lead angle	External		Internal	
		① Conventional shim	① Standard (New)	② Conventional shim	② Standard (New)
Dual clamping methods of screw-on and clamp-on	4°	GXE16-4DT	AE16-4DT	GXN16-4DT	AN16-4DT
	3°	GXE16-3DT	AE16-3DT	GXN16-3DT	AN16-3DT
	2°	GXE16-2DT	AE16-2DT	GXN16-2DT	AN16-2DT
	1° (Standard)	GX16-1DT	A16-1DT	GX16-1DT	A16-1DT
	0°	GXE16-0DT	AE16-0DT	GXN16-0DT	AN16-0DT
	-1°	GXE16-99DT	AE16-99DT	GXN16-99DT	AN16-99DT
	-2°	GXE16-98DT	AE16-98DT	GXN16-98DT	AN16-98DT
Clamp-on	4°	GXE16-4	AE16-4	GXN16-4	AN16-4
	3°	GXE16-3	AE16-3	GXN16-3	AN16-3
	2°	GXE16-2	AE16-2	GXN16-2	AN16-2
	1° (Standard)	GXE16-1	A16-1	GXN16-1	A16-1
	0°	GXE16-0	AE16-0	GXN16-0	AN16-0
	-1°	GXE16-99	AE16-99	GXN16-99	AN16-99
	-2°	GXE16-98	AE16-98	GXN16-98	AN16-98

Shim to be replaced (Insert size: 16)

Thread	External			Internal		
	Designation	Grade	Replacement	Designation	Grade	Replacement
ISO				16IR15ISO-B	AH725	
				16IR175ISO-B	AH725	
				16IR20ISO-B	AH725	
55°	16ERAG55-B	AH725		16IRAG55-B	AH725	
				16IRG55-B	AH725	
60°	16ERA60-B	AH725	① Conventional shim	16IRAG60-B	AH725	② Conventional shim
			↓	16IRA60-B	AH725	↓
				16IRG60-B	AH725	
UN			① Standard (New)	16IR18UN-B	AH725	② Standard (New)
				16IR16UN-B	AH725	
				16IR14UN-B	AH725	
W				16IR16W-B	AH725	
				16IR14W-B	AH725	
PT				16IR14PT-B	AH725	
NPT	16ER8NPT-B	AH725		16IR14NPT-B	AH725	
				16IR115NPT-B	AH725	

Reference pages: TinyMini-Turn: Toolholders → E052, Replacement of shim → E010, E014, E017 - E022

Parting, Grooving



Parting, Grooving - Content structure

- Products are listed by application.
- Each item is listed by product series.
- Internal grooving tools are listed according to the order of the minimum machining diameter (from small to larger).

How to use the page

Method ①

Select the application (①) at the left end of each page and choose a designation you need (④) in the dimension table (③). Applicable inserts are shown in (⑥).

TETRAMCUT
STCR/L-18-CHP
External grooving and threading toolholder, with high pressure coolant capability

TUNGALLOY

Right hand / Left hand

④

Inch	MM	CMX	H	B	LF	LH	HBL	HF	WF	NBH	Insert	Torque
STCR/L-18-CHP	0.013	0.116	0.500	0.500	3.54	0.728	0.689	0.500	0.500	0.193	TC18..	0.89

③

⑥

SPARE PARTS

Designation	Designation	Quantity
STCR/L-18-CHP	CSTC-4L1000R	T-1000-5
STCR/L-18-CHP	CSTC-4L1000L	T-1000-5

STCR/L-18-CHP
Threading tool - for external threading with high pressure coolant capability

Method ②

Select the tool series name on **F004 - F005** and check the details on the product page.

Parting, Grooving - Machining Overview

External grooving F010 page

Max. groove depth: 0.252" (6.4 mm)

TETRAMCUT F037 page

TETRAMCUT F049 page

GBR/L32 F095 page

GBR/L42 F096 page

GX-E F100 page

Max. groove depth: 1.969" (50 mm)

TUNGALLOY F010 page

TUNGALLOY F089 page

MY-T SERIES Flex, CGD, G series, CDT F058 page

For Swiss lathes

TETRAMCUT F037 page

TETRAMCUT F049 page

TUNGALLOY F014 page

J-SERIES (JTGR/L) F103 page

TUNGALLOY F089 page

Internal grooving F116 page

General internal grooving and turning

TUNGALLOY F116 page

MY-T SERIES G series F138 page

GBR/L32 F155 page

Small-diameter internal grooving

TINYTURN G070 page

SNG F158 page

F004 www.tungaloy.com/us

Method ③

Select the tool series or the tool specification from Quick Guide on **F006 - F007** and see the details on each page.

Quick Guide

Series	Insert	External grooving		Parting
		Right Hand	Left Hand	
TUNGALLOY		High Metal CW: 0.020" - 0.315" (0.5 - 8 mm) CDK: 1.417" (36 mm) F010 page	High Metal CW: 0.020" - 0.315" (0.5 - 8 mm) OUTDIA: 4.724" (120 mm) F029 page	
TETRAMCUT		Economy CW: 0.021" - 0.125" (0.5 - 3.18 mm) CDK: 0.250" (6.4 mm) F049 page	Economy CW: 0.021" - 0.125" (0.5 - 3.18 mm) OUTDIA: 0.504" (12.8 mm) F049 page	
TETRAMCUT		Economy CW: 0.013" - 0.118" (0.33 - 3 mm) CDK: 0.158" (4 mm) F037 page	Economy CW: 0.013" - 0.118" (0.33 - 3 mm) OUTDIA: 0.276" (7 mm) F037 page	
MY-T SERIES		High Metal CW: 0.079" - 0.197" (2 - 5 mm) CDK: 0.984" (25 mm) F098 page	High Metal CW: 0.079" - 0.197" (2 - 5 mm) OUTDIA: 4.724" (120 mm) F225 page	
EASYPART				
TUNGALLOY		High Metal CW: 0.024" - 0.984" (0.6 - 25 mm) CDK: 1.969" (50 mm) F089 page		
TUNGALLOY		High Metal CW: 0.030" - 0.118" (0.7 - 3 mm) DMN: 0.100" (2.5 mm) F075 page		
GBR/L		High Metal CW: 0.013" - 0.177" (0.33 - 4.5 mm) CDK: 0.100" (2.5 mm) F095 page		
SNG / CNG				
GX-E / GX-I		High Metal CW: 0.030" - 0.177" (0.7 - 4.5 mm) CDK: 0.236" (6 mm) F100 page		
Other				For O-ring and lock ring CW: 0.045" - 0.165" (1.15 - 4.2 mm) DMN: 0.127" (3.2 mm) F098 - F099 pages

F006 www.tungaloy.com/us

2 **TERRACUT**
STCR/L-F18-CHP
External grooving and threading toolholder, with high pressure coolant capability

5

4

Inch	CWN	CWX	H	B	LF	LH	HBL	HF	WF	HBM	Insert	Torque
STCR/L-F18-CHP	0.013	0.118	0.500	3.344	0.728	0.689	0.500	0.01500	0.130	TC*18..	0.89	

7 **SPARE PARTS**

Designation	Clamping screw	Wrench
STCR/L-F18-CHP	CSTC-AL3000R	T-1008.5
STCR/L-F18-CHP	CSTC-AL3000L	T-1008.5

3 **STCR/L-18-CHP**
Threading tool - for external threading with high pressure coolant capability

6

10 Reference pages: Inserts → F042 - F047, Standard cutting conditions → F048, Parts for coolant hose → F240
F038 www.tungaloy.com/us

8 **INSERT**
TGR18R/L (with edge preparation)

8

Designation	HAND	CWx160 (mm)	CWx4.00 (in)	RE (in)	Coated	CDX (in)	S (in)
TGR18R100-010	R	1	0.039	0.004	●	0.079	0.157
TGR18L100-010	L	1	0.039	0.004	●	0.079	0.157
TGR18R120-010	R	1.2	0.047	0.004	●	0.079	0.157
TGR18L120-010	L	1.2	0.047	0.004	●	0.079	0.157
TGR18R125-010	R	1.25	0.049	0.004	●	0.079	0.157
TGR18L125-010	L	1.25	0.049	0.004	●	0.079	0.157
TGR18R125-020	R	1.25	0.049	0.008	●	0.079	0.157
TGR18L125-020	L	1.25	0.049	0.008	●	0.079	0.157
TGR18R130-020	R	1.3	0.051	0.008	●	0.079	0.157
TGR18L130-020	L	1.3	0.051	0.008	●	0.079	0.157
TGR18R140-010	R	1.4	0.055	0.004	●	0.138	0.157
TGR18L140-010	L	1.4	0.055	0.004	●	0.138	0.157
TGR18R140-020	R	1.4	0.055	0.008	●	0.138	0.157
TGR18L140-020	L	1.4	0.055	0.008	●	0.138	0.157
TGR18R145-010	R	1.45	0.057	0.004	●	0.138	0.157
TGR18L145-010	L	1.45	0.057	0.004	●	0.138	0.157
TGR18R145-020	R	1.45	0.057	0.008	●	0.138	0.157
TGR18L145-020	L	1.45	0.057	0.008	●	0.138	0.157
TGR18R150-010	R	1.5	0.059	0.004	●	0.138	0.157
TGR18L150-010	L	1.5	0.059	0.004	●	0.138	0.157
TGR18R150-020	R	1.5	0.059	0.008	●	0.138	0.157
TGR18L150-020	L	1.5	0.059	0.008	●	0.138	0.157
TGR18R160-020	R	1.6	0.063	0.008	●	0.138	0.157
TGR18L160-020	L	1.6	0.063	0.008	●	0.138	0.157
TGR18R170-020	R	1.7	0.067	0.008	●	0.138	0.157
TGR18L170-020	L	1.7	0.067	0.008	●	0.138	0.157
TGR18R175-010	R	1.75	0.069	0.004	●	0.138	0.157
TGR18L175-010	L	1.75	0.069	0.004	●	0.138	0.157
TGR18R175-020	R	1.75	0.069	0.008	●	0.138	0.157
TGR18L175-020	L	1.75	0.069	0.008	●	0.138	0.157
TGR18R185-020	R	1.85	0.073	0.008	●	0.138	0.157
TGR18L185-020	L	1.85	0.073	0.008	●	0.138	0.157
TGR18R195-020	R	1.95	0.077	0.008	●	0.138	0.157
TGR18L195-020	L	1.95	0.077	0.008	●	0.138	0.157

See page F048 for precautions of processing. 5 pieces per package. ●: 1st choice, ○: 2nd choice.

Reference pages: Toolholders → F037 - F041, Standard cutting conditions → F048
F042 www.tungaloy.com/us

9 **STANDARD CUTTING CONDITIONS**

ISO	Workpiece material	Cutting speed Vc (sfm)	TCP / TCP-F (AH725 / SH725)	TCS (AH7025)	TCG (AH7025)
P	Low carbon steel 1015, etc.	260 - 690	0.001 - 0.004	0.001 - 0.006	0.001 - 0.005
P	Carbon steel, Alloy steel 1045, etc.	260 - 690	0.001 - 0.004	0.001 - 0.006	0.001 - 0.005
P	Prehardened steel NAK80, PAK, etc.	260 - 690	0.001 - 0.004	0.001 - 0.006	0.001 - 0.005
M	Stainless steel S30400, etc.	160 - 390	0.001 - 0.004	0.001 - 0.006	0.001 - 0.005
K	Gray cast iron No.2508, No.3008, etc.	160 - 690	0.001 - 0.004	0.001 - 0.006	0.001 - 0.005
K	Ductile cast iron 60-40-18, 60-45-08, etc.	160 - 690	0.001 - 0.004	0.001 - 0.006	0.001 - 0.005
S	Titanium alloy Ti-6Al-4V, etc.	60 - 260	0.001 - 0.004	0.001 - 0.006	0.001 - 0.005
S	Superalloys Inconel718, etc.	60 - 260	0.001 - 0.004	0.001 - 0.006	0.001 - 0.005

F048 www.tungaloy.com/us

- 1 : Application
- 2 : Tool series name
- 3 : Dimension table
- 4 : Toolholder designation
e.g. right-hand, 08 square shank
→ **STCR08F18-CHP**
R/L in the designation means the stock either right or left hand respectively.
- 5 : Dimension (conforming to ISO13399)
- 6 : Applicable insert
- 7 : Spare parts
- 8 : Insert
- 9 : Standard cutting conditions
- 10 : Reference pages

When ordering

- Please specify the designation and quantity for toolholders.
e.g. **CTER10-2T08 ... 1**
- Please specify the designation and quantity for shank and blade set when ordering both.
e.g. **CHSR12-CHP ... 1, CAER-2T20-CHP... 1** (one shank per package, one blade per package)
* Clamp screw for blade is included.
- Please specify the designation, grade, and quantity for inserts.
e.g. **DGS3-020 AH7025 ... 10** (10 inserts per package)
*You will find a note if the number per package is not 10.

Parting, Grooving - Machining Overview

External grooving F010 page

Max. groove depth: 0.252" (6.4 mm)

Economy **TETRAMCUT** F037 page

Economy **TETRAFCUT** F049 page

GBR/L32 F095 page

GBR/L42 F096 page

GX-E F100 page

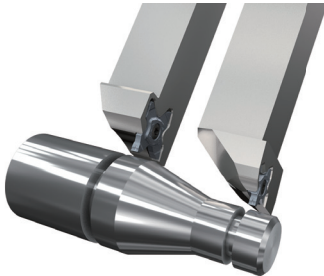

Max. groove depth: 1.969" (50 mm)

First choice **TUNGCUT** F010 page

TUNGHAYGROOVE F089 page

MY-T SERIES
Flex, CGD, G series , CDT F058 page



For Swiss lathes

Economy **TETRAMCUT** F037 page

Economy **TETRAFCUT** F049 page

TUNGCUT F014 page

J-SERIES (JTGR/L) F103 page

TUNGHAYGROOVE F089 page



Internal grooving F116 page

General internal grooving and turning

First choice **TUNGCUT** F116 page

MY-T SERIES
G series F136 page

GBR/L32 F155 page

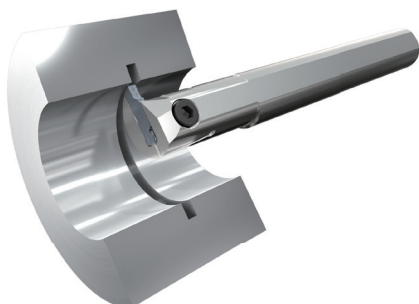

Small-diameter internal grooving

TINYTURN G070 page

SNG F158 page

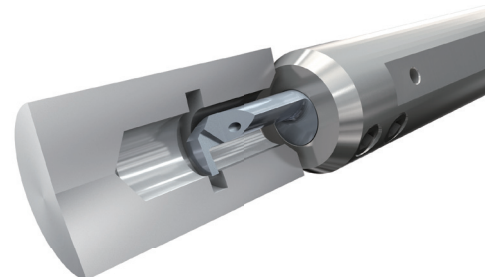

Face grooving

F167 page

- First choice** **TUNGCUT** F171 page
- EASYMCUT^{ULTRA}** F167 page
- Economy** **TETRAMCUT** F037 page
- MY-T SERIES** F194 page
- GX-F** F206 page

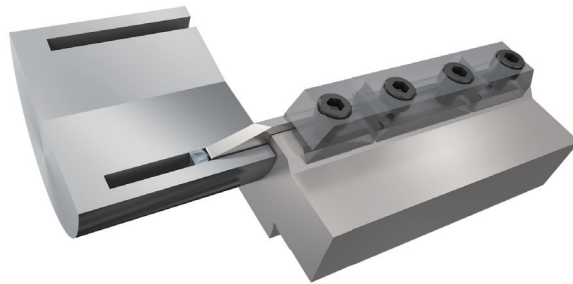

Parting

F209 page

- General parting**
- First choice** **TUNGCUT** F209 page
 - Economy** **TETRAFCUT** F049 page
 - MY-T SERIES** F225 page

For Swiss lathes

- First choice** **DUOJUST** G111 page
- TUNGCUT** F014 page
- Economy** **TETRAFCUT** F049 page
- Economy** **TETRAMCUT** F037 page
- J-SERIES** F103 page

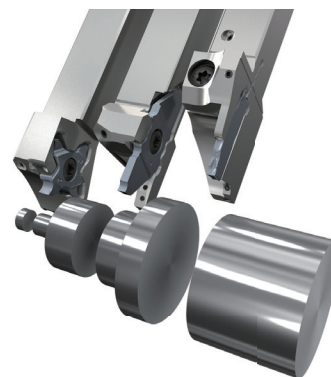
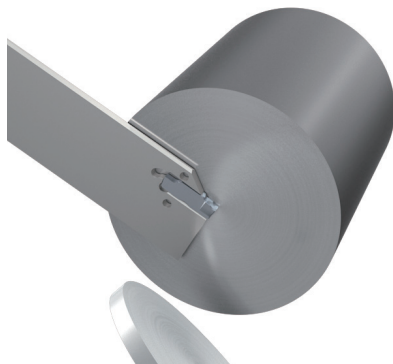

Quick Guide

Series	Insert	External grooving	Parting
			
TUNGCUT Inch <input checked="" type="checkbox"/> Metric <input checked="" type="checkbox"/>		<input checked="" type="radio"/> First choice CW: 0.055" - 0.315" (1.4 - 8 mm) CDX: 1.417" (36 mm) F010 page	<input checked="" type="radio"/> First choice CW: 0.055" - 0.315" (1.4 - 8 mm) CUTDIA: 4.724" (120 mm) F209 page
TETRAFCUT Inch <input checked="" type="checkbox"/> Metric <input checked="" type="checkbox"/>		<input checked="" type="radio"/> Economy CW: 0.02" - 0.125" (0.5 - 3.18 mm) CDX: 0.252" (6.4 mm) F049 page	<input checked="" type="radio"/> Economy CW: 0.02" - 0.125" (0.5 - 3.18 mm) CUTDIA: 0.504" (12.8 mm) F049 page
TETRAMCUT Inch <input checked="" type="checkbox"/> Metric <input checked="" type="checkbox"/>		<input checked="" type="radio"/> Economy CW: 0.013" - 0.118" (0.33 - 3 mm) CDX: 0.138" (3.5 mm) F037 page	<input checked="" type="radio"/> Economy CW: 0.013" - 0.118" (0.33 - 3 mm) CUTDIA: 0.276" (7 mm) F037 page
MY-T SERIES Inch <input checked="" type="checkbox"/> Metric <input checked="" type="checkbox"/>		<input type="radio"/> CW: 0.079" - 0.197" (2 - 5 mm) CDX: 0.984" (25 mm) F058 page	<input type="radio"/> CW: 0.079" - 0.197" (2 - 5 mm) CUTDIA: 4.724" (120 mm) F225 page
EASYMCUT^{ULTRA} Inch <input checked="" type="checkbox"/> Metric <input type="checkbox"/>			
TUNGH^{MAX}GROOVE Inch <input checked="" type="checkbox"/> Metric <input type="checkbox"/>		<input checked="" type="radio"/> First choice CW: 0.394" - 0.984" (10 - 25 mm) CDX: 1.969" (50 mm) F089 page	
TUNGT-CLAMP Inch <input checked="" type="checkbox"/> Metric <input checked="" type="checkbox"/>		<input type="radio"/> CW: 0.039" - 0.118" (1 - 3 mm) DMIN: 0.160" (4.07 mm) F076 page	
GBR/L Inch <input checked="" type="checkbox"/> Metric <input checked="" type="checkbox"/>		<input type="radio"/> CW: 0.013" - 0.177" (0.33 - 4.5 mm) CDX: 0.197" (5 mm) F095 page	
SNG / CNG Inch <input type="checkbox"/> Metric <input checked="" type="checkbox"/>			
GX-E / GX-I Inch <input checked="" type="checkbox"/> Metric <input checked="" type="checkbox"/>		<input type="radio"/> CW: 0.039" - 0.177" (1 - 4.5 mm) CDX: 0.236" (6 mm) F100 page	
Other Inch <input type="checkbox"/> Metric <input checked="" type="checkbox"/>		For O-ring and lock ring CW: 0.045" - 0.165" (1.15 - 4.2 mm) DMIN: 0.157" (4 mm) F098 - F099 pages	

⊙ : First choice
○ : Usable

	Face grooving	Internal grooving	Profiling (Full-R)	Turning
				
	<p>First choice ⊙</p> <p>CW: 0.118" - 0.236" (3 - 6 mm) CDX: 0.984" (25 mm) DAXN: 0.984" (25 mm) F171 page</p>	<p>First choice ⊙</p> <p>CW: 0.079" - 0.315" (2 - 8 mm) CDX: 0.394" (10 mm) DMIN: 0.984" (25 mm) F116 page</p>	<p>First choice ⊙</p> <p>CW: 0.118" - 0.315" (3 - 8 mm) CDX: 1.417" (36 mm) F010 page</p>	<p>First choice ⊙</p> <p>CW: 0.118" - 0.315" (3 - 8 mm) CDX: 1.417" (36 mm) F010 page</p>
			<p>Economy ⊙</p> <p>CW: 0.062" - 0.118" (1.57 - 3 mm) CDX: 0.252" (6.4 mm) F049 page</p>	
	<p>○</p> <p>CW: 0.013" - 0.118" (0.33 - 3 mm) CDX: 0.118" (3 mm) DAXN: 2.559" (65 mm) F037 page</p>			
	<p>○</p> <p>CW: 0.118" - 0.197" (3 - 5 mm) CDX: 0.866" (22 mm) DAXN: 1.181" (30 mm) F194 page</p>	<p>○</p> <p>CW: 0.118" - 0.197" (3 - 5 mm) CDX: 0.236" (6 mm) DMIN: 0.984" (25 mm) F136 page</p>	<p>○</p> <p>CW: 0.118" - 0.197" (3 - 5 mm) CDX: 0.984" (25 mm) F058 page</p>	<p>○</p> <p>CW: 0.118" - 0.197" (3 - 5 mm) CDX: 0.984" (25 mm) F058 page</p>
	<p>⊙</p> <p>CW: 0.157" - 0.236" (4 - 6 mm) CDX: 2.559" (65 mm) DAXN: 1.181" (30 mm) F167 page</p>			
		<p>CW: 0.039" - 0.118" (1 - 3 mm) CDX: 0.160" (4.07 mm) DMIN: 1.374" (34.9 mm) F143 page</p>		
		<p>⊙</p> <p>CW: 0.013" - 0.177" (0.33 - 4.5 mm) CDX: 0.098" (2.5 mm) DMIN: 1.378" (35 mm) F155 page</p>	<p>⊙</p> <p>CW: 0.039" - 0.157" (1 - 4 mm) CDX: 0.197" (5 mm) F093 page</p>	
		<p>○</p> <p>CW: 0.039" - 0.197" (1 - 5 mm) CDX: 0.197" (5 mm) DMIN: 0.315" (8 mm) F158 page</p>		
		<p>○</p> <p>CW: 0.039" - 0.177" (1 - 4.5 mm) CDX: 0.236" (6 mm) DMIN: 2.165" (55 mm) F164 page</p>		
		<p>• CGXR/L</p> <p>CW: 0.039" - 0.197" (1 - 5 mm) DMIN: 0.787" (20 mm) F162 page</p>		

Multi-functional grooving tool series with excellent versatility

New modular holder system enhances versatility of existing monoblock holder and TungCap (PSC) lines. High-pressure coolant system improves chip flow and tool life.



High clamping rigidity

For stable tool life and accuracy

Clamping system

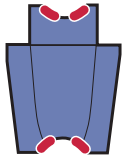

● **Stable and safe contact areas!**

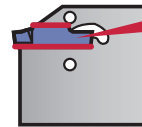

High repeatability and durability due to long pocket!

Minimizes cutting edge displacement

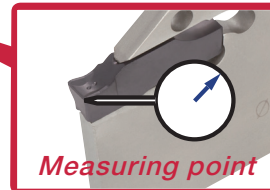
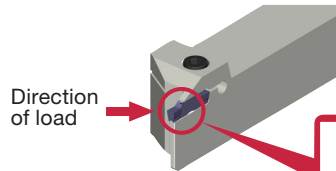
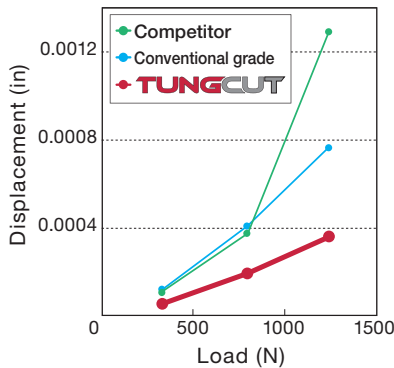

Excellent chip control at low feed rates

P Mild steel (SUJ2)

First choice chipbreaker for low carbon (soft) steel. Excellent chip control at low feed rates.



Workpiece material : SUJ2
 Toolholder : CTER16-3T09
 Insert : DGL3-025
 Groove width : 0.118"

	$f = 0.001$ ipr	$f = 0.002$ ipr	$f = 0.003$ ipr	$f = 0.004$ ipr
$V_c = 164$ sfm				
$V_c = 328$ sfm				

Reference pages: **F010, F116, F171, F209**

How to install and remove the blade and insert



Assembly

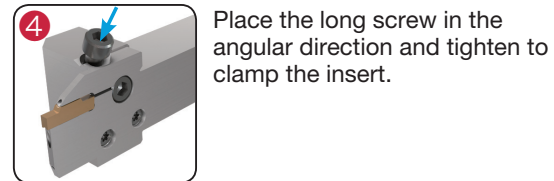
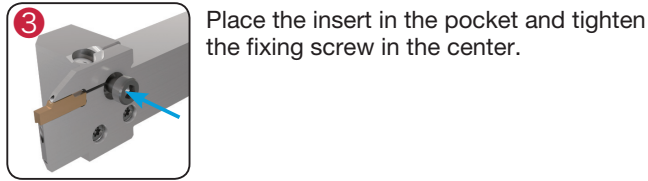
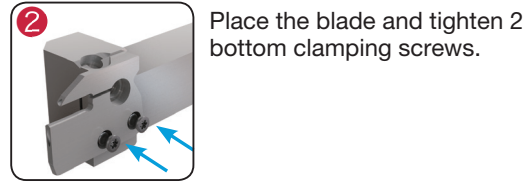
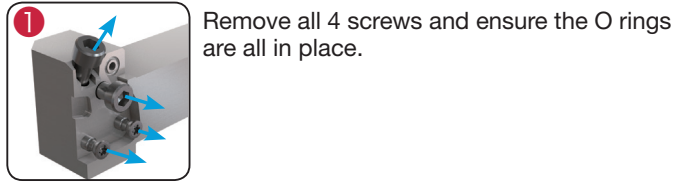

Please follow the installation order as shown above. When the screws are tightened in the 4 → 3 order, the insert clamping may be insufficient and unstable.

Disassembly

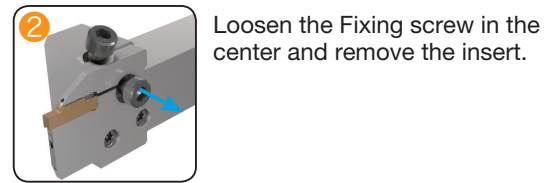
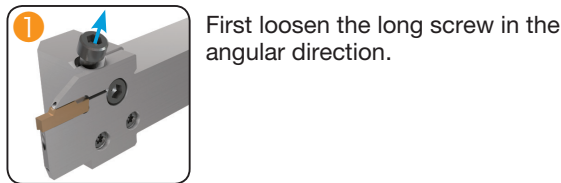

Loosening the long screw alone may not release the insert.

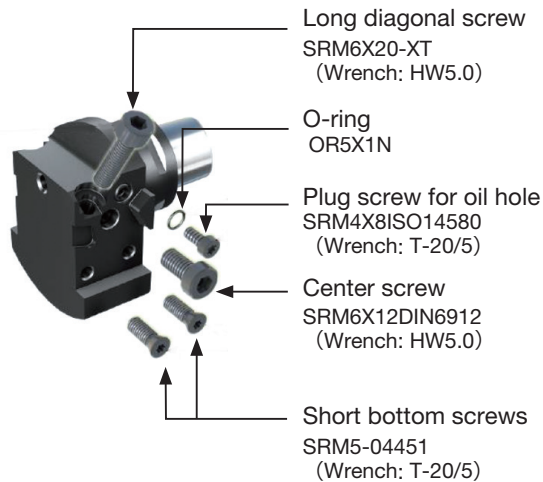
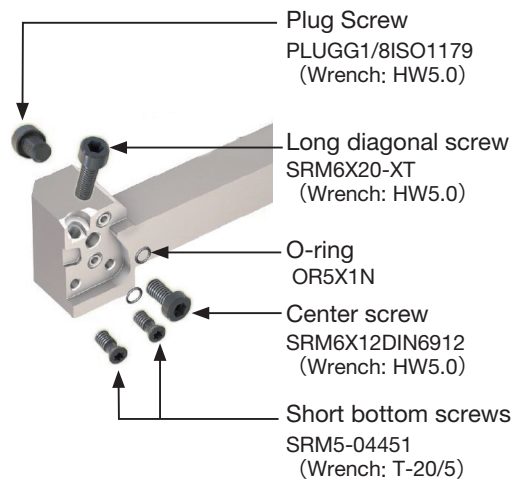

All parts listed here are included in the tool holder.

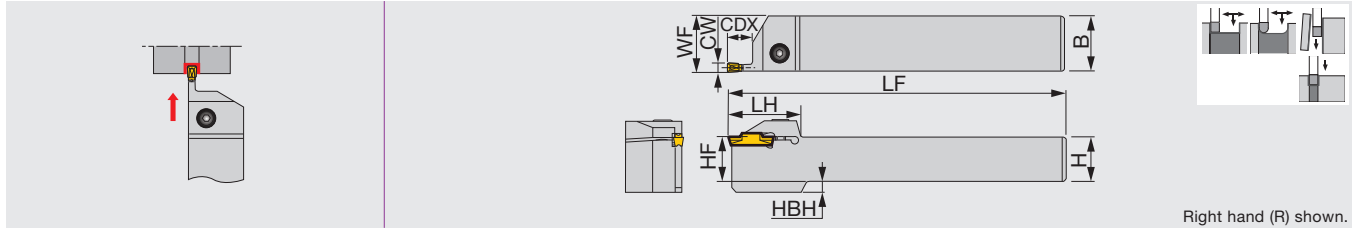

Inch	CW (in)	CW (mm)	Seat size	CDX	H	B	LF	LH	HF	WF ⁽¹⁾	HBH	Torque
CTER/L10-2T08	0.079	2	2	0.315	0.625	0.625	4.500	1.299	0.625	0.629	0.157	3.69
CTER/L12-2T08	0.079	2	2	0.315	0.750	0.750	5.000	1.299	0.750	0.754	-	3.69
CTER/L16-2T08	0.079	2	2	0.315	1.000	1.000	6.000	1.299	1.000	1.004	-	3.69
CTER/L10-2T12	0.079	2	2	0.472	0.625	0.625	4.500	1.260	0.625	0.629	0.157	3.69
CTER/L12-2T12	0.079	2	2	0.472	0.750	0.750	5.000	1.260	0.750	0.754	-	3.69
CTER/L16-2T12	0.079	2	2	0.472	1.000	1.000	6.000	1.260	1.000	1.004	-	3.69
CTER/L10-2T17	0.079	2	2	0.669	0.625	0.625	4.500	1.457	0.625	0.629	0.157	3.69
CTER/L12-2T17	0.079	2	2	0.669	0.750	0.750	5.000	1.457	0.750	0.754	-	3.69
CTER/L16-2T17	0.079	2	2	0.669	1.000	1.000	6.000	1.457	1.000	1.004	-	3.69
CTER/L10-3T09	0.118	3	3	0.354	0.625	0.625	4.500	1.260	0.625	0.637	0.157	3.69
CTER/L12-3T09	0.118	3	3	0.354	0.750	0.750	5.000	1.260	0.750	0.762	-	3.69
CTER/L16-3T09	0.118	3	3	0.354	1.000	1.000	6.000	1.260	1.000	1.012	-	3.69
CTER/L12-3T12	0.118	3	3	0.472	0.750	0.750	5.000	1.260	0.750	0.763	-	3.69
CTER/L16-3T12	0.118	3	3	0.472	1.000	1.000	6.000	1.260	1.000	1.012	-	3.69
CTER/L10-3T20	0.118	3	3	0.787	0.625	0.625	4.500	1.516	0.625	0.637	0.157	3.69
CTER/L12-3T20	0.118	3	3	0.787	0.750	0.750	5.000	1.516	0.750	0.762	-	3.69
CTER/L16-3T20	0.118	3	3	0.787	1.000	1.000	6.000	1.516	1.000	1.012	-	3.69
CTER/L16-3T25	0.118	3	3	0.984	1.000	1.000	6.000	1.752	1.000	1.012	-	3.69
CTER/L10-4T10	0.157	4	4	0.394	0.625	0.625	4.500	1.260	0.625	0.645	0.157	6.27
CTER/L12-4T10	0.157	4	4	0.394	0.750	0.750	5.000	1.260	0.750	0.770	-	6.27
CTER/L16-4T10	0.157	4	4	0.394	1.000	1.000	6.000	1.260	1.000	1.020	-	6.27
CTER/L12-4T15	0.157	4	4	0.590	0.750	0.750	5.000	1.299	0.750	0.770	-	6.27
CTER/L16-4T15	0.157	4	4	0.590	1.000	1.000	6.000	1.299	1.000	1.020	-	6.27
CTER/L10-4T25	0.157	4	4	0.984	0.625	0.625	4.500	1.772	0.625	0.645	0.157	6.27
CTER/L12-4T25	0.157	4	4	0.984	0.750	0.750	5.000	1.772	0.750	0.770	-	6.27
CTER/L16-4T25	0.157	4	4	0.984	1.000	1.000	6.000	1.772	1.000	1.020	-	6.27
CTER/L20-4T25	0.157	4	4	0.984	1.250	1.250	7.000	1.772	1.250	1.270	-	6.27
CTER/L12-5T12	0.197	5	5	0.472	0.750	0.750	5.000	1.457	0.750	0.774	-	6.27
CTER/L16-5T12	0.197	5	5	0.472	1.000	1.000	6.000	1.457	1.000	1.024	-	6.27
CTER/L16-5T20	0.197	5	5	0.787	1.000	1.000	6.000	1.457	1.000	1.024	-	6.27
CTER/L16-5T32	0.197	5	5	1.260	1.000	1.000	6.000	2.205	1.000	1.024	-	6.27
CTER/L20-5T32	0.197	5	5	1.260	1.250	1.250	7.000	2.205	1.250	1.274	-	8.85
CTER/L12-6T12	0.236	6	6	0.472	0.750	0.750	5.000	1.457	0.750	0.770	-	8.85
CTER/L16-6T12	0.236	6	6	0.472	1.000	1.000	6.000	1.457	1.000	1.020	0.276	8.85
CTER/L16-6T20	0.236	6	6	0.787	1.000	1.000	6.000	1.614	1.000	1.023	0.276	8.85
CTER/L16-6T32	0.236	6	6	1.260	1.000	1.000	6.000	2.205	1.000	1.020	0.276	8.85
CTER/L20-6T32	0.236	6	6	1.260	1.250	1.250	7.000	2.205	1.250	1.270	-	8.85
CTER/L16-8T16	0.315	8	8	0.630	1.000	1.000	6.000	1.850	1.000	1.039	0.276	8.85
CTER/L16-8T25	0.315	8	8	0.984	1.000	1.000	6.000	1.850	1.000	1.039	0.276	8.85
CTER/L20-8T25	0.315	8	8	0.984	1.250	1.250	7.000	1.850	1.250	1.289	-	8.85
CTER/L16-8T36	0.315	8	8	1.417	1.000	1.000	6.000	2.362	1.000	1.039	0.276	8.85
CTER/L20-8T36	0.315	8	8	1.417	1.250	1.250	7.000	2.362	1.250	1.289	-	8.85

When groove depth is larger than (insert length - 0.059"), please use 1-cornered insert.

(1) "WF" value is calculated with groove width "CW" shown in the table.

Torque: Recommended clamping torque: lbs-ft

Reference pages: Inserts → **F023 - F036**, Standard cutting conditions → **F032**

Metric	CW	Seat size	CDX	H	B	LF	LH	HF	WF ⁽¹⁾	HBH	Torque*
CTER/L1616-2T08	2	2	8	16	16	110	33	16	16.1	4	5
CTER/L2020-2T08	2	2	8	20	20	125	33	20	20.1	-	5
CTER/L2525-2T08	2	2	8	25	25	150	33	25	25.1	-	5
CTER/L1616-2T12	2	2	12	16	16	110	32	16	16.1	4	5
CTER/L2020-2T12	2	2	12	20	20	125	32	20	20.1	-	5
CTER/L2525-2T12	2	2	12	25	25	150	32	25	25.1	-	5
CTER/L1616-2T17	2	2	17	16	16	110	37	16	16.1	4	5
CTER/L2020-2T17	2	2	17	20	20	125	37	20	20.1	-	5
CTER/L2525-2T17	2	2	17	25	25	150	37	25	25.1	-	5
CTER/L1616-3T09	3	3	9	16	16	110	32	16	16.3	4	5
CTER/L2020-3T09	3	3	9	20	20	125	32	20	20.3	-	5
CTER/L2525-3T09	3	3	9	25	25	150	32	25	25.3	-	5
CTER/L2020-3T12	3	3	12	20	20	125	32	20	20.3	-	5
CTER/L2525-3T12	3	3	12	25	25	150	32	25	25.3	-	5
CTER/L1616-3T20	3	3	20	16	16	110	38.5	16	16.3	4	5
CTER/L2020-3T20	3	3	20	20	20	125	38.5	20	20.3	-	5
CTER/L2525-3T20	3	3	20	25	25	150	38.5	25	25.3	-	5
CTER/L2525-3T25	3	3	25	25	25	150	44.5	25	25.3	-	5
CTER/L1616-4T10	4	4	10	16	16	110	32	16	16.5	4	8.5
CTER/L2020-4T10	4	4	10	20	20	125	32	20	20.5	-	8.5
CTER/L2525-4T10	4	4	10	25	25	150	32	25	25.5	-	8.5
CTER/L2020-4T15	4	4	15	20	20	125	33	20	20.5	-	8.5
CTER/L2525-4T15	4	4	15	25	25	150	33	25	25.5	-	8.5
CTER/L1616-4T25	4	4	25	16	16	110	45	16	16.5	4	8.5
CTER/L2020-4T25	4	4	25	20	20	125	45	20	20.5	-	8.5
CTER/L2525-4T25	4	4	25	25	25	150	45	25	25.5	-	8.5
CTER/L3232-4T25	4	4	25	32	32	170	45	32	32.5	-	8.5
CTER/L2020-5T12	5	5	12	20	20	125	37	20	20.6	-	8.5
CTER/L2525-5T12	5	5	12	25	25	150	37	25	25.6	-	8.5
CTER/L2525-5T20	5	5	20	25	25	150	37	25	25.6	-	8.5
CTER/L2525-5T32	5	5	32	25	25	150	56	25	25.6	-	8.5
CTER/L3232-5T32	5	5	32	32	32	170	56	32	32.6	-	8.5
CTER/L2020-6T12	6	6	12	20	20	125	37	20	20.6	-	12
CTER/L2525-6T12	6	6	12	25	25	150	37	25	25.6	7	12
CTER/L2525-6T20	6	6	20	25	25	150	41	25	25.6	-	12
CTER/L2525-6T32	6	6	32	25	25	150	56	25	25.6	7	12
CTER/L3232-6T32	6	6	32	32	32	170	56	32	32.6	-	12
CTER/L2525-8T16	8	8	16	25	25	150	47	25	26.1	7	12
CTER/L2525-8T25	8	8	25	25	25	150	47	25	26.1	7	12
CTER/L3232-8T25	8	8	25	32	32	170	47	32	33.1	-	12
CTER/L2525-8T36	8	8	36	25	25	150	60	25	26.1	7	12
CTER/L3232-8T36	8	8	36	32	32	170	60	32	33.1	-	12

When groove depth is larger than (insert length - 1.5 mm), please use 1-cornered insert. (1) "WF" value is calculated with groove width "CW" shown in the table.
Torque: Recommended clamping torque: N·m

Designation	Clamping screw	Wrench
CTER/L10-2T08, CTER/L1616-2T08	CM5X0.8X16-A	P-4
CTER/L12-2T08, CTER/L2020-2T08	CM5X0.8X20-A	P-4
CTER/L16-2T08, CTER/L2525-2T08	CM5X0.8X25-A	P-4
CTER/L10-2T12, CTER/L1616-2T12	CM5X0.8X16-A	P-4
CTER/L12-2T12, CTER/L2020-2T12	CM5X0.8X20-A	P-4
CTER/L16-2T12, CTER/L2525-2T12	CM5X0.8X25-A	P-4
CTER/L10-2T17, CTER/L1616-2T17	CM5X0.8X16-A	P-4
CTER/L12-2T17, CTER/L2020-2T17	CM5X0.8X20-A	P-4
CTER/L16-2T17, CTER/L2525-2T17	CM5X0.8X25-A	P-4
CTER/L10-3T09, CTER/L1616-3T09	CM5X0.8X16-A	P-4
CTER/L12-3T09, CTER/L2020-3T09	CM5X0.8X20-A	P-4
CTER/L12-3T12, CTER/L2525-3T09	CM5X0.8X25-A	P-4
CTER/L16-3T12, CTER/L2020-3T12	CM5X0.8X20-A	P-4
CTER/L10-3T20, CTER/L2525-3T12	CM5X0.8X25-A	P-4
CTER/L12-3T20, CTER/L1616-3T20	CM5X0.8X16-A	P-4
CTER/L16-3T20, CTER/L2020-3T20	CM5X0.8X20-A	P-4
CTER/L16-3T25, CTER/L2525-3T20.25	CM5X0.8X25-A	P-4
CTER/L10-4T10, CTER/L1616-4T10	CM6X1X16-A	P-5
CTER/L12-4T10, CTER/L2020-4T10	CM6X1X20-A	P-5
CTER/L16-4T10, CTER/L2525-4T10	CM6X1X25-A	P-5

Designation	Clamping screw	Wrench
CTER/L12-4T15, CTER/L2020-4T15	CM6X1X20-A	P-5
CTER/L16-4T15, CTER/L2525-4T15	CM6X1X25-A	P-5
CTER/L10-4T25, CTER/L1616-4T25	CM6X1X16-A	P-5
CTER/L12-4T25, CTER/L2020-4T25	CM6X1X20-A	P-5
CTER/L16-4T25, CTER/L2525-4T25	CM6X1X25-A	P-5
CTER/L20-4T25, CTER/L3232-4T25	CM6X1X25-A	P-5
CTER/L12-5T12, CTER/L2020-5T12	CM6X1X20-A	P-5
CTER/L16-5T12, CTER/L2525-5T12	CM6X1X25-A	P-5
CTER/L16-5T20, CTER/L2525-5T20	CM6X1X25-A	P-5
CTER/L16-5T32, CTER/L2525, 3232-5T32	CM6X1X25-A	P-5
CTER/L20-5T32, CTER/L2020-6T12	CM8X1.25X20-A	P-6
CTER/L12-6T12, CTER/L16-6T12, CTER/L2525-6T12	CM8X1.25X25-A	P-6
CTER/L16-6T20, CTER/L2525-6T20	CM8X1.25X25-A	P-6
CTER/L16-6T32, CTER/L20-6T32, CTER/L2525, 3232-6T32	CM8X1.25X25-A	P-6
CTER/L16-8T16, CTER/L2525-8T16	CM8X1.25X25-A	P-6
CTER/L16-8T25, CTER/L20-8T25, CTER/L2525, 3232-8T25	CM8X1.25X25-A	P-6
CTER/L16-8T36, CTER/L20-8T36, CTER/L2525, 3232-8T36	CM8X1.25X25-A	P-6

Mono-block external grooving and parting toolholder, with high pressure coolant capability

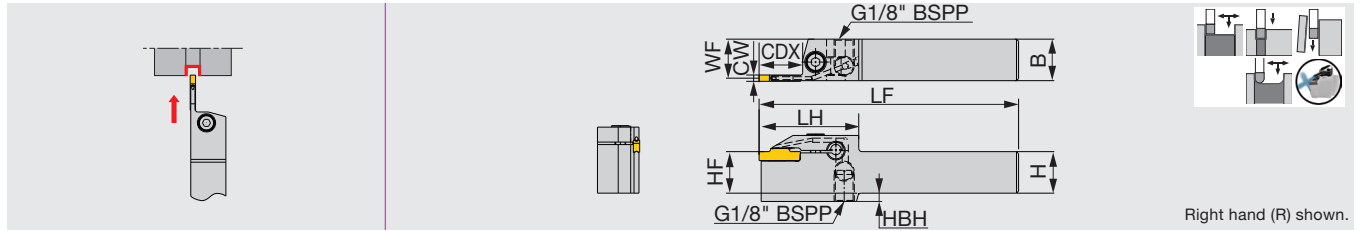

Right hand (R) shown.

Inch	CW (in)	CW (mm)	Seat size	CDX	H	B	LF	LH	HF	WF ⁽¹⁾	HBH	Torque
CTER/L12-2T17-CHP	0.079	2	2	0.669	0.750	0.750	5.000	1.772	0.750	0.715	0.157	4.06
CTER/L16-2T17-CHP	0.079	2	2	0.669	1.000	1.000	6.000	1.772	1.000	0.965	-	4.06
CTER/L12-3T25-CHP	0.118	3	3	0.984	0.750	0.750	5.000	2.008	0.750	0.703	0.157	4.06
CTER/L16-3T25-CHP	0.118	3	3	0.984	1.000	1.000	6.000	2.008	1.000	0.953	-	4.06
CTER/L16-4T25-CHP	0.157	4	4	0.984	1.000	1.000	6.000	2.170	1.000	0.941	-	5.90
CTER/L16-5T32-CHP	0.197	5	5	1.260	1.000	1.000	6.000	2.323	1.000	0.924	-	5.90
CTER/L16-6T32-CHP	0.236	6	6	1.260	1.000	1.000	6.000	2.441	1.000	0.905	0.276	8.85

Metric	CW	Seat size	CDX	H	B	LF	LH	HF	WF ⁽¹⁾	HBH	Torque*
CTER/L2020-2T17-CHP	2	2	17	20	20	125	45	20	19.1	4	5.5
CTER/L2525-2T17-CHP	2	2	17	25	25	150	45	25	24.1	-	5.5
CTER/L2020-3T20-CHP	3	3	20	20	20	125	48	20	18.8	4	5.5
CTER/L2525-3T20-CHP	3	3	20	25	25	150	48	25	23.8	-	5.5
CTER/L2525-3T25-CHP	3	3	25	25	25	150	51	25	23.8	-	5.5
CTER/L2525-4T25-CHP	4	4	25	25	25	150	55	25	23.5	-	8
CTER/L2525-5T20-CHP	5	5	20	25	25	150	49	25	23.08	-	8
CTER/L2525-6T20-CHP	6	6	20	25	25	150	52	25	22.58	7	12

When groove depth is larger than (insert length - 0.059"/1.5 mm), please use 1-cornered insert.

(1) "WF" value is calculated with groove width "CW" shown in the table.

Torque: Recommended clamping torque: lbs-ft (*N·m)

Inch SPARE PARTS



Designation	Clamping screw	Wrench
CTER/L12-2T17-CHP	CM5x0.8x20-A	P-4
CTER/L16-2T17-CHP	CM5x0.8x20-A	P-4
CTER/L12-3T25-CHP	CM5x0.8x25-A	P-4
CTER/L16-3T25-CHP	CM5x0.8x25-A	P-4
CTER/L16-4T25-CHP	CM6x1x16-A	P-5
CTER/L16-5T32-CHP	CM6x1x16-A	P-5
CTER/L16-6T32-CHP	CM8x1.25x20-A	P-6

Metric SPARE PARTS



Designation	Clamping screw	Wrench
CTER/L2020-2T17-CHP	CM5x0.8x20-A	P-4
CTER/L2525-2T17-CHP	CM5x0.8x25-A	P-4
CTER/L2020-3T20-CHP	CM5x0.8x20-A	P-4
CTER/L2525-3T20-CHP	CM5x0.8x25-A	P-4
CTER/L2525-3T25-CHP	CM5x0.8x25-A	P-4
CTER/L2525-4T25-CHP	CM6x1x16-A	P-5
CTER/L2525-5T20-CHP	CM6x1x16-A	P-5
CTER/L2525-6T20-CHP	CM8x1.25x20-A	P-6

Reference pages: Inserts → **F023 - F036**, Standard cutting conditions → **F032**
 Parts for coolant hose → **F240**, Technical Reference → **L043**

External face grooving and turning toolholder

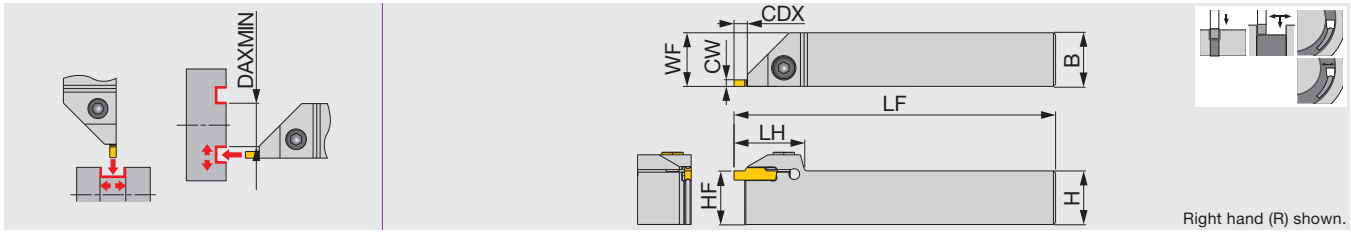

Right hand (R) shown.

Inch	CW (in)	CW (mm)	Seat size	CDX	HF	B	H	LF	WF ⁽¹⁾	LH	Torque
CTEFR/L12-4T04	0.157	4	2, 3, 4	0.189	0.750	0.750	0.750	5.000	0.770	1.300	6.27
CTEFR/L16-4T04	0.157	4	2, 3, 4	0.189	1.000	1.000	1.000	6.000	1.020	1.300	6.27
CTEFR/L12-6T04	0.236	6	5, 6	0.189	0.750	0.750	0.750	5.000	0.236	1.460	6.27
CTEFR/L16-6T04	0.236	6	5, 6	0.189	1.000	1.000	1.000	6.000	1.020	1.460	6.27

(1) "WF" value is calculated with groove width "CW" shown in the table.
Use the right-hand insert for the right-hand holder with DTF insert.
Torque: Recommended clamping torque: lbs-ft

SPARE PARTS

Designation	Clamping screw	Wrench
CTEFR/L12-4T04	CM6X1X20-A	P-5
CTEFR/L16-4T04	CM6X1X25-A	P-5
CTEFR/L12-6T04	CM6X1X20-A	P-5
CTEFR/L16-6T04	CM6X1X25-A	P-5

Insert	Groove width CW (in)	Face grooving Min. machining dia. DAXMIN (in)
DGM / DGS / SGN	0.079	11.614
DGM / DGS / SGN / DGL	0.118	3.622
DGM / DGS / SGN / DGL	0.157	1.457
DGM / DGS / DGL	0.197	2.362
DGM / DGS / DGL	0.236	2.244
DTE / DGG / DTM	0.118	2.441
DTE / DGG / DTM	0.157	1.654
DTE / DGG / DTM	0.197	2.520
DTE / DGG / DTM	0.236	2.402

Insert	Groove width CW (in)	Face grooving Min. machining dia. DAXMIN (in)
DTR	0.118	1.732
DTR	0.157	1.260
DTR	0.197	1.890
DTR	0.236	1.890
DTX	0.118	0.866
DTX	0.157	0.787
DTX	0.197	0.787
DTX	0.236	0.906
DTF	0.118	0.787
DTF	0.157	0.787



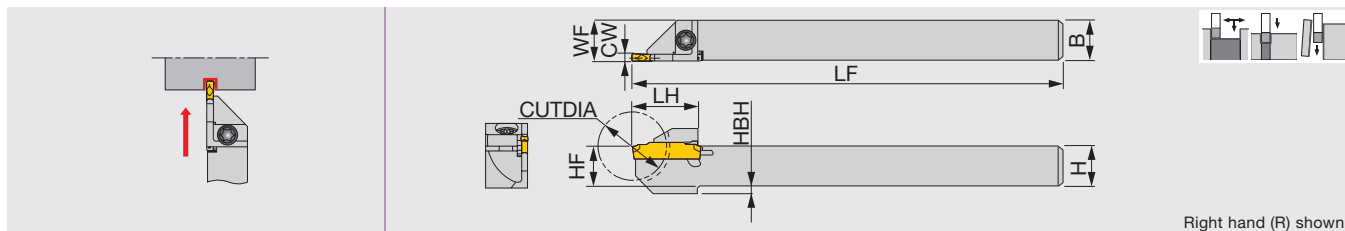

Right hand (R) shown.

Inch	CW (in)	CW (mm)	Seat size	CUTDIA	H	B	LF	LH	HF	WF ⁽¹⁾	HBH	Torque
JCTER/L08-2T12	0.079	2	2	0.945	0.500	0.500	4.750	0.748	0.500	0.504	0.079	2.21
JCTER/L08-3T12	0.118	3	3	0.945	0.500	0.500	4.750	0.748	0.500	0.512	0.079	2.21
JCTER/L10-2T16	0.079	2	2	1.260	0.625	0.625	4.750	0.945	0.625	0.629	-	2.21
JCTER/L10-3T16	0.118	3	3	1.260	0.625	0.625	4.750	0.945	0.625	0.637	-	2.21

Metric	CW	Seat size	CUTDIA	H	B	LF	LH	HF	WF ⁽¹⁾	HBH	Torque*
JCTER/L1010X1.4T10	1.4	1	20	10	10	120	18	10	10.2	-	3
JCTER/L010-1.4T10	1.4	1	20	10	10	125	18	10	10.2	-	3
JCTER/L1212F1.4T12	1.4	1	24	12	12	85	19.5	12	12.2	-	3
JCTER/L1212X1.4T12	1.4	1	24	12	12	120	19.5	12	12.2	-	3
JCTER/L1212-1.4T12	1.4	1	24	12	12	125	19.5	12	12.2	-	3
JCTER/L1414-1.4T12	1.4	1	24	14	14	125	19.5	14	14.2	-	3
JCTER/L1616X1.4T16	1.4	1	32	16	16	120	24	16	16.2	-	3
JCTER/L1010X2T10	2	2	20	10	10	120	19	10	10.1	2	3
JCTER/L1212F2T12	2	2	24	12	12	85	19	12	12.1	2	3
JCTER/L1212X2T12	2	2	24	12	12	120	19	12	12.1	2	3
JCTER/L1414-2T12	2	2	24	14	14	125	19	14	14.1	-	3
JCTER/L1616X2T16	2	2	32	16	16	120	24	16	16.1	-	3
JCTER/L1212F3T12	3	3	24	12	12	85	19	12	12.3	2	3
JCTER/L1212X3T12	3	3	24	12	12	120	19	12	12.3	2	3
JCTER/L1616X3T16	3	3	32	16	16	120	24	16	16.3	-	3
JCTER/L2020H3T16	3	3	32	20	20	100	24	20	20.3	-	3

(1) "WF" value is calculated with groove width "CW" shown in the table.

CUTDIA: Max. parting diameter

Torque: Recommended clamping torque: lbs-ft (*N-m)

SPARE PARTS

Designation	Clamping screw	Wrench
JCTER/L...	CSHB-4-A	T-15F

External grooving and parting toolholder with high pressure coolant capability

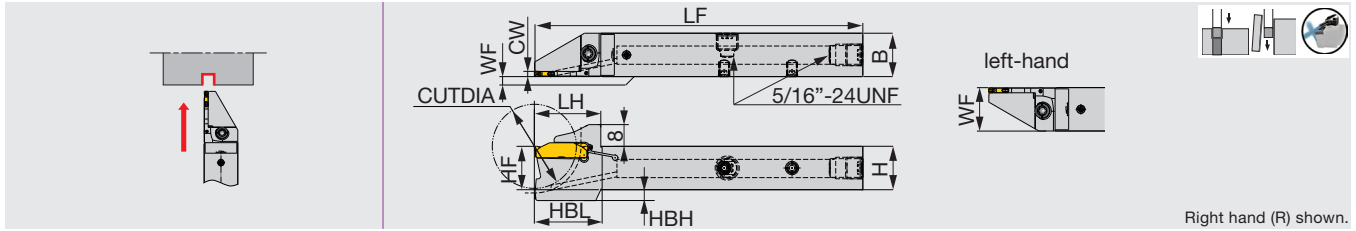

Inch	CW (in)	CW (mm)	Seat size	CUTDIA	H	B	LF	LH	HBL	HF	WF ⁽¹⁾	HBH	Torque
JCTER/L08X2T12-CHP	0.079	2	2	0.984	0.500	0.500	4.750	0.972	0.965	0.500	0.000/0.500	0.169	2.21
JCTER/L10X2T12-CHP	0.079	2	2	0.984	0.625	0.625	4.750	0.972	0.965	0.625	0.000/0.625	0.039	2.21
JCTER/L10X2T16-CHP	0.079	2	2	1.260	0.625	0.625	4.750	0.972	0.965	0.625	0.000/0.625	0.157	2.21
JCTER/L12X2T16-CHP	0.079	2	2	1.260	0.750	0.750	4.750	0.972	0.965	0.750	0.000/0.750	0.037	2.21

Metric	CW	Seat size	CUTDIA	H	B	LF	LH	HF	WF ⁽¹⁾	HBH	HBL	Torque*
JCTER/L1212X2T12-CHP	2	2	25	12	12	120	24.7	12	0/12	5	24.7	3
JCTER/L1616X2T12-CHP	2	2	25	16	16	120	24.7	16	0/16	1	24.5	3
JCTER/L1616X2T16-CHP	2	2	32	16	16	120	24.7	16	0/16	4	24.7	3
JCTER/L2020X2T16-CHP	2	2	32	20	20	120	24.7	20	0/20	-	-	3

(1) "WF" value is calculated with groove width "CW" shown in the table. "WF" value depends on the tool hand. With 0.000/0.500 (0/12), WF is 0" (0 mm) for the right hand and 0.5" (12 mm) for the left hand.

CUTDIA: Max. parting diameter

Torque: Recommended clamping torque: lbs-ft (*N·m)

SPARE PARTS

Designation	Clamping screw	Wrench 1	Coolant plug	Wrench 2	DirectJet plug	Wrench 3
JCTER/L...	CSHB-4-A	T-15F	SR5/16UNFTL360	P-4	SSHM4-6-TB	P-2

Groove width: 0.079" (2.0 mm)



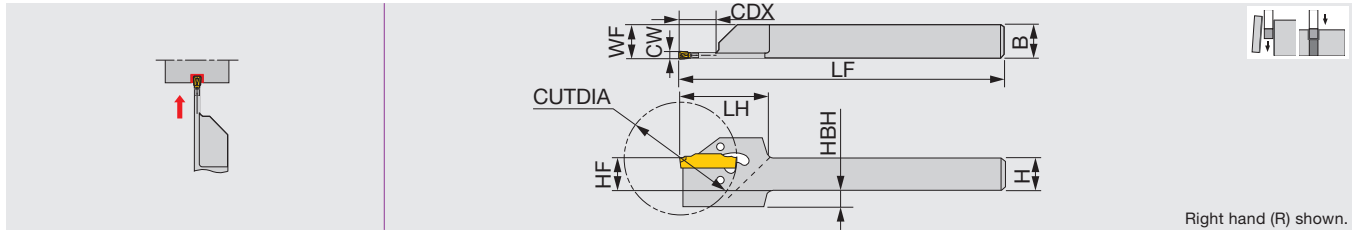

Right hand (R) shown.

Metric	CW	Seat size	CUTDIA ⁽¹⁾	CDX	H	B	LF	LH	HF	WF ⁽²⁾	HBH
CGER/L2020-1.4T14	1.4	1	29/29	9.7	20	20	125	31	20	20.2	-
CGER/L1212-2T17	2	2	35/35	11.8	12	12	150	31	12	12.1	6
CGER/L1616-2T17	2	2	35/35	11.8	16	16	150	31	16	16.1	2
CGER/L2020-2T17	2	2	35/35	9.8	20	20	125	31	20	20.1	-
CGER/L1212-3T19	3	3	38/40	12	12	12	150	31	12	12.3	6
CGER/L1616-3T19	3	3	38/45	14.9	16	16	150	31	16	16.3	2
CGER/L2020-3T19	3	3	38/45	13.2	20	20	125	31	20	20.3	-
CGER/L2020-4T19	4	4	38/55	20.3	20	20	125	33	20	20.4	-

Wrench (CRW**) is not included. Please order it separately. Insert is clamped by the elastic deformation of the upper jaw.

(1) DG*/SG* maximum parting diameter will depend on the insert.

(2) "WF" value is calculated with groove width "CW" shown in the table.

SPARE PARTS



Designation	Wrench (Option)
CGER/L2020-1.4T14	CRW23
CGER/L****-2T17 - 4T19	CRW33

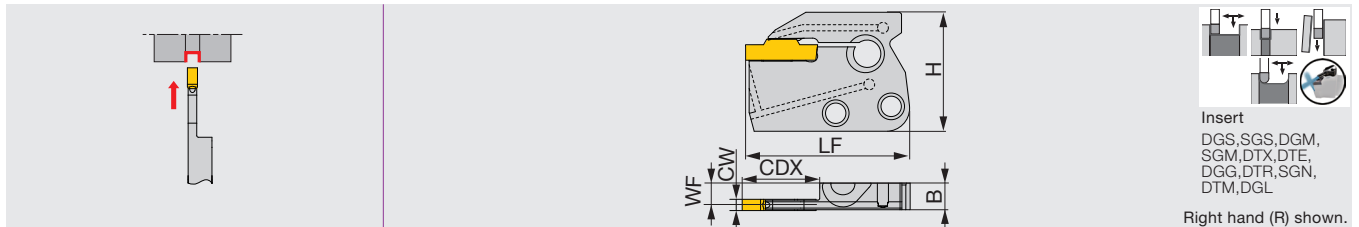

Insert
DGS, SGS, DGM,
SGM, DTX, DTE,
DGG, DTR, SGN,
DTM, DGL

Right hand (R) shown.

Inch	CW (in)	CW (mm)	Seat size	CDX	H	B	LF	WF
CAER/L-2T16-CHP	0.079	2	2	0.630	1.299	0.283	1.634	0.248
CAER/L-2T20-CHP	0.079	2	2	0.787	1.299	0.283	1.791	0.248
CAER/L-3T16-CHP	0.118	3	3	0.630	1.299	0.283	1.634	0.232
CAER/L-3T20-CHP	0.118	3	3	0.787	1.299	0.283	1.791	0.236
CAER/L-4T16-CHP	0.157	4	4	0.630	1.299	0.283	1.634	0.224
CAER/L-4T20-CHP	0.157	4	4	0.787	1.299	0.283	1.791	0.224
CAER/L-5T20-CHP	0.197	5	5	0.787	1.299	0.283	1.823	0.209
CAER/L-6T20-CHP	0.236	6	6	0.787	1.299	0.283	1.823	0.189

When groove depth is larger than (insert length - 0.059"), please use 1-cornered insert.

Shank for CAER/L-CHP blades with high pressure coolant capability

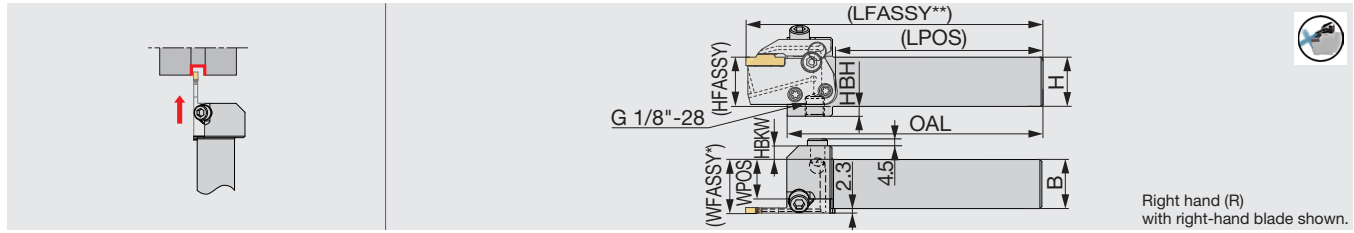

Inch	H	B	OAL	LPOS	WPOS	HBKW	HFASSY	HBH	Blade (Option)	Torque
CHSR/L12-CHP	0.750	0.750	5.000	4.035	0.560	0.510	0.750	0.190	CAER/L-CHP	3.69
CHSR/L16-CHP	1.000	1.000	5.000	4.035	0.810	0.260	1.000	0.200	CAER/L-CHP	3.69

Metric	H	B	OAL	LPOS	WPOS	HBKW	HFASSY	HBH	Blade (Option)	Torque*
CHSR/L2020-CHP	20	20	130	105.5	15.1	12	20	10	CAER/L-CHP	5
CHSR/L2525-CHP	25	25	130	105.5	20.1	7	25	5	CAER/L-CHP	5

*WFASSY : Shank (WPOS) + blade (WF)
 **LFASSY : Shank (LPOS) + blade (LF)

Please see the page **L043** for the instruction on installing and removing the blade or the insert.
 Torque: Recommended clamping torque: lbs·ft (*N·m)
 Use right-hand blades (R) with right-hand shanks (R); and left-hand blades (L) with left-hand shanks (L).
 Applicable for 30 MPa coolant

SPARE PARTS

Designation	Clamping screw 1	Wrench 1	Clamping screw 2	Clamping screw 3	Wrench 2	O-ring	Plug
CHSR/L...-CHP	SRM5-04451	T-20/5	SRM6X12DIN6912	SRM6X20-XT	HW5.0	OR5X1N	PLUGG1/8ISO1179

Recommended clamping torque (lbs-ft, N·m)

Clamping screw	Torque (lbs-ft)	Torque (N·m)
SRM5-04451	3.69	5
SRM6X12DIN6912	6.27	8.5
SRM6X20-XT	6.27	8.5

Reference pages: Inserts → **F023 - F036**, Standard cutting conditions → **F032**
 Parts for coolant hose → **F240**, Technical Reference → **L043**



Shank for CAER/L-CHP blades with high pressure coolant capability

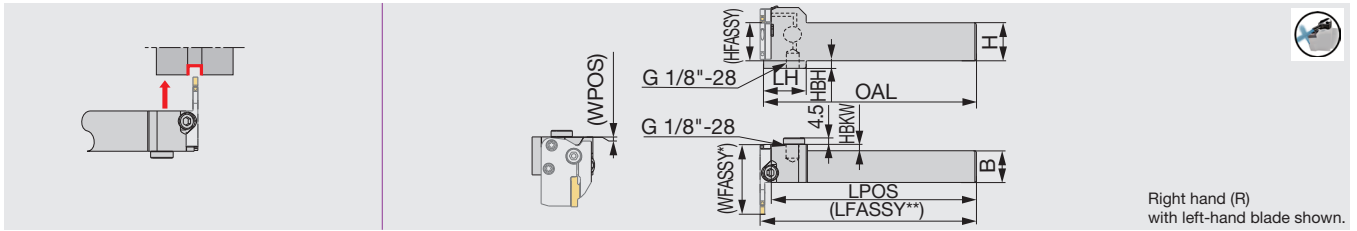

Right hand (R)
with left-hand blade shown.

Inch	H	B	OAL	LH	LPOS	WPOS	HBKW	HFASSY	HBH	Blade (Option)	Torque
CHFVR/L12-CHP	0.750	0.750	5.500	1.100	5.307	0.020	0.234	0.750	0.431	CAER/L-CHP	3.69
CHFVR/L16-CHP	1.000	1.000	5.500	1.100	5.307	0.020	-	1.000	0.200	CAER/L-CHP	3.69

Metric	H	B	OAL	LH	LPOS	WPOS	HBKW	HFASSY	HBH	Blade (Option)	Torque*
CHFVR/L2020-CHP	20	20	140	28	135.1	0.5	5	20	10	CAER/L-CHP	5
CHFVR/L2525-CHP	25	25	140	28	135.1	0.5	0	25	5	CAER/L-CHP	5

*WFASSY : Shank (WPOS) + blade (LF)

**LFASSY : Shank (LPOS) + blade (WF)

Torque: Recommended clamping torque: lbs-ft (*N·m)

Use right-hand blades (R) with left-hand shanks (L); and left-hand blades (L) with right-hand shanks (R).

Applicable for 30 MPa coolant

Please see the page **L043** for the instruction on installing and removing the blade or the insert.

SPARE PARTS

Designation	Clamping screw 1	Wrench 1	Clamping screw 2	Clamping screw 3	Wrench 2	O-ring	Plug
CHFVR/L...	SRM5-04451	T-20/5	SRM6X12DIN6912	SRM6X20-XT	HW5.0	OR5X1N	PLUGG1/8ISO1179

Recommended clamping torque (lbs-ft, N·m)

Clamping screw	Torque (lbs-ft)	Torque (N·m)
SRM5-04451	3.69	5
SRM6X12DIN6912	6.27	8.5
SRM6X20-XT	6.27	8.5

Reference pages: Inserts → **F023 - F036**, Standard cutting conditions → **F032**
Parts for coolant hose → **F240**, Technical Reference → **L043**

TungCap shank for CAER/L-CHP blades with high pressure coolant capability

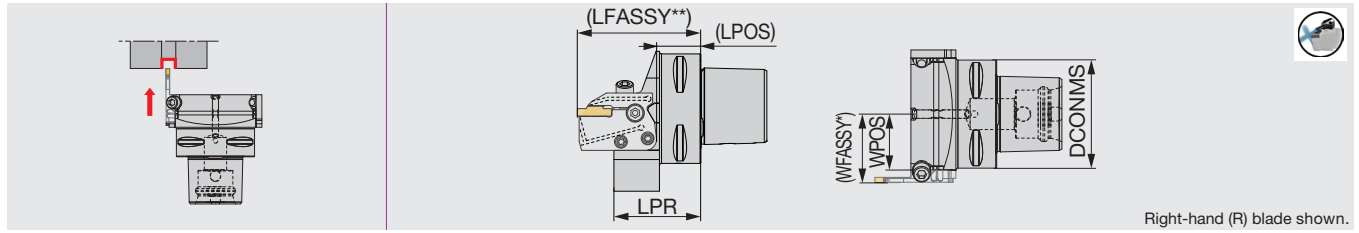

Right-hand (R) blade shown.

Metric	DCONMS	LPR	LPOS	WPOS	Blade (Option)	Torque
C3CHSN19045-CHP	32	45	17.5	18.5	CAER/L...-CHP	5
C4CHSN21047-CHP	40	46.5	21.5	21	CAER/L...-CHP	5
C5CHSN26047-CHP	50	47	22.5	26	CAER/L...-CHP	5
C6CHSN33050-CHP	63	50	24.5	32.5	CAER/L...-CHP	5

*WFASSY : Shank (WPOS) + blade (WF)

**LFASSY : Shank (LPOS) + blade (LF)

Torque: Recommended clamping torque: N·m, Applicable for 30 MPa coolant

Please see the page L043 for the instruction on installing and removing the blade or the insert.

SPARE PARTS

Designation	Clamping screw 1	Wrench 1	Clamping screw 2	Clamping screw 3	Wrench 2	O-ring
C*CHSN...-CHP	SRM5-04451	T-20/5	SRM6X12DIN6912	SRM6X20-XT	HW5.0	OR5X1N

Recommended clamping torque (N·m)

Clamping screw	Torque (N·m)
SRM5-04451	5
SRM6X12DIN6912	8.5
SRM6X20-XT	8.5

TungCap shank for CAER/L-CHP blades with high pressure coolant capability

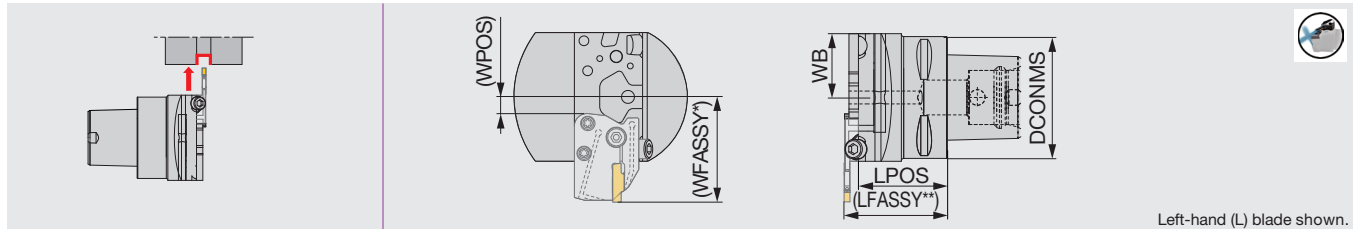

Left-hand (L) blade shown.

Metric	DCONMS	LPOS	WB	WPOS	Blade (Option)	Torque
C3CHFVN26040-CHP	32	40	26	1.5	CAER/L...-CHP	5
C4CHFVN26046-CHP	40	46	26	1.5	CAER/L...-CHP	5
C5CHFVN26046-CHP	50	46	26	1.5	CAER/L...-CHP	5
C6CHFVN33046-CHP	63	46	33	8.5	CAER/L...-CHP	5

*WFASSY : Shank (WPOS) + blade (LF)

**LFASSY : Shank (LPOS) + blade (WF)

Torque: Recommended clamping torque: N·m. Applicable for 30 MPa coolant

Please see the page L043 for the instruction on installing and removing the blade or the insert.

SPARE PARTS

Designation	Clamping screw 1	Wrench 1	Clamping screw 2	Clamping screw 3	Wrench 2	O-ring
C*CHFVN...-CHP	SRM5-04451	T-20/5	SRM6X12DIN6912	SRM6X20-XT	HW5.0	OR5X1N

Recommended clamping torque (N·m)

Clamping screw	Torque (N·m)
SRM5-04451	5
SRM6X12DIN6912	8.5
SRM6X20-XT	8.5

Reference pages: Inserts → F023 - F036, Standard cutting conditions → F032, Technical Reference → L043

External grooving, parting, and turning blade

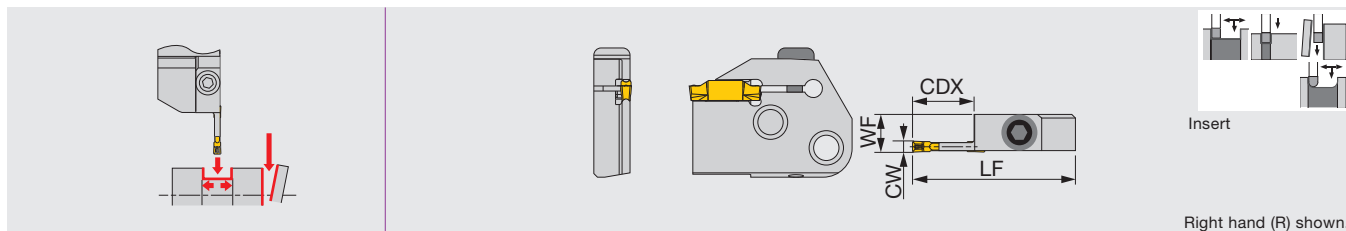

Inch	CW (in)	CW (mm)	Seat size	CDX	LF	WF	Shank	Torque
CAER/L-3T16	0.118	2	2	0.630	1.772	0.409	CHFVL/R...,CHSR/L...	3.69
CAER/L-4T16	0.157	2	2	0.630	1.772	0.413	CHFVL/R...,CHSR/L...	3.69
CAER/L-5T20	0.197	3	3	0.787	1.929	0.413	CHFVL/R...,CHSR/L...	3.69
CAER/L6T20	0.236	3	3	0.787	1.929	0.413	CHFVL/R...,CHSR/L...	3.69

Torque: Recommended clamping torque: lbs-ft
 Not compatible with TungModularSystem
 When groove depth is larger than insert length - 0.059", please use 1-cornered insert.

SPARE PARTS

Designation	Clamping screw	Wrench
CAER/L...	BHM6-20-A	P-4

Shank for CAER/L and CAFR/L blades

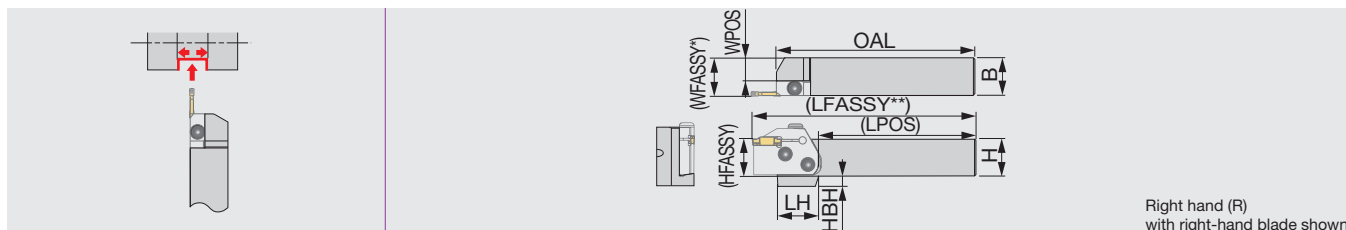

Inch	H	B	OAL	LPOS	LH	WPOS	HFASSY	HBH	Blade (Option)
CHSR/L12-U	0.750	0.750	5.330	4.227	1.380	0.356	0.750	0.502	CAER/L...
CHSR/L16-U	1.000	1.000	5.330	4.227	1.100	0.606	1.000	0.280	CAER/L...
CHSR/L20-U	1.250	1.250	6.330	5.227	-	0.856	1.250	-	CAER/L...

Metric	H	B	OAL	LPOS	LH	WPOS	HFASSY	HBH	Blade (Option)
CHSR/L2020	20	20	133	105	35	10	20	12	CAER/L...
CHSR/L2525	25	25	133	105	28	15	25	7	CAER/L...
CHSR/L3232	32	32	153	105	-	22	32	-	CAER/L...

*WFASSY : Shank (WPOS) + blade (WF)

**LFASSY : Shank (LPOS) + blade (LF)

Not compatible with TungModularSystem

SPARE PARTS

Designation	Clamping screw	Wrench
CHSR/L...	CSHB-6-A	P-4

Combination of blade and toolholder

Toolholder	Blade			
	CAER...	CAEL...	CAFR...	CAFL...
CHSR...	●			●
CHSL...		●	●	

● : Corresponding

Reference pages: Inserts → **F023 - F036**, Standard cutting conditions → **F032**

Shank for CAER/L and CAFR/L blades

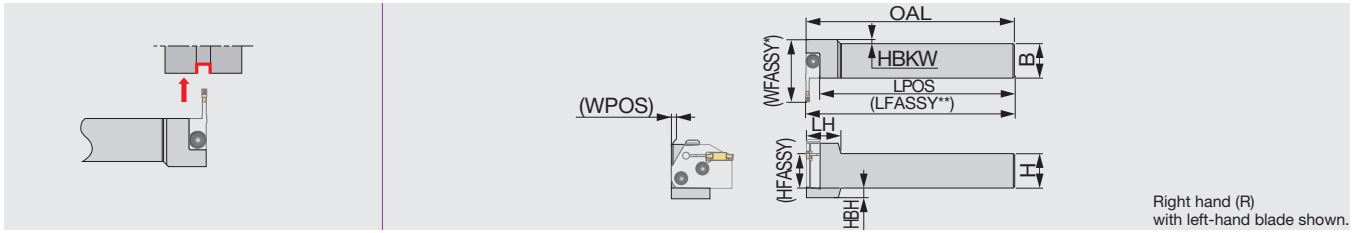

Inch	H	B	OAL	LPOS	LH	WPOS	HBKW	HFASSY	HBH	Blade (Option)
CHFVR/L12-U	0.750	0.750	6.000	5.606	0.984	-0.001	0.352	0.750	0.502	CAEL/R...
CHFVR/L16-U	1.000	1.000	6.000	5.606	0.984	-0.001	0.102	1.000	0.276	CAEL/R...
CHFVR/L20-U	1.250	1.250	7.000	6.606	0.984	0.147	-	1.250	-	CAEL/R...

Metric	H	B	OAL	LPOS	LH	WPOS	HBKW	HFASSY	HBH	Blade (Option)
CHFVR/L2020	20	20	150	140	25	0	8	20	12	CAEL/R...
CHFVR/L2525	25	25	150	140	25	0	3	25	7	CAEL/R...
CHFVR/L3232	32	32	170	160	25	4	-	32	-	CAEL/R...

*WFASSY : Shank (WPOS) + blade (LF)

**LFASSY : Shank (LPOS) + blade (WF)

Not compatible with TungModularSystem

SPARE PARTS

Designation	Clamping screw	Wrench
CHFVR/L...	CSHB-6-A	P-4

Combination of blade and toolholder

Toolholder	Blade			
	CAER...	CAEL...	CAFR...	CAFL...
CHFVR...		●	●	
CHFVL...	●			●

● : Corresponding



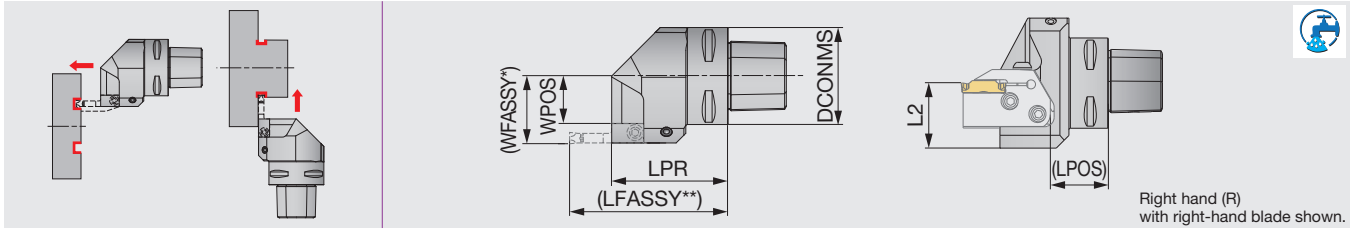

Right hand (R)
with right-hand blade shown.

Metric	DCONMS	LPR	LPOS	L2	WPOS	Blade (Option)
C3CHSR/L22050N	32	50	22.1	35	11.5	CAER/L...
C4CHSR/L27050N	40	50	22.1	36	16.5	CAER/L...
C5CHSR/L35060N	50	60	32.1	36	24.5	CAER/L...
C6CHSR/L45065N	63	65	32.1	41	34.5	CAER/L...

*WFASSY : Shank (WPOS) + blade (WF)

**LFASSY : Shank (LPOS) + blade (LF)

Applicable for 7 MPa coolant.

Not compatible with TungModularSystem

SPARE PARTS

Designation	Coolant parts	Clamping screw	Wrench
C3CHSR/L22050N	SATZ-M8X1-M3	CSHB-6-A	P-4
C4CHSR/L27050N	SATZ-M8X1-M3	CSHB-6-A	P-4
C5CHSR/L35060N	SATZ-M10X1-M5	CSHB-6-A	P-4
C6CHSR/L45065N	SATE-M10X1-M5	CSHB-6-A	P-4



External



Internal



Face



Parting



Others

C-CHFVR/L

TungCap shank for CAER/L and CAFR/L blades

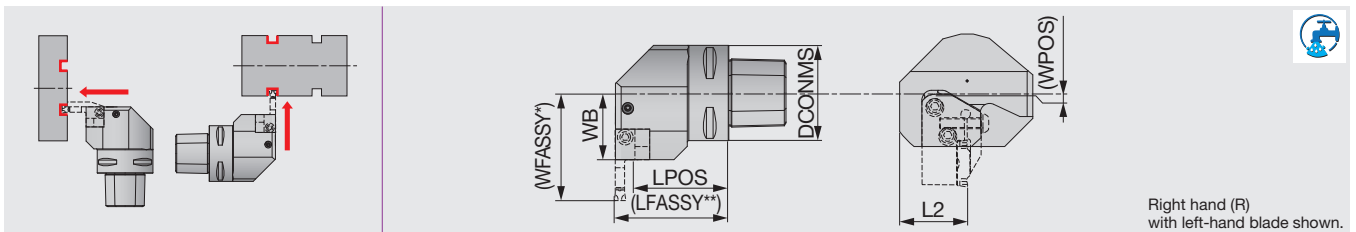

Right hand (R)
with left-hand blade shown.

Metric	DCONMS	LPOS	L2	WB	WPOS	Blade (Option)
C3CHFVR/L22040N	32	32.5	35	22	-5.9	CAEL/R...
C4CHFVR/L27050N	40	42.5	36	27	-0.9	CAEL/R...
C5CHFVR/L35060N	50	49.5	36	35	7.1	CAEL/R...
C6CHFVR/L45065N	63	54.5	41	45	17.1	CAEL/R...

*WFASSY : Shank (WPOS) + blade (LF)

**LFASSY : Shank (LPOS) + blade (WF)

Applicable for 7 MPa coolant.

Not compatible with TungModularSystem

SPARE PARTS

Designation	Coolant parts	Clamping screw	Wrench
C3CHFVR/L22040N	SATZ-M8X1-M3	CSHB-6-A	P-4
C4CHFVR/L27050N	SATZ-M8X1-M3	CSHB-6-A	P-4
C5CHFVR/L35060N	SATZ-M10X1-M5	CSHB-6-A	P-4
C6CHFVR/L45065N	SATZ-M10X1-M5	CSHB-6-A	P-4

Combination of blade and toolholder

Toolholder	Blade			
	CAER...	CAEL...	CAFR...	CAFV...
C*CHSR...	●			●
C*CHSL...		●	●	
C*CHFVR...		●	●	
C*CHFVL...	●			●

● : Corresponding

Reference pages: Inserts → **F023 - F036**, Standard cutting conditions → **F032**

INSERT

DGM

External grooving and parting, 2 corners

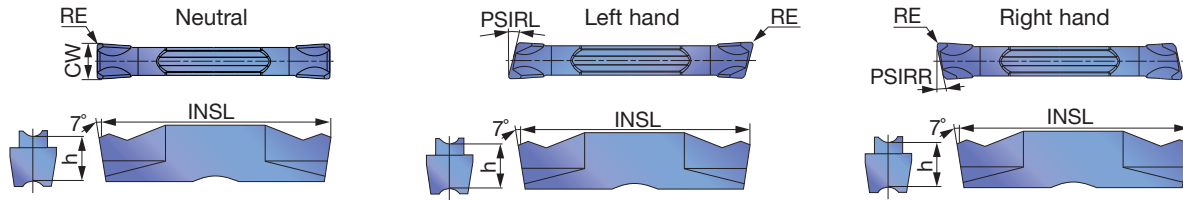

P	Steel	★	★	★	☆	☆	★						
M	Stainless	★		★	☆		★						
K	Cast iron	☆		★		☆	☆			☆			
N	Non-ferrous												
S	Superalloys			★	☆	★							
H	Hard materials												

★ : First choice
☆ : Second choice

Designation	Seat size	HAND	CW±0.05 (mm)	CW±0.002 (in)	RE (in)	Coated						Cermet		INSL (in)	h (in)	PSIRL	PSIRR
						T9225	T9125	AH7025	AH725	AH905	GH130	NS9530					
DGM2-020	2	N	2	0.079	0.008	●	▲	●	●	●	●	●		0.787	0.197	0°	0°
DGM2-020-6R	2	R	2	0.079	0.008			●	●	●	●			0.780	0.197	0°	6°
DGM2-020-6L	2	L	2	0.079	0.008			●	●	●	●			0.780	0.197	6°	0°
DGM2-020-8R	2	R	2	0.079	0.008			●	●	●	●			0.780	0.197	0°	8°
DGM2-020-8L	2	L	2	0.079	0.008			●	●	●	●			0.780	0.197	8°	0°
DGM2-020-15R	2	R	2	0.079	0.008			●	●	●	●			0.780	0.197	0°	15°
DGM2-020-15L	2	L	2	0.079	0.008			●	●	●	●			0.780	0.197	15°	0°
DGM2-002-15R	2	R	2	0.079	0.0008			●	●	●	●			0.762	0.197	0°	15°
DGM2-002-15L	2	L	2	0.079	0.0008			●	●	●	●			0.762	0.197	15°	0°
DGM3-020	3	N	3	0.118	0.008	●	▲	●	●	●	●	●		0.787	0.197	0°	0°
DGM3-020-6R	3	R	3	0.118	0.008			●	●	●	●			0.783	0.197	0°	6°
DGM3-020-6L	3	L	3	0.118	0.008			●	●	●	●			0.783	0.197	6°	0°
DGM3-002-6R	3	R	3	0.118	0.0008			●	●	●	●			0.766	0.197	0°	6°
DGM3-002-6L	3	L	3	0.118	0.0008			●	●	●	●			0.766	0.197	6°	0°
DGM3-020-15R	3	R	3	0.118	0.008			●	●	●	●			0.783	0.197	0°	15°
DGM3-020-15L	3	L	3	0.118	0.008			●	●	●	●			0.783	0.197	15°	0°
DGM4-030	4	N	4	0.157	0.012	●	▲	●	●	●	●	●		0.787	0.197	0°	0°
DGM4-030-4R	4	R	4	0.157	0.012			●	●	●	●			0.780	0.197	0°	4°
DGM4-030-4L	4	L	4	0.157	0.012			●	●	●	●			0.780	0.197	4°	0°
DGM4-030-15R	4	R	4	0.157	0.012			●	●	●	●			0.780	0.197	0°	15°
DGM4-030-15L	4	L	4	0.157	0.012			●	●	●	●			0.780	0.197	15°	0°
DGM5-030	5	N	5	0.197	0.012	●	▲	●	●	●	●	●		0.984	0.217	0°	0°
DGM5-030-4R	5	R	5	0.197	0.012			●	●	●	●			0.980	0.217	0°	4°
DGM6-030	6	N	6	0.236	0.012	●	▲	●	●	●	●	●		0.984	0.217	0°	0°
DGM8-040	8	N	8	0.315	0.016	●	▲	●	●	●	●	●		1.181	0.264	0°	0°

● : Line up
▲ : To be discontinued



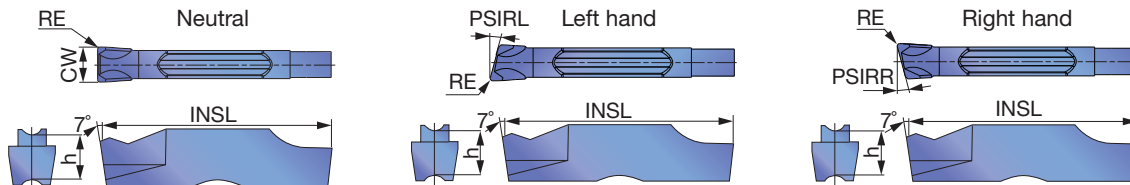

P	Steel	★	☆	☆								
M	Stainless	★	☆	★								
K	Cast iron	★		☆								
N	Non-ferrous											
S	Superalloys	★	☆									
H	Hard materials											

★ : First choice
☆ : Second choice

Designation	Seat size	HAND	CW±0.05 (mm)	CW±0.002 (in)	RE (in)	Coated						INSL (in)	h (in)	PSIRL	PSIRR	
						AH7025	AH725	GH130								
SGM2-020	2	N	2	0.079	0.008	●	●	●					0.787	0.197	0°	0°
SGM2-020-6R	2	R	2	0.079	0.008	●	●	●					0.787	0.197	0°	6°
SGM2-020-6L	2	L	2	0.079	0.008	●	●	●					0.787	0.197	6°	0°
SGM3-020	3	N	3	0.118	0.008	●	●	●					0.787	0.197	0°	0°
SGM3-020-6R	3	R	3	0.118	0.008	●	●	●					0.787	0.197	0°	6°
SGM3-020-6L	3	L	3	0.118	0.008	●	●	●					0.787	0.197	6°	0°
SGM3-020-15R	3	R	3	0.118	0.008	●	●	●					0.787	0.197	0°	15°
SGM3-020-15L	3	L	3	0.118	0.008	●	●	●					0.787	0.197	15°	0°
SGM4-030	4	N	4	0.157	0.012	●	●	●					0.787	0.197	0°	0°
SGM4-030-4R	4	R	4	0.157	0.012	●	●	●					0.787	0.197	0°	4°
SGM4-030-4L	4	L	4	0.157	0.012	●	●	●					0.787	0.197	4°	0°
SGM5-030	5	N	5	0.197	0.012	●	●	●					0.984	0.217	0°	0°
SGM6-030	6	N	6	0.236	0.012	●	●	●					0.984	0.217	0°	0°

● : Line up

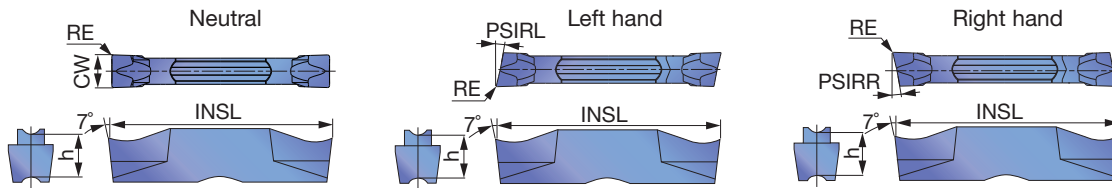

P	Steel	★	★	★	☆	☆			★				
M	Stainless	★		★	☆	★							
K	Cast iron	☆		★	☆				☆				
N	Non-ferrous												
S	Superalloys				★	☆							
H	Hard materials												

★ : First choice
☆ : Second choice

Designation	Seat size	HAND	CW±0.05 (mm)	CW±0.002 (in)	RE (in)	Coated					Cermet		INSL (in)	h (in)	PSIRL	PSIRR
						T9225	T9125	AH7025	AH725	GH130	NS9530					
DGS1.4-016	1	N	1.4	0.055	0.006								0.630	0.169	0°	0°
DGS2-020	2	N	2	0.079	0.008	●	▲	●	●	●	●		0.787	0.197	0°	0°
DGS2-020-6R	2	R	2	0.079	0.008			●	●	●			0.785	0.197	0°	6°
DGS2-020-6L	2	L	2	0.079	0.008			●	●	●			0.785	0.197	6°	0°
DGS2-002-6R	2	R	2	0.079	0.0008			●	●	●			0.768	0.197	0°	6°
DGS2-002-6L	2	L	2	0.079	0.0008			●	●	●			0.768	0.197	6°	0°
DGS2-020-15R	2	R	2	0.079	0.008			●	●	●			0.785	0.197	0°	15°
DGS2-020-15L	2	L	2	0.079	0.008			●	●	●			0.785	0.197	15°	0°
DGS2-002-15R	2	R	2	0.079	0.0008			●	●	●			0.768	0.197	0°	15°
DGS2-002-15L	2	L	2	0.079	0.0008			●	●	●			0.768	0.197	15°	0°
DGS3-020	3	N	3	0.118	0.008	●	▲	●	●	●	●		0.787	0.197	0°	0°
DGS3-020-6R	3	R	3	0.118	0.008			●	●	●			0.783	0.197	0°	6°
DGS3-020-6L	3	L	3	0.118	0.008			●	●	●			0.783	0.197	6°	0°
DGS3-002-6R	3	R	3	0.118	0.0008			●	●	●			0.766	0.197	0°	6°
DGS3-002-6L	3	L	3	0.118	0.0008			●	●	●			0.766	0.197	6°	0°
DGS3-020-15R	3	R	3	0.118	0.008			●	●	●			0.783	0.197	0°	15°
DGS3-020-15L	3	L	3	0.118	0.008			●	●	●			0.783	0.197	15°	0°
DGS3-002-15R	3	R	3	0.118	0.0008			●	●	●			0.766	0.197	0°	15°
DGS3-002-15L	3	L	3	0.118	0.0008			●	●	●			0.766	0.197	15°	0°
DGS4-030	4	N	4	0.157	0.012	●	▲	●	●	●	●		0.787	0.197	0°	0°
DGS4-030-4R	4	R	4	0.157	0.012			●	●	●			0.780	0.197	0°	4°
DGS4-030-4L	4	L	4	0.157	0.012			●	●	●			0.781	0.197	4°	0°
DGS5-030	5	N	5	0.197	0.012	●	▲	●	●	●	●		0.984	0.217	0°	0°
DGS6-030	6	N	6	0.236	0.012	●	▲	●	●	●	●		0.984	0.217	0°	0°

● : Line up
▲ : To be discontinued

Caution

The tool will interfere with the workpiece when grooving larger diameter than øDmax.

Designation	øDmax (in)	Designation	øDmax (in)
DGM2-002-15R/L	1.102	DGS2-002-15R/L	1.102
DGM3-002-15R/L	1.141	DGS3-002-15R/L	1.141
DGM4-030-15R/L	1.181	SGS3-020-15R/L	4.055
SGM3-020-15R/L	4.055	SGS3-002-15R/L	1.338

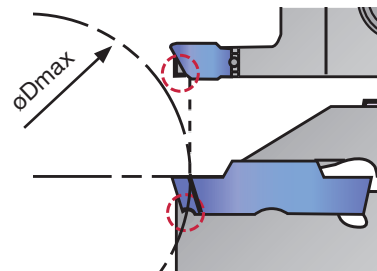

SGS

External deep grooving and parting, 1 corner

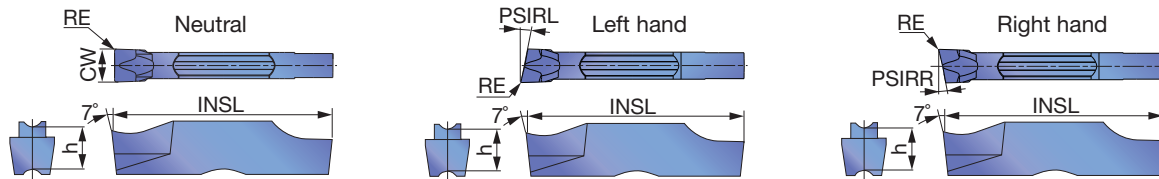

P	Steel	★	☆	☆									
M	Stainless	★	☆	★									
K	Cast iron	★		☆									
N	Non-ferrous												
S	Superalloys	★	☆										
H	Hard materials												

★ : First choice
☆ : Second choice

Designation	Seat size	HAND	CW±0.05 (mm)	CW±0.002 (in)	RE (in)	Coated			INSL (in)	h (in)	PSIRL	PSIRR
						AH7025	AH725	GH130				
SGS2-020	2	N	2	0.079	0.008	●	●	●	0.787	0.197	0°	0°
SGS2-020-6R	2	R	2	0.079	0.008	●	●	●	0.787	0.197	0°	6°
SGS2-020-6L	2	L	2	0.079	0.008	●	●	●	0.787	0.197	6°	0°
SGS2-020-15R	2	R	2	0.079	0.008	●	●	●	0.787	0.197	0°	15°
SGS2-020-15L	2	L	2	0.079	0.008	●	●	●	0.787	0.197	15°	0°
SGS3-020	3	N	3	0.118	0.008	●	●	●	0.787	0.197	0°	0°
SGS3-020-6R	3	R	3	0.118	0.008	●	●	●	0.787	0.197	0°	6°
SGS3-020-6L	3	L	3	0.118	0.008	●	●	●	0.787	0.197	6°	0°
SGS3-002-6R	3	R	3	0.118	0.0008		●	●	0.780	0.197	0°	6°
SGS3-002-6L	3	L	3	0.118	0.0008		●	●	0.780	0.197	6°	0°
SGS3-020-15R	3	R	3	0.118	0.008	●	●	●	0.787	0.197	0°	15°
SGS3-020-15L	3	L	3	0.118	0.008	●	●	●	0.787	0.197	15°	0°
SGS3-002-15R	3	R	3	0.118	0.0008		●	●	0.780	0.197	0°	15°
SGS3-002-15L	3	L	3	0.118	0.0008		●	●	0.780	0.197	15°	0°
SGS4-030	4	N	4	0.157	0.012	●	●	●	0.787	0.197	0°	0°
SGS5-030	5	N	5	0.197	0.012	●	●	●	0.984	0.217	0°	0°
SGS6-030	6	N	6	0.236	0.012	●	●	●	0.984	0.217	0°	0°

● : Line up

DGL

External grooving and parting

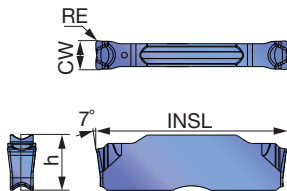

P	Steel	★										
M	Stainless	★										
K	Cast iron	★										
N	Non-ferrous											
S	Superalloys	★										
H	Hard materials											

★ : First choice
☆ : Second choice

Designation	Seat size	CW±0.05 (mm)	CW±0.002 (in)	RE (in)	Coated			INSL (in)	h (in)
					AH7025				
DGL3-025	3	3	0.118	0.010	●			0.787	0.197
DGL4-030	4	4	0.157	0.012	●			0.787	0.197
DGL5-030	5	5	0.197	0.012	●			0.984	0.217
DGL6-080	6	6	0.236	0.031	●			0.984	0.217

● : Line up

Reference pages: Toolholders → F010 - F022, Standard cutting conditions → F032

DGG

External grooving (for high precision)

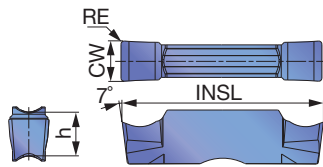

P	Steel	★		★						
M	Stainless	★								
K	Cast iron	★		☆			☆			
N	Non-ferrous						★			
S	Superalloys	★					☆			
H	Hard materials									

★ : First choice
☆ : Second choice

Designation	Seat size	CW±0.02 (mm)	CW±0.0008 (in)	RE (in)	Coated			Cermet			Uncoated			INSL (in)	h (in)
					AH7025			NS9530			KS05F				
DGG200-020	2	2	0.079	0.008	●			●			●			0.787	0.197
DGG300-020	3	3	0.118	0.008	●			●			●			0.787	0.197
DGG400-040	4	4	0.157	0.016	●			●			●			0.787	0.197
DGG500-040	5	5	0.197	0.016	●			●			●			0.984	0.217
DGG600-040	6	6	0.236	0.016	●			●			●			0.984	0.217

● : Line up

DGE

External grooving (for high precision)

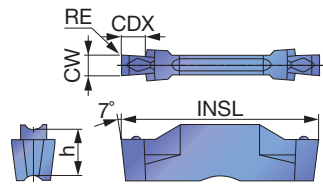

P	Steel	★	☆	☆				★				
M	Stainless	★	☆	★								
K	Cast iron	★		☆				☆				
N	Non-ferrous											
S	Superalloys	★	☆									
H	Hard materials											

★ : First choice
☆ : Second choice

Designation	Seat size	CW±0.05 (mm)	CW±0.0008 (in)	RE (in)	Coated			Cermet			CDX (in)	INSL (in)	h (in)	
					AH7025	AH725	GH130	NS9530						
DGE100-000	2	1	0.039	0		●	●		●			0.098	0.787	0.197
DGE130-000	2	1.3	0.051	0		●	●		●			0.098	0.787	0.197
DGE160-010	2	1.6	0.063	0.004	●	●	●		●			0.098	0.787	0.197
DGE185-010	2	1.85	0.073	0.004	●	●	●		●			0.138	0.787	0.197
DGE215-015	2	2.15	0.085	0.006	●	●	●		●			0.138	0.787	0.197

● : Line up

Caution

øDmax is limited as shown in the picture to the right according to the groove depth, T. Please refer to the following table.

T = Groove depth

Designation	Max. groove depth (in)	øDmax (in)				
		T = 0.039	T = 0.059	T = 0.079	T = 0.098	T = 0.118
DGE100-000	0.079	∞	0.73	0.45	-	-
DGE130-000					-	-
DGE160-010					-	-
DGE185-010	0.118				0.35	0.28
DGE215-015						

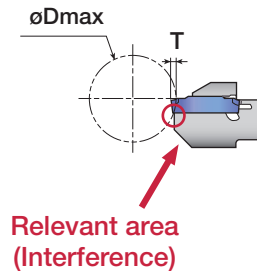

DTM

External face grooving and turning

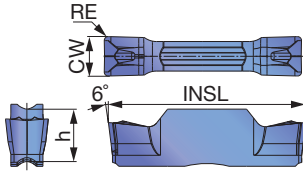

P	Steel	★								
M	Stainless	★								
K	Cast iron	★								
N	Non-ferrous									
S	Superalloys	★								
H	Hard materials									

★ : First choice
☆ : Second choice

Designation	Seat size	CW±0.05 (mm)	CW±0.002 (in)	RE (in)	Coated						INSL (in)	h (in)	
					AH7025								
DTM3-030	3	3	0.118	0.012	●							0.787	0.197
DTM4-040	4	4	0.157	0.016	●							0.787	0.197
DTM4-080	4	4	0.157	0.031	●							0.787	0.197
DTM5-080	5	5	0.197	0.031	●							0.984	0.217
DTM6-080	6	6	0.236	0.031	●							0.984	0.217
DTM8-080	8	8	0.315	0.031	●							1.181	0.264

● : Line up

DTE

External face grooving and turning (for high precision)

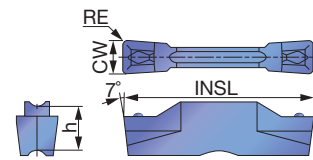

P	Steel	★	★	★	☆	☆				★			
M	Stainless	★		★	☆	★							
K	Cast iron	☆		★	☆								
N	Non-ferrous												
S	Superalloys				★	☆							
H	Hard materials												

★ : First choice
☆ : Second choice

Designation	Seat size	CW±0.02 (mm)	CW±0.0008 (in)	RE (in)	Coated					Cermet		INSL (in)	h (in)	
					T9225	T9125	AH7025	AH725	GH130	NS9530				
DTE265-015	3	2.65	0.104	0.006	●	▲	●	●	●		●		0.787	0.197
DTE300-020	3	3	0.118	0.008	●	▲	●	●	●		●		0.787	0.197
DTE300-040	3	3	0.118	0.016	●	▲	●	●	●		●		0.787	0.197
DTE315-015	3	3.15	0.124	0.006	●	▲	●	●	●		●		0.787	0.197
DTE400-040	4	4	0.157	0.016	●	▲	●	●	●		●		0.787	0.197
DTE400-080	4	4	0.157	0.031	●	▲	●	●	●		●		0.787	0.197
DTE415-015	4	4.15	0.163	0.006	●	▲	●	●	●		●		0.787	0.197
DTE478-055	5	4.78	0.188	0.022	●	▲	●	●	●		●		0.984	0.217
DTE500-040	5	5	0.197	0.016	●	▲	●	●	●		●		0.984	0.217
DTE500-080	5	5	0.197	0.031	●	▲	●	●	●		●		0.984	0.217
DTE515-015	5	5.15	0.203	0.006	●	▲	●	●	●				0.984	0.217
DTE600-080	6	6	0.236	0.031	●	▲	●	●	●				0.984	0.217
DTE600-120	6	6	0.236	0.047	●	▲	●	●	●				0.984	0.217
DTE800-080	8	8	0.315	0.031	●	▲	●	●	●				1.181	0.264
DTE800-120	8	8	0.315	0.047	●	▲	●	●	●				1.181	0.264

● : Line up
▲ : To be discontinued

Reference pages: Toolholders → F010 - F022, Standard cutting conditions → F032

DTE

External face grooving and turning

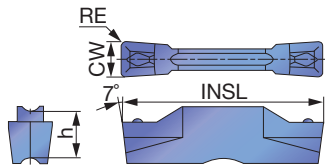

P	Steel	★	★	★	☆	☆	★						
M	Stainless	★		★	☆	★							
K	Cast iron	☆		★	★	☆							
N	Non-ferrous												
S	Superalloys				★	☆							
H	Hard materials												

★ : First choice
☆ : Second choice

Designation	Seat size	CW±0.05 (mm)	CW±0.002 (in)	RE (in)	Coated						Cermets			INSL (in)	h (in)	
					T9225	T9125	T515	AH7025	AH725	GH130	NS9530					
DTE3-040	3	3	0.118	0.016	●	▲	●	●	●	●		●			0.787	0.197
DTE4-040	4	4	0.157	0.016	●	▲	●	●	●	●		●			0.787	0.197
DTE5-040	5	5	0.197	0.016			●	●	●						0.984	0.217
DTE6-080	6	6	0.236	0.031			●	●							0.984	0.217

● : Line up
▲ : To be discontinued

DTX

External/Internal face grooving and turning

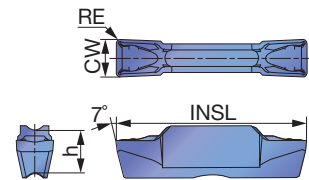

P	Steel	★	★	★	☆	☆	★						
M	Stainless	★		★	☆	★							
K	Cast iron	☆		★	☆								
N	Non-ferrous												
S	Superalloys				★	☆							
H	Hard materials												

★ : First choice
☆ : Second choice

Designation	Seat size	CW±0.05 (mm)	CW±0.002 (in)	RE (in)	Coated						Cermets			INSL (in)	h (in)
					T9225	T9125	AH7025	AH725	GH130	NS9530					
DTX3-030	3	3	0.118	0.012	●	▲	●	●	●		●			0.787	0.197
DTX4-040	4	4	0.157	0.016	●	▲	●	●	●		●			0.787	0.197
DTX5-040	5	5	0.197	0.016	●	▲	●	●	●		●			0.984	0.217
DTX6-080	6	6	0.236	0.031			●	●	●					0.984	0.197

● : Line up
▲ : To be discontinued

Reference pages: Toolholders → F010 - F022, Standard cutting conditions → F032

Grade
Insert
Toolholder
Ext. Toolholder
Int. Toolholder
Threading
Grooving
Miniature Tool
Milling Cutter
Endmill
Drilling Tool
Tooling System
User's Guide
Index



DTR

Profiling and undercutting (for high precision)

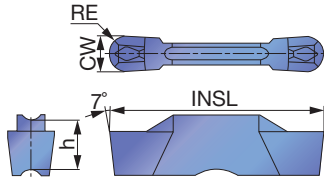

	P	M	K	N	S	H
Steel	★	★	★	☆	☆	★
Stainless	★	★	★	☆	★	
Cast iron	☆	★	★	☆	☆	★
Non-ferrous						
Superalloys			★	☆		
Hard materials						

★ : First choice
☆ : Second choice

Designation	Seat size	CW±0.02 (mm)	CW±0.0008 (in)	RE (in)	Coated					Cermets			INSL (in)	h (in)	
					T9225	T9125	AH7025	AH725	AH905	GH130	NS9530				
DTR300-150	3	3	0.118	0.059	●	▲	●	●	●		●			0.787	0.197
DTR400-200	4	4	0.157	0.079	●	▲	●	●	●		●			0.787	0.197
DTR478-239	5	4.78	0.188	0.094	●	▲	●	●	●		●			0.984	0.217
DTR500-250	5	5	0.197	0.098	●	▲	●	●	●		●			0.984	0.217
DTR600-300	6	6	0.236	0.118	●	▲	●	●	●					0.984	0.217

● : Line up
▲ : To be discontinued

DTR

Profiling and undercutting

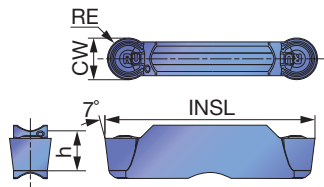

	P	M	K	N	S	H
Steel	★	★	★	☆	☆	★
Stainless	★	★	★	☆	★	
Cast iron	☆	★	★	☆	☆	★
Non-ferrous						
Superalloys			★	☆	★	
Hard materials						

★ : First choice
☆ : Second choice

Designation	Seat size	CW±0.05 (mm)	CW±0.002 (in)	RE (in)	Coated					Cermets			INSL (in)	h (in)	
					T9225	T9125	AH7025	AH725	AH905	GH130	NS9530				
DTR3-150	3	3	0.118	0.059	●	▲	●	●	●		●			0.787	0.197
DTR4-200	4	4	0.157	0.079	●	▲	●	●	●		●			0.787	0.197
DTR5-250	5	5	0.197	0.098	●	▲	●	●	●		●			0.984	0.217
DTR6-300	6	6	0.236	0.118	●	▲	●	●	●					0.984	0.217
DTR8-400	8	8	0.315	0.157	●	▲	●	●	●					1.181	0.264

● : Line up
▲ : To be discontinued

Reference pages: Toolholders → **F010 - F022**, Standard cutting conditions → **F032**

DTIU

Profiling and undercutting (for high precision)

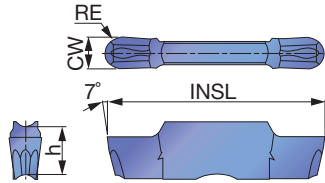

P	Steel	★	☆	☆					
M	Stainless	★	☆	★					
K	Cast iron	★		☆					
N	Non-ferrous								
S	Superalloys	★	☆						
H	Hard materials								

★ : First choice
☆ : Second choice

Designation	Seat size	CW±0.02 (mm)	CW±0.0008 (in)	RE (in)	Coated			INSL (in)	h (in)
					AH7025	AH725	GH130		
DTIU300-150	3	3	0.118	0.059	●	●	●	0.787	0.197
DTIU400-200	4	4	0.157	0.079	●	●	●	0.787	0.197
DTIU500-250	5	5	0.197	0.098	●	●	●	0.984	0.217
DTIU600-300	6	6	0.236	0.118	●	●	●	0.984	0.217

● : Line up

DTA

Aluminum wheel machining (for high precision)

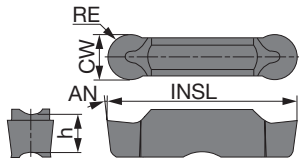

P	Steel								
M	Stainless								
K	Cast iron								
N	Non-ferrous	★							
S	Superalloys								
H	Hard materials								

★ : First choice
☆ : Second choice

Designation	Seat size	CW±0.02 (mm)	CW±0.0008 (in)	RE (in)	Uncoated			INSL (in)	h (in)	AN
					TH10					
DTA600-300	6	6	0.236	0.118	●			0.984	0.217	7°
DTA800-400	8	8	0.315	0.157	●			1.181	0.264	10°

● : Line up



External grooving of hardened steel

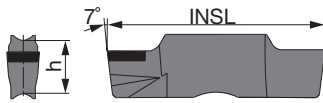
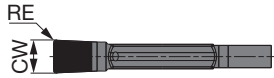

P	Steel								
M	Stainless								
K	Cast iron								
N	Non-ferrous								
S	Superalloys								
H	Hard materials	★							

★ : First choice
☆ : Second choice

Designation	Seat size	CW±0.025 (mm)	CW±0.001 (in)	RE (in)	CBN						INSL (in)	h (in)	
					BX360								
SGN200-020	2	2	0.079	0.008	●							0.787	0.197
SGN300-020	3	3	0.118	0.008	●							0.787	0.197
SGN400-020	4	4	0.157	0.008	●							0.787	0.197

● : Line up







STANDARD CUTTING CONDITIONS

ISO	Workpiece material	Hardness	Priority	Grade	Cutting speed Vc (sfm)
P	Steel 1045, 4135, etc.	< 300 HB	First choice	AH7025, AH725	164 - 591
		< 300 HB	Priority for wear resistance	T9225	262 - 984
		< 300 HB	Priority for impact resistance	GH130	164 - 394
		< 300 HB	Priority for surface finish	NS9530	262 - 722
M	Stainless steel 304SS, 316SS, 17-4 PH, etc.	< 200 HB	First choice	AH7025, AH725	164 - 394
		< 200 HB	Priority for impact resistance	GH130	164 - 394
K	Gray cast iron No.250B, No.300B, etc.	-	First choice	T515, AH7025	164 - 591
		-	Priority for impact resistance	GH130	164 - 591
	Ductile cast iron 60-40-18, 60-55-06, etc.	-	First choice	T515, AH7025	164 - 394
		-	Priority for impact resistance	GH130	164 - 394
N	Aluminum alloys Si < 12%	-	First choice	TH10	328 - 1640
		-	First choice	KS05F	328 - 1969
S	Superalloys Inconel 718, etc.	< HRC 40	First choice	AH7025	66 - 197
		< HRC 40	Priority for wear resistance	AH905	66 - 262
	Titanium alloys Ti-6Al-4V, etc.	< HRC 40	First choice	AH905	66 - 262
		< HRC 40	Priority for impact resistance	AH7025, AH725	66 - 262
		< HRC 40	Priority for surface finish	KS05F	66 - 197
H	Hardened steel 4137, etc.	> HRC 50	First choice	BX360	262 - 492

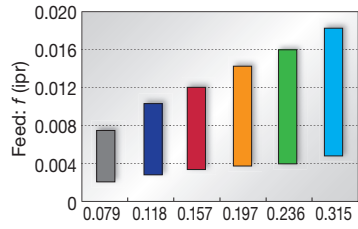
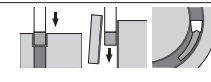
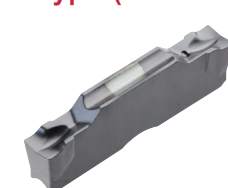
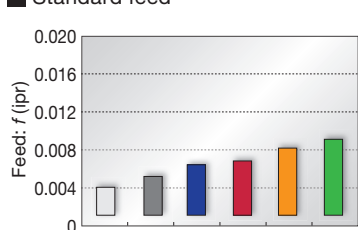
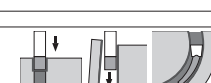
*See page F033 - F035 for feed: f (ipr).

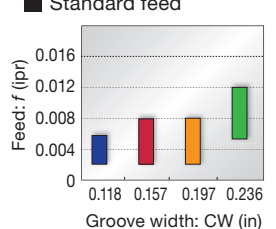
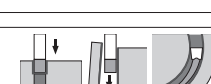
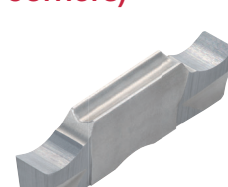
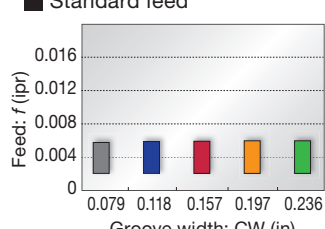
Reference pages: Toolholders → F010 - F022

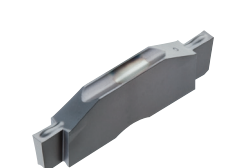
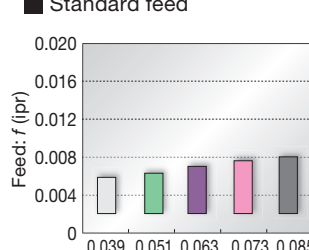
External grooving and parting

<p>DGM type (2 corners) SGM type (1 corner)</p>  <p>F023, F024 page</p>	<p>1st choice for grooving and parting</p> <p>Smooth chip evacuation Well-designed edge with high strength Handed insert available CW = 0.079" - 0.315"</p>	<p>■ Standard feed</p>  <p>Feed: f (ipr)</p> <p>Groove width: CW (in)</p> 
<p>DGS type (2 corners) SGS type (1 corner)</p>  <p>F025, F026 page</p>	<p>Lower cutting force and superior sharpness</p> <p>Unique-designed edge and chipbreaker Handed insert available CW = 0.055" - 0.236"</p>	<p>■ Standard feed</p>  <p>Feed: f (ipr)</p> <p>Groove width: CW (in)</p> 
<p>DGL type (2 corners)</p>  <p>F026 page</p>	<p>1st choice for mild steel</p> <p>Chipbreaker with excellent chip control at low feed Suitable for mild steel that often has difficulties with chip control CW = 0.118" - 0.236"</p>	<p>■ Standard feed</p>  <p>Feed: f (ipr)</p> <p>Groove width: CW (in)</p> 
<p>DGG type (2 corners)</p>  <p>F027 page</p>	<p>For non-ferrous materials and titanium</p> <p>Chipbreaker with low cutting force Sharp cutting edge that prevents vibration and delivers fine surface finish CW = 0.079" - 0.236"</p>	<p>■ Standard feed</p>  <p>Feed: f (ipr)</p> <p>Groove width: CW (in)</p> 
<p>DGE type (2 corners)</p>  <p>F027 page</p>	<p>For high accurate and shallow groove</p> <p>Excellent chip control CW = 0.039" - 0.085"</p>	<p>■ Standard feed</p>  <p>Feed: f (ipr)</p> <p>Groove width: CW (in)</p> 

Grade
Insert
Ext. Toolholder
Int. Toolholder
Threading
Grooving
Miniature Tool
Endmill
Drilling Tool
Tooling System
Index



External grooving and turning

DTM type (2 corners)



F028 page

General purpose

1st choice for grooving and turning
Suitable for light to medium cutting
Excellent chip control in machining steel, alloy steel, stainless steel, and heat-resistant alloy
CW = 0.118" - 0.315"

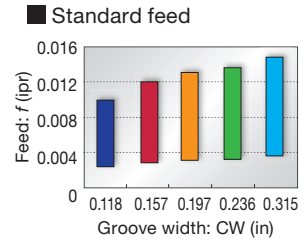
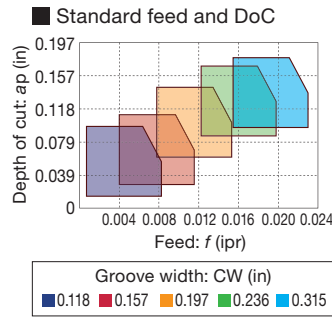

DTX type (2 corners)

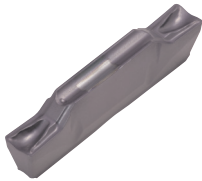

F029 page

Multi-functional type

Well balanced sharpness and strength
Multi-functional insert
CW = 0.118" - 0.236"

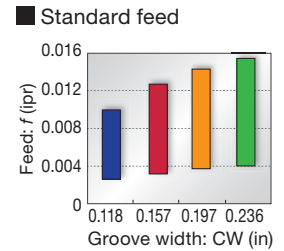
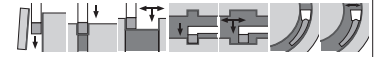
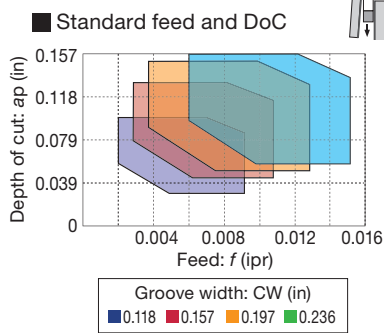

DTE type (2 corners)





F028, F029 page

General purpose

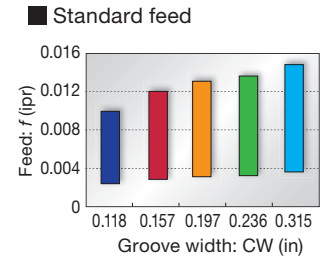
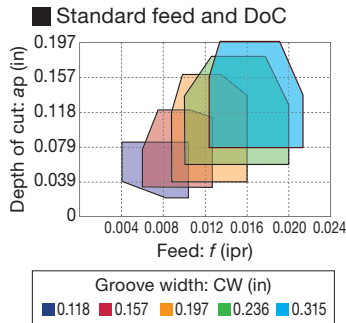
Unique chipbreaker makes chips shorter
Molded and ground insert available
CW = 0.118" - 0.315"

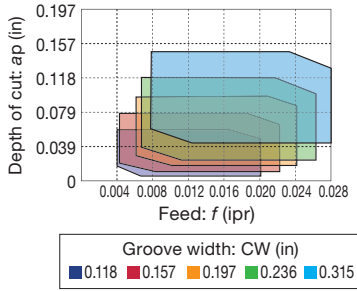
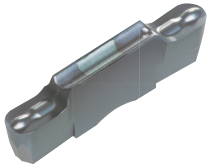
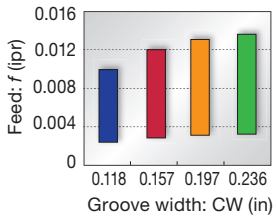

Profiling and undercutting

<p>DTR type (2 corners)</p> <p>Molded</p>  <p>Ground</p>  <p>F030 page</p>	<p>Full radius type</p> <p>Excellent chip control Molded and ground inserts available CW = 0.118" - 0.315"</p>	<p>Standard feed and DoC</p>  <p>Depth of cut: ap (in)</p> <p>Feed: f (ipr)</p> <p>Groove width: CW (in)</p> <p>0.118 0.157 0.197 0.236 0.315</p>
<p>DTIU type (2 corners)</p>  <p>F031 page</p>	<p>Full radius type</p> <p>Excellent chip control For undercutting CW = 0.118" - 0.236"</p>	<p>Standard feed and DoC</p>  <p>Feed: f (ipr)</p> <p>Groove width: CW (in)</p> <p>0.118 0.157 0.197 0.236</p>

Aluminum wheel machining

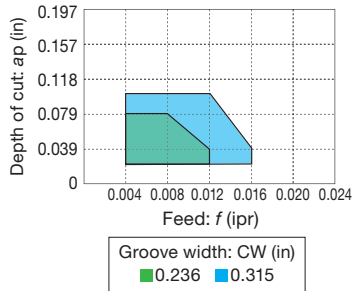
<p>DTA type (2 corners)</p>  <p>F031 page</p>	<p>Full radius type</p> <p>Excellent chip control For aluminum wheel profiling Ground insert CW = 0.236" - 0.315"</p>	<p>Standard feed and DoC</p>  <p>Depth of cut: ap (in)</p> <p>Feed: f (ipr)</p> <p>Groove width: CW (in)</p> <p>0.236 0.315</p>
---	--	---

External grooving of hardened steel

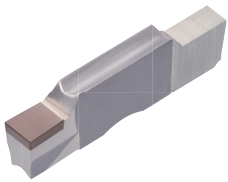
<p>SGN-CBN type (1 corner)</p>  <p>F032 page</p>	<p>For hardened steel cutting</p> <p>Optimum cutting edge shape for grooving of hardened steels High tolerance width for finishing CW = 0.079" - 0.157" (CW = ±0.001")</p>	<p>Standard feed</p>  <p>Feed: f (ipr)</p> <p>Groove width: CW (in)</p> <p>0.079 0.118 0.157</p>
--	---	--

AH7025 Cutting performance

First choice grade for grooving

AH7025 grade: Tungaloy's unique coating technology for drastically improved reliability

Tool life comparison

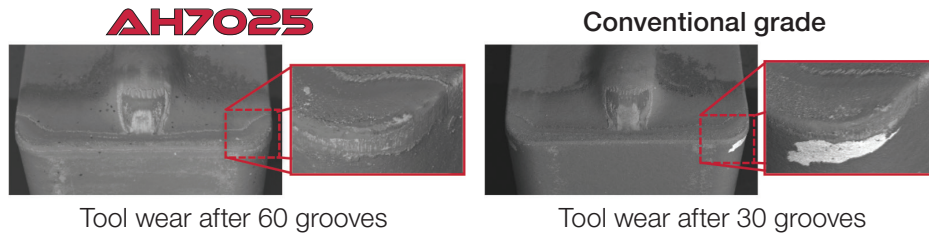

P Alloy steel (4140)

Insert : DTE3-040 AH7025
 Cutting speed : $V_c = 492$ sfm
 Feed : $f = 0.007$ ipr
 Groove depth : 0.669"
 Machining : External grooving
 Coolant : Wet

AH7025 provides stability, while preventing coating from peeling off even after machining twice the number of passes compared to the conventional grade.

→ **The combination of Nano-multi-layered AlTiN Coating with high Al content and tough substrate provides highly efficient machining in various grooving operations.**



Grades

AH7025

P M K S

- First choice for various applications
- New PVD coating with high Al content provides excellent adhesion strength
- Improved wear and chipping resistance

AH725

P M S

- Recommended for various applications
- Newly developed coating with well controlled crystal structure and fracture resistance
- Improved adhesion strength

T515

K

- First recommended grade for cast iron
- Excellent wear resistance in high-speed machining

T9225

P

- Suitable for steel machining at high speeds
- New CVD coating and substrate deliver an outstanding balance of wear and chipping resistance

NS9530

P

- Advanced cermet for finish cutting of steel
- Innovative grade with incredible fracture and high wear resistance

GH130

P M K

- Recommended for interrupted machining
- TiCNO PVD coating layer with high wear resistance
- High hardness wear resistance

AH905

S

- Remarkable for machining of heat resistant alloys
- Exclusive coating layer improves adhesion strength and wear resistance

KS05F

N S

- Recommended for non-ferrous materials and titanium

TH10

N

- Recommended for non-ferrous materials

BX360

H

- Suitable for hardened steel machining
- Ideal balance of wear and chipping resistance due to the optimum CBN content and grain size

TETRAMCUT

STCR/L-18

External grooving and threading toolholder

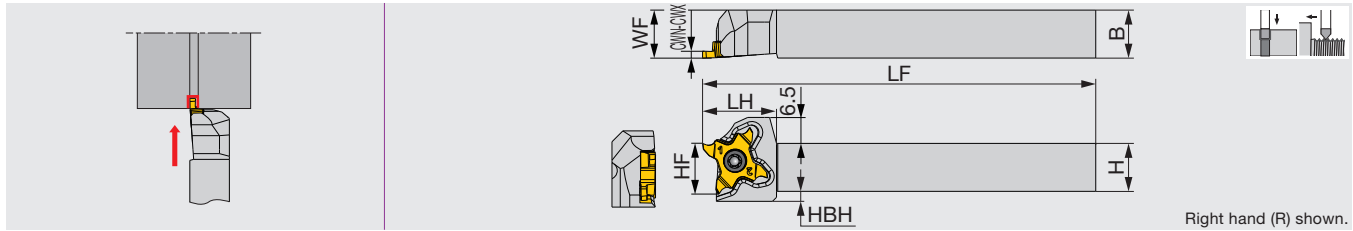

Right hand (R) shown.

Inch	CWN	CWX	H	B	LF	LH	HF	WF	HBH	Insert	Torque
STCR/L06-18	0.013	0.118	0.375	0.375	4.750	0.740	0.375	0.375	0.177	TC*18...	0.89
STCR/L08-18	0.013	0.118	0.500	0.500	4.750	0.740	0.500	0.500	0.098	TC*18...	0.89
STCR/L10-18	0.013	0.118	0.625	0.625	4.750	0.740	0.625	0.625	-	TC*18...	0.89
STCR/L12-18	0.013	0.118	0.750	0.750	4.750	0.900	0.750	1.000	-	TC*18...	0.89
STCR/L16-18	0.013	0.118	1.000	1.000	5.500	0.900	1.000	1.250	-	TC*18...	0.89

Use right-hand toolholders (R) with right-hand inserts (R); and left-hand toolholders (L) with left-hand inserts (L).
Torque: Recommended clamping torque: lbs-ft

SPARE PARTS

Designation	Clamping screw	Wrench
STCR**18	CSTC-4L100DL	T-1008/5
STCL**18	CSTC-4L100DR	T-1008/5

TETRAMCUT

STCR/L-X18-CHP

TUNG TURN

External grooving and threading toolholder with high pressure coolant capability

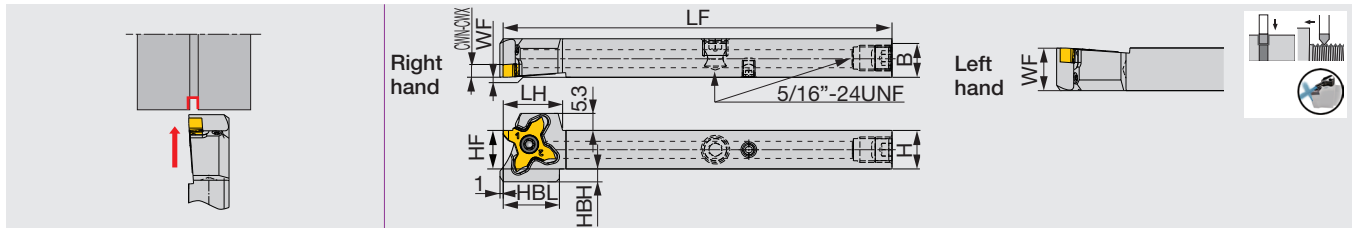

Inch	CWN	CWX	H	B	LF	LH	HBL	HF	WF	HBH	Insert	Torque
STCR/L08X18-CHP ⁽¹⁾	0.013	0.118	0.500	0.500	4.750	0.728	0.689	0.500	0/0.500	0.130	TC*18...	0.89
STCR/L10X18-CHP ⁽¹⁾	0.013	0.118	0.625	0.625	4.750	0.728	-	0.625	0/0.625	-	TC*18...	0.89

Use right-hand toolholders (R) with right-hand inserts (R); and left-hand toolholders (L) with left-hand inserts (L).

⁽¹⁾ Compatible to the direct internal coolant supply system without the use of external coolant hose.

Torque: Recommended clamping torque: lbs-ft

SPARE PARTS

Designation	Clamping screw	Wrench
STCL**18-CHP	CSTC-4L100DR	T-1008/5
STCR**18-CHP	CSTC-4L100DL	T-1008/5

External grooving and threading toolholder, with high pressure coolant capability

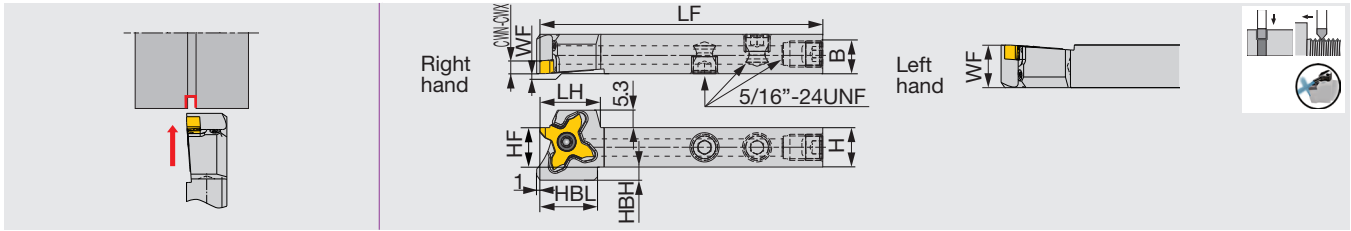

Inch	CWN	CWX	H	B	LF	LH	HBL	HF	WF	HBH	Insert	Torque
STCR/L08F18-CHP	0.013	0.118	0.500	0.500	3.344	0.728	0.689	0.500	0/0.500	0.130	TC*18...	0.89

Use right-hand toolholders (R) with right-hand inserts (R); and left-hand toolholders (L) with left-hand inserts (L).
Torque: Recommended clamping torque: lb-ft



SPARE PARTS



Designation	Clamping screw	Wrench
STCL**18-CHP	CSTC-4L100DR	T-1008/5
STCR**18-CHP	CSTC-4L100DL	T-1008/5

STCR/L-18-CHP

Threading tool - for external theading with high pressure coolant capability

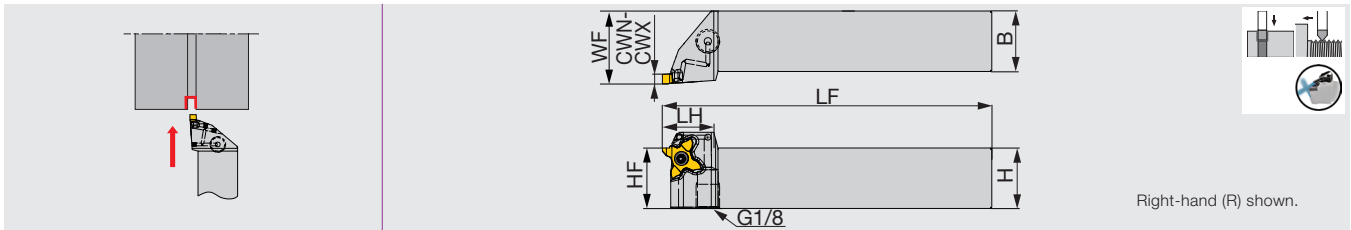

Inch	CWN	CWX	H	B	LF	LH	HBL	HF	WF	HBH	Insert	Torque
STCR/L12-18-CHP	0.013	0.118	0.750	0.750	4.750	0.900	-	0.750	1.000	-	TC*18...	0.890
STCR/L16-18-CHP	0.013	0.118	1.000	1.000	5.500	.900	-	1.000	1.250	-	TC*18...	0.890

Use the right hand insert (TC*18R...) with the right hand toolholders (STCR...). Use the left hand insert (TC*18L) with the left hand holder (STCL...).

Torque: Recommended clamping torque: lb-ft

SPARE PARTS



Designation	Clamping screw	Wrench
STCL**18-CHP	CSTC-4L100DR	T-1008/5
STCR**18-CHP	CSTC-4L100DL	T-1008/5

External grooving and threading toolholder with round shank, for Swiss lathes

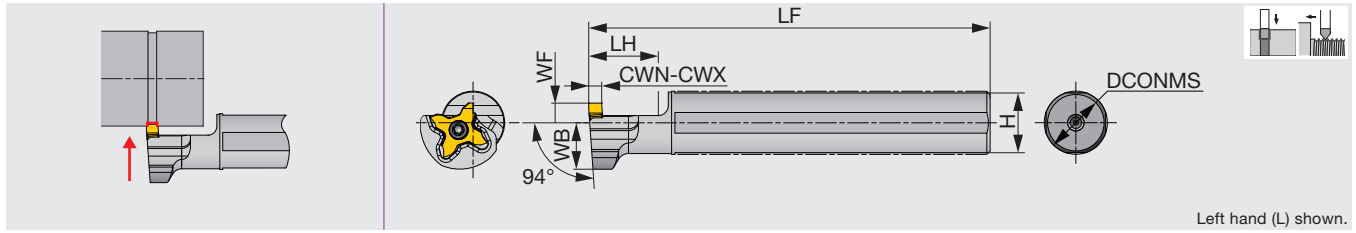

Metric	CWN	CWX	DCONMS	H	LF	LH	WB	WF	Insert	Torque
JS14H-STCL18	0.33	3	14	13	100	20	14	6	TC*18R...	1.2
JS159F-STCL18	0.33	3	15.875	15	85	20	14	6	TC*18R...	1.2
JS16F-STCL18	0.33	3	16	15	85	20	14	6	TC*18R...	1.2
JS19G-STCL18	0.33	3	19.05	18	90	20	14	6	TC*18R...	1.2
JS19X-STCL18	0.33	3	19.05	18	120	20	14	6	TC*18R...	1.2
JS20G-STCL18	0.33	3	20	19	90	20	14	6	TC*18R...	1.2
JS20X-STCL18	0.33	3	20	19	120	20	14	6	TC*18R...	1.2
JS22X-STCL18	0.33	3	22	21	120	20	12.25	10	TC*18R...	1.2
JS25H-STCL18	0.33	3	25	24	100	20	12.25	10	TC*18R...	1.2
JS254X-STCL18	0.33	3	25.4	24	120	20	12.25	10	TC*18R...	1.2

Please use right-hand inserts.
Torque: Recommended clamping torque: N·m

SPARE PARTS

Designation	Clamping screw	Wrench
JS****-STCL18	CSTC-4L100DL	T-1008/5

Modular-type external grooving and parting blade, with high pressure coolant capability

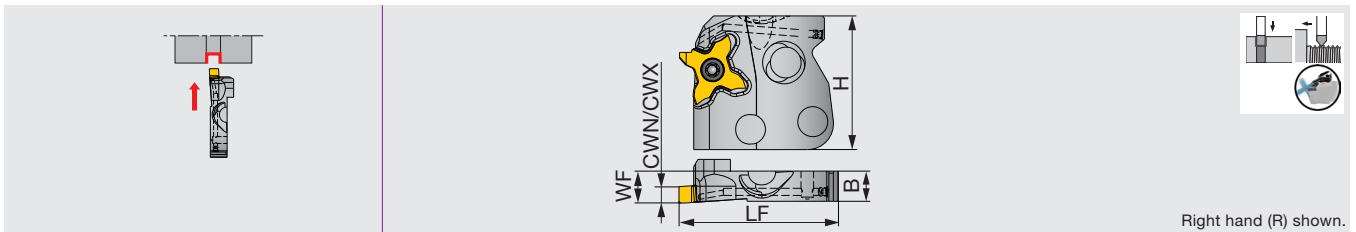

Inch	CWN	CWX	WF	H	LF	B	Insert	Torque
STCAR/L18-CHP	0.013	0.118	0.295	1.299	1.496	0.283	TC*18...	0.89

Use right-hand toolholders (R) with right-hand inserts (R); and left-hand toolholders (L) with left-hand inserts (L).
Torque: Recommended clamping torque: lb·ft

SPARE PARTS

Designation	Clamping screw	Wrench
STCAL18-CHP	CSTC-4L100DR	T-1008/5
STCAR18-CHP	CSTC-4L100DL	T-1008/5

Reference pages: Inserts → **F042 - F047**, Standard cutting conditions → **F048**, Parts for coolant hose → **F240**



CHSR/L-CHP

Shank for blades with high pressure coolant capability

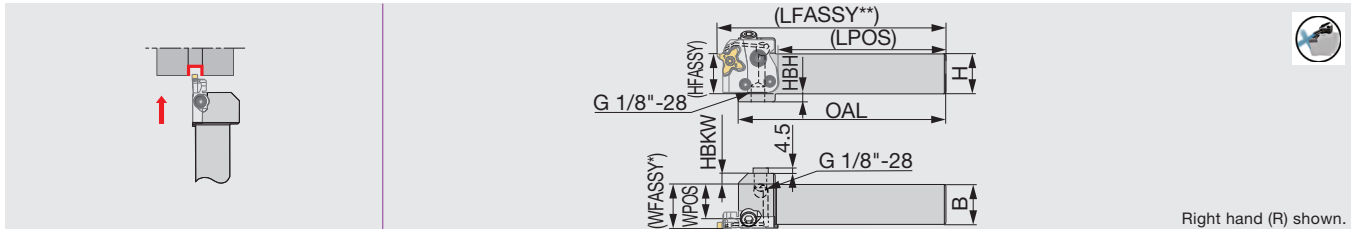

Right hand (R) shown.

Inch	H	B	OAL	LPOS	WPOS	HBKW	HFASSY	HBH
CHSR/L12-CHP	0.750	0.750	5.000	4.035	0.560	0.510	0.750	0.190
CHSR/L16-CHP	1.000	1.000	5.000	4.035	0.810	0.260	1.000	0.200

*WFASSY : shank (WPOS) + blade (WF)
 **LFASSY : shank (LPOS) + blade (LF)

Use right-hand blades (R) with right-hand shanks (R); and left-hand blades (L) with left-hand shanks (L).
 Applicable for 30 MPa coolant
 Please see the page L043 for the instruction on installing and removing the blade.

SPARE PARTS

Designation	Clamping screw 1	Wrench 1	Clamping screw 2	Clamping screw 3	Wrench 2	O-ring	Plug
CHSR/L*-CHP	SRM5-04451	T-20/5	SRM6X12DIN6912	SRM6X20-XT	HW5.0	OR5X1N	PLUGG1/8ISO1179

Recommended clamping torque (lbs-ft, N·m)

Clamping screw	Torque (lbs-ft)	Torque (N·m)
SRM5-04451	3.69	5
SRM6X12DIN6912	6.27	8.5
SRM6X20-XT	6.27	8.5

CHFVR/L-CHP

Shank for blades with high pressure coolant capability

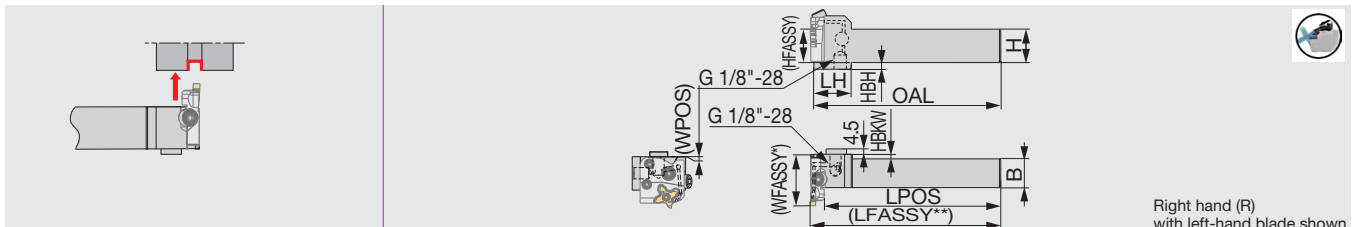

Right hand (R)
with left-hand blade shown.

Inch	H	B	OAL	LH	LPOS	WPOS	HBKW	HFASSY	HBH
CHFVR/L12-CHP	0.750	0.750	5.500	1.100	5.307	0.020	0.234	0.750	0.431
CHFVR/L16-CHP	1.000	1.000	5.500	1.100	5.307	0.020	-	1.000	0.200

*WFASSY : shank (WPOS) + blade (LF)
 **LFASSY : shank (LPOS) + blade (WF)

Use left-hand blades (L) with right-hand shanks (R); and right-hand blades (R) with left-hand shanks (L).
 Applicable for 30 MPa coolant
 Please see the page L043 for the instruction on installing and removing the blade.

SPARE PARTS

Designation	Clamping screw 1	Wrench 1	Clamping screw 2	Clamping screw 3	Wrench 2	O-ring	Plug
CHFVR/L*-CHP	SRM5-04451	T-20/5	SRM6X12DIN6912	SRM6X20-XT	HW5.0	OR5X1N	PLUGG1/8ISO1179

Reference pages: Inserts → F042 - F047, Standard cutting conditions → F048, Parts for coolant hose → F240

C*CHSN-CHP

TungCap shank for CAER/L-CHP blades with high pressure coolant capability

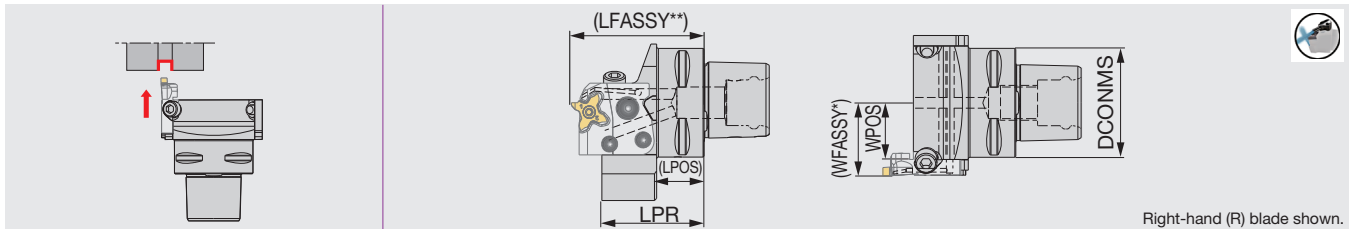

Right-hand (R) blade shown.

Metric	DCONMS	LPR	LPOS	WPOS
C3CHSN19045-CHP	32	45	17.5	18.5
C4CHSN21047-CHP	40	46.5	21.5	21
C5CHSN26047-CHP	50	47	22.5	26
C6CHSN33050-CHP	63	50	24.5	32.5

*WFASSY : shank (WPOS) + blade (WF)

**LFASSY : shank (LPOS) + blade (LF)

Applicable for 30 MPa coolant

Please see the page **L043** for the instruction on installing and removing the blade.

SPARE PARTS

Designation	Clamping screw 1	Wrench 1	Clamping screw 2	Clamping screw 3	Wrench 2	O-ring
C*CHSN**-CHP	SRM5-04451	T-20/5	SRM6X12DIN6912	SRM6X20-XT	HW5.0	OR5X1N

Recommended clamping torque (lbs-ft, N-m)

Clamping screw	Torque (lbs-ft)	Torque (N-m)
SRM5-04451	3.69	5
SRM6X12DIN6912	6.27	8.5
SRM6X20-XT	6.27	8.5

C*CHFVN-CHP

TungCap shank for CAER/L-CHP blades with high pressure coolant capability

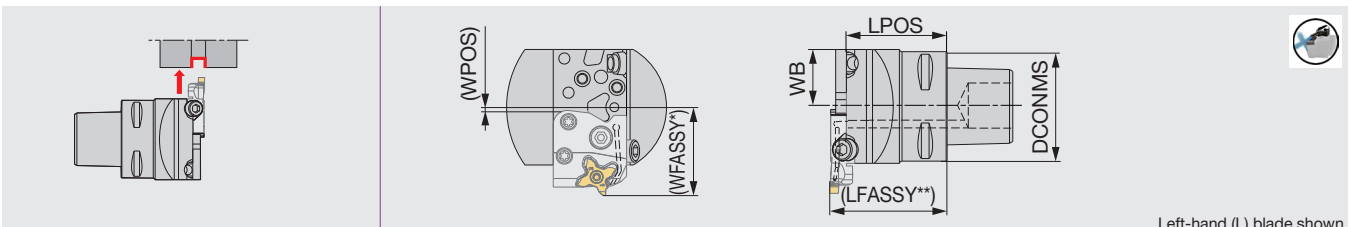

Left-hand (L) blade shown.

Inch	DCONMS	LPOS	WB	WPOS
C3CHFVN26040-CHP	1.260	1.575	1.024	0.059
C4CHFVN26046-CHP	1.575	1.811	1.024	0.059
C5CHFVN26046-CHP	1.969	1.811	1.024	0.059
C6CHFVN33046-CHP	2.480	1.811	1.299	0.335

*WFASSY : shank (WPOS) + blade (LF)

**LFASSY : shank (LPOS) + blade (WF)

Applicable for 30 MPa coolant

Please see the page **L043** for the instruction on installing and removing the blade.

SPARE PARTS

Designation	Clamping screw 1	Wrench 1	Clamping screw 2	Clamping screw 3	Wrench 2	O-ring
C*CHFVN**-CHP	SRM5-04451	T-20/5	SRM6X12DIN6912	SRM6X20-XT	HW5.0	OR5X1N

Recommended clamping torque (lbs-ft, N-m)

Clamping screw	Torque (lbs-ft)	Torque (N-m)
SRM5-04451	3.69	5
SRM6X12DIN6912	6.27	8.5
SRM6X20-XT	6.27	8.5

Reference pages: Inserts → **F042 - F047**, Standard cutting conditions → **F048**, Parts for coolant hose → **F240**

INSERT

TCG18R/L (with edge preparation)

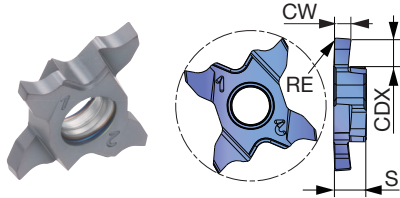

P	Steel	★					
M	Stainless	★					
K	Cast iron	★					
N	Non-ferrous						
S	Superalloys	★					
H	Hard materials						

★ : First choice
☆ : Second choice

Designation	HAND	CW±0.02 (mm)	CW±0.001 (in)	RE (in)	Coated					CDX (in)	S (in)	
					AH7025							
TCG18R100-010	R	1	0.039	0.004	●						0.079	0.157
TCG18L100-010	L	1	0.039	0.004	●						0.079	0.157
TCG18R120-010	R	1.2	0.047	0.004	●						0.079	0.157
TCG18L120-010	L	1.2	0.047	0.004	●						0.079	0.157
TCG18R125-010	R	1.25	0.049	0.004	●						0.079	0.157
TCG18L125-010	L	1.25	0.049	0.004	●						0.079	0.157
TCG18R125-020	R	1.25	0.049	0.008	●						0.079	0.157
TCG18L125-020	L	1.25	0.049	0.008	●						0.079	0.157
TCG18R130-020	R	1.3	0.051	0.008	●						0.079	0.157
TCG18L130-020	L	1.3	0.051	0.008	●						0.079	0.157
TCG18R140-010	R	1.4	0.055	0.004	●						0.138	0.157
TCG18L140-010	L	1.4	0.055	0.004	●						0.138	0.157
TCG18R140-020	R	1.4	0.055	0.008	●						0.138	0.157
TCG18L140-020	L	1.4	0.055	0.008	●						0.138	0.157
TCG18R145-010	R	1.45	0.057	0.004	●						0.138	0.157
TCG18L145-010	L	1.45	0.057	0.004	●						0.138	0.157
TCG18R145-020	R	1.45	0.057	0.008	●						0.138	0.157
TCG18L145-020	L	1.45	0.057	0.008	●						0.138	0.157
TCG18R150-010	R	1.5	0.059	0.004	●						0.138	0.157
TCG18L150-010	L	1.5	0.059	0.004	●						0.138	0.157
TCG18R150-020	R	1.5	0.059	0.008	●						0.138	0.157
TCG18L150-020	L	1.5	0.059	0.008	●						0.138	0.157
TCG18R160-020	R	1.6	0.063	0.008	●						0.138	0.157
TCG18L160-020	L	1.6	0.063	0.008	●						0.138	0.157
TCG18R170-020	R	1.7	0.067	0.008	●						0.138	0.157
TCG18L170-020	L	1.7	0.067	0.008	●						0.138	0.157
TCG18R175-010	R	1.75	0.069	0.004	●						0.138	0.157
TCG18L175-010	L	1.75	0.069	0.004	●						0.138	0.157
TCG18R175-020	R	1.75	0.069	0.008	●						0.138	0.157
TCG18L175-020	L	1.75	0.069	0.008	●						0.138	0.157
TCG18R185-020	R	1.85	0.073	0.008	●						0.138	0.157
TCG18L185-020	L	1.85	0.073	0.008	●						0.138	0.157
TCG18R195-020	R	1.95	0.077	0.008	●						0.138	0.157
TCG18L195-020	L	1.95	0.077	0.008	●						0.138	0.157

See page F048 for precautions of processing.

5 pieces per package

● : Line up

Reference pages: Toolholders → F037 - F041, Standard cutting conditions → F048

P	Steel	★			
M	Stainless	★			
K	Cast iron	★			
N	Non-ferrous				
S	Superalloys	★			
H	Hard materials				

★ : First choice
 ☆ : Second choice

Designation	HAND	CW±0.02 (mm)	CW±0.001 (in)	RE (in)	Coated						CDX (in)	S (in)	
					AH7025								
TCG18R200-010	R	2	0.079	0.004	●							0.138	0.157
TCG18L200-010	L	2	0.079	0.004	●							0.138	0.157
TCG18R200-020	R	2	0.079	0.008	●							0.138	0.157
TCG18L200-020	L	2	0.079	0.008	●							0.138	0.157
TCG18R225-020	R	2.25	0.089	0.008	●							0.138	0.157
TCG18L225-020	L	2.25	0.089	0.008	●							0.138	0.157
TCG18R230-020	R	2.3	0.091	0.008	●							0.138	0.157
TCG18L230-020	L	2.3	0.091	0.008	●							0.138	0.157
TCG18R250-010	R	2.5	0.098	0.004	●							0.138	0.157
TCG18L250-010	L	2.5	0.098	0.004	●							0.138	0.157
TCG18R250-020	R	2.5	0.098	0.008	●							0.138	0.157
TCG18L250-020	L	2.5	0.098	0.008	●							0.138	0.157
TCG18R250-030	R	2.5	0.098	0.012	●							0.138	0.157
TCG18L250-030	L	2.5	0.098	0.012	●							0.138	0.157
TCG18R265-030	R	2.65	0.104	0.012	●							0.138	0.157
TCG18L265-030	L	2.65	0.104	0.012	●							0.138	0.157
TCG18R280-030	R	2.8	0.110	0.012	●							0.138	0.157
TCG18L280-030	L	2.8	0.110	0.012	●							0.138	0.157
TCG18R300-010	R	3	0.118	0.004	●							0.138	0.157
TCG18L300-010	L	3	0.118	0.004	●							0.138	0.157
TCG18R300-020	R	3	0.118	0.008	●							0.138	0.157
TCG18L300-020	L	3	0.118	0.008	●							0.138	0.157
TCG18R300-030	R	3	0.118	0.012	●							0.138	0.157
TCG18L300-030	L	3	0.118	0.012	●							0.138	0.157

Please see the page **F048** for precautions of processing.

5 pieces per package
 ● : Line up

INSERT

TCS18R (3D chipbreaker, honed edge)

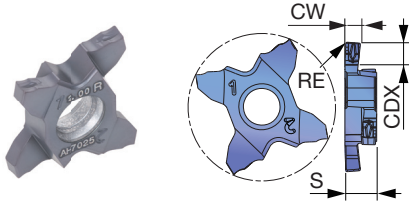

P	Steel	★						
M	Stainless	★						
K	Cast iron	★						
N	Non-ferrous							
S	Superalloys	★						
H	Hard materials							

★ : First choice
☆ : Second choice



Designation	HAND	CW±0.02 (mm)	CW±0.001 (in)	RE (in)	Coated								CDX (in)	S (in)	
					AH7025										
TCS18R100-010	R	1	0.039	0.004	●									0.079	0.157
TCS18R120-010	R	1.2	0.047	0.004	●									0.079	0.157
TCS18R125-010	R	1.25	0.049	0.004	●									0.079	0.157
TCS18R125-020	R	1.25	0.049	0.008	●									0.079	0.157
TCS18R130-020	R	1.3	0.051	0.008	●									0.138	0.157
TCS18R140-010	R	1.4	0.055	0.004	●									0.138	0.157
TCS18R140-020	R	1.4	0.055	0.008	●									0.138	0.157
TCS18R145-010	R	1.45	0.057	0.004	●									0.138	0.157
TCS18R150-010	R	1.5	0.059	0.004	●									0.138	0.157
TCS18R150-020	R	1.5	0.059	0.008	●									0.138	0.157
TCS18R160-020	R	1.6	0.063	0.008	●									0.138	0.157
TCS18R170-020	R	1.7	0.067	0.008	●									0.138	0.157
TCS18R175-010	R	1.75	0.069	0.004	●									0.138	0.157
TCS18R175-020	R	1.75	0.069	0.008	●									0.138	0.157
TCS18R185-020	R	1.85	0.073	0.008	●									0.138	0.157
TCS18R195-020	R	1.95	0.077	0.008	●									0.138	0.157
TCS18R200-010	R	2	0.079	0.004	●									0.138	0.157
TCS18R200-020	R	2	0.079	0.008	●									0.138	0.157
TCS18R225-020	R	2.25	0.089	0.008	●									0.138	0.157
TCS18R230-020	R	2.3	0.091	0.008	●									0.138	0.157
TCS18R250-010	R	2.5	0.098	0.008	●									0.138	0.157
TCS18R250-020	R	2.5	0.098	0.008	●									0.138	0.157
TCS18R250-030	R	2.5	0.098	0.012	●									0.138	0.157
TCS18R265-030	R	2.65	0.104	0.012	●									0.138	0.157
TCS18R280-030	R	2.8	0.110	0.012	●									0.138	0.157
TCS18R300-010	R	3	0.118	0.004	●									0.138	0.157
TCS18R300-020	R	3	0.118	0.008	●									0.138	0.157
TCS18R300-030	R	3	0.118	0.012	●									0.138	0.157

Please see the page F048 for precautions of processing.

5 pieces per package
● : Line up

Reference pages: Toolholders → F037 - F041, Standard cutting conditions → F048

TCP18R/L (lightly honed edge)

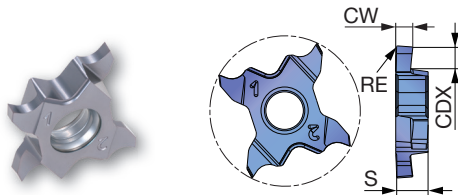

P	Steel	★						
M	Stainless	★						
K	Cast iron	★						
N	Non-ferrous							
S	Superalloys	★						
H	Hard materials							

★ : First choice
☆ : Second choice

Designation	HAND	CW±0.02 (mm)	CW±0.001 (in)	RE (in)	Coated						CDX (in)	S (in)	
					AH725								
TCP18R033-005	R	0.33	0.013	0.002	●							0.031	0.157
TCP18L033-005	L	0.33	0.013	0.002	●							0.031	0.157
TCP18R043-005	R	0.43	0.017	0.002	●							0.047	0.157
TCP18L043-005	L	0.43	0.017	0.002	●							0.047	0.157
TCP18R050-005	R	0.50	0.020	0.002	●							0.047	0.157
TCP18L050-005	L	0.50	0.020	0.002	●							0.047	0.157
TCP18R075-005	R	0.75	0.030	0.002	●							0.079	0.157
TCP18L075-005	L	0.75	0.030	0.002	●							0.079	0.157
TCP18R095-005	R	0.95	0.037	0.002	●							0.079	0.157
TCP18L095-005	L	0.95	0.037	0.002	●							0.079	0.157
TCP18R100-010	R	1	0.039	0.004	●							0.079	0.157
TCP18L100-010	L	1	0.039	0.004	●							0.079	0.157
TCP18R120-010	R	1.2	0.047	0.004	●							0.079	0.157
TCP18L120-010	L	1.2	0.047	0.004	●							0.079	0.157
TCP18R125-010	R	1.25	0.049	0.004	●							0.079	0.157
TCP18L125-010	L	1.25	0.049	0.004	●							0.079	0.157
TCP18R140-010-35	R	1.4	0.055	0.004	●							0.138	0.157
TCP18L140-010-35	L	1.4	0.055	0.004	●							0.138	0.157
TCP18R145-010	R	1.45	0.057	0.004	●							0.079	0.157
TCP18L145-010	L	1.45	0.057	0.004	●							0.079	0.157
TCP18R145-010-35	R	1.45	0.057	0.004	●							0.138	0.157
TCP18L145-010-35	L	1.45	0.057	0.004	●							0.138	0.157
TCP18R150-010	R	1.5	0.059	0.004	●							0.079	0.157
TCP18L150-010	L	1.5	0.059	0.004	●							0.079	0.157
TCP18R150-010-35	R	1.5	0.059	0.004	●							0.138	0.157
TCP18L150-010-35	L	1.5	0.059	0.004	●							0.138	0.157
TCP18R175-010	R	1.75	0.069	0.004	●							0.079	0.157
TCP18L175-010	L	1.75	0.069	0.004	●							0.079	0.157
TCP18R175-010-35	R	1.75	0.069	0.004	●							0.138	0.157
TCP18L175-010-35	L	1.75	0.069	0.004	●							0.138	0.157
TCP18R200-010	R	2	0.079	0.004	●							0.098	0.157
TCP18L200-010	L	2	0.079	0.004	●							0.098	0.157
TCP18R200-010-35	R	2	0.079	0.004	●							0.138	0.157
TCP18L200-010-35	L	2	0.079	0.004	●							0.138	0.157
TCP18R250-010	R	2.5	0.098	0.004	●							0.098	0.157
TCP18L250-010	L	2.5	0.098	0.004	●							0.098	0.157
TCP18R250-010-35	R	2.5	0.098	0.004	●							0.138	0.157
TCP18L250-010-35	L	2.5	0.098	0.004	●							0.138	0.157
TCP18R300-010	R	3	0.118	0.004	●							0.098	0.157
TCP18L300-010	L	3	0.118	0.004	●							0.098	0.157
TCP18R300-010-35	R	3	0.118	0.004	●							0.138	0.157
TCP18L300-010-35	L	3	0.118	0.004	●							0.138	0.157

Please see the page F048 for precautions of processing.

5 pieces per package
● : Line up

Reference pages: Toolholders → F037 - F041, Standard cutting conditions → F048

Index User's Guide Tooling System Drilling Tool Endmill Milling Cutter Miniature Tool Grooving Threading Int. Toolholder Ext. Toolholder Insert Grade



INSERT

TCP18R/L-F (sharp edge)

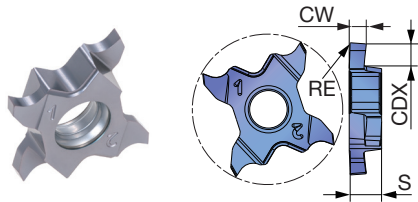

P	Steel	★			
M	Stainless	★			
K	Cast iron	★			
N	Non-ferrous				
S	Superalloys	★			
H	Hard materials				

★ : First choice
☆ : Second choice

Designation	HAND	CW±0.02 (mm)	CW±0.001 (in)	RE (in)	Coated						CDX (in)	S (in)	
					SH725								
TCP18R033F-005	R	0.33	0.013	0.002	●							0.031	0.157
TCP18L033F-005	L	0.33	0.013	0.002	●							0.031	0.157
TCP18R043F-005	R	0.43	0.017	0.002	●							0.047	0.157
TCP18L043F-005	L	0.43	0.017	0.002	●							0.047	0.157
TCP18R050F-005	R	0.5	0.020	0.002	●							0.047	0.157
TCP18L050F-005	L	0.5	0.020	0.002	●							0.047	0.157
TCP18R075F-005	R	0.75	0.030	0.002	●							0.079	0.157
TCP18L075F-005	L	0.75	0.030	0.002	●							0.079	0.157
TCP18R095F-005	R	0.95	0.037	0.002	●							0.079	0.157
TCP18L095F-005	L	0.95	0.037	0.002	●							0.079	0.157
TCP18R100F-005	R	1	0.039	0.002	●							0.079	0.157
TCP18R100F-010	R	1	0.039	0.004	●							0.079	0.157
TCP18L100F-010	L	1	0.039	0.004	●							0.079	0.157
TCP18R120F-005	R	1.2	0.047	0.002	●							0.079	0.157
TCP18R120F-010	R	1.2	0.047	0.004	●							0.079	0.157
TCP18L120F-010	L	1.2	0.047	0.004	●							0.079	0.157
TCP18R125F-005	R	1.25	0.049	0.002	●							0.079	0.157
TCP18R125F-010	R	1.25	0.049	0.004	●							0.079	0.157
TCP18L125F-010	L	1.25	0.049	0.004	●							0.079	0.157
TCP18R140F-010-35	R	1.4	0.055	0.004	●							0.138	0.157
TCP18R145F-005-35	R	1.45	0.057	0.002	●							0.138	0.157
TCP18R145F-010	R	1.45	0.057	0.004	●							0.079	0.157
TCP18L145F-010	L	1.45	0.057	0.004	●							0.079	0.157
TCP18R145F-010-35	R	1.45	0.057	0.004	●							0.138	0.157
TCP18L145F-010-35	L	1.45	0.057	0.004	●							0.138	0.157
TCP18R150F-005-35	R	1.5	0.059	0.002	●							0.138	0.157
TCP18R150F-010	R	1.5	0.059	0.004	●							0.079	0.157
TCP18L150F-010	L	1.5	0.059	0.004	●							0.079	0.157
TCP18R150F-010-35	R	1.5	0.059	0.004	●							0.138	0.157
TCP18L150F-010-35	L	1.5	0.059	0.004	●							0.138	0.157
TCP18R175F-005-35	R	1.75	0.069	0.002	●							0.138	0.157
TCP18R175F-010	R	1.75	0.069	0.004	●							0.079	0.157
TCP18L175F-010	L	1.75	0.069	0.004	●							0.079	0.157
TCP18R175F-010-35	R	1.75	0.069	0.004	●							0.138	0.157
TCP18L175F-010-35	L	1.75	0.069	0.004	●							0.138	0.157

Please see the page F048 for precautions of processing.

5 pieces per package
● : Line up

Reference pages: Toolholders → F037 - F041, Standard cutting conditions → F048

P	Steel	★				
M	Stainless	★				
K	Cast iron	★				
N	Non-ferrous					
S	Superalloys	★				
H	Hard materials					

★ : First choice
☆ : Second choice

Designation	HAND	CW±0.02 (mm)	CW±0.001 (in)	RE (in)	Coated						CDX (in)	S (in)	
					SH725								
TCP18R200F-005-35	R	2	0.079	0.002	●							0.138	0.157
TCP18R200F-010	R	2	0.079	0.004	●							0.098	0.157
TCP18L200F-010	L	2	0.079	0.004	●							0.098	0.157
TCP18R200F-010-35	R	2	0.079	0.004	●							0.138	0.157
TCP18L200F-010-35	L	2	0.079	0.004	●							0.138	0.157
TCP18R250F-010	R	2.5	0.098	0.004	●							0.098	0.157
TCP18L250F-010	L	2.5	0.098	0.004	●							0.098	0.157
TCP18R250F-010-35	R	2.5	0.098	0.004	●							0.138	0.157
TCP18L250F-010-35	L	2.5	0.098	0.004	●							0.138	0.157
TCP18R300F-010	R	3	0.118	0.004	●							0.098	0.157
TCP18L300F-010	L	3	0.118	0.004	●							0.098	0.157
TCP18R300F-010-35	R	3	0.118	0.004	●							0.138	0.157
TCP18L300F-010-35	L	3	0.118	0.004	●							0.138	0.157

Please see the page F048 for precautions of processing.

5 pieces per package
● : Line up

PRECAUTIONS OF PROCESSING

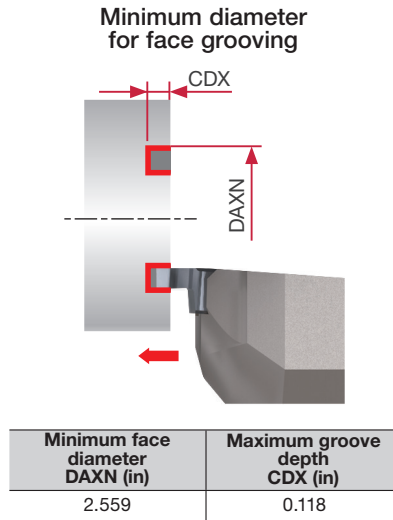
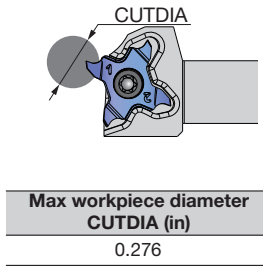
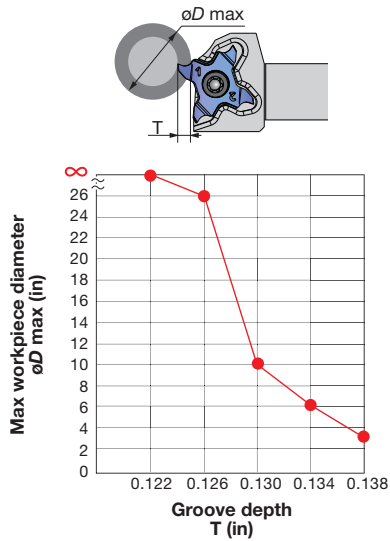

*Groove depth and max workpiece diameter (ϕD_{max})

Maximum workpiece diameter is limited relative to depth of cut in order to avoid collision between insert and workpiece.



STANDARD CUTTING CONDITIONS

ISO	Workpiece material	Cutting speed Vc (sfm)	Feed: f (ipr)		
			TCP / TCP-F (AH725 / SH725)	TCS (AH7025)	TCG (AH7025)
P	Low carbon steel 1015, etc.	260 - 590	0.001 - 0.004	0.001 - 0.006	0.001 - 0.005
	Carbon steel, Alloy steel 1055, etc.	260 - 590	0.001 - 0.004	0.001 - 0.006	0.001 - 0.005
	Prehardened steel NAK80, PX5, etc.	260 - 590	0.001 - 0.004	0.001 - 0.006	0.001 - 0.005
M	Stainless steel S30400, etc.	160 - 390	0.001 - 0.004	0.001 - 0.006	0.001 - 0.005
K	Gray cast iron No.250B, No.300B, etc.	160 - 590	0.001 - 0.004	0.001 - 0.006	0.001 - 0.005
	Ductile cast iron 60-40-18, 80-55-06, etc.	160 - 590	0.001 - 0.004	0.001 - 0.006	0.001 - 0.005
S	Titanium alloys Ti-6Al-4V, etc.	60 - 260	0.001 - 0.004	0.001 - 0.006	0.001 - 0.005
	Superalloys Inconel718, etc.	60 - 260	0.001 - 0.004	0.001 - 0.006	0.001 - 0.005

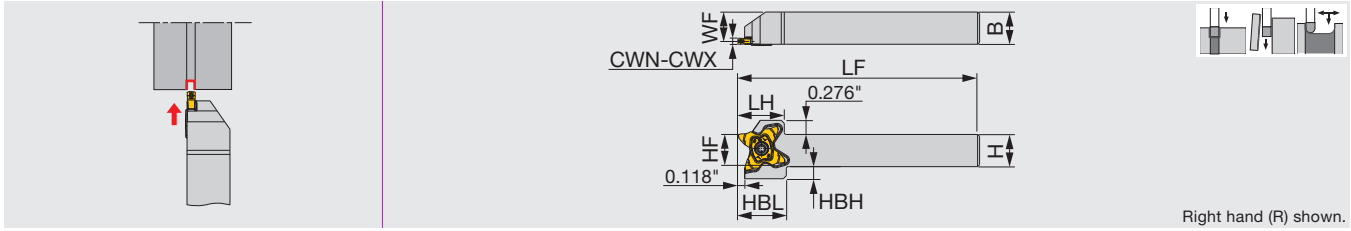

Inch	CWN	CWX	H	B	LF	LH	HBL	HF	WF	HBH	Insert	Torque
STCR/L06-27	0.02	0.125	0.375	0.375	5.000	0.906	0.945	0.375	0.315	0.374	TC*27...	1.84
STCR/L08-27	0.02	0.125	0.500	0.500	5.000	0.906	0.945	0.500	0.440	0.287	TC*27...	1.84
STCR/L10-27	0.02	0.125	0.625	0.625	5.000	0.906	0.945	0.625	0.570	0.236	TC*27...	1.84
STCR/L12-27	0.02	0.125	0.750	0.750	5.000	0.906	0.945	0.750	0.690	0.118	TC*27...	1.84
STCR/L16-27	0.02	0.125	1.000	1.000	5.000	0.906	-	1.000	0.940	-	TC*27...	1.84

Torque: Recommended clamping torque: lbs-ft

SPARE PARTS

Designation	Screw	Wrench
STCR**-27	SR16-212-01397L	T-2010/5
STCL**-27	SR16-212-01397	T-2010/5

STCR/L-27-CHP



Precision grooving tools with uniquely shaped insert with 4 cutting edges and channel for high pressure coolant supply

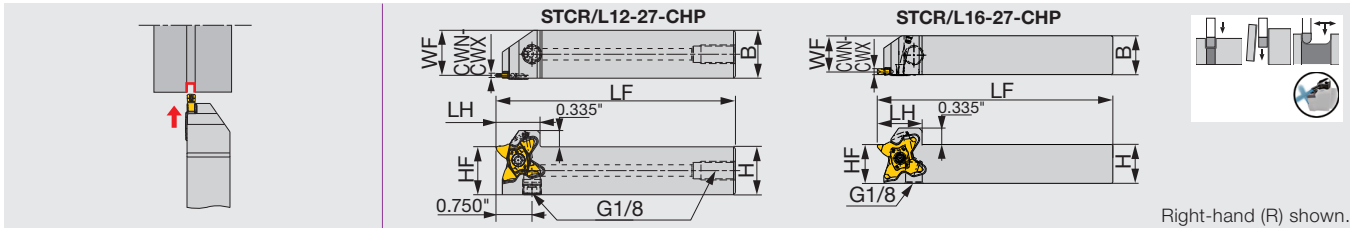

Inch	CWN	CWX	H	B	LF	LH	HF	WF	Insert	Torque
STCR/L12-27-CHP	0.020	0.125	0.750	0.750	5.000	0.906	0.750	0.690	TC*27...	1.84
STCR/L16-27-CHP	0.020	0.125	1.000	1.000	4.920	0.906	1.000	0.940	TC*27...	1.84

Metric	CWN	CWX	H	B	LF	LH	HF	WF	Insert	Torque*
STCR/L2020-27-CHP	0.5	3.18	20	20	120	23	20	18.5	TC*27...	2.5
STCR/L2525-27-CHP	0.5	3.18	25	25	125	23	25	23.5	TC*27...	2.5

Torque: Recommended clamping torque: lbs-ft (*N·m)

SPARE PARTS

Designation	Screw	Wrench
STCR...-27-CHP	SR16-212-01397L	T-2010/5
STCL...-27-CHP	SR16-212-01397	T-2010/5

Grooving and parting-off tool with high pressure coolant capability

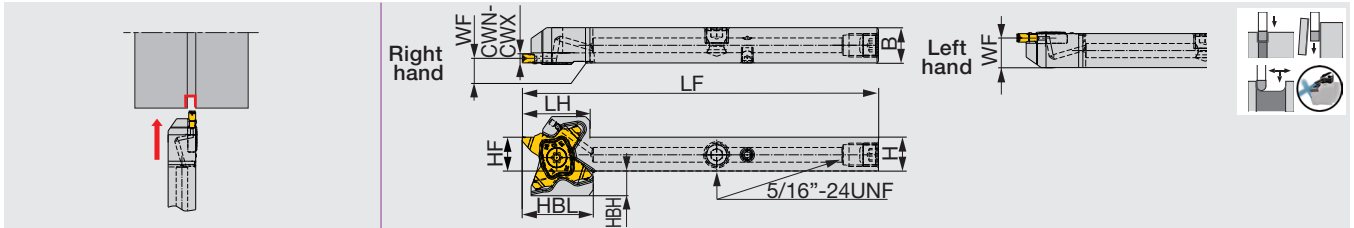

Inch	CWN	CWX	H	B	LF	LH	HF	WF ⁽¹⁾	HBH	HBL	Insert	Torque
STCR/L08-27-CHP	0.200	0.125	0.500	0.500	4.750	0.906	0.500	0.590/0.441	0.287	0.945	TC*27...	1.84

Make sure to avoid tool interferences when used on Swiss machines
Torque: Recommended clamping torque: lb-ft
(1) The above WF value is valid when an insert width of CW=3 is mounted.

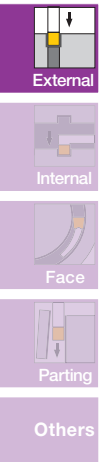

Modular-type external grooving and parting blade, with high pressure coolant capability

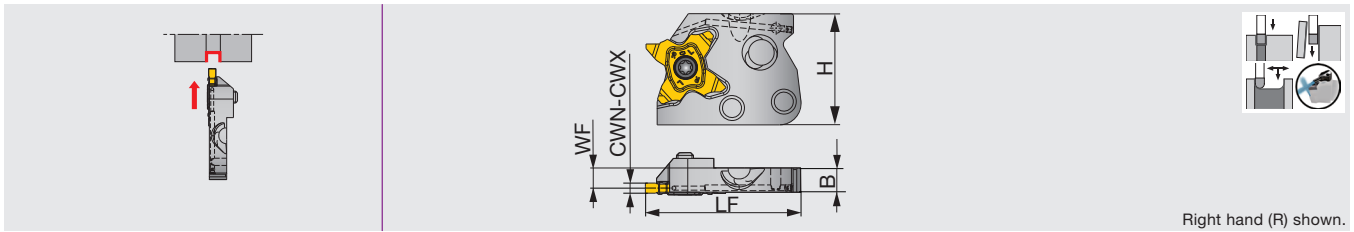

Inch	CWN	CWX	WF	H	LF	B	Insert	Torque
STCAR/L27-CHP	0.020	0.125	0.236	1.299	1.811	0.283	TC*27...	1.84

Torque: Recommended clamping torque: lb-ft

SPARE PARTS

Designation	Screw	Wrench
STCAR27-CHP	SR16-212-01397L	T-2010/5
STCAL27-CHP	SR16-212-01397	T-2010/5

Reference pages: Inserts → **F053 - F056**, Standard cutting conditions → **F057**
Parts for coolant hose → **F240**

CHSR/L-CHP

Shank for blades with high pressure coolant capability

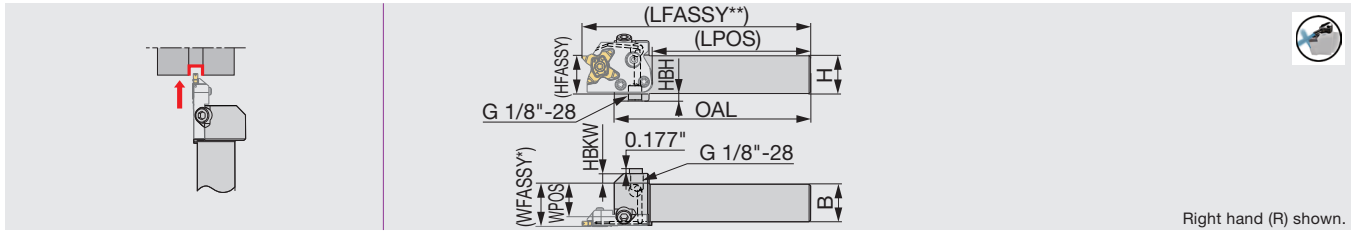

Right hand (R) shown.

Inch	H	B	OAL	LPOS	WPOS	HBKW	HFASSY	HBH
CHSR/L12-CHP	0.750	0.750	5.000	4.035	0.560	0.510	0.750	0.190
CHSR/L16-CHP	1.000	1.000	5.000	4.035	0.810	0.260	1.000	0.200

*WFASSY : shank (WPOS) + blade (WF)

**LFASSY : shank (LPOS) + blade (LF)

Use right-hand blades (R) with right-hand shanks (R); and left-hand blades (L) with left-hand shanks (L).

Applicable for 30 MPa coolant

Please see the page L043 for the instruction on installing and removing the blade.

SPARE PARTS

Designation	Clamping screw 1	Wrench 1	Clamping screw 2	Clamping screw 3	Wrench 2	O-ring	Plug
CHSR/L*-CHP	SRM5-04451	T-20/5	SRM6X12DIN6912	SRM6X20-XT	HW5.0	OR5X1N	PLUGG1/8ISO1179

Recommended clamping torque (lbf-ft, N-m)

Clamping screw	Torque (lbf-ft)	Torque (N-m)
SRM5-04451	3.69	5
SRM6X12DIN6912	6.27	8.5
SRM6X20-XT	6.27	8.5

CHFVR/L-CHP

Shank for blades with high pressure coolant capability

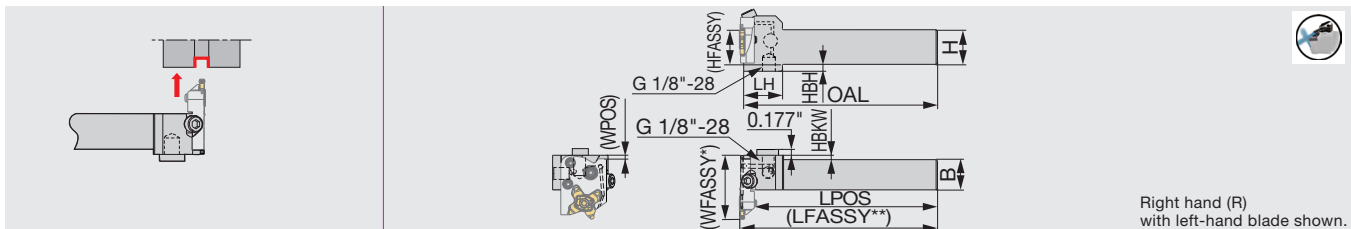

Right hand (R) with left-hand blade shown.

Inch	H	B	OAL	LPOS	WPOS	LH	HBKW	HFASSY	HBH
CHFVR/L12-CHP	0.750	0.750	5.500	5.307	0.020	1.100	0.234	0.750	10
CHFVR/L16-CHP	1.000	1.000	5.500	5.307	0.020	1.100	-	1.000	5

*WFASSY : shank (WPOS) + blade (LF)

**LFASSY : shank (LPOS) + blade (WF)

Use left-hand blades (L) with right-hand shanks (R); and right-hand blades (R) with left-hand shanks (L).

Applicable for 30 MPa coolant

Please see the page L043 for the instruction on installing and removing the blade.

SPARE PARTS

Designation	Clamping screw 1	Wrench 1	Clamping screw 2	Clamping screw 3	Wrench 2	O-ring	Plug
CHFVR/L*-CHP	SRM5-04451	T-20/5	SRM6X12DIN6912	SRM6X20-XT	HW5.0	OR5X1N	PLUGG1/8ISO1179

Reference pages: Inserts → F053 - F056, Standard cutting conditions → F057
Parts for coolant hose → F240

Grade
Insert
Toolholder
Ext. Toolholder
Int. Toolholder
Threading
Grooving
Miniature Tool
Endmill
Drilling Tool
Drilling System
User's Guide
Index



C*CHSN-CHP

TungCap shank for CAER/L-CHP blades with high pressure coolant capability

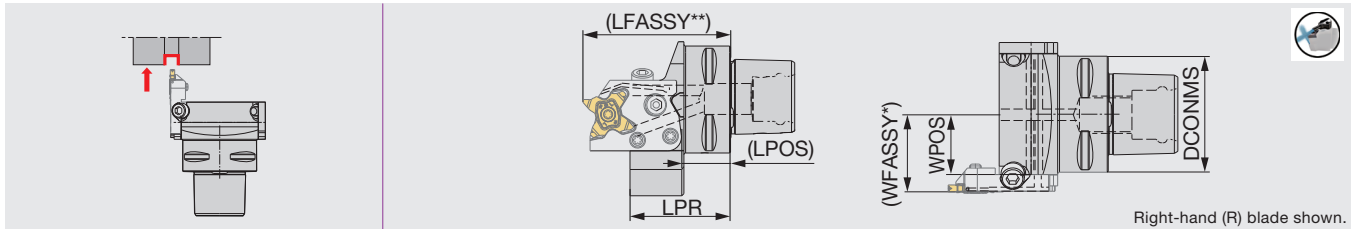

Right-hand (R) blade shown.

Metric	DCONMS	LPR	LPOS	WPOS
C3CHSN19045-CHP	32	45	17.5	18.5
C4CHSN21047-CHP	40	46.5	21.5	21
C5CHSN26047-CHP	50	47	22.5	26
C6CHSN33050-CHP	63	50	24.5	32.5

*WFASSY : shank (WPOS) + blade (WF)

**LFASSY : shank (LPOS) + blade (LF)

Applicable for 30 MPa coolant

Please see the page **L043** for the instruction on installing and removing the blade.

SPARE PARTS

Designation	Clamping screw 1	Wrench 1	Clamping screw 2	Clamping screw 3	Wrench 2	O-ring
C*CHSN**-CHP	SRM5-04451	T-20/5	SRM6X12DIN6912	SRM6X20-XT	HW5.0	OR5X1N

Recommended clamping torque (lbs-ft, N-m)

Clamping screw	Torque (lbs-ft)	Torque (N-m)
SRM5-04451	3.69	5
SRM6X12DIN6912	6.27	8.5
SRM6X20-XT	6.27	8.5



C*CHFVN-CHP

TungCap shank for CAER/L-CHP blades with high pressure coolant capability

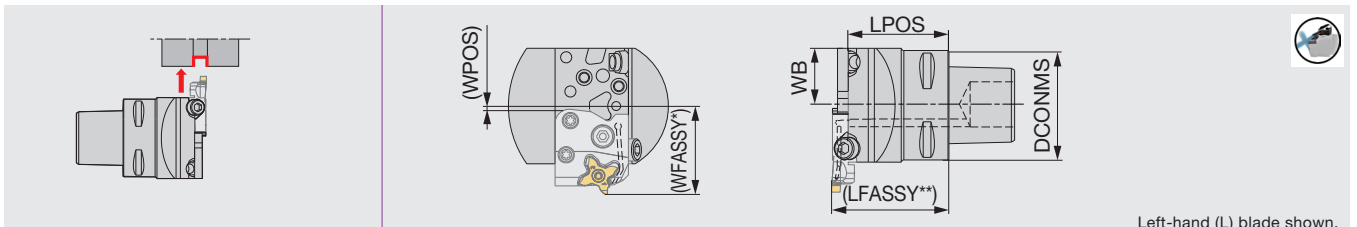

Left-hand (L) blade shown.

Inch	DCONMS	LPOS	WB	WPOS
C3CHFVN26040-CHP	1.260	1.575	1.024	0.059
C4CHFVN26046-CHP	1.575	1.811	1.024	0.059
C5CHFVN26046-CHP	1.969	1.811	1.024	0.059
C6CHFVN33046-CHP	2.480	1.811	1.299	0.335

*WFASSY : shank (WPOS) + blade (LF)

**LFASSY : shank (LPOS) + blade (WF)

Applicable for 30 MPa coolant

Please see the page **L043** for the instruction on installing and removing the blade.

SPARE PARTS

Designation	Clamping screw 1	Wrench 1	Clamping screw 2	Clamping screw 3	Wrench 2	O-ring
C*CHFVN**-CHP	SRM5-04451	T-20/5	SRM6X12DIN6912	SRM6X20-XT	HW5.0	OR5X1N

Recommended clamping torque (lbs-ft, N-m)

Clamping screw	Torque (lbs-ft)	Torque (N-m)
SRM5-04451	3.69	5
SRM6X12DIN6912	6.27	8.5
SRM6X20-XT	6.27	8.5

Reference pages: Inserts → **F053 - F026**, Standard cutting conditions → **F057**

INSERT - FOR GROOVING AND PARTING OFF

TCS27

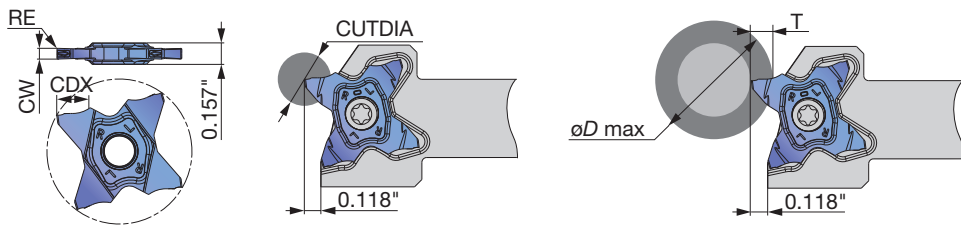

P	Steel	★
M	Stainless	★
K	Cast iron	★
N	Non-ferrous	★
S	Superalloys	★
H	Hard materials	★

★ : First choice
☆ : Second choice

Designation	CW±0.02 (mm)	CW±0.001 (in)	RE (in)	Coated AH725	CDX (in)	CUTDIA (in)	Relation of groove depth (T) and Max. diameter (øD max) (in)												
							T≤0.039	T≤0.079	T≤0.118	T≤0.138	T≤0.157	T≤0.177	T≤0.197	T≤0.217	T≤0.224	T≤0.236	T≤0.244	T≤0.252	
							TCS27-050-000	0.5	0.020	0	●	0.039	0.079	∞	-	-	-	-	-
TCS27-050-004	0.5	0.020	0.0016	●	0.098	0.197	∞	∞	-	-	-	-	-	-	-	-	-	-	-
TCS27-075-010	0.75	0.030	0.004	●	0.098	0.197	∞	∞	-	-	-	-	-	-	-	-	-	-	-
TCS27-080-000	0.8	0.031	0	●	0.063	0.126	∞	-	-	-	-	-	-	-	-	-	-	-	-
TCS27-100-006	1	0.039	0.0024	●	0.138	0.276	∞	∞	∞	23.622	-	-	-	-	-	-	-	-	-
TCS27-100-010	1	0.039	0.004	●	0.138	0.276	∞	∞	∞	23.622	-	-	-	-	-	-	-	-	-
TCS27-104-000	1.04	0.041	0	●	0.079	0.157	∞	∞	-	-	-	-	-	-	-	-	-	-	-
TCS27-120-000	1.2	0.047	0	●	0.079	0.157	∞	∞	-	-	-	-	-	-	-	-	-	-	-
TCS27-125-010	1.25	0.049	0.004	●	0.138	0.276	∞	∞	∞	23.622	-	-	-	-	-	-	-	-	-
TCS27-125-020	1.25	0.049	0.008	●	0.138	0.276	∞	∞	∞	23.622	-	-	-	-	-	-	-	-	-
TCS27-140-000	1.4	0.055	0	●	0.079	0.157	∞	∞	-	-	-	-	-	-	-	-	-	-	-
TCS27-147-000	1.47	0.058	0	●	0.098	0.197	∞	∞	-	-	-	-	-	-	-	-	-	-	-
TCS27-150-010	1.5	0.059	0.004	●	0.224	0.449	∞	∞	∞	23.622	11.024	7.087	5.118	1.969	1.378	-	-	-	-
TCS27-150-020	1.5	0.059	0.008	●	0.224	0.449	∞	∞	∞	23.622	11.024	7.087	5.118	1.969	1.378	-	-	-	-
TCS27-157-015	1.57	0.062	0.006	●	0.118	0.236	∞	∞	∞	-	-	-	-	-	-	-	-	-	-
TCS27-170-010	1.7	0.067	0.004	●	0.118	0.236	∞	∞	∞	-	-	-	-	-	-	-	-	-	-
TCS27-175-010	1.75	0.069	0.004	●	0.118	0.236	∞	∞	∞	-	-	-	-	-	-	-	-	-	-
TCS27-175-020	1.75	0.069	0.008	●	0.118	0.236	∞	∞	∞	-	-	-	-	-	-	-	-	-	-
TCS27-178-018	1.78	0.070	0.007	●	0.118	0.236	∞	∞	∞	-	-	-	-	-	-	-	-	-	-
TCS27-185-020	1.85	0.073	0.008	●	0.118	0.236	∞	∞	∞	-	-	-	-	-	-	-	-	-	-
TCS27-196-015	1.96	0.077	0.006	●	0.118	0.236	∞	∞	∞	-	-	-	-	-	-	-	-	-	-
TCS27-200-010	2	0.079	0.004	●	0.252	0.504	∞	∞	∞	23.622	11.024	7.087	5.118	4.134	3.346	2.362	1.969	1.181	-
TCS27-200-020	2	0.079	0.008	●	0.252	0.504	∞	∞	∞	23.622	11.024	7.087	5.118	4.134	3.346	2.362	1.969	1.181	-
TCS27-222-015	2.22	0.087	0.006	●	0.138	0.276	∞	∞	∞	23.622	-	-	-	-	-	-	-	-	-
TCS27-230-020	2.3	0.091	0.008	●	0.138	0.276	∞	∞	∞	23.622	-	-	-	-	-	-	-	-	-
TCS27-239-015	2.39	0.094	0.006	●	0.224	0.449	∞	∞	∞	23.622	11.024	7.087	5.118	1.969	1.378	-	-	-	-
TCS27-247-020	2.47	0.097	0.008	●	0.224	0.449	∞	∞	∞	23.622	11.024	7.087	5.118	1.969	1.378	-	-	-	-
TCS27-250-010	2.5	0.098	0.004	●	0.224	0.449	∞	∞	∞	23.622	11.024	7.087	5.118	1.969	1.378	-	-	-	-
TCS27-250-030	2.5	0.098	0.012	●	0.224	0.449	∞	∞	∞	23.622	11.024	7.087	5.118	1.969	1.378	-	-	-	-
TCS27-270-010	2.7	0.106	0.004	●	0.244	0.488	∞	∞	∞	23.622	11.024	7.087	5.315	4.134	3.740	3.346	3.071	-	-
TCS27-287-020	2.87	0.113	0.008	●	0.244	0.488	∞	∞	∞	23.622	11.024	7.087	5.315	4.134	3.740	3.346	3.071	-	-
TCS27-300-000	3	0.118	0	●	0.252	0.504	∞	∞	∞	23.622	11.024	7.087	5.315	4.134	3.740	3.346	3.071	2.165	-
TCS27-300-020	3	0.118	0.008	●	0.252	0.504	∞	∞	∞	23.622	11.024	7.087	5.315	4.134	3.740	3.346	3.071	2.165	-
TCS27-300-030	3	0.118	0.012	●	0.252	0.504	∞	∞	∞	23.622	11.024	7.087	5.315	4.134	3.740	3.346	3.071	2.165	-
TCS27-300-040	3	0.118	0.016	●	0.252	0.504	∞	∞	∞	23.622	11.024	7.087	5.315	4.134	3.740	3.346	3.071	2.165	-
TCS27-315-015	3.15	0.124	0.006	●	0.252	0.504	∞	∞	∞	23.622	11.024	7.087	5.315	4.134	3.740	3.346	3.071	2.677	-
TCS27-318-020	3.18	0.125	0.008	●	0.252	0.504	∞	∞	∞	23.622	11.024	7.087	5.315	4.134	3.740	3.346	3.071	2.677	-

5 pieces per package
● : Line up

Reference pages: Toolholders → F049 - F052, Standard cutting conditions → F057



INSERT- FOR PARTING OFF

TCS27-R/L

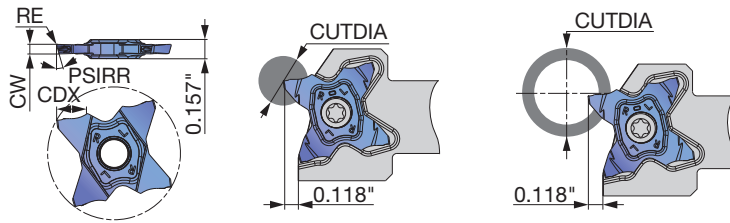

Right hand (R) shown.

P	Steel	★		
M	Stainless	★		
K	Cast iron	★		
N	Non-ferrous			
S	Superalloys	★		
H	Hard materials			

★ : First choice
☆ : Second choice

Designation	HAND	CW±0.02 (mm)	CW±0.001 (in)	RE (in)	Coated		CDX (in)	PSIRL	PSIRR	Max. parting off dia. CUTDIA (in)	
					AH725					Solid bar	Tube
TCS27-100-15R	R	1	0.039	0.0024	●		0.138	0°	15°	0.276	23.622
TCS27-100-15L	L	1	0.039	0.0024	●		0.138	15°	0°	0.276	23.622
TCS27-150-6R	R	1.5	0.059	0.0024	●		0.224	0°	6°	0.449	1.378
TCS27-150-6L	L	1.5	0.059	0.0024	●		0.224	6°	0°	0.449	1.378
TCS27-150-15R	R	1.5	0.059	0.0024	●		0.224	0°	15°	0.449	1.378
TCS27-150-15L	L	1.5	0.059	0.0024	●		0.224	15°	0°	0.449	1.378
TCS27-200-6R	R	2	0.079	0.004	●		0.252	0°	6°	0.504	1.181
TCS27-200-6L	L	2	0.079	0.004	●		0.252	6°	0°	0.504	1.181
TCS27-200-15R	R	2	0.079	0.004	●		0.252	0°	15°	0.504	1.181
TCS27-200-15L	L	2	0.079	0.004	●		0.252	15°	0°	0.504	1.181

5 pieces per package
● : Line up

INSERT- FOR GROOVING AND PROFILING

TCS27 (Full R)

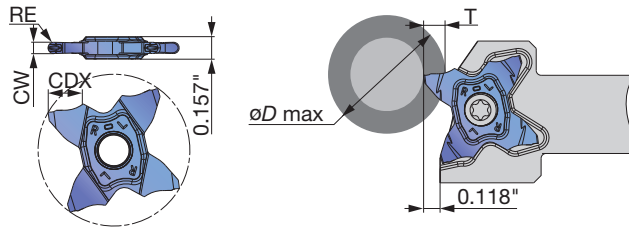

P	Steel	★		
M	Stainless	★		
K	Cast iron	★		
N	Non-ferrous			
S	Superalloys	★		
H	Hard materials			

★ : First choice
☆ : Second choice

Designation	CW±0.02 (mm)	CW±0.001 (in)	RE (in)	Coated		CDX (in)	Relation of groove depth (T) and Max. diameter (øD max) (in)											
				AH725			T≤0.039	T≤0.079	T≤0.118	T≤0.138	T≤0.157	T≤0.177	T≤0.197	T≤0.217	T≤0.224	T≤0.236	T≤0.244	T≤0.252
TCS27-157-079	1.57	0.062	0.031	●		0.118	∞	-	-	-	-	-	-	-	-	-	-	
TCS27-200-100	2	0.079	0.039	●		0.118	∞	-	-	-	-	-	-	-	-	-	-	
TCS27-239-120	2.39	0.094	0.047	●		0.224	∞	23.622	11.024	7.087	5.118	1.969	1.378	-	-	-	-	
TCS27-300-150	3	0.118	0.059	●		0.252	∞	23.622	11.024	7.087	5.315	4.134	3.740	3.346	3.071	2.165		

5 pieces per package
● : Line up

Reference pages: Toolholders → **F049 - F052**, Standard cutting conditions → **F057**

INSERT- FOR GROOVING AND PARTING OFF

TCM27

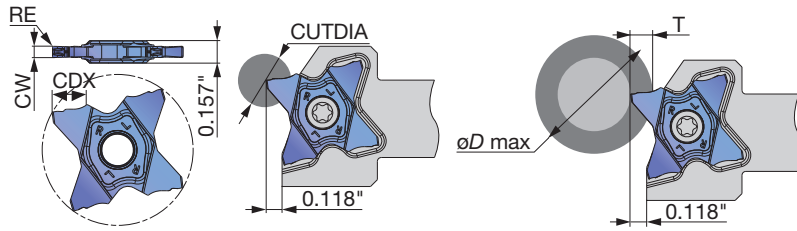

P	Steel	★	
M	Stainless	★	
K	Cast iron	★	
N	Non-ferrous		
S	Superalloys	★	
H	Hard materials		

★ : First choice
☆ : Second choice

Designation	CW±0.02 (mm)	CW±0.001 (in)	RE (in)	Coated		CDX (in)	CUTDIA (in)	Relation of groove depth (T) and Max. diameter (øD max) (in)									
				AH725				T≤0.039	T≤0.138	T≤0.157	T≤0.177	T≤0.197	T≤0.217	T≤0.224	T≤0.236	T≤0.244	T≤0.252
								T≤0.079	T≤0.118								
TCM27-150-010	1.5	0.059	0.004	●		0.224	0.449	∞	23.622	11.024	7.087	5.118	1.969	1.378	-	-	-
TCM27-150-020	1.5	0.059	0.008	●		0.224	0.449	∞	23.622	11.024	7.087	5.118	1.969	1.378	-	-	-
TCM27-157-015	1.57	0.062	0.006	●		0.118	0.236	∞	-	-	-	-	-	-	-	-	-
TCM27-170-010	1.7	0.067	0.004	●		0.118	0.236	∞	-	-	-	-	-	-	-	-	-
TCM27-175-010	1.75	0.069	0.004	●		0.118	0.236	∞	-	-	-	-	-	-	-	-	-
TCM27-175-020	1.75	0.069	0.008	●		0.118	0.236	∞	-	-	-	-	-	-	-	-	-
TCM27-178-018	1.78	0.070	0.007	●		0.118	0.236	∞	-	-	-	-	-	-	-	-	-
TCM27-185-020	1.85	0.073	0.008	●		0.118	0.236	∞	-	-	-	-	-	-	-	-	-
TCM27-196-015	1.96	0.077	0.006	●		0.118	0.236	∞	-	-	-	-	-	-	-	-	-
TCM27-200-010	2	0.079	0.004	●		0.252	0.504	∞	23.622	11.024	7.087	5.118	4.134	3.346	2.362	1.969	1.181
TCM27-200-020	2	0.079	0.008	●		0.252	0.504	∞	23.622	11.024	7.087	5.118	4.134	3.346	2.362	1.969	1.181
TCM27-222-015	2.22	0.087	0.006	●		0.138	0.276	∞	23.622	-	-	-	-	-	-	-	-
TCM27-230-020	2.3	0.091	0.008	●		0.138	0.276	∞	23.622	-	-	-	-	-	-	-	-
TCM27-239-015	2.39	0.094	0.006	●		0.224	0.449	∞	23.622	11.024	7.087	5.118	1.969	1.378	-	-	-
TCM27-247-020	2.47	0.097	0.008	●		0.224	0.449	∞	23.622	11.024	7.087	5.118	1.969	1.378	-	-	-
TCM27-250-010	2.5	0.098	0.004	●		0.224	0.449	∞	23.622	11.024	7.087	5.118	1.969	1.378	-	-	-
TCM27-250-030	2.5	0.098	0.012	●		0.224	0.449	∞	23.622	11.024	7.087	5.118	1.969	1.378	-	-	-
TCM27-270-010	2.7	0.106	0.004	●		0.244	0.488	∞	23.622	11.024	7.087	5.315	4.134	3.740	3.346	3.071	-
TCM27-287-020	2.87	0.113	0.008	●		0.244	0.488	∞	23.622	11.024	7.087	5.315	4.134	3.740	3.346	3.071	-
TCM27-300-000	3	0.118	0	●		0.252	0.504	∞	23.622	11.024	7.087	5.315	4.134	3.740	3.346	3.071	2.165
TCM27-300-020	3	0.118	0.008	●		0.252	0.504	∞	23.622	11.024	7.087	5.315	4.134	3.740	3.346	3.071	2.165
TCM27-300-030	3	0.118	0.012	●		0.252	0.504	∞	23.622	11.024	7.087	5.315	4.134	3.740	3.346	3.071	2.165
TCM27-300-040	3	0.118	0.016	●		0.252	0.504	∞	23.622	11.024	7.087	5.315	4.134	3.740	3.346	3.071	2.165
TCM27-315-015	3.15	0.124	0.006	●		0.252	0.504	∞	23.622	11.024	7.087	5.315	4.134	3.740	3.346	3.071	2.677
TCM27-318-020	3.18	0.125	0.008	●		0.252	0.504	∞	23.622	11.024	7.087	5.315	4.134	3.740	3.346	3.071	2.677

5 pieces per package
● : Line up

INSERT - FOR GROOVING AND PROFILING

TCM27 (Full R)

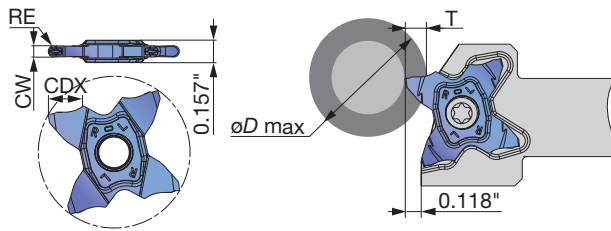

P	Steel	★	
M	Stainless	★	
K	Cast iron	★	
N	Non-ferrous		
S	Superalloys	★	
H	Hard materials		

★ : First choice
☆ : Second choice

Designation	CW±0.02 (mm)	CW±0.001 (in)	RE (in)	Coated		CDX (in)	CUTDIA (in)	Relation of groove depth (T) and Max. diameter (øD max) (in)									
				AH725				T≤0.039	T≤0.138	T≤0.157	T≤0.177	T≤0.197	T≤0.217	T≤0.224	T≤0.236	T≤0.244	T≤0.252
								T≤0.079	T≤0.118								
TCM27-157-079	1.57	0.059	0.031	●		0.118	0.236	∞	-	-	-	-	-	-	-	-	-
TCM27-200-100	2	0.059	0.039	●		0.118	0.236	∞	23.622	-	-	-	-	-	-	-	-
TCM27-239-120	2.39	0.062	0.047	●		0.224	0.449	∞	23.622	11.024	7.087	5.118	1.969	1.378	-	-	-
TCM27-300-150	3	0.125	0.059	●		0.252	0.504	∞	23.622	11.024	7.087	5.315	4.134	3.740	3.346	3.071	2.165

5 pieces per package
● : Line up

CHIPBREAKER

TCS27

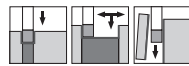
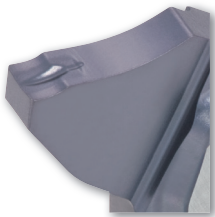

CW = 0.020" - 0.125" (0.5 mm – 3.18 mm)
For general machining, lower cutting force and superior sharpness.

TCM27

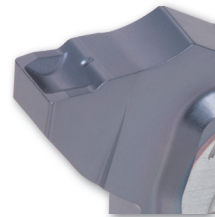

CW = 0.059" - 0.125" (1.5 mm – 3.18 mm)
For high feed machining. Well-designed edge with high strength and fracture resistance.

STANDARD CUTTING CONDITIONS

ISO	Workpiece materials	Grades	Cutting speed Vc (sfm)	Feed: f (ipr)					Depth of cut for profiling Turning (full radius)
				Grooving, Parting		Parting (with hand)	Turning (full radius)		
				TCS	TCM	TCS	TCS	TCM	
P	Steel 1045, etc.	AH725	330 - 660	0.002 - 0.006	0.002 - 0.010	0.0016 - 0.005	0.002 - 0.004	0.002 - 0.006	0.020
	Alloy steel 4137, etc.	AH725	165 - 590	0.002 - 0.006	0.002 - 0.010	0.0016 - 0.005	0.002 - 0.004	0.002 - 0.006	0.020
M	Stainless steel 304, etc.	AH725	165 - 490	0.002 - 0.006	0.002 - 0.008	0.0016 - 0.005	0.002 - 0.004	0.002 - 0.006	0.020
K	Gray cast iron No.250, etc.	AH725	165 - 590	0.002 - 0.006	0.002 - 0.010	0.0016 - 0.005	0.002 - 0.004	0.002 - 0.006	0.020
	Ductile cast iron 60-40-18, etc.	AH725	165 - 390	0.002 - 0.006	0.002 - 0.008	0.0016 - 0.005	0.002 - 0.004	0.002 - 0.006	0.020
S	Titanium alloys Ti-6Al-4V, etc.	AH725	100 - 200	0.002 - 0.006	0.002 - 0.006	0.0016 - 0.005	0.002 - 0.004	0.002 - 0.004	0.020
	Superalloys Inconel718, etc.	AH725	65 - 165	0.002 - 0.006	0.002 - 0.006	0.0016 - 0.005	0.002 - 0.004	0.002 - 0.004	0.020

Grade
Insert
Ext. Toolholder
Int. Toolholder
Threading
Grooving
Miniature Tool
Endmill
Drilling Tool
Tooling System
User's Guide
Index



MY-T SERIES

CGWSR/L-W

External grooving, parting and turning toolholder, for 2 corner inserts

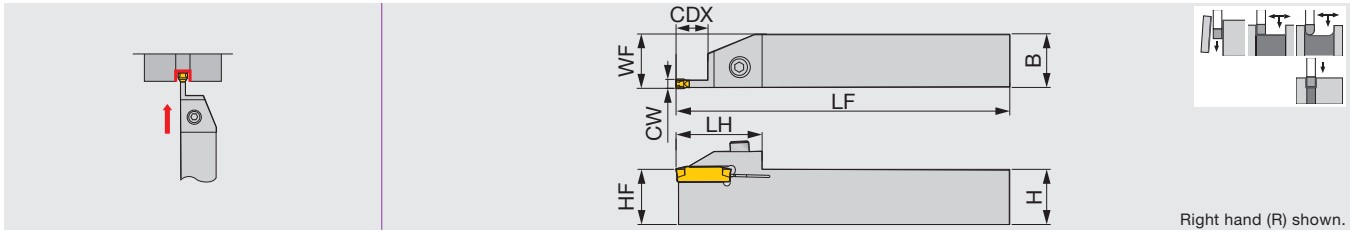

Metric	CW	CDX	H	B	LF	LH	HF	WF	Insert	Torque
CGWSR/L1616-W30	3	12	16	16	125	34	16	16.4	WG*30, WGE30R/L	5
CGWSR/L2020-W30	3	12	20	20	150	34	20	20.4	WG*30, WGE30R/L	5
CGWSR/L2525-W30	3	12	25	25	150	34	25	25.4	WG*30, WGE30R/L	5
CGWSR/L2020-W40	4	13	20	20	150	39	20	20.4	WG*40, WGE40R/L	5
CGWSR/L2525-W40	4	13	25	25	150	39	25	25.4	WG*40, WGE40R/L	5
CGWSR/L2020-W50	5	13	20	20	150	39	20	20.4	WG*50, WGE50R/L	5
CGWSR/L2525-W50	5	13	25	25	150	39	25	25.4	WG*50, WGE50R/L	5

Torque: Recommended clamping torque: N·m

SPARE PARTS

Designation	Clamping screw	Wrench
CGWSR/L***-W...	CHHM5-18	P-4

MY-T SERIES

CGWSR/L-W-L

External deep grooving, parting and turning toolholder, for 2 corner inserts

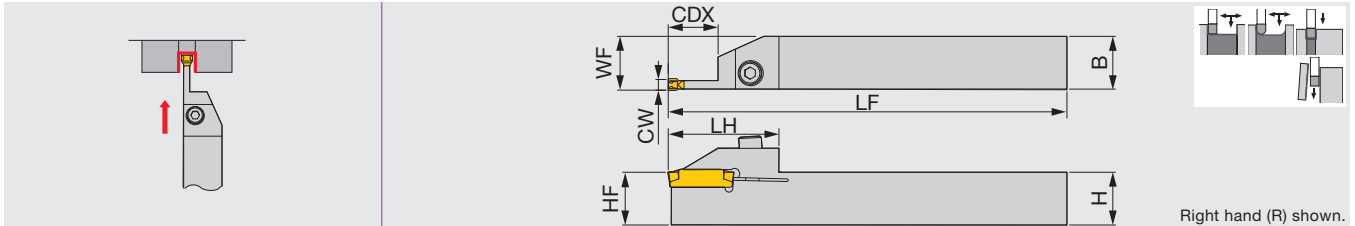

Metric	CW	CDX	H	B	LF	LH	HF	WF	Insert	Torque
CGWSR/L1616-W20-L	2	15	16	16	125	37	16	16.2	WGE20, WGE20R/L	5
CGWSR/L2020-W20-L	2	15	20	20	150	37	20	20.2	WGE20, WGE20R/L	5
CGWSR/L2525-W20-L	2	15	25	25	150	37	25	25.2	WGE20, WGE20R/L	5
CGWSR/L1616-W30-L	3	16.5, 17.5	16	16	125	37	16	16.4	WG*30, WGE30R/L	5
CGWSR/L2020-W30-L	3	16.5, 17.5	20	20	150	37	20	20.4	WG*30, WGE30R/L	5
CGWSR/L2525-W30-L	3	16.5, 17.5	25	25	150	37	25	25.4	WG*30, WGE30R/L	5
CGWSR/L2020-W40-L	4	21, 21.5	20	20	150	42	20	20.4	WG*40, WGE40R/L	5
CGWSR/L2525-W40-L	4	21, 21.5	25	25	150	42	25	25.4	WG*40, WGE40R/L	5
CGWSR/L2020-W50-L	5	21	20	20	150	42	20	20.4	WG*50, WGE50R/L	5
CGWSR/L2525-W50-L	5	21	25	25	150	42	25	25.4	WG*50, WGE50R/L	5

Torque: Recommended clamping torque: N·m

SPARE PARTS

Designation	Clamping screw	Wrench
CGWSR/L***-W**-L	CHHM5-18	P-4

Reference pages: Inserts → **F065 - F066**, Standard cutting conditions → **F067**

MY-T SERIES

CGWSR/L-WG

External grooving, parting and turning toolholder, for 2 corner inserts

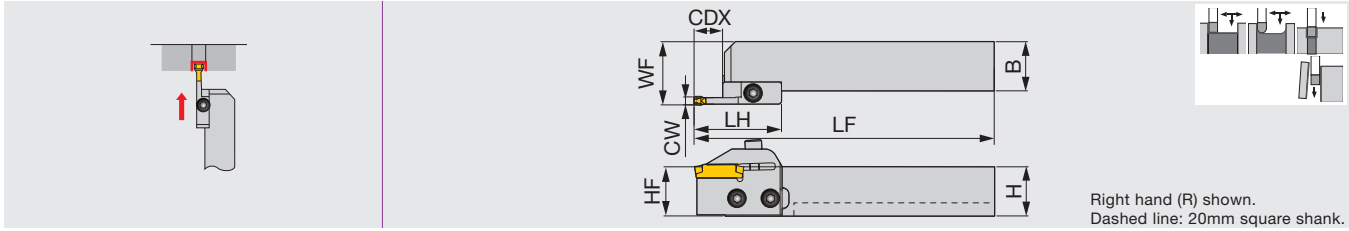

Metric	CW	CDX	H	B	LF	LH	HF	WF	Insert	Shank	Blade	Torque
CGWSR/L2020-W30GR/L	3	12	20	20	150.5	43.5	20	26.9	WG*30, WGE30R/L	CGWSR/L2020	W30GR/L	5
CGWSR/L2525-W30GR/L	3	12	25	25	150.5	43.5	25	31.9	WG*30, WGE30R/L	CGWSR/L2525	W30GR/L	5
CGWSR/L2020-W40GR/L	4	13	20	20	151.5	44.5	20	26.9	WG*40, WGE40R/L	CGWSR/L2020	W40GR/L	5
CGWSR/L2525-W40GR/L	4	13	25	25	151.5	44.5	25	31.9	WG*40, WGE40R/L	CGWSR/L2525	W40GR/L	5
CGWSR/L2020-W50GR/L	5	13	20	20	151.5	44.5	20	26.9	WG*50, WGE50R/L	CGWSR/L2020	W50GR/L	5
CGWSR/L2525-W50GR/L	5	13	25	25	151.5	44.5	25	31.9	WG*50, WGE50R/L	CGWSR/L2525	W50GR/L	5

Use right-hand blades (R) with right-hand shanks (R); and left-hand blades (L) with left-hand shanks (L).
Blade sold separately.
Torque: Recommended clamping torque: N·m

SPARE PARTS

Designation	Clamping screw	Blade screw	Wrench
CGWSR/L***-W**GR/L	CHHM5-18	CSHB-6	P-4

MY-T SERIES

CGWSR/L-WG-L

External deep grooving, parting and turning toolholder, for 2 corner inserts

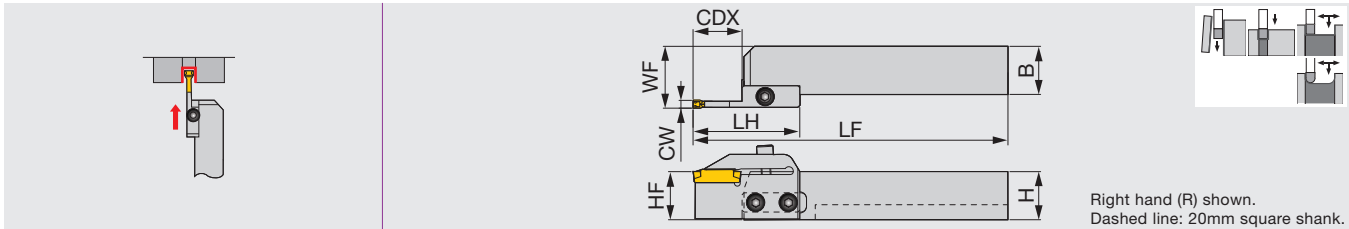

Metric	CW	CDX	H	B	LF	LH	HF	WF	Insert	Shank	Blade	Torque
CGWSR/L2020-W20GR/L-L	2	15	20	20	153.5	46.5	20	26.7	WGE20, WGE20R/L	CGWSR/L2020	W20GR/L-L	5
CGWSR/L2525-W20R/LR-L	2	15	25	25	153.5	46.5	25	31.7	WGE20, WGE20R/L	CGWSR/L2525	W20GR/L-L	5
CGWSR/L2020-W30GR/L-L	3	16.5 - 17.5	20	20	157.5	50.5	20	26.9	WG*30, WGE30R/L	CGWSR/L2020	W30GR/L-L	5
CGWSR/L2525-W30GR/L-L	3	16.5 - 17.5	25	25	157.5	50.5	25	31.9	WG*30, WGE30R/L	CGWSR/L2525	W30GR/L-L	5
CGWSR/L2020-W40GR/L-L	4	21 - 21.5	20	20	162.5	55.5	20	26.9	WG*40, WGE40R/L	CGWSR/L2020	W40GR/L-L	5
CGWSR/L2525-W40GR/L-L	4	21 - 21.5	25	25	162.5	55.5	25	31.9	WG*40, WGE40R/L	CGWSR/L2525	W40GR/L-L	5
CGWSR/L2020-W50GR/L-L	5	21	20	20	162.5	55.5	20	26.9	WG*50, WGE50R/L	CGWSR/L2020	W50GR/L-L	5
CGWSR/L2525-W50GR/L-L	5	21	25	25	162.5	55.5	25	31.9	WG*50, WGE50R/L	CGWSR/L2525	W50GR/L-L	5

Use right-hand blades (R) with right-hand shanks (R); and left-hand blades (L) with left-hand shanks (L).
Blade sold separately.
Torque: Recommended clamping torque: N·m

SPARE PARTS

Designation	Clamping screw	Blade screw	Wrench
CGWSR/L***-W**GR/L-L	CHHM5-18	CSHB-6	P-4

Reference pages: Inserts → **F065 - F066**, Standard cutting conditions → **F067**



MY-T SERIES

CGWSR/L-G

External grooving, parting and turning toolholder, for 1 corner inserts

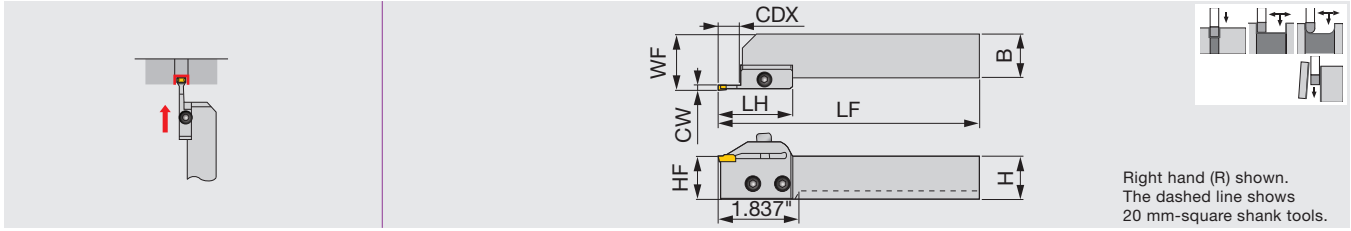

Right hand (R) shown.
The dashed line shows
20 mm-square shank tools.

Inch	CW	CDX	H	B	LF	LH	HF	WF	Insert	Shank	Blade	Torque
CGWSR/L12-20GR/L	0.079	0.472	0.750	0.750	5.913	1.699	0.787	1.055	GE20, GE20-AL	CGWSR/L12	20GR/L	3.69
CGWSR/L16-20GR/L	0.079	0.472	1.000	1.000	5.913	1.699	0.984	1.252	GE20, GE20-AL	CGWSR/L16	20GR/L	3.69
CGWSR/L12-30GR/L	0.118	0.472	0.750	0.750	5.913	1.699	0.787	1.063	G*30,GE30R/L,GE30-AL	CGWSR/L12	30GR/L	3.69
CGWSR/L16-30GR/L	0.118	0.472	1.000	1.000	5.913	1.699	0.984	1.260	G*30,GE30R/L,GE30-AL	CGWSR/L16	30GR/L	3.69
CGWSR/L12-40GR/L	0.157	0.472	0.750	0.750	5.913	1.699	0.787	1.067	G*40,GE40R/L,GE40-AL	CGWSR/L12	40GR/L	3.69
CGWSR/L16-40GR/L	0.157	0.472	1.000	1.000	5.913	1.699	0.984	1.264	G*40,GE40R/L,GE40-AL	CGWSR/L16	40GR/L	3.69
CGWSR/L12-50GR/L	0.197	0.472	0.750	0.750	5.913	1.699	0.787	1.071	G*50,GE50R	CGWSR/L12	50GR	3.69

Metric	CW	CDX	H	B	LF	LH	HF	WF	Insert	Shank	Blade	Torque*
CGWSR/L2020-20GR/L	2	12	20	20	150.2	43.15	20	26.8	GE20, GE20-AL	CGWSR/L2020	20GR/L	5
CGWSR/L2525-20GR/L	2	12	25	25	150.2	43.15	25	31.8	GE20, GE20-AL	CGWSR/L2525	20GR/L	5
CGWSR/L2020-30GR/L	3	12	20	20	150.2	43.15	20	27	G*30,GE30R/L,GE30-AL	CGWSR/L2020	30GR/L	5
CGWSR/L2525-30GR/L	3	12	25	25	150.2	43.15	25	32	G*30,GE30R/L,GE30-AL	CGWSR/L2525	30GR/L	5
CGWSR/L2020-40GR/L	4	12	20	20	150.2	43.15	20	27.1	G*40,GE40R/L,GE40-AL	CGWSR/L2020	40GR/L	5
CGWSR/L2525-40GR/L	4	12	25	25	150.2	43.15	25	32.1	G*40,GE40R/L,GE40-AL	CGWSR/L2525	40GR/L	5
CGWSR/L2020-50GR/L	5	12	20	20	150.2	43.15	20	27.2	G*50,GE50R	CGWSR/L2020	50GR	5

For diameter compensation values in traversing, see page **F111**.

Use right-hand blades (R) with right-hand shanks (R); and left-hand blades (L) with left-hand shanks (L).

Blade sold separately.

Torque: Recommended clamping torque: lbs-ft (*N·m)

SPARE PARTS

Designation	Clamping screw	Blade screw	Wrench
CGWSR/L**-*GR/L	CHHM5-18	CSHB-6	P-4



Reference pages: Inserts → **F069 - F072**, Standard cutting conditions → **F075**

MY-T SERIES

CGWTR/L-G

External grooving, parting and turning toolholder, for 1 corner inserts

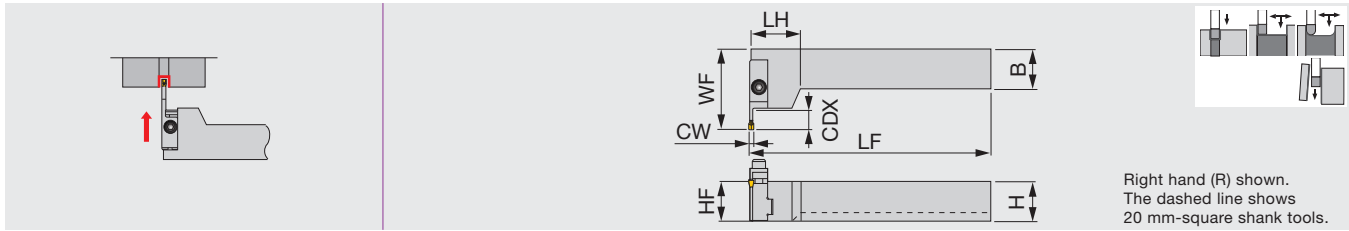

Inch	CW	CDX	H	B	LF	LH	HF	WF	Insert	Shank	Blade	Torque
CGWTR/L12-30GL/R	0.118	0.472	0.750	0.750	5.911	0.508	0.750	1.960	G*30,GE30R/L,GE30-AL	CGWTR/L12	30GL/R	3.69
CGWTR/L16-30GL/R	0.118	0.472	1.000	1.000	5.911	0.508	1.000	1.960	G*30,GE30R/L,GE30-AL	CGWTR/L16	30GL/R	3.69
CGWTR/L12-40GL/R	0.157	0.472	0.750	0.750	5.911	0.508	0.750	1.960	G*40,GE40R/L,GE40-AL	CGWTR/L12	40GL/R	3.69
CGWTR/L16-40GL/R	0.157	0.472	1.000	1.000	5.911	0.508	1.000	1.960	G*40,GE40R/L,GE40-AL	CGWTR/L16	40GL/R	3.69
CGWTR/L12-50GL/R	0.197	0.472	0.750	0.750	5.911	0.508	0.750	1.960	G*50,GE50R/L,GE50-AL	CGWTR/L12	50GL/R	3.69
CGWTR/L16-50GL/R	0.197	0.472	1.000	1.000	5.911	0.508	1.000	1.960	G*50,GE50R/L,GE50-AL	CGWTR/L16	50GL/R	3.69

Metric	CW	CDX	H	B	LF	LH	HF	WF	Insert	Shank	Blade	Torque*
CGWTR/L2020-30GL/R	3	12	20	20	150	12.9	20	49.9	G*30,GE30R/L,GE30-AL	CGWTR/L2020	30GL/R	5
CGWTR/L2525-30GL/R	3	12	25	25	150	12.9	25	49.9	G*30,GE30R/L,GE30-AL	CGWTR/L2525	30GL/R	5
CGWTR/L2020-40GL/R	4	12	20	20	150.1	12.9	20	49.9	G*40,GE40R/L,GE40-AL	CGWTR/L2020	40GL/R	5
CGWTR/L2525-40GL/R	4	12	25	25	150.1	12.9	25	49.9	G*40,GE40R/L,GE40-AL	CGWTR/L2525	40GL/R	5
CGWTR/L2020-50GL/R	5	12	20	20	150.2	12.9	20	49.9	G*50,GE50R/L,GE50-AL	CGWTR/L2020	50GL/R	5
CGWTR/L2525-50GL/R	5	12	25	25	150.2	12.9	25	49.9	G*50,GE50R/L,GE50-AL	CGWTR/L2525	50GL/R	5

For diameter compensation values in traversing, see page F111.
Use left-hand blades (L) with right-hand shanks (R); and right-hand blades (R) with left-hand shanks (L).
Torque: Recommended clamping torque: lbs·ft (*N·m)

SPARE PARTS

Designation	Clamping screw	Blade screw	Wrench
CGWTR/L**-*GL/R	CHHM5-18	CSHB-6	P-4

Reference pages: Inserts → F069 - F072, Standard cutting conditions → F075

Grade
Insert
Toolholder
Ext. Toolholder
Int. Toolholder
Threading
Grooving
Miniature Tool
Milling Cutter
Endmill
Drilling Tool
Tooling System
User's Guide
Index



MY-T SERIES

CGSSR/L

External grooving, parting and turning toolholder, for 1 corner inserts

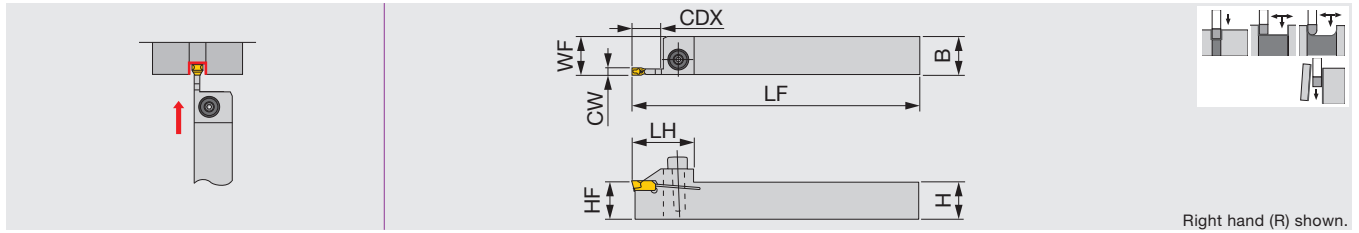

Right hand (R) shown.

Metric	CW	CDX	H	B	LF	LH	HF	WF	Insert	Torque
CGSSR/L1616-20	2	16	16	16	125	27	16	16.2	GE20, GE20-AL	5
CGSSR/L2020-20	2	16	20	20	150	27	20	20.2	GE20, GE20-AL	5
CGSSR/L2525-20	2	16	25	25	150	27	25	25.2	GE20, GE20-AL	5
CGSSR/L1616-30	3	12	16	16	125	27	16	16.5	G*30,GE30R/L,GE30-AL	5
CGSSR/L2020-30	3	12	20	20	150	27	20	20.5	G*30,GE30R/L,GE30-AL	5
CGSSR/L2525-30	3	12	25	25	150	27	25	25.5	G*30,GE30R/L,GE30-AL	5
CGSSR/L2020-40	4	12	20	20	150	27	20	20.6	G*40,GE40R/L,GE40-AL	5
CGSSR/L2525-40	4	12	25	25	150	27	25	25.6	G*40,GE40R/L,GE40-AL	5
CGSSR/L2020-50	5	12	20	20	150	27	20	20.7	G*50,GE50R/L,GE50-AL	5
CGSSR/L2525-50	5	12	25	25	150	27	25	25.7	G*50,GE50R/L,GE50-AL	5

Torque: Recommended clamping torque: N·m

SPARE PARTS

Designation	Clamping screw	Wrench
CGSSR/L...	CHHM5-18	P-4

MY-T SERIES

CGSSR/L-D

External grooving, parting and turning toolholder, for 1 corner inserts

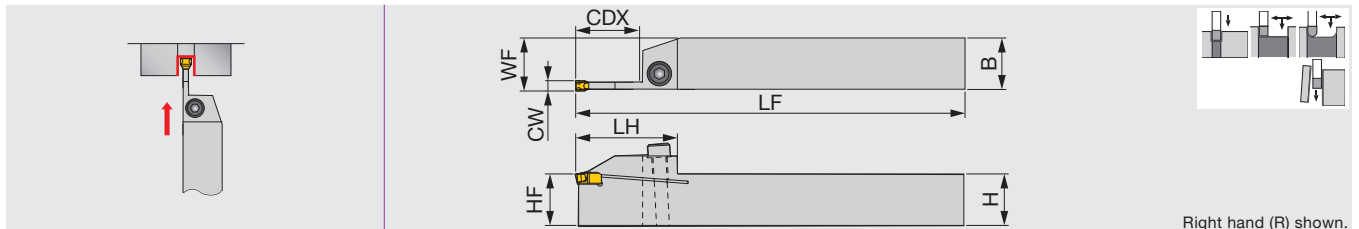

Right hand (R) shown.

Metric	CW	CDX	H	B	LF	LH	HF	WF	Insert	Torque
CGSSR/L1616-30D	3	22	16	16	125	36.2	16	16.5	G*30,GE30R/L,GE30-AL	5
CGSSR/L2020-30D	3	22	20	20	150	36.2	20	20.5	G*30,GE30R/L,GE30-AL	5
CGSSR/L2525-30D	3	22	25	25	150	36.2	25	25.5	G*30,GE30R/L,GE30-AL	5
CGSSR/L2020-40D	4	25	20	20	150	39.5	20	20.6	G*40,GE40R/L,GE40-AL	5
CGSSR/L2525-40D	4	25	25	25	150	39.5	25	25.6	G*40,GE40R/L,GE40-AL	5
CGSSR/L2020-50D	5	25	20	20	150	39.5	20	20.7	G*50,GE50R/L	5
CGSSR/L2525-50D	5	25	25	25	150	39.5	25	25.7	G*50,GE50R/L	5

Torque: Recommended clamping torque: N·m

SPARE PARTS

Designation	Clamping screw	Wrench
CGSSR/L***-D	CHHM5-18	P-4

Reference pages: Inserts → **F069 - F072**, Standard cutting conditions → **F075**

MY-T SERIES

JCGSSR/L

External grooving and parting toolholder, for Swiss lathes

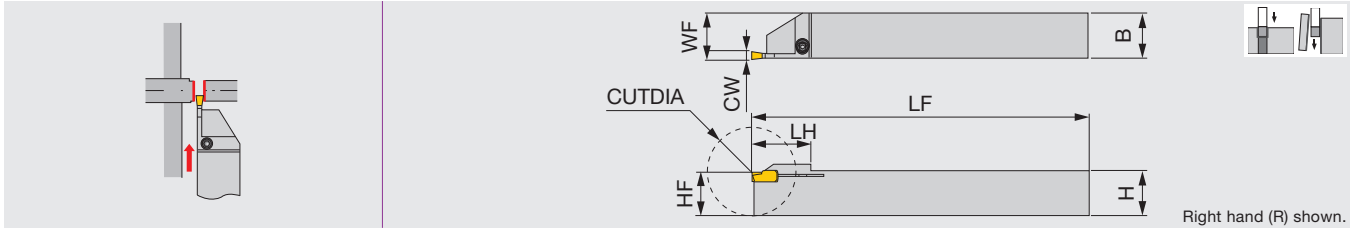

Metric	CW	CUTDIA	H	B	LF	LH	HF	WF	Insert	Torque
JCGSSR/L1010-20	2	20	10	10	125	15	10	10.2	GE20, GE20-AL	2.3
JCGSSR/L1212-20	2	25	12	12	125	19	12	12.2	GE20, GE20-AL	2.3
JCGSSR/L1616-20	2	32	16	16	125	22.5	16	16.2	GE20, GE20-AL	2.3

CUTDIA: Max. parting diameter

Torque: Recommended clamping torque: N·m

SPARE PARTS



Designation	Clamping screw	Wrench
JCGSSR/L...	CSTB-3	T-9F

MY-T SERIES

CGWSR/L

Shank for CGWSR/L-WG, -WG-L, -G, -CGD, -FL-G/TP, and -#S/D toolholders

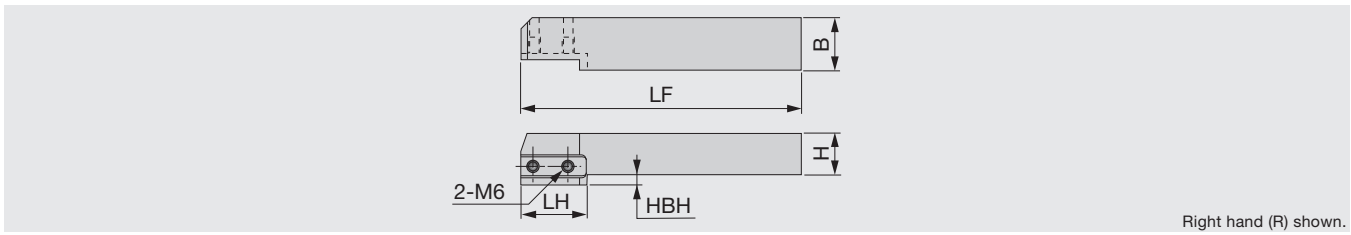

Inch	H	B	LF	LH	HBH
CGWSR/L12	0.750	0.750	5.400	1.180	0.250
CGWSR/L16	1.000	1.000	5.400	1.180	-

Metric	H	B	LF	LH	HBH
CGWSR/L2020	20	20	137	32.5	5
CGWSR/L2525	25	25	137	-	-

Right hand tool holders (R) use right hand cartridges (R). Left hand tool holders (L) use left hand cartridges (L).

SPARE PARTS



Designation	Blade screw
CGWSR/L...	CSHB-6

Reference pages: Inserts → **F069 - F072**, Standard cutting conditions → **F075**

MY-T SERIES

CGWSRL

Shank of toolholders. Vertical type with offset

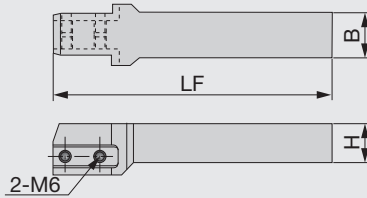

Inch	H	B	LF
CGWSRL12	0.75	0.75	5.40
CGWSRL16	1.00	1.00	5.40

Right (R) or Left (L) hand cartridges can be used in this toolholder

SPARE PARTS



Designation	Blade screw
CGWSRL...	CSHB-6



MY-T SERIES

CGWTR/L

Shank for CGWSR/L-WG, -WG-L, -G, -CGD, -FL-G/TP, and #S/D toolholders

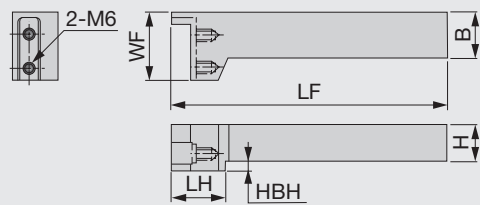

Right hand (R) shown.

Inch	H	B	LF	LH	WF	HBH
CGWTR/L12	0.75	0.75	6.00	1.20	1.50	0.234
CGWTR/L16	1.00	1.00	6.00	-	1.50	-

Metric	H	B	LF	LH	WF	HBH
CGWTR/L2020	20	20	150	30.5	37	5
CGWTR/L2525	25	25	150	-	37	-

Right hand tool holders (R) use left hand cartridges (L). Left hand tool holders (L) use right hand cartridges (R).

SPARE PARTS



Designation	Blade screw
CGWTR/L...	CSHB-6

Reference pages: Inserts → **F069 - F072**, Standard cutting conditions → **F075**

INSERT

WGE

For external grooving and parting

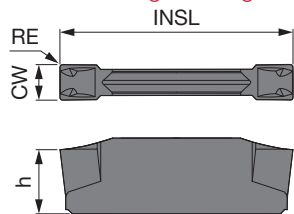

P	Steel	★	☆	★	★			★			
M	Stainless	★		★	★						
K	Cast iron	☆		★	☆			☆			
N	Non-ferrous										
S	Superalloys				☆						
H	Hard materials										

★ : First choice
☆ : Second choice

Designation	CW ₀ ^{+0.1} (mm)	CW ₀ ^{+0.004} (in)	RE (in)	Coated				Cermets		INSL (in)	h (in)
				T9225	T9125	AH120	GH730	NS9530			
WGE20	2	0.079	0.008	●	▲	●	●	●		0.787	0.185
WGE30	3	0.118	0.008	●	▲	●	●	●		0.787	0.217
WGE40	4	0.157	0.008	●	▲	●	●	●		0.984	0.224
WGE50	5	0.197	0.008	●	▲	●	●	●		0.984	0.232

● : Line up
▲ : To be discontinued

WGE(R/L)

For parting (with hand)

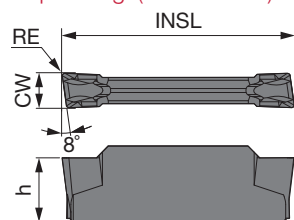

Right hand (R) shown.

P	Steel	★	★							
M	Stainless	★	★							
K	Cast iron	★	☆							
N	Non-ferrous									
S	Superalloys	☆								
H	Hard materials									

★ : First choice
☆ : Second choice

Designation	HAND	CW ₀ ^{+0.1} (mm)	CW ₀ ^{+0.004} (in)	RE (in)	Coated						INSL (in)	h (in)
					AH120	GH730						
WGE20R	R	2	0.079	0.008		●					0.787	0.185
WGE20L	L	2	0.079	0.008		●					0.787	0.185
WGE30R	R	3	0.118	0.008	●	●					0.787	0.217
WGE30L	L	3	0.118	0.008	●	●					0.787	0.217
WGE40R	R	4	0.157	0.008	●	●					0.984	0.224
WGE40L	L	4	0.157	0.008	●	●					0.984	0.224
WGE50R	R	5	0.197	0.008		●					0.984	0.232
WGE50L	L	5	0.197	0.008		●					0.984	0.232

● : Line up

Reference pages: Toolholders → F058 - F059



WGT

For turning (External grooving and parting)

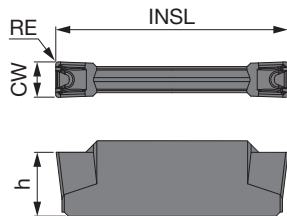

P	Steel	★	☆	★	★		★			
M	Stainless	★		★	★					
K	Cast iron	☆		★	☆		☆			
N	Non-ferrous									
S	Superalloys				☆					
H	Hard materials									

★ : First choice
☆ : Second choice

Designation	CW ^{+0.1} ₀ (mm)	CW ^{+0.004} ₀ (in)	RE (in)	Coated				Cermets			INSL (in)	h (in)
				T9225	T9125	AH120	GH730	NS9530				
WGT30	3	0.118	0.016	●	▲	●	●	●			0.787	0.217
WGT40	4	0.157	0.016	●	▲	●	●	●			0.984	0.224
WGT50	5	0.197	0.016	●	▲	●	●	●			0.984	0.232

● : Line up
▲ : To be discontinued



Others

WGR

For profiling (full radius)

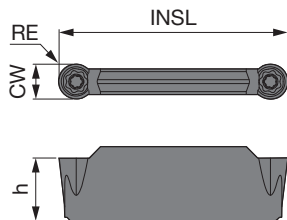

P	Steel	★	☆	★	★		★			
M	Stainless	★		★	★					
K	Cast iron	☆		★	☆		☆			
N	Non-ferrous									
S	Superalloys				☆					
H	Hard materials									

★ : First choice
☆ : Second choice

Designation	CW ^{+0.1} ₀ (mm)	CW ^{+0.004} ₀ (in)	RE (in)	Coated				Cermets			INSL (in)	h (in)
				T9225	T9125	AH120	GH730	NS9530				
WGR30	3	0.118	0.059	●	▲	●	●	●			0.787	0.217
WGR40	4	0.157	0.079	●	▲	●	●	●			0.984	0.224
WGR50	5	0.197	0.098	●	▲	●	●	●			0.984	0.232

● : Line up
▲ : To be discontinued

Reference pages: Toolholders → **F058 - F059**

STANDARD CUTTING CONDITIONS

ISO	Workpiece material	Grade	Cutting speed Vc (sfm)
P	Low carbon steel, Alloy steel (~ HB150)	T9225	262 - 984
		NS9530	328 - 656
		GH730	164 - 591
	Medium carbon steel, Alloy steel (HB150 ~ 250)	T9225	262 - 722
		NS9530	262 - 591
		GH730	164 - 492
High carbon steel, Alloy steel (HB250 ~)	T9225	262 - 722	
	NS9530	262 - 492	
	GH730	164 - 492	
M	Stainless steel	T9225	262 - 591
		GH730	164 - 394
K	Gray iron, Ductile cast iron	T9225	262 - 820
		GH730	164 - 591

Operation	Feed: <i>f</i> (ipr)			
	Groove width: CW (in)			
	2 mm (0.079")	3 mm (0.118")	4 mm (0.157")	5 mm (0.197")
Grooving (WGE**)	0.0024 - 0.008	0.0024 - 0.010	0.0028 - 0.011	0.0028 - 0.012
Parting (WGE**R/L)	0.0016 - 0.004	0.0016 - 0.006	0.0016 - 0.006	0.0016 - 0.006
Turning (WGT**)	-	ap = 0.020 - 0.059 f = 0.0024 - 0.008	ap = 0.020 - 0.079 f = 0.0024 - 0.010	ap = 0.020 - 0.098 f = 0.0024 - 0.011
Profiling (WGR**)	-	ap = 0.020 - 0.055 f = 0.002 - 0.010	ap = 0.020 - 0.059 f = 0.002 - 0.010	ap = 0.020 - 0.063 f = 0.002 - 0.012

Note: For diameter compensation values in traversing, see page **F111**.

Grade
Insert
Ext. Toolholder
Int. Toolholder
Threading
Grooving
Miniature Tool
Milling Cutter
Endmill
Drilling Tool
Tooling System
User's Guide
Index



2 corner insert

External grooving and parting

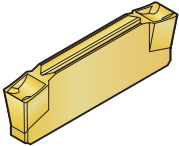
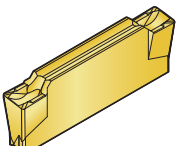
<p>WGE</p>  <p>F065 page</p>	<p>1st choice for external grooving and parting Excellent chip control for grooving CW = 0.079" - 0.197"</p>	<table border="1"> <caption>WGE Feed Performance</caption> <thead> <tr> <th>Groove width : CW (in)</th> <th>External (ipr)</th> <th>Internal (ipr)</th> <th>Face (ipr)</th> <th>Parting (ipr)</th> </tr> </thead> <tbody> <tr> <td>0.079</td> <td>0.008</td> <td>0.002</td> <td>0.009</td> <td>0.002</td> </tr> <tr> <td>0.118</td> <td>0.010</td> <td>0.002</td> <td>0.009</td> <td>0.002</td> </tr> <tr> <td>0.157</td> <td>0.011</td> <td>0.002</td> <td>0.009</td> <td>0.002</td> </tr> <tr> <td>0.197</td> <td>0.012</td> <td>0.002</td> <td>0.010</td> <td>0.002</td> </tr> </tbody> </table>	Groove width : CW (in)	External (ipr)	Internal (ipr)	Face (ipr)	Parting (ipr)	0.079	0.008	0.002	0.009	0.002	0.118	0.010	0.002	0.009	0.002	0.157	0.011	0.002	0.009	0.002	0.197	0.012	0.002	0.010	0.002
Groove width : CW (in)	External (ipr)	Internal (ipr)	Face (ipr)	Parting (ipr)																							
0.079	0.008	0.002	0.009	0.002																							
0.118	0.010	0.002	0.009	0.002																							
0.157	0.011	0.002	0.009	0.002																							
0.197	0.012	0.002	0.010	0.002																							
<p>WGE R/L</p>  <p>F065 page</p>	<p>Handed insert Minimize burr generation when workpiece is cut off CW = 0.079" - 0.197"</p>	<table border="1"> <caption>WGE R/L Feed Performance</caption> <thead> <tr> <th>Groove width : CW (in)</th> <th>External (ipr)</th> </tr> </thead> <tbody> <tr> <td>0.079</td> <td>0.0035</td> </tr> <tr> <td>0.118</td> <td>0.006</td> </tr> <tr> <td>0.157</td> <td>0.006</td> </tr> <tr> <td>0.197</td> <td>0.006</td> </tr> </tbody> </table>	Groove width : CW (in)	External (ipr)	0.079	0.0035	0.118	0.006	0.157	0.006	0.197	0.006															
Groove width : CW (in)	External (ipr)																										
0.079	0.0035																										
0.118	0.006																										
0.157	0.006																										
0.197	0.006																										

- External
- Internal
- Face
- Parting
- Others

External grooving and turning

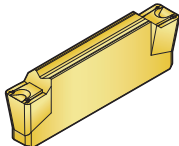
<p>WGT</p>  <p>F066 page</p>	<p>1st choice for turning Low cutting force and good chip control for traversing CW = 0.118" - 0.197"</p>	<table border="1"> <caption>WGT Surface Plot Data</caption> <thead> <tr> <th>Feed: f (ipr)</th> <th>WGT50 (ap in)</th> <th>WGT40 (ap in)</th> <th>WGT30 (ap in)</th> </tr> </thead> <tbody> <tr> <td>0.002</td> <td>0.079</td> <td>0.079</td> <td>0.039</td> </tr> <tr> <td>0.004</td> <td>0.079</td> <td>0.079</td> <td>0.039</td> </tr> <tr> <td>0.006</td> <td>0.079</td> <td>0.079</td> <td>0.039</td> </tr> <tr> <td>0.008</td> <td>0.079</td> <td>0.079</td> <td>0.039</td> </tr> <tr> <td>0.010</td> <td>0.079</td> <td>0.079</td> <td>0.039</td> </tr> <tr> <td>0.012</td> <td>0.079</td> <td>0.079</td> <td>0.039</td> </tr> </tbody> </table>	Feed: f (ipr)	WGT50 (ap in)	WGT40 (ap in)	WGT30 (ap in)	0.002	0.079	0.079	0.039	0.004	0.079	0.079	0.039	0.006	0.079	0.079	0.039	0.008	0.079	0.079	0.039	0.010	0.079	0.079	0.039	0.012	0.079	0.079	0.039
Feed: f (ipr)	WGT50 (ap in)	WGT40 (ap in)	WGT30 (ap in)																											
0.002	0.079	0.079	0.039																											
0.004	0.079	0.079	0.039																											
0.006	0.079	0.079	0.039																											
0.008	0.079	0.079	0.039																											
0.010	0.079	0.079	0.039																											
0.012	0.079	0.079	0.039																											

Profiling

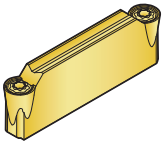
<p>WGR</p>  <p>F066 page</p>	<p>Low cutting force and good chip control for profiling CW = 0.118" - 0.197"</p>	<table border="1"> <caption>WGR Surface Plot Data</caption> <thead> <tr> <th>Feed: f (ipr)</th> <th>WGR50 (ap in)</th> <th>WGR40 (ap in)</th> <th>WGR30 (ap in)</th> </tr> </thead> <tbody> <tr> <td>0.002</td> <td>0.079</td> <td>0.079</td> <td>0.039</td> </tr> <tr> <td>0.004</td> <td>0.079</td> <td>0.079</td> <td>0.039</td> </tr> <tr> <td>0.006</td> <td>0.079</td> <td>0.079</td> <td>0.039</td> </tr> <tr> <td>0.008</td> <td>0.079</td> <td>0.079</td> <td>0.039</td> </tr> <tr> <td>0.010</td> <td>0.079</td> <td>0.079</td> <td>0.039</td> </tr> <tr> <td>0.012</td> <td>0.079</td> <td>0.079</td> <td>0.039</td> </tr> </tbody> </table>	Feed: f (ipr)	WGR50 (ap in)	WGR40 (ap in)	WGR30 (ap in)	0.002	0.079	0.079	0.039	0.004	0.079	0.079	0.039	0.006	0.079	0.079	0.039	0.008	0.079	0.079	0.039	0.010	0.079	0.079	0.039	0.012	0.079	0.079	0.039
Feed: f (ipr)	WGR50 (ap in)	WGR40 (ap in)	WGR30 (ap in)																											
0.002	0.079	0.079	0.039																											
0.004	0.079	0.079	0.039																											
0.006	0.079	0.079	0.039																											
0.008	0.079	0.079	0.039																											
0.010	0.079	0.079	0.039																											
0.012	0.079	0.079	0.039																											

INSERT

GE

For general grooving

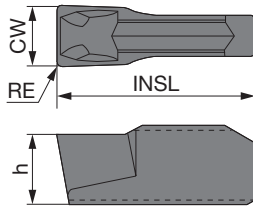

P	Steel	★	☆	★	★			★			
M	Stainless	★		★	★						
K	Cast iron	☆		★	☆			☆			
N	Non-ferrous										
S	Superalloys				☆						
H	Hard materials										

★ : First choice
☆ : Second choice

Designation	CW ₀ ^{+0.1} (mm)	CW ₀ ^{+0.004} (in)	RE (in)	Coated				Cermets			INSL (in)	h (in)		
				T9225	T9125	AH120	GH730	NS9530						
GE20	2	0.079	0.008			●	●			●			0.394	0.138
GE30	3	0.118	0.008	●	▲	●	●			●			0.394	0.138
GE40	4	0.157	0.008	●	▲	●	●			●			0.394	0.157
GE50	5	0.197	0.008	●	▲	●	●			●			0.472	0.177

● : Line up
▲ : To be discontinued

GT

For turning

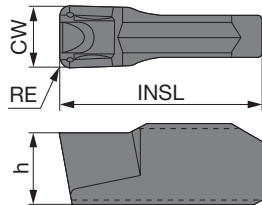

P	Steel	★	☆	★	★			★			
M	Stainless	★		★	★						
K	Cast iron	☆		★	☆			☆			
N	Non-ferrous										
S	Superalloys				☆						
H	Hard materials										

★ : First choice
☆ : Second choice

Designation	CW ₀ ^{+0.1} (mm)	CW ₀ ^{+0.004} (in)	RE (in)	Coated				Cermets			INSL (in)	h (in)		
				T9225	T9125	AH120	GH730	NS9530						
GT30	3	0.118	0.016			●	●			●			0.394	0.138
GT40	4	0.157	0.016			●	●			●			0.394	0.157
GT50	5	0.197	0.016	●	▲	●	●			●			0.472	0.177

● : Line up
▲ : To be discontinued

GR

For profiling (full radius)

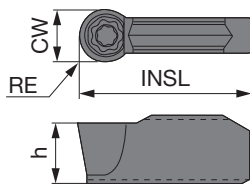

P	Steel	★	☆	★	★		★			
M	Stainless	★		★	★					
K	Cast iron	☆		★	☆		☆			
N	Non-ferrous									
S	Superalloys				☆					
H	Hard materials									

★ : First choice
☆ : Second choice

Designation	CW ^{+0.1} ₀ (mm)	CW ^{+0.004} ₀ (in)	RE (in)	Coated				Cermets				INSL (in)	h (in)		
				T9225	T9125	AH120	GH730	NS9530							
GR30	3	0.118	0.059			●	●			●				0.394	0.138
GR40	4	0.157	0.079	●	▲	●	●			●				0.394	0.157
GR50	5	0.197	0.098	●	▲	●	●			●				0.472	0.177

● : Line up
▲ : To be discontinued



Others

GF

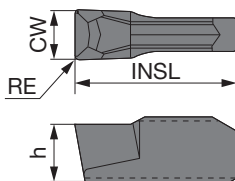

P	Steel	★			★					
M	Stainless	★								
K	Cast iron	☆			☆					
N	Non-ferrous									
S	Superalloys									
H	Hard materials									

★ : First choice
☆ : Second choice

Designation	CW ^{+0.1} ₀ (mm)	CW ^{+0.004} ₀ (in)	RE (in)	Coated	Cermets				INSL (in)	h (in)	
				GH730	NS9530						
GF30	3	0.118	0.008	●		●				0.394	0.138
GF40	4	0.157	0.008	●		●				0.394	0.157
GF50	5	0.197	0.008	●		●				0.472	0.177

● : Line up

Reference pages: Toolholders → **F060 - F063**, Standard cutting conditions → **F075**

GN

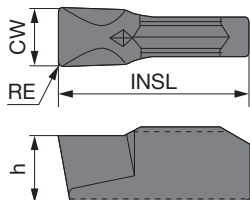

P	Steel	★					
M	Stainless	★					
K	Cast iron	☆					
N	Non-ferrous						
S	Superalloys						
H	Hard materials						

★ : First choice
☆ : Second choice

Designation	CW ^{+0.1} ₀ (mm)	CW ^{+0.004} ₀ (in)	RE (in)	Coated						INSL (in)	h (in)	
				AH120	GH730							
GN30	3	0.118	0.008	●							0.394	0.138
GN40	4	0.157	0.008	●							0.394	0.157
GN50	5	0.197	0.008	●							0.472	0.177

● : Line up

GE-R/L

For parting (with hand)

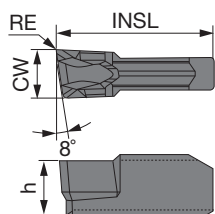

Right hand (R) shown.

P	Steel	★	★				
M	Stainless	★	★				
K	Cast iron	★	☆				
N	Non-ferrous						
S	Superalloys	☆					
H	Hard materials						

★ : First choice
☆ : Second choice

Designation	HAND	CW ^{+0.1} ₀ (mm)	CW ^{+0.004} ₀ (in)	RE (in)	Coated						INSL (in)	h (in)	
					AH120	GH730							
GE30R	R	3	0.118	0.008	●	●						0.394	0.138
GE30L	L	3	0.118	0.008		●						0.394	0.138
GE40R	R	4	0.157	0.008	●	●						0.394	0.157
GE40L	L	4	0.157	0.008		●						0.394	0.157
GE50R	R	5	0.197	0.008	●	●						0.472	0.177
GE50L	L	5	0.197	0.008		●						0.472	0.177

● : Line up



GE-AL

For aluminum and non-ferrous metal

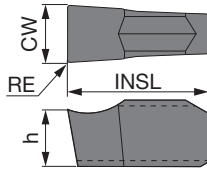

P	Steel							
M	Stainless							
K	Cast iron							
N	Non-ferrous	★						
S	Superalloys							
H	Hard materials							

★ : First choice
☆ : Second choice

Designation	CW ^{+0.1} ₀ (mm)	CW ^{+0.004} ₀ (in)	RE (in)	Uncoated						INSL (in)	h (in)
				KS05F							
GE20-AL	2	0.079	0.008	●						0.394	0.138
GE30-AL	3	0.118	0.008	●						0.394	0.138
GE40-AL	4	0.157	0.008	●						0.394	0.157

● : Line up



1 corner insert

External grooving and parting

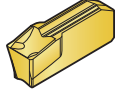
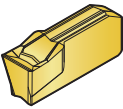
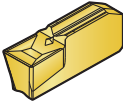
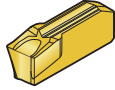
<p>GE</p>  <p>F069 page</p>	<p>1st choice for external grooving and parting Excellent chip control CW = 0.079" - 0.197"</p>	<table border="1"> <caption>Feed: f (ipr) vs Groove width : CW (in) for GE</caption> <thead> <tr> <th>Groove width : CW (in)</th> <th>External</th> <th>Internal</th> <th>Face</th> <th>Parting</th> </tr> </thead> <tbody> <tr> <td>0.079</td> <td>0.008</td> <td>0.006</td> <td>0.009</td> <td>0.005</td> </tr> <tr> <td>0.118</td> <td>0.010</td> <td>0.007</td> <td>0.011</td> <td>0.006</td> </tr> <tr> <td>0.157</td> <td>0.011</td> <td>0.008</td> <td>0.012</td> <td>0.007</td> </tr> <tr> <td>0.197</td> <td>0.012</td> <td>0.009</td> <td>0.013</td> <td>0.008</td> </tr> </tbody> </table>	Groove width : CW (in)	External	Internal	Face	Parting	0.079	0.008	0.006	0.009	0.005	0.118	0.010	0.007	0.011	0.006	0.157	0.011	0.008	0.012	0.007	0.197	0.012	0.009	0.013	0.008
Groove width : CW (in)	External	Internal	Face	Parting																							
0.079	0.008	0.006	0.009	0.005																							
0.118	0.010	0.007	0.011	0.006																							
0.157	0.011	0.008	0.012	0.007																							
0.197	0.012	0.009	0.013	0.008																							
<p>GF</p>  <p>F070 page</p>	<p>1st choice for face grooving Low cutting force and good chip control for face grooving CW = 0.118" - 0.197"</p>	<table border="1"> <caption>Feed: f (ipr) vs Groove width : CW (in) for GF</caption> <thead> <tr> <th>Groove width : CW (in)</th> <th>External</th> </tr> </thead> <tbody> <tr> <td>0.118</td> <td>0.009</td> </tr> <tr> <td>0.157</td> <td>0.011</td> </tr> <tr> <td>0.197</td> <td>0.012</td> </tr> </tbody> </table>	Groove width : CW (in)	External	0.118	0.009	0.157	0.011	0.197	0.012																	
Groove width : CW (in)	External																										
0.118	0.009																										
0.157	0.011																										
0.197	0.012																										
<p>GN</p>  <p>F071 page</p>	<p>1st choice for internal grooving Low cutting force and good chip control for internal grooving CW = 0.118" - 0.197"</p>	<table border="1"> <caption>Feed: f (ipr) vs Groove width : CW (in) for GN</caption> <thead> <tr> <th>Groove width : CW (in)</th> <th>External</th> </tr> </thead> <tbody> <tr> <td>0.118</td> <td>0.007</td> </tr> <tr> <td>0.157</td> <td>0.008</td> </tr> <tr> <td>0.197</td> <td>0.009</td> </tr> </tbody> </table>	Groove width : CW (in)	External	0.118	0.007	0.157	0.008	0.197	0.009																	
Groove width : CW (in)	External																										
0.118	0.007																										
0.157	0.008																										
0.197	0.009																										
<p>GE R/L</p>  <p>F071 page</p>	<p>Handed insert Minimize burr generation when workpiece is cut off CW = 0.118" - 0.197"</p>	<table border="1"> <caption>Feed: f (ipr) vs Groove width : CW (in) for GE R/L</caption> <thead> <tr> <th>Groove width : CW (in)</th> <th>External</th> </tr> </thead> <tbody> <tr> <td>0.079</td> <td>0.004</td> </tr> <tr> <td>0.118</td> <td>0.006</td> </tr> <tr> <td>0.157</td> <td>0.006</td> </tr> <tr> <td>0.197</td> <td>0.006</td> </tr> </tbody> </table>	Groove width : CW (in)	External	0.079	0.004	0.118	0.006	0.157	0.006	0.197	0.006															
Groove width : CW (in)	External																										
0.079	0.004																										
0.118	0.006																										
0.157	0.006																										
0.197	0.006																										

1 corner insert

External grooving and turning

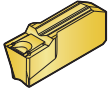
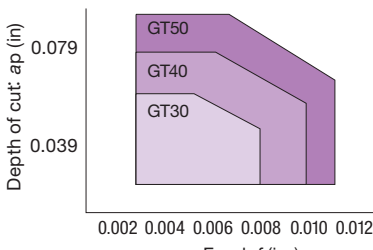
<p>GT</p>  <p>F069 page</p>	<p>1st choice for turning Low cutting force and good chip control for traversing CW = 0.118" - 0.197"</p>	 
---	---	--

Profiling

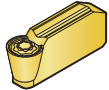
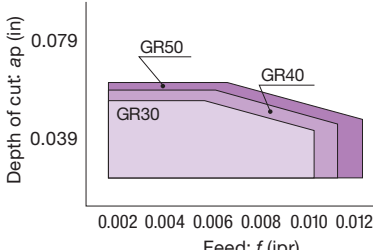
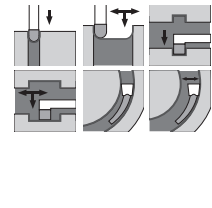
<p>GR</p>  <p>F070 page</p>	<p>Full radius type Low cutting force and good chip control for profiling CW = 0.118" - 0.197"</p>	 
---	--	---

For aluminum and non-ferrous metal

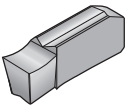
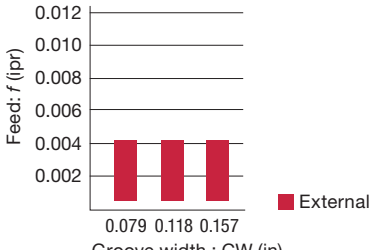
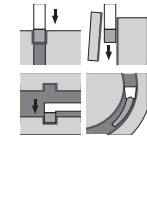
<p>GE-AL</p>  <p>F072 page</p>	<p>Reduce cutting force and welding due to sharp chipbreaker CW = 0.079" - 0.157"</p>	 
--	---	--

STANDARD CUTTING CONDITIONS

ISO	Workpiece material	Grade	Cutting speed Vc (sfm)
P	Low carbon steel, Alloy steel (- HB150)	T9225	262 - 984
		NS9530	328 - 656
		GH730	164 - 591
	Medium carbon steel, Alloy steel (HB150 - 250)	T9225	262 - 722
		NS9530	262 - 591
		GH730	164 - 492
High carbon steel, Alloy steel (HB250 -)	T9225	262 - 722	
	NS9530	262 - 492	
	GH730	164 - 394	
M	Stainless steel	T9225	262 - 591
GH730		164 - 394	
K	Gray iron, Ductile cast iron	T9225	262 - 820
		GH730	164 - 591
N	Aluminum alloys, Non-ferrous metal	KS05F	656 - 984

For External

Operation	Feed: <i>f</i> (ipr)			
	Groove width: CW (in)			
	2 mm (0.079")	3 mm (0.118")	4 mm (0.157")	5 mm (0.197")
Grooving (GE**)	0.0024 - 0.008	0.0024 - 0.010	0.0028 - 0.011	0.0028 - 0.012
Parting off (GE**R/L)	0.0016 - 0.004	0.0016 - 0.006	0.0016 - 0.006	0.0016 - 0.006
Traversing (GT**)	-	Depth of cut <i>ap</i> = 0.020 - 0.059 <i>f</i> = 0.0024 - 0.008	Depth of cut <i>ap</i> = 0.020 - 0.079 <i>f</i> = 0.0024 - 0.010	Depth of cut <i>ap</i> = 0.020 - 0.098 <i>f</i> = 0.0024 - 0.011
Profiling (GR**)	-	Depth of cut <i>ap</i> = 0.020 - 0.055 <i>f</i> = 0.002 - 0.010	Depth of cut <i>ap</i> = 0.020 - 0.059 <i>f</i> = 0.002 - 0.010	Depth of cut <i>ap</i> = 0.020 - 0.063 <i>f</i> = 0.002 - 0.012
Grooving for Aluminum alloys (GE**-AL)	0.0012 - 0.004	0.0012 - 0.004	0.0012 - 0.004	-

For diameter compensation values in traversing, see page **F111**.

Grade
Insert
Ext. Toolholder
Int. Toolholder
Threading
Grooving
Miniature Tool
Milling Cutter
Endmill
Drilling Tool
Tooling System
User's Guide
Index



TUNGT-CLAMP

FLASR/L

External grooving and threading toolholder, for Swiss lathes

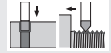
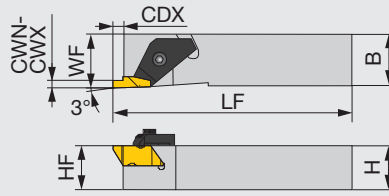

Right hand (R) shown.

Inch	CWN	CWX	CDX	HF	H	B	LF	WF	Insert	Torque
FLASR/L-082D	0.031	0.128	0.138	0.500	0.500	0.500	6.000	0.500	FL*-2**R/L...	2.21
FLASR-102B	0.031	0.128	0.138	0.625	0.625	0.625	4.500	0.625	FL*-2**R...	2.21
FLASR/L-103B	0.031	0.250	0.210	0.625	0.625	0.625	4.500	0.625	FL*-3**R/L...	2.21

Metric	CWN	CWX	CDX	HF	H	B	LF	WF	Insert	Torque*
FLASR/L-1616M3	1	3	5.31	16	16	16	125	16	FL*-3**R/L...	3

Use right-hand toolholders (R) with right-hand inserts (R); and left-hand toolholders (L) with left-hand inserts (L).
Torque: Recommended clamping torque: lbs-ft (*N-m)

Inch SPARE PARTS

Designation	Clamp	Clamping screw	Wrench
FLASR-082D	TF-182	S-310	7/64HEX
FLASL-082D	TF-183	S-310	7/64HEX
FLASR-102B, FLASR-103B	TF-184	S-412	5/32HEX
FLASL-103B	TF-185	S-412	5/32HEX

Metric SPARE PARTS

Designation	Clamp	Clamping screw	Wrench
FLASR-1616M3	TF-184	S-412	5/32HEX
FLASL-1616M3	TF-185	S-412	5/32HEX

TUNGT-CLAMP

FLSR/L

External grooving and threading toolholder, for Swiss lathes

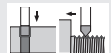
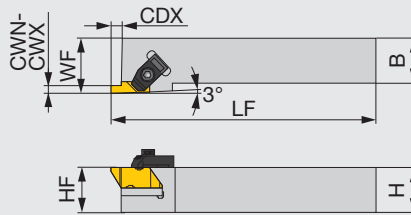

Right hand (R) shown.

Inch	CWN	CWX	CDX	HF	H	B	LF	WF	Insert	Torque
FLSR/L-122B	0.031	0.128	0.140	0.750	0.750	0.750	4.500	1.000	FL*-2**R/L...	2.21
FLSR/L-162C	0.031	0.128	0.140	1.000	1.000	1.000	5.000	1.250	FL*-2**R/L...	2.21
FLSR/L-123B	0.031	0.250	0.210	0.750	0.750	0.750	4.500	1.000	FL*-3**R/L...	2.21
FLSR/L-163C	0.031	0.250	0.210	1.000	1.000	1.000	5.000	1.250	FL*-3**R/L...	2.21

Metric	CWN	CWX	CDX	HF	H	B	LF	WF	Insert	Torque*
FLSR/L-2020M3	1	3	4.5	20	20	20	125	32	FL*-3**R/L...	3
FLSR/L-2525M3	1	3	4.5	25	25	25	150	32	FL*-3**R/L...	3

Use right-hand toolholders (R) with right-hand inserts (R); and left-hand toolholders (L) with left-hand inserts (L).
Torque: Recommended clamping torque: lbs-ft (*N-m)

Inch SPARE PARTS

Designation	Clamp	Clamping screw	Wrench
FLSR-122B, FLSR-162C	TF-74	S-310	7/64HEX
FLSL-122B, FLSL-162C	TF-75	S-310	7/64HEX
FLSR-123B, FLSR-163C	TF-72	S-412	5/32HEX
FLSL-123B, FLSL-163C	TF-73	S-412	5/32HEX

Metric SPARE PARTS

Designation	Clamp	Clamping screw	Wrench
FLSR-****M3	TF-72	S-412	5/32HEX
FLSL-****M3	TF-73	S-412	5/32HEX

Reference pages: Inserts → **F079 - F086**, Standard cutting conditions → **F078**

TUNGT-CLAMP

FLER/L

External toolholders for grooving & threading

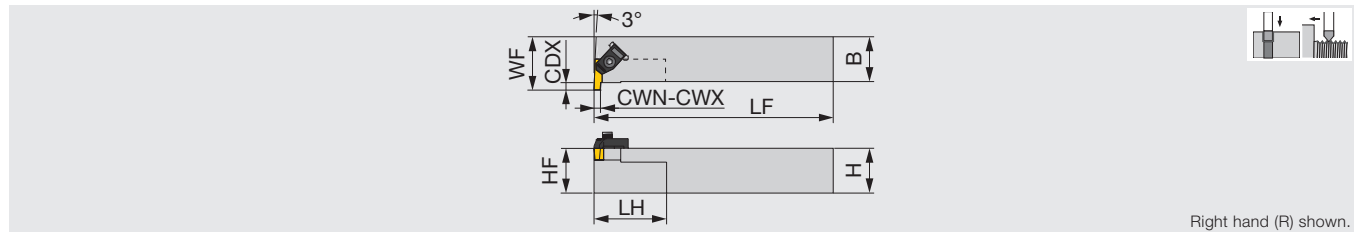

Inch	CWN	CWX	CDX	HF	H	B	LF	LH	WF	Insert	Torque
FLER/L-122B	0.031	0.128	0.140	0.750	0.750	0.750	4.500	1.000	1.000	FL*-2**/L/...	2.21
FLER/L-162C	0.031	0.128	0.140	1.000	1.000	1.000	5.000	1.000	1.250	FL*-2**/L/...	2.21
FLER/L-123B	0.031	0.250	0.210	0.750	0.750	0.750	4.500	2.000	1.125	FL*-3**/L/...	2.21
FLER/L-163D	0.031	0.250	0.210	1.000	1.000	1.000	6.000	2.000	1.250	FL*-3**/L/...	2.21

The right hand toolholders use right hand inserts, and the left hand toolholders use left hand inserts.
Torque: Recommended clamping torque: lbs·ft

SPARE PARTS

Designation	Clamp	Clamping screw	Wrench
FLER-122B, FLER-162C	TF-75	S-310	7/64HEX
FLEL-122B, FLEL-162C	TF-74	S-310	7/64HEX
FLER-123B, FLER-163D	TF-73	S-412	5/32HEX
FLEL-123B, FLEL-163D	TF-72	S-412	5/32HEX

TUNGT-CLAMP

FLSR/LT

External toolholders for grooving & threading

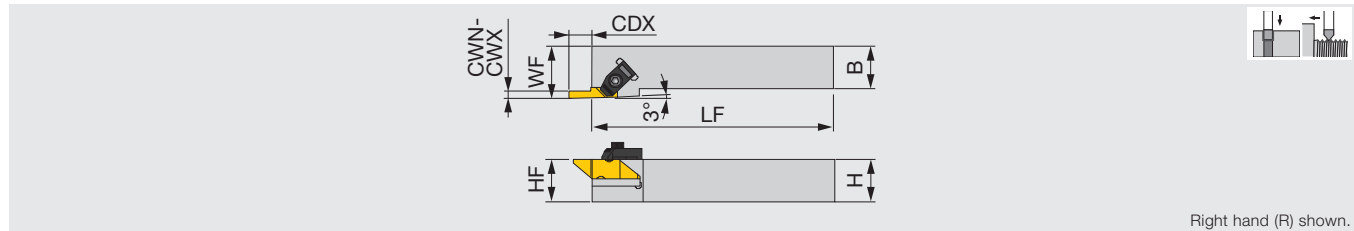

Inch	CWN	CWX	CDX	HF	H	B	LF	WF	Insert	Torque
FLSR/LT-163D	0.094	0.189	0.440	1.000	1.000	1.000	6.000	1.250	FLGT-3R/L/...	2.21
FLSR/LT-203D	0.094	0.189	0.440	1.250	1.250	1.250	6.000	1.500	FLGT-3R/L/...	2.21

The right hand toolholders use right hand inserts, and the left hand toolholders use left hand inserts.
Torque: Recommended clamping torque: lbs·ft

SPARE PARTS

Designation	Clamp	Clamping screw	Wrench
FLSRT-163D, FLSRT-203D	TF-72	S-412	5/32HEX
FLSLT-163D, FLSLT-203D	TF-73	S-412	5/32HEX

Reference pages: Inserts → **F079 - F086**, Standard cutting conditions → **F078**

Grade
Insert
Toolholder
Ext. Toolholder
Int. Toolholder
Threading
Grooving
Miniature Tool
Milling Cutter
Endmill
Drilling Tool
Tooling System
User's Guide
Index



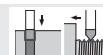
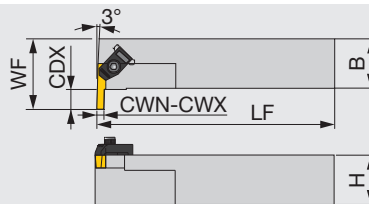

Right hand (R) shown.

Inch	CWN	CWX	CDX	HF	H	B	LF	WF	Insert	Torque
FLER/LT-163D	0.094	0.189	0.440	1.000	1.000	1.000	6.000	1.250	FLGT-3R/L...	2.21
FLER/LT-203D	0.094	0.189	0.440	1.250	1.250	1.250	6.000	1.500	FLGT-3R/L...	2.21

The right hand toolholders use right hand inserts, and the left hand toolholders use left hand inserts.
Torque: Recommended clamping torque: lbs-ft



SPARE PARTS



Designation	Clamp	Clamping screw	Wrench
FLERT-163D, FLERT-203D	TF-72	S-412	5/32HEX
FLELT-163D, FLELT-203D	TF-73	S-412	5/32HEX

STANDARD CUTTING CONDITIONS

ISO	Workpiece material	Grade	Application	Cutting speed Vc (sfm)	Feed f (ipr)
P	High carbon steel 1045, etc.	AH110	Grooving	328 - 656	0.005 - 0.014
		AH725	Threading	262 - 591	-
	Alloy steel 4137, etc.	AH110	Grooving	164 - 262	0.005 - 0.012
		AH725	Threading	197 - 525	-
M	Stainless steel S30400, etc.	AH110	Grooving	164 - 492	0.004 - 0.008
		AH725	Threading	164 - 427	-
K	Gray cast iron No.250B, etc.	AH110	Grooving	164 - 591	0.004 - 0.010
	Ductile cast iron 60-40-18, etc.	AH110	Grooving	164 - 394	0.004 - 0.010

INSERT

FLG-CB (With chipbreaker, metric width)

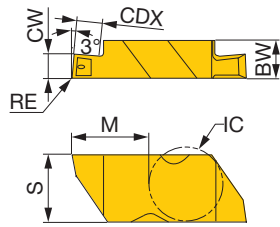

P	Steel	★						
M	Stainless	★						
K	Cast iron	★						
N	Non-ferrous							
S	Superalloys	★						
H	Hard materials							

★ : First choice
☆ : Second choice

Designation	HAND	CW±0.025 (mm)	CW±0.001 (in)	RE (in)	Coated					CDX (in)	IC (in)	BW (in)	S (in)	M (in)
					AH110									
FLG-3M100R-CB	R	1	0.039	0.005 - 0.010	●					0.055	0.3750	0.195	0.344	0.4050
FLG-3M100L-CB	L	1	0.039	0.005 - 0.010	●					0.055	0.3750	0.195	0.344	0.4050
FLG-3M150R-CB	R	1.5	0.059	0.005 - 0.010	●					0.100	0.3750	0.195	0.344	0.4050
FLG-3M150L-CB	L	1.5	0.059	0.005 - 0.010	●					0.100	0.3750	0.195	0.344	0.4050
FLG-3M200R-CB	R	2	0.079	0.005 - 0.010	●					0.100	0.3750	0.195	0.344	0.4050
FLG-3M200L-CB	L	2	0.079	0.005 - 0.010	●					0.100	0.3750	0.195	0.344	0.4050
FLG-3M250R-CB	R	2.5	0.098	0.005 - 0.010	●					0.160	0.3750	0.195	0.344	0.4050
FLG-3M250L-CB	L	2.5	0.098	0.005 - 0.010	●					0.160	0.3750	0.195	0.344	0.4050
FLG-3M300R-CB	R	3	0.118	0.005 - 0.010	●					0.160	0.3750	0.195	0.344	0.4050
FLG-3M300L-CB	L	3	0.118	0.005 - 0.010	●					0.160	0.3750	0.195	0.344	0.4050

● : Line up



FLG-CB (With chipbreaker)

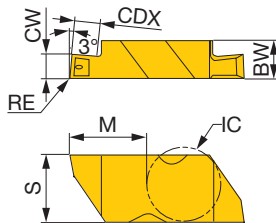

P	Steel	★					
M	Stainless	★					
K	Cast iron	★					
N	Non-ferrous						
S	Superalloys	★					
H	Hard materials						

★ : First choice
☆ : Second choice

Designation	HAND	CW±0.025 (mm)	CW±0.001 (in)	RE (in)	Coated					CDX (in)	IC (in)	BW (in)	S (in)	M (in)
					AH110									
FLG-2047R-CB	R	1.2	0.047	0.002 - 0.005	●					0.050	0.1875	0.150	0.219	0.2700
FLG-2047L-CB	L	1.2	0.047	0.002 - 0.005	●					0.050	0.1875	0.150	0.219	0.2700
FLG-2062R-CB	R	1.57	0.062	0.005 - 0.010	●					0.110	0.1875	0.150	0.219	0.2700
FLG-2062L-CB	L	1.57	0.062	0.005 - 0.010	●					0.110	0.1875	0.150	0.219	0.2700
FLG-2078R-CB	R	1.98	0.078	0.005 - 0.010	●					0.110	0.1875	0.150	0.219	0.2700
FLG-2078L-CB	L	1.98	0.078	0.005 - 0.010	●					0.110	0.1875	0.150	0.219	0.2700
FLG-2094R-CB	R	2.39	0.094	0.005 - 0.010	●					0.110	0.1875	0.150	0.219	0.2700
FLG-2094L-CB	L	2.39	0.094	0.005 - 0.010	●					0.110	0.1875	0.150	0.219	0.2700
FLG-2125R-CB	R	3.18	0.125	0.005 - 0.010	●					0.110	0.1875	0.150	0.219	0.2700
FLG-2125L-CB	L	3.18	0.125	0.005 - 0.010	●					0.110	0.1875	0.150	0.219	0.2700
FLG-3031R-CB	R	0.79	0.031	0.002 - 0.005	●					0.050	0.3750	0.195	0.344	0.4050
FLG-3031L-CB	L	0.79	0.031	0.002 - 0.005	●					0.050	0.3750	0.195	0.344	0.4050
FLG-3047R-CB	R	1.19	0.047	0.005 - 0.010	●					0.075	0.3750	0.195	0.344	0.4050
FLG-3047L-CB	L	1.19	0.047	0.005 - 0.010	●					0.075	0.3750	0.195	0.344	0.4050
FLG-3062R-CB	R	1.57	0.062	0.005 - 0.010	●					0.120	0.3750	0.195	0.344	0.4050
FLG-3062L-CB	L	1.57	0.062	0.005 - 0.010	●					0.120	0.3750	0.195	0.344	0.4050
FLG-3072R-CB	R	1.83	0.072	0.005 - 0.010	●					0.120	0.3750	0.195	0.344	0.4050
FLG-3072L-CB	L	1.83	0.072	0.005 - 0.010	●					0.120	0.3750	0.195	0.344	0.4050
FLG-3078R-CB	R	1.98	0.078	0.005 - 0.010	●					0.120	0.3750	0.195	0.344	0.4050
FLG-3078L-CB	L	1.98	0.078	0.005 - 0.010	●					0.120	0.3750	0.195	0.344	0.4050
FLG-3088R-CB	R	2.24	0.088	0.005 - 0.010	●					0.180	0.3750	0.195	0.344	0.4050
FLG-3088L-CB	L	2.24	0.088	0.005 - 0.010	●					0.180	0.3750	0.195	0.344	0.4050
FLG-3094R-CB	R	2.39	0.094	0.005 - 0.010	●					0.180	0.3750	0.195	0.344	0.4050
FLG-3094L-CB	L	2.39	0.094	0.005 - 0.010	●					0.180	0.3750	0.195	0.344	0.4050
FLG-3097R-CB	R	2.46	0.097	0.005 - 0.010	●					0.180	0.3750	0.195	0.344	0.4050
FLG-3097L-CB	L	2.46	0.097	0.005 - 0.010	●					0.180	0.3750	0.195	0.344	0.4050
FLG-3125R-CB	R	3.18	0.125	0.005 - 0.010	●					0.180	0.3750	0.195	0.344	0.4050
FLG-3125L-CB	L	3.18	0.125	0.005 - 0.010	●					0.180	0.3750	0.195	0.344	0.4050
FLG-3189R-CB	R	4.8	0.189	0.020 - 0.025	●					0.180	0.3750	0.195	0.344	0.4050
FLG-3189L-CB	L	4.8	0.189	0.020 - 0.025	●					0.180	0.3750	0.195	0.344	0.4050

● : Line up

Reference pages: Toolholders → **F076 - F078**

FLG

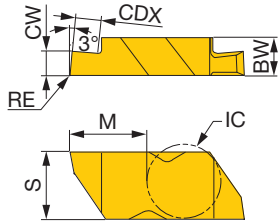

P	Steel	★					
M	Stainless	★					
K	Cast iron	★					
N	Non-ferrous						
S	Superalloys	★					
H	Hard materials						

★ : First choice
☆ : Second choice

Designation	HAND	CW±0.025 (mm)	CW±0.001 (in)	RE (in)	Coated				CDX (in)	IC (in)	BW (in)	S (in)	M (in)
					AH110								
FLG-2031R	R	0.79	0.031	0.002 - 0.005	●				0.050	0.1875	0.150	0.219	0.2700
FLG-2031L	L	0.79	0.031	0.002 - 0.005	●				0.050	0.1875	0.150	0.219	0.2700
FLG-2041R	R	1.04	0.041	0.002 - 0.005	●				0.050	0.1875	0.150	0.219	0.2700
FLG-2041L	L	1.04	0.041	0.002 - 0.005	●				0.050	0.1875	0.150	0.219	0.2700
FLG-2047R	R	1.19	0.047	0.002 - 0.005	●				0.050	0.1875	0.150	0.219	0.2700
FLG-2047L	L	1.19	0.047	0.002 - 0.005	●				0.050	0.1875	0.150	0.219	0.2700
FLG-2058R	R	1.47	0.058	0.005 - 0.010	●				0.050	0.1875	0.150	0.219	0.2700
FLG-2058L	L	1.47	0.058	0.005 - 0.010	●				0.050	0.1875	0.150	0.219	0.2700
FLG-2062R	R	1.57	0.062	0.005 - 0.010	●				0.110	0.1875	0.150	0.219	0.2700
FLG-2062L	L	1.57	0.062	0.005 - 0.010	●				0.110	0.1875	0.150	0.219	0.2700
FLG-2094R	R	2.39	0.094	0.005 - 0.010	●				0.110	0.1875	0.150	0.219	0.2700
FLG-2094L	L	2.39	0.094	0.005 - 0.010	●				0.110	0.1875	0.150	0.219	0.2700
FLG-2125R	R	3.18	0.125	0.005 - 0.010	●				0.110	0.1875	0.150	0.219	0.2700
FLG-2125L	L	3.18	0.125	0.005 - 0.010	●				0.110	0.1875	0.150	0.219	0.2700
FLG-3031R	R	0.79	0.031	0.002 - 0.005	●				0.050	0.3750	0.195	0.344	0.4050
FLG-3031L	L	0.79	0.031	0.002 - 0.005	●				0.050	0.3750	0.195	0.344	0.4050
FLG-3047R	R	1.19	0.047	0.005 - 0.010	●				0.075	0.3750	0.195	0.344	0.4050
FLG-3047L	L	1.19	0.047	0.005 - 0.010	●				0.075	0.3750	0.195	0.344	0.4050
FLG-3062R	R	1.57	0.062	0.005 - 0.010	●				0.120	0.3750	0.195	0.344	0.4050
FLG-3062L	L	1.57	0.062	0.005 - 0.010	●				0.120	0.3750	0.195	0.344	0.4050
FLG-3072R	R	1.83	0.072	0.005 - 0.010	●				0.120	0.3750	0.195	0.344	0.4050
FLG-3072L	L	1.83	0.072	0.005 - 0.010	●				0.120	0.3750	0.195	0.344	0.4050
FLG-3078R	R	1.98	0.078	0.005 - 0.010	●				0.120	0.3750	0.195	0.344	0.4050
FLG-3078L	L	1.98	0.078	0.005 - 0.010	●				0.120	0.3750	0.195	0.344	0.4050
FLG-3088R	R	2.24	0.088	0.005 - 0.010	●				0.180	0.3750	0.195	0.344	0.4050
FLG-3088L	L	2.24	0.088	0.005 - 0.010	●				0.180	0.3750	0.195	0.344	0.4050
FLG-3094R	R	2.39	0.094	0.005 - 0.010	●				0.180	0.3750	0.195	0.344	0.4050
FLG-3094L	L	2.39	0.094	0.005 - 0.010	●				0.180	0.3750	0.195	0.344	0.4050
FLG-3097R	R	2.46	0.097	0.010 - 0.015	●				0.180	0.3750	0.195	0.344	0.4050
FLG-3097L	L	2.46	0.097	0.010 - 0.015	●				0.180	0.3750	0.195	0.344	0.4050
FLG-3105R	R	2.67	0.105	0.005 - 0.010	●				0.180	0.3750	0.195	0.344	0.4050
FLG-3105L	L	2.67	0.105	0.005 - 0.010	●				0.180	0.3750	0.195	0.344	0.4050
FLG-3110R	R	2.79	0.110	0.005 - 0.010	●				0.180	0.3750	0.195	0.344	0.4050
FLG-3110L	L	2.79	0.110	0.005 - 0.010	●				0.180	0.3750	0.195	0.344	0.4050
FLG-3122R	R	3.1	0.122	0.005 - 0.010	●				0.180	0.3750	0.195	0.344	0.4050
FLG-3122L	L	3.1	0.122	0.005 - 0.010	●				0.180	0.3750	0.195	0.344	0.4050
FLG-3125R	R	3.18	0.125	0.005 - 0.010	●				0.180	0.3750	0.195	0.344	0.4050
FLG-3125L	L	3.18	0.125	0.005 - 0.010	●				0.180	0.3750	0.195	0.344	0.4050
FLG-3142R	R	3.61	0.142	0.005 - 0.010	●				0.180	0.3750	0.195	0.344	0.4050
FLG-3142L	L	3.61	0.142	0.005 - 0.010	●				0.180	0.3750	0.195	0.344	0.4050
FLG-3156R	R	3.96	0.156	0.005 - 0.010	●				0.180	0.3750	0.195	0.344	0.4050
FLG-3156L	L	3.96	0.156	0.005 - 0.010	●				0.180	0.3750	0.195	0.344	0.4050
FLG-3178R	R	4.52	0.178	0.005 - 0.010	●				0.180	0.3750	0.195	0.344	0.4050
FLG-3178L	L	4.52	0.178	0.005 - 0.010	●				0.180	0.3750	0.195	0.344	0.4050
FLG-3185R	R	4.7	0.185	0.020 - 0.025	●				0.180	0.3750	0.195	0.344	0.4050
FLG-3185L	L	4.7	0.185	0.020 - 0.025	●				0.180	0.3750	0.195	0.344	0.4050
FLG-3189R	R	4.8	0.189	0.020 - 0.025	●				0.180	0.3750	0.195	0.344	0.4050
FLG-3189L	L	4.8	0.189	0.020 - 0.025	●				0.180	0.3750	0.195	0.344	0.4050
FLG-3250R	R	6.35	0.250	0.020 - 0.025	●				0.180	0.3750	0.250	0.344	0.4050
FLG-3250L	L	6.35	0.250	0.020 - 0.025	●				0.180	0.3750	0.250	0.344	0.4050

● : Line up

Reference pages: Toolholders → F076 - F078

FLGP (Positive rake)

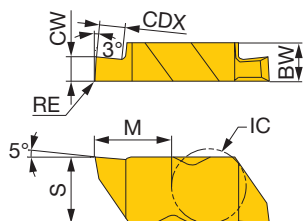

P	Steel	★				
M	Stainless	★				
K	Cast iron	★				
N	Non-ferrous					
S	Superalloys	★				
H	Hard materials					

★ : First choice
☆ : Second choice

Designation	HAND	CW±0.025 (mm)	CW±0.001 (in)	RE (in)	Coated				CDX (in)	IC (in)	BW (in)	S (in)	M (in)
					AH110								
FLGP-2031R	R	0.79	0.031	0.002 - 0.005	●				0.050	0.1875	0.150	0.219	0.2700
FLGP-2031L	L	0.79	0.031	0.002 - 0.005	●				0.050	0.1875	0.150	0.219	0.2700
FLGP-2062R	R	1.57	0.062	0.005 - 0.010	●				0.110	0.1875	0.150	0.219	0.2700
FLGP-2062L	L	1.57	0.062	0.005 - 0.010	●				0.110	0.1875	0.150	0.219	0.2700
FLGP-2125R	R	3.18	0.125	0.005 - 0.010	●				0.110	0.1875	0.150	0.219	0.2700
FLGP-2125L	L	3.18	0.125	0.005 - 0.010	●				0.110	0.1875	0.150	0.219	0.2700
FLGP-3047R	R	1.19	0.047	0.005 - 0.010	●				0.075	0.3750	0.195	0.344	0.4050
FLGP-3047L	L	1.19	0.047	0.005 - 0.010	●				0.075	0.3750	0.195	0.344	0.4050
FLGP-3062R	R	1.57	0.062	0.005 - 0.010	●				0.120	0.3750	0.195	0.344	0.4050
FLGP-3062L	L	1.57	0.062	0.005 - 0.010	●				0.120	0.3750	0.195	0.344	0.4050
FLGP-3088R	R	2.24	0.088	0.005 - 0.010	●				0.180	0.3750	0.195	0.344	0.4050
FLGP-3088L	L	2.24	0.088	0.005 - 0.010	●				0.180	0.3750	0.195	0.344	0.4050
FLGP-3094R	R	2.39	0.094	0.005 - 0.010	●				0.180	0.3750	0.195	0.344	0.4050
FLGP-3094L	L	2.39	0.094	0.005 - 0.010	●				0.180	0.3750	0.195	0.344	0.4050
FLGP-3125R	R	3.18	0.125	0.005 - 0.010	●				0.180	0.3750	0.195	0.344	0.4050
FLGP-3125L	L	3.18	0.125	0.005 - 0.010	●				0.180	0.3750	0.195	0.344	0.4050
FLGP-3156R	R	3.96	0.156	0.005 - 0.010	●				0.180	0.3750	0.195	0.344	0.4050
FLGP-3156L	L	3.96	0.156	0.005 - 0.010	●				0.180	0.3750	0.195	0.344	0.4050
FLGP-3189R	R	4.8	0.189	0.020 - 0.025	●				0.180	0.3750	0.195	0.344	0.4050
FLGP-3189L	L	4.8	0.189	0.020 - 0.025	●				0.180	0.3750	0.195	0.344	0.4050

● : Line up

FLR-CB (Full nose radius, with chipbreaker)

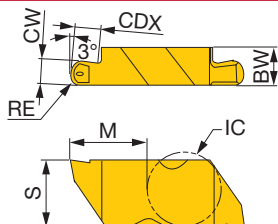

P	Steel	★				
M	Stainless	★				
K	Cast iron	★				
N	Non-ferrous					
S	Superalloys	★				
H	Hard materials					

★ : First choice
☆ : Second choice

Designation	HAND	CW±0.025 (mm)	CW±0.001 (in)	RE (in)	Coated				CDX (in)	IC (in)	BW (in)	S (in)	M (in)
					AH110								
FLR-3031R-CB	R	1.57	0.062	0.031	●				0.125	0.3750	0.195	0.344	0.4033
FLR-3031L-CB	L	1.57	0.062	0.031	●				0.125	0.3750	0.195	0.344	0.4033
FLR-3047R-CB	R	2.39	0.094	0.047	●				0.180	0.3750	0.195	0.344	0.4025
FLR-3047L-CB	L	2.39	0.094	0.047	●				0.180	0.3750	0.195	0.344	0.4025
FLR-3062R-CB	R	3.18	0.125	0.062	●				0.180	0.3750	0.195	0.344	0.4017
FLR-3062L-CB	L	3.18	0.125	0.062	●				0.180	0.3750	0.195	0.344	0.4017

● : Line up

Reference pages: Toolholders → **F076 - F078**

FLR (Full nose radius)

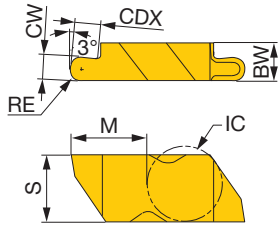

P	Steel	★				
M	Stainless	★				
K	Cast iron	★				
N	Non-ferrous					
S	Superalloys	★				
H	Hard materials					

★ : First choice
☆ : Second choice

Designation	HAND	CW±0.025 (mm)	CW±0.001 (in)	RE (in)	Coated				CDX (in)	IC (in)	BW (in)	S (in)	M (in)
					AH110								
FLR-2031R	R	1.57	0.062	0.031	●				0.110	0.1875	0.150	0.219	0.2683
FLR-2031L	L	1.57	0.062	0.031	●				0.110	0.1875	0.150	0.219	0.2683
FLR-2047R	R	2.39	0.094	0.047	●				0.110	0.1875	0.150	0.219	0.2675
FLR-2047L	L	2.39	0.094	0.047	●				0.110	0.1875	0.150	0.219	0.2675
FLR-2062R	R	3.18	0.125	0.062	●				0.110	0.1875	0.150	0.219	0.2667
FLR-2062L	L	3.18	0.125	0.062	●				0.110	0.1875	0.150	0.219	0.2667
FLR-3031R	R	1.57	0.062	0.031	●				0.125	0.3750	0.195	0.344	0.4033
FLR-3031L	L	1.57	0.062	0.031	●				0.125	0.3750	0.195	0.344	0.4033
FLR-3047R	R	2.39	0.094	0.047	●				0.180	0.3750	0.195	0.344	0.4025
FLR-3047L	L	2.39	0.094	0.047	●				0.180	0.3750	0.195	0.344	0.4025
FLR-3062R	R	3.18	0.125	0.062	●				0.180	0.3750	0.195	0.344	0.4017
FLR-3062L	L	3.18	0.125	0.062	●				0.180	0.3750	0.195	0.344	0.4017
FLR-3078R	R	3.96	0.156	0.078	●				0.180	0.3750	0.195	0.344	0.4008
FLR-3078L	L	3.96	0.156	0.078	●				0.180	0.3750	0.195	0.344	0.4008
FLR-3094R	R	4.8	0.189	0.094	●				0.180	0.3750	0.195	0.344	0.4000
FLR-3094L	L	4.8	0.189	0.094	●				0.180	0.3750	0.195	0.344	0.4000

● : Line up

FLRP (Full nose radius and positive rake)

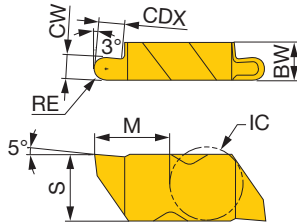

P	Steel	★				
M	Stainless	★				
K	Cast iron	★				
N	Non-ferrous					
S	Superalloys	★				
H	Hard materials					

★ : First choice
☆ : Second choice

Designation	HAND	CW±0.025 (mm)	CW±0.001 (in)	RE (in)	Coated				CDX (in)	IC (in)	BW (in)	S (in)	M (in)
					AH110								
FLRP-3031R	R	1.57	0.062	0.031	●				0.125	0.3750	0.195	0.344	0.4033
FLRP-3031L	L	1.57	0.062	0.031	●				0.125	0.3750	0.195	0.344	0.4033
FLRP-3047R	R	2.39	0.094	0.047	●				0.180	0.3750	0.195	0.344	0.4025
FLRP-3047L	L	2.39	0.094	0.047	●				0.180	0.3750	0.195	0.344	0.4025
FLRP-3062R	R	3.18	0.125	0.062	●				0.180	0.3750	0.195	0.344	0.4017
FLRP-3062L	L	3.18	0.125	0.062	●				0.180	0.3750	0.195	0.344	0.4017
FLRP-3078R	R	3.96	0.156	0.078	●				0.180	0.3750	0.195	0.344	0.4008
FLRP-3078L	L	3.96	0.156	0.078	●				0.180	0.3750	0.195	0.344	0.4008
FLRP-3094R	R	4.8	0.189	0.094	●				0.180	0.3750	0.195	0.344	0.4000
FLRP-3094L	L	4.8	0.189	0.094	●				0.180	0.3750	0.195	0.344	0.4000

● : Line up

Reference pages: Toolholders → **F076 - F078**



FLGD-CB (Single edge deep, with chipbreaker)

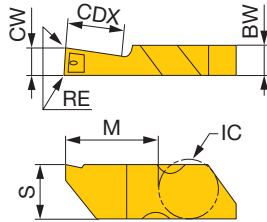

P	Steel	★					
M	Stainless	★					
K	Cast iron	★					
N	Non-ferrous						
S	Superalloys	★					
H	Hard materials						

★ : First choice
☆ : Second choice

Designation	HAND	CW±0.025 (mm)	CW±0.001 (in)	RE (in)	Coated					CDX (in)	IC (in)	BW (in)	S (in)	M (in)
					AH110									
FLGD-3094R-CB	R	2.39	0.094	0.005 - 0.010	●					0.250	0.3750	0.195	0.344	0.5050
FLGD-3094L-CB	L	2.39	0.094	0.005 - 0.010	●					0.250	0.3750	0.195	0.344	0.5050
FLGD-3125R-CB	R	3.18	0.125	0.005 - 0.010	●					0.250	0.3750	0.195	0.344	0.5050
FLGD-3125L-CB	L	3.18	0.125	0.005 - 0.010	●					0.250	0.3750	0.195	0.344	0.5050
FLGD-3189R-CB	R	4.8	0.189	0.020 - 0.025	●					0.250	0.3750	0.195	0.344	0.5050
FLGD-3189L-CB	L	4.8	0.189	0.020 - 0.025	●					0.250	0.3750	0.195	0.344	0.5050

● : Line up

FLGD (Single edge deep)

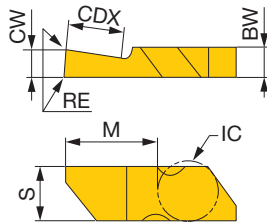

P	Steel	★					
M	Stainless	★					
K	Cast iron	★					
N	Non-ferrous						
S	Superalloys	★					
H	Hard materials						

★ : First choice
☆ : Second choice

Designation	HAND	CW±0.025 (mm)	CW±0.001 (in)	RE (in)	Coated					CDX (in)	IC (in)	BW (in)	S (in)	M (in)
					AH110									
FLGD-3062R	R	1.57	0.062	0.005 - 0.010	●					0.120	0.3750	0.195	0.344	0.5050
FLGD-3062L	L	1.57	0.062	0.005 - 0.010	●					0.120	0.3750	0.195	0.344	0.5050
FLGD-3094R	R	2.39	0.094	0.005 - 0.010	●					0.250	0.3750	0.195	0.344	0.5050
FLGD-3094L	L	2.39	0.094	0.005 - 0.010	●					0.250	0.3750	0.195	0.344	0.5050
FLGD-3125R	R	3.18	0.125	0.005 - 0.010	●					0.250	0.3750	0.195	0.344	0.5050
FLGD-3125L	L	3.18	0.125	0.005 - 0.010	●					0.250	0.3750	0.195	0.344	0.5050
FLGD-3189R	R	4.8	0.189	0.020 - 0.025	●					0.250	0.3750	0.195	0.344	0.5050
FLGD-3189L	L	4.8	0.189	0.020 - 0.025	●					0.250	0.3750	0.195	0.344	0.5050

● : Line up

Reference pages: Toolholders → **F076 - F078**

FLRD (Full nose radius, single edge deep)

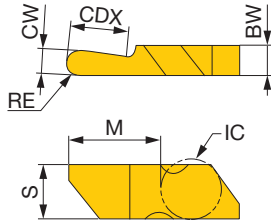

P	Steel	★							
M	Stainless	★							
K	Cast iron	★							
N	Non-ferrous								
S	Superalloys	★							
H	Hard materials								

★ : First choice
☆ : Second choice

Designation	HAND	CW±0.025 (mm)	CW±0.001 (in)	RE (in)	Coated					CDX (in)	IC (in)	BW (in)	S (in)	M (in)
					AH110									
FLRD-3062R	R	3.19	0.125	0.062	●					0.250	0.3750	0.195	0.344	0.5016
FLRD-3062L	L	3.19	0.125	0.062	●					0.250	0.3750	0.195	0.344	0.5016
FLRD-3094R	R	4.8	0.189	0.094	●					0.250	0.3750	0.195	0.344	0.5016
FLRD-3094L	L	4.8	0.189	0.094	●					0.250	0.3750	0.195	0.344	0.5016

● : Line up

FLGT (Double end deep)

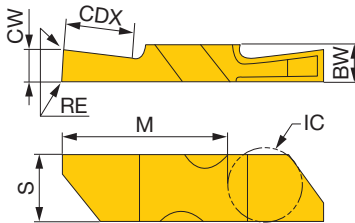

P	Steel	★							
M	Stainless	★							
K	Cast iron	★							
N	Non-ferrous								
S	Superalloys	★							
H	Hard materials								

★ : First choice
☆ : Second choice

Designation	HAND	CW±0.025 (mm)	CW±0.001 (in)	RE (in)	Coated					CDX (in)	IC (in)	BW (in)	S (in)	M (in)
					AH110									
FLGT-3094R	R	2.39	0.094	0.005 - 0.010	●					0.275	0.3750	0.195	0.344	0.8550
FLGT-3094L	L	2.39	0.094	0.005 - 0.010	●					0.275	0.3750	0.195	0.344	0.8550
FLGT-3125R	R	3.18	0.125	0.005 - 0.010	●					0.437	0.3750	0.195	0.344	0.8550
FLGT-3125L	L	3.18	0.125	0.005 - 0.010	●					0.437	0.3750	0.195	0.344	0.8550
FLGT-3189R	R	4.8	0.189	0.020 - 0.025	●					0.437	0.3750	0.195	0.344	0.8550
FLGT-3189L	L	4.8	0.189	0.020 - 0.025	●					0.437	0.3750	0.195	0.344	0.8550

*Fits FLSLT/RT toolholders

● : Line up



FLRT (Double end deep FNR)

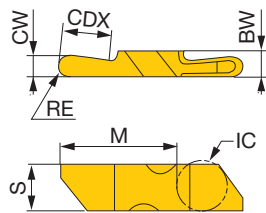

P	Steel	★				
M	Stainless	★				
K	Cast iron	★				
N	Non-ferrous					
S	Superalloys	★				
H	Hard materials					

★ : First choice
☆ : Second choice

Designation	HAND	CW±0.025 (mm)	CW±0.001 (in)	RE (in)	Coated					CDX (in)	IC (in)	BW (in)	S (in)	M (in)
					AH110									
FLRT-3062R	R	3.18	0.125	0.062	●					0.437	0.3750	0.195	0.344	0.8550
FLRT-3062L	L	3.18	0.125	0.062	●					0.437	0.3750	0.195	0.344	0.8550
FLRT-3094R	R	4.8	0.189	0.094	●					0.437	0.3750	0.195	0.344	0.8550
FLRT-3094L	L	4.8	0.189	0.094	●					0.437	0.3750	0.195	0.344	0.8550

*Fits FLSLT/RT toolholders

● : Line up

FLT-CB (For threading)

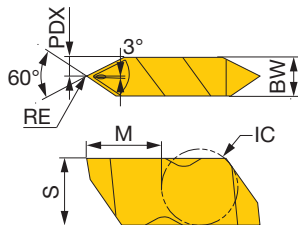

P	Steel	★			
M	Stainless	★			
K	Cast iron	★			
N	Non-ferrous				
S	Superalloys	★			
H	Hard materials				

★ : First choice
☆ : Second choice

Designation	HAND	RE (in)	Coated		TPI		IC (in)	PDX (in)	BW (in)	S (in)	M (in)
			AH110		Internal	External					
FLT-3R-HCB	R	0.005 - 0.008	●		5-12	6-20	0.3750	0.098	0.195	0.344	0.3999
FLT-3L-HCB	L	0.005 - 0.008	●		5-12	6-20	0.3750	0.098	0.195	0.344	0.3999
FLT-3RC-HCB	R	0.012 - 0.015	●		5-6	6-11	0.3750	0.098	0.195	0.344	0.3999
FLT-3LC-HCB	L	0.012 - 0.015	●		5-6	6-11	0.3750	0.098	0.195	0.344	0.3999
FLT-3R-CB	R	0.005 - 0.008	●		8-12	8-20	0.3750	0.098	0.195	0.344	0.3999
FLT-3L-CB	L	0.005 - 0.008	●		8-12	8-20	0.3750	0.098	0.195	0.344	0.3999

● : Line up

Reference pages: Toolholders → **F076 - F078**

CER/L

Clamp-on external grooving and threading toolholder (alternative clamping of screw-on or clamp-on only for DT type)

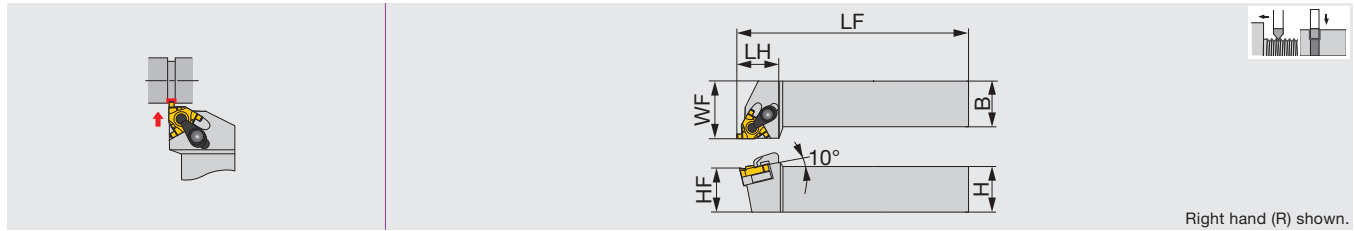

Right hand (R) shown.

Inch	CWN	CWX	H	B	LF	LH	HF	WF	Insert	Torque
CER/L123DT	0.039	0.089	0.750	0.750	5.000	0.870	0.750	1.000	GTGN16...	2.58
CER/L163DT	0.039	0.089	1.000	1.000	6.000	1.000	1.000	1.250	GTGN16...	2.58
CER203DT	0.039	0.089	1.250	1.250	6.000	1.250	1.250	1.500	GTGN16...	2.58

Metric	CWN	CWX	H	B	LF	LH	HF	WF	Insert	Torque*
CER/L1212H16DT	1	2.25	12	12	100	24	12	16	GTGN16...	3.5
CER/L1616H16DT	1	2.25	16	16	100	24	16	20	GTGN16...	3.5
CER/L2020K16DT	1	2.25	20	20	125	24	20	25	GTGN16...	3.5
CER/L2525M16DT	1	2.25	25	25	150	28	25	32	GTGN16...	3.5
CER3232P16T	1	2.25	32	32	170	32	32	40	GTGN16...	3.5

A clamp set consists of a clamp and a clamping screw. A shim set consists of a shim and a shim screw to secure the shim to the shank. Standard shims can be used on both right- and left-hand toolholders. Please use either of the sides depending on the tool hand. When using grooving inserts, please use shims for grooving. Shims for grooving inserts are sold separately. Use right-hand toolholders (R) with right-hand inserts (R); and left-hand toolholders (L) with left-hand inserts (L). Torque: Recommended clamping torque: lbs-ft (*N·m)

SPARE PARTS						
Designation	Clamp set	Clamp screw	Shim screw	*Optional: Shim for grooving	Wrench 1	Wrench 2
CER/L123DT, CER/L163DT, CER203DT	CSP16	CSTB-3.5ST	DTS5-3.5	G16ER/IL-DT	P-3.5	T-15F
CER****16DT	CSP16	CSTB-3.5ST	DTS5-3.5	G16ER/IL-DT	P-3.5	T-15F
CEL****16DT	CSP16	CSTB-3.5ST	DTS5-3.5	G16EL/IR-DT	P-3.5	T-15F
CER3232P16T	CSP16	-	-	G16ER/IR-S	-	T-15F

B-CER/L

External threading toolholder, for Swiss lathes

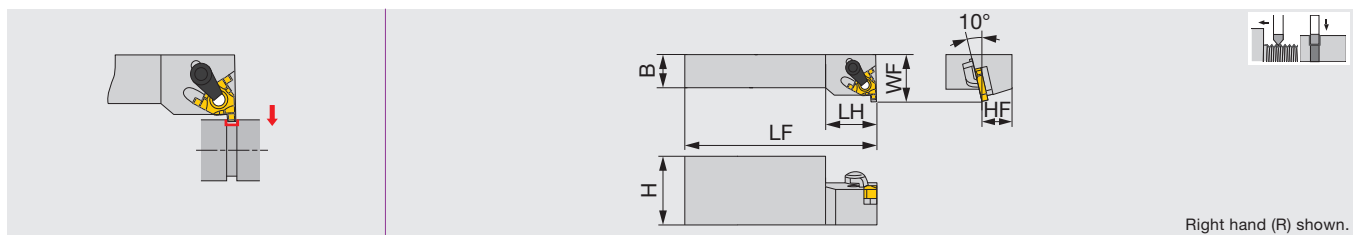

Right hand (R) shown.

Metric	CWN	CWX	H	B	LF	LH	HF	WF	Insert	Torque
B-CER/L16M16	1	2.25	32	16	150	24	16	22	GTGN16...	3.5

When using grooving inserts, please use shims for grooving. Shims for grooving inserts are sold separately. Use right-hand toolholders (R) with right-hand inserts (R); and left-hand toolholders (L) with left-hand inserts (L). Torque: Recommended clamping torque: N·m

SPARE PARTS				
Designation	Clamp set	Clamp screw	Wrench	*Optional: Shim for grooving
B-CER16M16	CSP16	-	T-15F	G16ER/IL-S
B-CEL16M16	CSP16	-	T-15F	G16EL/IR-S

Reference pages: Inserts, Standard cutting conditions → **F088**

Grade
Insert
Toolholder
Ext. Toolholder
Int. Toolholder
Threading
Grooving
Miniature Tool
Milling Cutter
Endmill
Drilling Tool
System
User's Guide
Index



INSERT

GTGN16

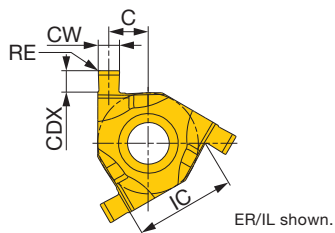

P	Steel	★
M	Stainless	★
K	Cast iron	
N	Non-ferrous	
S	Superalloys	★
H	Hard materials	

★ : First choice
☆ : Second choice

Designation	HAND (External)	CW±0.03 (mm)	CW±0.001 (in)	RE (in)	Coated		Insert size	CDX (in)	IC (in)	C (in)	Shim	
					SH730						Dual-clamp toolholder: screw-on and clamp-on	Clamp-on toolholder
GTGN-16ER/IL100	R	1	0.039	0.004	●		16	0.049	0.375	0.166	G16ER/IL-DT	G16ER/IL-S
GTGN-16EL/IR100	L	1	0.039	0.004	●		16	0.049	0.375	0.166	G16ER/IL-DT	G16ER/IL-S
GTGN-16ER/IL120	R	1.2	0.047	0.004	●		16	0.051	0.375	0.162	G16ER/IL-DT	G16ER/IL-S
GTGN-16EL/IR120	L	1.2	0.047	0.004	●		16	0.051	0.375	0.162	G16ER/IL-DT	G16ER/IL-S
GTGN-16ER/IL140	R	1.4	0.055	0.004	●		16	0.059	0.375	0.158	G16ER/IL-DT	G16ER/IL-S
GTGN-16EL/IR140	L	1.4	0.055	0.004	●		16	0.059	0.375	0.158	G16ER/IL-DT	G16ER/IL-S
GTGN-16ER/IL170	R	1.7	0.067	0.004	●		16	0.067	0.375	0.144	G16EL/IR-DT	G16EL/IR-S
GTGN-16EL/IR170	L	1.7	0.067	0.004	●		16	0.067	0.375	0.144	G16EL/IR-DT	G16EL/IR-S
GTGN-16ER/IL195	R	1.95	0.077	0.004	●		16	0.067	0.375	0.148	G16EL/IR-DT	G16EL/IR-S
GTGN-16EL/IR195	L	1.95	0.077	0.004	●		16	0.067	0.375	0.148	G16EL/IR-DT	G16EL/IR-S
GTGN-16ER/IL225	R	2.25	0.089	0.004	●		16	0.071	0.375	0.142	G16EL/IR-DT	G16EL/IR-S
GTGN-16EL/IR225	L	2.25	0.089	0.004	●		16	0.071	0.375	0.142	G16EL/IR-DT	G16EL/IR-S

GTGN insert can be used for both external and internal machining, but the tool hand is reversed.
Shim for GTGN depends on the toolholder type.

● : Line up

STANDARD CUTTING CONDITIONS

ISO	Workpiece material	Grade	Cutting speed Vc (sfm)	Feed f (ipr)
P	Steel 1045, 4140, etc.	SH730	160 - 490	0.002 - 0.004
M	Stainless steel 304, 316, etc.	SH730	100 - 490	0.002 - 0.004
S	Heat-resistant alloys, Titanium alloys, etc. Ti-6Al-4V, etc.	SH730	100 - 330	0.002 - 0.004

Reference pages: Toolholders → **F087**

Lever-lock external wide grooving toolholder

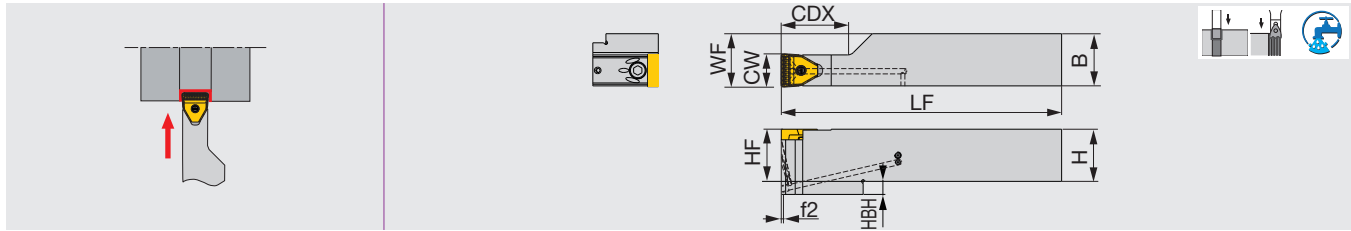

Inch	CW	CDX	H	B	LF	HF	WF	HBH	f2	Insert ⁽¹⁾	Torque
FPGR16-10T20	0.394	0.787	1.000	1.000	7.000	1.000	1.020	-	0.019	PSG*10...	1.62
FPGR20-10T36	0.394	1.417	1.250	1.250	8.000	1.250	1.270	-	0.019	PSG*10...	1.62
FPGR16-15T20	0.590	0.787	1.000	1.000	7.000	1.000	1.020	-	0.019	PSG*15...	1.62
FPGR20-15T40	0.590	1.574	1.250	1.250	8.000	1.250	1.270	-	0.015	PSG*15...	1.62
FPGR20-20T40	0.787	1.574	1.250	1.250	8.000	1.250	1.270	0.314	0.015	PSG*20...	6.27
FPGR24-20T50	0.787	1.968	1.500	1.500	10.000	1.500	1.520	0.314	0.015	PSG*20...	6.27
FPGR20-25T40	0.984	1.574	1.250	1.250	8.000	1.250	1.270	0.314	0.015	PSG*25...	6.27
FPGR24-25T50	0.984	1.968	1.500	1.500	10.000	1.500	1.520	0.314	0.015	PSG*25...	6.27

(1) Can be used for both wide grooving and wide profile grooving

Torque: Recommended clamping torque: lbs-ft

CDX, LF, f2 are dimensions when PSGM insert is attached. When mounting PSGB insert, the dimensions will be 0.197" (5 mm) longer.

SPARE PARTS

Designation	Lever	Clamping screw	Spring	Wrench
FPGR**-10T..., 15T...	FCL4	FCS3	BP-5	P-2.5
FPGR**-20T..., 25T...	FCL8	FCS6	BP-9	P-5

Lever-lock external wide profile grooving toolholder

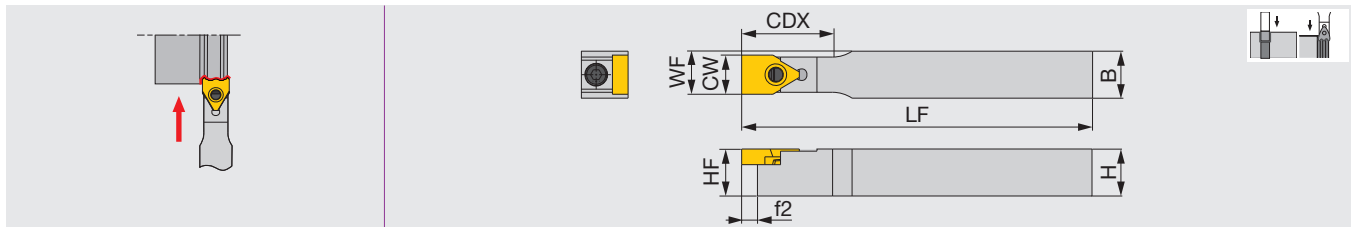

Inch	CW	CDX	H	B	LF	HF	WF	f2	Insert ⁽¹⁾	Torque
FPGN08-10T20	0.394	0.984	0.500	0.500	4.946	0.500	0.450	0.216	PSG*10...	1.62
FPGN10-10T20	0.394	0.984	0.625	0.625	4.946	0.625	0.510	0.216	PSG*10...	1.62
FPGN12-10T20	0.394	0.984	0.750	0.750	5.196	0.750	0.570	0.216	PSG*10...	1.62
FPGN10-15T25	0.590	1.181	0.625	0.625	4.946	0.625	0.610	0.216	PSG*15...	1.62
FPGN12-15T25	0.590	1.181	0.750	0.750	5.196	0.750	0.670	0.216	PSG*15...	1.62
FPGN12-20T32	0.787	1.456	0.750	0.750	5.196	0.750	0.770	0.216	PSG*20...	6.27
FPGN16-20T32	0.787	1.456	1.000	1.000	6.196	1.000	0.890	0.216	PSG*20...	6.27
FPGN16-25T36	0.984	1.614	1.000	1.000	6.196	1.000	0.990	0.216	PSG*25...	6.27

PSGB insert blank is available for tailored inserts.

(1) Can be used for both wide grooving and wide profile grooving

Torque: Recommended clamping torque: lbs-ft

CDX, LF, f2 are dimensions when PSGM insert is attached. When mounting PSGB insert, the dimensions will be 0.197" (5 mm) shorter.

SPARE PARTS

Designation	Lever	Clamping screw	Spring	Wrench
FPGN**-10T..., 15T...	FCL4	FCS3	BP-5	P-2.5
FPGN**-20T..., 25T...	FCL8	FCS6	BP-9	P-5

Reference pages: Inserts → **F091**, Standard cutting conditions → **F092**



SPGN

Screw-on external wide profile grooving toolholder

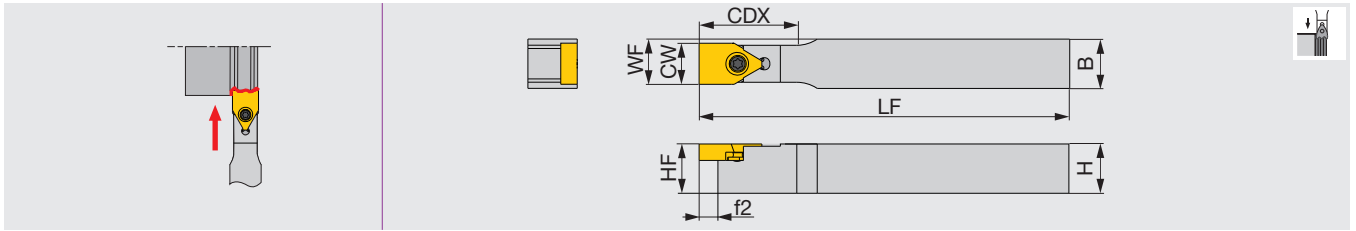

Inch	CW	CDX	H	B	LF	HF	WF	f2	Insert ⁽¹⁾	Torque
SPGN08-10T20	0.394	0.984	0.500	0.500	4.946	0.500	0.450	0.216	PSGB10	0.96
SPGN10-10T20	0.394	0.984	0.625	0.625	4.946	0.625	0.510	0.216	PSGB10	0.96
SPGN12-10T20	0.394	0.984	0.750	0.750	5.196	0.750	0.570	0.216	PSGB10	0.96
SPGN10-15T25	0.590	1.181	0.625	0.625	4.946	0.625	0.610	0.216	PSGB15	2.58
SPGN12-15T25	0.590	1.181	0.750	0.750	5.196	0.750	0.670	0.216	PSGB15	2.58
SPGN12-20T32	0.787	1.456	0.750	0.750	5.196	0.750	0.770	0.216	PSGB20	3.69
SPGN16-20T32	0.787	1.456	1.000	1.000	6.196	1.000	0.890	0.216	PSGB20	3.69
SPGN16-25T36	0.984	1.614	1.000	1.000	6.196	1.000	0.990	0.216	PSGB25	3.69

PSGB insert blank is available for tailored inserts.
Torque: Recommended clamping torque: lbs-ft

SPARE PARTS

Designation	Clamping screw	Wrench
SPGN**-10T20	CSTB-3L081	T-8F
SPGN**-15T25	CSTB-4	T-15F
SPGN**-20T..., 25T...	CSTB-5	T-20F

TUNG H^{HEAVY}GROOVE - Chipbreaker Guide

PSGM



For wide grooving
Improved productivity with excellent chip control and the chipbreaker designed for high feed

CW = 0.394" - 0.984"
(10 mm - 25 mm)

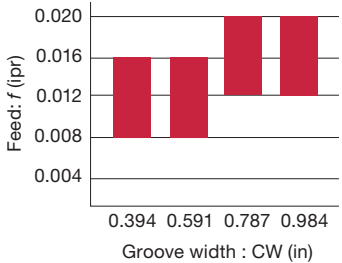



PSGB

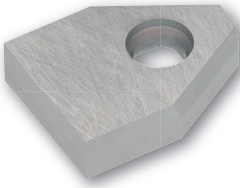

Blank for wide profile grooving inserts
Can be prepared for various insert shapes. Shortened cutting time and improved productivity with one-pass operations

CW = 0.394" - 0.984"
(10 mm - 25 mm)

Specially tailored inserts (example)

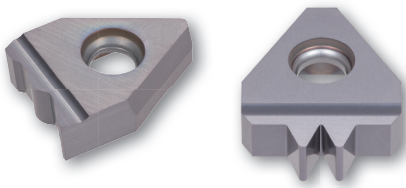



Reference pages: Inserts → **F091**, Standard cutting conditions → **F092**

INSERT

PSGM

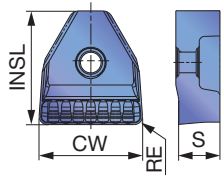

P	Steel	★					
M	Stainless	★					
K	Cast iron	☆					
N	Non-ferrous						
S	Superalloys						
H	Hard materials						

★ : First choice
☆ : Second choice

Designation	CW* (mm)	CW** (in)	RE (in)	Coated						INSL (in)	S (in)
				AH725							
PSGM10-08	10	0.394	0.032	●						0.433	0.157
PSGM15-15	15	0.590	0.059	●						0.591	0.197
PSGM20-20	20	0.787	0.079	●						0.866	0.256
PSGM25-20	25	0.984	0.079	●						0.866	0.256

*Tolerance CW ± 0.08 (CW = 10 mm), ± 0.1 (CW ≥ 15 mm)

**Tolerance CW ± 0.003* (CW = 0.394"), ± 0.004" (CW ≥ 0.591")

● : Line up

PSGB

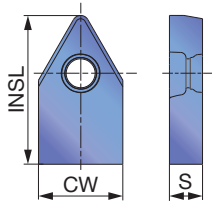

P	Steel	☆	★				
M	Stainless		★				
K	Cast iron	★					
N	Non-ferrous	★					
S	Superalloys	☆					
H	Hard materials						

★ : First choice
☆ : Second choice

Designation	CW±0.025 (mm)	CW±0.001 (in)	Uncoated						INSL (in)	S (in)
			TH10	UX30						
PSGB10	10.2	0.402	●	●					0.709	0.157
PSGB15	15.2	0.598	●	●					0.787	0.197
PSGB20	20.2	0.795	●	●					1.062	0.256
PSGB25	25.2	0.992	●	●					1.062	0.256

● : Line up



STANDARD CUTTING CONDITIONS



Wide grooving (PSGM insert)

ISO	Workpiece material	Hardness (HB)	Grade	Cutting speed Vc (sfm)
P	Alloy steel 4140, 8620, etc.	< 300	AH725	165 - 590
	Alloy steel 4140, 8620, etc.	< 300	UX30	165 - 390
Groove width: CW (in)				
Feed: f (ipr)	0.394	0.590	0.787	0.984
	0.008 - 0.016	0.008 - 0.016	0.012 - 0.020	0.012 - 0.020

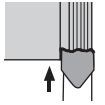

Wide profile grooving (PSGB insert)

ISO	Workpiece material	Hardness (HB)	Grade	Cutting speed Vc (sfm)
P	Steel 1045, 1055, etc.	< 200	UX30	165 - 490
	Alloy steel 4140, 8620, etc.	< 300	UX30	165 - 390
M	Stainless steel 304SS, 316SS, 17-4 PH, etc.	< 200	UX30	165 - 390
K	Gray cast iron Class 25, Class 30, etc.	-	TH10	165 - 490
	Ductile cast iron 60-40-18, 60-55-06, etc.	-	TH10	165 - 390
N	Aluminum alloys Si < 12%, etc.	-	TH10	330 - 1640



■ Spare parts for internal coolant supply attachment (Order separately)

No.	Parts name	Designation	Note
①	Body	FPGR...	-
②	Insert	PSGM...	-
③	Coolant supply attachment	SGCU-341	-
④	Connector	Commercial items can be used	G 1/8 thread
			NPT 1/8 thread

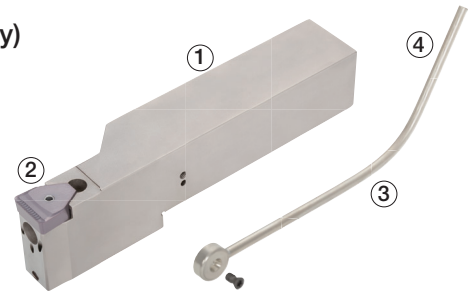

TGTSR/L

External grooving toolholder, for 3 corner inserts

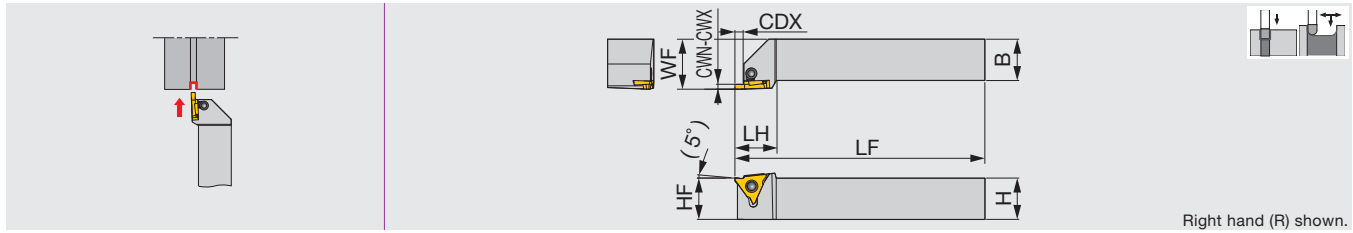

Inch	CWN	CWX	CDX	H	B	LF	LH	HF	WF	Torque
TGTSR16-3	0.013	0.100	0.110	1.00	1.00	6	0.98	1.00	1.00	2.21
TGTSR16-4-1	0.040	0.057	0.100	1.00	1.00	6	1.00	1.00	1.00	2.21
TGTSR16-4-2	0.060	0.090	0.160	1.00	1.00	6	1.00	1.00	1.00	2.21
TGTSR16-4-3	0.100	0.180	0.210	1.00	1.00	6	1.00	1.00	1.00	2.21

Metric	CWN	CWX	CDX	H	B	LF	LH	HF	WF	Torque*
TGTSR/L2020K16	0.33	2.5	2.5	20	20	125	25	20	25	3
TGTSR/L2525M16	0.33	2.5	2.5	25	25	150	25	25	30	3
TGTSR/L2020K22-1	1	1.45	2	20	20	125	25	20	25	3
TGTSR/L2020K22-2	1.5	2.3	3.5	20	20	125	25	20	25	3
TGTSR/L2020K22-3	2.5	4.5	5	20	20	125	25	20	25	3
TGTSR/L2525M22-1	1	1.45	2	25	25	150	25	25	30	3
TGTSR/L2525M22-2	1.5	2.3	3.5	25	25	150	25	25	30	3
TGTSR/L2525M22-3	2.5	4.5	5	25	25	150	25	25	30	3

Use right-hand toolholders (TGTSR) with right-hand inserts (GBR); and left-hand toolholders (TGTSL) with left-hand inserts (GBL).
See below insert table.
Torque: Recommended clamping torque: lbs-ft (*N·m)

Designation	Insert
TGTSR16-3	GBR/L32...
TGTSR16-4-1	GBR43050R ~ 145
TGTSR16-4-2	GBR43150 ~ 230
TGTSR16-4-3	GBR43250 ~ 450
TGTSR/L2020K16	GBR/L32...
TGTSR/L2525M16	GBR/L32...
TGTSR/L2020K22-1	GBR/L43125 ~ 145 GBR/L43050R
TGTSR/L2020K22-2	GBR/L43150 ~ 230 GBR/L43075R ~ 100R
TGTSR/L2020K22-3	GBR/L43250 ~ 450 GBR/L43125R ~ 200R
TGTSR/L2525M22-1	GBR/L43125 ~ 145 GBR/L43050R
TGTSR/L2525M22-2	GBR/L43150 ~ 230 GBR/L43075R ~ 100R
TGTSR/L2525M22-3	GBR/L43250 ~ 450 GBR/L43125R ~ 200R

SPARE PARTS



Designation	Clamp	Clamping screw	Wrench
TGTSR16-3	CP900	MCS520-2.5	P-2.5
TGTSR16-4...	CP910	MCS520-2.5	P-2.5
TGTSR/L****16	CP900	MCS520-2.5	P-2.5
TGTSR/L****22...	CP910	MCS520-2.5	P-2.5

Reference pages: Inserts → **F095 - F097**, Standard cutting conditions → **F097**



TGTR/L

Perpendicular toolholder for external grooving, for 3 corner inserts

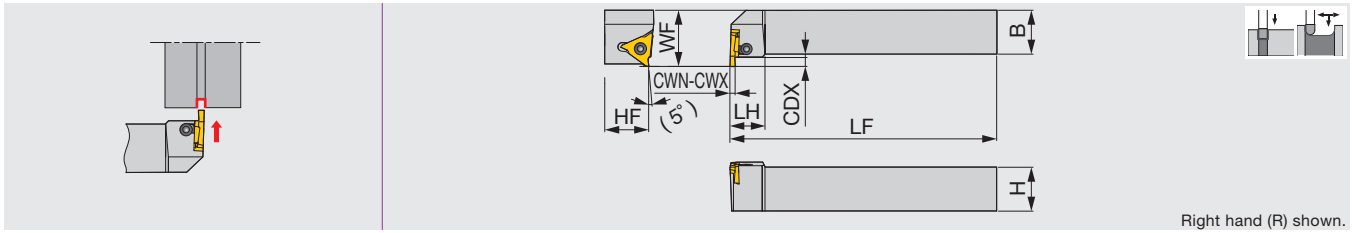

Metric	CWN	CWX	CDX	H	B	LF	LH	HF	WF	Torque
TGTR/L2020K16	0.33	2.5	2.5	20	20	125	20	20	27	3
TGTR/L2525M16	0.33	2.5	2.5	25	25	150	20	25	32	3
TGTR/L2020K22-1	1	1.45	2	20	20	125	20	20	27	3
TGTR/L2020K22-2	1.5	2.3	3.5	20	20	125	20	20	27	3
TGTR/L2020K22-3	2.5	4.5	5	20	20	125	20	20	27	3
TGTR/L2525M22-1	1	2.3	2	25	25	150	20	25	32	3
TGTR/L2525M22-2	1.5	2.3	3.5	25	25	150	20	25	32	3
TGTR/L2525M22-3	2.5	4.5	5	25	25	150	20	25	32	3

Use right-hand toolholders (TGTR) with left-hand inserts (GBL); and left-hand toolholders (TGTL) with right-hand inserts (GBR).
See below insert table.
Torque: Recommended clamping torque: N·m

Designation	Insert
TGTR/L2020K16	GBL/R32...
TGTR/L2525M16	GBL/R32...
TGTR/L2020K22-1	GBL/R43125 ~ 145 GBL/R43050R
TGTR/L2020K22-2	GBL/R43150 ~ 230 GBL/R43075R ~ 100R
TGTR/L2020K22-3	GBL/R43250 ~ 450 GBL/R43125R ~ 200R
TGTR/L2525M22-1	GBL/R43125 ~ 145 GBL/R43050R
TGTR/L2525M22-2	GBL/R43150 ~ 230 GBL/R43075R ~ 100R
TGTR/L2525M22-3	GBL/R43250 ~ 450 GBL/R43125R ~ 200R

SPARE PARTS

Designation	Clamp	Clamping screw	Wrench
TGTR/L****16	CP900	MCS520-2.5	P-2.5
TGTR/L****22...	CP910	MCS520-2.5	P-2.5

Reference pages: Inserts → **F095 - F097**, Standard cutting conditions → **F097**

INSERT

GBR/L32

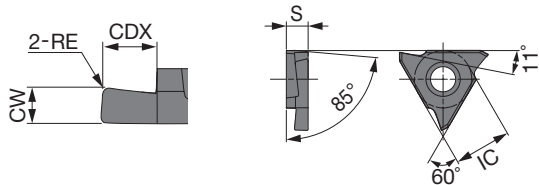

P	Steel	★		★						
M	Stainless	★								
K	Cast iron	★		☆						
N	Non-ferrous						★			
S	Superalloys	☆					☆			
H	Hard materials									

★ : First choice
☆ : Second choice

Designation	HAND	CW±0.025 (mm)	CW±0.001 (in)	RE (in)	Coated			Cermet			Uncoated			CDX (in)	IC (mm)	S (mm)	
					AH710			NS9530			KS05F						
GBR32033	R	0.33	0.013	0.0012	●			●			●				0.031	9.53	3.18
GBL32033	L	0.33	0.013	0.0012	●										0.031	9.53	3.18
GBR32050	R	0.5	0.020	0.002	●			●			●				0.047	9.53	3.18
GBL32050	L	0.5	0.020	0.002	●										0.047	9.53	3.18
GBR32075	R	0.75	0.030	0.002	●			●			●				0.079	9.53	3.18
GBL32075	L	0.75	0.030	0.002	●			●			●				0.079	9.53	3.18
GBR32095	R	0.95	0.037	0.002	●			●			●				0.079	9.53	3.18
GBL32095	L	0.95	0.037	0.002	●			●			●				0.079	9.53	3.18
GBR32100	R	1	0.039	0.002	●			●			●				0.079	9.53	3.18
GBL32100	L	1	0.039	0.002	●			●			●				0.079	9.53	3.18
GBR32125	R	1.25	0.049	0.008	●			●			●				0.079	9.53	3.18
GBL32125	L	1.25	0.049	0.008	●			●			●				0.079	9.53	3.18
GBR32145	R	1.45	0.057	0.008	●			●			●				0.079	9.53	3.18
GBL32145	L	1.45	0.057	0.008	●			●			●				0.079	9.53	3.18
GBR32150	R	1.5	0.059	0.008	●			●			●				0.079	9.53	3.18
GBL32150	L	1.5	0.059	0.008	●			●			●				0.079	9.53	3.18
GBR32200	R	2	0.079	0.008	●			●			●				0.098	9.53	3.18
GBL32200	L	2	0.079	0.008	●			●			●				0.098	9.53	3.18
GBR32250	R	2.5	0.098	0.008	●			●			●				0.098	9.53	3.18
GBL32250	L	2.5	0.098	0.008	●			●			●				0.098	9.53	3.18

● : Line up



GBR/L43

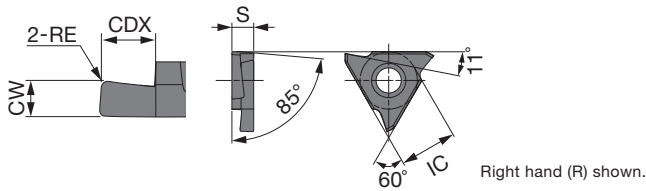

P	Steel	★		★						
M	Stainless	★								
K	Cast iron	★		☆						
N	Non-ferrous						★			
S	Superalloys	☆					☆			
H	Hard materials									

★ : First choice
☆ : Second choice

Designation	HAND	CW±0.025 (mm)	CW±0.001 (in)	RE (in)	Coated			Cermet			Uncoated			CDX (in)	IC (mm)	S (mm)	
					AH710			NS9530			KS05F						
GBR43125	R	1.25	0.049	0.008	●			●			●				0.079	12.7	4.76
GBL43125	L	1.25	0.049	0.008	●										0.079	12.7	4.76
GBR43145	R	1.45	0.057	0.008	●			●			●				0.079	12.7	4.76
GBL43145	L	1.45	0.057	0.008	●										0.079	12.7	4.76
GBR43150	R	1.50	0.059	0.008	●			●			●				0.138	12.7	4.76
GBL43150	L	1.50	0.059	0.008	●										0.138	12.7	4.76
GBR43175	R	1.75	0.069	0.008	●			●			●				0.138	12.7	4.76
GBL43175	L	1.75	0.069	0.008	●										0.138	12.7	4.76
GBR43185	R	1.85	0.073	0.008	●			●			●				0.138	12.7	4.76
GBL43185	L	1.85	0.073	0.008	●										0.138	12.7	4.76
GBR43200	R	2	0.079	0.008	●			●			●				0.138	12.7	4.76
GBL43200	L	2	0.079	0.008	●										0.138	12.7	4.76
GBR43230	R	2.3	0.091	0.008	●			●			●				0.138	12.7	4.76
GBL43230	L	2.3	0.091	0.008	●										0.138	12.7	4.76
GBR43250	R	2.5	0.098	0.012	●			●			●				0.197	12.7	4.76
GBL43250	L	2.5	0.098	0.012	●										0.197	12.7	4.76
GBR43265	R	2.65	0.104	0.012	●			●			●				0.197	12.7	4.76
GBL43265	L	2.65	0.104	0.012	●										0.197	12.7	4.76
GBR43280	R	2.8	0.110	0.012	●			●			●				0.197	12.7	4.76
GBL43280	L	2.8	0.110	0.012	●										0.197	12.7	4.76
GBR43300	R	3	0.118	0.012	●			●			●				0.197	12.7	4.76
GBL43300	L	3	0.118	0.012	●										0.197	12.7	4.76
GBR43330	R	3.3	0.130	0.012	●			●			●				0.197	12.7	4.76
GBL43330	L	3.3	0.130	0.012	●										0.197	12.7	4.76
GBR43350	R	3.5	0.138	0.012	●			●			●				0.197	12.7	4.76
GBL43350	L	3.5	0.138	0.012	●										0.197	12.7	4.76
GBR43400	R	4	0.157	0.016	●			●			●				0.197	12.7	4.76
GBL43400	L	4	0.157	0.016	●										0.197	12.7	4.76
GBR43430	R	4.3	0.169	0.016	●			●			●				0.197	12.7	4.76
GBL43430	L	4.3	0.169	0.016	●										0.197	12.7	4.76
GBR43450	R	4.5	0.177	0.016	●			●			●				0.197	12.7	4.76
GBL43450	L	4.5	0.177	0.016	●										0.197	12.7	4.76

● : Line up

Reference pages: Toolholders → **F093 - F094**

GBR/L43-R(full radius)

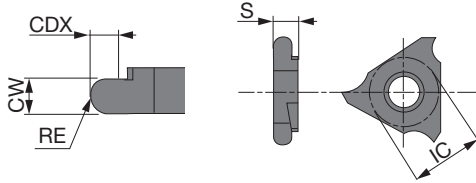

P	Steel	★		★							
M	Stainless	★									
K	Cast iron	★		☆							
N	Non-ferrous							★			
S	Superalloys	☆						☆			
H	Hard materials										

★ : First choice
☆ : Second choice

Designation	HAND	CW±0.025 (mm)	CW±0.001 (in)	RE (in)	Coated			Cermet			Uncoated			CDX (in)	IC (mm)	S (mm)	
					AH710			NS9530			KS05F						
GBR43050R	R	1	0.039	0.020	●			●			●				0.079	12.7	4.76
GBL43050R	L	1	0.039	0.020	●						●				0.079	12.7	4.76
GBR43075R	R	1.5	0.059	0.030	●			●			●				0.138	12.7	4.76
GBL43075R	L	1.5	0.059	0.030	●						●				0.138	12.7	4.76
GBR43100R	R	2	0.079	0.039	●			●			●				0.138	12.7	4.76
GBL43100R	L	2	0.079	0.039	●						●				0.138	12.7	4.76
GBR43125R	R	2.5	0.098	0.049	●			●			●				0.197	12.7	4.76
GBL43125R	L	2.5	0.098	0.049	●						●				0.197	12.7	4.76
GBR43150R	R	3	0.118	0.059	●			●			●				0.197	12.7	4.76
GBL43150R	L	3	0.118	0.059	●						●				0.197	12.7	4.76
GBR43200R	R	4	0.157	0.079	●			●			●				0.197	12.7	4.76
GBL43200R	L	4	0.157	0.079	●						●				0.197	12.7	4.76

● : Line up

STANDARD CUTTING CONDITIONS

ISO	Workpiece material	Hardness	Grade	Cutting Speed Vc (sfm)	Feed f (ipr)
P	Carbon steel, Alloy steel 1045 SAE, 4140 SAE, etc.	150 - 240HB	NS9530	330 - 650	0.001 - 0.010
		150 - 240HB	AH710	200 - 500	0.002 - 0.010
M	Stainless steel 303, 304, etc.	≤ 240HB	AH710	200 - 500	0.002 - 0.006
K	Cast irons 250, etc.	Tensile strength ≤ 350 N/mm ²	AH710	200 - 500	0.002 - 0.006
N	Non-ferrous metals Aluminum, etc.	-	KS05F	650 - 980	0.002 - 0.006

Reference pages: Toolholders → **F093 - F094**

Grade
Insert
Toolholder
Ext. Toolholder
Int. Toolholder
Threading
Grooving
Miniature Tool
Milling Cutter
Endmill
Drilling Tool
Tooling System
User's Guide
Index



SGTR/L

External grooving toolholder, for 3 corner inserts

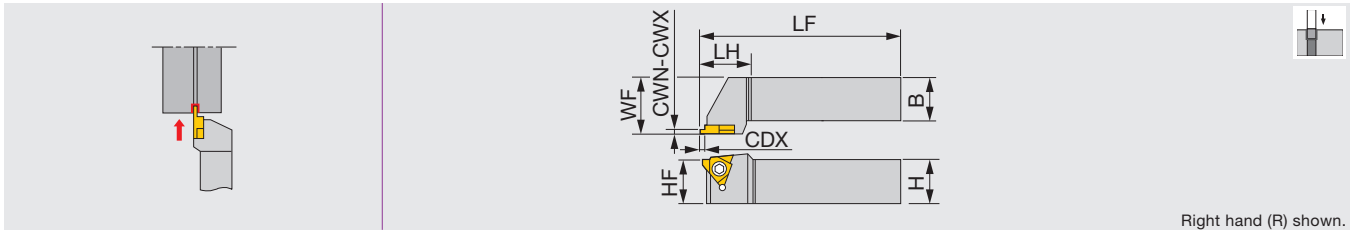

Right hand (R) shown.

Metric	CWN	CWX	CDX	H	B	LF	LH	HF	WF	Insert	Torque
SGTR1616-3	1.15	2.7	1.5 - 3	16	16	100	20	16	20	GLR/L3...	3.5
SGTR/L2020-3	1.15	2.7	1.5 - 3	20	20	125	20	20	25	GLR/L3...	3.5
SGTR/L2525-3	1.15	2.7	1.5 - 3	25	25	150	20	25	32	GLR/L3...	3.5
SGTR/L2020-4	1.15	4.2	1.5 - 4	20	20	125	30	20	25	GLR/L4...,GOR/L4...	5
SGTR/L2525-4	1.15	4.2	1.5 - 4	25	25	150	30	25	32	GLR/L4...,GOR/L4...	5

Torque: Recommended clamping torque: N·m

SPARE PARTS

Designation	Clamping screw	Wrench
SGTR/L***-3	CSTB-4	T-15F
SGTR/L***-4	CSTB-5	T-20F

INSERT

GOR/L (For O-ring)

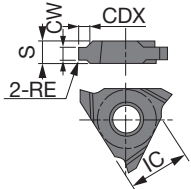

Right hand (R) shown.

P Steel	★		★						
M Stainless				★					
K Cast iron	☆								
N Non-ferrous									
S Superalloys									
H Hard materials									

★ : First choice
☆ : Second choice

Designation	HAND	CW ^{+0.004} / _{+0.002} (in)	CW ^{+0.1} / _{+0.05} (mm)	RE (mm)	Cement		Uncoated				CDX (mm)	IC (mm)	S (mm)	
					NS9530	UX30								
GOR4190	R	0.098	2.5	0.4	●	●						1.5	12.7	4.76
GOR4240	R	0.126	3.2	0.4	●	●						2	12.7	4.76
GOR4310	R	0.161	4.1	0.7	●	●						2.5	12.7	4.76

● : Line up

Reference pages: Inserts → **F098 - F099**

GLR/L (For lock ring)

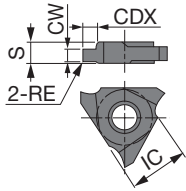

Right hand (R) shown.

P	Steel	★		★					
M	Stainless			★					
K	Cast iron	☆							
N	Non-ferrous								
S	Superalloys								
H	Hard materials								

★ : First choice
☆ : Second choice

Designation	HAND	CW ^{+0.004} _{+0.002} (in)	CW ^{+0.1} _{+0.05} (mm)	RE (mm)	Cermets		Uncoated						CDX (mm)	IC (mm)	S (mm)
					NS9530		UX30								
GLR3115	R	0.045	1.15	0.1	●		●						1.5	9.53	3.18
GLL3115	L	0.045	1.15	0.1	●		●						1.5	9.53	3.18
GLR3135	R	0.053	1.35	0.1	●		●						1.5	9.53	3.18
GLL3135	L	0.053	1.35	0.1	●		●						1.5	9.53	3.18
GLR3165	R	0.065	1.65	0.1	●		●						2	9.53	3.18
GLR3175	R	0.069	1.75	0.1	●		●						2	9.53	3.18
GLL3175	L	0.069	1.75	0.1	●		●						2	9.53	3.18
GLR3195	R	0.077	1.95	0.1	●		●						2.5	9.53	3.18
GLL3195	L	0.077	1.95	0.1	●		●						2.5	9.53	3.18
GLR3220	R	0.087	2.2	0.1	●		●						3	9.53	3.18
GLL3220	L	0.087	2.2	0.1	●		●						3	9.53	3.18
GLR3270	R	0.106	2.7	0.1	●		●						3	9.53	3.18
GLL3270	L	0.106	2.7	0.1	●		●						3	9.53	3.18
GLR4115	R	0.045	1.15	0.1	●		●						1.5	12.7	4.76
GLR4135	R	0.053	1.35	0.1	●		●						1.5	12.7	4.76
GLR4165	R	0.065	1.65	0.1	●		●						2	12.7	4.76
GLR4175	R	0.069	1.75	0.1	●		●						2	12.7	4.76
GLR4190	R	0.075	1.9	0.1	●		●						2.5	12.7	4.76
GLR4195	R	0.077	1.95	0.1	●		●						2.5	12.7	4.76
GLR4220	R	0.087	2.2	0.1	●		●						3.5	12.7	4.76
GLL4220	L	0.087	2.2	0.1	●		●						3.5	12.7	4.76
GLR4270	R	0.106	2.7	0.1	●		●						3.5	12.7	4.76
GLR4320	R	0.126	3.2	0.1	●		●						4	12.7	4.76
GLL4320	L	0.126	3.2	0.1	●		●						4	12.7	4.76
GLR4420	R	0.165	4.2	0.1	●		●						4	12.7	4.76
GLL4420	L	0.165	4.2	0.1	●		●						4	12.7	4.76

● : Line up

STANDARD CUTTING CONDITIONS

ISO	Workpiece material	Grade	Cutting speed Vc (sfm)	Feed: f (ipr)		
				CW < 0.079"	CW = 0.079" - 0.157"	CW > 0.157"
P	Carbon steel	NS9530	260 - 650	0.002 - 0.004	0.003 - 0.008	0.003 - 0.010
		UX30	200 - 500	0.002 - 0.004	0.003 - 0.008	0.003 - 0.010

Reference pages: Toolholders → **F098**

Grade
Insert
Ext. Toolholder
Int. Toolholder
Threading
Grooving
Miniature Tool
Milling Cutter
Endmill
Drilling Tool
User's Guide Tooling System
Index



GX-R/LE

External grooving toolholder, for 2 corner inserts

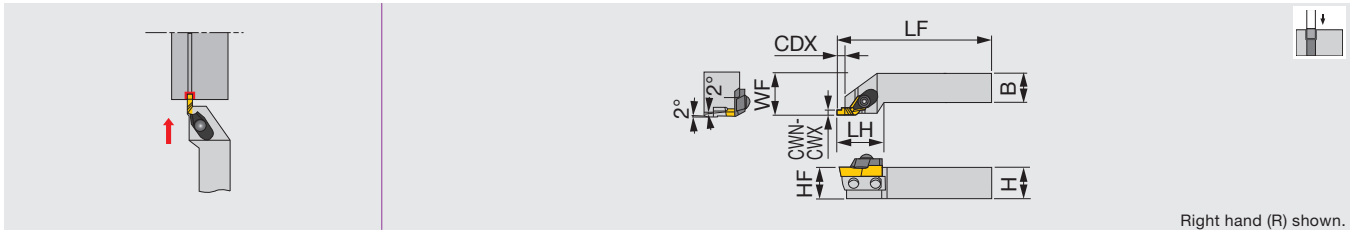

Right hand (R) shown.

Inch	CWN	CWX	CDX	H	B	LF	LH	HF	WF	Insert	Torque
GX-1212REU	0.039	0.177	0.059 - 0.236	0.75	0.75	5.00	1.38	0.75	1.00	XGR63...	3.69
GX-1616REU	0.039	0.177	0.059 - 0.236	1.00	1.00	5.90	1.38	1.00	1.25	XGR63...	3.69

Metric	CWN	CWX	CDX	H	B	LF	LH	HF	WF	Insert	Torque*
GX-2020R/LE	1	4.5	1.5 - 6	20	20	125	40	20	25	XGR/L63...	5
GX-2525R/LE	1	4.5	1.5 - 6	25	25	150	38	25	32	XGR/L63...	5

Use right-hand toolholders (GX-****RE) with right-hand inserts (XGR); and left-hand toolholders (GX-****LE) with left-hand inserts (XGL).
Torque: Recommended clamping torque: lbs-ft (*N·m)

SPARE PARTS

Designation	Clamp set	Clamp screw	Shim	Shim screw	Wrench
GX-1212REU, GX-2020RE	CP81A	RT-1	SL-6R	BHM4-8	P-4
GX-2020LE	CP81A	RT-1	SL-6L	BHM4-8	P-4
GX-1616REU, GX-2525RE	CP81A	RT-1	SL-1R	BHM4-8	P-4
GX-2525LE	CP81A	RT-1	SL-1L	BHM4-8	P-4

Max. groove width and max. groove depth will depend on the insert type.

Reference pages: Inserts → **F101 - F102**, Standard cutting conditions → **F102**

INSERT

XGR/L

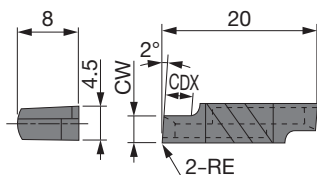

Right hand (R) shown.

P	Steel	★		☆	★				
M	Stainless					★			
K	Cast iron	☆			★				
N	Non-ferrous				★				
S	Superalloys				☆				
H	Hard materials								

★ : First choice
☆ : Second choice

Designation	HAND	CW±0.025 (mm)	CW±0.001 (in)	RE (in)	Cermet		Uncoated		CDX (in)
					NS9530		TH10	UX30	
XGR6310-02	R	1	0.039	0.008	●		●	●	0.059
XGL6310-02	L	1	0.039	0.008	●		●	●	0.059
XGR6315-02	R	1.5	0.059	0.008	●		●	●	0.091
XGL6315-02	L	1.5	0.059	0.008	●		●	●	0.091
XGR6320-02	R	2	0.079	0.008	●		●	●	0.118
XGL6320-02	L	2	0.079	0.008	●		●	●	0.118
XGR6325-02	R	2.5	0.098	0.008	●		●	●	0.150
XGL6325-02	L	2.5	0.098	0.008	●		●	●	0.150
XGR6330-02	R	3	0.118	0.008	●		●	●	0.177
XGL6330-02	L	3	0.118	0.008	●		●	●	0.177
XGR6335-02	R	3.5	0.138	0.008	●		●	●	0.209
XGL6335-02	L	3.5	0.138	0.008	●		●	●	0.209
XGR6340-02	R	4	0.157	0.008	●		●	●	0.236
XGL6340-02	L	4	0.157	0.008	●		●	●	0.236
XGR6345-02	R	4.5	0.177	0.008	●		●	●	0.236
XGL6345-02	L	4.5	0.177	0.008	●		●	●	0.236

Use right-hand toolholders (GX-****RE) with right-hand inserts (XGR...)
left-hand toolholders (GX-****LE) with left-hand inserts (XGL...).

● : Line up

Grade
Insert
Toolholder
Ext. Toolholder
Int. Toolholder
Threading
Grooving
Miniature Tool
Milling Cutter
Endmill
Drilling Tool
Tooling System
User's Guide
Index



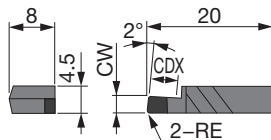

Right hand (R) shown.

P	Steel						
M	Stainless						
K	Cast iron						
N	Non-ferrous						
S	Superalloys						
H	Hard materials	★					

★ : First choice
☆ : Second choice

Designation	HAND	CW±0.05 (mm)	CW±0.002 (in)	RE (in)	CBN							CDX (in)	
					BX360								
XGL6310S-QBN	L	1	0.039	0.008	●								0.059
XGR6315S-QBN	R	1.5	0.059	0.008	●								0.091
XGL6315S-QBN	L	1.5	0.059	0.008	●								0.091
XGR6320S-QBN	R	2	0.079	0.008	●								0.118
XGL6320S-QBN	L	2	0.079	0.008	●								0.118
XGR6325S-QBN	R	2.5	0.098	0.008	●								0.150
XGL6325S-QBN	L	2.5	0.098	0.008	●								0.150
XGR6330S-QBN	R	3	0.118	0.008	●								0.177
XGL6330S-QBN	L	3	0.118	0.008	●								0.177
XGR6335S-QBN	R	3.5	0.138	0.008	●								0.209
XGL6335S-QBN	L	3.5	0.138	0.008	●								0.209
XGR6340S-QBN	R	4	0.157	0.008	●								0.236
XGL6340S-QBN	L	4	0.157	0.008	●								0.236
XGR6345S-QBN	R	4.5	0.177	0.008	●								0.236
XGL6345S-QBN	L	4.5	0.177	0.008	●								0.236

Use right-hand toolholders (GX-****RE) with right-hand inserts (XGR...) left-hand toolholders (GX-****LE) with left-hand inserts (XGL...).

● : Line up

STANDARD CUTTING CONDITIONS

ISO	Workpiece material	Grade	Cutting speed Vc (sfm)	Feed: f (ipr)		
				CW < 0.079"	CW = 0.079" - 0.157"	CW > 0.157"
P	Carbon steel	NS9530	262 - 656	0.002 - 0.004	0.003 - 0.008	0.003 - 0.010
		UX30	197 - 492	0.002 - 0.004	0.003 - 0.008	0.003 - 0.010
K	Cast irons , Light alloys	TH10	197 - 492	0.002 - 0.004	0.003 - 0.008	0.003 - 0.010
H	Hardened steel	BX360	164 - 591	0.002 - 0.006	0.002 - 0.006	0.002 - 0.006

Reference pages: Toolholders → **F100**

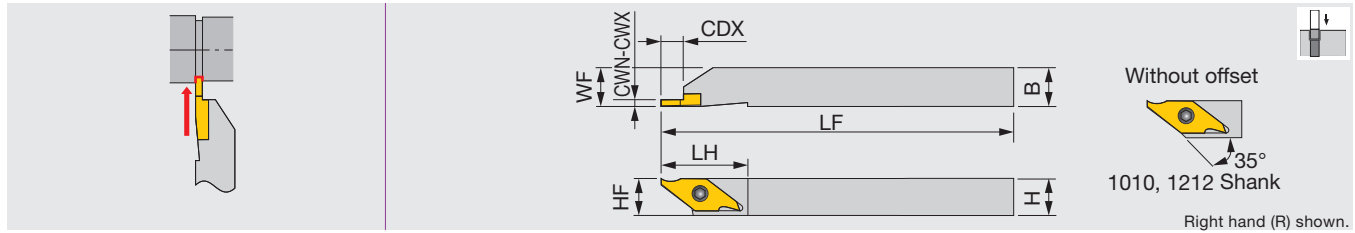

Inch	CWN	CWX	CDX	H	B	LF	LH	HF	WF	Insert	Torque
JSVGR/L062.5	0.013	0.079	0.028 - 0.217	0.375	0.375	5	0.875	0.375	0.375	JVGR/L...	1.70
JSVGR/L082.5	0.013	0.079	0.028 - 0.217	0.500	0.500	5	0.875	0.500	0.500	JVGR/L...	1.70
JSVGR/L102.5	0.013	0.079	0.028 - 0.217	0.625	0.625	5	0.875	0.625	0.625	JVGR/L...	1.70

Metric	CWN	CWX	CDX	H	B	LF	LH	HF	WF	Insert	Torque*
JSVGR/L1010K-C	0.33	2	0.7 - 5.5	10	10	125	23	10	10	JVGR/L...	2.3
JSVGR/L1212K-C	0.33	2	0.7 - 5.5	12	12	125	23	12	12	JVGR/L...	2.3
JSVGR/L1616K	0.33	2	0.7 - 5.5	16	16	125	23	16	16	JVGR/L...	2.3

Torque: Recommended clamping torque: lbs-ft (*N·m)

SPARE PARTS

Designation	Clamping screw	Wrench
JSVGR/L...	CSTB-3S	T-9F (Optional T-9L)

INSERT

JVG (with hand, sharp edge)

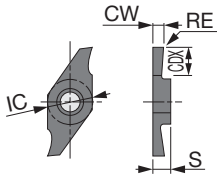

Right hand (R) shown.

	P	M	K	N	S	H
Steel	★	★				
Stainless	★	★				
Cast iron			☆			
Non-ferrous					★	
Superalloys					★	
Hard materials						

★ : First choice
☆ : Second choice

Designation	HAND	CW ₀ ^{+0.05} (mm)	CW ₀ ^{+0.002} (in)	RE (in)	Coated		Cermet		Uncoated		CDX (in)	IC (mm)	S (mm)
					SH725	J740	NS9530		TH10				
JVGR033F	R	0.33	0.013	0	●	●			●		0.028	7.94	3.18
JVGL033F	L	0.33	0.013	0	●						0.028	7.94	3.18
JVGR050F	R	0.5	0.020	0	●	●			●		0.043	7.94	3.18
JVGL050F	L	0.5	0.020	0	●						0.043	7.94	3.18
JVGR075F	R	0.75	0.030	0	●	●			●		0.075	7.94	3.18
JVGL075F	L	0.75	0.030	0	●						0.075	7.94	3.18
JVGR095F	R	0.95	0.037	0	●	●			●		0.075	7.94	3.18
JVGL095F	L	0.95	0.037	0	●						0.075	7.94	3.18
JVGR100F	R	1	0.039	0	●	●	●		●		0.217	7.94	3.18
JVGL100F	L	1	0.039	0	●		●		●		0.217	7.94	3.18
JVGR125F	R	1.25	0.049	0	●	●			●		0.197	7.94	3.18
JVGL125F	L	1.25	0.049	0	●						0.197	7.94	3.18
JVGR150F	R	1.5	0.059	0	●	●	●		●		0.217	7.94	3.18
JVGL150F	L	1.5	0.059	0	●		●		●		0.217	7.94	3.18
JVGR200F	R	2	0.079	0	●	●	●		●		0.217	7.94	3.18
JVGL200F	L	2	0.079	0	●						0.217	7.94	3.18

● : Line up

Reference pages: Standard cutting conditions → **F110**

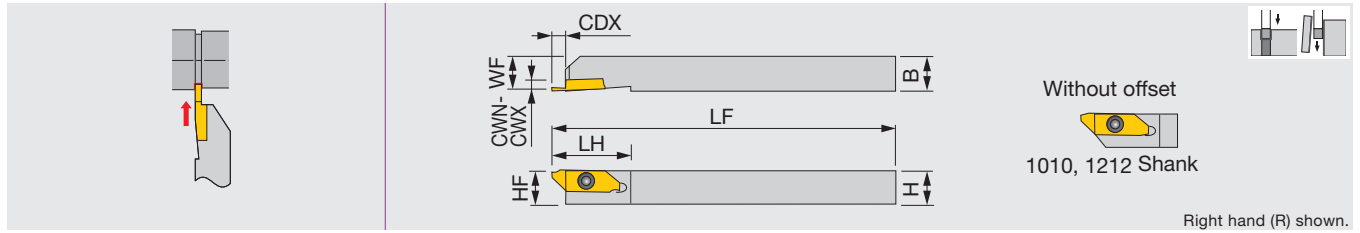

Metric	CWN	CWX	CDX	H	B	LF	LH	HF	WF	Insert	Torque
JSXGR/L1010K8-C	0.7	2	4.5 - 6	10	10	125	29	10	9.9	JXG...	1.3
JSXGR/L1212K8-C	0.7	2	4.5 - 6	12	12	125	29	12	11.9	JXG...	1.3
JSXGR/L1616K8	0.7	2	4.5 - 6	16	16	125	29	16	15.9	JXG...	1.3
JSXGR/L2020K8	0.7	2	4.5 - 6	20	20	125	29	20	19.9	JXG...	1.3
JSXGR/L2525K8	0.7	2	4.5 - 6	25	25	125	29	25	24.9	JXG...	1.3

Access to insert clamping screw is available from both sides of the tool for ease of insert indexing/changing. This toolholder can be used for JXF front-turning insert, JXR reverse-turning insert, and JXG parting and grooving insert. Torque: Recommended clamping torque: N·m

SPARE PARTS

Designation	Clamping screw	Wrench
JSXGR/L...	CSTB-4SD	T-8F

INSERT

JXG (with hand, sharp edge)

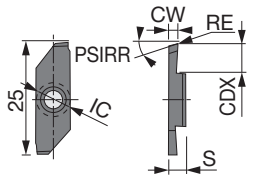

Right hand (R) shown.

P Steel	★		☆				
M Stainless	★						
K Cast iron			☆				
N Non-ferrous			★				
S Superalloys			★				
H Hard materials							

★ : First choice
☆ : Second choice

Designation	HAND	CW±0.001 (in)	CW±0.025 (mm)	RE (mm)	Coated		Uncoated		CDX (mm)	IC (mm)	PSIRR	S (mm)
					J740	TH10						
JXGR8070FA	R	0.028	0.7	0	●	●			4.5	8	15°	3.97
JXGL8070FA	L	0.028	0.7	0	●	●			4.5	8	15°	3.97
JXGR8070FA-005	R	0.028	0.7	0.05	●				4.5	8	15°	3.97
JXGR8100FA	R	0.039	1	0	●	●			6	8	15°	3.97
JXGL8100FA	L	0.039	1	0	●	●			6	8	15°	3.97
JXGR8100FA-005	R	0.039	1	0.05	●				6	8	15°	3.97
JXGR8100FA45	R	0.039	1	0	●	●			4.5	8	15°	3.97
JXGR8100FA45-005	R	0.039	1	0.05	●				4.5	8	15°	3.97
JXGR8150FA	R	0.059	1.5	0	●	●			6	8	15°	3.97
JXGL8150FA	L	0.059	1.5	0	●	●			6	8	15°	3.97
JXGR8150FA-005	R	0.059	1.5	0.05	●				6	8	15°	3.97
JXGR8150FA50	R	0.059	1.5	0	●	●			5	8	15°	3.97
JXGR8150FA50-005	R	0.059	1.5	0.05	●				5	8	15°	3.97
JXGR8180FA	R	0.071	1.8	0	●	●			6	8	15°	3.97
JXGR8180FA-005	R	0.071	1.8	0.05	●				6	8	15°	3.97
JXGR8200FA	R	0.079	2	0	●	●			6	8	15°	3.97
JXGL8200FA	L	0.079	2	0	●	●			6	8	15°	3.97
JXGR8200FA-005	R	0.079	2	0.05	●				6	8	15°	3.97
JXGR8200FN	R	0.079	2	0	●	●			6	8	0°	3.97
JXGL8200FN	L	0.079	2	0	●	●			6	8	0°	3.97
JXGR8200FN-005	R	0.079	2	0.05	●				6	8	0°	3.97

● : Line up

Reference pages: Standard cutting conditions → **F110**

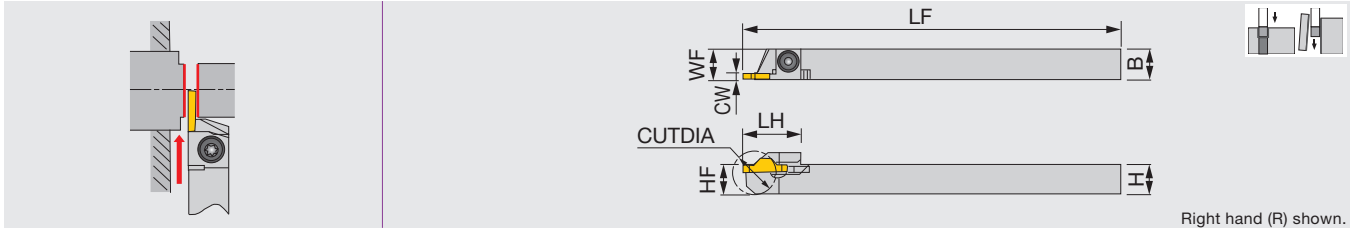

Inch	CW	CUTDIA	H	B	LF	LH	HF	WF	Insert	Torque
JCCWSR/L062	0.079	0.787	0.375	0.375	5	0.748	0.375	0.1875	JCC*200...	2.58
JCCWSR/L082	0.079	0.787	0.500	0.500	5	0.748	0.500	0.250	JCC*200...	2.58
JCCWSR/L102	0.079	0.787	0.625	0.625	5	0.748	0.625	0.3125	JCC*200...	2.58

Metric	CW	CUTDIA	H	B	LF	LH	HF	WF	Insert	Torque*
JCCWSR/L1010K2	2	20	10	10	125	19	10	10	JCC*200...	3.5
JCCWSR/L1212K2	2	20	12	12	125	19	12	12	JCC*200...	3.5
JCCWSR/L1616K2	2	20	16	16	125	19	16	16	JCC*200...	3.5
JCCWSR/L2020K2	2	20	20	20	125	19	20	20	JCC*200...	3.5
JCCWSR/L2525K2	2	20	25	25	125	19	25	25	JCC*200...	3.5

Torque: Recommended clamping torque: lbs-ft (*N-m)

SPARE PARTS

Designation	Clamping screw	Wrench
JCCWSR/L...	CSTB-4S	T-15F

INSERT

JCC (Sharp edge)

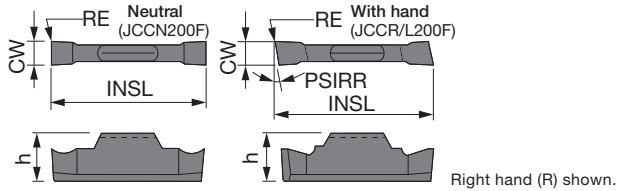

P Steel	★		☆					
M Stainless	★							
K Cast iron			☆					
N Non-ferrous			★					
S Superalloys			★					
H Hard materials								

★ : First choice
☆ : Second choice

Designation	HAND	CW±0.025 (mm)	CW±0.001 (in)	RE (in)	Coated		Uncoated		PSIRR	INSL (mm)	h (mm)
					J740	TH10					
JCCN200F	N	2	0.079	0	●	●			0°	15	4.8
JCCN200F-005	N	2	0.079	0.002	●				0°	15	4.8
JCCR200F	R	2	0.079	0	●	●			15°	15	4.8
JCCL200F	L	2	0.079	0	●	●			15°	15	4.8
JCCR200F-005	R	2	0.079	0.002	●				15°	15	4.8
JCCL200F-005	L	2	0.079	0.002	●				15°	15	4.8

● : Line up

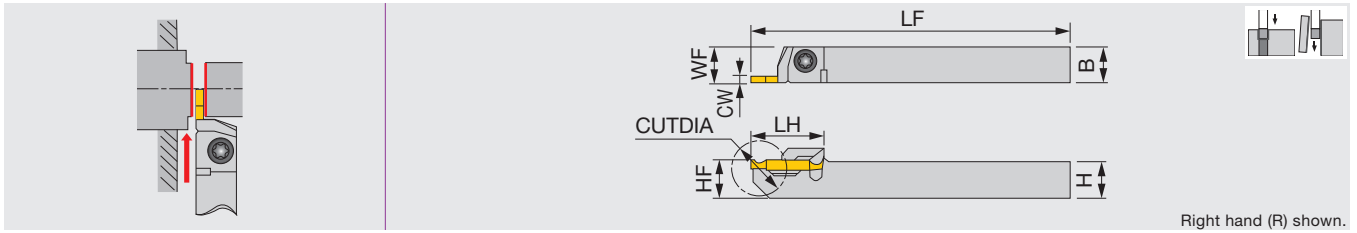

Metric	CW	CUTDIA	H	B	LF	LH	HF	WF	Insert	Torque
JCGWSR/L1010K2	2	20	10	10	125	20	10	10	JCGN200F...	3.5
JCGWSR/L1212K2	2	20	12	12	125	20	12	12	JCGN200F...	3.5
JCGWSR/L1616K2	2	20	16	16	125	20	16	16	JCGN200F...	3.5

Torque: Recommended clamping torque: N·m

SPARE PARTS

Designation	Clamping screw	Wrench
JCGWSR/L...	CSTB-4S	T-15F

INSERT

JCGN (Sharp edge)

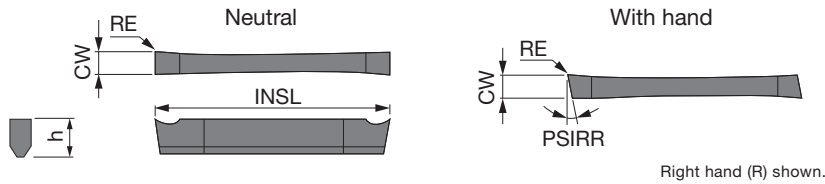

P Steel	★		☆					
M Stainless	★							
K Cast iron			☆					
N Non-ferrous			★					
S Superalloys			★					
H Hard materials								

★ : First choice
☆ : Second choice

Designation	HAND	CW±0.001 (in)	CW±0.025 (mm)	RE (mm)	Coated		Uncoated		PSIRR	INSL (mm)	h (mm)
					J740	TH10					
JCGN200F	N	0.079	2	0.05	●	●			0°	20	3
JCGN200FR	R	0.079	2	0.05	●	●			8°	20	3
JCGN200FL	L	0.079	2	0.05	●	●			8°	20	3

● : Line up

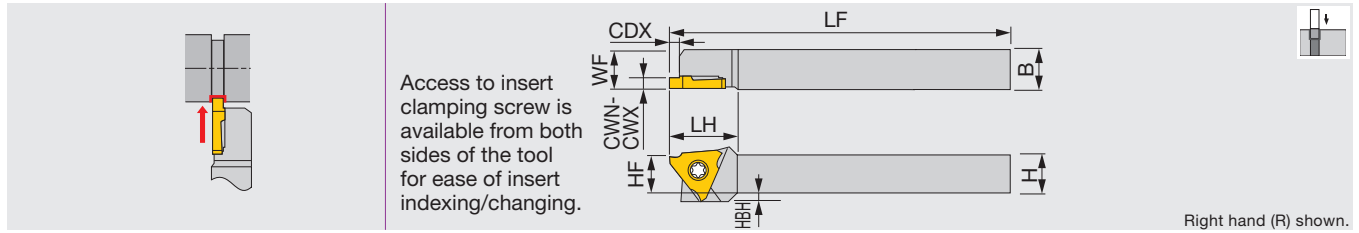

Inch	CWN	CWX	CDX	H	B	LF	LH	HF	WF	HBH	Insert	Torque
JSTGR/L063	0.013	0.118	0.028 - 0.102	0.375	0.375	5	0.75	0.375	0.375	0.100	JTGR/L3...	0.89
JSTGR/L083	0.013	0.118	0.028 - 0.102	0.500	0.500	5	0.75	0.500	0.500	-	JTGR/L3...	0.89
JSTGR/L103	0.013	0.118	0.028 - 0.102	0.625	0.625	5	0.75	0.625	0.625	-	JTGR/L3...	0.89

Metric	CWN	CWX	CDX	H	B	LF	LH	HF	WF	HBH	Insert	Torque*
JSTGR/L1010X3	0.33	3	0.7 - 2.6	10	10	120	18.5	10	10	2	JTGR/L3...	1.2
JSTGR/L1212F3	0.33	3	0.7 - 2.6	12	12	85	18.5	12	12	-	JTGR/L3...	1.2
JSTGR/L1212X3	0.33	3	0.7 - 2.6	12	12	120	18.5	12	12	-	JTGR/L3...	1.2
JSTGR/L1616X3	0.33	3	0.7 - 2.6	16	16	120	18.5	16	16	-	JTGR/L3...	1.2
JSTGL1616K3	0.33	3	0.7 - 2.6	16	16	125	18.5	16	16	-	JTGR/L3...	1.2

Torque: Recommended clamping torque: lbs-ft (*N·m)

SPARE PARTS

Designation	Clamping screw	Wrench
JSTGR/L...	CSTB-4SD	T-8F

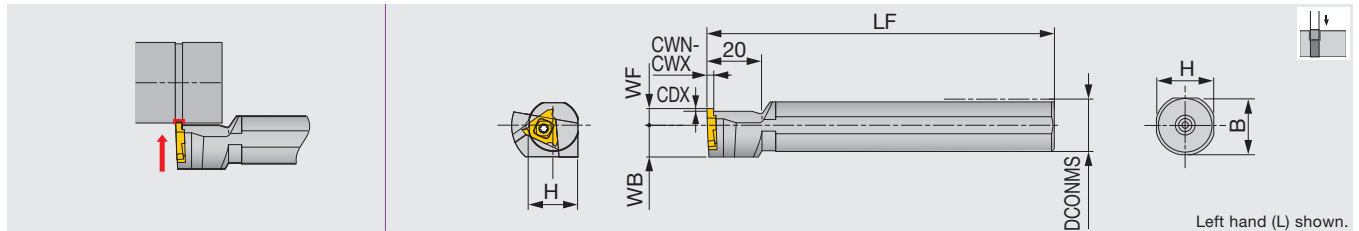

Metric	CWN	CWX	CDX	DCONMS	H	B	LF	WF	WB	Insert	Torque
JS19K-TGL3	0.33	3	0.7 - 2.6	19.05	18	18	125	6	11.5	JTGR3...	3
JS20K-TGL3	0.33	3	0.7 - 2.6	20	19	19	125	6	11.5	JTGR3...	3
JS22K-TGL3	0.33	3	0.7 - 2.6	22	21	21	125	6	11.5	JTGR3...	3
JS25K-TGL3	0.33	3	0.7 - 2.6	25.4	24	24	125	10	12.7	JTGR3...	3

Note: Use left-hand toolholders (L) with right-hand inserts (R).
Torque: Recommended clamping torque: N·m

SPARE PARTS

Designation	Clamping screw	Wrench
JS***-TGL3	CSTB-4S	T-15F



INSERT

JTG (Sharp edge)

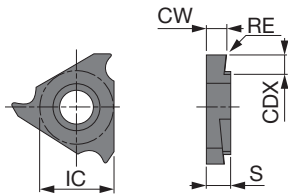

Right hand (R) shown.

P	Steel	★	★		★		☆		
M	Stainless	★	★						
K	Cast iron					☆	★		
N	Non-ferrous						★		
S	Superalloys						★		
H	Hard materials								

★ : First choice
☆ : Second choice

Designation	HAND	CW ₀ ^{+0.05} (mm)	CW ₀ ^{+0.002} (in)	RE (in)	Coated		Cermet	Uncoated		CDX (in)	IC (mm)	S (mm)
					SH725	J740	NS9530	TH10				
JTGR3033F	R	0.33	0.013	0.0012	●	●			●	0.028	9.53	3.18
JTGL3033F	L	0.33	0.013	0.0012		●			●	0.028	9.53	3.18
JTGR3033F-005	R	0.33	0.013	0.002	●					0.028	9.53	3.18
JTGR3043F	R	0.43	0.017	0.0012		●				0.043	9.53	3.18
JTGR3050F	R	0.5	0.020	0.0012	●	●	●		●	0.043	9.53	3.18
JTGL3050F	L	0.5	0.020	0.0012	●	●			●	0.043	9.53	3.18
JTGR3050F-005	R	0.5	0.020	0.002	●					0.043	9.53	3.18
JTGL3050F-005	L	0.5	0.020	0.002	●					0.043	9.53	3.18
JTGR3065F	R	0.65	0.026	0.0012	●	●				0.075	9.53	3.18
JTGR3065F-010	R	0.65	0.026	0.004	●					0.075	9.53	3.18
JTGR3075F	R	0.75	0.030	0.0012	●	●	●		●	0.075	9.53	3.18
JTGL3075F	L	0.75	0.030	0.0012	●	●	●		●	0.075	9.53	3.18
JTGR3075F-010	R	0.75	0.030	0.004	●					0.075	9.53	3.18
JTGL3075F-010	L	0.75	0.030	0.004	●					0.075	9.53	3.18
JTGR3080F	R	0.8	0.031	0.0012	●	●				0.075	9.53	3.18
JTGR3080F-010	R	0.8	0.031	0.004	●					0.075	9.53	3.18
JTGR3085F	R	0.85	0.033	0.0012	●	●				0.075	9.53	3.18
JTGR3095F	R	0.95	0.037	0.0012	●	●	●		●	0.075	9.53	3.18
JTGL3095F	L	0.95	0.037	0.0012	●	●			●	0.075	9.53	3.18
JTGR3095F-010	R	0.95	0.037	0.004	●					0.075	9.53	3.18
JTGL3095F-010	L	0.95	0.037	0.004	●					0.075	9.53	3.18
JTGR3100F	R	1	0.039	0.002	●	●	●		●	0.083	9.53	3.18
JTGL3100F	L	1	0.039	0.002	●	●			●	0.083	9.53	3.18
JTGR3100F-010	R	1	0.039	0.004	●					0.083	9.53	3.18
JTGL3100F-010	L	1	0.039	0.004	●					0.083	9.53	3.18
JTGR3110F	R	1.1	0.043	0.002	●	●				0.083	9.53	3.18
JTGR3120F	R	1.2	0.047	0.002	●	●				0.083	9.53	3.18
JTGR3120F-010	R	1.2	0.047	0.004	●					0.083	9.53	3.18
JTGR3125F	R	1.25	0.049	0.002	●	●	●		●	0.083	9.53	3.18
JTGL3125F	L	1.25	0.049	0.002	●	●			●	0.083	9.53	3.18
JTGR3125F-010	R	1.25	0.049	0.004	●					0.083	9.53	3.18
JTGL3125F-010	L	1.25	0.049	0.004	●					0.083	9.53	3.18
JTGR3130F	R	1.3	0.051	0.002	●	●				0.083	9.53	3.18
JTGR3140F	R	1.4	0.055	0.002	●	●				0.083	9.53	3.18
JTGR3140F-010	R	1.4	0.055	0.004	●					0.083	9.53	3.18
JTGR3145F	R	1.45	0.057	0.002	●	●	●		●	0.083	9.53	3.18
JTGL3145F	L	1.45	0.057	0.002	●	●			●	0.083	9.53	3.18
JTGR3145F-010	R	1.45	0.057	0.004	●					0.083	9.53	3.18
JTGR3150F	R	1.5	0.059	0.002	●	●	●		●	0.083	9.53	3.18
JTGL3150F	L	1.5	0.059	0.002	●	●			●	0.083	9.53	3.18
JTGR3150F-010	R	1.5	0.059	0.004	●					0.083	9.53	3.18
JTGL3150F-010	L	1.5	0.059	0.004	●					0.083	9.53	3.18

● : Line up

Reference pages: Toolholders → **F107**, Standard cutting conditions → **F110**

JTG (Sharp edge)

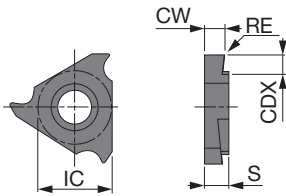

Right hand (R) shown.

P	Steel	★	★		★		☆		
M	Stainless	★	★						
K	Cast iron				☆		★		
N	Non-ferrous						★		
S	Superalloys						★		
H	Hard materials								

★ : First choice
☆ : Second choice

Designation	HAND	CW ₀ ^{+0.05} (mm)	CW ₀ ^{+0.002} (in)	RE (in)	Coated		Cermet	Uncoated		CDX (in)	IC (mm)	S (mm)
					SH725	J740	NS9530	TH10				
JTGR3175F	R	1.75	0.069	0.002	●	●	●	●		0.083	9.53	3.18
JTGL3175F	L	1.75	0.069	0.002		●	●	●		0.083	9.53	3.18
JTGR3175F-010	R	1.75	0.069	0.004	●					0.083	9.53	3.18
JTGR3180F	R	1.8	0.071	0.002	●	●				0.083	9.53	3.18
JTGR3200F	R	2	0.079	0.002	●	●	●	●		0.102	9.53	3.18
JTGL3200F	L	2	0.079	0.002	●	●		●		0.102	9.53	3.18
JTGR3200F-010	R	2	0.079	0.004	●					0.102	9.53	3.18
JTGL3200F-010	L	2	0.079	0.004	●					0.102	9.53	3.18
JTGR3225F	R	2.25	0.089	0.002	●	●				0.102	9.53	3.18
JTGR3250F	R	2.5	0.098	0.002	●	●	●	●		0.102	9.53	3.18
JTGL3250F	L	2.5	0.098	0.002	●	●		●		0.102	9.53	3.18
JTGR3250F-010	R	2.5	0.098	0.004	●					0.102	9.53	3.18
JTGL3250F-010	L	2.5	0.098	0.004	●					0.102	9.53	3.18
JTGR3275F	R	2.75	0.108	0.002		●				0.102	9.53	3.18
JTGR3300F	R	3	0.118	0.002	●	●				0.102	9.53	3.18
JTGR3300F-010	R	3	0.118	0.004	●					0.102	9.53	3.18

● : Line up

JTG (honed edge)

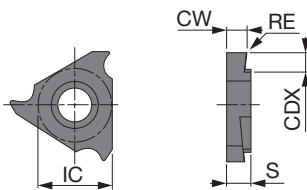

Right hand (R) shown.

P	Steel	★							
M	Stainless								
K	Cast iron	☆							
N	Non-ferrous								
S	Superalloys								
H	Hard materials								

★ : First choice
☆ : Second choice

Designation	HAND	CW ₀ ^{+0.05} (mm)	CW ₀ ^{+0.002} (in)	RE (in)	Coated cermet		CDX (in)	IC (mm)	S (mm)
					J9530				
JTGR3100	R	1	0.039	0.002	●		0.083	9.53	3.18
JTGR3125	R	1.25	0.049	0.002	●		0.083	9.53	3.18
JTGR3150	R	1.5	0.059	0.002	●		0.083	9.53	3.18
JTGR3200	R	2	0.079	0.002	●		0.102	9.53	3.18

● : Line up

Reference pages: Toolholders → **F107**, Standard cutting conditions → **F110**



STANDARD CUTTING CONDITIONS (J-Series grooving tool)

ISO	Workpiece material	Grade	Cutting speed Vc (sfm)	Feed f (ipr)
P	General steel, Free-cutting steel, etc.	J740	33 - 328	0.0004 - 0.004
		SH725	164 - 492	0.0004 - 0.004
		NS9530	164 - 492	0.0004 - 0.004
		J9530	164 - 492	0.0004 - 0.004
M	Stainless steel, etc.	J740	33 - 328	0.0004 - 0.004
		SH725	164 - 492	0.0004 - 0.004
N	Aluminum alloys, Brass, etc.	TH10	33 - 656	0.0004 - 0.004
S	Difficult-to-cut materials, Titanium alloys, etc.	TH10	33 - 98	0.0004 - 0.004

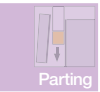
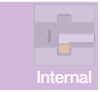
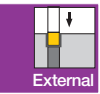

MY-T SERIES

CGWSR/L-FLR/L#GP

External grooving and turning toolholder

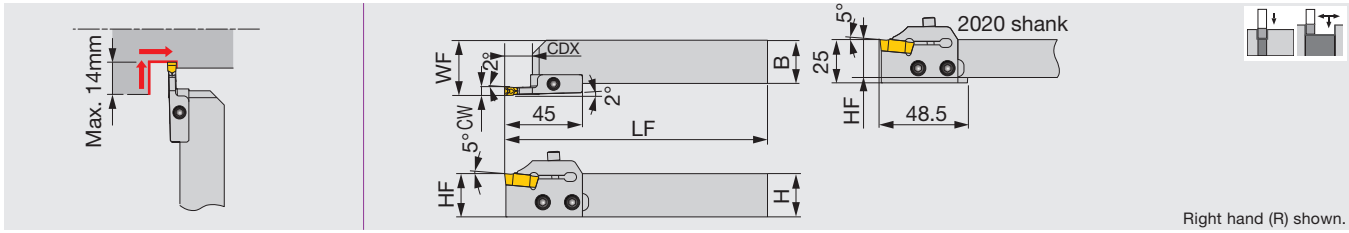

Right hand (R) shown.

Metric	CW	CDX	H	B	LF	HF	WF	Insert	Shank	Blade	Torque
CGWSR/L2020-FLR/L3GP	3	10	20	20	152	20	27	FLEX30R/L	CGWSR/L2020	FLR/L3GP	5
CGWSR/L2525-FLR/L3GP	3	10	25	25	152	25	32	FLEX30R/L	CGWSR/L2525	FLR/L3GP	5
CGWSR/L2020-FLR/L4GP	4	12	20	20	152	20	27	FLEX40R/L	CGWSR/L2020	FLR/L4GP	5
CGWSR/L2525-FLR/L4GP	4	12	25	25	152	25	32	FLEX40R/L	CGWSR/L2525	FLR/L4GP	5
CGWSR/L2020-FLR/L5GP	5	14	20	20	152	20	27	FLEX50R/L	CGWSR/L2020	FLR/L5GP	5
CGWSR/L2525-FLR/L5GP	5	14	25	25	152	25	32	FLEX50R/L	CGWSR/L2525	FLR/L5GP	5

Toolholders are in stock with the designations of: a set of shank and blade; a shank; a blade. Combining the designations of a blade and a shank will make the designation of a set. Please check the stock and place an order with the designation of a set or a shank+a blade.

Use right-hand toolholders (CGWSR...) with right-hand blade (FLR...); and left-hand toolholders (CGWSL...) with left-hand blade (FLL...).

Torque: Recommended clamping torque: N·m

SPARE PARTS

Designation	Clamping screw	Blade screw	Wrench
CGWSR/L***-FLR/L#GP	CHHM5-18	CSHB-6	P-4

Caution

- Flex-Tool has a mechanism in which the end cutting edge angle is formed by accepting a cutting force. In external grooving, there is a possibility that if the cutting conditions (feed and depth of cut) are set too high, the programmed diameter will not be achieved. To prevent this problem, it is necessary to perform a compensation in the program by an amount that is equal to the amount A'-A that is shown in the drawing on the right. The values of compensation corresponding to the feeds are also shown in the graph.

The length of blade for 5 mm width is shortened 2 mm compared from the old type blade. Please notice and read the instruction manual packaged in the box.

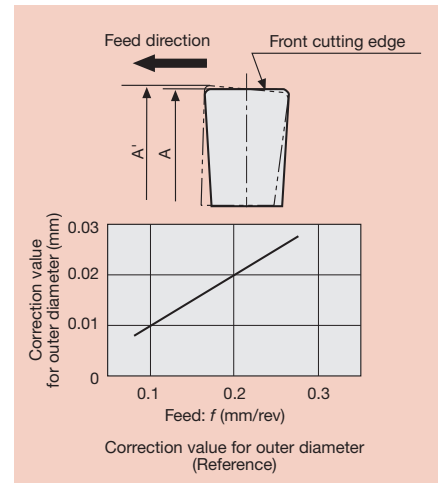

INSERT

FLEX(R/L)

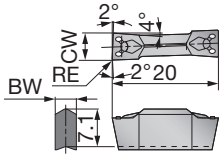

Right hand (R) shown.

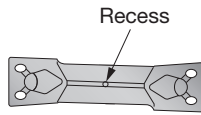

To distinguish the insert hands, the V-shape surface (top surface) of a left-hand insert has a recess. (not of a right-hand insert)

P	Steel	★	☆			★			★		
M	Stainless	★							★		
K	Cast iron	☆				☆					
N	Non-ferrous										
S	Superalloys										
H	Hard materials										

★ : First choice
☆ : Second choice

Designation	HAND	CW±0.002 (in)	CW±0.05 (mm)	RE (mm)	Coated		Carbide	Uncoated		BW (mm)
					T9225	T9125	NS9530	UX30		
FLEX30R	R	0.118	3	0.4			●			2.2
FLEX30L	L	0.118	3	0.4			●			2.2
FLEX40R	R	0.157	4	0.4			●			3.1
FLEX40L	L	0.157	4	0.4			●			3.1
FLEX50R	R	0.197	5	0.4	●	▲	●	●		4
FLEX50L	L	0.197	5	0.4	●	▲	●	●		4

● : Line up
▲ : To be discontinued

STANDARD CUTTING CONDITIONS

ISO	Workpiece material	Grade	Cutting speed Vc (sfm)	Feed: f (ipr)	
				Grooving	Turning
P	Carbon steel	T9225	262 - 984	0.002 - 0.010	0.004 - 0.012
		NS9530	262 - 656	0.002 - 0.010	0.004 - 0.012
		UX30	197 - 492	0.002 - 0.010	0.004 - 0.012

CTWR/L

External grooving and parting toolholder, for 2 corner inserts

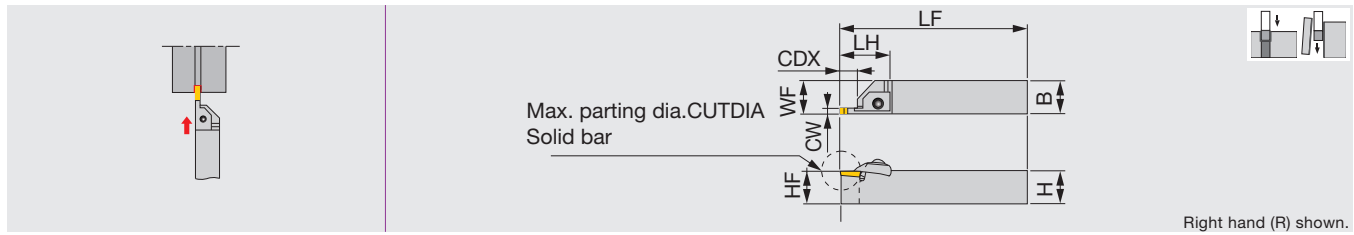

Metric	CW	CUTDIA	CDX	H	B	LF	LH	HF	WF	Insert	Torque
CTWR/L2020-3	3	32	14	20	20	150	41	20	20.25	CTD3	5
CTWR/L2525-3	3	32	14	25	25	150	41	25	25.25	CTD3	5
CTWR/L2020-4	4	32	14	20	20	150	41	20	20.25	CTD4	5
CTWR/L2525-4	4	32	14	25	25	150	41	25	25.25	CTD4	5
CTWR/L2525-5	5	42	20	25	25	150	46	25	25.25	CTD5	5

Torque: Recommended clamping torque: N·m

SPARE PARTS	Clamp	Pin	Clamping screw	Washer	Wrench
CTWR2020-3	CTC-3R	BP-360	CTS-M6	CDW6	P-4
CTWL2020-3	CTC-3L	BP-360	CTS-M6	CDW6	P-4
CTWR2525-3	CTC-3R	BP-360	CTS-M6	CDW6	P-4
CTWL2525-3	CTC-3L	BP-360	CTS-M6	CDW6	P-4
CTWR2020-4	CTC-4R	BP-360	CTS-M6	CDW6	P-4
CTWL2020-4	CTC-4L	BP-360	CTS-M6	CDW6	P-4
CTWR2525-4	CTC-4R	BP-360	CTS-M6	CDW6	P-4
CTWL2525-4	CTC-4L	BP-360	CTS-M6	CDW6	P-4
CTWR2525-5	CTC-5R	BP-360	CTS-M6	CDW6	P-4
CTWL2525-5	CTC-5L	BP-360	CTS-M6	CDW6	P-4

INSERT

CTD

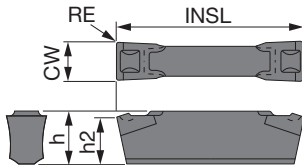

P Steel	★							
M Stainless	★							
K Cast iron	☆							
N Non-ferrous								
S Superalloys								
H Hard materials								

★ : First choice
☆ : Second choice

Designation	CW±0.004 (in)	CW±0.1 (mm)	RE (mm)	Coated						INSL (mm)	h (mm)	h2 (mm)
				AH725								
CTD3	0.118	3	0.2	●						20	4.3	4
CTD4	0.157	4	0.2	●						20	5.3	5
CTD5	0.197	5	0.2	●						25	6.3	6

● : Line up

STANDARD CUTTING CONDITIONS

ISO	Workpiece material	Grade	Cutting speed Vc (sfm)	Feed: f (ipr)	
				Grooving	Parting off
P	Carbon steel	AH725	262 - 591	0.003 - 0.012	0.003 - 0.006
M	Stainless steel	AH725	164 - 394	0.003 - 0.010	0.003 - 0.004



MY-T SERIES

CGWSR/L-CGD

External grooving and parting toolholder

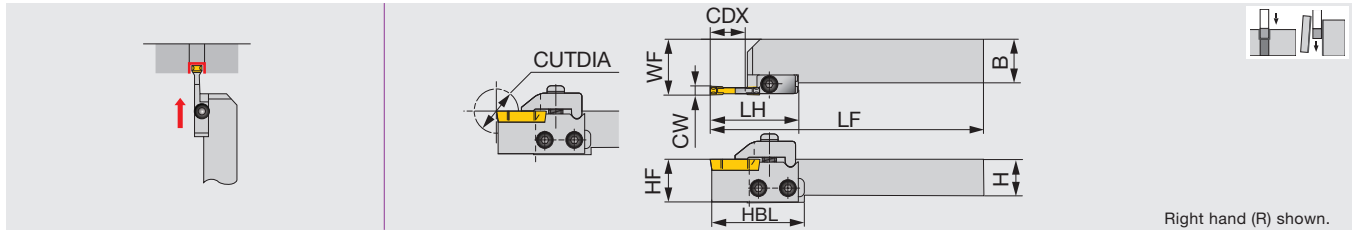

Metric	CW	CUTDIA	CDX	H	B	LF	LH	HBL	HF	WF	Insert	Shank	Blade	Torque
CGWSR/L2020-CGDR/L2	2	35	16	20	20	152	45	48.5	20	26.45	CGD200	CGWSR/L2020	CGDR/L2	5
CGWSR/L2525-CGDR/L2	2	35	16	25	25	152	45	-	25	31.45	CGD200	CGWSR/L2525	CGDR/L2	5
CGWSR/L2020-CGDR/L3	3	46	21.6	20	20	157.6	50.6	54.1	20	26.45	CGD300	CGWSR/L2020	CGDR/L3	5
CGWSR/L2525-CGDR/L3	3	46	21.6	25	25	157.6	50.6	-	25	31.45	CGD300	CGWSR/L2525	CGDR/L3	5
CGWSR/L2020-CGDR/L4	4	46	21.6	20	20	157.6	50.6	54.1	20	26.65	CGD400	CGWSR/L2020	CGDR/L4	5
CGWSR/L2525-CGDR/L4	4	46	21.6	25	25	157.6	50.6	-	25	31.65	CGD400	CGWSR/L2525	CGDR/L4	5
CGWSR/L2020-CGDR/L5	5	46	21.6	20	20	157.6	50.6	54.1	20	26.95	CGD500	CGWSR/L2020	CGDR/L5	5
CGWSR/L2525-CGDR/L5	5	46	21.6	25	25	157.6	50.6	-	25	31.95	CGD500	CGWSR/L2525	CGDR/L5	5
CGWSR/L2020-CGDR/L6	6	46	21.6	20	20	157.6	50.6	54.1	20	27.1	CGD600	CGWSR/L2020	CGDR/L6	5
CGWSR/L2525-CGDR/L6	6	46	21.6	25	25	157.6	50.6	-	25	32.1	CGD600	CGWSR/L2525	CGDR/L6	5
CGWSR2525-8	7 / 8	50	21.6	25	25	150	-	-	25	26.35	CGD700, CGD800	-	-	8.5
CGWSR3232-8	7 / 8	50	21.6	32	32	170	-	-	32	33.35	CGD700, CGD800	-	-	8.5

When using a right or left hand blade set, the right hand blade set is used with right hand shank and the left hand blade set is used with left hand shank.
Torque: Recommended clamping torque: N·m

SPARE PARTS

Designation	Blade	Clamp	Clamping screw	Blade screw	Spring pin	Spring	Wrench
CGWSR****-CGDR2	TCR2	CCR2	RT-1	C SHB-6	-	BP-9	P-4
CGWSL****-CGDL2	TCL2	CCL2	RT-1	C SHB-6	-	BP-9	P-4
CGWSR****-CGDR3	TCR3	CCR3	RT-1	C SHB-6	-	BP-9	P-4
CGWSL****-CGDL3	TCL3	CCL3	RT-1	C SHB-6	-	BP-9	P-4
CGWSR****-CGDR4	TCR4	CCR4	RT-1	C SHB-6	-	BP-9	P-4
CGWSL****-CGDL4	TCL4	CCL4	RT-1	C SHB-6	-	BP-9	P-4
CGWSR****-CGDR5	TCR5	CCR5	RT-1	C SHB-6	-	BP-9	P-4
CGWSL****-CGDL5	TCL5	CCL5	RT-1	C SHB-6	-	BP-9	P-4
CGWSR****-CGDR6	TCR6	CCR6	RT-1	C SHB-6	-	BP-9	P-4
CGWSL****-CGDL6	TCL6	CCL6	RT-1	C SHB-6	-	BP-9	P-4
CGWSR****-8	-	CCR/L-8	CHHM6-20	-	5X14AW	BP-9	P-5

Reference pages: Inserts, Standard cutting conditions → **F115**

INSERT

CGD

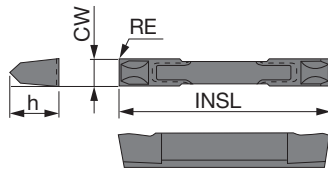

P	Steel	★	☆	★		★		
M	Stainless	★	★			★		
K	Cast iron	★		☆				
N	Non-ferrous							
S	Superalloys	☆						
H	Hard materials							

★ : First choice
☆ : Second choice

Designation	CW±0.001 (in)	CW±0.025 (mm)	RE (mm)	Coated		Cermet	Uncoated		INSL (in)	h (in)
				AH120 GH330		NS9530		UX30		
CGD200	0.079	2	0.2	●		●		●	0.787	0.128
CGD300	0.118	3	0.2	●	●	●		●	1.126	0.248
CGD400	0.157	4	0.2	●	●	●		●	1.126	0.248
CGD500	0.197	5	0.2	●	●	●		●	1.126	0.248
CGD600	0.236	6	0.2		●	●		●	1.126	0.335
CGD700	0.276	7	0.2		●			●	1.126	0.335
CGD800	0.315	8	0.2		●			●	1.126	0.335

● : Line up

STANDARD CUTTING CONDITIONS

ISO	Workpiece material	Grade	Cutting speed Vc (sfm)	Feed: f (ipr)	
				Grooving	Parting off
P	Carbon steel	GH330	230 - 591	0.003 - 0.012	0.003 - 0.006
		NS9530	262 - 656	0.003 - 0.012	0.003 - 0.006
		UX30	197 - 492	0.003 - 0.012	0.003 - 0.006

Grade
Insert
Toolholder
Ext. Toolholder
Int. Toolholder
Threading
Grooving
Miniature Tool
Endmill
Drilling Tool
Tooling System
Index



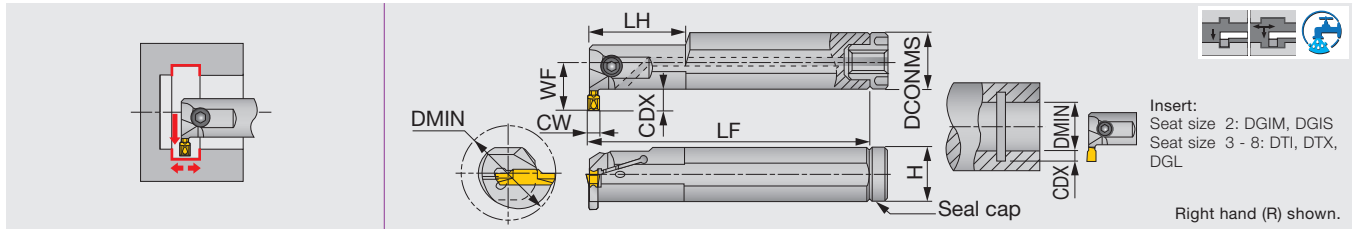

Inch	CW (in)	CW (mm)	DMIN	Seat size	CDX	DCONMS	H	LF ⁽¹⁾	LH	WF	Insert	Torque
CTIR/L12-3T06-D16	0.118	3	1.000	3	0.236	0.750	0.551	6.500	1.575	0.609	DTI..., DTX...	3.69
CTIR/L16-3T05-D16	0.118	3	1.000	3	0.201	1.000	0.709	8.000	1.575	0.689	DTI..., DTX...	3.69
CTIR/L16-3T08-D20	0.118	3	1.250	3	0.315	1.000	0.709	8.000	1.575	0.846	DTI..., DTX...	3.69
CTIR/L20-3T10-D25	0.118	3	1.563	3	0.394	1.250	0.906	10.000	2.362	1.063	DTI..., DTX...	3.69
CTIR/L12-4T06-D16	0.157	4	1.000	4	0.236	0.750	0.906	6.500	1.575	0.609	DTI..., DTX...	3.69
CTIR/L16-4T08-D20	0.157	4	1.250	4	0.315	1.000	1.181	8.000	1.575	0.846	DTI..., DTX...	3.69
CTIR/L20-4T04-D20	0.157	4	1.250	4	0.157	1.250	0.709	10.000	2.362	0.819	DTI..., DTX...	3.69
CTIR/L20-4T10-D25	0.157	4	1.563	4	0.394	1.250	0.906	10.000	2.362	1.063	DTI..., DTX...	3.69
CTIR/L16-5T05-D20	0.197	5	1.250	5	0.197	1.000	1.181	8.000	2.362	0.681	DTI..., DTX...	6.27
CTIR/L20-5T10-D25	0.197	5	1.563	5	0.394	1.250	1.181	10.000	2.362	1.063	DTI..., DTX...	6.27
CTIR/L20-6T04-D20	0.236	6	1.250	6	0.157	1.250	0.906	10.000	2.362	0.820	DTI..., DTX...	6.27
CTIR/L20-6T10-D25	0.236	6	1.563	6	0.394	1.250	1.181	10.000	2.362	1.063	DTI..., DTX...	6.27
CTIR/L20-8T05-D23	0.315	8	1.438	8	0.197	1.250	1.181	10.000	2.362	0.839	DTI..., DTX...	6.27
CTIR/L24-8T05-D26	0.315	8	1.625	8	0.228	1.500	1.181	12.000	2.559	0.982	DTI..., DTX...	6.27

(1) LF is calculated with the groove width CW in the above table.
Torque: Recommended clamping torque: lbs-ft

Inch SPARE PARTS



Designation	Clamping screw	Wrench	Seal cap	Thread type for connection
CTIR/L12-3T06-D16	CM5x0.8x12-A	P-4	CA-20	M6
CTIR/L16-3T05-D16	CM5x0.8x16-A	P-4	CA-25	R1/8"
CTIR/L16-3T08-D20	CM5x0.8x16-A	P-4	CA-25	R1/8"
CTIR/L20-3T10-D25	CM5x0.8x16-A	P-4	CA-32	R1/8"
CTIR/L12-4T06-D16	CM5x0.8x12-A	P-4	CA-20	M6
CTIR/L16-4T08-D20	CM5x0.8x16-A	P-4	CA-25	R1/8"
CTIR/L20-4T04-D20	CM5x0.8x16-A	P-4	CA-32	R1/8"
CTIR/L20-4T10-D25	CM5x0.8x16-A	P-4	CA-32	R1/8"
CTIR/L16-5T05-D20	CM6x1x16-A	P-5	CA-25	R1/8"
CTIR/L20-5T10-D25	CM6x1x20-A	P-5	CA-32	R1/8"
CTIR/L20-6T04-D20	CM6x1x20-A	P-5	CA-32	R1/8"
CTIR/L20-6T10-D25	CM6x1x20-A	P-5	CA-32	R1/8"
CTIR/L20-8T05-D23	CM6x1x20-A	P-5	CA-32	R1/8"
CTIR/L24-8T05-D26	CM6x1x25-A	P-5	CA-40	R1/8"

When using the inserts that are not in the above

Insert	Groove width CW (in)	Min. diameter DMIN (in)
DGM / DGS / SGN / DGL / DTM	0.118	1.969
DGM / DGS / SGN / DTM / DGL	0.157	1.969
DGM / DGS / DTM / DGL	0.197	2.362
DGM / DGS / DTM / DGL	0.236	2.362
DGM / DGS / DTM	0.315	2.756
DTE / DGG	0.118	1.575
DTE / DGG	0.157	1.575
DTE / DGG	0.197	1.969
DTE / DGG	0.236	1.969
DTE / DGG	0.315	2.441
DTR	0.118	1.496
DTR	0.157	1.496
DTR	0.197	1.693
DTR	0.236	1.811
DTR	0.315	2.205

Metric	CW	DMIN	Seat size	CDX	DCONMS	H	LF ⁽¹⁾	LH	WF	Insert	Torque
CTIR/L16-2T08-D250	2	25	2	8	16	14	125	-	16.5	DGIM..., DGIS...	5
CTIR/L20-2T06-D250	2	25	2	6	20	18	160	40	15.8	DGIM..., DGIS...	5
CTIR/L20-3T06-D250	3	25	3	6	20	18	160	40	15.8	DTI..., DTX...	5
CTIR/L25-3T05-D250	3	25	3	5.1	25	23	200	40	17.5	DTI..., DTX...	5
CTIR/L25-3T08-D320	3	32	3	8	25	23	200	40	21.5	DTI..., DTX...	5
CTIR/L32-3T10-D400	3	40	3	10	32	30	250	60	27	DTI..., DTX...	5
CTIR/L20-4T06-D250	4	25	4	6	20	18	160	40	15.8	DTI..., DTX...	5
CTIR/L25-4T08-D320	4	32	4	8	25	23	200	40	21.5	DTI..., DTX...	5
CTIR/L32-4T04-D310	4	31	4	4	32	30	250	60	20.8	DTI..., DTX...	5
CTIR/L32-4T10-D400	4	40	4	10	32	30	250	60	27	DTI..., DTX...	5
CTIR/L25-5T05-D310	5	31	5	5	25	23	200	60	17.3	DTI..., DTX...	8.5
CTIR/L32-5T10-D400	5	40	5	10	32	30	250	60	27	DTI..., DTX...	8.5
CTIR/L32-6T04-D310	6	31	6	4	32	30	250	60	20.8	DTI..., DTX...	8.5
CTIR/L32-6T10-D400	6	40	6	10	32	30	250	60	27	DTI..., DTX...	8.5
CTIR/L32-8T05-D370	8	37	8	5	32	30	250	60	21.3	DTI..., DTX...	8.5
CTIR/L40-8T05-D420	8	42	8	5.8	40	38	300	65	25.8	DTI..., DTX...	8.5

(1) LF is calculated with the groove width CW in the above table.
Torque: Recommended clamping torque: N·m

**Metric
SPARE PARTS**



Designation	Clamping screw	Wrench	Seal cap	Thread type for connection
CTIR/L16-2T08-D250	CM5X0.8X10-A	P-4	CA-16	M6
CTIR/L20-2T06-D250	CM5X0.8X12-A	P-4	CA-20	M6
CTIR/L20-3T06-D250	CM5X0.8X12-A	P-4	CA-20	M6
CTIR/L25-3T05-D250	CM5X0.8X16-A	P-4	CA-25	R1/8"
CTIR/L25-3T08-D320	CM5X0.8X16-A	P-4	CA-25	R1/8"
CTIR/L32-3T10-D400	CM5X0.8X16-A	P-4	CA-32	R1/8"
CTIR/L20-4T06-D250	CM5X0.8X12-A	P-4	CA-20	M6
CTIR/L25-4T08-D320	CM5X0.8X16-A	P-4	CA-25	R1/8"
CTIR/L32-4T04-D310	CM5X0.8X16-A	P-4	CA-32	R1/8"
CTIR/L32-4T10-D400	CM5X0.8X16-A	P-4	CA-32	R1/8"
CTIR/L25-5T05-D310	CM6X1X16-A	P-5	CA-25	R1/8"
CTIR/L32-5T10-D400	CM6X1X20-A	P-5	CA-32	R1/8"
CTIR/L32-6T04-D310	CM6X1X20-A	P-5	CA-32	R1/8"
CTIR/L32-6T10-D400	CM6X1X20-A	P-5	CA-32	R1/8"
CTIR/L32-8T05-D370	CM6X1X20-A	P-5	CA-32	R1/8"
CTIR/L40-8T05-D420	CM6X1X25-A	P-5	CA-40	R1/8"

When using the inserts that are not in the above

Insert	Groove width CW (mm)	Min. diameter DMIN (mm)
DGM / DGS / SGN / DGL / DTM	3	50
DGM / DGS / SGN / DTM / DGL	4	50
DGM / DGS / DTM / DGL	5	60
DGM / DGS / DTM / DGL	6	60
DGM / DGS / DTM	8	70
DTE / DGG	3	40
DTE / DGG	4	40
DTE / DGG	5	50
DTE / DGG	6	50
DTE / DGG	8	62
DTR	3	38
DTR	4	38
DTR	5	43
DTR	6	46
DTR	8	56

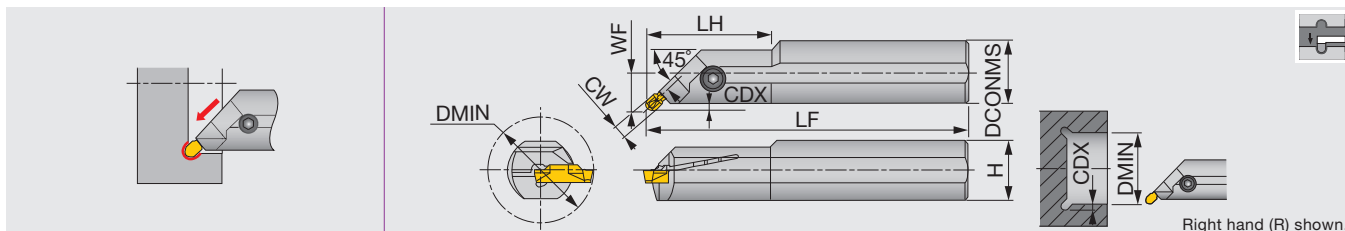

Metric	CW	DMIN	Seat size	CDX	DCONMS	H	LF	LH	WF ⁽¹⁾	Insert	Torque
CGIUR/L20-3T02-D380	3	38	3	2.8	20	19	160	-	12.8	DTIU...	5
CGIUR/L25-3T02-D380	3	38	3	2.8	25	23	200	40	14.8	DTIU...	5
CGIUR/L20-4T02-D380	4	38	4	2.8	20	19	160	-	12.9	DTIU...	5
CGIUR/L25-4T02-D460	4	46	4	2.8	25	23	200	40	14.9	DTIU...	5
CGIUR/L25-6T02-D460	6	46	5, 6	2.8	25	23	200	-	15.2	DTIU...	8.5

(1) WF is calculated with the groove width CW in the above table.
Torque: Recommended clamping torque: N·m

SPARE PARTS

Designation	Clamping screw	Wrench
CGIUR/L20-3T02-D380	CM5X0.8X12-A	P-4
CGIUR/L25-3T02-D380	CM5X0.8X16-A	P-4
CGIUR/L**-4T02-D...	CM5X0.8X16-A	P-4
CGIUR/L25-6T02-D460	CM6X1X25-A	P-5

TUNGCUT

CGIUR/L-15A

Round-shank toolholder for profiling aluminum wheel

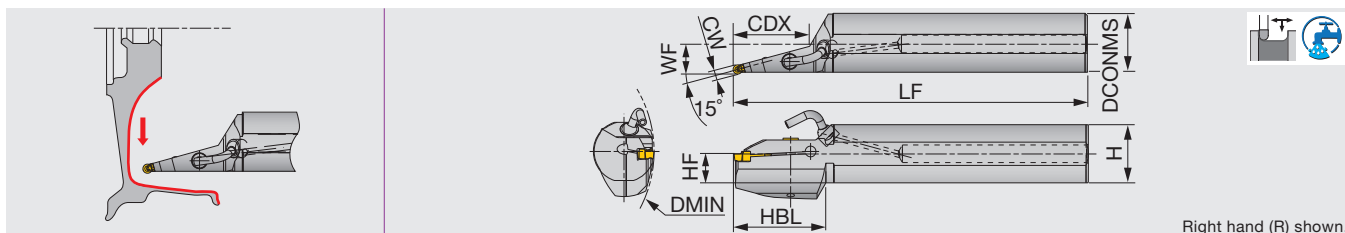

Metric	CW	DMIN	Seat size	CDX	DCONMS	H	WF	LF	HF	HBL	Insert	Seal cap	Torque
CGIUR/L40-6T50-D160-15A	6	160	6	50	40	38.5	19.7	320	19	60	DTA...	CA-40	5
CGIUR/L40-8T83-D160-15A	8	160	8	83	40	38.5	20.5	320	19	85	DTA...	CA-40	5
CGIUR/L50-6T85-D200-15A	6	200	6	85	50	48.5	25.2	350	23.5	85	DTA...	-	5
CGIUR/L50-8T85-D200-15A	8	200	8	85	50	48.5	25.9	350	23.5	85	DTA...	-	5

Torque: Recommended clamping torque: N·m

SPARE PARTS

Designation	Clamping screw	Wrench	Seal cap
CGIUR/L**-15A	CM6X1X25-A	P-5	CA-40

NOZZLE

Coolant pipe	Coolant nozzle
PNZ5	CNZ125

Reference pages: Inserts → **F119 - F130**, Standard cutting conditions → **F130**

INSERT

DTI

Internal grooving and turning (for high precision)

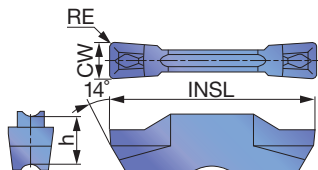

P	Steel	★	☆	★	☆	☆			★		
M	Stainless	★		★	☆	★					
K	Cast iron	☆		★		☆			☆		
N	Non-ferrous										
S	Superalloys			★	☆						
H	Hard materials										

★ : First choice
☆ : Second choice

Designation	Seat size	CW±0.02 (mm)	CW±0.0008 (in)	RE (in)	Coated					Cermet			INSL (in)	h (in)	
					T9225	T9125	AH7025	AH725	GH130	NS9530					
DTI300-040	3	3	0.118	0.016	●	▲	●	●	●		●			0.787	0.197
DTI400-040	4	4	0.157	0.016	●	▲	●	●	●		●			0.787	0.197
DTI400-080	4	4	0.157	0.031	●	▲	●	●	●		●			0.787	0.197
DTI500-040	5	5	0.197	0.016	●	▲	●	●	●		●			0.984	0.217
DTI500-080	5	5	0.197	0.031	●	▲	●	●	●		●			0.984	0.217
DTI600-080	6	6	0.236	0.031	●	▲	●	●	●					0.984	0.217
DTI600-120	6	6	0.236	0.047	●	▲	●	●	●					0.984	0.217
DTI800-080	8	8	0.315	0.031	●	▲	●	●	●					1.181	0.264
DTI800-120	8	8	0.315	0.047	●	▲	●	●	●					1.181	0.264

● : Line up
▲ : To be discontinued

DTI

Internal grooving and turning

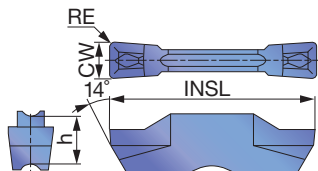

P	Steel	★	☆	★	☆	☆			★		
M	Stainless	★		★	☆	★					
K	Cast iron	☆		★		☆			☆		
N	Non-ferrous										
S	Superalloys			★	☆						
H	Hard materials										

★ : First choice
☆ : Second choice

Designation	Seat size	CW±0.02 (mm)	CW±0.001 (in)	RE (in)	Coated					Cermet			INSL (in)	h (in)	
					T9225	T9125	AH7025	AH725	GH130	NS9530					
DTI3-040	3	3	0.118	0.016	●	▲	●	●	●		●			0.787	0.197
DTI4-040	4	4	0.157	0.016	●	▲	●	●	●		●			0.787	0.197

● : Line up
▲ : To be discontinued



DTX

External/Internal face grooving and turning

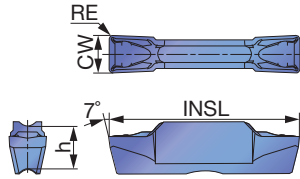

P	Steel	★	★	★	☆	☆		★				
M	Stainless	★		★	☆	★						
K	Cast iron	☆		★		☆		☆				
N	Non-ferrous											
S	Superalloys				★	☆						
H	Hard materials											

★ : First choice
☆ : Second choice

Designation	Seat size	CW±0.05 (mm)	CW±0.002 (in)	RE (in)	Coated					Cermet			INSL (in)	h (in)	
					T9225	T9125	AH7025	AH725	GH130	NS9530					
DTX3-030	3	3	0.118	0.012	●	▲	●	●	●		●			0.787	0.197
DTX4-040	4	4	0.157	0.016	●	▲	●	●	●		●			0.787	0.197
DTX5-040	5	5	0.197	0.016	●	▲	●	●	●		●			0.984	0.217
DTX6-080	6	6	0.236	0.031			●	●	●					0.984	0.197

● : Line up
▲ : To be discontinued

External

Internal

Face

Parting

Others

DTM

External face grooving and turning

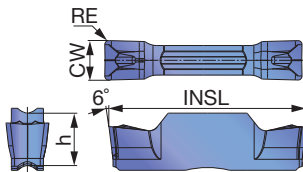

P	Steel	★										
M	Stainless	★										
K	Cast iron	★										
N	Non-ferrous											
S	Superalloys	★										
H	Hard materials											

★ : First choice
☆ : Second choice

Designation	Seat size	CW±0.05 (mm)	CW±0.002 (in)	RE (in)	Coated							INSL (in)	h (in)	
					AH7025									
DTM3-030	3	3	0.118	0.012	●								0.787	0.197
DTM4-040	4	4	0.157	0.016	●								0.787	0.197
DTM4-080	4	4	0.157	0.031	●								0.787	0.197
DTM5-080	5	5	0.197	0.031	●								0.984	0.217
DTM6-080	6	6	0.236	0.031	●								0.984	0.217
DTM8-080	8	8	0.315	0.031	●								1.181	0.264

● : Line up

Reference pages: Toolholders → **F116 - F118**, Standard cutting conditions → **F130**

DTE

External face grooving and turning (for high precision)

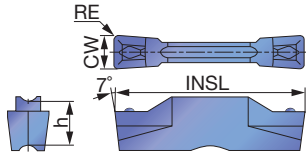

P	Steel	★	★	★	☆	☆			★				
M	Stainless	★		★	☆	★							
K	Cast iron	☆		★		☆							
N	Non-ferrous												
S	Superalloys				★	☆							
H	Hard materials												

★ : First choice
☆ : Second choice

Designation	Seat size	CW±0.02 (mm)	CW±0.0008 (in)	RE (in)	Coated					Cermets			INSL (in)	h (in)	
					T9225	T9125	AH7025	AH725	GH130	NS9530					
DTE265-015	3	2.65	0.104	0.006	●	▲	●	●	●		●			0.787	0.197
DTE300-020	3	3	0.118	0.008	●	▲	●	●	●		●			0.787	0.197
DTE300-040	3	3	0.118	0.016	●	▲	●	●	●		●			0.787	0.197
DTE315-015	3	3.15	0.124	0.006	●	▲	●	●	●		●			0.787	0.197
DTE400-040	4	4	0.157	0.016	●	▲	●	●	●		●			0.787	0.197
DTE400-080	4	4	0.157	0.031	●	▲	●	●	●		●			0.787	0.197
DTE415-015	4	4.15	0.163	0.006	●	▲	●	●	●		●			0.787	0.197
DTE478-055	5	4.78	0.188	0.022	●	▲	●	●	●		●			0.984	0.217
DTE500-040	5	5	0.197	0.016	●	▲	●	●	●		●			0.984	0.217
DTE500-080	5	5	0.197	0.031	●	▲	●	●	●		●			0.984	0.217
DTE515-015	5	5.15	0.203	0.006	●	▲	●	●	●					0.984	0.217
DTE600-080	6	6	0.236	0.031	●	▲	●	●	●					0.984	0.217
DTE600-120	6	6	0.236	0.047	●	▲	●	●	●					0.984	0.217
DTE800-080	8	8	0.315	0.031	●	▲	●	●	●					1.181	0.264
DTE800-120	8	8	0.315	0.047	●	▲	●	●	●					1.181	0.264

● : Line up
▲ : To be discontinued

DTE

External face grooving and turning

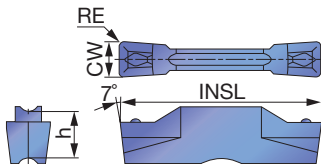

P	Steel	★	★		★	☆	☆			★			
M	Stainless	★			★	☆	★						
K	Cast iron	☆			★	★	☆						
N	Non-ferrous												
S	Superalloys						★	☆					
H	Hard materials												

★ : First choice
☆ : Second choice

Designation	Seat size	CW±0.05 (mm)	CW±0.002 (in)	RE (in)	Coated					Cermets			INSL (in)	h (in)	
					T9225	T9125	T515	AH7025	AH725	GH130	NS9530				
DTE3-040	3	3	0.118	0.016	●	▲	●	●	●	●		●		0.787	0.197
DTE4-040	4	4	0.157	0.016	●	▲	●	●	●	●		●		0.787	0.197
DTE5-040	5	5	0.197	0.016			●	●	●					0.984	0.217
DTE6-080	6	6	0.236	0.031			●	●						0.984	0.217

● : Line up
▲ : To be discontinued

Reference pages: Toolholders → **F116 - F118**, Standard cutting conditions → **F130**

Grade
Insert
Toolholder
Ext. Toolholder
Int. Toolholder
Threading
Grooving
Miniature Tool
Milling Cutter
Endmill
Drilling Tool
Tooling System
User's Guide
Index



DGIM

Small diameter internal grooving

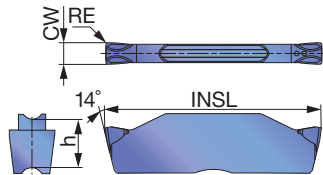

P	Steel	★	☆	★	☆	☆			★			
M	Stainless	★		★	☆	★						
K	Cast iron	☆		★		☆			☆			
N	Non-ferrous											
S	Superalloys				★	☆						
H	Hard materials											

★ : First choice
☆ : Second choice

Designation	Seat size	CW±0.05 (mm)	CW±0.002 (in)	RE (in)	Coated					Cermets			INSL (in)	h (in)	
					T9225	T9125	AH7025	AH725	GH130	NS9530					
DGIM2-020	2	2	0.079	0.008	●	▲	●	●	●		●			0.787	0.197

● : Line up
▲ : To be discontinued

External

Internal

DGIS

Small diameter internal grooving

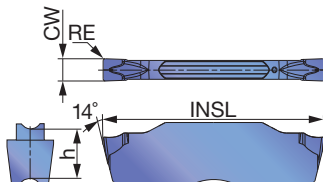

P	Steel	★	☆	★	☆	☆			★			
M	Stainless	★		★	☆	★						
K	Cast iron	☆		★		☆			☆			
N	Non-ferrous											
S	Superalloys				★	☆						
H	Hard materials											

★ : First choice
☆ : Second choice

Designation	Seat size	CW±0.05 (mm)	CW±0.002 (in)	RE (in)	Coated					Cermets			INSL (in)	h (in)	
					T9225	T9125	AH7025	AH725	GH130	NS9530					
DGIS2-020	2	2	0.079	0.008	●	▲	●	●	●		●			0.787	0.197

● : Line up
▲ : To be discontinued

Face

Parting

Others

DGM

External grooving and parting, 2 corners

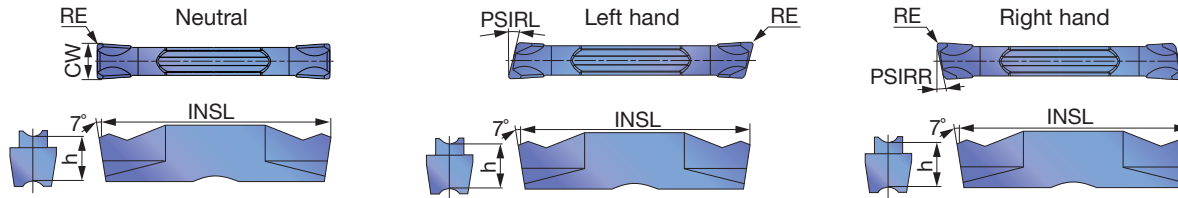

P	Steel	★	★	★	☆	☆	★					
M	Stainless	★		★	☆	★						
K	Cast iron	☆		★		☆	☆					
N	Non-ferrous											
S	Superalloys			★	☆	★						
H	Hard materials											

★ : First choice
☆ : Second choice

Designation	Seat size	HAND	CW±0.05 (mm)	CW±0.002 (in)	RE (in)	Coated						Cermets		INSL (in)	h (in)	PSIRL	PSIRR
						T9225	T9125	AH7025	AH725	AH905	GH130	NS9530					
DGM2-020	2	N	2	0.079	0.008	●	▲	●	●	●	●	●		0.787	0.197	0°	0°
DGM2-020-6R	2	R	2	0.079	0.008			●	●	●	●	●		0.780	0.197	0°	6°
DGM2-020-6L	2	L	2	0.079	0.008			●	●	●	●	●		0.780	0.197	6°	0°
DGM2-020-8R	2	R	2	0.079	0.008			●	●	●	●	●		0.780	0.197	0°	8°
DGM2-020-8L	2	L	2	0.079	0.008			●	●	●	●	●		0.780	0.197	8°	0°
DGM2-020-15R	2	R	2	0.079	0.008			●	●	●	●	●		0.780	0.197	0°	15°
DGM2-020-15L	2	L	2	0.079	0.008			●	●	●	●	●		0.780	0.197	15°	0°
DGM2-002-15R	2	R	2	0.079	0.0008			●	●	●	●	●		0.762	0.197	0°	15°
DGM2-002-15L	2	L	2	0.079	0.0008			●	●	●	●	●		0.762	0.197	15°	0°
DGM3-020	3	N	3	0.118	0.008	●	▲	●	●	●	●	●		0.787	0.197	0°	0°
DGM3-020-6R	3	R	3	0.118	0.008			●	●	●	●	●		0.783	0.197	0°	6°
DGM3-020-6L	3	L	3	0.118	0.008			●	●	●	●	●		0.783	0.197	6°	0°
DGM3-002-6R	3	R	3	0.118	0.0008			●	●	●	●	●		0.766	0.197	0°	6°
DGM3-002-6L	3	L	3	0.118	0.0008			●	●	●	●	●		0.766	0.197	6°	0°
DGM3-020-15R	3	R	3	0.118	0.008			●	●	●	●	●		0.783	0.197	0°	15°
DGM3-020-15L	3	L	3	0.118	0.008			●	●	●	●	●		0.783	0.197	15°	0°
DGM4-030	4	N	4	0.157	0.012	●	▲	●	●	●	●	●		0.787	0.197	0°	0°
DGM4-030-4R	4	R	4	0.157	0.012			●	●	●	●	●		0.780	0.197	0°	4°
DGM4-030-4L	4	L	4	0.157	0.012			●	●	●	●	●		0.780	0.197	4°	0°
DGM4-030-15R	4	R	4	0.157	0.012			●	●	●	●	●		0.780	0.197	0°	15°
DGM4-030-15L	4	L	4	0.157	0.012			●	●	●	●	●		0.780	0.197	15°	0°
DGM5-030	5	N	5	0.197	0.012	●	▲	●	●	●	●	●		0.984	0.217	0°	0°
DGM5-030-4R	5	R	5	0.197	0.012			●	●	●	●	●		0.980	0.217	0°	4°
DGM6-030	6	N	6	0.236	0.012	●	▲	●	●	●	●	●		0.984	0.217	0°	0°
DGM8-040	8	N	8	0.315	0.016	●	▲	●	●	●	●	●		1.181	0.264	0°	0°

● : Line up
▲ : To be discontinued

Grade
Insert
Toolholder
Ext. Toolholder
Int. Toolholder
Threading
Grooving
Miniature Tool
Milling Cutter
Endmill
Drilling Tool
Tooling System
User's Guide
Index



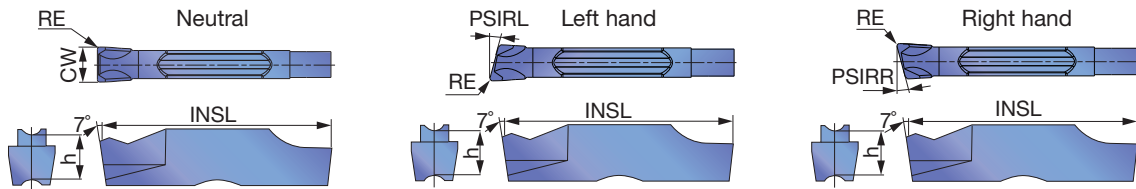

P	Steel	★	☆	☆									
M	Stainless	★	☆	★									
K	Cast iron	★		☆									
N	Non-ferrous												
S	Superalloys	★	☆										
H	Hard materials												

★ : First choice
☆ : Second choice

Designation	Seat size	HAND	CW±0.05 (mm)	CW±0.002 (in)	RE (in)	Coated						INSL (in)	h (in)	PSIRL	PSIRR	
						AH7025	AH725	GH130								
SGM2-020	2	N	2	0.079	0.008	●	●	●					0.787	0.197	0°	0°
SGM2-020-6R	2	R	2	0.079	0.008	●	●	●					0.787	0.197	0°	6°
SGM2-020-6L	2	L	2	0.079	0.008	●	●	●					0.787	0.197	6°	0°
SGM3-020	3	N	3	0.118	0.008	●	●	●					0.787	0.197	0°	0°
SGM3-020-6R	3	R	3	0.118	0.008	●	●	●					0.787	0.197	0°	6°
SGM3-020-6L	3	L	3	0.118	0.008	●	●	●					0.787	0.197	6°	0°
SGM3-020-15R	3	R	3	0.118	0.008	●	●	●					0.787	0.197	0°	15°
SGM3-020-15L	3	L	3	0.118	0.008	●	●	●					0.787	0.197	15°	0°
SGM4-030	4	N	4	0.157	0.012	●	●	●					0.787	0.197	0°	0°
SGM4-030-4R	4	R	4	0.157	0.012	●	●	●					0.787	0.197	0°	4°
SGM4-030-4L	4	L	4	0.157	0.012	●	●	●					0.787	0.197	4°	0°
SGM5-030	5	N	5	0.197	0.012	●	●	●					0.984	0.217	0°	0°
SGM6-030	6	N	6	0.236	0.012	●	●	●					0.984	0.217	0°	0°

● : Line up

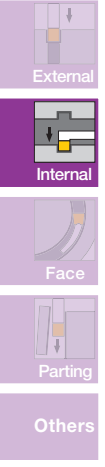

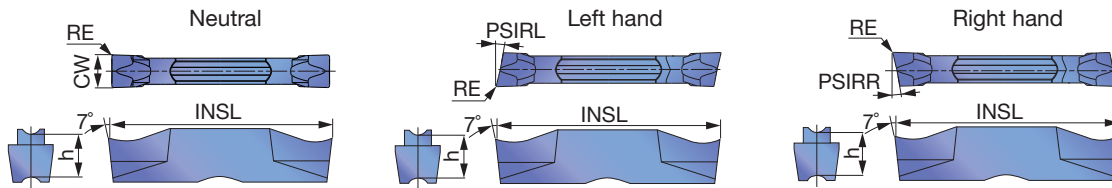

P	Steel	★	★	★	☆	☆				★			
M	Stainless	★		★	☆	★							
K	Cast iron	☆		★	☆					☆			
N	Non-ferrous												
S	Superalloys				★	☆							
H	Hard materials												

★ : First choice
☆ : Second choice

Designation	Seat size	HAND	CW±0.05 (mm)	CW±0.002 (in)	RE (in)	Coated					Cermet		INSL (in)	h (in)	PSIRL	PSIRR	
						T9225	T9125	AH7025	AH725	GH130	NS9530						
DGS1.4-016	1	N	1.4	0.055	0.006				●	●	●			0.630	0.169	0°	0°
DGS2-020	2	N	2	0.079	0.008	●	▲	●	●	●		●		0.787	0.197	0°	0°
DGS2-020-6R	2	R	2	0.079	0.008			●	●	●				0.785	0.197	0°	6°
DGS2-020-6L	2	L	2	0.079	0.008			●	●	●				0.785	0.197	6°	0°
DGS2-002-6R	2	R	2	0.079	0.0008			●	●	●				0.768	0.197	0°	6°
DGS2-002-6L	2	L	2	0.079	0.0008			●	●	●				0.768	0.197	6°	0°
DGS2-020-15R	2	R	2	0.079	0.008			●	●	●				0.785	0.197	0°	15°
DGS2-020-15L	2	L	2	0.079	0.008			●	●	●				0.785	0.197	15°	0°
DGS2-002-15R	2	R	2	0.079	0.0008			●	●	●				0.768	0.197	0°	15°
DGS2-002-15L	2	L	2	0.079	0.0008			●	●	●				0.768	0.197	15°	0°
DGS3-020	3	N	3	0.118	0.008	●	▲	●	●	●		●		0.787	0.197	0°	0°
DGS3-020-6R	3	R	3	0.118	0.008			●	●	●				0.783	0.197	0°	6°
DGS3-020-6L	3	L	3	0.118	0.008			●	●	●				0.783	0.197	6°	0°
DGS3-002-6R	3	R	3	0.118	0.0008			●	●	●				0.766	0.197	0°	6°
DGS3-002-6L	3	L	3	0.118	0.0008			●	●	●				0.766	0.197	6°	0°
DGS3-020-15R	3	R	3	0.118	0.008			●	●	●				0.783	0.197	0°	15°
DGS3-020-15L	3	L	3	0.118	0.008			●	●	●				0.783	0.197	15°	0°
DGS3-002-15R	3	R	3	0.118	0.0008			●	●	●				0.766	0.197	0°	15°
DGS3-002-15L	3	L	3	0.118	0.0008			●	●	●				0.766	0.197	15°	0°
DGS4-030	4	N	4	0.157	0.012	●	▲	●	●	●		●		0.787	0.197	0°	0°
DGS4-030-4R	4	R	4	0.157	0.012			●	●	●				0.780	0.197	0°	4°
DGS4-030-4L	4	L	4	0.157	0.012			●	●	●				0.781	0.197	4°	0°
DGS5-030	5	N	5	0.197	0.012	●	▲	●	●	●		●		0.984	0.217	0°	0°
DGS6-030	6	N	6	0.236	0.012	●	▲	●	●	●		●		0.984	0.217	0°	0°

● : Line up
▲ : To be discontinued

Caution

The tool will interfere with the workpiece when grooving larger diameter than øDmax.

Designation	øDmax (in)	Designation	øDmax (in)
DGM2-002-15R/L	1.102	DGS2-002-15R/L	1.102
DGM3-002-15R/L	1.141	DGS3-002-15R/L	1.141
DGM4-030-15R/L	1.181	SGS3-020-15R/L	4.055
SGM3-020-15R/L	4.055	SGS3-002-15R/L	1.338

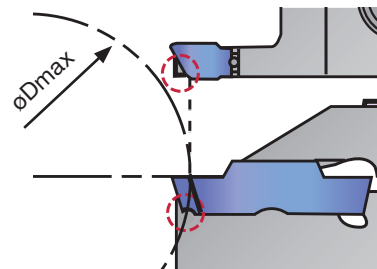

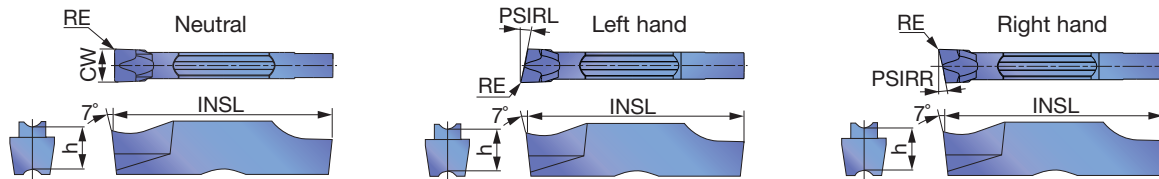

P	Steel	★	☆	☆									
M	Stainless	★	☆	★									
K	Cast iron	★		☆									
N	Non-ferrous												
S	Superalloys	★	☆										
H	Hard materials												

★ : First choice
☆ : Second choice

Designation	Seat size	HAND	CW±0.05 (mm)	CW±0.002 (in)	RE (in)	Coated						INSL (in)	h (in)	PSIRL	PSIRR	
						AH7025	AH725	GH130								
SGS2-020	2	N	2	0.079	0.008	●	●	●					0.787	0.197	0°	0°
SGS2-020-6R	2	R	2	0.079	0.008	●	●	●					0.787	0.197	0°	6°
SGS2-020-6L	2	L	2	0.079	0.008	●	●	●					0.787	0.197	6°	0°
SGS2-020-15R	2	R	2	0.079	0.008	●	●	●					0.787	0.197	0°	15°
SGS2-020-15L	2	L	2	0.079	0.008	●	●	●					0.787	0.197	15°	0°
SGS3-020	3	N	3	0.118	0.008	●	●	●					0.787	0.197	0°	0°
SGS3-020-6R	3	R	3	0.118	0.008	●	●	●					0.787	0.197	0°	6°
SGS3-020-6L	3	L	3	0.118	0.008	●	●	●					0.787	0.197	6°	0°
SGS3-002-6R	3	R	3	0.118	0.0008		●	●					0.780	0.197	0°	6°
SGS3-002-6L	3	L	3	0.118	0.0008		●	●					0.780	0.197	6°	0°
SGS3-020-15R	3	R	3	0.118	0.008	●	●	●					0.787	0.197	0°	15°
SGS3-020-15L	3	L	3	0.118	0.008	●	●	●					0.787	0.197	15°	0°
SGS3-002-15R	3	R	3	0.118	0.0008		●	●					0.780	0.197	0°	15°
SGS3-002-15L	3	L	3	0.118	0.0008		●	●					0.780	0.197	15°	0°
SGS4-030	4	N	4	0.157	0.012	●	●	●					0.787	0.197	0°	0°
SGS5-030	5	N	5	0.197	0.012	●	●	●					0.984	0.217	0°	0°
SGS6-030	6	N	6	0.236	0.012	●	●	●					0.984	0.217	0°	0°

● : Line up



DGG

External grooving (for high precision)

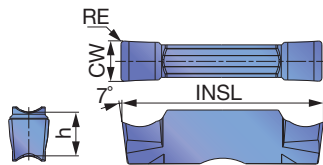

P	Steel	★		★							
M	Stainless	★									
K	Cast iron	★		☆			☆				
N	Non-ferrous							★			
S	Superalloys	★						☆			
H	Hard materials										

★ : First choice
☆ : Second choice

Designation	Seat size	CW±0.02 (mm)	CW±0.0008 (in)	RE (in)	Coated			Cermet			Uncoated			INSL (in)	h (in)
					AH7025			NS9530			KS05F				
DGG200-020	2	2	0.079	0.008	●			●			●			0.787	0.197
DGG300-020	3	3	0.118	0.008	●			●			●			0.787	0.197
DGG400-040	4	4	0.157	0.016	●			●			●			0.787	0.197
DGG500-040	5	5	0.197	0.016	●			●			●			0.984	0.217
DGG600-040	6	6	0.236	0.016	●			●			●			0.984	0.217

● : Line up

DGL

External grooving and parting

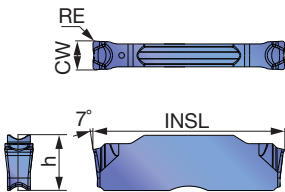

P	Steel	★										
M	Stainless	★										
K	Cast iron	★										
N	Non-ferrous											
S	Superalloys	★										
H	Hard materials											

★ : First choice
☆ : Second choice

Designation	Seat size	CW±0.05 (mm)	CW±0.002 (in)	RE (in)	Coated			Cermet			Uncoated			INSL (in)	h (in)
					AH7025										
DGL3-025	3	3	0.118	0.010	●									0.787	0.197
DGL4-030	4	4	0.157	0.012	●									0.787	0.197
DGL5-030	5	5	0.197	0.012	●									0.984	0.217
DGL6-080	6	6	0.236	0.031	●									0.984	0.217

● : Line up

Reference pages: Toolholders → **F116 - F118**, Standard cutting conditions → **F130**

Grade
Insert
Toolholder
Ext. Toolholder
Int. Toolholder
Threading
Grooving
Miniature Tool
Milling Cutter
Endmill
Drilling Tool
Tooling System
User's Guide
Index



DTR

Profiling and undercutting (for high precision)

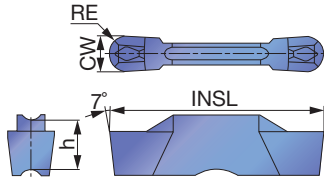

	P	M	K	N	S	H
Steel	★	★	★	☆	☆	★
Stainless	★	★	★	☆	★	
Cast iron	☆	★	★	☆	☆	★
Non-ferrous						
Superalloys			★	☆		
Hard materials						

★ : First choice
☆ : Second choice

Designation	Seat size	CW±0.02 (mm)	CW±0.001 (in)	RE (in)	Coated					Cermets			INSL (in)	h (in)	
					T9225	T9125	AH7025	AH725	AH130	NS9530					
DTR300-150	3	3	0.118	0.059	●	▲	●	●	●		●			0.787	0.197
DTR400-200	4	4	0.157	0.079	●	▲	●	●	●		●			0.787	0.197
DTR478-239	5	4.78	0.188	0.094	●	▲	●	●	●		●			0.984	0.217
DTR500-250	5	5	0.197	0.098	●	▲	●	●	●		●			0.984	0.217
DTR600-300	6	6	0.236	0.118	●	▲	●	●	●					0.984	0.217

● : Line up
▲ : To be discontinued

External

Internal

Face

Parting

Others

DTR

Profiling and undercutting

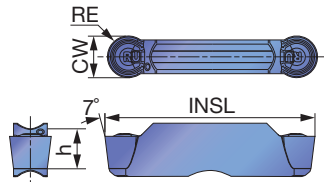

	P	M	K	N	S	H
Steel	★	★	★	☆	☆	★
Stainless	★	★	★	☆	★	
Cast iron	☆	★	★	☆	☆	★
Non-ferrous						
Superalloys			★	☆	★	
Hard materials						

★ : First choice
☆ : Second choice

Designation	Seat size	CW±0.05 (mm)	CW±0.002 (in)	RE (in)	Coated					Cermets			INSL (in)	h (in)	
					T9225	T9125	AH7025	AH725	AH905	AH130	NS9530				
DTR3-150	3	3	0.118	0.059	●	▲	●	●	●	●		●		0.787	0.197
DTR4-200	4	4	0.157	0.079	●	▲	●	●	●	●		●		0.787	0.197
DTR5-250	5	5	0.197	0.098	●	▲	●	●	●	●		●		0.984	0.217
DTR6-300	6	6	0.236	0.118	●	▲	●	●	●	●				0.984	0.217
DTR8-400	8	8	0.315	0.157	●	▲	●	●	●	●				1.181	0.264

● : Line up
▲ : To be discontinued

Reference pages: Toolholders → **F116 - F118**, Standard cutting conditions → **F130**

DTIU

Profiling and undercutting (for high precision)

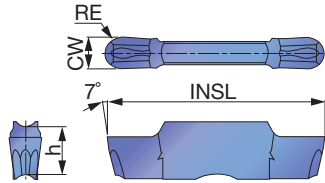

P	Steel	★	☆	☆						
M	Stainless	★	☆	★						
K	Cast iron	★		☆						
N	Non-ferrous									
S	Superalloys	★	☆							
H	Hard materials									

★ : First choice
☆ : Second choice

Designation	Seat size	CW±0.02 (mm)	CW±0.0008 (in)	RE (in)	Coated			INSL (in)	h (in)
					AH7025	AH725	GH130		
DTIU300-150	3	3	0.118	0.059	●	●	●	0.787	0.197
DTIU400-200	4	4	0.157	0.079	●	●	●	0.787	0.197
DTIU500-250	5	5	0.197	0.098	●	●	●	0.984	0.217
DTIU600-300	6	6	0.236	0.118	●	●	●	0.984	0.217

● : Line up

DTA

Aluminum wheel machining (for high precision)

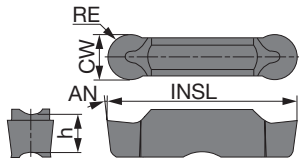

P	Steel									
M	Stainless									
K	Cast iron									
N	Non-ferrous	★								
S	Superalloys									
H	Hard materials									

★ : First choice
☆ : Second choice

Designation	Seat size	CW±0.02 (mm)	CW±0.0008 (in)	RE (in)	Uncoated			INSL (in)	h (in)	AN
					TH10					
DTA600-300	6	6	0.236	0.118	●			0.984	0.217	7°
DTA800-400	8	8	0.315	0.157	●			1.181	0.264	10°

● : Line up



External grooving of hardened steel

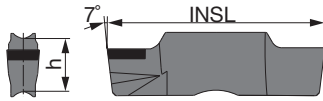
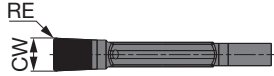

P	Steel								
M	Stainless								
K	Cast iron								
N	Non-ferrous								
S	Superalloys								
H	Hard materials	★							

★ : First choice
☆ : Second choice

Designation	Seat size	CW±0.025 (mm)	CW±0.001 (in)	RE (in)	CBN							INSL (in)	h (in)
					BX360								
SGN200-020	2	2	0.079	0.008	●							0.787	0.197
SGN300-020	3	3	0.118	0.008	●							0.787	0.197
SGN400-020	4	4	0.157	0.008	●							0.787	0.197





● : Line up

STANDARD CUTTING CONDITIONS



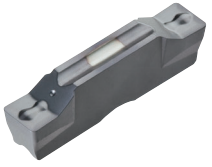

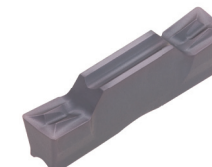

ISO	Workpiece material	Hardness	Priority	Grade	Cutting speed Vc (sfm)
P	Steel 1045, 4135, etc.	< 300 HB	First choice	AH7025, AH725	164 - 591
		< 300 HB	Priority for wear resistance	T9225	262 - 984
		< 300 HB	Priority for impact resistance	GH130	164 - 394
		< 300 HB	Priority for surface finish	NS9530	262 - 722
M	Stainless steel 304SS, 316SS, 17-4 PH, etc.	< 200 HB	First choice	AH7025, AH725	164 - 394
		< 200 HB	Priority for impact resistance	GH130	164 - 394
K	Gray cast iron No.250B, No.300B, etc.	-	First choice	T515, AH7025	164 - 591
		-	Priority for impact resistance	GH130	164 - 591
	Ductile cast iron 60-40-18, 60-55-06, etc.	-	First choice	T515, AH7025	164 - 394
		-	Priority for impact resistance	GH130	164 - 394
N	Aluminum alloys Si < 12%	-	First choice	TH10	328 - 1640
		-	First choice	KS05F	328 - 1969
S	Superalloys Inconel 718, etc.	< HRC 40	First choice	AH7025	66 - 197
		< HRC 40	Priority for wear resistance	AH905	66 - 262
	Titanium alloys Ti-6Al-4V, etc.	< HRC 40	First choice	AH905	66 - 262
		< HRC 40	Priority for impact resistance	AH7025, AH725	66 - 262
		< HRC 40	Priority for surface finish	KS05F	66 - 197
H	Hardened steel 4137, etc.	> HRC 50	First choice	BX360	262 - 492

*See page F131 - F134 for feed: f (ipr).

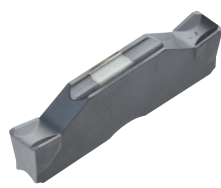
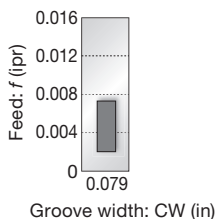

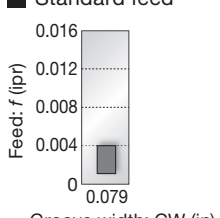

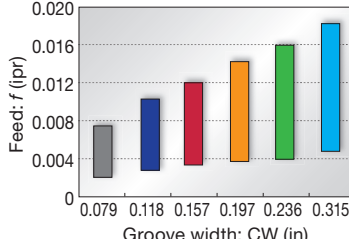
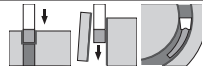
Internal grooving and turning

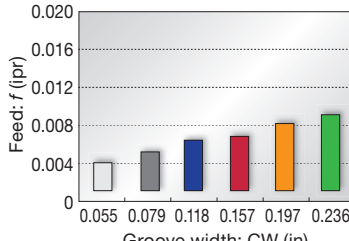
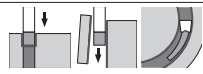
<p>DTI type (2 corners)</p> <p>First choice</p>  <p>F119 page</p>	<p>Internal</p> <p>Unique chipbreaker makes chips shorter Molded and ground inserts available CW = 0.118" - 0.315"</p> <div style="display: flex; justify-content: space-around;"> <div data-bbox="763 217 1104 538"> <p>■ Standard feed and DoC</p> </div> <div data-bbox="1120 217 1461 538"> <p>■ Standard feed</p> </div> </div>
<p>DTX type (2 corners)</p>  <p>F120 page</p>	<p>Multi-functional type</p> <p>Well balanced sharpness and strength Multi-functional insert CW = 0.118" - 0.236"</p> <div style="display: flex; justify-content: space-around;"> <div data-bbox="763 580 1104 901"> <p>■ Standard feed and DoC</p> </div> <div data-bbox="1120 580 1461 901"> <p>■ Standard feed</p> </div> </div>
<p>DTM type (2 corners)</p>  <p>F120 page</p>	<p>General purpose</p> <p>1st choice for grooving and turning Suitable for light to medium cutting Excellent chip control in machining steel, alloy steel, stainless steel, and heat-resistant alloy CW = 0.118" - 0.315"</p> <div style="display: flex; justify-content: space-around;"> <div data-bbox="763 953 1104 1274"> <p>■ Standard feed and DoC</p> </div> <div data-bbox="1120 953 1461 1274"> <p>■ Standard feed</p> </div> </div>
<p>DTE type (2 corners)</p>  <p>F121 page</p>	<p>General purpose</p> <p>Unique chipbreaker makes chips shorter Molded and ground inserts available CW = 0.118" - 0.315"</p> <div style="display: flex; justify-content: space-around;"> <div data-bbox="763 1367 1104 1688"> <p>■ Standard feed and DoC</p> </div> <div data-bbox="1120 1367 1461 1688"> <p>■ Standard feed</p> </div> </div>

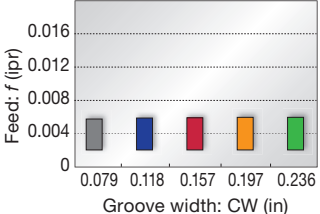
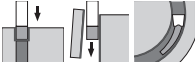

Small diameter internal grooving

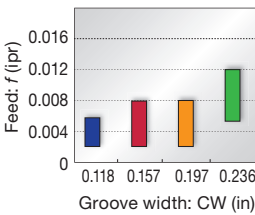
<p>DGIM type (2 corners)</p>  <p>F122 page</p>	<p>2 mm insert width only (For general purpose)</p> <p>Unique chipbreaker for excellent chip control Excellent fracture resistance due to optimum land on the cutting edge For general applications on steels & stainless steels CW = 0.079"</p>	<p>Standard feed</p>  
<p>DGIS type (2 corners)</p>  <p>F122 page</p>	<p>2 mm insert width only (Lower cutting force)</p> <p>Lower cutting force Excellent fracture resistance due to optimum land on the cutting edge Applicable for low carbon steels & stainless steels CW = 0.079"</p>	<p>Standard feed</p>  
<p>DGM type (2 corners) SGM type (1 corner)</p>  <p>F123, F124 page</p>	<p>1st choice for grooving and parting</p> <p>Smooth chip evacuation Well-designed edge with high strength Handed insert available CW = 0.079" - 0.315"</p>	<p>Standard feed</p>  
<p>DGS type (2 corners) SGS type (1 corner)</p>  <p>F125, F126 page</p>	<p>Lower cutting force and superior sharpness</p> <p>Unique-designed edge and chipbreaker Handed insert available CW = 0.055" - 0.236"</p>	<p>Standard feed</p>  

Small diameter internal grooving

<p>DGG type (2 corners)</p>  <p>F127 page</p>	<p>For non-ferrous materials and titanium</p> <p>Chipbreaker with low cutting force Sharp cutting edge that prevents vibration and delivers fine surface finish CW = 0.079" - 0.236"</p>	<p>Standard feed</p> 	
<p>DGL type (2 corners)</p>  <p>F128 page</p>	<p>1st choice for mild steel</p> <p>Chipbreaker with excellent chip control at low feed Suitable for mild steel that often has difficulties with chip control CW = 0.118" - 0.236"</p>	<p>Standard feed</p> 	

Profiling and undercutting

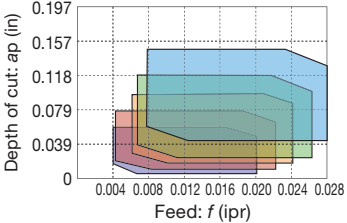
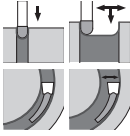
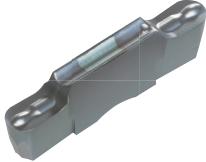
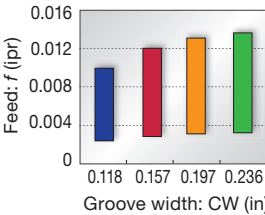
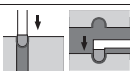
<p>DTR type (2 corners)</p> <p>Molded</p>  <p>Ground</p>  <p>F128 page</p>	<p>Full radius type</p> <p>Excellent chip control Molded and ground inserts available CW = 0.118" - 0.315"</p>	<p>Standard feed and DoC</p>  <p>Groove width: CW (in) ■ 0.118 ■ 0.157 ■ 0.197 ■ 0.236 ■ 0.315</p>	
<p>DTIU type (2 corners)</p>  <p>F129 page</p>	<p>Full radius type</p> <p>Excellent chip control For undercutting CW = 0.118" - 0.236"</p>	<p>Standard feed and DoC</p> 	

Aluminum wheel machining

DTA type (2 corners)

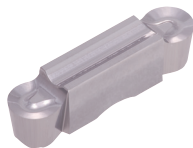

F129 page

Full radius type

Excellent chip control
For aluminum wheel profiling
Ground insert
CW = 0.236" - 0.315"

Standard feed and DoC

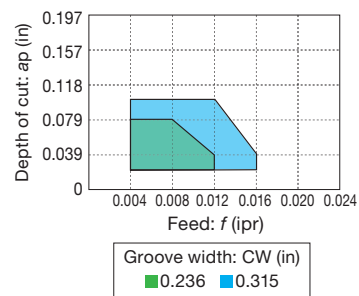

External grooving of hardened steel

SGN-CBN type (1 corner)

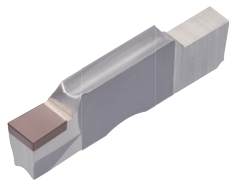

F130 page

For hardened steel cutting

Optimum cutting edge shape for grooving of hardened steels
High tolerance width for finishing
CW = 0.079" - 0.157"
(CW = ±0.001")

Standard feed

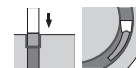
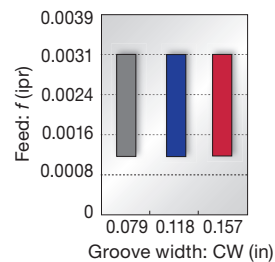

AH7025 Cutting performance

First choice grade for grooving

AH7025 grade: Tungaloy's unique coating technology for drastically improved reliability

Tool life comparison



Tool wear after 60 grooves

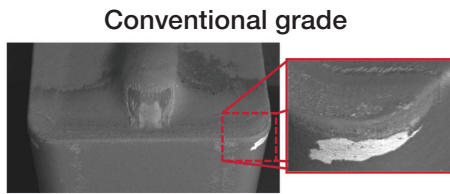

Tool wear after 30 grooves

P Alloy steel
(4140)

Insert : DTE3-040 AH7025
Cutting speed: $V_c = 492$ sfm
Feed : $f = 0.007$ ipr
Groove depth : 0.669"
Machining : External grooving
Coolant : Wet

AH7025 provides stability, while preventing coating from peeling off even after machining twice the number of passes compared to the conventional grade.

→ **The combination of Nano-multi-layered AlTiN Coating with high Al content and tough substrate provides highly efficient machining in various grooving operations.**

Grades

AH7025

P M K S

- First choice for various applications
- New PVD coating with high Al content provides excellent adhesion strength
- Improved wear and chipping resistance

AH725

P M S

- Recommended for various applications
- Newly developed coating with well controlled crystal structure and fracture resistance
- Improved adhesion strength

T515

K

- First recommended grade for cast iron
- Excellent wear resistance in high-speed machining

T9225

P

- Suitable for steel machining at high speeds
- New CVD coating and substrate deliver an outstanding balance of wear and chipping resistance

NS9530

P

- Advanced cermet for finish cutting of steel
- Innovative grade with incredible fracture and high wear resistance

GH130

P M K

- Recommended for interrupted machining
- TiCNO PVD coating layer with high wear resistance
- High hardness wear resistance

AH905

S

- Remarkable for machining of heat resistant alloys
- Exclusive coating layer improves adhesion strength and wear resistance

KS05F

N S

- Recommended for non-ferrous materials and titanium

TH10

N

- Recommended for non-ferrous materials

BX360

H

- Suitable for hardened steel machining
- Ideal balance of wear and chipping resistance due to the optimum CBN content and grain size



MY-T SERIES

CGTR/L

Internal grooving and turning toolholder

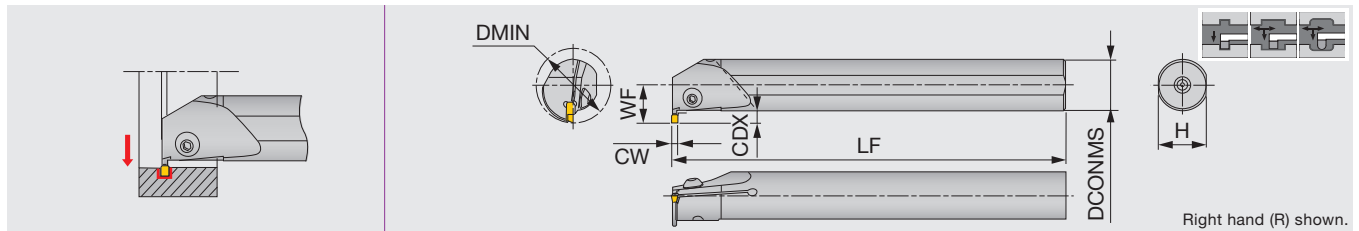

Inch	CW	DMIN	CDX	DCONMS	H	LF	WF	Insert	Torque
A12Q-CGTR30U	0.118	1.0	0.138	0.75	0.709	7.09	0.571	G*30, GE30-AL	2.21
A16R-CGTR/L30U	0.118	1.26	0.197	1.00	0.961	7.87	0.728	G*30, GE30-AL	2.21
A16R-CGTR40U	0.157	1.26	0.197	1.00	0.961	7.87	0.728	G*40, GE40-AL	2.21

Torque: Recommended clamping torque: lbs-ft

SPARE PARTS

Designation	Clamping screw	Wrench
A***-CGTR/L...	BHM5-14	P-3

External

Internal

Face

Parting

Others

Reference pages: Inserts → **F137 - F139**, Standard cutting conditions → **F142**

INSERT

GE

For general grooving

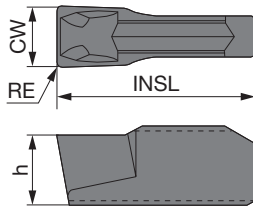

P	Steel	★	☆	★	★			★			
M	Stainless	★		★	★						
K	Cast iron	☆		★	☆			☆			
N	Non-ferrous										
S	Superalloys			☆							
H	Hard materials										

★ : First choice
☆ : Second choice

Designation	CW ^{+0.1} ₀ (mm)	CW ^{+0.004} ₀ (in)	RE (in)	Coated				Cermets		INSL (in)	h (in)	
				T9225	T9125	AH120	GH730	NS9530				
GE20	2	0.079	0.008			●	●		●		0.394	0.138
GE30	3	0.118	0.008	●	▲	●	●		●		0.394	0.138
GE40	4	0.157	0.008	●	▲	●	●		●		0.394	0.157
GE50	5	0.197	0.008	●	▲	●	●		●		0.472	0.177

● : Line up
▲ : To be discontinued

GT

For turning

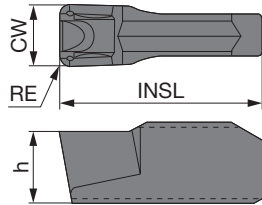

P	Steel	★	☆	★	★			★			
M	Stainless	★		★	★						
K	Cast iron	☆		★	☆			☆			
N	Non-ferrous										
S	Superalloys			☆							
H	Hard materials										

★ : First choice
☆ : Second choice

Designation	CW ^{+0.1} ₀ (mm)	CW ^{+0.004} ₀ (in)	RE (in)	Coated				Cermets		INSL (in)	h (in)	
				T9225	T9125	AH120	GH730	NS9530				
GT30	3	0.118	0.016			●	●		●		0.394	0.138
GT40	4	0.157	0.016			●	●		●		0.394	0.157
GT50	5	0.197	0.016	●	▲	●	●		●		0.472	0.177

● : Line up
▲ : To be discontinued



GR

For profiling (full radius)

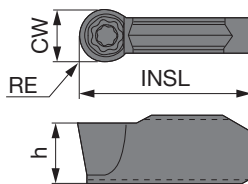

P	Steel	★	☆	★	★		★				
M	Stainless	★		★	★						
K	Cast iron	☆		★	☆		☆				
N	Non-ferrous										
S	Superalloys				☆						
H	Hard materials										

★ : First choice
☆ : Second choice

Designation	CW ^{+0.1} ₀ (mm)	CW ^{+0.004} ₀ (in)	RE (in)	Coated				Cermet				INSL (in)	h (in)		
				T9225	T9125	AH120	GH730	NS9530							
GR30	3	0.118	0.059			●	●			●				0.394	0.138
GR40	4	0.157	0.079	●	▲	●	●			●				0.394	0.157
GR50	5	0.197	0.098	●	▲	●	●			●				0.472	0.177

● : Line up
▲ : To be discontinued

GF

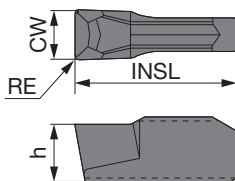

P	Steel	★			★						
M	Stainless	★									
K	Cast iron	☆			☆						
N	Non-ferrous										
S	Superalloys										
H	Hard materials										

★ : First choice
☆ : Second choice

Designation	CW ^{+0.1} ₀ (mm)	CW ^{+0.004} ₀ (in)	RE (in)	Coated		Cermet				INSL (in)	h (in)	
				GH730		NS9530						
GF30	3	0.118	0.008	●		●					0.394	0.138
GF40	4	0.157	0.008	●		●					0.394	0.157
GF50	5	0.197	0.008	●		●					0.472	0.177

● : Line up

Reference pages: Toolholders → **F136**, Standard cutting conditions → **F142**

GN

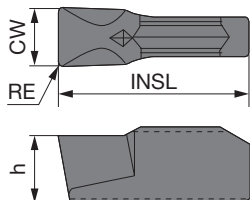

P	Steel	★					
M	Stainless	★					
K	Cast iron	☆					
N	Non-ferrous						
S	Superalloys						
H	Hard materials						

★ : First choice
☆ : Second choice

Designation	CW ^{+0.1} ₀ (mm)	CW ^{+0.004} ₀ (in)	RE (in)	Coated						INSL (in)	h (in)	
				GH730								
GN30	3	0.118	0.008	●							0.394	0.138
GN40	4	0.157	0.008	●							0.394	0.157
GN50	5	0.197	0.008	●							0.472	0.177

● : Line up

GE-AL

For aluminum and non-ferrous metal

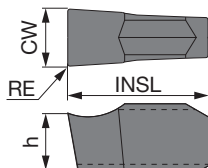

P	Steel						
M	Stainless						
K	Cast iron						
N	Non-ferrous	★					
S	Superalloys						
H	Hard materials						

★ : First choice
☆ : Second choice

Designation	CW ^{+0.1} ₀ (mm)	CW ^{+0.004} ₀ (in)	RE (in)	Uncoated						INSL (in)	h (in)	
				KS05F								
GE20-AL	2	0.079	0.008	●							0.394	0.138
GE30-AL	3	0.118	0.008	●							0.394	0.138
GE40-AL	4	0.157	0.008	●							0.394	0.157

● : Line up



1 corner insert

Internal grooving

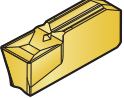
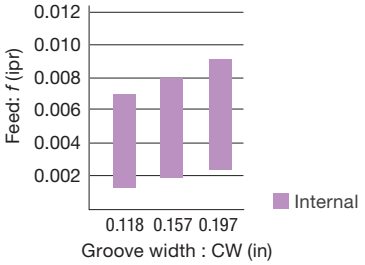
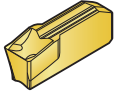
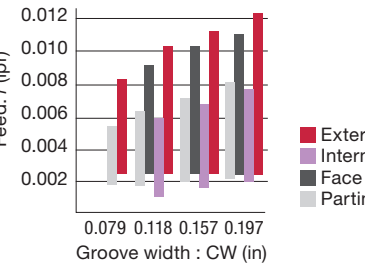
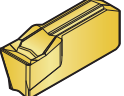
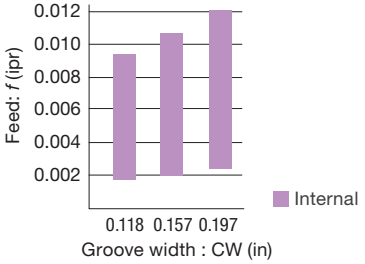
<p>GN</p>  <p>F139 page</p>	<p>1st choice for internal grooving Low cutting force and good chip control for internal grooving</p> <p>CW = 0.118" - 0.197"</p>	 <table border="1"> <caption>GN Feed Data</caption> <thead> <tr> <th>Groove width : CW (in)</th> <th>Feed: f (ipr)</th> </tr> </thead> <tbody> <tr> <td>0.118</td> <td>~0.007</td> </tr> <tr> <td>0.157</td> <td>~0.008</td> </tr> <tr> <td>0.197</td> <td>~0.009</td> </tr> </tbody> </table>	Groove width : CW (in)	Feed: f (ipr)	0.118	~0.007	0.157	~0.008	0.197	~0.009																	
Groove width : CW (in)	Feed: f (ipr)																										
0.118	~0.007																										
0.157	~0.008																										
0.197	~0.009																										
<p>GE</p>  <p>F137 page</p>	<p>1st choice for external grooving and parting Excellent chip control</p> <p>CW = 0.079" - 0.197"</p>	 <table border="1"> <caption>GE Feed Data</caption> <thead> <tr> <th>Groove width : CW (in)</th> <th>External</th> <th>Internal</th> <th>Face</th> <th>Parting</th> </tr> </thead> <tbody> <tr> <td>0.079</td> <td>~0.008</td> <td>~0.002</td> <td>~0.009</td> <td>~0.002</td> </tr> <tr> <td>0.118</td> <td>~0.010</td> <td>~0.002</td> <td>~0.011</td> <td>~0.002</td> </tr> <tr> <td>0.157</td> <td>~0.011</td> <td>~0.002</td> <td>~0.012</td> <td>~0.002</td> </tr> <tr> <td>0.197</td> <td>~0.012</td> <td>~0.002</td> <td>~0.013</td> <td>~0.002</td> </tr> </tbody> </table>	Groove width : CW (in)	External	Internal	Face	Parting	0.079	~0.008	~0.002	~0.009	~0.002	0.118	~0.010	~0.002	~0.011	~0.002	0.157	~0.011	~0.002	~0.012	~0.002	0.197	~0.012	~0.002	~0.013	~0.002
Groove width : CW (in)	External	Internal	Face	Parting																							
0.079	~0.008	~0.002	~0.009	~0.002																							
0.118	~0.010	~0.002	~0.011	~0.002																							
0.157	~0.011	~0.002	~0.012	~0.002																							
0.197	~0.012	~0.002	~0.013	~0.002																							
<p>GF</p>  <p>F138 page</p>	<p>1st choice for face grooving Low cutting force and good chip control for face grooving</p> <p>CW = 0.118" - 0.197"</p>	 <table border="1"> <caption>GF Feed Data</caption> <thead> <tr> <th>Groove width : CW (in)</th> <th>Feed: f (ipr)</th> </tr> </thead> <tbody> <tr> <td>0.118</td> <td>~0.009</td> </tr> <tr> <td>0.157</td> <td>~0.010</td> </tr> <tr> <td>0.197</td> <td>~0.011</td> </tr> </tbody> </table>	Groove width : CW (in)	Feed: f (ipr)	0.118	~0.009	0.157	~0.010	0.197	~0.011																	
Groove width : CW (in)	Feed: f (ipr)																										
0.118	~0.009																										
0.157	~0.010																										
0.197	~0.011																										

Grooving and turning

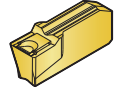
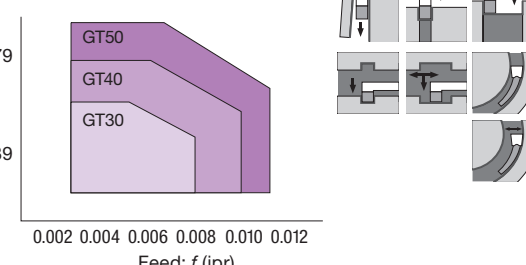
<p>GT</p>  <p>F137 page</p>	<p>1st choice for turning Low cutting force and good chip control for traversing</p> <p>CW = 0.118" - 0.197"</p>	 <table border="1"> <caption>GT Depth of Cut vs Feed</caption> <thead> <tr> <th>Feed: f (ipr)</th> <th>GT50 (ap)</th> <th>GT40 (ap)</th> <th>GT30 (ap)</th> </tr> </thead> <tbody> <tr> <td>0.002</td> <td>~0.050</td> <td>~0.040</td> <td>~0.030</td> </tr> <tr> <td>0.004</td> <td>~0.055</td> <td>~0.045</td> <td>~0.035</td> </tr> <tr> <td>0.006</td> <td>~0.060</td> <td>~0.050</td> <td>~0.040</td> </tr> <tr> <td>0.008</td> <td>~0.065</td> <td>~0.055</td> <td>~0.045</td> </tr> <tr> <td>0.010</td> <td>~0.070</td> <td>~0.060</td> <td>~0.050</td> </tr> <tr> <td>0.012</td> <td>~0.075</td> <td>~0.065</td> <td>~0.055</td> </tr> </tbody> </table>	Feed: f (ipr)	GT50 (ap)	GT40 (ap)	GT30 (ap)	0.002	~0.050	~0.040	~0.030	0.004	~0.055	~0.045	~0.035	0.006	~0.060	~0.050	~0.040	0.008	~0.065	~0.055	~0.045	0.010	~0.070	~0.060	~0.050	0.012	~0.075	~0.065	~0.055
Feed: f (ipr)	GT50 (ap)	GT40 (ap)	GT30 (ap)																											
0.002	~0.050	~0.040	~0.030																											
0.004	~0.055	~0.045	~0.035																											
0.006	~0.060	~0.050	~0.040																											
0.008	~0.065	~0.055	~0.045																											
0.010	~0.070	~0.060	~0.050																											
0.012	~0.075	~0.065	~0.055																											

1 corner insert

■ Profiling

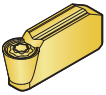
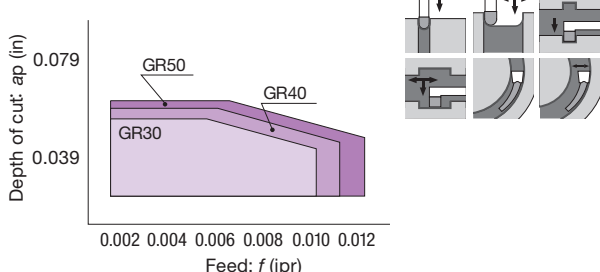
<p>GR</p>  <p>F138 page</p>	<p>Full radius type Low cutting force and good chip control for profiling CW = 0.118" - 0.197"</p>	
---	--	--

■ For aluminum and non-ferrous metal

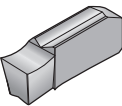
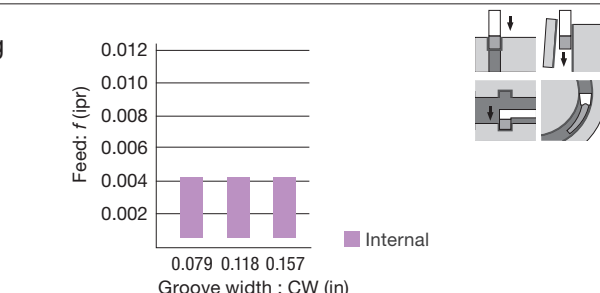
<p>GE-AL</p>  <p>F139 page</p>	<p>Reduce cutting force and welding due to sharp chipbreaker CW = 0.079" - 0.157"</p>	
--	---	---

Grade
 Insert
 Ext. Toolholder
 Int. Toolholder
 Threading
 Grooving
 Miniature Tool
 Milling Cutter
 Endmill
 Drilling Tool
 Tooling System
 User's Guide
 Index

A
B
C
D
E
F
G
H
I
J
K
L
M

STANDARD CUTTING CONDITIONS

ISO	Workpiece material	Grade	Cutting speed Vc (sfm)
P	Low carbon steel, Alloy steel (~ HB150)	T9225	262 - 984
		NS9530	328 - 656
		GH730	164 - 591
	Medium carbon steel, Alloy steel (HB150 ~ 250)	T9225	262 - 722
		NS9530	262 - 591
		GH730	164 - 492
High carbon steel, Alloy steel (HB250 ~)	T9225	262 - 722	
	NS9530	262 - 492	
	GH730	164 - 394	
M	Stainless steel	T9225	262 - 591
		GH730	164 - 394
K	Gray iron, Ductile cast iron	T9225	262 - 820
		GH730	164 - 591
N	Aluminum alloy, Non-ferrous metal	KS05F	656 - 984



External

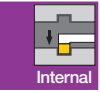

Internal



Face

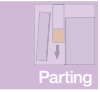

Parting



Others

Internal

Operation	Feed: f (ipr)		
	Groove width: CW (in)		
	3 mm (0.118")	4 mm (0.157")	5 mm (0.197")
Internal grooving (GE**)	0.0016 - 0.006	0.002 - 0.006	0.002 - 0.006
Internal grooving (GN**)	0.0016 - 0.006	0.002 - 0.007	0.002 - 0.008
Internal traversing (GT**)	$a_p = 0.020 - 0.059$ $f = 0.0024 - 0.008$	$a_p = 0.020 - 0.079$ $f = 0.0024 - 0.010$	$a_p = 0.020 - 0.098$ $f = 0.0024 - 0.011$
Internal traversing (GR**)	$a_p = 0.020 - 0.055$ $f = 0.002 - 0.010$	$a_p = 0.020 - 0.059$ $f = 0.002 - 0.010$	$a_p = 0.020 - 0.063$ $f = 0.002 - 0.012$
Aluminum alloys (GE**-AL)	0.0012 - 0.004	0.0012 - 0.004	-

For diameter compensation values in traversing, see page **F111**.

When vibration occurs in turning, please use the lower limit value in the above table.

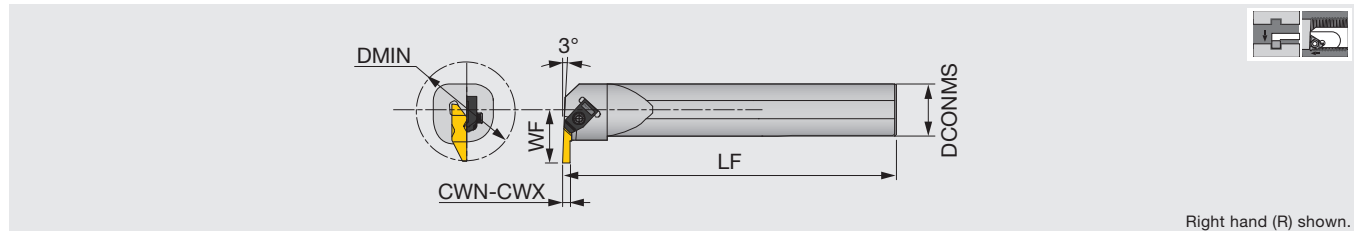

Inch	CWN	CWX	DMIN	DCONMS	LF	WF	Insert	Torque
A20-FLER/LT3	0.094	0.189	1.807	1.250	6.000	1.082	FLGT-3R/L...	2.21
A24-FLER/LT3	0.094	0.189	2.057	1.500	6.000	1.207	FLGT-3R/L...	2.21

Note: The right hand toolholders use right hand inserts, and the left hand toolholders use left hand inserts.
Torque: Recommended clamping torque: lbs-ft

SPARE PARTS

Designation	Clamp	Clamping screw	Wrench
A20-FLERT3, A24-FLERT3	TF-72	S-412	5/32HEX
A20-FLELT3, A24-FLELT3	TF-73	S-412	5/32HEX

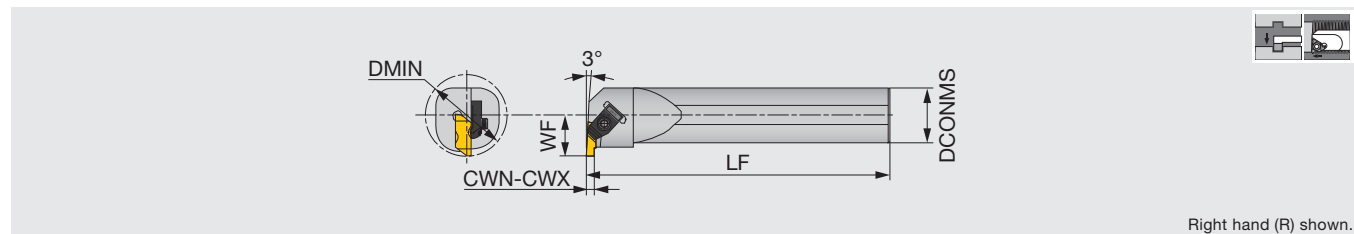

Inch	CWN	CWX	DMIN	DCONMS	LF	WF	Insert	Torque
A08-FLER/L2	0.031	0.125	0.730	0.500	8.000	0.437	FL*-2**/R...	2.21
A10-FLER2	0.031	0.125	1.000	0.625	10.000	0.500	FL*-2**/L...	2.21
A12-FLER/L2	0.031	0.128	1.125	0.750	10.000	0.562	FL*-2**/R...	2.21
A16-FLER/L2	0.031	0.128	1.375	1.000	12.000	0.688	FL*-2**/R...	2.21
A16-FLER/L3	0.031	0.250	1.375	1.000	12.000	0.688	FL*-3**/R...	2.21

Metric	CWN	CWX	DMIN	DCONMS	LF	WF	Insert	Torque*
A25M-FLER/L3	1	3	34.9	25	300	17.7	FL*-3**/R...	3
A32M-FLER/L3	1	3	44.45	32	350	22.1	FL*-3**/R...	3
A40M-FLER3	1	3	50.8	40	350	24.5	FL*-3**/L...	3

Note: Use right-hand toolholders (R) with left-hand inserts (L); and left-hand toolholders (L) with right-hand inserts (R).
Torque: Recommended clamping torque: lbs-ft (*N·m)

Inch SPARE PARTS

Designation	Clamp	Clamping screw	Wrench
A08-FLER2	TF-146	S-310	7/64HEX
A08-FLEL2	TF-147	S-310	7/64HEX
A10-FLER2, A12-FLER2, A16-FLER2	TF-75	S-310	7/64HEX
A12-FLEL2, A16-FLEL2	TF-74	S-310	7/64HEX
A16-FLER3	TF-73	S-412	5/32HEX
A16-FLEL3	TF-72	S-412	5/32HEX

Metric SPARE PARTS

Designation	Clamp	Clamping screw	Wrench
A**M-FLER3	TF-73	S-412	5/32HEX
A**M-FLEL3	TF-72	S-412	5/32HEX

TUNGT-CLAMP

HS-FLER/L

Internal grooving and threading head, for S-570 shank

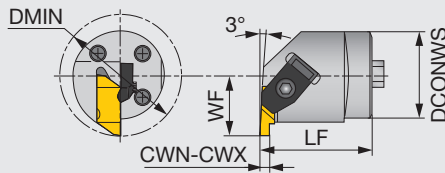

Right hand (R) shown.

Metric	CWN	CWX	DMIN	DCONWS	LF	WF	Insert	Torque
HS40-FLER3W	1	3	56.1	40	40.1	28	FL*-3**L...	3
HS50-FLER3W	1	3	70.1	50	41.9	35	FL*-3**L...	3

Note: Use right-hand toolholders (R) with left-hand inserts (L); and left-hand toolholders (L) with right-hand inserts (R).
Torque: Recommended clamping torque: N·m

SPARE PARTS



Designation	Clamp	Clamping screw	Wrench
HS40-FLER3W	TF-73	S-412	5/32HEX
HS50-FLER3W	TF-73	S-412	5/32HEX

TUNGT-CLAMP

S-570

Steel shank for head exchangeable tools

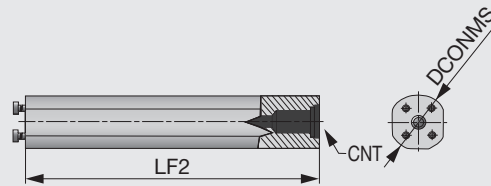

Metric	DCONMS	LF2	CNT
S-570-40M-40	40	273	1/2-14NPT
S-570-50M-50	50	366	1/2-14NPT

SPARE PARTS



Designation	Clamping screw	Wrench
S-570-40M-40	SS100	5/32HEX
S-570-50M-50	SS94	1/4HEX

STANDARD CUTTING CONDITIONS

ISO	Workpiece material	Grade	Application	Cutting speed Vc (sfm)	Feed f (ipr)
P	High carbon steel 1045, etc.	AH110	Grooving	328 - 656	0.005 - 0.014
		AH725	Threading	262 - 591	-
	Alloy steel 4137, etc.	AH110	Grooving	164 - 262	0.005 - 0.012
		AH725	Threading	197 - 525	-
M	Stainless steel S30400, etc.	AH110	Grooving	164 - 492	0.004 - 0.008
		AH725	Threading	164 - 427	-
K	Gray cast iron No.250B, etc.	AH110	Grooving	164 - 591	0.004 - 0.010
	Ductile cast iron 60-40-18, etc.	AH110	Grooving	164 - 394	0.004 - 0.010

Reference pages: Inserts → **F145 - F152**

INSERT

FLG-CB (With chipbreaker, metric width)

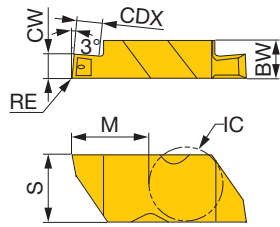

P	Steel	★						
M	Stainless	★						
K	Cast iron	★						
N	Non-ferrous							
S	Superalloys	☆						
H	Hard materials							

★ : First choice
☆ : Second choice

Designation	HAND	CW±0.025 (mm)	CW±0.001 (in)	RE (in)	Coated					CDX (in)	IC (in)	BW (in)	S (in)	M (in)
					AH110									
FLG-3M100R-CB	R	1	0.039	0.005 - 0.010	●					0.055	0.3750	0.195	0.344	0.4050
FLG-3M100L-CB	L	1	0.039	0.005 - 0.010	●					0.055	0.3750	0.195	0.344	0.4050
FLG-3M150R-CB	R	1.5	0.059	0.005 - 0.010	●					0.100	0.3750	0.195	0.344	0.4050
FLG-3M150L-CB	L	1.5	0.059	0.005 - 0.010	●					0.100	0.3750	0.195	0.344	0.4050
FLG-3M200R-CB	R	2	0.079	0.005 - 0.010	●					0.100	0.3750	0.195	0.344	0.4050
FLG-3M200L-CB	L	2	0.079	0.005 - 0.010	●					0.100	0.3750	0.195	0.344	0.4050
FLG-3M250R-CB	R	2.5	0.098	0.005 - 0.010	●					0.160	0.3750	0.195	0.344	0.4050
FLG-3M250L-CB	L	2.5	0.098	0.005 - 0.010	●					0.160	0.3750	0.195	0.344	0.4050
FLG-3M300R-CB	R	3	0.118	0.005 - 0.010	●					0.160	0.3750	0.195	0.344	0.4050
FLG-3M300L-CB	L	3	0.118	0.005 - 0.010	●					0.160	0.3750	0.195	0.344	0.4050

● : Line up



FLG-CB (With chipbreaker)

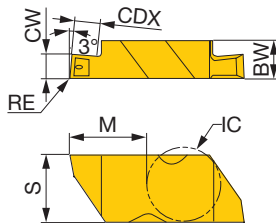

P	Steel	★							
M	Stainless	★							
K	Cast iron	★							
N	Non-ferrous								
S	Superalloys	☆							
H	Hard materials								

★ : First choice
☆ : Second choice

Designation	HAND	CW±0.025 (mm)	CW±0.001 (in)	RE (in)	Coated					CDX (in)	IC (in)	BW (in)	S (in)	M (in)
					AH110									
FLG-2047R-CB	R	1.2	0.047	0.002 - 0.005	●					0.050	0.1875	0.150	0.219	0.2700
FLG-2047L-CB	L	1.2	0.047	0.002 - 0.005	●					0.050	0.1875	0.150	0.219	0.2700
FLG-2062R-CB	R	1.57	0.062	0.005 - 0.010	●					0.110	0.1875	0.150	0.219	0.2700
FLG-2062L-CB	L	1.57	0.062	0.005 - 0.010	●					0.110	0.1875	0.150	0.219	0.2700
FLG-2078R-CB	R	1.98	0.078	0.005 - 0.010	●					0.110	0.1875	0.150	0.219	0.2700
FLG-2078L-CB	L	1.98	0.078	0.005 - 0.010	●					0.110	0.1875	0.150	0.219	0.2700
FLG-2094R-CB	R	2.39	0.094	0.005 - 0.010	●					0.110	0.1875	0.150	0.219	0.2700
FLG-2094L-CB	L	2.39	0.094	0.005 - 0.010	●					0.110	0.1875	0.150	0.219	0.2700
FLG-2125R-CB	R	3.18	0.125	0.005 - 0.010	●					0.110	0.1875	0.150	0.219	0.2700
FLG-2125L-CB	L	3.18	0.125	0.005 - 0.010	●					0.110	0.1875	0.150	0.219	0.2700
FLG-3031R-CB	R	0.79	0.031	0.002 - 0.005	●					0.050	0.3750	0.195	0.344	0.4050
FLG-3031L-CB	L	0.79	0.031	0.002 - 0.005	●					0.050	0.3750	0.195	0.344	0.4050
FLG-3047R-CB	R	1.19	0.047	0.005 - 0.010	●					0.075	0.3750	0.195	0.344	0.4050
FLG-3047L-CB	L	1.19	0.047	0.005 - 0.010	●					0.075	0.3750	0.195	0.344	0.4050
FLG-3062R-CB	R	1.57	0.062	0.005 - 0.010	●					0.120	0.3750	0.195	0.344	0.4050
FLG-3062L-CB	L	1.57	0.062	0.005 - 0.010	●					0.120	0.3750	0.195	0.344	0.4050
FLG-3072R-CB	R	1.83	0.072	0.005 - 0.010	●					0.120	0.3750	0.195	0.344	0.4050
FLG-3072L-CB	L	1.83	0.072	0.005 - 0.010	●					0.120	0.3750	0.195	0.344	0.4050
FLG-3078R-CB	R	1.98	0.078	0.005 - 0.010	●					0.120	0.3750	0.195	0.344	0.4050
FLG-3078L-CB	L	1.98	0.078	0.005 - 0.010	●					0.120	0.3750	0.195	0.344	0.4050
FLG-3088R-CB	R	2.24	0.088	0.005 - 0.010	●					0.180	0.3750	0.195	0.344	0.4050
FLG-3088L-CB	L	2.24	0.088	0.005 - 0.010	●					0.180	0.3750	0.195	0.344	0.4050
FLG-3094R-CB	R	2.39	0.094	0.005 - 0.010	●					0.180	0.3750	0.195	0.344	0.4050
FLG-3094L-CB	L	2.39	0.094	0.005 - 0.010	●					0.180	0.3750	0.195	0.344	0.4050
FLG-3097R-CB	R	2.46	0.097	0.005 - 0.010	●					0.180	0.3750	0.195	0.344	0.4050
FLG-3097L-CB	L	2.46	0.097	0.005 - 0.010	●					0.180	0.3750	0.195	0.344	0.4050
FLG-3125R-CB	R	3.18	0.125	0.005 - 0.010	●					0.180	0.3750	0.195	0.344	0.4050
FLG-3125L-CB	L	3.18	0.125	0.005 - 0.010	●					0.180	0.3750	0.195	0.344	0.4050
FLG-3189R-CB	R	4.8	0.189	0.020 - 0.025	●					0.180	0.3750	0.195	0.344	0.4050
FLG-3189L-CB	L	4.8	0.189	0.020 - 0.025	●					0.180	0.3750	0.195	0.344	0.4050

● : Line up

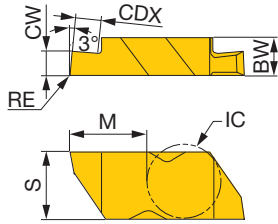

P	Steel	★				
M	Stainless	★				
K	Cast iron	★				
N	Non-ferrous					
S	Superalloys	☆				
H	Hard materials					

★ : First choice
☆ : Second choice

Designation	HAND	CW±0.025 (mm)	CW±0.001 (in)	RE (in)	Coated				CDX (in)	IC (in)	BW (in)	S (in)	M (in)
					AH110								
FLG-2031R	R	0.79	0.031	0.002 - 0.005	●				0.050	0.1875	0.150	0.219	0.2700
FLG-2031L	L	0.79	0.031	0.002 - 0.005	●				0.050	0.1875	0.150	0.219	0.2700
FLG-2041R	R	1.04	0.041	0.002 - 0.005	●				0.050	0.1875	0.150	0.219	0.2700
FLG-2041L	L	1.04	0.041	0.002 - 0.005	●				0.050	0.1875	0.150	0.219	0.2700
FLG-2047R	R	1.19	0.047	0.002 - 0.005	●				0.050	0.1875	0.150	0.219	0.2700
FLG-2047L	L	1.19	0.047	0.002 - 0.005	●				0.050	0.1875	0.150	0.219	0.2700
FLG-2058R	R	1.47	0.058	0.005 - 0.010	●				0.050	0.1875	0.150	0.219	0.2700
FLG-2058L	L	1.47	0.058	0.005 - 0.010	●				0.050	0.1875	0.150	0.219	0.2700
FLG-2062R	R	1.57	0.062	0.005 - 0.010	●				0.110	0.1875	0.150	0.219	0.2700
FLG-2062L	L	1.57	0.062	0.005 - 0.010	●				0.110	0.1875	0.150	0.219	0.2700
FLG-2094R	R	2.39	0.094	0.005 - 0.010	●				0.110	0.1875	0.150	0.219	0.2700
FLG-2094L	L	2.39	0.094	0.005 - 0.010	●				0.110	0.1875	0.150	0.219	0.2700
FLG-2125R	R	3.18	0.125	0.005 - 0.010	●				0.110	0.1875	0.150	0.219	0.2700
FLG-2125L	L	3.18	0.125	0.005 - 0.010	●				0.110	0.1875	0.150	0.219	0.2700
FLG-3031R	R	0.79	0.031	0.002 - 0.005	●				0.050	0.3750	0.195	0.344	0.4050
FLG-3031L	L	0.79	0.031	0.002 - 0.005	●				0.050	0.3750	0.195	0.344	0.4050
FLG-3047R	R	1.19	0.047	0.005 - 0.010	●				0.075	0.3750	0.195	0.344	0.4050
FLG-3047L	L	1.19	0.047	0.005 - 0.010	●				0.075	0.3750	0.195	0.344	0.4050
FLG-3062R	R	1.57	0.062	0.005 - 0.010	●				0.120	0.3750	0.195	0.344	0.4050
FLG-3062L	L	1.57	0.062	0.005 - 0.010	●				0.120	0.3750	0.195	0.344	0.4050
FLG-3072R	R	1.83	0.072	0.005 - 0.010	●				0.120	0.3750	0.195	0.344	0.4050
FLG-3072L	L	1.83	0.072	0.005 - 0.010	●				0.120	0.3750	0.195	0.344	0.4050
FLG-3078R	R	1.98	0.078	0.005 - 0.010	●				0.120	0.3750	0.195	0.344	0.4050
FLG-3078L	L	1.98	0.078	0.005 - 0.010	●				0.120	0.3750	0.195	0.344	0.4050
FLG-3088R	R	2.24	0.088	0.005 - 0.010	●				0.180	0.3750	0.195	0.344	0.4050
FLG-3088L	L	2.24	0.088	0.005 - 0.010	●				0.180	0.3750	0.195	0.344	0.4050
FLG-3094R	R	2.39	0.094	0.005 - 0.010	●				0.180	0.3750	0.195	0.344	0.4050
FLG-3094L	L	2.39	0.094	0.005 - 0.010	●				0.180	0.3750	0.195	0.344	0.4050
FLG-3097R	R	2.46	0.097	0.010 - 0.015	●				0.180	0.3750	0.195	0.344	0.4050
FLG-3097L	L	2.46	0.097	0.010 - 0.015	●				0.180	0.3750	0.195	0.344	0.4050
FLG-3105R	R	2.67	0.105	0.005 - 0.010	●				0.180	0.3750	0.195	0.344	0.4050
FLG-3105L	L	2.67	0.105	0.005 - 0.010	●				0.180	0.3750	0.195	0.344	0.4050
FLG-3110R	R	2.79	0.110	0.005 - 0.010	●				0.180	0.3750	0.195	0.344	0.4050
FLG-3110L	L	2.79	0.110	0.005 - 0.010	●				0.180	0.3750	0.195	0.344	0.4050
FLG-3122R	R	3.1	0.122	0.005 - 0.010	●				0.180	0.3750	0.195	0.344	0.4050
FLG-3122L	L	3.1	0.122	0.005 - 0.010	●				0.180	0.3750	0.195	0.344	0.4050
FLG-3125R	R	3.18	0.125	0.005 - 0.010	●				0.180	0.3750	0.195	0.344	0.4050
FLG-3125L	L	3.18	0.125	0.005 - 0.010	●				0.180	0.3750	0.195	0.344	0.4050
FLG-3142R	R	3.61	0.142	0.005 - 0.010	●				0.180	0.3750	0.195	0.344	0.4050
FLG-3142L	L	3.61	0.142	0.005 - 0.010	●				0.180	0.3750	0.195	0.344	0.4050
FLG-3156R	R	3.96	0.156	0.005 - 0.010	●				0.180	0.3750	0.195	0.344	0.4050
FLG-3156L	L	3.96	0.156	0.005 - 0.010	●				0.180	0.3750	0.195	0.344	0.4050
FLG-3178R	R	4.52	0.178	0.005 - 0.010	●				0.180	0.3750	0.195	0.344	0.4050
FLG-3178L	L	4.52	0.178	0.005 - 0.010	●				0.180	0.3750	0.195	0.344	0.4050
FLG-3185R	R	4.7	0.185	0.020 - 0.025	●				0.180	0.3750	0.195	0.344	0.4050
FLG-3185L	L	4.7	0.185	0.020 - 0.025	●				0.180	0.3750	0.195	0.344	0.4050
FLG-3189R	R	4.8	0.189	0.020 - 0.025	●				0.180	0.3750	0.195	0.344	0.4050
FLG-3189L	L	4.8	0.189	0.020 - 0.025	●				0.180	0.3750	0.195	0.344	0.4050
FLG-3250R	R	6.35	0.250	0.020 - 0.025	●				0.180	0.3750	0.250	0.344	0.4050
FLG-3250L	L	6.35	0.250	0.020 - 0.025	●				0.180	0.3750	0.250	0.344	0.4050

● : Line up

Reference pages: Toolholders → F143 - F144

Grade
Insert
Toolholder
Ext. Toolholder
Int. Toolholder
Threading
Grooving
Miniature Tool
Milling Cutter
Endmill
Drilling Tool
Tooling System
User's Guide
Index



FLGP (Positive rake)

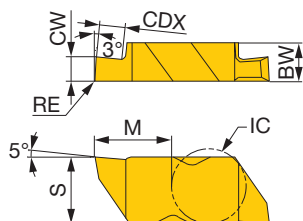

P	Steel	★				
M	Stainless	★				
K	Cast iron	★				
N	Non-ferrous					
S	Superalloys	☆				
H	Hard materials					

★ : First choice
☆ : Second choice

Designation	HAND	CW±0.025 (mm)	CW±0.001 (in)	RE (in)	Coated				CDX (in)	IC (in)	BW (in)	S (in)	M (in)
					AH110								
FLGP-2031R	R	0.79	0.031	0.002 - 0.005	●				0.050	0.1875	0.150	0.219	0.2700
FLGP-2031L	L	0.79	0.031	0.002 - 0.005	●				0.050	0.1875	0.150	0.219	0.2700
FLGP-2062R	R	1.57	0.062	0.005 - 0.010	●				0.110	0.1875	0.150	0.219	0.2700
FLGP-2062L	L	1.57	0.062	0.005 - 0.010	●				0.110	0.1875	0.150	0.219	0.2700
FLGP-2125R	R	3.18	0.125	0.005 - 0.010	●				0.110	0.1875	0.150	0.219	0.2700
FLGP-2125L	L	3.18	0.125	0.005 - 0.010	●				0.110	0.1875	0.150	0.219	0.2700
FLGP-3047R	R	1.19	0.047	0.005 - 0.010	●				0.075	0.3750	0.195	0.344	0.4050
FLGP-3047L	L	1.19	0.047	0.005 - 0.010	●				0.075	0.3750	0.195	0.344	0.4050
FLGP-3062R	R	1.57	0.062	0.005 - 0.010	●				0.120	0.3750	0.195	0.344	0.4050
FLGP-3062L	L	1.57	0.062	0.005 - 0.010	●				0.120	0.3750	0.195	0.344	0.4050
FLGP-3088R	R	2.24	0.088	0.005 - 0.010	●				0.180	0.3750	0.195	0.344	0.4050
FLGP-3088L	L	2.24	0.088	0.005 - 0.010	●				0.180	0.3750	0.195	0.344	0.4050
FLGP-3094R	R	2.39	0.094	0.005 - 0.010	●				0.180	0.3750	0.195	0.344	0.4050
FLGP-3094L	L	2.39	0.094	0.005 - 0.010	●				0.180	0.3750	0.195	0.344	0.4050
FLGP-3125R	R	3.18	0.125	0.005 - 0.010	●				0.180	0.3750	0.195	0.344	0.4050
FLGP-3125L	L	3.18	0.125	0.005 - 0.010	●				0.180	0.3750	0.195	0.344	0.4050
FLGP-3156R	R	3.96	0.156	0.005 - 0.010	●				0.180	0.3750	0.195	0.344	0.4050
FLGP-3156L	L	3.96	0.156	0.005 - 0.010	●				0.180	0.3750	0.195	0.344	0.4050
FLGP-3189R	R	4.8	0.189	0.020 - 0.025	●				0.180	0.3750	0.195	0.344	0.4050
FLGP-3189L	L	4.8	0.189	0.020 - 0.025	●				0.180	0.3750	0.195	0.344	0.4050

● : Line up

FLR-CB (Full nose radius, with chipbreaker)

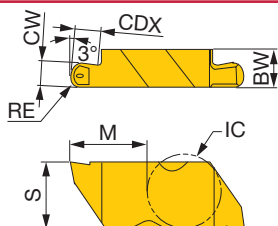

P	Steel	★				
M	Stainless	★				
K	Cast iron	★				
N	Non-ferrous					
S	Superalloys	☆				
H	Hard materials					

★ : First choice
☆ : Second choice

Designation	HAND	CW±0.025 (mm)	CW±0.001 (in)	RE (in)	Coated				CDX (in)	IC (in)	BW (in)	S (in)	M (in)
					AH110								
FLR-3031R-CB	R	1.57	0.062	0.031	●				0.125	0.3750	0.195	0.344	0.4033
FLR-3031L-CB	L	1.57	0.062	0.031	●				0.125	0.3750	0.195	0.344	0.4033
FLR-3047R-CB	R	2.39	0.094	0.047	●				0.180	0.3750	0.195	0.344	0.4025
FLR-3047L-CB	L	2.39	0.094	0.047	●				0.180	0.3750	0.195	0.344	0.4025
FLR-3062R-CB	R	3.18	0.125	0.062	●				0.180	0.3750	0.195	0.344	0.4017
FLR-3062L-CB	L	3.18	0.125	0.062	●				0.180	0.3750	0.195	0.344	0.4017

● : Line up

Reference pages: Toolholders → **F143 - F144**

FLR (Full nose radius)

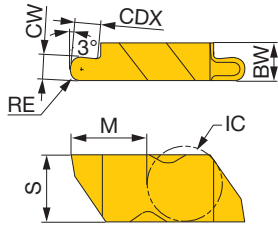

P	Steel	★				
M	Stainless	★				
K	Cast iron	★				
N	Non-ferrous					
S	Superalloys	☆				
H	Hard materials					

★ : First choice
☆ : Second choice

Designation	HAND	CW±0.025 (mm)	CW±0.001 (in)	RE (in)	Coated				CDX (in)	IC (in)	BW (in)	S (in)	M (in)
					AH110								
FLR-2031R	R	1.57	0.062	0.031	●				0.110	0.1875	0.150	0.219	0.2683
FLR-2031L	L	1.57	0.062	0.031	●				0.110	0.1875	0.150	0.219	0.2683
FLR-2047R	R	2.39	0.094	0.047	●				0.110	0.1875	0.150	0.219	0.2675
FLR-2047L	L	2.39	0.094	0.047	●				0.110	0.1875	0.150	0.219	0.2675
FLR-2062R	R	3.18	0.125	0.062	●				0.110	0.1875	0.150	0.219	0.2667
FLR-2062L	L	3.18	0.125	0.062	●				0.110	0.1875	0.150	0.219	0.2667
FLR-3031R	R	1.57	0.062	0.031	●				0.125	0.3750	0.195	0.344	0.4033
FLR-3031L	L	1.57	0.062	0.031	●				0.125	0.3750	0.195	0.344	0.4033
FLR-3047R	R	2.39	0.094	0.047	●				0.180	0.3750	0.195	0.344	0.4025
FLR-3047L	L	2.39	0.094	0.047	●				0.180	0.3750	0.195	0.344	0.4025
FLR-3062R	R	3.18	0.125	0.062	●				0.180	0.3750	0.195	0.344	0.4017
FLR-3062L	L	3.18	0.125	0.062	●				0.180	0.3750	0.195	0.344	0.4017
FLR-3078R	R	3.96	0.156	0.078	●				0.180	0.3750	0.195	0.344	0.4008
FLR-3078L	L	3.96	0.156	0.078	●				0.180	0.3750	0.195	0.344	0.4008
FLR-3094R	R	4.8	0.189	0.094	●				0.180	0.3750	0.195	0.344	0.4000
FLR-3094L	L	4.8	0.189	0.094	●				0.180	0.3750	0.195	0.344	0.4000

● : Line up

FLRP (Full nose radius and positive rake)

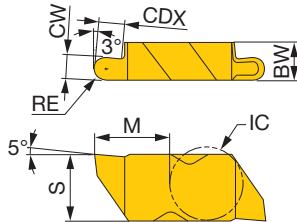

P	Steel	★				
M	Stainless	★				
K	Cast iron	★				
N	Non-ferrous					
S	Superalloys	☆				
H	Hard materials					

★ : First choice
☆ : Second choice

Designation	HAND	CW±0.025 (mm)	CW±0.001 (in)	RE (in)	Coated				CDX (in)	IC (in)	BW (in)	S (in)	M (in)
					AH110								
FLRP-3031R	R	1.57	0.062	0.031	●				0.125	0.3750	0.195	0.344	0.4033
FLRP-3031L	L	1.57	0.062	0.031	●				0.125	0.3750	0.195	0.344	0.4033
FLRP-3047R	R	2.39	0.094	0.047	●				0.180	0.3750	0.195	0.344	0.4025
FLRP-3047L	L	2.39	0.094	0.047	●				0.180	0.3750	0.195	0.344	0.4025
FLRP-3062R	R	3.18	0.125	0.062	●				0.180	0.3750	0.195	0.344	0.4017
FLRP-3062L	L	3.18	0.125	0.062	●				0.180	0.3750	0.195	0.344	0.4017
FLRP-3078R	R	3.96	0.156	0.078	●				0.180	0.3750	0.195	0.344	0.4008
FLRP-3078L	L	3.96	0.156	0.078	●				0.180	0.3750	0.195	0.344	0.4008
FLRP-3094R	R	4.8	0.189	0.094	●				0.180	0.3750	0.195	0.344	0.4000
FLRP-3094L	L	4.8	0.189	0.094	●				0.180	0.3750	0.195	0.344	0.4000

● : Line up

Reference pages: Toolholders → **F143 - F144**



FLGD-CB (Single edge deep, with chipbreaker)

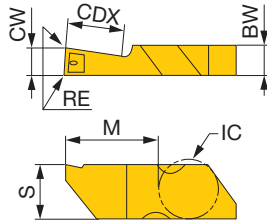

P	Steel	★						
M	Stainless	★						
K	Cast iron	★						
N	Non-ferrous							
S	Superalloys	☆						
H	Hard materials							

★ : First choice
☆ : Second choice

Designation	HAND	CW±0.025 (mm)	CW±0.001 (in)	RE (in)	Coated					CDX (in)	IC (in)	BW (in)	S (in)	M (in)
					AH110									
FLGD-3094R-CB	R	2.39	0.094	0.005 - 0.010	●					0.250	0.3750	0.195	0.344	0.5050
FLGD-3094L-CB	L	2.39	0.094	0.005 - 0.010	●					0.250	0.3750	0.195	0.344	0.5050
FLGD-3125R-CB	R	3.18	0.125	0.005 - 0.010	●					0.250	0.3750	0.195	0.344	0.5050
FLGD-3125L-CB	L	3.18	0.125	0.005 - 0.010	●					0.250	0.3750	0.195	0.344	0.5050
FLGD-3189R-CB	R	4.8	0.189	0.020 - 0.025	●					0.250	0.3750	0.195	0.344	0.5050
FLGD-3189L-CB	L	4.8	0.189	0.020 - 0.025	●					0.250	0.3750	0.195	0.344	0.5050

● : Line up

FLGD (Single edge deep)

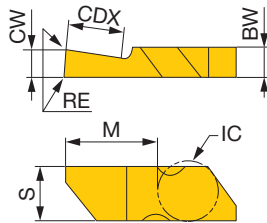

P	Steel	★						
M	Stainless	★						
K	Cast iron	★						
N	Non-ferrous							
S	Superalloys	☆						
H	Hard materials							

★ : First choice
☆ : Second choice

Designation	HAND	CW±0.025 (mm)	CW±0.001 (in)	RE (in)	Coated					CDX (in)	IC (in)	BW (in)	S (in)	M (in)
					AH110									
FLGD-3062R	R	1.57	0.062	0.005 - 0.010	●					0.120	0.3750	0.195	0.344	0.5050
FLGD-3062L	L	1.57	0.062	0.005 - 0.010	●					0.120	0.3750	0.195	0.344	0.5050
FLGD-3094R	R	2.39	0.094	0.005 - 0.010	●					0.250	0.3750	0.195	0.344	0.5050
FLGD-3094L	L	2.39	0.094	0.005 - 0.010	●					0.250	0.3750	0.195	0.344	0.5050
FLGD-3125R	R	3.18	0.125	0.005 - 0.010	●					0.250	0.3750	0.195	0.344	0.5050
FLGD-3125L	L	3.18	0.125	0.005 - 0.010	●					0.250	0.3750	0.195	0.344	0.5050
FLGD-3189R	R	4.8	0.189	0.020 - 0.025	●					0.250	0.3750	0.195	0.344	0.5050
FLGD-3189L	L	4.8	0.189	0.020 - 0.025	●					0.250	0.3750	0.195	0.344	0.5050

● : Line up

Reference pages: Toolholders → **F143 - F144**

FLRD (Full nose radius, single edge deep)

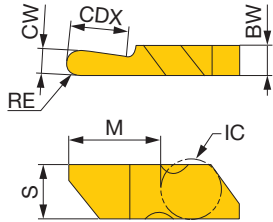

P	Steel	★							
M	Stainless	★							
K	Cast iron	★							
N	Non-ferrous								
S	Superalloys	☆							
H	Hard materials								

★ : First choice
☆ : Second choice

Designation	HAND	CW±0.025 (mm)	CW±0.001 (in)	RE (in)	Coated					CDX (in)	IC (in)	BW (in)	S (in)	M (in)
					AH110									
FLRD-3062R	R	3.19	0.125	0.062	●					0.250	0.3750	0.195	0.344	0.5016
FLRD-3062L	L	3.19	0.125	0.062	●					0.250	0.3750	0.195	0.344	0.5016
FLRD-3094R	R	4.8	0.189	0.094	●					0.250	0.3750	0.195	0.344	0.5016
FLRD-3094L	L	4.8	0.189	0.094	●					0.250	0.3750	0.195	0.344	0.5016

● : Line up

FLGT (Double end deep)

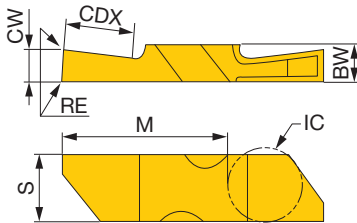

P	Steel	★							
M	Stainless	★							
K	Cast iron	★							
N	Non-ferrous								
S	Superalloys	☆							
H	Hard materials								

★ : First choice
☆ : Second choice

Designation	HAND	CW±0.025 (mm)	CW±0.001 (in)	RE (in)	Coated					CDX (in)	IC (in)	BW (in)	S (in)	M (in)
					AH110									
FLGT-3094R	R	2.39	0.094	0.005 - 0.010	●					0.275	0.3750	0.195	0.344	0.8550
FLGT-3094L	L	2.39	0.094	0.005 - 0.010	●					0.275	0.3750	0.195	0.344	0.8550
FLGT-3125R	R	3.18	0.125	0.005 - 0.010	●					0.437	0.3750	0.195	0.344	0.8550
FLGT-3125L	L	3.18	0.125	0.005 - 0.010	●					0.437	0.3750	0.195	0.344	0.8550
FLGT-3189R	R	4.8	0.189	0.020 - 0.025	●					0.437	0.3750	0.195	0.344	0.8550
FLGT-3189L	L	4.8	0.189	0.020 - 0.025	●					0.437	0.3750	0.195	0.344	0.8550

*Fits FLSLT/RT toolholders

● : Line up



FLRT (Double end deep FNR)

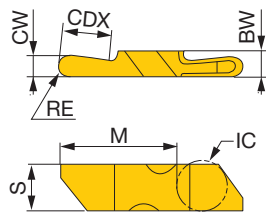

P	Steel	★				
M	Stainless	★				
K	Cast iron	★				
N	Non-ferrous					
S	Superalloys	☆				
H	Hard materials					

★ : First choice
☆ : Second choice

Designation	HAND	CW±0.025 (mm)	CW±0.001 (in)	RE (in)	Coated					CDX (in)	IC (in)	BW (in)	S (in)	M (in)
					AH110									
FLRT-3062R	R	3.18	0.125	0.062	●					0.437	0.3750	0.195	0.344	0.8550
FLRT-3062L	L	3.18	0.125	0.062	●					0.437	0.3750	0.195	0.344	0.8550
FLRT-3094R	R	4.8	0.189	0.094	●					0.437	0.3750	0.195	0.344	0.8550
FLRT-3094L	L	4.8	0.189	0.094	●					0.437	0.3750	0.195	0.344	0.8550

*Fits FLSLT/RT toolholders

● : Line up

FLT-CB (For threading)

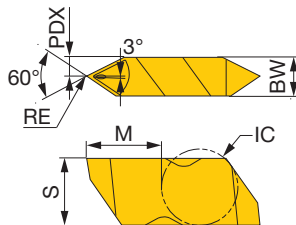

P	Steel	★			
M	Stainless	★			
K	Cast iron	★			
N	Non-ferrous				
S	Superalloys	☆			
H	Hard materials				

★ : First choice
☆ : Second choice

Designation	HAND	RE (in)	Coated		TPI		IC (in)	PDX (in)	BW (in)	S (in)	M (in)
			AH110		Internal	External					
FLT-3R-HCB	R	0.005 - 0.008	●		5-12	6-20	0.3750	0.098	0.195	0.344	0.3999
FLT-3L-HCB	L	0.005 - 0.008	●		5-12	6-20	0.3750	0.098	0.195	0.344	0.3999
FLT-3RC-HCB	R	0.012 - 0.015	●		5-6	6-11	0.3750	0.098	0.195	0.344	0.3999
FLT-3LC-HCB	L	0.012 - 0.015	●		5-6	6-11	0.3750	0.098	0.195	0.344	0.3999
FLT-3R-CB	R	0.005 - 0.008	●		8-12	8-20	0.3750	0.098	0.195	0.344	0.3999
FLT-3L-CB	L	0.005 - 0.008	●		8-12	8-20	0.3750	0.098	0.195	0.344	0.3999

● : Line up

Reference pages: Toolholders → **F143 - F144**

CNR

Clamp-on internal threading and grooving toolholder (alternative clamping of screw-on or clamp-on only for DT type)

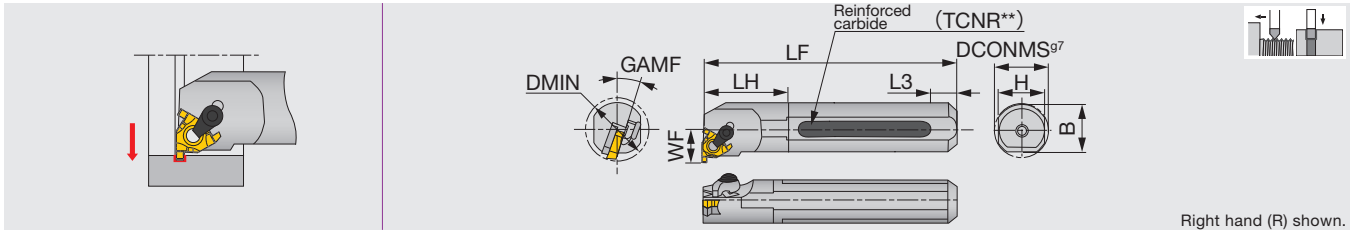

Inch	Material	CWN	CWX	DMIN	DCONMS	WF	LF	LH	L3	H	B	GAMF	Insert	Torque
S12-CNR3DT	STEEL	0.039	0.089	0.950	0.750	0.552	7.000	1.200	-	0.725	0.738	15	GTGN-16...	2.58
S16-CNR3DT	STEEL	0.039	0.089	1.150	1.000	0.652	8.000	1.500	-	0.906	0.953	15	GTGN-16...	2.58
S20-CNR3DT	STEEL	0.039	0.089	1.450	1.250	0.788	10.000	1.900	-	1.188	1.219	15	GTGN-16...	2.58

A clamp set consists of a clamp and a clamping screw.







A shim set consists of a shim and a shim screw to secure the shim to the shank.

Use right-hand toolholders (CNR...) with right-hand inserts (**IR...).

Standard shims can be used on both right- and left-hand toolholders. Please use either of the sides depending on the tool hand.

When using grooving inserts, please use shims for grooving. Shims for grooving inserts are sold separately.

Torque: Recommended clamping torque: lbs-ft

SPARE PARTS						
Designation	Clamp set	Clamping screw	Shim screw	Shim (Optional)	Wrench 1	Wrench 2
S**-CNR3DT	CSP16	CSTB-3.5ST	DTS5-3.5	G16EL/IR-DT	P-3.5	T-15F

INSERT

GTGN16

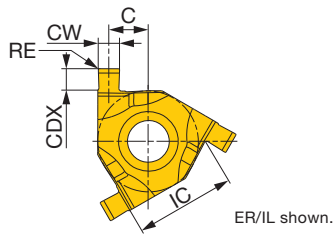

P	Steel	★
M	Stainless	★
K	Cast iron	
N	Non-ferrous	
S	Superalloys	★
H	Hard materials	

★ : First choice
☆ : Second choice

Designation	HAND (Internal)	CW±0.03 (mm)	CW±0.001 (in)	RE (in)	Coated		Insert size	CDX (in)	IC (in)	C (in)	Shim	
					SH730						Dual-clamp toolholder: screw-on and clamp-on	Clamp-on toolholder
GTGN-16ER/IL100	L	1	0.039	0.004	●		16	0.049	0.375	0.166	G16ER/IL-DT	G16ER/IL-S
GTGN-16EL/IR100	R	1	0.039	0.004	●		16	0.049	0.375	0.166	G16ER/IL-DT	G16ER/IL-S
GTGN-16ER/IL120	L	1.2	0.047	0.004	●		16	0.051	0.375	0.162	G16ER/IL-DT	G16ER/IL-S
GTGN-16EL/IR120	R	1.2	0.047	0.004	●		16	0.051	0.375	0.162	G16ER/IL-DT	G16ER/IL-S
GTGN-16ER/IL140	L	1.4	0.055	0.004	●		16	0.059	0.375	0.158	G16ER/IL-DT	G16ER/IL-S
GTGN-16EL/IR140	R	1.4	0.055	0.004	●		16	0.059	0.375	0.158	G16ER/IL-DT	G16ER/IL-S
GTGN-16ER/IL170	L	1.7	0.067	0.004	●		16	0.067	0.375	0.144	G16EL/IR-DT	G16EL/IR-S
GTGN-16EL/IR170	R	1.7	0.067	0.004	●		16	0.067	0.375	0.144	G16EL/IR-DT	G16EL/IR-S
GTGN-16ER/IL195	L	1.95	0.077	0.004	●		16	0.067	0.375	0.148	G16EL/IR-DT	G16EL/IR-S
GTGN-16EL/IR195	R	1.95	0.077	0.004	●		16	0.067	0.375	0.148	G16EL/IR-DT	G16EL/IR-S
GTGN-16ER/IL225	L	2.25	0.089	0.004	●		16	0.071	0.375	0.142	G16EL/IR-DT	G16EL/IR-S
GTGN-16EL/IR225	R	2.25	0.089	0.004	●		16	0.071	0.375	0.142	G16EL/IR-DT	G16EL/IR-S

Note: GTGN insert can be used for both external and internal machining, but the tool hand is reversed.
Shim for GTGN depends on the toolholder type.

● : Line up

STANDARD CUTTING CONDITIONS

ISO	Workpiece material	Grade	Cutting speed Vc (sfm)	Feed f (ipr)
P	Steel 1045, 4140, etc.	SH730	160 - 490	0.002 - 0.004
M	Stainless steel 304, 316, etc.	SH730	100 - 490	0.002 - 0.004
S	Heat-resistant alloys, Titanium alloys, etc. Ti-6Al-4V, etc.	SH730	100 - 330	0.002 - 0.004

Reference pages: Toolholders → **F153**

S-SGTR/L

Internal grooving

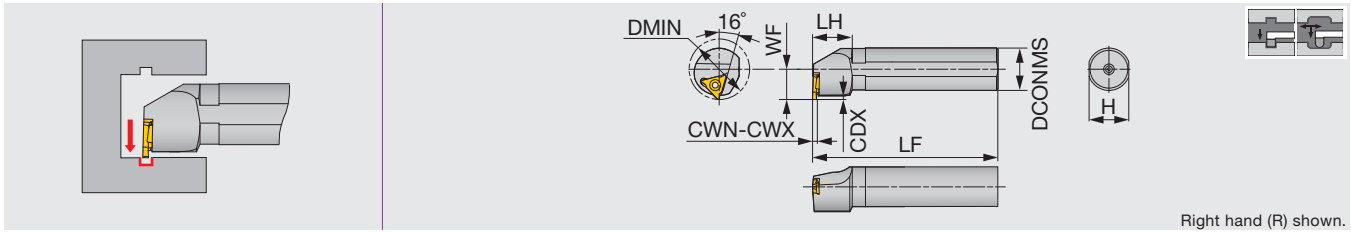

Right hand (R) shown.

Inch	CWN	CWX	DMIN	CDX	DCONMS	H	LF	LH	WF	Insert	Torque
S16R-SGTR/L3	0.013	0.098	1.38	0.100	1.00	0.910	7.78	1.18	0.690	GBL/R32...	2.58

Metric	CWN	CWX	DMIN	CDX	DCONMS	H	LF	LH	WF	Insert	Torque*
S25R-SGTR/L16	0.33	2.5	35	2	25	23	200	30	17.5	GBL/R32...	3.5
S32S-SGTR/L22	1.25	4.5	40	2.5	32	30	250	30	23	GBL/R43...	5

Use right-hand toolholders (SGTR) with left-hand inserts (GBL); and left-hand toolholders (SGTL) with right-hand inserts (GBR).
Torque: Recommended clamping torque: lbs·ft (*N·m)

SPARE PARTS

Designation	Clamping screw	Wrench
S16R-SGTR/L3, S25R-SGTR/L16	CSTB-4S	T-15F
S32S-SGTR/L22	CSTB-5S	T-20F

INSERT

GBR/L32

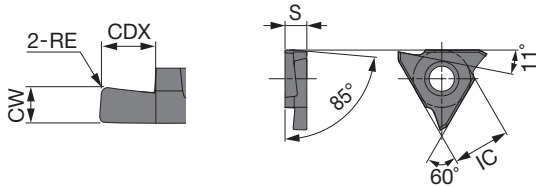

Right hand (R) shown.

	P	M	K	N	S	H
Steel	★					
Stainless	★					
Cast iron	★		☆			
Non-ferrous				★		
Superalloys					☆	
Hard materials						

★ : First choice
☆ : Second choice

Designation	HAND	CW±0.025 (mm)	CW±0.001 (in)	RE (in)	Coated			Cermet			Uncoated			CDX (in)	IC (mm)	S (mm)
					AH710			NS9530			KS05F					
GBR32033	R	0.33	0.013	0.0012	●			●			●			0.031	9.53	3.18
GBL32033	L	0.33	0.013	0.0012	●									0.031	9.53	3.18
GBR32050	R	0.5	0.020	0.002	●			●			●			0.047	9.53	3.18
GBL32050	L	0.5	0.020	0.002	●									0.047	9.53	3.18
GBR32075	R	0.75	0.030	0.002	●			●			●			0.079	9.53	3.18
GBL32075	L	0.75	0.030	0.002	●									0.079	9.53	3.18
GBR32095	R	0.95	0.037	0.002	●			●			●			0.079	9.53	3.18
GBL32095	L	0.95	0.037	0.002	●									0.079	9.53	3.18
GBR32100	R	1	0.039	0.002	●			●			●			0.079	9.53	3.18
GBL32100	L	1	0.039	0.002	●									0.079	9.53	3.18
GBR32125	R	1.25	0.049	0.008	●			●			●			0.079	9.53	3.18
GBL32125	L	1.25	0.049	0.008	●									0.079	9.53	3.18
GBR32145	R	1.45	0.057	0.008	●			●			●			0.079	9.53	3.18
GBL32145	L	1.45	0.057	0.008	●									0.079	9.53	3.18
GBR32150	R	1.5	0.059	0.008	●			●			●			0.079	9.53	3.18
GBL32150	L	1.5	0.059	0.008	●									0.079	9.53	3.18
GBR32200	R	2	0.079	0.008	●			●			●			0.098	9.53	3.18
GBL32200	L	2	0.079	0.008	●									0.098	9.53	3.18
GBR32250	R	2.5	0.098	0.008	●			●			●			0.098	9.53	3.18
GBL32250	L	2.5	0.098	0.008	●									0.098	9.53	3.18

Reference pages: Inserts → **F156 - F157**, Standard cutting conditions → **F157**

● : Line up



GBR/L43

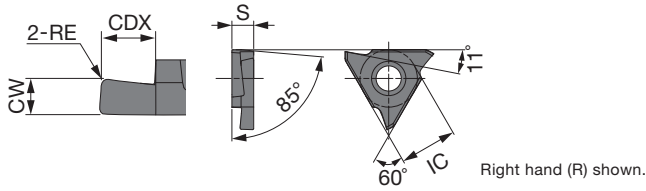

P	Steel	★		★						
M	Stainless	★								
K	Cast iron	★		☆						
N	Non-ferrous						★			
S	Superalloys	☆					☆			
H	Hard materials									

★ : First choice
☆ : Second choice

Designation	HAND	CW±0.025 (mm)	CW±0.001 (in)	RE (in)	Coated			Cermet			Uncoated			CDX (in)	IC (mm)	S (mm)	
					AH710			NS9530			KS05F						
GBR43125	R	1.25	0.049	0.008	●			●			●				0.079	12.7	4.76
GBL43125	L	1.25	0.049	0.008	●										0.079	12.7	4.76
GBR43145	R	1.45	0.057	0.008	●			●			●				0.079	12.7	4.76
GBL43145	L	1.45	0.057	0.008	●										0.079	12.7	4.76
GBR43150	R	1.50	0.059	0.008	●			●			●				0.138	12.7	4.76
GBL43150	L	1.50	0.059	0.008	●										0.138	12.7	4.76
GBR43175	R	1.75	0.069	0.008	●			●			●				0.138	12.7	4.76
GBL43175	L	1.75	0.069	0.008	●										0.138	12.7	4.76
GBR43185	R	1.85	0.073	0.008	●			●			●				0.138	12.7	4.76
GBL43185	L	1.85	0.073	0.008	●										0.138	12.7	4.76
GBR43200	R	2	0.079	0.008	●			●			●				0.138	12.7	4.76
GBL43200	L	2	0.079	0.008	●										0.138	12.7	4.76
GBR43230	R	2.3	0.091	0.008	●			●			●				0.138	12.7	4.76
GBL43230	L	2.3	0.091	0.008	●										0.138	12.7	4.76
GBR43250	R	2.5	0.098	0.012	●			●			●				0.197	12.7	4.76
GBL43250	L	2.5	0.098	0.012	●										0.197	12.7	4.76
GBR43265	R	2.65	0.104	0.012	●			●			●				0.197	12.7	4.76
GBL43265	L	2.65	0.104	0.012	●										0.197	12.7	4.76
GBR43280	R	2.8	0.110	0.012	●			●			●				0.197	12.7	4.76
GBL43280	L	2.8	0.110	0.012	●										0.197	12.7	4.76
GBR43300	R	3	0.118	0.012	●			●			●				0.197	12.7	4.76
GBL43300	L	3	0.118	0.012	●										0.197	12.7	4.76
GBR43330	R	3.3	0.130	0.012	●			●			●				0.197	12.7	4.76
GBL43330	L	3.3	0.130	0.012	●										0.197	12.7	4.76
GBR43350	R	3.5	0.138	0.012	●			●			●				0.197	12.7	4.76
GBL43350	L	3.5	0.138	0.012	●										0.197	12.7	4.76
GBR43400	R	4	0.157	0.016	●			●			●				0.197	12.7	4.76
GBL43400	L	4	0.157	0.016	●										0.197	12.7	4.76
GBR43430	R	4.3	0.169	0.016	●			●			●				0.197	12.7	4.76
GBL43430	L	4.3	0.169	0.016	●										0.197	12.7	4.76
GBR43450	R	4.5	0.177	0.016	●			●			●				0.197	12.7	4.76
GBL43450	L	4.5	0.177	0.016	●										0.197	12.7	4.76

● : Line up

GBR/L43-R(full radius)

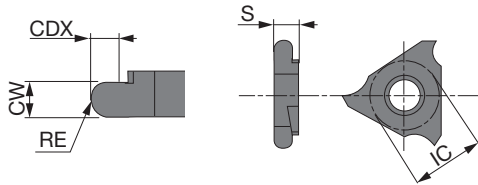

P	Steel	★		★								
M	Stainless	★										
K	Cast iron	★		☆								
N	Non-ferrous							★				
S	Superalloys	☆						☆				
H	Hard materials											

★ : First choice
☆ : Second choice

Designation	HAND	CW±0.025 (mm)	CW±0.001 (in)	RE (in)	Coated			Cermet			Uncoated			CDX (in)	IC (mm)	S (mm)	
					AH710			NS9530			KS05F						
GBR43050R	R	1	0.039	0.020	●			●			●				0.079	12.7	4.76
GBL43050R	L	1	0.039	0.020	●						●				0.079	12.7	4.76
GBR43075R	R	1.5	0.059	0.030	●			●			●				0.138	12.7	4.76
GBL43075R	L	1.5	0.059	0.030	●						●				0.138	12.7	4.76
GBR43100R	R	2	0.079	0.039	●			●			●				0.138	12.7	4.76
GBL43100R	L	2	0.079	0.039	●						●				0.138	12.7	4.76
GBR43125R	R	2.5	0.098	0.049	●			●			●				0.197	12.7	4.76
GBL43125R	L	2.5	0.098	0.049	●						●				0.197	12.7	4.76
GBR43150R	R	3	0.118	0.059	●			●			●				0.197	12.7	4.76
GBL43150R	L	3	0.118	0.059	●						●				0.197	12.7	4.76
GBR43200R	R	4	0.157	0.079	●			●			●				0.197	12.7	4.76
GBL43200R	L	4	0.157	0.079	●						●				0.197	12.7	4.76

● : Line up

STANDARD CUTTING CONDITIONS

ISO	Workpiece material	Hardness	Grade	Cutting Speed Vc (sfm)	Feed f (ipr)
P	Carbon steel, Alloy steel 1045 SAE, 4140 SAE, etc.	150 - 240HB	NS9530	330 - 650	0.001 - 0.010
		150 - 240HB	AH710	200 - 500	0.002 - 0.010
M	Stainless steel 303, 304, etc.	≤ 240HB	AH710	200 - 500	0.002 - 0.006
K	Cast irons 250, etc.	Tensile strength ≤ 350 N/mm ²	AH710	200 - 500	0.002 - 0.006
N	Non-ferrous metals Aluminum, etc.	-	KS05F	650 - 980	0.002 - 0.006

Grade
Insert
Toolholder
Ext. Toolholder
Int. Toolholder
Threading
Grooving
Miniature Tool
Endmill
Drilling Tool
Tooling System
User's Guide
Index



A/E-SNGR

Toolholders for internal grooving, coolant-through

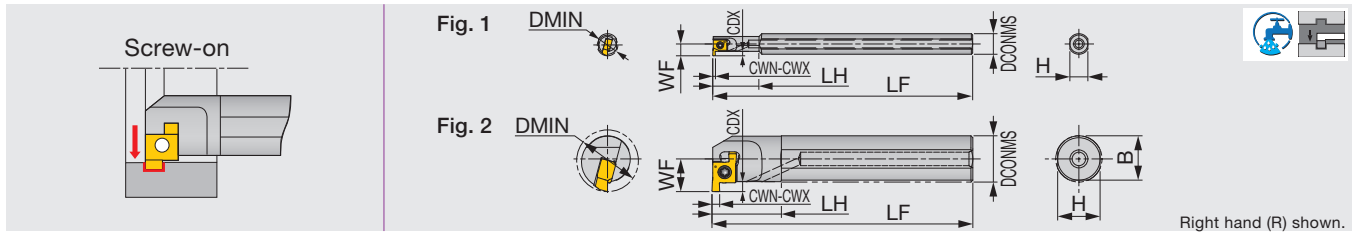

Right hand (R) shown.

Metric	Material	CWN	CWX	DMIN	CDX	DCONMS	H	B	LF	LH	WF	Insert	Torque	Fig.
A08H-SNGR06-D080	Steel	1	2	8	1.5	8	7	-	100	18	4.73	6GMR..., 6GR...	0.7	1
A08H-SNGR07-D100	Steel	1	2	10	1.5	8	7	-	100	23	5.8	7GMR..., 7GR...	1.0	1
A10K-SNGR07-D120	Steel	1	2	12	1.5	10	9	-	125	29	6.8	7GMR..., 7GR...	1.0	1
A10K-SNGR08-D140	Steel	1.5	3.5	14	2	10	9	-	125	15	7.6	8GMR..., 8GR...	1.0	2
A12M-SNGR08-D160	Steel	1.5	3.5	16	2	12	11	11.5	150	18	8.6	8GMR..., 8GR...	1.0	2
A16Q-SNGR09-D200	Steel	1.5	3.5	20	3	16	15	15.5	180	20	11.6	9GMR..., 9GR...	1.3	2
A20R-SNGR09-D240	Steel	1.5	3.5	24	3	20	18	19	200	25	13.6	9GMR..., 9GR...	1.3	2
E08X-SNGR07-D100	Carbide	1	2	10	1.5	8	7.5	-	120.5	35	5.8	7GMR..., 7GR...	1.0	1
E10X-SNGR07-D120	Carbide	1	2	12	1.5	10	9	-	143.5	45	6.8	7GMR..., 7GR...	1.0	1
E10X-SNGR08-D140	Carbide	1.5	3.5	14	2	10	9	-	146	-	7.6	8GMR..., 8GR...	1.0	2
E12X-SNGR08-D160	Carbide	1.5	3.5	16	2	12	11	-	174.8	-	8.6	8GMR..., 8GR...	1.0	2
E16X-SNGR09-D200	Carbide	1.5	3.5	20	3	16	15	-	194.6	-	11.6	9GMR..., 9GR...	1.5	2

Use the right-hand insert (□GR) with the right-hand holder (□NGR).
Torque: Recommended clamping torque: N·m

SPARE PARTS



Designation	Clamping screw	Wrench
A*-SNGR06-D...	CSTB-2L040	T-6F
A*-SNGR07-D...	CSTB-2.2S	T-7F
A*-SNGR08-D...	CSTB-2.2	T-7F
A*-SNGR09-D...	CSTB-2.5L080	T-8F
E*-SNGR07-D...	CSTB-2.2S	T-7F
E*-SNGR08-D...	CSTB-2.2	T-7F
E*-SNGR09-D...	CSTB-2.5L080	T-8F

Reference pages: Inserts → **F160 - F161**, Standard cutting conditions → **F162**

SNGR/L

Internal grooving

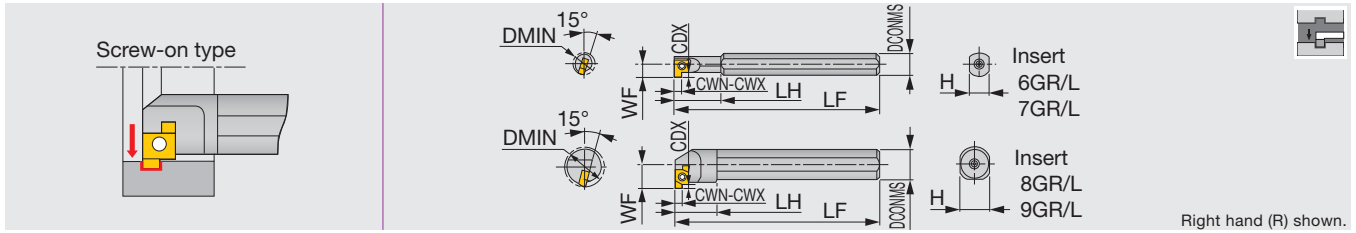

Metric	Material	CWN	CWX	DMIN	CDX	DCONMS	H	LF	LH	WF	Insert	Torque
SNGR/L08H06	Steel	1	2	8	1.5	8	7	100	18	4.7	6GR/L...	0.7
SNGR/L08H07	Steel	1	2	10	1.5	8	7	100	23	5.8	7GR/L...	1.0
SNGR/L10K07	Steel	1	2	12	1.5	10	9	125	29	6.8	7GR/L...	1.0
SNGR/L10K08	Steel	1.5	3.5	14	2	10	9	125	15	7.6	8GR/L...	1.0
SNGR/L12M08	Steel	1.5	3.5	16	2	12	11	150	18	8.6	8GR/L...	1.0
SNGR/L16Q09	Steel	1.5	3.5	20	3	16	15	180	20	11.6	9GR/L...	1.3
SNGR/L20R09	Steel	1.5	3.5	24	3	20	18	200	25	13.6	9GR/L...	1.3
SNGR/L08K06SC	Carbide	1	2	8	1.5	8	7	125	28	4.7	6GR/L...	0.7
SNGR/L08K07SC	Carbide	1	2	10	1.5	8	7	125	35	5.8	7GR/L...	1.0
SNGR/L10M07SC	Carbide	1	2	12	1.5	10	9	150	45	6.8	7GR/L...	1.0
SNGR/L10M08SC	Carbide	1.5	3.5	14	2	10	9	150	45	7.6	8GR/L...	1.0
SNGR/L12Q08SC	Carbide	1.5	3.5	16	2	12	11	180	-	8.6	8GR/L...	1.0
SNGR/L16R09SC	Carbide	1.5	3.5	20	3	16	15	200	-	11.6	9GR/L...	1.5

Use right-hand holder (□NGR ~) with right-hand insert (□GR ~); and left-hand holder (□NGL ~) with left-hand insert (□GL ~).
Torque: Recommended clamping torque: N·m

SPARE PARTS

Designation	Clamping screw	Wrench
SNGR/L***06	CSTB-2L040	T-6F
SNGR/L***07	CSTB-2.2S	T-7F
SNGR/L***08	CSTB-2.2	T-7F
SNGR/L***09	CSTB-2.5L080	T-8F
SNGR/L***06SC	CSTB-2L040	T-6F
SNGR/L***07SC	CSTB-2.2S	T-7F
SNGR/L***08SC	CSTB-2.2	T-7F
SNGR/L***09SC	CSTB-2.5L080	T-8F

CNGR/L

Internal grooving

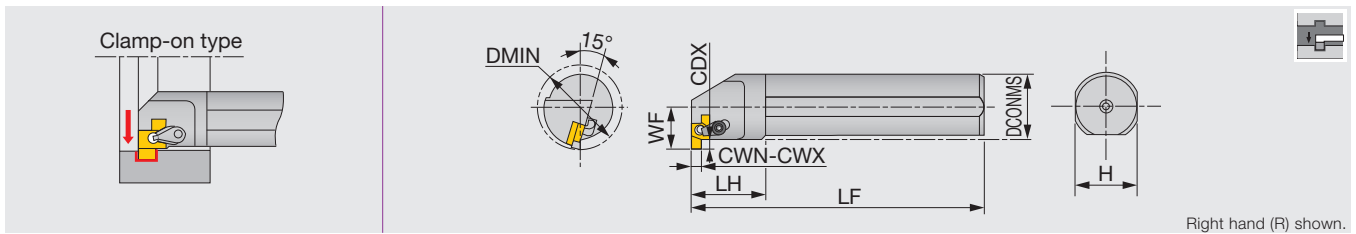

Metric	CWN	CWX	DMIN	CDX	DCONMS	H	LF	LH	WF	Insert	Torque*
CNGR/L25S15	2	5	32	5	25	23	250	30	18.1	15GR/L...	7
CNGR/L32T15	2	5	40	5	32	30	300	35	22.1	15GR/L...	7
CNGR/L40U15	2	5	48	5	40	38	350	45	26.1	15GR/L...	7

Use right-hand holder (□NGR ~) with right-hand insert (□GR ~); and left-hand holder (□NGL ~) with left-hand insert (□GL ~).
Torque: Recommended clamping torque: N·m

SPARE PARTS

Designation	Clamp set	Screw	Shim	Wrench
CNGR...	CSP22	DTS5-3.5	SGSR151	T-20F
CNGL...	CSP22	DTS5-3.5	SGSL151	T-20F

Optional parts for CNG type toolholder

When using as a screw-on type, please use the parts below.

Designation	Clamping screw	Wrench
CNGR/L...	CSTB-3.5L	T-15F

Reference pages: Inserts → **F160 - F161**, Standard cutting conditions → **F162**



INSERT

**GMR/L

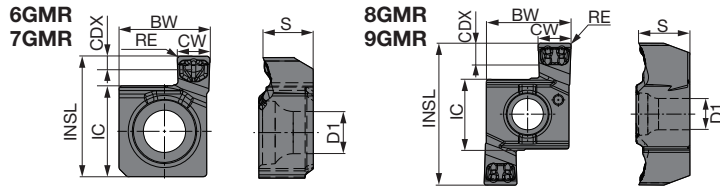

Single edge

Double edge

Right hand (R) shown.

P	Steel	★							
M	Stainless	★							
K	Cast iron	★							
N	Non-ferrous								
S	Superalloys	★							
H	Hard materials								

★ : First choice
☆ : Second choice

Designation	HAND	CW±0.001 (in)	CW±0.025 (mm)	RE (mm)	Coated					CDX (mm)	BW (in)	S (in)	IC (in)	INSL (in)	D1 (in)
					AH7025										
6GMR100-015	R	0.039	1	0.15	●					1.5	0.219	0.092	0.187	0.254	0.091
7GMR200-020	R	0.079	2	0.20	●					1.5	0.219	0.121	0.219	0.290	0.102
8GMR150-020	R	0.059	1.5	0.20	●					2	0.242	0.152	0.219	0.400	0.102
9GMR200-020	R	0.079	2	0.20	●					3	0.305	0.183	0.250	0.510	0.113
9GMR300-020	R	0.118	3	0.20	●					3	0.305	0.183	0.250	0.510	0.113

● : Line up



INSERT

**GR/L

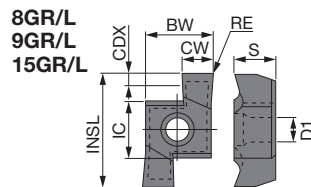
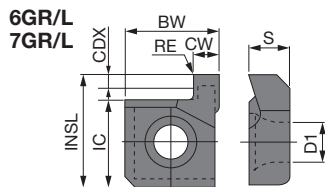

Right hand (R) shown.

P	Steel	★			★
M	Stainless				★
K	Cast iron	☆		★	
N	Non-ferrous			★	
S	Superalloys			☆	
H	Hard materials				

★ : First choice
☆ : Second choice

Designation	HAND	CW±0.001 (in)	CW±0.025 (mm)	RE (mm)	Cermet		Uncoated		CDX (mm)	BW (in)	S (in)	IC (in)	INSL (in)	D1 (in)
					NS9530		TH10	UX30						
6GR100	R	0.039	1	0.2	●		●	●	1.5	0.220	0.092	0.187	0.254	0.098
6GL100	L	0.039	1	0.2				●	1.5	0.220	0.092	0.187	0.254	0.098
6GR150	R	0.059	1.5	0.2	●		●	●	1.5	0.220	0.092	0.187	0.254	0.098
6GL150	L	0.059	1.5	0.2			●	●	1.5	0.220	0.092	0.187	0.254	0.098
6GR200	R	0.079	2	0.2	●		●	●	1.5	0.220	0.092	0.187	0.254	0.098
6GL200	L	0.079	2	0.2			●	●	1.5	0.220	0.092	0.187	0.254	0.098
7GR100	R	0.039	1	0.2	●		●	●	1.5	0.220	0.121	0.219	0.290	0.102
7GR150	R	0.059	1.5	0.2	●		●	●	1.5	0.220	0.121	0.219	0.290	0.102
7GR200	R	0.079	2	0.2	●		●	●	1.5	0.220	0.121	0.219	0.290	0.102
7GL200	L	0.079	2	0.2			●	●	1.5	0.220	0.121	0.219	0.290	0.102
8GR150	R	0.059	1.5	0.2	●		●	●	2	0.244	0.152	0.219	0.400	0.102
8GR200	R	0.079	2	0.2	●		●	●	2	0.244	0.152	0.219	0.400	0.102
8GL200	L	0.079	2	0.2			●		2	0.244	0.152	0.219	0.400	0.102
8GR250	R	0.098	2.5	0.2	●		●	●	2	0.244	0.152	0.219	0.400	0.102
8GL250	L	0.098	2.5	0.2			●	●	2	0.244	0.152	0.219	0.400	0.102
8GR300	R	0.118	3	0.2	●		●	●	2	0.244	0.152	0.219	0.400	0.102
8GL300	L	0.118	3	0.2			●	●	2	0.244	0.152	0.219	0.400	0.102
8GR350	R	0.138	3.5	0.2			●	●	2	0.244	0.152	0.219	0.400	0.102
9GR150	R	0.059	1.5	0.2	●		●	●	2	0.303	0.183	0.250	0.510	0.114
9GL150	L	0.059	1.5	0.2	●			●	2	0.303	0.183	0.250	0.510	0.114
9GR200	R	0.079	2	0.2	●		●	●	3	0.303	0.183	0.250	0.510	0.114
9GL200	L	0.079	2	0.2	●		●	●	3	0.303	0.183	0.250	0.510	0.114
9GR250	R	0.098	2.5	0.2	●		●	●	3	0.303	0.183	0.250	0.510	0.114
9GL250	L	0.098	2.5	0.2	●			●	3	0.303	0.183	0.250	0.510	0.114
9GR300	R	0.118	3	0.2	●		●	●	3	0.303	0.183	0.250	0.510	0.114
9GL300	L	0.118	3	0.2	●		●	●	3	0.303	0.183	0.250	0.510	0.114
9GR350	R	0.138	3.5	0.2	●		●	●	3	0.303	0.183	0.250	0.510	0.114
9GL350	L	0.138	3.5	0.2	●			●	3	0.303	0.183	0.250	0.510	0.114
15GR200	R	0.079	2	0.2	●		●	●	3	0.425	0.201	0.362	0.819	0.189
15GR250	R	0.098	2.5	0.2	●		●	●	3	0.425	0.201	0.362	0.819	0.189
15GR300	R	0.118	3	0.2	●		●	●	3	0.425	0.201	0.362	0.819	0.189
15GL300	L	0.118	3	0.2				●	3	0.425	0.201	0.362	0.819	0.189
15GR350	R	0.138	3.5	0.2	●		●	●	3	0.425	0.201	0.362	0.819	0.189
15GR400	R	0.157	4	0.2	●		●	●	4	0.425	0.201	0.362	0.819	0.189
15GR450	R	0.177	4.5	0.2			●	●	4	0.425	0.201	0.362	0.819	0.189
15GL450	L	0.177	4.5	0.2			●		4	0.425	0.201	0.362	0.819	0.189
15GR500	R	0.197	5	0.2			●	●	5	0.425	0.201	0.362	0.819	0.189

Note: Use right-hand holder (□NGR ~) with right-hand insert (□GR ~); and left-hand holder (□NGL ~) with left-hand insert (□GL ~).

● : Line up

Grade
Insert
Ext. Toolholder
Int. Toolholder
Threading
Grooving
Miniature Tool
Endmill
Drilling Tool
Tooling System
User's Guide
Index



STANDARD CUTTING CONDITIONS

ISO	Workpiece material	Grade	Cutting speed Vc (sfm)	Feed rate: f (ipr)	
				**GMR...	**GR/L...
P	Carbon steel 1045, etc.	AH7025	262 - 591	0.0012 - 0.0047	-
		NS9530	262 - 656	-	0.002 - 0.0059
		UX30	131 - 492	-	0.002 - 0.0059
	Alloy steel 4137, etc.	AH7025	262 - 591	0.0012 - 0.0047	-
		NS9530	262 - 656	-	0.002 - 0.0059
		UX30	131 - 492	-	0.002 - 0.0059
M	Stainless steel 304SS, etc.	AH7025	164 - 394	0.0012 - 0.0047	-
		UX30	131 - 328	-	0.0012 - 0.0039
K	Grey cast irons Class 25, etc.	AH7025	164 - 722	0.0012 - 0.0047	-
		TH10	197 - 656	-	0.002 - 0.0059
	Ductile cast irons 60-40-18, etc.	AH7025	164 - 591	0.0012 - 0.0047	-
		TH10	131 - 525	-	0.002 - 0.0059
S	Titanium alloys Ti-6Al-4V, etc.	AH7025	98 - 262	0.0012 - 0.0047	-
		TH10	66 - 164	-	0.002 - 0.0031
	Superalloys Inconel718, etc.	AH7025	66 - 197	0.0012 - 0.0047	-
		TH10	33 - 98	-	0.0012 - 0.0031



Reference pages: Inserts → **F160 - F161**, Toolholders → **F158 - F159**

CGXR/L

Internal grooving

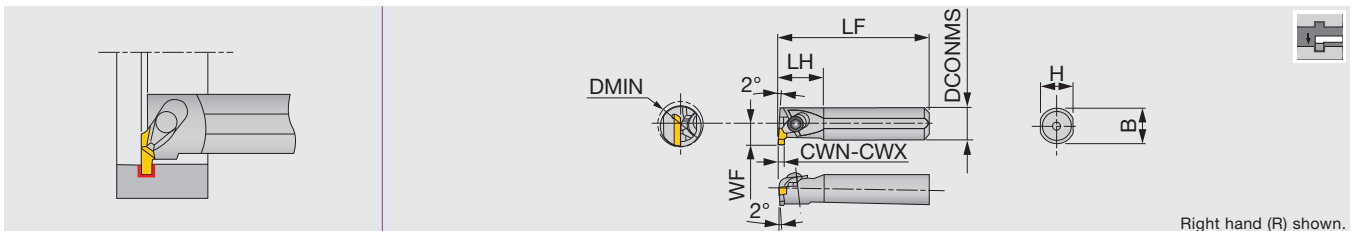

Metric	Material	CWN	CWX	DMIN	CDX	DCONMS	H	B	LF	LH	WF	Insert	Torque*
CGXR/L0016	Steel	1	3	20	3	16	15	15.5	150	24	11.3	GIR/L52...	2.2
CGXR/L0020	Steel	1	3	24	3	20	18	19	180	30	13.3	GIR/L52...	2.2
CGXR/L0025	Steel	1	5	32	5.3	25	23	24	200	38	18	GIR/L63...	5
CGXR/L0032	Steel	1	5	40	5.3	32	30	31	250	48	23	GIR/L63...	5
CGXR/L0040	Steel	1	5	48	5.3	40	37	38.5	300	60	27	GIR/L63...	5
CGXR/L16SC	Carbide	1	3	20	3	16	15	-	200	24	11.3	GIR/L52...	2.2

Note: Use right-hand holder (CGXR) with right-hand insert (GIR); and left-hand holder (L) with left-hand insert (GIL).
*Torque: Recommended clamping torque (N·m)

SPARE PARTS			
Designation	Clamp set	Wrench1	Wrench2
CGXR/L0016/20	CSW-0	-	P-2.5T
CGXR/L0025/32/40	CSW-2	P-4	-
CGXR/L16SC	CSW-0	-	P-2.5T

Reference pages: Inserts, Standard cutting conditions → **F163**

INSERT

GIR/L

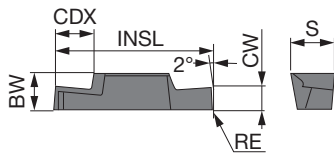

Right hand (R) shown.

P	Steel	★							
M	Stainless					☆			
K	Cast iron	☆				★			
N	Non-ferrous					★			
S	Superalloys					☆			
H	Hard materials								

★ : First choice
☆ : Second choice

Designation	HAND	CW±0.002 (in)	CW±0.05 (mm)	RE (mm)	Coated		Uncoated		CDX (mm)	INSL (mm)	BW (mm)	S (mm)
					NS9530		TH10					
GIR5210-02	R	0.039	1	0.2	●		●		1.5	15	3.5	4.4
GIL5210-02	L	0.039	1	0.2	●		●		1.5	15	3.5	4.4
GIR5215-02	R	0.059	1.5	0.2	●		●		2.3	15	3.5	4.4
GIL5215-02	L	0.059	1.5	0.2	●		●		2.3	15	3.5	4.4
GIR5220-02	R	0.079	2	0.2	●		●		3	15	3.5	4.4
GIL5220-02	L	0.079	2	0.2	●		●		3	15	3.5	4.4
GIR5225-02	R	0.098	2.5	0.2	●		●		3	15	3.5	4.4
GIL5225-02	L	0.098	2.5	0.2	●		●		3	15	3.5	4.4
GIR5230-02	R	0.118	3	0.2	●		●		3	15	3.5	4.4
GIL5230-02	L	0.118	3	0.2	●		●		3	15	3.5	4.4
GIR6310-02	R	0.039	1	0.2	●		●		1.5	24	5.5	6.4
GIL6310-02	L	0.039	1	0.2	●		●		1.5	24	5.5	6.4
GIR6315-02	R	0.059	1.5	0.2	●		●		2.3	24	5.5	6.4
GIL6315-02	L	0.059	1.5	0.2	●		●		2.3	24	5.5	6.4
GIR6320-02	R	0.079	2	0.2	●		●		3	24	5.5	6.4
GIL6320-02	L	0.079	2	0.2	●		●		3	24	5.5	6.4
GIR6325-02	R	0.098	2.5	0.2	●		●		3.8	24	5.5	6.4
GIL6325-02	L	0.098	2.5	0.2	●		●		3.8	24	5.5	6.4
GIR6330-02	R	0.118	3	0.2	●		●		4.5	24	5.5	6.4
GIL6330-02	L	0.118	3	0.2	●		●		4.5	24	5.5	6.4
GIR6335-02	R	0.138	3.5	0.2	●		●		5.3	24	5.5	6.4
GIL6335-02	L	0.138	3.5	0.2	●		●		5.3	24	5.5	6.4
GIR6340-02	R	0.157	4	0.2	●		●		5.3	24	5.5	6.4
GIL6340-02	L	0.157	4	0.2	●		●		5.3	24	5.5	6.4
GIR6345-02	R	0.177	4.5	0.2	●		●		5.3	24	5.5	6.4
GIL6345-02	L	0.177	4.5	0.2	●		●		5.3	24	5.5	6.4
GIR6350-02	R	0.197	5	0.2	●		●		5.3	24	5.5	6.4
GIL6350-02	L	0.197	5	0.2	●		●		5.3	24	5.5	6.4

Use right-hand toolholders (CGXR~) with right-hand inserts (GIR); and left-hand toolholders (GX-****LI) with left-hand inserts (XGR).

● : Line up

STANDARD CUTTING CONDITIONS

ISO	Workpiece material	Grade	Cutting speed Vc (sfm)	Feed: f (ipr)		
				CW < 0.079"	CW = 0.079" - 0.157"	CW > 0.157"
P	Carbon steel	NS9530	262 - 492	0.002 - 0.004	0.003 - 0.006	0.003 - 0.008
K	Cast iron, Light alloys	TH10	197 - 492	0.002 - 0.004	0.003 - 0.006	0.003 - 0.008

Reference pages: Toolholders → **F162**

Grade
Insert
Toolholder
Ext. Toolholder
Int. Toolholder
Threading
Grooving
Miniature Tool
Milling Cutter
Endmill
Drilling Tool
Tooling System
Index



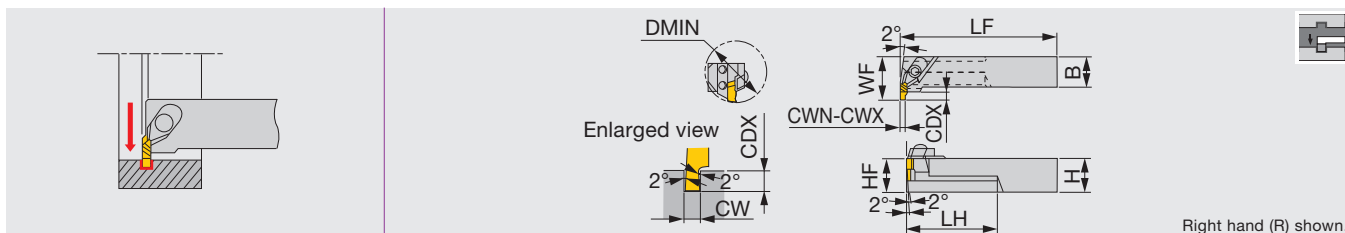

Inch	CWN	CWX	DMIN	CDX	H	B	LF	LH	HF	WF	Insert	Torque
GX-1212RIU	0.039	0.177	2.165	0.059 - 0.236	0.750	0.75	6.30	2.36	0.75	1.37	XGL63...	3.69
GX-1616RIU	0.039	0.177	2.165	0.059 - 0.236	1.00	1.00	7.87	1.96	1.00	1.37	XGL63...	3.69

Metric	CWN	CWX	DMIN	CDX	H	B	LF	LH	HF	WF	Insert	Torque*
GX-2525R/LI	1	4.5	55	1.5 - 6	25	25	200	70	25	35	XGL/R63...	5

Use right-hand toolholders (GX-****R) with left-hand inserts (XGL); and left-hand toolholders (GX-****L) with right-hand inserts (XGR).
Torque: Recommended clamping torque: lbs-ft (*N·m)

SPARE PARTS

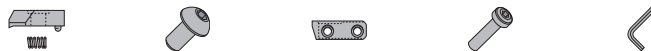

Designation	Clamp set	Clamp screw	Shim	Shim screw	Wrench
GX-1212RIU	CP81B	RT-1	SL-7R	BHM4-8	P-4
GX-2525RI	CP81B	RT-1	SL-2R	BHM3-8	P-4
GX-1616RIU, GX-2525LI	CP81B	RT-1	SL-2L	BHM3-8	P-4

Max. groove width and max. groove depth will depend on the insert type.

INSERT

XGR/L

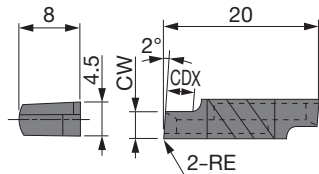

Right hand (R) shown.

	P	M	K	N	S	H
Steel	★			☆	★	
Stainless					★	
Cast iron	☆			★		
Non-ferrous				★		
Superalloys				☆		
Hard materials						

★ : First choice
☆ : Second choice

Designation	HAND	CW±0.025 (mm)	CW±0.001 (in)	RE (in)	Cermet		Uncoated		CDX (in)
					NS9530	TH10	UX30		
XGR6310-02	R	1	0.039	0.008	●		●	●	0.059
XGL6310-02	L	1	0.039	0.008	●		●	●	0.059
XGR6315-02	R	1.5	0.059	0.008	●		●	●	0.091
XGL6315-02	L	1.5	0.059	0.008	●		●	●	0.091
XGR6320-02	R	2	0.079	0.008	●		●	●	0.118
XGL6320-02	L	2	0.079	0.008	●		●	●	0.118
XGR6325-02	R	2.5	0.098	0.008	●		●	●	0.150
XGL6325-02	L	2.5	0.098	0.008	●		●	●	0.150
XGR6330-02	R	3	0.118	0.008	●		●	●	0.177
XGL6330-02	L	3	0.118	0.008	●		●	●	0.177
XGR6335-02	R	3.5	0.138	0.008	●		●	●	0.209
XGL6335-02	L	3.5	0.138	0.008	●		●	●	0.209
XGR6340-02	R	4	0.157	0.008	●		●	●	0.236
XGL6340-02	L	4	0.157	0.008	●		●	●	0.236
XGR6345-02	R	4.5	0.177	0.008	●		●	●	0.236
XGL6345-02	L	4.5	0.177	0.008	●		●	●	0.236

Use right-hand toolholders (GX-****RE) with right-hand inserts (XGR...) left-hand toolholders (GX-****LE) with left-hand inserts (XGL...).

● : Line up

Reference pages: Standard cutting conditions → F165

STANDARD CUTTING CONDITIONS

ISO	Workpiece material	Grade	Cutting speed Vc (sfm)	Feed: f (ipr)		
				CW < 0.079"	CW = 0.079" - 0.157"	CW > 0.157"
P	Carbon steel	NS9530	262 - 656	0.002 - 0.004	0.003 - 0.008	0.003 - 0.010
		UX30	197 - 492	0.002 - 0.004	0.003 - 0.008	0.003 - 0.010
K	Cast irons , Light alloys	TH10	197 - 492	0.002 - 0.004	0.003 - 0.008	0.003 - 0.010
H	Hardened steel	BX360	164 - 591	0.002 - 0.006	0.002 - 0.006	0.002 - 0.006

Grade
 Insert
 Ext. Toolholder
 Int. Toolholder
 Threading
 Grooving
 Miniature Tool
 Milling Cutter
 Endmill
 Drilling Tool
 Tooling System
 User's Guide
 Index



MY-T SERIES

CGWTR/L0040-FLL/R3NP

Internal grooving and turning toolholder

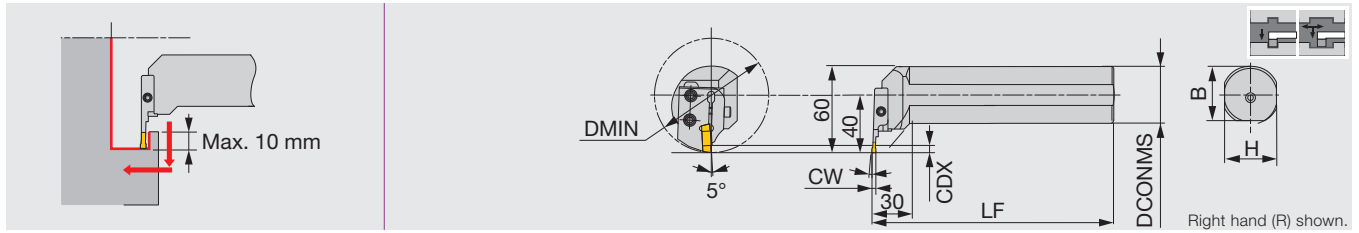

Metric	CW	DMIN	CDX	DCONMS	LF	H	B	Insert	Shank	Blade	Torque
CGWTR/L0040-FLL/R3NP	3	80	10	40	180	37.5	37	FLEX30L/R	CGWTR/L0040	FLL/R3NP	5

Please place an order with the designation of a set or a shank+a blade

Note: Use right-hand blades (CCWTR) with left-hand shanks (FLL3NP); and left-hand blades (CGWTL) with right-hand shanks (FLR3NP).

Torque: Recommended clamping torque: N·m

SPARE PARTS

Designation	Clamping screw	Blade screw	Wrench
CGWTR/L0040-FLL/R3NP	CHHM5-18	CSHB-6	P-4

INSERT

FLEX(R/L)

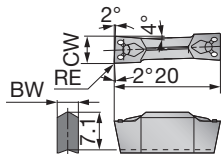

Right hand (R) shown.

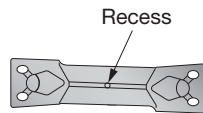

To distinguish the insert hands, the V-shape surface (top surface) of a left-hand insert has a recess. (not of a right-hand insert)

	P	M	K	N	S	H
Steel	★ ☆					
Stainless	★					
Cast iron	☆		☆			
Non-ferrous						
Superalloys						
Hard materials						

★ : First choice
☆ : Second choice

Designation	HAND	CW±0.002 (in)	CW±0.05 (mm)	RE (mm)	Coated		Carbide		Uncoated		BW (mm)
					T9225	T9125	NS9530	UX30			
FLEX30R	R	0.118	3	0.4			●				2.2
FLEX30L	L	0.118	3	0.4			●				2.2
FLEX40R	R	0.157	4	0.4			●				3.1
FLEX40L	L	0.157	4	0.4			●				3.1
FLEX50R	R	0.197	5	0.4	● ▲		●		●		4
FLEX50L	L	0.197	5	0.4	● ▲		●		●		4

● : Line up
▲ : To be discontinued

STANDARD CUTTING CONDITIONS

ISO	Workpiece material	Grade	Cutting speed Vc (sfm)	Feed: f (ipr)	
				Grooving	Turning
P	Carbon steel	T9225	262 - 984	0.002 - 0.010	0.004 - 0.012
		NS9530	262 - 656	0.002 - 0.010	0.004 - 0.012
		UX30	197 - 492	0.002 - 0.010	0.004 - 0.012

Face grooving and turning toolholder

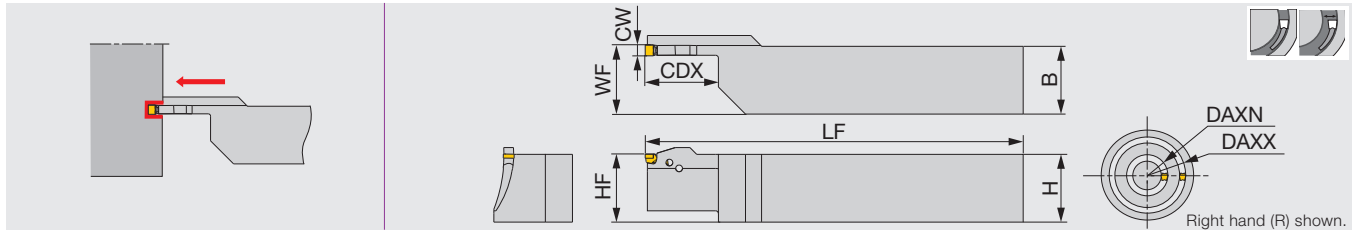

Inch	CW	DAXN	DAXX	CDX	H	B	LF	HF	WF	Insert
ETFR/L12-4T15-030035	0.157	1.181	1.378	0.591	0.750	0.750	5.000	0.750	0.770	E**4...
ETFR/L16-4T15-030035	0.157	1.181	1.378	0.591	1.000	1.000	6.000	1.000	1.020	E**4...
ETFR/L12-4T22-035045	0.157	1.378	1.772	0.866	0.750	0.750	5.000	0.750	0.770	E**4...
ETFR/L16-4T22-035045	0.157	1.378	1.772	0.866	1.000	1.000	6.000	1.000	1.020	E**4...
ETFR/L12-4T25-045055	0.157	1.772	2.165	0.984	0.750	0.750	5.000	0.750	0.770	E**4...
ETFR/L16-4T25-045055	0.157	1.772	2.165	0.984	1.000	1.000	6.000	1.000	1.020	E**4...
ETFR/L12-4T25-055075	0.157	2.165	2.953	0.984	0.750	0.750	5.000	0.750	0.770	E**4...
ETFR/L16-4T25-055075	0.157	2.165	2.953	0.984	1.000	1.000	6.000	1.000	1.020	E**4...
ETFR/L12-4T25-075120	0.157	2.953	4.724	0.984	0.750	0.750	5.000	0.750	0.770	E**4...
ETFR/L16-4T25-075120	0.157	2.953	4.724	0.984	1.000	1.000	6.000	1.000	1.020	E**4...
ETFR/L16-4T25-120200	0.157	4.724	7.874	0.984	1.000	1.000	6.000	1.000	1.020	E**4...
ETFR/L16-4T25-200500	0.157	7.874	19.685	0.984	1.000	1.000	6.000	1.000	1.020	E**4...
ETFR/L16-5T25-035045	0.197	1.378	1.772	0.984	1.000	1.000	6.000	1.000	1.020	ETX5...
ETFR/L16-5T25-045055	0.197	1.772	2.165	0.984	1.000	1.000	6.000	1.000	1.020	ETX5...
ETFR/L16-5T25-055075	0.197	2.165	2.953	0.984	1.000	1.000	6.000	1.000	1.020	ETX5...
ETFR/L16-5T32-075120	0.197	2.953	4.724	1.260	1.000	1.000	6.000	1.000	1.020	ETX5...
ETFR/L16-5T32-120200	0.197	4.724	7.874	1.260	1.000	1.000	6.000	1.000	1.020	ETX5...
ETFR/L16-5T32-200500	0.197	7.874	19.685	1.260	1.000	1.000	6.000	1.000	1.020	ETX5...
ETFR/L16-6T25-040055	0.236	1.575	2.165	0.984	1.000	1.000	6.000	1.000	1.020	ETX6...
ETFR/L16-6T25-055075	0.236	2.165	2.953	0.984	1.000	1.000	6.000	1.000	1.020	ETX6...
ETFR/L16-6T32-075120	0.236	2.953	4.724	1.260	1.000	1.000	6.000	1.000	1.020	ETX6...
ETFR/L16-6T32-120200	0.236	4.724	7.874	1.260	1.000	1.000	6.000	1.000	1.020	ETX6...
ETFR/L16-6T32-200500	0.236	7.874	19.685	1.260	1.000	1.000	6.000	1.000	1.020	ETX6...

SPARE PARTS

Designation	Wrench (Optional)
ETFR/L...	ECW-456EF

Wrench (ECW...) is not included. Please order it separately.

Face grooving and turning toolholder, with high pressure coolant capability

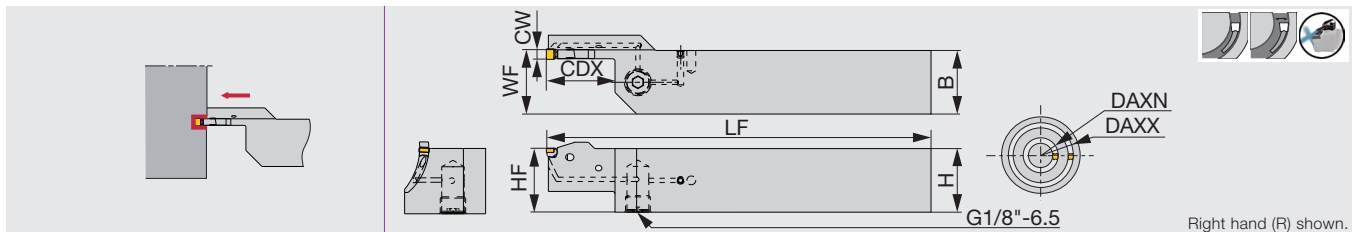

Inch	CW	DAXN	DAXX	CDX	H	B	LF	HF	WF	Insert
ETFR16-4T15-030035-CHP	0.157	1.181	1.378	0.591	1.000	1.000	6.000	1.000	1.020	E**4...
ETFR16-4T22-035045-CHP	0.157	1.378	1.772	0.866	1.000	1.000	6.000	1.000	1.020	E**4...
ETFR16-4T25-045055-CHP	0.157	1.772	2.165	0.984	1.000	1.000	6.000	1.000	1.020	E**4...
ETFR16-4T25-055075-CHP	0.157	2.165	2.953	0.984	1.000	1.000	6.000	1.000	1.020	E**4...
ETFR16-4T25-075120-CHP	0.157	2.953	4.724	0.984	1.000	1.000	6.000	1.000	1.020	E**4...
ETFR16-4T25-120200-CHP	0.157	4.724	7.874	0.984	1.000	1.000	6.000	1.000	1.020	E**4...
ETFR16-4T25-200500-CHP	0.157	7.874	19.685	0.984	1.000	1.000	6.000	1.000	1.020	E**4...

SPARE PARTS

Designation	Wrench (Optional)
ETFR**-CHP	ECW-456EF

Wrench (ECW...) is not included. Please order it separately.

Reference pages: Inserts, Standard cutting conditions → **F170**, Parts for coolant hose → **F240**

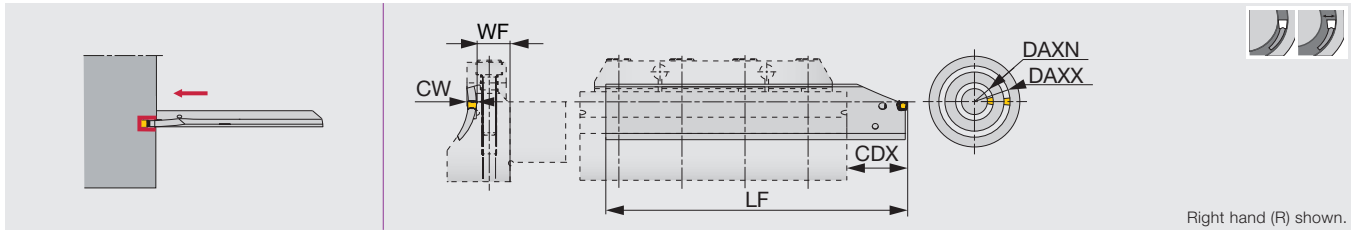

Inch	CW	DAXN	DAXX	WF	LF	Min. CDX	Max. CDX	Insert
EFPR/L-4-030035	0.157	1.181	1.378	0.535	4.921	0.709	1.968	E**4...
EFPR-4-035045	0.157	1.378	1.772	0.535	4.921	0.709	1.968	E**4...
EFPR-4-045055	0.157	1.772	2.165	0.535	4.921	0.709	1.968	E**4...
EFPR-4-055075	0.157	2.165	2.953	0.535	4.921	0.709	1.968	E**4...
EFPR-4-075120	0.157	2.953	4.724	0.535	5.512	0.709	2.559	E**4...
EFPR-4-120200	0.157	4.724	7.874	0.535	5.512	0.709	2.559	E**4...
EFPR-4-200500	0.157	7.874	19.685	0.535	5.512	0.709	2.559	E**4...
EFPR-5-035045	0.197	1.378	1.772	0.535	4.921	0.748	1.968	ETX5...
EFPR-5-045055	0.197	1.772	2.165	0.535	4.921	0.748	1.968	ETX5...
EFPR-5-055075	0.197	2.165	2.953	0.535	4.921	0.748	1.968	ETX5...
EFPR-5-075120	0.197	2.953	4.724	0.535	5.512	0.748	2.559	ETX5...
EFPR-5-120200	0.197	4.724	7.874	0.535	5.512	0.748	2.559	ETX5...
EFPR-5-200500	0.197	7.874	19.685	0.535	5.512	0.748	2.559	ETX5...
EFPR-6-045055	0.236	1.772	2.165	0.535	4.921	0.787	1.968	ETX6...
EFPR-6-055075	0.236	2.165	2.953	0.535	4.921	0.787	1.968	ETX6...
EFPR-6-075120	0.236	2.953	4.724	0.535	5.512	0.787	2.559	ETX6...
EFPR-6-120200	0.236	4.724	7.874	0.535	5.512	0.787	2.559	ETX6...
EFPR/L-6-200500	0.236	7.874	19.685	0.535	5.512	0.787	2.559	ETX6...

SPARE PARTS

Designation	Wrench (Optional)
EFPR/L...	ECW-456I

Wrench (ECW...) is not included. Please order it separately.

Procedure to clamp and unclamp insert

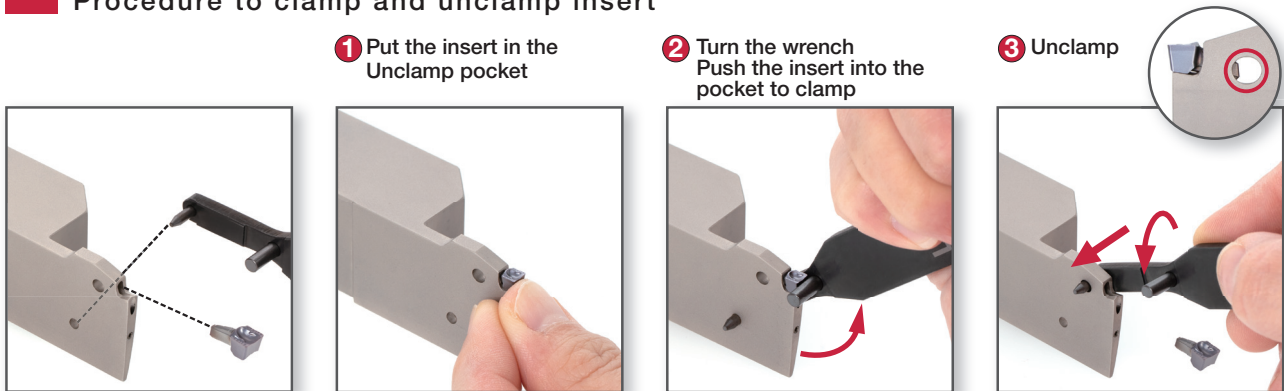

Tool block for EFP blades with high pressure coolant capability

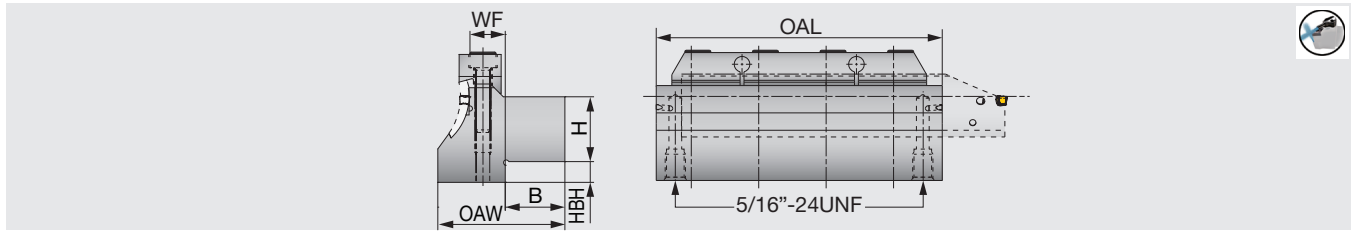

Inch	CW	DAXN	WF	H	B	HBH	OAW	OAL	Blade
CTBU16-030-4U-CHP	0.157	1.181	0.535	1.000	0.905	0.299	1.929	4.331	EFPR/L-4-030035
CTBU16-035-4/5U-CHP	0.157, 0.197	1.378	0.535	1.000	0.905	0.299	1.929	4.331	EFPR/L-4/5-035045
CTBU16-045-4/5U-CHP	0.157, 0.197	1.772	0.535	1.000	0.905	0.299	1.929	4.331	EFPR/L-4/5-045055
CTBU16-055-4/5U-CHP	0.157, 0.197	2.165	0.535	1.000	0.905	0.299	1.850	4.331	EFPR/L-4/5-055075
CTBU16-075-4/5U-CHP	0.157, 0.197	2.953	0.535	1.000	0.905	0.299	1.771	4.331	EFPR/L-4/5-075120
CTBU16-120-4/5U-CHP	0.157, 0.197	4.724	0.535	1.000	0.905	0.299	1.732	4.331	EFPR/L-4/5-120200
CTBU16-200-4/5U-CHP	0.157, 0.197	7.874	0.535	1.000	0.905	0.299	1.633	4.331	EFPR/L-4/5-200500
CTBU16-045-6U-CHP	0.236	1.772	0.535	1.000	0.905	0.299	2.007	4.331	EFPR/L-6-045055
CTBU16-055-6U-CHP	0.236	2.165	0.535	1.000	0.905	0.299	1.929	4.331	EFPR/L-6-055075
CTBU16-075-6U-CHP	0.236	2.953	0.535	1.000	0.905	0.299	1.850	4.331	EFPR/L-6-075120
CTBU16-120-6U-CHP	0.236	4.724	0.535	1.000	0.905	0.299	1.811	4.331	EFPR/L-6-120200
CTBU16-200-6U-CHP	0.236	7.874	0.535	1.000	0.905	0.299	1.712	4.331	EFPR/L-6-200500

SPARE PARTS

Designation	Clamp	Clamping screw	Wrench
CTBU**-CHP	CT-110	CM6X30-S	P-5

EASYM^{ULTI}CUT - Chipbreaker Guide

ETX type

Multi-functional insert
Grooving and turning suitable for light to medium cutting
Well-balanced sharpness and strength
CW = 0.157" - 0.236"

■ Standard feed

Feed: f (ipr)

Groove width: CW (in)

■ Standard feed and depth of cut for turning

Depth of cut ap (in)

Feed: f (ipr)

EGM type

1st choice for high feed
Well-designed edge
CW = 0.157"

■ Standard feed

Feed: f (ipr)

Groove width: CW (in)

Reference pages: Inserts, Standard cutting conditions → **F170**
Parts for coolant hose → **F240**

Grade
Insert
Toolholder
Ext. Toolholder
Int. Toolholder
Threading
Grooving
Miniature Tool
Milling Cutter
Endmill
Drilling Tool
User's Guide Tooling System
Index



INSERT

ETX

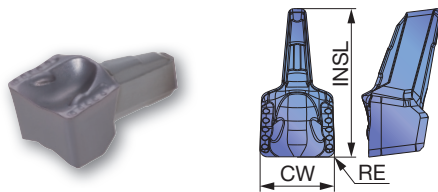

P Steel	★							
M Stainless	★							
K Cast iron	☆							
N Non-ferrous								
S Superalloys								
H Hard materials								

★ : First choice
☆ : Second choice

Designation	CW±0.05 (mm)	CW±0.002 (in)	RE (in)	Coated						INSL (in)
				AH725						
ETX4-040	4	0.157	0.016	●						0.315
ETX5-040	5	0.197	0.016	●						0.394
ETX6-040	6	0.236	0.016	●						0.472

● : Line up

EGM

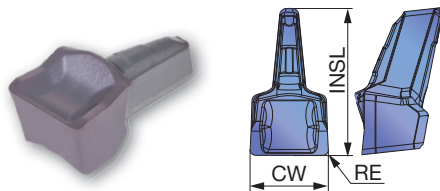

P Steel	★							
M Stainless	★							
K Cast iron	☆							
N Non-ferrous								
S Superalloys								
H Hard materials								

★ : First choice
☆ : Second choice

Designation	CW±0.05 (mm)	CW±0.002 (in)	RE (in)	Coated						INSL (in)
				AH725						
EGM4-030	4	0.157	0.012	●						0.315

● : Line up

STANDARD CUTTING CONDITIONS

ISO	Workpiece material	Hardness	Grade	Chipbreaker	Cutting speed Vc (sfm)
P	Low carbon steel 1018, 1020, 1026, etc.	- 300 HB	AH725	ETX	262 - 591
		- 300 HB	AH725	EGM	262 - 591
	Carbon steel, Alloy steel 1045, 1055, etc.	- 300 HB	AH725	ETX	262 - 591
		- 300 HB	AH725	EGM	262 - 591
	Prehardened steel NAK80, PX5, etc.	- 300 HB	AH725	ETX	262 - 591
- 300 HB		AH725	EGM	262 - 591	
M	Stainless steel 304SS, 316SS, 17-4 PH, etc.	-	AH725	ETX	164 - 394
		-	AH725	EGM	164 - 394

Reference pages: Toolholders → **F167 - F168**

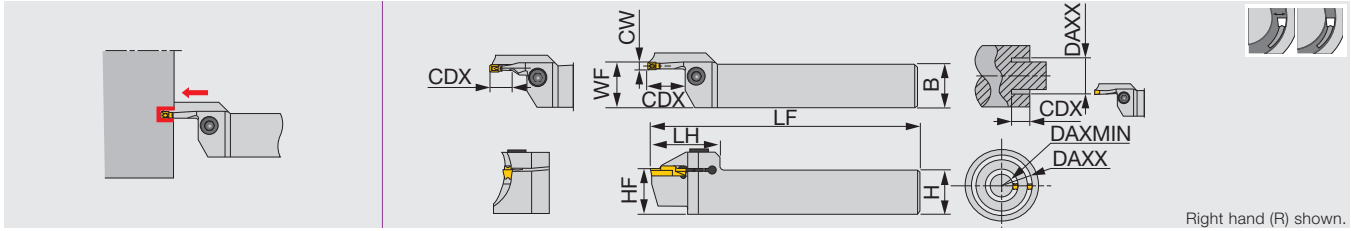

Metric	CW	DAXMIN	DAXX	Seat size	CDX	H	B	LF	LH	HF	WF ⁽¹⁾	Torque
CTFR/L2525-3T10-024035	3	24	35	3	10	25	25	150	38	25	25.5	5
CTFR/L2525-3T10-029040	3	29	40	3	10	25	25	150	38	25	25.5	5
CTFR/L2525-3T10-034050	3	34	50	3	10	25	25	150	38	25	25.5	5
CTFR/L2525-3T15-044070	3	44	70	3	15	25	25	150	38	25	25.5	5
CTFR/L2525-3T15-064100	3	64	100	3	15	25	25	150	38	25	25.5	5
CTFR/L2525-4T10-022036	4	22	36	4	10	25	25	150	39	25	25.6	5
CTFR/L2525-4T20-028042	4	28	42	4	20	25	25	150	39	25	25.6	5
CTFR/L2525-4T20-034050	4	34	50	4	20	25	25	150	39	25	25.6	5
CTFR/L2525-4T20-042070	4	42	70	4	20	25	25	150	39	25	25.6	5
CTFR/L2525-4T20-062120	4	62	120	4	20	25	25	150	39	25	25.6	5
CTFR/L2525-4T20-112200	4	112	200	4	20	25	25	150	39	25	25.6	5
CTFR/L2525-5T25-050080	5	50	80	5	25	25	25	150	49	25	25.6	12
CTFR/L2525-5T25-070110	5	70	110	5	25	25	25	150	49	25	25.6	12
CTFR/L2525-5T25-100150	5	100	150	5	25	25	25	150	49	25	25.6	12
CTFR/L2525-5T25-140200	5	140	200	5	25	25	25	150	49	25	25.6	12
CTFR/L2525-6T25-048070	6	48	70	6	25	25	25	150	49	25	25.6	12
CTFR/L2525-6T25-058100	6	58	100	6	25	25	25	150	49	25	25.6	12
CTFR/L2525-6T25-088180	6	88	180	6	25	25	25	150	49	25	25.6	12
CTFR/L2525-6T25-168400	6	168	400	6	25	25	25	150	49	25	25.6	12

When depth is deeper than (insert length - 1.5 mm), 1 corner type is recommended.
 Max. groove depth will be 15 mm with DTF insert.
 (1)WF is calculated with the groove width (CW) in the above table.
 Torque: Recommended clamping torque: N·m

SPARE PARTS

Designation	Clamping screw	Wrench
CTFR/L2525-3T - 4T...	CM6X1X25-A	P-5
CTFR/L2525-5T - 6T...	CM8X1.25X25-A	P-6

INSERT

Designation	Seat size	Insert
CTFR/L2525-3T10-024035	3	DTF, DTX
CTFR/L2525-3T10-029040	3	DTF, DTX
CTFR/L2525-3T10-034050	3	DTF, DTX
CTFR/L2525-3T15-044070	3	DTF, DTX, DTR, DTE, DGG, DTM
CTFR/L2525-3T15-064100	3	DTF, DTX, DTE, DGG, DGM, DGS, DTR, SGN, DGL, DTM
CTFR/L2525-4T10-022036	4	DTF, DTX
CTFR/L2525-4T20-028042	4	DTF, DTX, DTR
CTFR/L2525-4T20-034050	4	DTF, DTX, DTE, DGG, DGM, DGS, DTR, DTM, DGL
CTFR/L2525-4T20-042070	4	DTF, DTX, DTE, DGG, DGM, DGS, DTR, SGN, DTM, DGL
CTFR/L2525-4T20-062120	4	DTF, DTX, DTE, DGG, DGM, DGS, DTR, SGN, DTM, DGL
CTFR/L2525-4T20-112200	4	DTF, DTX, DTE, DGG, DGM, DGS, DTR, SGN, DTM, DGL
CTFR/L2525-5T25-...	5	DTX, DTE, DGG, DGM, DGS, DTR, DTM, DGL
CTFR/L2525-6T25-...	6	DTX, DTE, DGG, DGM, DGS, DTR, DTM, DGL

Insert	Groove width CW (mm)	Face grooving Min. machining dia. DAXMIN (mm)
DGM / DGS / SGN / DGL	3	92
DGM / DGS / SGN / DGL	4	37
DGM / DGS / DGL	5	60
DGM / DGS / DGL	6	57
DTE / DGG / DTM	3	62
DTE / DGG / DTM	4	42
DTE / DGG / DTM	5	64
DTE / DGG / DTM	6	61
DTR	3	44
DTR	4	32
DTR	5	48
DTR	6	48
DTX	3	22
DTX	4	20
DTX	5	20
DTX	6	23
DTF	3	20
DTF	4	20

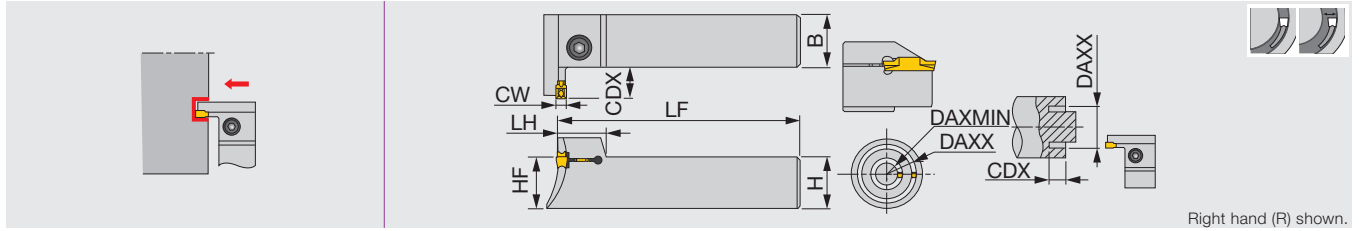

Metric	CW	DAXMIN	DAXX	Seat size	CDX	H	B	LF	LH	HF	Torque
CTFVR/L2525-3T10-024035	3	24	35	3	10	25	25	150	18	25	5
CTFVR/L2525-3T10-029040	3	29	40	3	10	25	25	150	18	25	5
CTFVR/L2525-3T10-034050	3	34	50	3	10	25	25	150	18	25	5
CTFVR/L2525-3T15-044060	3	44	60	3	15	25	25	150	18	25	5
CTFVR/L2525-3T15-054085	3	54	85	3	15	25	25	150	18	25	5
CTFVR/L2525-4T12-022040	4	22	40	4	12	25	25	150	18.5	25	8.5
CTFVR/L2525-4T15-032050	4	32	50	4	15	25	25	150	18.5	25	8.5
CTFVR/L2525-4T15-042060	4	42	60	4	15	25	25	150	18.5	25	8.5
CTFVR/L2525-4T15-052085	4	52	85	4	15	25	25	150	18.5	25	8.5
CTFVR/L2525-5T20-050080	5	50	80	5	20	25	25	150	22	25	12
CTFVR/L2525-5T20-070110	5	70	110	5	20	25	25	150	22	25	12
CTFVR/L2525-5T20-100150	5	100	150	5	20	25	25	150	22	25	12
CTFVR/L2525-5T20-140200	5	140	200	5	20	25	25	150	22	25	12
CTFVR/L2525-6T20-048085	6	48	85	6	20	25	25	150	22	25	12
CTFVR/L2525-6T20-073150	6	73	150	6	20	25	25	150	22	25	12
CTFVR/L2525-6T20-138250	6	138	250	6	20	25	25	150	22	25	12

When depth is deeper than (insert length - 1.5 mm), 1 corner type is recommended
 Max. groove depth will be 15 mm with DTF insert.
 Torque: Recommended clamping torque: N·m

SPARE PARTS

Designation	Clamping screw	Wrench
CTFVR/L2525-3T...	CM5X0.8X25-A	P-4
CTFVR/L2525-4T...	CM6X1X25-A	P-5
CTFVR/L2525-5T..., 6T...	CM8X1.25X25-A	P-6

INSERT

Designation	Seat size	Insert
CTFVR/L2525-3T10-024035	3	DTF, DTX
CTFVR/L2525-3T10-029040	3	DTF, DTX
CTFVR/L2525-3T10-034050	3	DTF, DTX, DTR
CTFVR/L2525-3T15-044060	3	DTF, DTX, DTE, DTR
CTFVR/L2525-3T15-054085	3	DTF, DTX, DTE, DGG, DTR, DTM
CTFVR/L2525-4T12-022040	4	DTF, DTX, DTR
CTFVR/L2525-4T15-032050	4	DTF, DTX, DTE, DGG, DGM, DGS, DTR, DTM, DGL
CTFVR/L2525-4T15-042060	4	DTF, DTX, DTE, DGG, DGM, DGS, DTR, SGN, DTM, DGL
CTFVR/L2525-4T15-052085	4	DTF, DTX, DTE, DGG, DGM, DGS, DTR, SGN, DTM, DGL
CTFVR/L2525-5T20-...	5	DTX, DTE, DGG, DGM, DGS, DTR, DTM, DGL
CTFVR/L2525-6T20-...	6	DTX, DTE, DGG, DGM, DGS, DTR, DTM, DGL

Insert	Groove width CW (mm)	Face grooving Min. machining dia. DAXMIN (mm)
DGM / DGS / SGN / DGL	3	92
DGM / DGS / SGN / DGL	4	37
DGM / DGS / DGL	5	60
DGM / DGS / DGL	6	57
DTE / DGG / DTM	3	62
DTE / DGG / DTM	4	42
DTE / DGG / DTM	5	64
DTE / DGG / DTM	6	61
DTR	3	44
DTR	4	32
DTR	5	48
DTR	6	48
DTX	3	22
DTX	4	20
DTX	5	20
DTX	6	23
DTF	3	20
DTF	4	20

External face grooving and turning toolholder

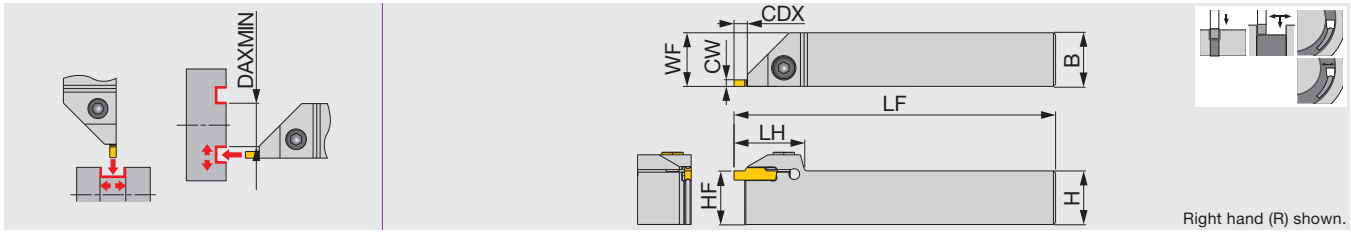

Right hand (R) shown.

Inch	CW (in)	CW (mm)	Seat size	CDX	HF	B	H	LF	WF ⁽¹⁾	LH	Torque
CTEFR/L12-4T04	0.157	4	2, 3, 4	0.189	0.750	0.750	0.750	5.000	0.770	1.300	6.27
CTEFR/L16-4T04	0.157	4	2, 3, 4	0.189	1.000	1.000	1.000	6.000	1.020	1.300	6.27
CTEFR/L12-6T04	0.236	6	5, 6	0.189	0.750	0.750	0.750	5.000	0.236	1.460	6.27
CTEFR/L16-6T04	0.236	6	5, 6	0.189	1.000	1.000	1.000	6.000	1.020	1.460	6.27

(1) "WF" value is calculated with groove width "CW" shown in the table.
Torque: Recommended clamping torque: lbs-ft

SPARE PARTS



Designation	Clamping screw	Wrench
CTEFR/L12-4T04	CM6X1X20-A	P-5
CTEFR/L16-4T04	CM6X1X25-A	P-5
CTEFR/L12-6T04	CM6X1X20-A	P-5
CTEFR/L16-6T04	CM6X1X25-A	P-5

Insert	Groove width CW (in)	Face grooving Min. machining dia. DAXMIN (in)
DGM / DGS / SGN	0.079	11.614
DGM / DGS / SGN / DGL	0.118	3.622
DGM / DGS / SGN / DGL	0.157	1.457
DGM / DGS / DGL	0.197	2.362
DGM / DGS / DGL	0.236	2.244
DTE / DGG / DTM	0.118	2.441
DTE / DGG / DTM	0.157	1.654
DTE / DGG / DTM	0.197	2.520
DTE / DGG / DTM	0.236	2.402

Insert	Groove width CW (in)	Face grooving Min. machining dia. DAXMIN (in)
DTR	0.118	1.732
DTR	0.157	1.260
DTR	0.197	1.890
DTR	0.236	1.890
DTX	0.118	0.866
DTX	0.157	0.787
DTX	0.197	0.787
DTX	0.236	0.906
DTF	0.118	0.787
DTF	0.157	0.787



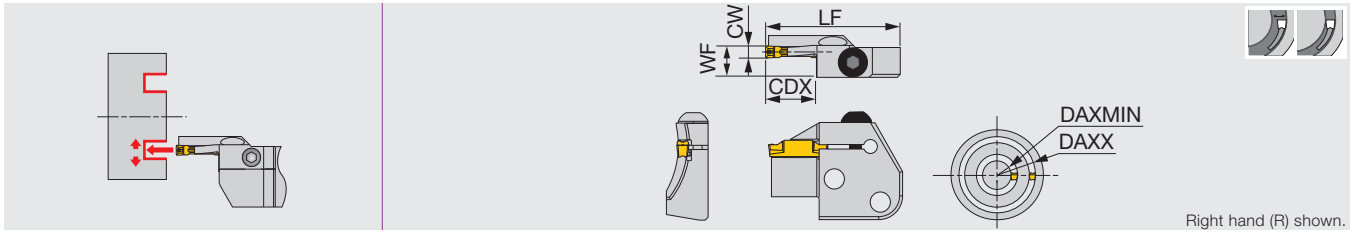

Inch	CW (in)	CW (mm)	DAXMIN	DAXX	Seat size	CDX	LF	WF (1)	Torque
CAFR/L-3T12-040055	0.118	3	1.575	2.17	3	0.472	1.772	0.409	3.69
CAFR/L-3T12-055075	0.118	3	2.165	2.95	3	0.472	1.772	0.409	3.69
CAFR/L-3T12-075100	0.118	3	2.953	3.94	3	0.472	1.772	0.409	3.69
CAFR/L-3T12-100140	0.118	3	3.937	5.51	3	0.472	1.772	0.409	3.69
CAFR/L-3T12-140200	0.118	3	5.512	7.87	3	0.472	1.772	0.409	3.69
CAFR/L-4T16-050070	0.157	4	1.969	2.76	4	0.630	1.772	0.413	3.69
CAFR/L-4T16-070100	0.157	4	2.756	3.94	4	0.630	1.772	0.413	3.69
CAFR/L-4T16-100150	0.157	4	3.937	5.91	4	0.630	1.772	0.413	3.69
CAFR/L-4T16-150250	0.157	4	5.906	9.84	4	0.630	1.772	0.413	3.69
CAFR/L-5T20-055080	0.197	5	2.165	3.15	5	0.787	1.929	0.413	3.69
CAFR/L-5T20-080120	0.197	5	3.15	4.72	5	0.787	1.929	0.413	3.69
CAFR/L-5T20-120180	0.197	5	4.724	7.09	5	0.787	1.929	0.413	3.69
CAFR/L-5T20-180300	0.197	5	7.087	11.81	5	0.787	1.929	0.413	3.69
CAFR/L-5T20-300000	0.197	5	11.811	0	5	0.787	1.929	0.413	3.69
CAFR/L-6T25-060090	0.236	6	2.362	3.54	6	0.984	2.165	0.413	3.69
CAFR/L-6T25-090150	0.236	6	3.543	5.91	6	0.984	2.165	0.413	3.69
CAFR/L-6T25-150250	0.236	6	5.906	9.84	6	0.984	2.165	0.413	3.69
CAFR/L-6T25-250400	0.236	6	9.843	15.75	6	0.984	2.165	0.413	3.69

When groove depth is larger than (insert length - 0.059"), please use 1-cornered insert.
 Max. groove depth will be 0.591" with DTF insert.
 Not compatible with TungModularSystem
 (1) WF is calculated with the groove width (CW) in the above table.
 (2) Not applicable to CAFR/L-3T12-040055
 (3) Seat sizes of DTF are only 3 and 4.
 Torque: Recommended clamping torque: lbs-ft

SPARE PARTS

Designation	Clamping screw	Wrench
CAFR/L...	BHM6-20-A	P-4

Insert	Groove width CW (in)	Face grooving Min. machining dia. DAXMIN (in)
DGM / DGS / SGN / DGL	0.118	3.622
DGM / DGS / SGN / DGL	0.157	1.457
DGM / DGS / DGL	0.197	2.362
DGM / DGS / DGL	0.236	2.244
DTE / DGG / DTM	0.118	2.441
DTE / DGG / DTM	0.157	1.654
DTE / DGG / DTM	0.197	2.520
DTE / DGG / DTM	0.236	2.402
DTR	0.118	1.732
DTR	0.157	1.260
DTR	0.197	1.890
DTR	0.236	1.890
DTX	0.118	0.866
DTX	0.157	0.787
DTX	0.197	0.787
DTX	0.236	0.906
DTF	0.118	0.787
DTF	0.157	0.787

Reference pages: Inserts → **F178 - F187**, Standard cutting conditions → **F192**

Shank for CAER/L and CAFR/L blades

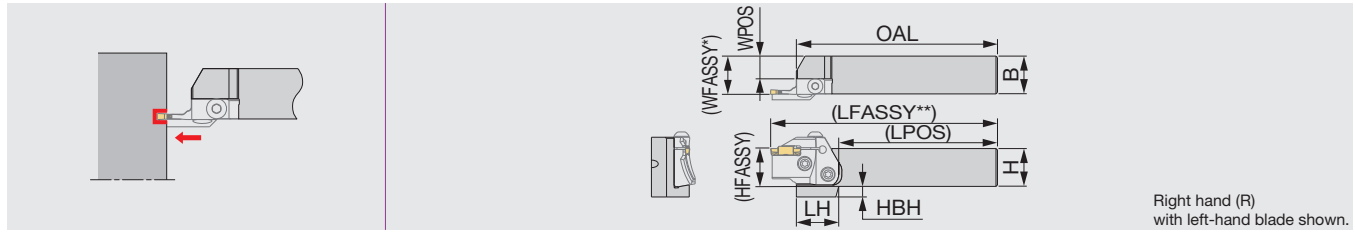

Inch	H	B	OAL	LPOS	LH	WPOS	HFASSY	HBH	Blade (Option)
CHSR/L12-U	0.750	0.750	5.330	4.227	1.380	0.356	0.750	0.502	CAFL/R...
CHSR/L16-U	1.000	1.000	5.330	4.227	1.100	0.606	1.000	0.280	CAFL/R...
CHSR/L20-U	1.250	1.250	6.330	5.227	-	0.856	1.250	-	CAFL/R...

Metric	H	B	OAL	LPOS	LH	WPOS	HFASSY	HBH	Blade (Option)
CHSR/L2020	20	20	133	105	35	10	20	12	CAFL/R...
CHSR/L2525	25	25	133	105	28	15	25	7	CAFL/R...
CHSR/L3232	32	32	153	105	-	22	32	-	CAFL/R...

*WFASSY : Shank (WPOS) + blade (WF) Not compatible with TungModularSystem
 **LFASSY : Shank (LPOS) + blade (LF)

SPARE PARTS

Designation	Clamping screw	Wrench
CHSR/L...	CSHB-6-A	P-4

Shank for CAER/L and CAFR/L blades

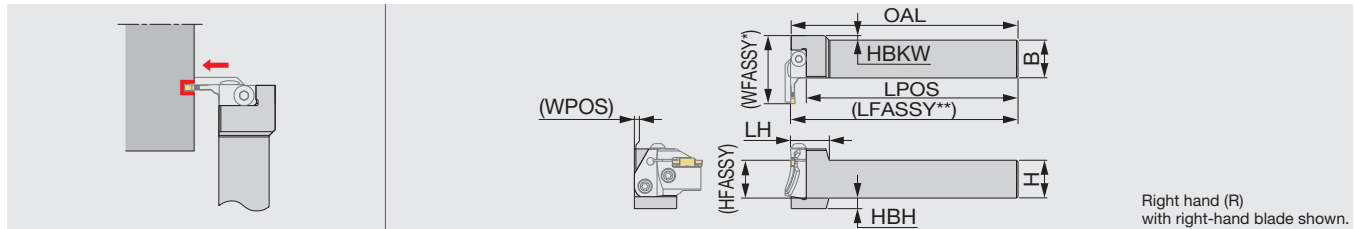

Inch	H	B	OAL	LPOS	LH	WPOS	HBKW	HFASSY	HBH	Blade (Option)
CHFVR/L12-U	0.750	0.750	6.000	5.606	0.984	-0.001	0.352	0.750	0.502	CAFR/L...
CHFVR/L16-U	1.000	1.000	6.000	5.606	0.984	-0.001	0.102	1.000	0.276	CAFR/L...
CHFVR/L20-U	1.250	1.250	7.000	6.606	0.984	0.147	-	1.250	-	CAFR/L...

Metric	H	B	OAL	LPOS	LH	WPOS	HBKW	HFASSY	HBH	Blade (Option)
CHFVR/L2020	20	20	150	140	25	0	8	20	12	CAFR/L...
CHFVR/L2525	25	25	150	140	25	0	3	25	7	CAFR/L...
CHFVR/L3232	32	32	170	160	25	4	-	32	-	CAFR/L...

*WFASSY : Shank (WPOS) + blade (LF) Not compatible with TungModularSystem
 **LFASSY : Shank (LPOS) + blade (WF)

SPARE PARTS

Designation	Clamping screw	Wrench
CHFVR/L...	CSHB-6-A	P-4

Combination of blade and toolholder

Toolholder	Blade			
	CAER...	CAEL...	CAFR...	CAFL...
CHSR...	●			●
CHSL...		●	●	
CHFVR...		●	●	
CHFVL...	●			●

● : Corresponding

Reference pages: Inserts → **F178 - F187**,
 Standard cutting conditions → **F192**



TungCap shank for CAER/L and CAFR/L blades

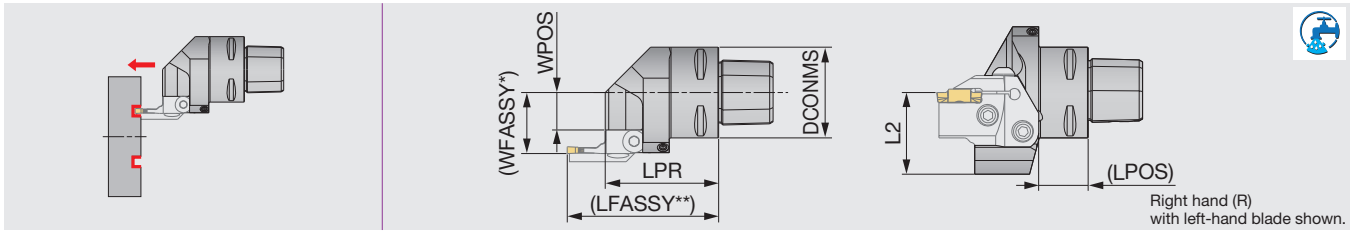

Metric	DCONMS	LPR	LPOS	L2	WPOS	Blade (Option)
C3CHSR/L22050N	32	50	22.1	35	11.5	CAFL/R...
C4CHSR/L27050N	40	50	22.1	36	16.5	CAFL/R...
C5CHSR/L35060N	50	60	32.1	36	24.5	CAFL/R...
C6CHSR/L45065N	63	65	32.1	41	34.5	CAFL/R...

*WFASSY : Shank (WPOS) + blade (WF)

**LFASSY : Shank (LPOS) + blade (LF)

Applicable for 7 MPa coolant.

Not compatible with TungModularSystem

SPARE PARTS

Designation	Coolant parts	Clamping screw	Wrench
C3CHSR/L22050N	SATZ-M8X1-M3	CSHB-6-A	P-4
C4CHSR/L27050N	SATZ-M8X1-M3	CSHB-6-A	P-4
C5CHSR/L35060N	SATZ-M10X1-M5	CSHB-6-A	P-4
C6CHSR/L45065N	SATZ-M10X1-M5	CSHB-6-A	P-4

External

Internal

Face

Parting

Others

C-CHFVR/L

TungCap shank for CAER/L and CAFR/L blades

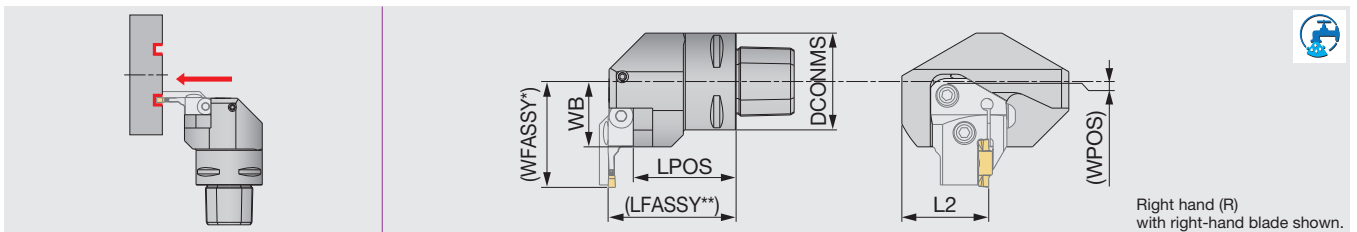

Metric	DCONMS	LPOS	L2	WB	WPOS	Blade (Option)
C3CHFVR/L22040N	32	32.5	35	22	-5.9	CAFR/L...
C4CHFVR/L27050N	40	42.5	36	27	-0.9	CAFR/L...
C5CHFVR/L35060N	50	49.5	36	35	7.1	CAFR/L...
C6CHFVR/L45065N	63	54.5	41	45	17.1	CAFR/L...

*WFASSY : Shank (WPOS) + blade (LF)

**LFASSY : Shank (LPOS) + blade (WF)

Applicable for 7 MPa coolant.

Not compatible with TungModularSystem

SPARE PARTS

Designation	Coolant parts	Clamping screw	Wrench
C3CHFVR/L22040N	SATZ-M8X1-M3	CSHB-6-A	P-4
C4CHFVR/L27050N	SATZ-M8X1-M3	CSHB-6-A	P-4
C5CHFVR/L35060N	SATZ-M10X1-M5	CSHB-6-A	P-4
C6CHFVR/L45065N	SATZ-M10X1-M5	CSHB-6-A	P-4

Combination of blade and toolholder

Toolholder	Blade			
	CAER...	CAEL...	CAFR...	CAFL...
C*CHSR...	●			●
C*CHSL...		●	●	
C*CHFVR...		●	●	
C*CHFVL...	●			●

● : Corresponding

Reference pages: Inserts → **F178 - F187**, Standard cutting conditions → **F192**

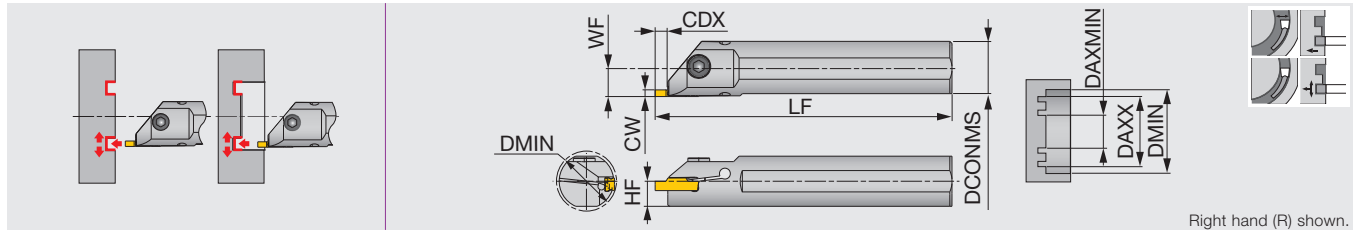

Inch	CW (in)	CW (mm)	Seat size	CDX	DCONMS	LF	HF	WF ⁽¹⁾	Torque
CTIFR/L16-4T05-D17	0.157	4	3, 4	0.217	1.000	8.000	0.450	0.531	3.69
CTIFR/L20-4T05-D22	0.157	4	3, 4	0.217	1.250	10.000	0.590	0.656	3.69
CTIFR/L16-5T05-D17	0.236	6	5, 6	0.217	1.000	8.000	0.450	0.531	3.69
CTIFR/L20-5T05-D22	0.236	6	5, 6	0.217	1.250	10.000	0.590	0.656	3.69

Metric	CW	Seat size	CDX	DCONMS	LF	HF	WF ⁽¹⁾	Torque*
CTIFR/L25-4T05-D270	4	3, 4	5.5	25	200	11.5	13.3	5
CTIFR/L32-4T05-D340	4	3, 4	5.5	32	250	15	16.8	5
CTIFR/L25-5T05-D270	6	5, 6	5.5	25	200	11.5	13.3	5
CTIFR/L32-5T05-D340	6	5, 6	5.5	32	250	15	16.8	5

(1) WF is calculated with the groove width (CW) in the above table.
Use the right-hand insert for the right-hand holder with DTF insert.
Torque: Recommended clamping torque: lbs-ft (*N·m)

Inch SPARE PARTS



Designation	Clamping screw	Wrench	Seal cap
CTIFR/L16-4T05-D17	CM6X1X16-A	P-5	CA-25
CTIFR/L20-4T05-D22	CM6X1X20-A	P-5	CA-32
CTIFR/L16-5T05-D17	CM6X1X16-A	P-5	CA-25
CTIFR/L20-5T05-D22	CM6X1X20-A	P-5	CA-32

Insert seat size	Minimum diameter	
	DCONMS = 0.984"	DCONMS = 1.259"
3	1.035	1.311
4	1.055	1.331
5	1.035	1.311
6	1.055	1.331

Insert seat size	DAXMIN				
	DGM, DGS	DTE, DGG	DTF, DTX	DTR	DAXX
3	2.126	1.732	0.787	1.614	∞
4	1.339	1.654	0.709	1.417	∞
5	1.929	1.969	0.787	2.126	∞
6	1.811	1.890	0.709	2.126	∞

Metric SPARE PARTS



Designation	Clamping screw	Wrench	Seal cap
CTIFR/L25-4T05-D270	CM6X1X16-A	P-5	CA-25
CTIFR/L32-4T05-D340	CM6X1X20-A	P-5	CA-32
CTIFR/L25-5T05-D270	CM6X1X16-A	P-5	CA-25
CTIFR/L32-5T05-D340	CM6X1X20-A	P-5	CA-32

Insert seat size	Minimum diameter	
	DCONMS = 25 mm	DCONMS = 32 mm
3	26.3	33.3
4	26.8	33.8
5	26.3	33.3
6	26.8	33.8

Insert seat size	DAXMIN				
	DGM, DGS	DTE, DGG	DTF, DTX	DTR	DAXX
3	92	62	19	44	∞
4	37	42	20	32	∞
5	60	64	20	48	∞
6	57	61	23	48	∞

INSERT

DTX

External/Internal face grooving and turning

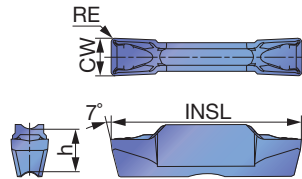

P	Steel	★	★	★	☆	☆			★			
M	Stainless	★		★	☆	★						
K	Cast iron	☆		★		☆			☆			
N	Non-ferrous											
S	Superalloys				★	☆						
H	Hard materials											

★ : First choice
☆ : Second choice

Designation	Seat size	CW±0.05 (mm)	CW±0.002 (in)	RE (in)	Coated					Cermets			INSL (in)	h (in)	
					T9225	T9125	AH7025	AH725	GH130	NS9530					
DTX3-030	3	3	0.118	0.012	●	▲	●	●	●		●			0.787	0.197
DTX4-040	4	4	0.157	0.016	●	▲	●	●	●		●			0.787	0.197
DTX5-040	5	5	0.197	0.016	●	▲	●	●	●		●			0.984	0.217
DTX6-080	6	6	0.236	0.031			●	●	●					0.984	0.197

● : Line up
▲ : To be discontinued

DTF

Face grooving and turning

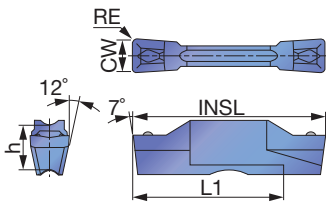

Right hand (R) shown.

P	Steel	★	☆	★	☆	☆			★			
M	Stainless	★		★	☆	★						
K	Cast iron	☆		★		☆			☆			
N	Non-ferrous											
S	Superalloys				★	☆						
H	Hard materials											

★ : First choice
☆ : Second choice

Designation	Seat size	HAND	CW±0.05 (mm)	CW±0.002 (in)	RE (in)	Coated					Cermets			INSL (in)	h (in)	L1 (in)	
						T9225	T9125	AH7025	AH725	GH130	NS9530						
DTF3-040-R	3	R	3	0.118	0.016	●	▲	●	●	●		●			0.787	0.197	0.630
DTF3-040-L	3	L	3	0.118	0.016	●	▲	●	●	●		●			0.787	0.197	0.630
DTF4-040-R	4	R	4	0.157	0.016	●	▲	●	●	●		●			0.787	0.197	0.630
DTF4-040-L	4	L	4	0.157	0.016	●	▲	●	●	●		●			0.787	0.197	0.630

● : Line up
▲ : To be discontinued

Reference pages: Toolholders → **F171 - F177**, Standard cutting conditions → **F192**

DTM

External face grooving and turning

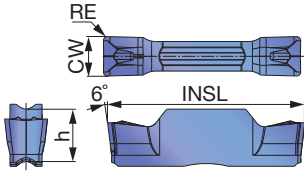

P	Steel	★								
M	Stainless	★								
K	Cast iron	★								
N	Non-ferrous									
S	Superalloys	★								
H	Hard materials									

★ : First choice
☆ : Second choice

Designation	Seat size	CW±0.05 (mm)	CW±0.002 (in)	RE (in)	Coated						INSL (in)	h (in)	
					AH7025								
DTM3-030	3	3	0.118	0.012	●							0.787	0.197
DTM4-040	4	4	0.157	0.016	●							0.787	0.197
DTM4-080	4	4	0.157	0.031	●							0.787	0.197
DTM5-080	5	5	0.197	0.031	●							0.984	0.217
DTM6-080	6	6	0.236	0.031	●							0.984	0.217
DTM8-080	8	8	0.315	0.031	●							1.181	0.264

● : Line up

DTE

External face grooving and turning (for high precision)

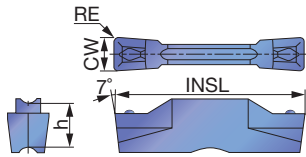

P	Steel	★	★	★	☆	☆				★			
M	Stainless	★		★	☆	★							
K	Cast iron	☆		★	☆								
N	Non-ferrous												
S	Superalloys				★	☆							
H	Hard materials												

★ : First choice
☆ : Second choice

Designation	Seat size	CW±0.02 (mm)	CW±0.0008 (in)	RE (in)	Coated					Cermet		INSL (in)	h (in)	
					T9225	T9125	AH7025	AH725	GH130	NS9530				
DTE265-015	3	2.65	0.104	0.006	●	▲	●	●	●		●		0.787	0.197
DTE300-020	3	3	0.118	0.008	●	▲	●	●	●		●		0.787	0.197
DTE300-040	3	3	0.118	0.016	●	▲	●	●	●		●		0.787	0.197
DTE315-015	3	3.15	0.124	0.006	●	▲	●	●	●		●		0.787	0.197
DTE400-040	4	4	0.157	0.016	●	▲	●	●	●		●		0.787	0.197
DTE400-080	4	4	0.157	0.031	●	▲	●	●	●		●		0.787	0.197
DTE415-015	4	4.15	0.163	0.006	●	▲	●	●	●		●		0.787	0.197
DTE478-055	5	4.78	0.188	0.022	●	▲	●	●	●		●		0.984	0.217
DTE500-040	5	5	0.197	0.016	●	▲	●	●	●		●		0.984	0.217
DTE500-080	5	5	0.197	0.031	●	▲	●	●	●		●		0.984	0.217
DTE515-015	5	5.15	0.203	0.006	●	▲	●	●	●				0.984	0.217
DTE600-080	6	6	0.236	0.031	●	▲	●	●	●				0.984	0.217
DTE600-120	6	6	0.236	0.047	●	▲	●	●	●				0.984	0.217
DTE800-080	8	8	0.315	0.031	●	▲	●	●	●				1.181	0.264
DTE800-120	8	8	0.315	0.047	●	▲	●	●	●				1.181	0.264

● : Line up
▲ : To be discontinued

Reference pages: Toolholders → **F171 - F177**, Standard cutting conditions → **F192**

Grade
Insert
Toolholder
Ext. Toolholder
Int. Toolholder
Threading
Grooving
Miniature Tool
Milling Cutter
Endmill
Drilling Tool
Tooling System
User's Guide
Index



DTE

External face grooving and turning

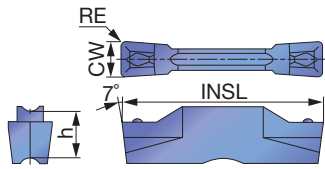

P	Steel	★	★		★	☆	☆			★			
M	Stainless	★			★	☆	★						
K	Cast iron	☆		★	★	☆							
N	Non-ferrous												
S	Superalloys				★	☆							
H	Hard materials												

★ : First choice
☆ : Second choice

Designation	Seat size	CW±0.05 (mm)	CW±0.002 (in)	RE (in)	Coated					Cermets			INSL (in)	h (in)		
					T9225	T9125	T515	AH7025	AH725	GH130	NS9530					
DTE3-040	3	3	0.118	0.016	●	▲	●	●	●	●		●			0.787	0.197
DTE4-040	4	4	0.157	0.016	●	▲	●	●	●	●		●			0.787	0.197
DTE5-040	5	5	0.197	0.016			●	●							0.984	0.217
DTE6-080	6	6	0.236	0.031			●	●							0.984	0.217

● : Line up
▲ : To be discontinued

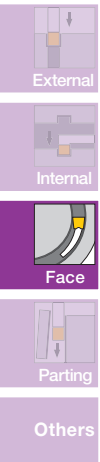

DGM

External grooving and parting, 2 corners

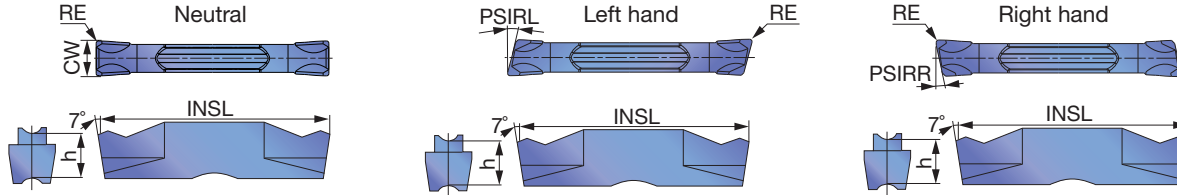

P	Steel	★	★	★	☆	☆	★					
M	Stainless	★		★	☆	★						
K	Cast iron	☆		★		☆	☆					
N	Non-ferrous											
S	Superalloys			★	☆	★						
H	Hard materials											

★ : First choice
☆ : Second choice

Designation	Seat size	HAND	CW±0.05 (mm)	CW±0.002 (in)	RE (in)	Coated						Cermets		INSL (in)	h (in)	PSIRL	PSIRR
						T9225	T9125	AH7025	AH725	AH905	GH130	NS9530					
DGM2-020	2	N	2	0.079	0.008	●	▲	●	●	●	●	●		0.787	0.197	0°	0°
DGM2-020-6R	2	R	2	0.079	0.008			●	●	●	●	●		0.780	0.197	0°	6°
DGM2-020-6L	2	L	2	0.079	0.008			●	●	●	●	●		0.780	0.197	6°	0°
DGM2-020-8R	2	R	2	0.079	0.008			●	●	●	●	●		0.780	0.197	0°	8°
DGM2-020-8L	2	L	2	0.079	0.008			●	●	●	●	●		0.780	0.197	8°	0°
DGM2-020-15R	2	R	2	0.079	0.008			●	●	●	●	●		0.780	0.197	0°	15°
DGM2-020-15L	2	L	2	0.079	0.008			●	●	●	●	●		0.780	0.197	15°	0°
DGM2-002-15R	2	R	2	0.079	0.0008			●	●	●	●	●		0.762	0.197	0°	15°
DGM2-002-15L	2	L	2	0.079	0.0008			●	●	●	●	●		0.762	0.197	15°	0°
DGM3-020	3	N	3	0.118	0.008	●	▲	●	●	●	●	●		0.787	0.197	0°	0°
DGM3-020-6R	3	R	3	0.118	0.008			●	●	●	●	●		0.783	0.197	0°	6°
DGM3-020-6L	3	L	3	0.118	0.008			●	●	●	●	●		0.783	0.197	6°	0°
DGM3-002-6R	3	R	3	0.118	0.0008			●	●	●	●	●		0.766	0.197	0°	6°
DGM3-002-6L	3	L	3	0.118	0.0008			●	●	●	●	●		0.766	0.197	6°	0°
DGM3-020-15R	3	R	3	0.118	0.008			●	●	●	●	●		0.783	0.197	0°	15°
DGM3-020-15L	3	L	3	0.118	0.008			●	●	●	●	●		0.783	0.197	15°	0°
DGM4-030	4	N	4	0.157	0.012	●	▲	●	●	●	●	●		0.787	0.197	0°	0°
DGM4-030-4R	4	R	4	0.157	0.012			●	●	●	●	●		0.780	0.197	0°	4°
DGM4-030-4L	4	L	4	0.157	0.012			●	●	●	●	●		0.780	0.197	4°	0°
DGM4-030-15R	4	R	4	0.157	0.012			●	●	●	●	●		0.780	0.197	0°	15°
DGM4-030-15L	4	L	4	0.157	0.012			●	●	●	●	●		0.780	0.197	15°	0°
DGM5-030	5	N	5	0.197	0.012	●	▲	●	●	●	●	●		0.984	0.217	0°	0°
DGM5-030-4R	5	R	5	0.197	0.012			●	●	●	●	●		0.980	0.217	0°	4°
DGM6-030	6	N	6	0.236	0.012	●	▲	●	●	●	●	●		0.984	0.217	0°	0°
DGM8-040	8	N	8	0.315	0.016	●	▲	●	●	●	●	●		1.181	0.264	0°	0°

● : Line up
▲ : To be discontinued

Grade
Insert
Toolholder
Ext. Toolholder
Int. Toolholder
Threading
Grooving
Miniature Tool
Milling Cutter
Endmill
Drilling Tool
Tooling System
User's Guide
Index



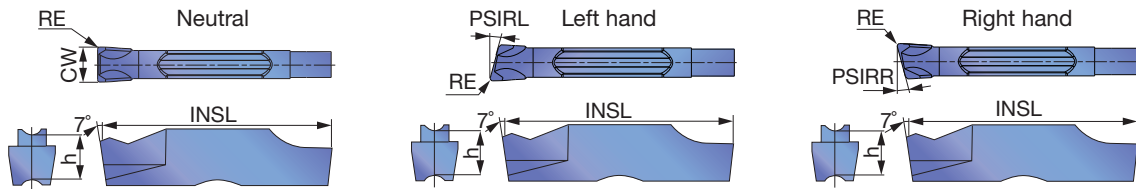

P	Steel	★	☆	☆								
M	Stainless	★	☆	★								
K	Cast iron	★		☆								
N	Non-ferrous											
S	Superalloys	★	☆									
H	Hard materials											

★ : First choice
☆ : Second choice

Designation	Seat size	HAND	CW±0.05 (mm)	CW±0.002 (in)	RE (in)	Coated			INSL (in)	h (in)	PSIRL	PSIRR
						AH7025	AH725	GH130				
SGM2-020	2	N	2	0.079	0.008	●	●	●	0.787	0.197	0°	0°
SGM2-020-6R	2	R	2	0.079	0.008	●	●	●	0.787	0.197	0°	6°
SGM2-020-6L	2	L	2	0.079	0.008	●	●	●	0.787	0.197	6°	0°
SGM3-020	3	N	3	0.118	0.008	●	●	●	0.787	0.197	0°	0°
SGM3-020-6R	3	R	3	0.118	0.008	●	●	●	0.787	0.197	0°	6°
SGM3-020-6L	3	L	3	0.118	0.008	●	●	●	0.787	0.197	6°	0°
SGM3-020-15R	3	R	3	0.118	0.008	●	●	●	0.787	0.197	0°	15°
SGM3-020-15L	3	L	3	0.118	0.008	●	●	●	0.787	0.197	15°	0°
SGM4-030	4	N	4	0.157	0.012	●	●	●	0.787	0.197	0°	0°
SGM4-030-4R	4	R	4	0.157	0.012	●	●	●	0.787	0.197	0°	4°
SGM4-030-4L	4	L	4	0.157	0.012	●	●	●	0.787	0.197	4°	0°
SGM5-030	5	N	5	0.197	0.012	●	●	●	0.984	0.217	0°	0°
SGM6-030	6	N	6	0.236	0.012	●	●	●	0.984	0.217	0°	0°

● : Line up

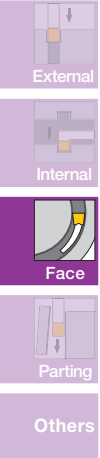

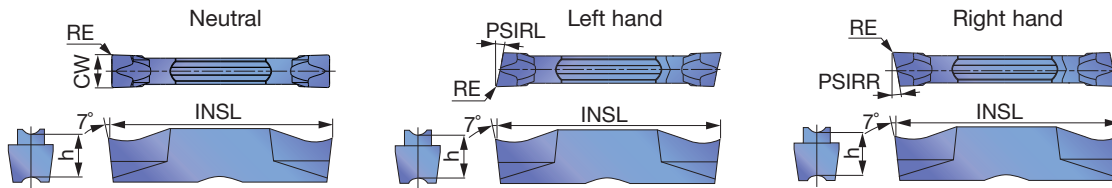

P	Steel	★	★	★	☆	☆			★				
M	Stainless	★		★	☆	★							
K	Cast iron	☆		★	☆				☆				
N	Non-ferrous												
S	Superalloys			★	☆								
H	Hard materials												

★ : First choice
☆ : Second choice

Designation	Seat size	HAND	CW±0.05 (mm)	CW±0.002 (in)	RE (in)	Coated					Cermet		INSL (in)	h (in)	PSIRL	PSIRR
						T9225	T9125	AH7025	AH725	GH130	NS9530					
DGS1.4-016	1	N	1.4	0.055	0.006								0.630	0.169	0°	0°
DGS2-020	2	N	2	0.079	0.008	●	▲	●	●	●	●		0.787	0.197	0°	0°
DGS2-020-6R	2	R	2	0.079	0.008			●	●	●			0.785	0.197	0°	6°
DGS2-020-6L	2	L	2	0.079	0.008			●	●	●			0.785	0.197	6°	0°
DGS2-002-6R	2	R	2	0.079	0.0008			●	●	●			0.768	0.197	0°	6°
DGS2-002-6L	2	L	2	0.079	0.0008			●	●	●			0.768	0.197	6°	0°
DGS2-020-15R	2	R	2	0.079	0.008			●	●	●			0.785	0.197	0°	15°
DGS2-020-15L	2	L	2	0.079	0.008			●	●	●			0.785	0.197	15°	0°
DGS2-002-15R	2	R	2	0.079	0.0008			●	●	●			0.768	0.197	0°	15°
DGS2-002-15L	2	L	2	0.079	0.0008			●	●	●			0.768	0.197	15°	0°
DGS3-020	3	N	3	0.118	0.008	●	▲	●	●	●	●		0.787	0.197	0°	0°
DGS3-020-6R	3	R	3	0.118	0.008			●	●	●			0.783	0.197	0°	6°
DGS3-020-6L	3	L	3	0.118	0.008			●	●	●			0.783	0.197	6°	0°
DGS3-002-6R	3	R	3	0.118	0.0008			●	●	●			0.766	0.197	0°	6°
DGS3-002-6L	3	L	3	0.118	0.0008			●	●	●			0.766	0.197	6°	0°
DGS3-020-15R	3	R	3	0.118	0.008			●	●	●			0.783	0.197	0°	15°
DGS3-020-15L	3	L	3	0.118	0.008			●	●	●			0.783	0.197	15°	0°
DGS3-002-15R	3	R	3	0.118	0.0008			●	●	●			0.766	0.197	0°	15°
DGS3-002-15L	3	L	3	0.118	0.0008			●	●	●			0.766	0.197	15°	0°
DGS4-030	4	N	4	0.157	0.012	●	▲	●	●	●	●		0.787	0.197	0°	0°
DGS4-030-4R	4	R	4	0.157	0.012			●	●	●			0.780	0.197	0°	4°
DGS4-030-4L	4	L	4	0.157	0.012			●	●	●			0.781	0.197	4°	0°
DGS5-030	5	N	5	0.197	0.012	●	▲	●	●	●	●		0.984	0.217	0°	0°
DGS6-030	6	N	6	0.236	0.012	●	▲	●	●	●	●		0.984	0.217	0°	0°

● : Line up
▲ : To be discontinued

Caution

The tool will interfere with the workpiece when grooving larger diameter than øDmax.

Designation	øDmax (in)	Designation	øDmax (in)
DGM2-002-15R/L	1.102	DGS2-002-15R/L	1.102
DGM3-002-15R/L	1.141	DGS3-002-15R/L	1.141
DGM4-030-15R/L	1.181	SGS3-020-15R/L	4.055
SGM3-020-15R/L	4.055	SGS3-002-15R/L	1.338

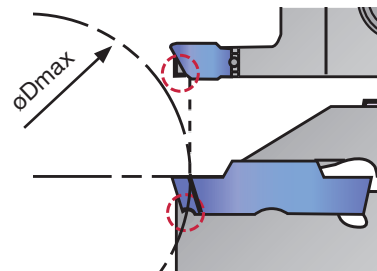

SGS

External deep grooving and parting, 1 corner

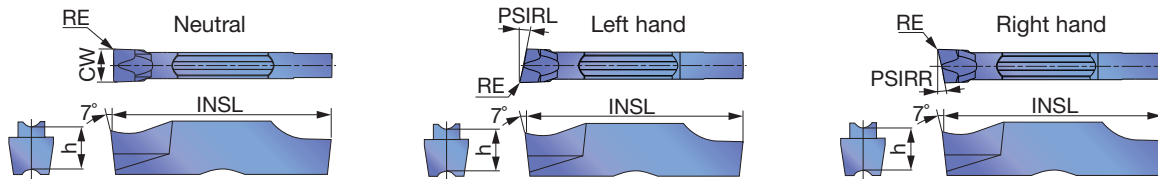

P	Steel	★	☆	☆									
M	Stainless	★	☆	★									
K	Cast iron	★		☆									
N	Non-ferrous												
S	Superalloys	★	☆										
H	Hard materials												

★ : First choice
☆ : Second choice

Designation	Seat size	HAND	CW±0.05 (mm)	CW±0.002 (in)	RE (in)	Coated						INSL (in)	h (in)	PSIRL	PSIRR	
						AH7025	AH725	GH130								
SGS2-020	2	N	2	0.079	0.008	●	●	●					0.787	0.197	0°	0°
SGS2-020-6R	2	R	2	0.079	0.008	●	●	●					0.787	0.197	0°	6°
SGS2-020-6L	2	L	2	0.079	0.008	●	●	●					0.787	0.197	6°	0°
SGS2-020-15R	2	R	2	0.079	0.008	●	●	●					0.787	0.197	0°	15°
SGS2-020-15L	2	L	2	0.079	0.008	●	●	●					0.787	0.197	15°	0°
SGS3-020	3	N	3	0.118	0.008	●	●	●					0.787	0.197	0°	0°
SGS3-020-6R	3	R	3	0.118	0.008	●	●	●					0.787	0.197	0°	6°
SGS3-020-6L	3	L	3	0.118	0.008	●	●	●					0.787	0.197	6°	0°
SGS3-002-6R	3	R	3	0.118	0.0008		●	●					0.780	0.197	0°	6°
SGS3-002-6L	3	L	3	0.118	0.0008		●	●					0.780	0.197	6°	0°
SGS3-020-15R	3	R	3	0.118	0.008	●	●	●					0.787	0.197	0°	15°
SGS3-020-15L	3	L	3	0.118	0.008	●	●	●					0.787	0.197	15°	0°
SGS3-002-15R	3	R	3	0.118	0.0008		●	●					0.780	0.197	0°	15°
SGS3-002-15L	3	L	3	0.118	0.0008		●	●					0.780	0.197	15°	0°
SGS4-030	4	N	4	0.157	0.012	●	●	●					0.787	0.197	0°	0°
SGS5-030	5	N	5	0.197	0.012	●	●	●					0.984	0.217	0°	0°
SGS6-030	6	N	6	0.236	0.012	●	●	●					0.984	0.217	0°	0°

● : Line up

DGG

External grooving (for high precision)

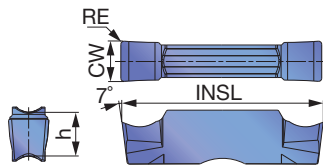

P	Steel	★		★									
M	Stainless	★											
K	Cast iron	★		☆		☆							
N	Non-ferrous									★			
S	Superalloys	★								☆			
H	Hard materials												

★ : First choice
☆ : Second choice

Designation	Seat size	CW±0.02 (mm)	CW±0.0008 (in)	RE (in)	Coated			Cermet			Uncoated			INSL (in)	h (in)
					AH7025			NS9530			KS05F				
DGG200-020	2	2	0.079	0.008	●			●			●			0.787	0.197
DGG300-020	3	3	0.118	0.008	●			●			●			0.787	0.197
DGG400-040	4	4	0.157	0.016	●			●			●			0.787	0.197
DGG500-040	5	5	0.197	0.016	●			●			●			0.984	0.217
DGG600-040	6	6	0.236	0.016	●			●			●			0.984	0.217

● : Line up

Reference pages: Toolholders → **F171 - F177**, Standard cutting conditions → **F192**

DGL

External grooving and parting

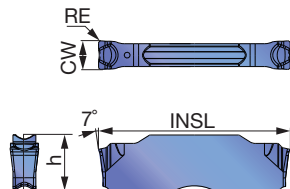

P	Steel	★								
M	Stainless	★								
K	Cast iron	★								
N	Non-ferrous									
S	Superalloys	★								
H	Hard materials									

★ : First choice
☆ : Second choice

Designation	Seat size	CW±0.05 (mm)	CW±0.002 (in)	RE (in)	Coated						INSL (in)	h (in)
					AH7025							
DGL3-025	3	3	0.118	0.010	●						0.787	0.197
DGL4-030	4	4	0.157	0.012	●						0.787	0.197
DGL5-030	5	5	0.197	0.012	●						0.984	0.217
DGL6-080	6	6	0.236	0.031	●						0.984	0.217

● : Line up

DTR

Profiling and undercutting (for high precision)

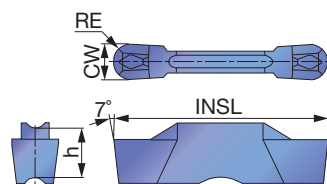

P	Steel	★	★	★	☆	☆			★			
M	Stainless	★		★	☆	★						
K	Cast iron	☆		★	☆	☆			☆			
N	Non-ferrous											
S	Superalloys			★	☆							
H	Hard materials											

★ : First choice
☆ : Second choice

Designation	Seat size	CW±0.02 (mm)	CW±0.0008 (in)	RE (in)	Coated					Cermets		INSL (in)	h (in)
					T9225	T9125	AH7025	AH725	GH130	NS9530			
DTR300-150	3	3	0.118	0.059	●	▲	●	●	●		●	0.787	0.197
DTR400-200	4	4	0.157	0.079	●	▲	●	●	●		●	0.787	0.197
DTR478-239	5	4.78	0.188	0.094	●	▲	●	●	●		●	0.984	0.217
DTR500-250	5	5	0.197	0.098	●	▲	●	●	●		●	0.984	0.217
DTR600-300	6	6	0.236	0.118	●	▲	●	●	●			0.984	0.217

● : Line up
▲ : To be discontinued

Reference pages: Toolholders → **F171 - F177**, Standard cutting conditions → **F192**



DTR

Profiling and undercutting

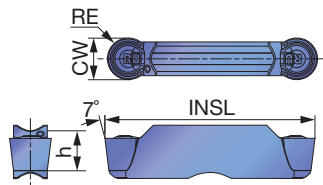

P Steel	★	★	★	☆	☆		★			
M Stainless	★		★	☆		★				
K Cast iron	☆		★		☆	☆	☆			
N Non-ferrous										
S Superalloys			★	☆	★					
H Hard materials										

★ : First choice
☆ : Second choice

Designation	Seat size	CW±0.05 (mm)	CW±0.002 (in)	RE (in)	Coated						Cermets		INSL (in)	h (in)	
					T9225	T9125	AH7025	AH725	AH905	GH130	NS9530				
DTR3-150	3	3	0.118	0.059	●	▲	●	●	●	●		●		0.787	0.197
DTR4-200	4	4	0.157	0.079	●	▲	●	●	●	●		●		0.787	0.197
DTR5-250	5	5	0.197	0.098	●	▲	●	●	●	●		●		0.984	0.217
DTR6-300	6	6	0.236	0.118	●	▲	●	●	●	●				0.984	0.217
DTR8-400	8	8	0.315	0.157	●	▲	●	●	●	●				1.181	0.264

● : Line up
▲ : To be discontinued

DTIU

Profiling and undercutting (for high precision)

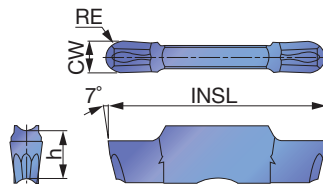

P Steel	★	☆	☆							
M Stainless	★	☆	★							
K Cast iron	★		☆							
N Non-ferrous										
S Superalloys	★	☆								
H Hard materials										

★ : First choice
☆ : Second choice

Designation	Seat size	CW±0.02 (mm)	CW±0.0008 (in)	RE (in)	Coated							INSL (in)	h (in)	
					AH7025	AH725	GH130							
DTIU300-150	3	3	0.118	0.059	●	●	●						0.787	0.197
DTIU400-200	4	4	0.157	0.079	●	●	●						0.787	0.197
DTIU500-250	5	5	0.197	0.098	●	●	●						0.984	0.217
DTIU600-300	6	6	0.236	0.118	●	●	●						0.984	0.217

● : Line up

Reference pages: Toolholders → **F171 - F177**, Standard cutting conditions → **F192**

DTA

Aluminum wheel machining (for high precision)

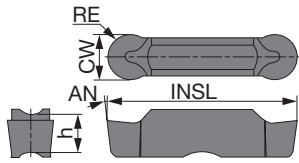

P	Steel					
M	Stainless					
K	Cast iron					
N	Non-ferrous	★				
S	Superalloys					
H	Hard materials					

★ : First choice
☆ : Second choice

Designation	Seat size	CW±0.02 (mm)	CW±0.0008 (in)	RE (in)	Uncoated							INSL (in)	h (in)	AN
					TH10									
DTA600-300	6	6	0.236	0.118	●							0.984	0.217	7°
DTA800-400	8	8	0.315	0.157	●							1.181	0.264	10°

● : Line up

SGN

External grooving of hardened steel

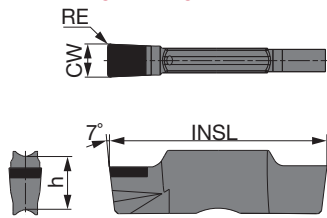

P	Steel					
M	Stainless					
K	Cast iron					
N	Non-ferrous					
S	Superalloys					
H	Hard materials	★				

★ : First choice
☆ : Second choice

Designation	Seat size	CW±0.025 (mm)	CW±0.001 (in)	RE (in)	CBN							INSL (in)	h (in)
					BX360								
SGN200-020	2	2	0.079	0.008	●							0.787	0.197
SGN300-020	3	3	0.118	0.008	●							0.787	0.197
SGN400-020	4	4	0.157	0.008	●							0.787	0.197

● : Line up



Face grooving and turning

DTX type (2 corners)

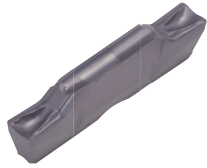

F178 page

Multi-functional type

Well balanced sharpness and strength
Multi-functional insert
CW = 0.118" - 0.236"

Standard feed and DoC

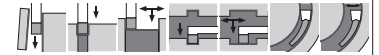
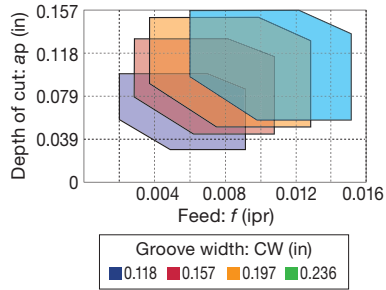

Standard feed

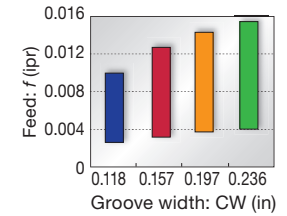

DTF type (2 corners)

First choice

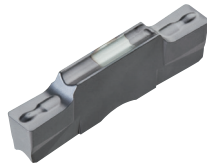

F178 page

1st choice for face grooving

Unique chipbreaker makes chips shorter
Molded and ground insert available
CW = 0.118" - 0.157"

Standard feed and DoC

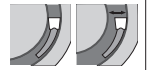
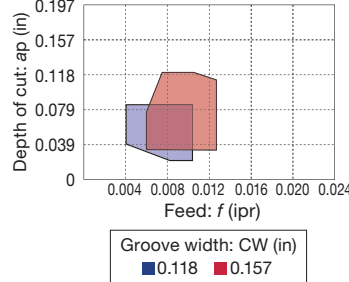

Standard feed

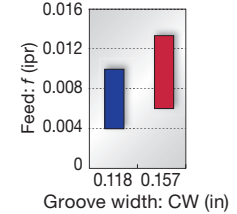

DTM type (2 corners)



F179 page

General purpose

1st choice for grooving and turning
Suitable for light to medium cutting
Excellent chip control in machining steel, alloy steel, stainless steel, and heat-resistant alloy
CW = 0.118" - 0.315"

Standard feed and DoC

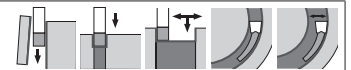
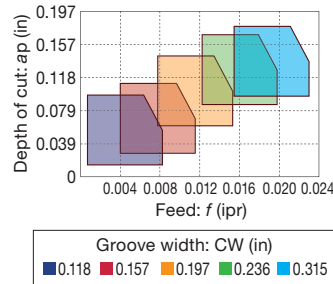

Standard feed

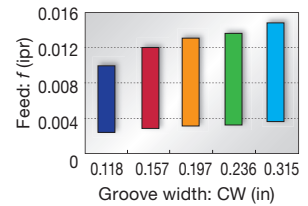

DTE type (2 corners)



F179, F180 page

General purpose

Unique chipbreaker makes chips shorter
Molded and ground inserts available
CW = 0.118" - 0.315"



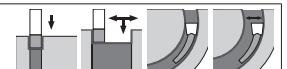
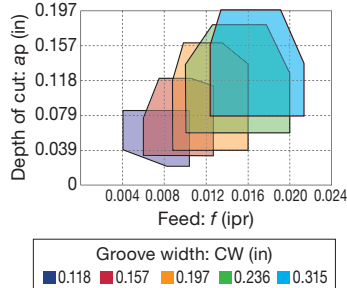

Standard feed and DoC

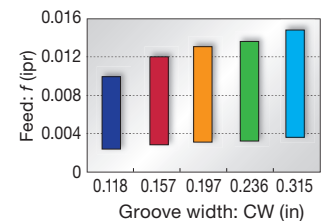

Standard feed

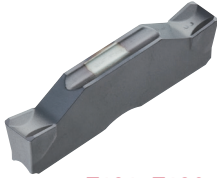
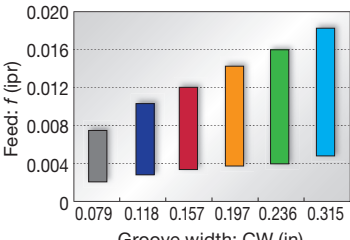
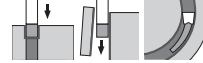

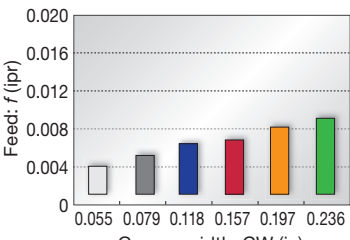
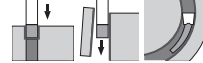
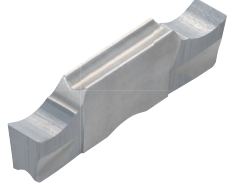
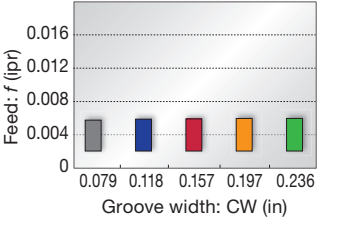
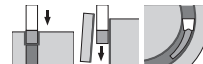
Grooving

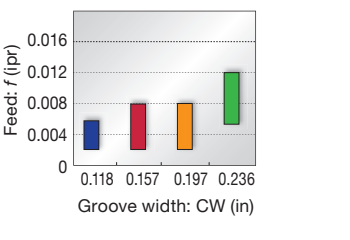
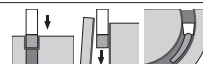
<p>DGM type (2 corners) SGM type (1 corner)</p>  <p>F181, F182 page</p>	<p>1st choice for grooving and parting</p> <p>Smooth chip evacuation Well-designed edge with high strength Handed insert available CW = 0.079" - 0.315"</p>	<p>■ Standard feed</p> 	
<p>DGS type (2 corners) SGS type (1 corner)</p>  <p>F183, F184 page</p>	<p>Lower cutting force and superior sharpness</p> <p>Unique-designed edge and chipbreaker Handed insert available CW = 0.055" - 0.236"</p>	<p>■ Standard feed</p> 	
<p>DGG type (2 corners)</p>  <p>F184 page</p>	<p>For non-ferrous materials and titanium</p> <p>Chipbreaker with low cutting force Sharp cutting edge that prevents vibration and delivers fine surface finish CW = 0.079" - 0.236"</p>	<p>■ Standard feed</p> 	
<p>DGL type (2 corners)</p>  <p>F185 page</p>	<p>1st choice for mild steel</p> <p>Chipbreaker with excellent chip control at low feed Suitable for mild steel that often has difficulties with chip control CW = 0.118" - 0.236"</p>	<p>■ Standard feed</p> 	

A
B
C
D
E
F
G
H
I
J
K
L
M

Profiling and undercutting

DTR type (2 corners)

Molded



Ground



F185, F186 page

Full radius type

Excellent chip control
Molded and ground inserts available
CW = 0.118" - 0.315"

Standard feed and DoC

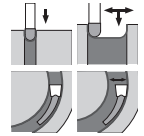
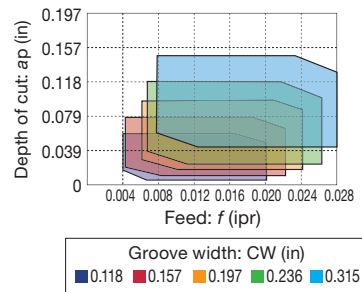

DTIU type (2 corners)

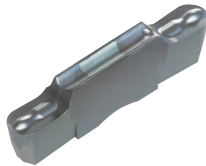

F186 page

Full radius type

Excellent chip control
For undercutting
CW = 0.118" - 0.236"

Standard feed and DoC

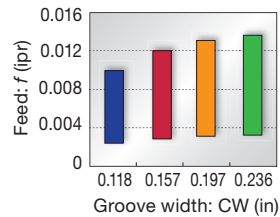

External

Internal

Face

Parting

Others

Aluminum wheel machining

DTA type (2 corners)

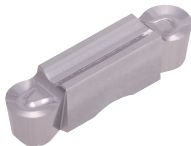

F187 page

Full radius type

Excellent chip control
For aluminum wheel profiling
Ground insert
CW = 0.236" - 0.315"

Standard feed and DoC

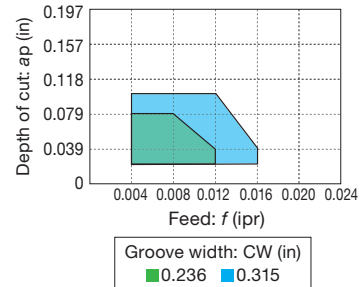

External grooving of hardened steel

SGN-CBN type (1 corner)

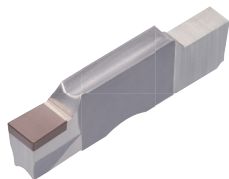

F187 page

For hardened steel cutting

Optimum cutting edge shape for grooving of hardened steels
High tolerance width for finishing
CW = 0.079" - 0.157"
(CW = ±0.001")

Standard feed

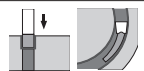
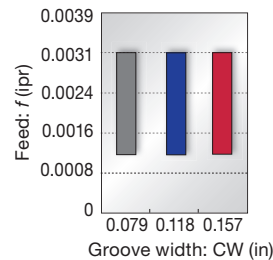

AH7025 Cutting performance

First choice grade for grooving

AH7025 grade: Tungaloy's unique coating technology for drastically improved reliability

Tool life comparison



Tool wear after 60 grooves

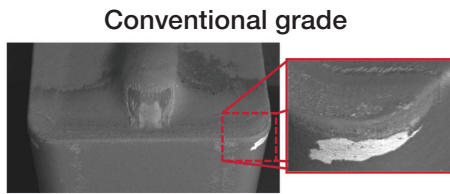

Tool wear after 30 grooves

P Alloy steel
(4140)

Insert : DTE3-040 AH7025
Cutting speed: $V_c = 492$ sfm
Feed : $f = 0.007$ ipr
Groove depth : 0.669"
Machining : External grooving
Coolant : Wet

AH7025 provides stability, while preventing coating from peeling off even after machining twice the number of passes compared to the conventional grade.

→ **The combination of Nano-multi-layered AlTiN Coating with high Al content and tough substrate provides highly efficient machining in various grooving operations.**

Grades

AH7025 **P M K S**

- First choice for various applications
- New PVD coating with high Al content provides excellent adhesion strength
- Improved wear and chipping resistance

AH725 **P M S**

- Recommended for various applications
- Newly developed coating with well controlled crystal structure and fracture resistance
- Improved adhesion strength

T515 **K**

- First recommended grade for cast iron
- Excellent wear resistance in high-speed machining

T9225 **P**

- Suitable for steel machining at high speeds
- New CVD coating and substrate deliver an outstanding balance of wear and chipping resistance

NS9530 **P**

- Advanced cermet for finish cutting of steel
- Innovative grade with incredible fracture and high wear resistance

GH130 **P M K**

- Recommended for interrupted machining
- TiCNO PVD coating layer with high wear resistance
- High hardness wear resistance

AH905 **S**

- Remarkable for machining of heat resistant alloys
- Exclusive coating layer improves adhesion strength and wear resistance

KS05F **N S**

- Recommended for non-ferrous materials and titanium

TH10 **N**

- Recommended for non-ferrous materials

BX360 **H**

- Suitable for hardened steel machining
- Ideal balance of wear and chipping resistance due to the optimum CBN content and grain size

Grade
Insert
Ext. Toolholder
Int. Toolholder
Threading
Grooving
Miniature Tool
Milling Cutter
Endmill
Drilling Tool
Tooling System
User's Guide
Index



STANDARD CUTTING CONDITIONS

ISO	Workpiece material	Hardness	Priority	Grade	Cutting speed Vc (sfm)
P	Steel 1045, 4135, etc.	< 300 HB	First choice	AH7025, AH725	164 - 591
		< 300 HB	Priority for wear resistance	T9225	262 - 984
		< 300 HB	Priority for impact resistance	GH130	164 - 394
		< 300 HB	Priority for surface finish	NS9530	262 - 722
M	Stainless steel 304SS, 316SS, 17-4 PH, etc.	< 200 HB	First choice	AH7025, AH725	164 - 394
		< 200 HB	Priority for impact resistance	GH130	164 - 394
K	Gray cast iron No.250B, No.300B, etc.	-	First choice	T515, AH7025	164 - 591
		-	Priority for impact resistance	GH130	164 - 591
	Ductile cast iron 60-40-18, 60-55-06, etc.	-	First choice	T515, AH7025	164 - 394
		-	Priority for impact resistance	GH130	164 - 394
N	Aluminum alloys Si < 12%	-	First choice	TH10	328 - 1640
		-	First choice	KS05F	328 - 1969
S	Superalloys Inconel 718, etc.	< HRC 40	First choice	AH7025	66 - 197
		< HRC 40	Priority for wear resistance	AH905	66 - 262
	Titanium alloys Ti-6Al-4V, etc.	< HRC 40	First choice	AH905	66 - 262
		< HRC 40	Priority for impact resistance	AH7025, AH725	66 - 262
		< HRC 40	Priority for surface finish	KS05F	66 - 197
H	Hardened steel 4137, etc.	> HRC 50	First choice	BX360	262 - 492

*See page F189 - F190 for feed: f (ipr).

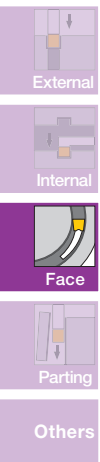

MY-T SERIES

#S/D##R/L+CGWSR/L

Blade for face grooving and turning toolholders (CGWSR/L-#S/D, CGWTR/L-#S/D)

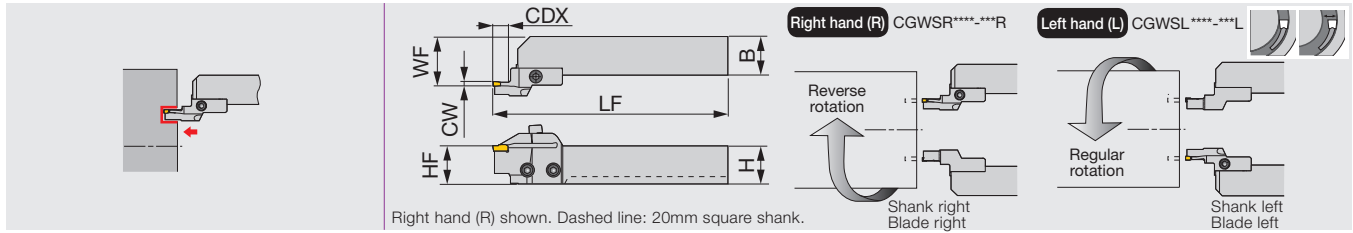

Inch	CW	DAXN	DAXX	CDX	H	B	LF	HF	WF	Insert	Shank	Torque
30S3040R/L	0.118	1.181	1.575	0.393	0.750/1.0	0.750/1.0	5.906	0.750/1.0	2.057	G*30, GE30-AL	CGWSR/L...	3.69
30S4050R/L	0.118	1.575	1.696	0.393	0.750/1.0	0.750/1.0	5.906	0.750/1.0	2.057	G*30, GE30-AL	CGWSR/L...	3.69
30S5065R/L	0.118	1.696	2.559	0.393	0.750/1.0	0.750/1.0	5.906	0.750/1.0	2.057	G*30, GE30-AL	CGWSR/L...	3.69
30S6590R/L	0.118	2.559	3.543	0.393	0.750/1.0	0.750/1.0	5.906	0.750/1.0	2.057	G*30, GE30-AL	CGWSR/L...	3.69
30S90150R/L	0.118	3.543	5.906	0.393	0.750/1.0	0.750/1.0	5.906	0.750/1.0	2.057	G*30, GE30-AL	CGWSR/L...	3.69
30S150500R/L	0.118	5.906	19.685	0.393	0.750/1.0	0.750/1.0	5.906	0.750/1.0	2.057	G*30, GE30-AL	CGWSR/L...	3.69
40S3545R/L	0.157	1.378	1.772	0.551	0.750/1.0	0.750/1.0	5.906	0.750/1.0	2.057	G*40, GE40-AL	CGWSR/L...	3.69
40S4555R/L	0.157	1.772	2.165	0.551	0.750/1.0	0.750/1.0	5.906	0.750/1.0	2.057	G*40, GE40-AL	CGWSR/L...	3.69
40S5580R/L	0.157	2.165	3.150	0.551	0.750/1.0	0.750/1.0	5.906	0.750/1.0	2.057	G*40, GE40-AL	CGWSR/L...	3.69
40S80140R/L	0.157	3.150	5.512	0.551	0.750/1.0	0.750/1.0	5.906	0.750/1.0	2.057	G*40, GE40-AL	CGWSR/L...	3.69
40S140500R/L	0.157	5.512	19.685	0.551	0.750/1.0	0.750/1.0	5.906	0.750/1.0	2.057	G*40, GE40-AL	CGWSR/L...	3.69
40D3545R/L	0.157	1.378	1.772	0.866	0.750/1.0	0.750/1.0	5.906	0.750/1.0	2.372	G*40, GE40-AL	CGWSR/L...	3.69
40D4555R/L	0.157	1.772	2.165	0.866	0.750/1.0	0.750/1.0	5.906	0.750/1.0	2.372	G*40, GE40-AL	CGWSR/L...	3.69
40D5580R/L	0.157	2.165	3.150	0.866	0.750/1.0	0.750/1.0	5.906	0.750/1.0	2.372	G*40, GE40-AL	CGWSR/L...	3.69
40D80140R/L	0.157	3.150	5.512	0.866	0.750/1.0	0.750/1.0	5.906	0.750/1.0	2.372	G*40, GE40-AL	CGWSR/L...	3.69
40D140500R/L	0.157	5.512	19.685	0.866	0.750/1.0	0.750/1.0	5.906	0.750/1.0	2.372	G*40, GE40-AL	CGWSR/L...	3.69
50S3545R/L	0.197	1.378	1.772	0.551	0.750/1.0	0.750/1.0	5.906	0.750/1.0	2.057	G*50	CGWSR/L...	3.69
50S4555R/L	0.197	1.772	2.165	0.551	0.750/1.0	0.750/1.0	5.906	0.750/1.0	2.057	G*50	CGWSR/L...	3.69
50S5575R/L	0.197	2.165	2.953	0.551	0.750/1.0	0.750/1.0	5.906	0.750/1.0	2.057	G*50	CGWSR/L...	3.69
50S75130R/L	0.197	2.953	5.118	0.551	0.750/1.0	0.750/1.0	5.906	0.750/1.0	2.057	G*50	CGWSR/L...	3.69
50S130500R/L	0.197	5.118	19.685	0.551	0.750/1.0	0.750/1.0	5.906	0.750/1.0	2.057	G*50	CGWSR/L...	3.69
50D3545R/L	0.197	1.378	1.772	0.866	0.750/1.0	0.750/1.0	5.906	0.750/1.0	2.372	G*50	CGWSR/L...	3.69
50D4555R/L	0.197	1.772	2.165	0.866	0.750/1.0	0.750/1.0	5.906	0.750/1.0	2.372	G*50	CGWSR/L...	3.69
50D5575R/L	0.197	2.165	2.953	0.866	0.750/1.0	0.750/1.0	5.906	0.750/1.0	2.372	G*50	CGWSR/L...	3.69
50D75130R/L	0.197	2.953	5.118	0.866	0.750/1.0	0.750/1.0	5.906	0.750/1.0	2.372	G*50	CGWSR/L...	3.69
50D130500R/L	0.197	5.118	19.685	0.866	0.750/1.0	0.750/1.0	5.906	0.750/1.0	2.372	G*50	CGWSR/L...	3.69

Toolholders are in stock with the designations of: a set of shank and blade; a shank; a blade. Combining the designations of a blade and a shank will make the designation of a set. Please check the stock and place an order with the designation of a set or a shank+a blade.
Use right-hand blades (CGWSR~) with right-hand shanks ~(R); and left-hand blades (CGWSL~) with left-hand shanks (~L).
Torque: Recommended clamping torque: lbs·ft

Designation	Clamping screw	Blade screw	Wrench
30S..., 40S...	CHHM5-18	CSHB-6	P-4
40D...	CM5X0.8X16	CSHB-6	P-4
50S...	CHHM5-18	CSHB-6	P-4
50D...	CM5X0.8X16	CSHB-6	P-4

Reference pages: Inserts → **F200 - F202**, Standard cutting conditions → **F205**

MY-T SERIES

#S/D##R/L+CGWSR/L

Blade for face grooving and turning toolholders (CGWSR/L-#S/D, CGWTR/L-#S/D)

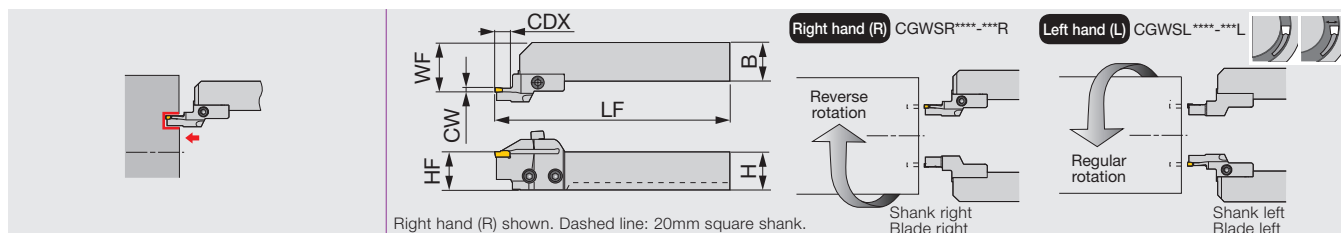

Metric	CW	DAXN	DAXX	CDX	H	B	LF	HF	WF	Insert	Shank	Torque
30S3040R/L	3	30	40	10	20/25	20/25	152.5	20/25	27/32	G*30, GE30-AL	CGWSR/L...	5
30S4050R/L	3	40	50	10	20/25	20/25	152.5	20/25	27/32	G*30, GE30-AL	CGWSR/L...	5
30S5065R/L	3	50	65	10	20/25	20/25	152.5	20/25	27/32	G*30, GE30-AL	CGWSR/L...	5
30S6590R/L	3	65	90	10	20/25	20/25	152.5	20/25	27/32	G*30, GE30-AL	CGWSR/L...	5
30S90150R/L	3	90	150	10	20/25	20/25	152.5	20/25	27/32	G*30, GE30-AL	CGWSR/L...	5
30S150500R/L	3	150	500	10	20/25	20/25	152.5	20/25	27/32	G*30, GE30-AL	CGWSR/L...	5
40S3545R/L	4	35	45	14	20/25	20/25	152.5	20/25	27/32	G*40, GE40-AL	CGWSR/L...	5
40S4555R/L	4	45	55	14	20/25	20/25	152.5	20/25	27/32	G*40, GE40-AL	CGWSR/L...	5
40S5580R/L	4	55	80	14	20/25	20/25	152.5	20/25	27/32	G*40, GE40-AL	CGWSR/L...	5
40S80140R/L	4	80	140	14	20/25	20/25	152.5	20/25	27/32	G*40, GE40-AL	CGWSR/L...	5
40S140500R/L	4	140	500	14	20/25	20/25	152.5	20/25	27/32	G*40, GE40-AL	CGWSR/L...	5
40D3545R/L	4	35	45	22	20/25	20/25	160.5	20/25	27/32	G*40, GE40-AL	CGWSR/L...	5
40D4555R/L	4	45	55	22	20/25	20/25	160.5	20/25	27/32	G*40, GE40-AL	CGWSR/L...	5
40D5580R/L	4	55	80	22	20/25	20/25	160.5	20/25	27/32	G*40, GE40-AL	CGWSR/L...	5
40D80140R/L	4	80	140	22	20/25	20/25	160.5	20/25	27/32	G*40, GE40-AL	CGWSR/L...	5
40D140500R/L	4	140	500	22	20/25	20/25	160.5	20/25	27/32	G*40, GE40-AL	CGWSR/L...	5
50S3545R/L	5	35	45	14	20/25	20/25	152.5	20/25	27/32	G*50	CGWSR/L...	5
50S4555R/L	5	45	55	14	20/25	20/25	152.5	20/25	27/32	G*50	CGWSR/L...	5
50S5575R/L	5	55	75	14	20/25	20/25	152.5	20/25	27/32	G*50	CGWSR/L...	5
50S75130R/L	5	75	130	14	20/25	20/25	152.5	20/25	27/32	G*50	CGWSR/L...	5
50S130500R/L	5	130	500	14	20/25	20/25	152.5	20/25	27/32	G*50	CGWSR/L...	5
50D3545R/L	5	35	45	22	20/25	20/25	160.5	20/25	27/32	G*50	CGWSR/L...	5
50D4555R/L	5	45	55	22	20/25	20/25	160.5	20/25	27/32	G*50	CGWSR/L...	5
50D5575R/L	5	55	75	22	20/25	20/25	160.5	20/25	27/32	G*50	CGWSR/L...	5
50D75130R/L	5	75	130	22	20/25	20/25	160.5	20/25	27/32	G*50	CGWSR/L...	5
50D130500R/L	5	130	500	22	20/25	20/25	160.5	20/25	27/32	G*50	CGWSR/L...	5

Toolholders are in stock with the designations of: a set of shank and blade; a shank; a blade. Combining the designations of a blade and a shank will make the designation of a set. Please check the stock and place an order with the designation of a set or a shank+blade.
Use right-hand blades (CGWSR~) with right-hand shanks ~(R); and left-hand blades (CGWSL~) with left-hand shanks (~L).
Torque: Recommended clamping torque: N·m

SPARE PARTS	Clamping screw	Blade screw	Wrench
30S..., 40S...	CHHM5-18	CSHB-6	P-4
40D...	CM5X0.8X16	CSHB-6	P-4
50S...	CHHM5-18	CSHB-6	P-4
50D...	CM5X0.8X16	CSHB-6	P-4

Reference pages: Inserts → **F200 - F202**, Standard cutting conditions → **F205**



MY-T SERIES

#S/D##R/L+CGWTR/L

Blade for face grooving and turning toolholders (CGWSR/L-#S/D, CGWTR/L-#S/D)

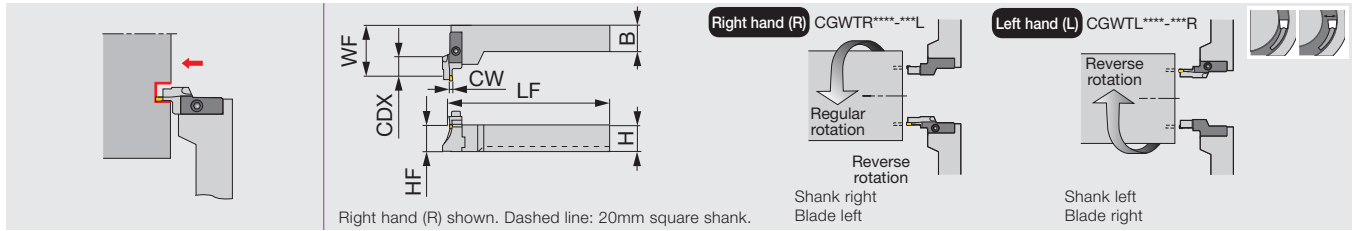

Inch	CW	DAXN	DAXX	CDX	H	B	LF	HF	WF	Insert	Shank	Torque
30S3040R/L	0.118	1.181	1.575	0.393	0.750/1.0	0.750/1.0	5.906	0.750/1.0	2.057	G*30, GE30-AL	CGWTL/R...	3.69
30S4050R/L	0.118	1.575	1.696	0.393	0.750/1.0	0.750/1.0	5.906	0.750/1.0	2.057	G*30, GE30-AL	CGWTL/R...	3.69
30S5065R/L	0.118	1.696	2.559	0.393	0.750/1.0	0.750/1.0	5.906	0.750/1.0	2.057	G*30, GE30-AL	CGWTL/R...	3.69
30S6590R/L	0.118	2.559	3.543	0.393	0.750/1.0	0.750/1.0	5.906	0.750/1.0	2.057	G*30, GE30-AL	CGWTL/R...	3.69
30S90150R/L	0.118	3.543	5.906	0.393	0.750/1.0	0.750/1.0	5.906	0.750/1.0	2.057	G*30, GE30-AL	CGWTL/R...	3.69
30S150500R/L	0.118	5.906	19.685	0.393	0.750/1.0	0.750/1.0	5.906	0.750/1.0	2.057	G*30, GE30-AL	CGWTL/R...	3.69
40S3545R/L	0.157	1.378	1.772	0.551	0.750/1.0	0.750/1.0	5.906	0.750/1.0	2.057	G*40, GE40-AL	CGWTL/R...	3.69
40S4555R/L	0.157	1.772	2.165	0.551	0.750/1.0	0.750/1.0	5.906	0.750/1.0	2.057	G*40, GE40-AL	CGWTL/R...	3.69
40S5580R/L	0.157	2.165	3.150	0.551	0.750/1.0	0.750/1.0	5.906	0.750/1.0	2.057	G*40, GE40-AL	CGWTL/R...	3.69
40S80140R/L	0.157	3.150	5.512	0.551	0.750/1.0	0.750/1.0	5.906	0.750/1.0	2.057	G*40, GE40-AL	CGWTL/R...	3.69
40S140500R/L	0.157	5.512	19.685	0.551	0.750/1.0	0.750/1.0	5.906	0.750/1.0	2.057	G*40, GE40-AL	CGWTL/R...	3.69
40D3545R/L	0.157	1.378	1.772	0.866	0.750/1.0	0.750/1.0	5.906	0.750/1.0	2.372	G*40, GE40-AL	CGWTL/R...	3.69
40D4555R/L	0.157	1.772	2.165	0.866	0.750/1.0	0.750/1.0	5.906	0.750/1.0	2.372	G*40, GE40-AL	CGWTL/R...	3.69
40D5580R/L	0.157	2.165	3.150	0.866	0.750/1.0	0.750/1.0	5.906	0.750/1.0	2.372	G*40, GE40-AL	CGWTL/R...	3.69
40D80140R/L	0.157	3.150	5.512	0.866	0.750/1.0	0.750/1.0	5.906	0.750/1.0	2.372	G*40, GE40-AL	CGWTL/R...	3.69
40D140500R/L	0.157	5.512	19.685	0.866	0.750/1.0	0.750/1.0	5.906	0.750/1.0	2.372	G*40, GE40-AL	CGWTL/R...	3.69
50S3545R/L	0.197	1.378	1.772	0.551	0.750/1.0	0.750/1.0	5.906	0.750/1.0	2.057	G*50	CGWTL/R...	3.69
50S4555R/L	0.197	1.772	2.165	0.551	0.750/1.0	0.750/1.0	5.906	0.750/1.0	2.057	G*50	CGWTL/R...	3.69
50S5575R/L	0.197	2.165	2.953	0.551	0.750/1.0	0.750/1.0	5.906	0.750/1.0	2.057	G*50	CGWTL/R...	3.69
50S75130R/L	0.197	2.953	5.118	0.551	0.750/1.0	0.750/1.0	5.906	0.750/1.0	2.057	G*50	CGWTL/R...	3.69
50S130500R/L	0.197	5.118	19.685	0.551	0.750/1.0	0.750/1.0	5.906	0.750/1.0	2.057	G*50	CGWTL/R...	3.69
50D3545R/L	0.197	1.378	1.772	0.866	0.750/1.0	0.750/1.0	5.906	0.750/1.0	2.372	G*50	CGWTL/R...	3.69
50D4555R/L	0.197	1.772	2.165	0.866	0.750/1.0	0.750/1.0	5.906	0.750/1.0	2.372	G*50	CGWTL/R...	3.69
50D5575R/L	0.197	2.165	2.953	0.866	0.750/1.0	0.750/1.0	5.906	0.750/1.0	2.372	G*50	CGWTL/R...	3.69
50D75130R/L	0.197	2.953	5.118	0.866	0.750/1.0	0.750/1.0	5.906	0.750/1.0	2.372	G*50	CGWTL/R...	3.69
50D130500R/L	0.197	5.118	19.685	0.866	0.750/1.0	0.750/1.0	5.906	0.750/1.0	2.372	G*50	CGWTL/R...	3.69

Toolholders are in stock with the designations of: a set of shank and blade; a shank; a blade. Combining the designations of a blade and a shank will make the designation of a set. Please check the stock and place an order with the designation of a set or a shank+a blade. Use right-hand shanks (CGWTR~) with left-hand blades (~L); and left-hand shanks (CGWTL~) with right-hand blades (~R). Torque: Recommended clamping torque: lbs·ft

SPARE PARTS			
Designation	Clamping screw	Blade screw	Wrench
30S..., 40S...	CHHM5-18	CSHB-6	P-4
40D...	CM5X0.8X16	CSHB-6	P-4
50S...	CHHM5-18	CSHB-6	P-4
50D...	CM5X0.8X16	CSHB-6	P-4

Reference pages: Inserts → **F200 - F202**, Standard cutting conditions → **F205**

MY-T SERIES

#S/D##R/L+CGWTR/L

Blade for face grooving and turning toolholders (CGWSR/L-#S/D, CGWTR/L-#S/D)

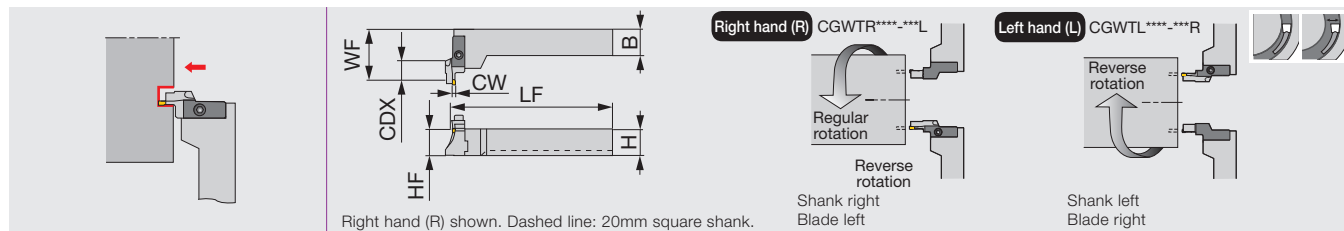

Right hand (R) shown. Dashed line: 20mm square shank.

Metric	CW	DAXN	DAXX	CDX	H	B	LF	HF	WF	Insert	Shank	Torque
30S3040R/L	3	30	40	10	20/25	20/25	150	20/25	52.25	G*30, GE30-AL	CGWTL/R...	5
30S4050R/L	3	40	50	10	20/25	20/25	150	20/25	52.25	G*30, GE30-AL	CGWTL/R...	5
30S5065R/L	3	50	65	10	20/25	20/25	150	20/25	52.25	G*30, GE30-AL	CGWTL/R...	5
30S6590R/L	3	65	90	10	20/25	20/25	150	20/25	52.25	G*30, GE30-AL	CGWTL/R...	5
30S90150R/L	3	90	150	10	20/25	20/25	150	20/25	52.25	G*30, GE30-AL	CGWTL/R...	5
30S150500R/L	3	150	500	10	20/25	20/25	150	20/25	52.25	G*30, GE30-AL	CGWTL/R...	5
40S3545R/L	4	35	45	14	20/25	20/25	150	20/25	52.25	G*40, GE40-AL	CGWTL/R...	5
40S4555R/L	4	45	55	14	20/25	20/25	150	20/25	52.25	G*40, GE40-AL	CGWTL/R...	5
40S5580R/L	4	55	80	14	20/25	20/25	150	20/25	52.25	G*40, GE40-AL	CGWTL/R...	5
40S80140R/L	4	80	140	14	20/25	20/25	150	20/25	52.25	G*40, GE40-AL	CGWTL/R...	5
40S140500R/L	4	140	500	14	20/25	20/25	150	20/25	52.25	G*40, GE40-AL	CGWTL/R...	5
40D3545R/L	4	35	45	22	20/25	20/25	150	20/25	60.25	G*40, GE40-AL	CGWTL/R...	5
40D4555R/L	4	45	55	22	20/25	20/25	150	20/25	60.25	G*40, GE40-AL	CGWTL/R...	5
40D5580R/L	4	55	80	22	20/25	20/25	150	20/25	60.25	G*40, GE40-AL	CGWTL/R...	5
40D80140R/L	4	80	140	22	20/25	20/25	150	20/25	60.25	G*40, GE40-AL	CGWTL/R...	5
40D140500R/L	4	140	500	22	20/25	20/25	150	20/25	60.25	G*40, GE40-AL	CGWTL/R...	5
50S3545R/L	5	35	45	14	20/25	20/25	150	20/25	52.25	G*50	CGWTL/R...	5
50S4555R/L	5	45	55	14	20/25	20/25	150	20/25	52.25	G*50	CGWTL/R...	5
50S5575R/L	5	55	75	14	20/25	20/25	150	20/25	52.25	G*50	CGWTL/R...	5
50S75130R/L	5	75	130	14	20/25	20/25	150	20/25	52.25	G*50	CGWTL/R...	5
50S130500R/L	5	130	500	14	20/25	20/25	150	20/25	52.25	G*50	CGWTL/R...	5
50D3545R/L	5	35	45	22	20/25	20/25	150	20/25	60.25	G*50	CGWTL/R...	5
50D4555R/L	5	45	55	22	20/25	20/25	150	20/25	60.25	G*50	CGWTL/R...	5
50D5575R/L	5	55	75	22	20/25	20/25	150	20/25	60.25	G*50	CGWTL/R...	5
50D75130R/L	5	75	130	22	20/25	20/25	150	20/25	60.25	G*50	CGWTL/R...	5
50D130500R/L	5	130	500	22	20/25	20/25	150	20/25	60.25	G*50	CGWTL/R...	5

Toolholders are in stock with the designations of: a set of shank and blade; a shank; a blade. Combining the designations of a blade and a shank will make the designation of a set. Please check the stock and place an order with the designation of a set or a shank+blade. Use right-hand shanks (CGWTR~) with left-hand blades (~L); and left-hand shanks (CGWTL~) with right-hand blades (~R). Torque: Recommended clamping torque: N·m

SPARE PARTS			
Designation	Clamping screw	Blade screw	Wrench
30S..., 40S...	CHHM5-18	CSHB-6	P-4
40D...	CM5X0.8X16	CSHB-6	P-4
50S...	CHHM5-18	CSHB-6	P-4
50D...	CM5X0.8X16	CSHB-6	P-4

Reference pages: Inserts → **F200 - F202**, Standard cutting conditions → **F205**

MY-T SERIES

CGWSR/L

Shank for CGWSR/L-WG, -WG-L, -G, -CGD, -FL-G/TP, and -#S/D toolholders

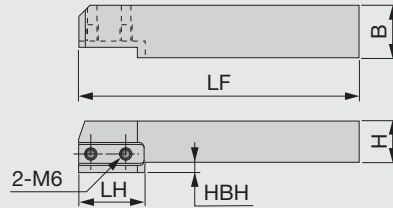

Right hand (R) shown.

Inch	H	B	LF	LH	HBH
CGWSR/L12	0.75	0.75	5.40	1.280	0.197
CGWSR/L16	1.00	1.00	5.40	1.280	0.197

Metric	H	B	LF	LH	HBH
CGWSR/L2020	20	20	137	32.5	5
CGWSR/L2525	25	25	137	-	-

Note: Right hand tool holders (R) use right hand cartridges (R). Left hand tool holders (L) use left hand cartridges (L).

SPARE PARTS



Designation	Blade screw
CGWSR/L...	CSHB-6

MY-T SERIES

CGWSRL

Shank of toolholders. Vertical type with offset

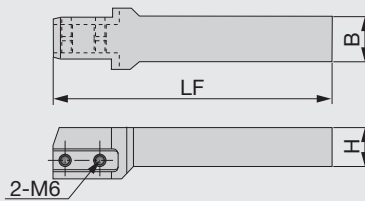

Inch	H	B	LF
CGWSRL12	0.75	0.75	5.40
CGWSRL16	1.00	1.00	5.40

Note: Right (R) or Left (L) hand cartridges can be used in this toolholder

SPARE PARTS



Designation	Blade screw
CGWSRL...	CSHB-6

Reference pages: Inserts → **F200 - F202**, Standard cutting conditions → **F205**

MY-T SERIES

CGWTR/L

Shank for CGWSR/L-WG, -WG-L, -G, -CGD, -FL-G/TP, and #S/D toolholders

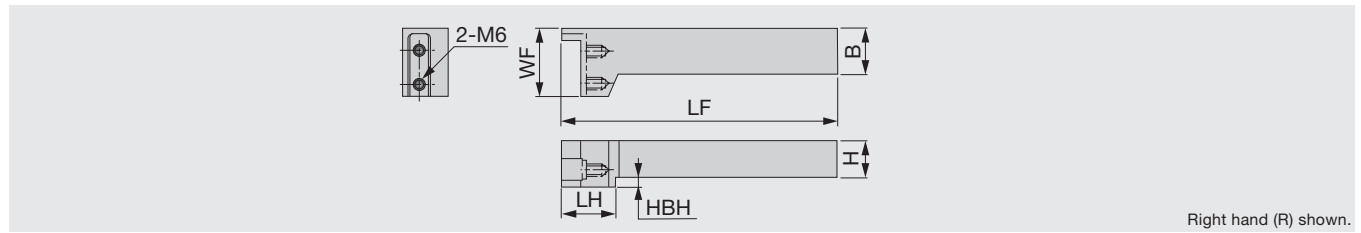

Right hand (R) shown.

Inch	H	B	LF	LH	WF	HBH
CGWTR/L12	0.75	0.75	6.00	1.20	1.50	0.234
CGWTR/L16	1.00	1.00	6.00	-	1.50	-
Metric	H	B	LF	LH	WF	HBH
CGWTR/L2020	20	20	150	30.5	37	5
CGWTR/L2525	25	25	150	-	37	-

Note: Right hand tool holders (R) use left hand cartridges (L). Left hand tool holders (L) use right hand cartridges (R).

SPARE PARTS



Designation	Blade screw
CGWTR/L...	CSHB-6

Reference pages: Inserts → **F200 - F202**, Standard cutting conditions → **F205**

INSERT

GE

For general grooving

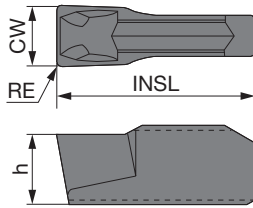

P Steel	★	☆	★	★		★			
M Stainless	★		★	★					
K Cast iron	☆		★	☆		☆			
N Non-ferrous									
S Superalloys				☆					
H Hard materials									

★ : First choice
☆ : Second choice

Designation	CW ₀ ^{+0.1} (mm)	CW ₀ ^{+0.004} (in)	RE (in)	Coated				Cermets			INSL (in)	h (in)
				T9225	T9125	AH120	GH730	NS9530				
GE20	2	0.079	0.008			●	●		●		0.394	0.138
GE30	3	0.118	0.008	●	▲	●	●		●		0.394	0.138
GE40	4	0.157	0.008	●	▲	●	●		●		0.394	0.157
GE50	5	0.197	0.008	●	▲	●	●		●		0.472	0.177

● : Line up
▲ : To be discontinued

GT

For turning

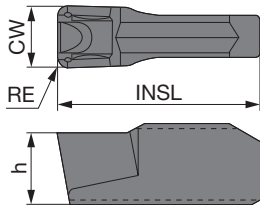

P Steel	★	☆	★	★		★			
M Stainless	★		★	★					
K Cast iron	☆		★	☆		☆			
N Non-ferrous									
S Superalloys				☆					
H Hard materials									

★ : First choice
☆ : Second choice

Designation	CW ₀ ^{+0.1} (mm)	CW ₀ ^{+0.004} (in)	RE (in)	Coated				Cermets			INSL (in)	h (in)
				T9225	T9125	AH120	GH730	NS9530				
GT30	3	0.118	0.016			●	●		●		0.394	0.138
GT40	4	0.157	0.016			●	●		●		0.394	0.157
GT50	5	0.197	0.016	●	▲	●	●		●		0.472	0.177

● : Line up
▲ : To be discontinued

Reference pages: Toolholders → **F194 - F199**, Standard cutting conditions → **F205**

GR

For profiling (full radius)

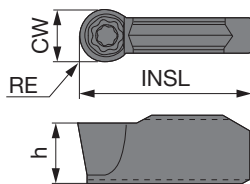

P	Steel	★	☆	★	★			★				
M	Stainless	★		★	★							
K	Cast iron	☆		★	☆			☆				
N	Non-ferrous											
S	Superalloys				☆							
H	Hard materials											

★ : First choice
☆ : Second choice

Designation	CW ^{+0.1} ₀ (mm)	CW ^{+0.004} ₀ (in)	RE (in)	Coated				Cermets				INSL (in)	h (in)	
				T9225	T9125	AH120	GH730	NS9530						
GR30	3	0.118	0.059			●	●			●			0.394	0.138
GR40	4	0.157	0.079	●	▲	●	●			●			0.394	0.157
GR50	5	0.197	0.098	●	▲	●	●			●			0.472	0.177

● : Line up
▲ : To be discontinued

GF

For face grooving

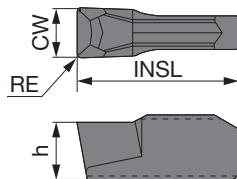

P	Steel	★			★							
M	Stainless	★										
K	Cast iron	☆			☆							
N	Non-ferrous											
S	Superalloys											
H	Hard materials											

★ : First choice
☆ : Second choice

Designation	CW ^{+0.1} ₀ (mm)	CW ^{+0.004} ₀ (in)	RE (in)	Coated		Cermets				INSL (in)	h (in)	
				GH730		NS9530						
GF30	3	0.118	0.008	●		●					0.394	0.138
GF40	4	0.157	0.008	●		●					0.394	0.157
GF50	5	0.197	0.008	●		●					0.472	0.177

● : Line up



GN

For internal grooving

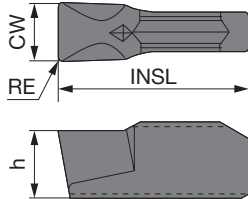

P	Steel	★					
M	Stainless	★					
K	Cast iron	☆					
N	Non-ferrous						
S	Superalloys						
H	Hard materials						

★ : First choice
☆ : Second choice

Designation	CW ^{+0.1} ₀ (mm)	CW ^{+0.004} ₀ (in)	RE (in)	Coated						INSL (in)	h (in)
				GH730							
GN30	3	0.118	0.008	●						0.394	0.138
GN40	4	0.157	0.008	●						0.394	0.157
GN50	5	0.197	0.008	●						0.472	0.177

● : Line up

GE-AL

For aluminum and non-ferrous metal

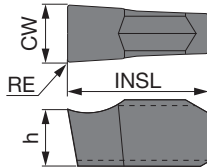

P	Steel						
M	Stainless						
K	Cast iron						
N	Non-ferrous	★					
S	Superalloys						
H	Hard materials						

★ : First choice
☆ : Second choice

Designation	CW ^{+0.1} ₀ (mm)	CW ^{+0.004} ₀ (in)	RE (in)	Uncoated						INSL (in)	h (in)
				KS05F							
GE20-AL	2	0.079	0.008	●						0.394	0.138
GE30-AL	3	0.118	0.008	●						0.394	0.138
GE40-AL	4	0.157	0.008	●						0.394	0.157

● : Line up

Reference pages: Toolholders → **F194 - F199**, Standard cutting conditions → **F205**

1 corner insert

Face grooving

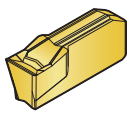
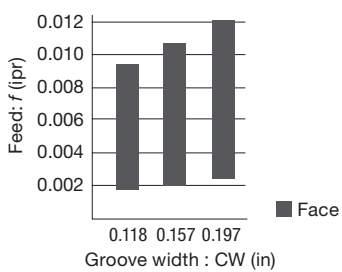
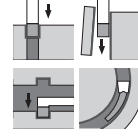
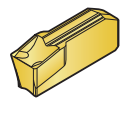
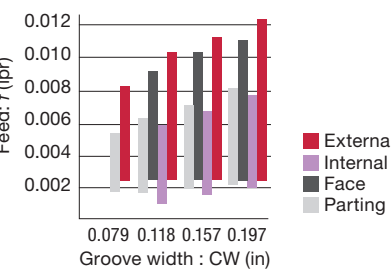
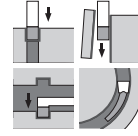
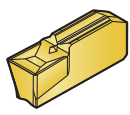
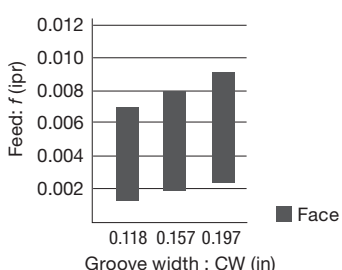
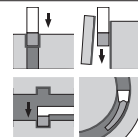
<p>GF</p>  <p>F201 page</p>	<p>1st choice for face grooving Low cutting force and good chip control for face grooving</p> <p>CW = 0.118" - 0.197"</p>	 
<p>GE</p>  <p>F200 page</p>	<p>1st choice for external grooving and parting Excellent chip control</p> <p>CW = 0.079" - 0.197"</p>	 
<p>GN</p>  <p>F202 page</p>	<p>1st choice for internal grooving Low cutting force and good chip control for internal grooving</p> <p>CW = 0.118" - 0.197"</p>	 

External grooving and turning

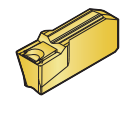
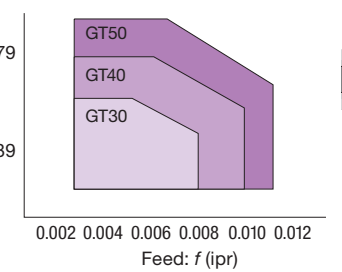
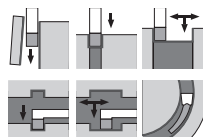
<p>GT</p>  <p>F200 page</p>	<p>1st choice for turning Low cutting force and good chip control for traversing</p> <p>CW = 0.118" - 0.197"</p>	 
---	--	--

A
B
C
D
E
F
G
H
I
J
K
L
M

1 corner insert

Profiling

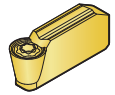
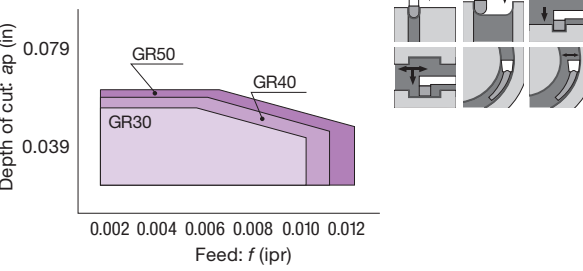
<p>GR</p>  <p>F201 page</p>	<p>Full radius type Low cutting force and good chip control for profiling CW = 0.118" - 0.197"</p>	
---	--	--

- External
- Internal
- Face
- Parting
- Others

For aluminum and non-ferrous metal

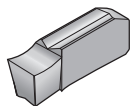
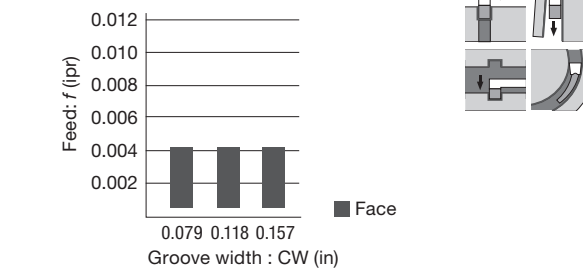
<p>GE-AL</p>  <p>F202 page</p>	<p>Reduce cutting force and welding due to sharp chipbreaker CW = 0.079" - 0.157"</p>	
--	---	---

STANDARD CUTTING CONDITIONS

ISO	Workpiece material	Grade	Cutting speed Vc (sfm)
P	Low carbon steel, Alloy steel (- HB150)	T9225	262 - 984
		NS9530	328 - 656
		GH730	164 - 591
	Medium carbon steel, Alloy steel (HB150 - 250)	T9225	262 - 722
		NS9530	262 - 591
		GH730	164 - 492
High carbon steel, Alloy steel (HB250 -)	T9225	262 - 722	
	NS9530	262 - 492	
	GH730	164 - 394	
M	Stainless steel	T9225	262 - 591
		GH730	164 - 394
K	Gray iron, Ductile cast iron	T9225	262 - 820
		GH730	164 - 591
N	Aluminum alloys, Non-ferrous metal	KS05F	656 - 984

1st choice for face grooving

Operation	Feed: <i>f</i> (ipr)		
	Groove width: CW (in)		
	3 mm (0.118")	4 mm (0.157")	5 mm (0.197")
Face grooving (GE ^{**})	0.0024 - 0.009	0.0024 - 0.009	0.0028 - 0.010
Face grooving (GF ^{**})	0.0016 - 0.010	0.0020 - 0.010	0.0020 - 0.012
Traversing (GT ^{**})	Depth of cut <i>ap</i> = 0.020 - 0.059 <i>f</i> = 0.0024 - 0.008	Depth of cut <i>ap</i> = 0.020 - 0.079 <i>f</i> = 0.0024 - 0.010	Depth of cut <i>ap</i> = 0.020 - 0.098 <i>f</i> = 0.0024 - 0.011
Traversing (GR ^{**})	Depth of cut <i>ap</i> = 0.020 - 0.055 <i>f</i> = 0.002 - 0.010	Depth of cut <i>ap</i> = 0.020 - 0.059 <i>f</i> = 0.002 - 0.010	Depth of cut <i>ap</i> = 0.020 - 0.063 <i>f</i> = 0.002 - 0.012
Grooving for Aluminum alloys (GE ^{**} -AL)	0.0012 - 0.004	0.0012 - 0.004	-

For diameter compensation values in traversing, see page **F111**.

When vibration occurs in turning, please use the lower limit value in the above table.

Grade
Insert
Ext. Toolholder
Int. Toolholder
Threading
Grooving
Miniature Tool
Milling Cutter
Endmill
Drilling Tool
Tooling System
Index



GX-R/LF

Face grooving toolholder

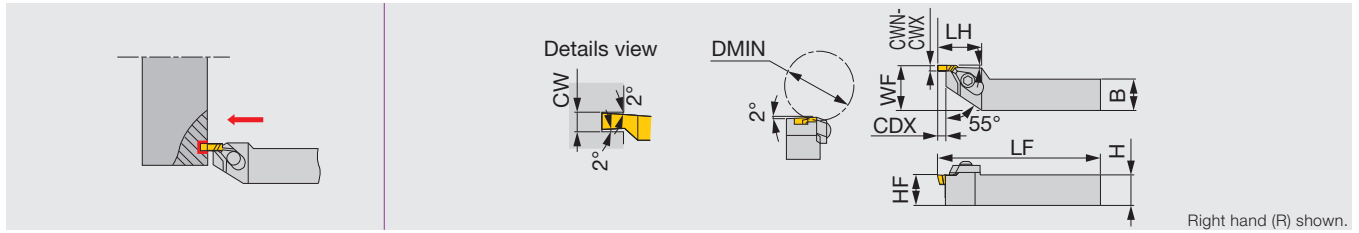

Metric	CWN	CWX	DMIN	CDX	H	B	LF	LH	HF	WF	Insert	Torque
GX-2525R/LF	1	4.5	55	1.5 - 6	25	25	150	35	25	32	XNL/R63...	5

Use right-hand toolholders (GX-...RF) with left-hand inserts (XNL); and left-hand toolholders (GX-...LF) with right-hand inserts (GBR).
Torque: Recommended clamping torque: N·m

SPARE PARTS	Clamp set	Clamping screw	Shim	Shim screw	Wrench
GX-2525RF	CP81A	RT-1	SL-3R	BHM4-8	P-4
GX-2525LF	CP81A	RT-1	SL-3L	BHM4-8	P-4

INSERT

XNR/L

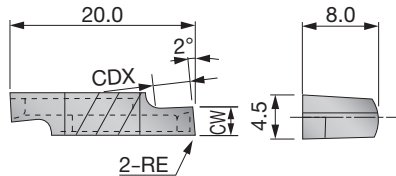

P	Steel	★		★					
M	Stainless								
K	Cast iron	☆		☆					
N	Non-ferrous								
S	Superalloys								
H	Hard materials								

★ : First choice
☆ : Second choice

Designation	HAND	CW±0.002 (in)	CW±0.05 (mm)	RE (mm)	Cermet		Uncoated		CDX (mm)
					NS9530		TH10		
XNR6310-02	R	0.039	1	0.2	●		●		1.5
XNL6310-02	L	0.039	1	0.2	●		●		1.5
XNR6315-02	R	0.059	1.5	0.2	●		●		2.3
XNL6315-02	L	0.059	1.5	0.2	●		●		2.3
XNR6320-02	R	0.079	2	0.2	●		●		3
XNL6320-02	L	0.079	2	0.2	●		●		3
XNR6325-02	R	0.098	2.5	0.2	●		●		3.8
XNL6325-02	L	0.098	2.5	0.2	●		●		3.8
XNR6330-02	R	0.118	3	0.2	●		●		4.5
XNL6330-02	L	0.118	3	0.2	●		●		4.5
XNR6335-02	R	0.138	3.5	0.2	●		●		5.3
XNL6335-02	L	0.138	3.5	0.2	●		●		5.3
XNR6340-02	R	0.157	4	0.2	●		●		6
XNL6340-02	L	0.157	4	0.2	●		●		6
XNR6345-02	R	0.177	4.5	0.2	●		●		6
XNL6345-02	L	0.177	4.5	0.2	●		●		6

● : Line up

STANDARD CUTTING CONDITIONS

ISO	Workpiece material	Grade	Cutting speed Vc (sfm)	Feed: f (ipr)		
				CW < 0.079"	CW = 0.079" - 0.157"	CW > 0.157"
P	Carbon steels	NS9530	262 - 656	0.002 - 0.004	0.003 - 0.008	0.003 - 0.010
K	Cast irons, Light alloys	TH10	197 - 492	0.002 - 0.004	0.003 - 0.008	0.003 - 0.010

Grade
Insert
Ext. Toolholder
Int. Toolholder
Threading
Grooving
Miniature Tool
Milling Cutter
Endmill
Drilling Tool
Tooling System
User's Guide
Index



MY-T SERIES

CGWSR/L-FLR/L5TP

Face grooving and turning toolholder

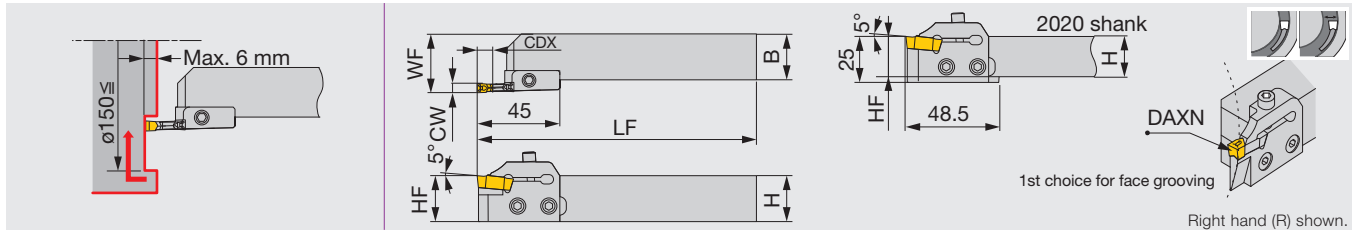

Metric	CW	DAXN	CDX	H	B	LF	HF	WF	Insert	Shank	Blade	Torque
CGWSR/L2020-FLR/L5TP	5	150	6	20	20	152	20	27	FLEX50R/L	CGWSR/L2020	FLR/L5TP	5
CGWSR/L2525-FLR/L5TP	5	150	6	25	25	152	25	32	FLEX50R/L	CGWSR/L2525	FLR/L5TP	5

Toolholders are in stock with the designations of: a set of shank and blade; a shank; a blade. Combining the designations of a blade and a shank will make the designation of a set. Please check the stock and place an order with the designation of a set or a shank+a blade.
 Note: Use right-hand blades (CGWSR...) with right-hand shanks (FLR5TP); and left-hand blades (CGWSL...) with left-hand shanks (FLR5TP).
 Torque: Recommended clamping torque: N·m

SPARE PARTS

Designation	Clamping screw	Blade screw	Wrench
CGWSR/L****-FLR/L5TP	CHHM5-18	CSHB-6	P-4

INSERT

FLEX(R/L)

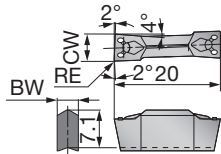

Right hand (R) shown.

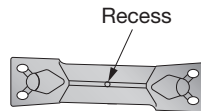

To distinguish the insert hands, the V-shape surface (top surface) of a left-hand insert has a recess. (not of a right-hand insert)

	P	M	K	N	S	H
Steel	★	☆			★	
Stainless	★				★	
Cast iron	☆		☆			
Non-ferrous						
Superalloys						
Hard materials						

★ : First choice
 ☆ : Second choice

Designation	HAND	CW±0.002 (in)	CW±0.05 (mm)	RE (mm)	Coated		Carbide		Uncoated		BW (mm)
					T9225	T9125	NS9530		UX30		
FLEX30R	R	0.118	3	0.4			●				2.2
FLEX30L	L	0.118	3	0.4			●				2.2
FLEX40R	R	0.157	4	0.4			●				3.1
FLEX40L	L	0.157	4	0.4			●				3.1
FLEX50R	R	0.197	5	0.4	● ▲		●		●		4
FLEX50L	L	0.197	5	0.4	● ▲		●		●		4

● : Line up
 ▲ : To be discontinued

STANDARD CUTTING CONDITIONS

ISO	Workpiece material	Grade	Cutting speed Vc (sfm)	Feed: f (ipr)	
				Grooving	Turning
P	Carbon steel	T9225	262 - 984	0.002 - 0.010	0.004 - 0.012
		NS9530	262 - 656	0.002 - 0.010	0.004 - 0.012
		UX30	197 - 492	0.002 - 0.010	0.004 - 0.012

External deep grooving and parting blade

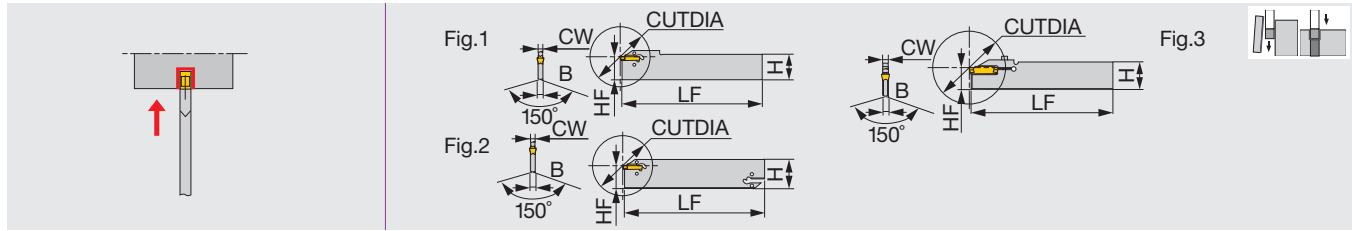

Inch	CW (in)	CW (mm)	Seat size	CUTDIA	H	B	LF	HF	Fig.	Torque
CGP26-1.4S	0.055	1.4	1	1.024	1.024	0.039	5.906	0.843	1	-
CGP32-1.4D	0.055	1.4	1	1.024	1.260	0.039	5.906	0.976	2	-
CGP26-2S	0.079	2	2	1.575	1.024	0.071	5.906	0.843	1	-
CGP32-2D	0.079	2	2	1.969	1.260	0.071	5.906	0.976	2	-
CGP26-3S	0.118	3	3	1.969	1.024	0.094	5.906	0.843	1	-
CGP32-3D	0.118	3	3	3.937	1.260	0.094	5.906	0.976	2	-
CGP26-4S	0.157	4	4	3.150	1.024	0.126	5.906	0.843	1	-
CGP32-4D	0.157	4	4	3.937	1.260	0.126	5.906	0.980	2	-
CGP45-4D	0.157	4	4	4.724	1.772	0.126	5.906	1.500	2	-
CGP32-5D	0.197	5	5	4.724	1.260	0.157	5.906	0.980	2	-
CGP32-6D	0.236	6	6	4.724	1.260	0.205	5.906	0.980	2	-
CGP32-8S-CL	0.315	8	8	3.150	1.260	0.244	5.906	0.980	3	2.21

When depth is deeper than (insert length - 0.059"), 1 corner type is recommended.

• CUTDIA: Max. parting dia.

Torque: Recommended clamping torque: lbs-ft

SPARE PARTS

Designation	Clamping screw	Wrench	Wrench (Optional)
CGP**-1.4*	-	-	CRW23
CGP**-2/3/4/5/6	-	-	CRW33
CGP32-8S-CL	CM4X0.7X20-M0-A	P-3	-

Wrench (CRW...) is not included. Please order it separately.

CGP32-CHP

External deep grooving and parting blade, with high pressure coolant capability

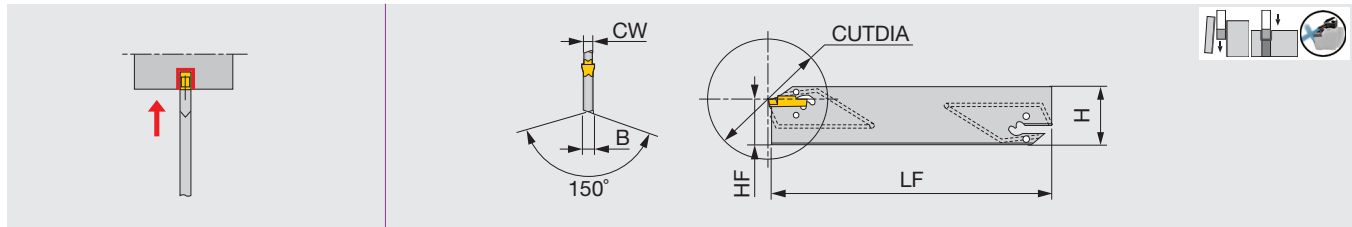

Inch	CW	Seat size	CUTDIA	H	B	LF	HF
CGP32-2D-CHP	0.079	2	1.968	1.260	0.071	5.906	0.976
CGP32-3D-CHP	0.118	3	3.937	1.260	0.094	5.906	0.976
CGP32-4D-CHP	0.157	4	3.937	1.260	0.126	5.906	0.980
CGP32-5D-CHP	0.197	5	4.724	1.260	0.157	5.906	0.980
CGP32-6D-CHP	0.236	6	4.724	1.260	0.205	5.906	0.980

When depth is deeper than (insert length - 0.059"), 1 corner type is recommended.

• CUTDIA Max. parting dia

SPARE PARTS

Designation	Sealing screw	Wrench (Optional)
CGP32-*D-CHP	SGC340	CRW33

Wrench (CRW...) is not included. Please order it separately.

Caution

Newly developed clamp

Insert is clamped by the elastic deformation of upper jaw.
Low clamping stress increases the stability and tool life.

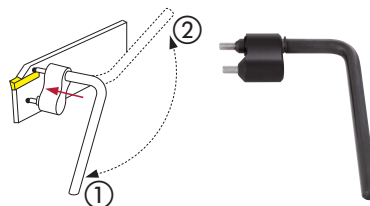

① → ② : unclamp
② → ① : clamp

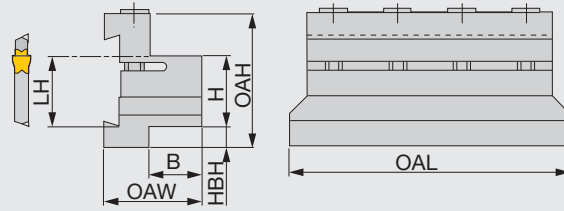

Right hand (R) shown.

Metric	H	B	OAL	LH	HBH	OAH	OAW	Blade (Optional)
CTBF25-45	25	22	110	38.1	25	66	40	CGP45...
CTBF32-45	32	28	120	38.1	18	66	45	CGP45...

SPARE PARTS

Designation	Clamping screw	Wrench
CTBF...	CM6X1.0X40-A	P-5

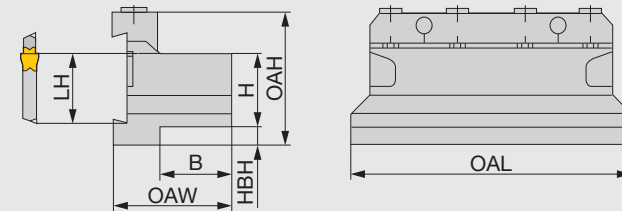

Right hand (R) shown.

Inch	H	B	OAL	LH	HBH	OAH	OAW	Blade (Optional)
CTBU12-26-U	0.750	1.690	3.386	0.843	0.354	1.690	1.496	CGP26...
CTBU16-26-U	1.000	1.770	4.331	0.843	0.197	1.770	1.654	CGP26...
CTBU12-32-U	0.750	1.970	3.937	0.976	0.512	1.970	1.496	CGP32...
CTBU16-32-U	1.000	1.970	4.331	0.976	0.315	1.970	1.654	CGP32...
CTBU20-32-U	1.250	2.130	4.331	0.976	0.197	2.130	1.890	CGP32...

Metric	H	B	OAL	LH	HBH	OAH	OAW	Blade (Optional)
CTBU20-26	20	21	86	21.4	9	43	38	CGP26...
CTBU25-26	25	23	110	21.4	5	45	43	CGP26...
CTBU20-32	20	19	100	24.8	13	50	38	CGP32...
CTBU25-32	25	23	110	24.8	8	50	42	CGP32...
CTBU32-32	32	29	110	24.8	5	54	48	CGP32...

Inch

SPARE PARTS

Designation	Clamp	Clamping screw	Wrench
CTBU12-26-U	CT-86	CM6X30-S	P-5
CTBU16-26-U	CT-100	CM6X30-S	P-5
CTBU12-32-U	CT-105	CM6X30-S	P-5
CTBU16-32-U	CT-110	CM6X30-S	P-5
CTBU20-32-U	CT-110	CM6X30-S	P-5

Metric

SPARE PARTS

Designation	Clamp	Clamping screw	Wrench
CTBU20-26	CT-86	CM6X30-S	P-5
CTBU25-26	CT-105	CM6X30-S	P-5
CTBU20-32	CT-100	CM6X30-S	P-5
CTBU25-32	CT-110	CM6X30-S	P-5
CTBU32-32	CT-110	CM6X30-S	P-5

CTBU-CHP

Tool blocks for high pressure coolant

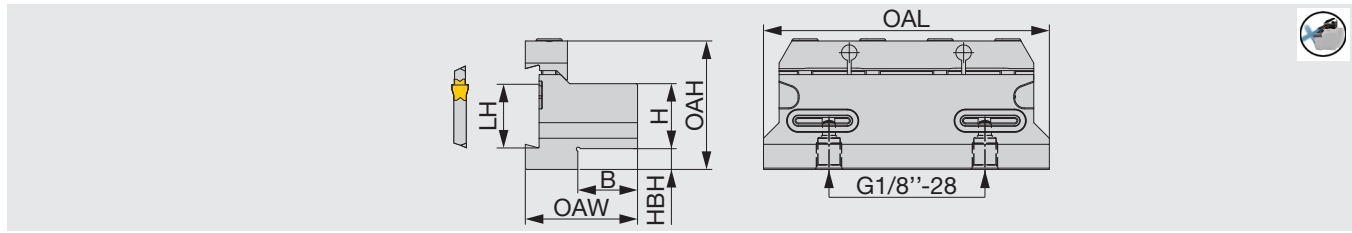

Inch	H	B	OAL	LH	HBH	OAH	OAW	Blade (Optional)
CTBU16-32-U-CHP	1.000	0.906	4.331	0.976	0.315	1.97	1.654	CGP32-'D-CHP

Applicable for 14 MPa coolant

SPARE PARTS

Designation	Clamping screw	Clamp	Wrench	O-ring
CTBU16-32-U-CHP	SRM6X16DIN912-12.9	CT-110	P-5	OR14X2.5NN

INSERT

DGM

External grooving and parting, 2 corners

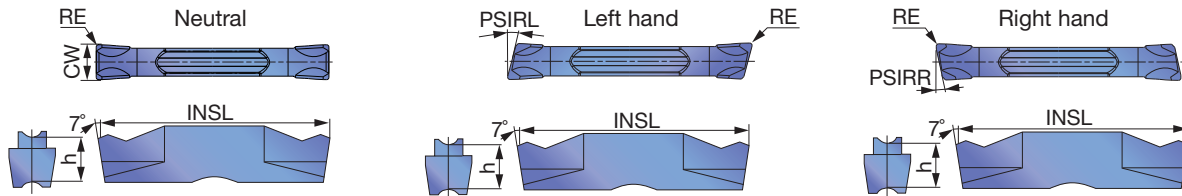

	Steel	Stainless	Cast iron	Non-ferrous	Superalloys	Hard materials
★	★	★	☆			
☆			★	☆	★	

★ : First choice
☆ : Second choice

Designation	Seat size	HAND	CW±0.05 (mm)	CW±0.002 (in)	RE (in)	Coated					Cermet		INSL (in)	h (in)	PSIRL	PSIRR
						T9225	T9125	AH7025	AH725	AH905	GH130	NS9530				
DGM2-020	2	N	2	0.079	0.008	●	▲	●	●	●	●	●	0.787	0.197	0°	0°
DGM2-020-6R	2	R	2	0.079	0.008			●	●	●			0.780	0.197	0°	6°
DGM2-020-6L	2	L	2	0.079	0.008			●	●	●			0.780	0.197	6°	0°
DGM2-020-8R	2	R	2	0.079	0.008			●	●	●			0.780	0.197	0°	8°
DGM2-020-8L	2	L	2	0.079	0.008			●	●	●			0.780	0.197	8°	0°
DGM2-020-15R	2	R	2	0.079	0.008			●	●	●			0.780	0.197	0°	15°
DGM2-020-15L	2	L	2	0.079	0.008			●	●	●			0.780	0.197	15°	0°
DGM2-002-15R	2	R	2	0.079	0.0008			●	●	●			0.762	0.197	0°	15°
DGM2-002-15L	2	L	2	0.079	0.0008			●	●	●			0.762	0.197	15°	0°
DGM3-020	3	N	3	0.118	0.008	●	▲	●	●	●	●	●	0.787	0.197	0°	0°
DGM3-020-6R	3	R	3	0.118	0.008			●	●	●			0.783	0.197	0°	6°
DGM3-020-6L	3	L	3	0.118	0.008			●	●	●			0.783	0.197	6°	0°
DGM3-002-6R	3	R	3	0.118	0.0008			●	●	●			0.766	0.197	0°	6°
DGM3-002-6L	3	L	3	0.118	0.0008			●	●	●			0.766	0.197	6°	0°
DGM3-020-15R	3	R	3	0.118	0.008			●	●	●			0.783	0.197	0°	15°
DGM3-020-15L	3	L	3	0.118	0.008			●	●	●			0.783	0.197	15°	0°
DGM4-030	4	N	4	0.157	0.012	●	▲	●	●	●	●	●	0.787	0.197	0°	0°
DGM4-030-4R	4	R	4	0.157	0.012			●	●	●			0.780	0.197	0°	4°
DGM4-030-4L	4	L	4	0.157	0.012			●	●	●			0.780	0.197	4°	0°
DGM4-030-15R	4	R	4	0.157	0.012			●	●	●			0.780	0.197	0°	15°
DGM4-030-15L	4	L	4	0.157	0.012			●	●	●			0.780	0.197	15°	0°
DGM5-030	5	N	5	0.197	0.012	●	▲	●	●	●	●	●	0.984	0.217	0°	0°
DGM5-030-4R	5	R	5	0.197	0.012			●	●	●			0.980	0.217	0°	4°
DGM6-030	6	N	6	0.236	0.012	●	▲	●	●	●	●	●	0.984	0.217	0°	0°
DGM8-040	8	N	8	0.315	0.016	●	▲	●	●	●	●	●	1.181	0.264	0°	0°

Reference pages: Toolholders → F209 - F210, Standard cutting conditions → F224

● : Line up ▲ : To be discontinued



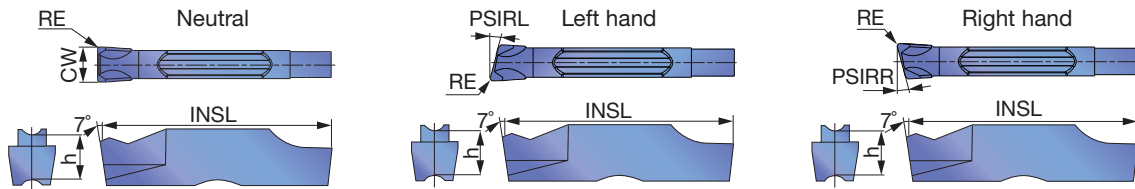

P	Steel	★	☆	☆									
M	Stainless	★	☆	★									
K	Cast iron	★		☆									
N	Non-ferrous												
S	Superalloys	★	☆										
H	Hard materials												

★ : First choice
☆ : Second choice

Designation	Seat size	HAND	CW±0.05 (mm)	CW±0.002 (in)	RE (in)	Coated						INSL (in)	h (in)	PSIRL	PSIRR	
						AH7025	AH725	GH130								
SGM2-020	2	N	2	0.079	0.008	●	●	●					0.787	0.197	0°	0°
SGM2-020-6R	2	R	2	0.079	0.008	●	●	●					0.787	0.197	0°	6°
SGM2-020-6L	2	L	2	0.079	0.008	●	●	●					0.787	0.197	6°	0°
SGM3-020	3	N	3	0.118	0.008	●	●	●					0.787	0.197	0°	0°
SGM3-020-6R	3	R	3	0.118	0.008	●	●	●					0.787	0.197	0°	6°
SGM3-020-6L	3	L	3	0.118	0.008	●	●	●					0.787	0.197	6°	0°
SGM3-020-15R	3	R	3	0.118	0.008	●	●	●					0.787	0.197	0°	15°
SGM3-020-15L	3	L	3	0.118	0.008	●	●	●					0.787	0.197	15°	0°
SGM4-030	4	N	4	0.157	0.012	●	●	●					0.787	0.197	0°	0°
SGM4-030-4R	4	R	4	0.157	0.012	●	●	●					0.787	0.197	0°	4°
SGM4-030-4L	4	L	4	0.157	0.012	●	●	●					0.787	0.197	4°	0°
SGM5-030	5	N	5	0.197	0.012	●	●	●					0.984	0.217	0°	0°
SGM6-030	6	N	6	0.236	0.012	●	●	●					0.984	0.217	0°	0°

● : Line up

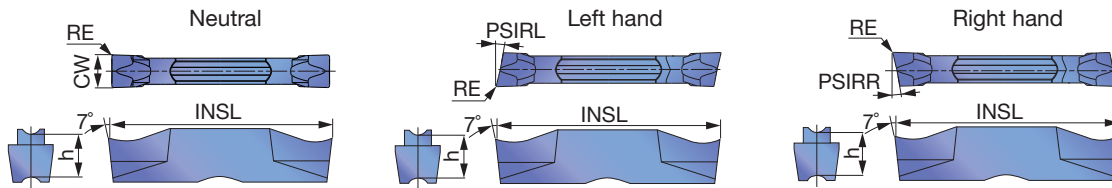

P	Steel	★	★	★	☆	☆			★				
M	Stainless	★		★	☆	★							
K	Cast iron	☆		★	☆				☆				
N	Non-ferrous												
S	Superalloys				★	☆							
H	Hard materials												

★ : First choice
☆ : Second choice

Designation	Seat size	HAND	CW±0.05 (mm)	CW±0.002 (in)	RE (in)	Coated					Cermet			INSL (in)	h (in)	PSIRL	PSIRR
						T9225	T9125	AH7025	AH725	GH130	NS9530						
DGS1.4-016	1	N	1.4	0.055	0.006				●	●	●			0.630	0.169	0°	0°
DGS2-020	2	N	2	0.079	0.008	●	▲	●	●	●		●		0.787	0.197	0°	0°
DGS2-020-6R	2	R	2	0.079	0.008			●	●	●				0.785	0.197	0°	6°
DGS2-020-6L	2	L	2	0.079	0.008			●	●	●				0.785	0.197	6°	0°
DGS2-002-6R	2	R	2	0.079	0.0008			●	●	●				0.768	0.197	0°	6°
DGS2-002-6L	2	L	2	0.079	0.0008			●	●	●				0.768	0.197	6°	0°
DGS2-020-15R	2	R	2	0.079	0.008			●	●	●				0.785	0.197	0°	15°
DGS2-020-15L	2	L	2	0.079	0.008			●	●	●				0.785	0.197	15°	0°
DGS2-002-15R	2	R	2	0.079	0.0008			●	●	●				0.768	0.197	0°	15°
DGS2-002-15L	2	L	2	0.079	0.0008			●	●	●				0.768	0.197	15°	0°
DGS3-020	3	N	3	0.118	0.008	●	▲	●	●	●		●		0.787	0.197	0°	0°
DGS3-020-6R	3	R	3	0.118	0.008			●	●	●				0.783	0.197	0°	6°
DGS3-020-6L	3	L	3	0.118	0.008			●	●	●				0.783	0.197	6°	0°
DGS3-002-6R	3	R	3	0.118	0.0008			●	●	●				0.766	0.197	0°	6°
DGS3-002-6L	3	L	3	0.118	0.0008			●	●	●				0.766	0.197	6°	0°
DGS3-020-15R	3	R	3	0.118	0.008			●	●	●				0.783	0.197	0°	15°
DGS3-020-15L	3	L	3	0.118	0.008			●	●	●				0.783	0.197	15°	0°
DGS3-002-15R	3	R	3	0.118	0.0008			●	●	●				0.766	0.197	0°	15°
DGS3-002-15L	3	L	3	0.118	0.0008			●	●	●				0.766	0.197	15°	0°
DGS4-030	4	N	4	0.157	0.012	●	▲	●	●	●		●		0.787	0.197	0°	0°
DGS4-030-4R	4	R	4	0.157	0.012			●	●	●				0.780	0.197	0°	4°
DGS4-030-4L	4	L	4	0.157	0.012			●	●	●				0.781	0.197	4°	0°
DGS5-030	5	N	5	0.197	0.012	●	▲	●	●	●		●		0.984	0.217	0°	0°
DGS6-030	6	N	6	0.236	0.012	●	▲	●	●	●		●		0.984	0.217	0°	0°

● : Line up
▲ : To be discontinued

Caution

The tool will interfere with the workpiece when grooving larger diameter than øDmax.

Designation	øDmax (in)	Designation	øDmax (in)
DGM2-002-15R/L	1.102	DGS2-002-15R/L	1.102
DGM3-002-15R/L	1.141	DGS3-002-15R/L	1.141
DGM4-030-15R/L	1.181	SGS3-020-15R/L	4.055
SGM3-020-15R/L	4.055	SGS3-002-15R/L	1.338

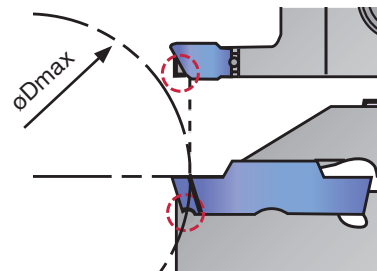

External deep grooving and parting, 1 corner

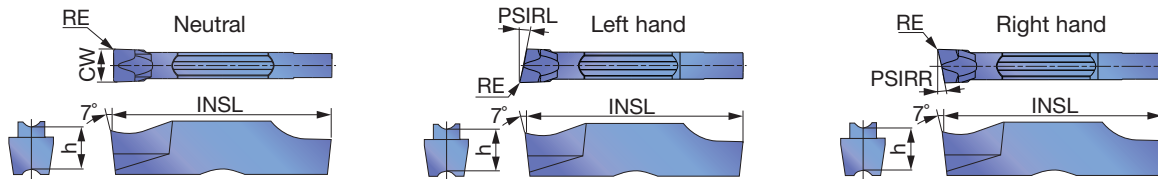

P	Steel	★	☆	☆									
M	Stainless	★	☆	★									
K	Cast iron	★		☆									
N	Non-ferrous												
S	Superalloys	★	☆										
H	Hard materials												

★ : First choice
☆ : Second choice

Designation	Seat size	HAND	CW±0.05 (mm)	CW±0.002 (in)	RE (in)	Coated			INSL (in)	h (in)	PSIRL	PSIRR
						AH7025	AH725	GH130				
SGS2-020	2	N	2	0.079	0.008	●	●	●	0.787	0.197	0°	0°
SGS2-020-6R	2	R	2	0.079	0.008	●	●	●	0.787	0.197	0°	6°
SGS2-020-6L	2	L	2	0.079	0.008	●	●	●	0.787	0.197	6°	0°
SGS2-020-15R	2	R	2	0.079	0.008	●	●	●	0.787	0.197	0°	15°
SGS2-020-15L	2	L	2	0.079	0.008	●	●	●	0.787	0.197	15°	0°
SGS3-020	3	N	3	0.118	0.008	●	●	●	0.787	0.197	0°	0°
SGS3-020-6R	3	R	3	0.118	0.008	●	●	●	0.787	0.197	0°	6°
SGS3-020-6L	3	L	3	0.118	0.008	●	●	●	0.787	0.197	6°	0°
SGS3-002-6R	3	R	3	0.118	0.0008		●	●	0.780	0.197	0°	6°
SGS3-002-6L	3	L	3	0.118	0.0008		●	●	0.780	0.197	6°	0°
SGS3-020-15R	3	R	3	0.118	0.008	●	●	●	0.787	0.197	0°	15°
SGS3-020-15L	3	L	3	0.118	0.008	●	●	●	0.787	0.197	15°	0°
SGS3-002-15R	3	R	3	0.118	0.0008		●	●	0.780	0.197	0°	15°
SGS3-002-15L	3	L	3	0.118	0.0008		●	●	0.780	0.197	15°	0°
SGS4-030	4	N	4	0.157	0.012	●	●	●	0.787	0.197	0°	0°
SGS5-030	5	N	5	0.197	0.012	●	●	●	0.984	0.217	0°	0°
SGS6-030	6	N	6	0.236	0.012	●	●	●	0.984	0.217	0°	0°

● : Line up

DGG

External grooving (for high precision)

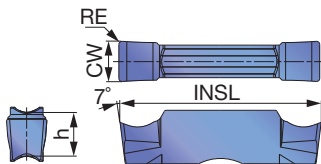

P	Steel	★		★								
M	Stainless	★										
K	Cast iron	★		☆		☆						
N	Non-ferrous							★				
S	Superalloys	★						☆				
H	Hard materials											

★ : First choice
☆ : Second choice

Designation	Seat size	CW±0.02 (mm)	CW±0.0008 (in)	RE (in)	Coated		Cermet		Uncoated		INSL (in)	h (in)
					AH7025		NS9530		KS05F			
DGG200-020	2	2	0.079	0.008	●		●		●		0.787	0.197
DGG300-020	3	3	0.118	0.008	●		●		●		0.787	0.197
DGG400-040	4	4	0.157	0.016	●		●		●		0.787	0.197
DGG500-040	5	5	0.197	0.016	●		●		●		0.984	0.217
DGG600-040	6	6	0.236	0.016	●		●		●		0.984	0.217

● : Line up

Reference pages: Toolholders → F209 - F210, Standard cutting conditions → F224

DGL

External grooving and parting

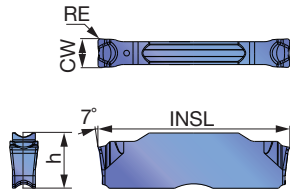

P	Steel	★							
M	Stainless	★							
K	Cast iron	★							
N	Non-ferrous								
S	Superalloys	★							
H	Hard materials								

★ : First choice
☆ : Second choice

Designation	Seat size	CW±0.05 (mm)	CW±0.002 (in)	RE (in)	Coated								INSL (in)	h (in)
					AH7025									
DGL3-025	3	3	0.118	0.010	●								0.787	0.197
DGL4-030	4	4	0.157	0.012	●								0.787	0.197
DGL5-030	5	5	0.197	0.012	●								0.984	0.217
DGL6-080	6	6	0.236	0.031	●								0.984	0.217

● : Line up

DTM

External face grooving and turning

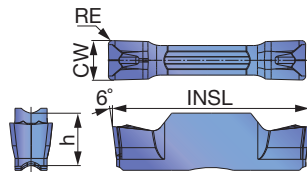

P	Steel	★							
M	Stainless	★							
K	Cast iron	★							
N	Non-ferrous								
S	Superalloys	★							
H	Hard materials								

★ : First choice
☆ : Second choice

Designation	Seat size	CW±0.05 (mm)	CW±0.002 (in)	RE (in)	Coated								INSL (in)	h (in)
					AH7025									
DTM3-030	3	3	0.118	0.012	●								0.787	0.197
DTM4-040	4	4	0.157	0.016	●								0.787	0.197
DTM4-080	4	4	0.157	0.031	●								0.787	0.197
DTM5-080	5	5	0.197	0.031	●								0.984	0.217
DTM6-080	6	6	0.236	0.031	●								0.984	0.217
DTM8-080	8	8	0.315	0.031	●								1.181	0.264

● : Line up



DTE

External face grooving and turning (for high precision)

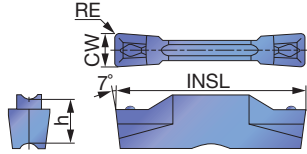

P	Steel	★	★	★	☆	☆		★				
M	Stainless	★		★	☆	★						
K	Cast iron	☆		★		☆						
N	Non-ferrous											
S	Superalloys				★	☆						
H	Hard materials											

★ : First choice
☆ : Second choice

Designation	Seat size	CW±0.02 (mm)	CW±0.0008 (in)	RE (in)	Coated					Cermets			INSL (in)	h (in)	
					T9225	T9125	AH7025	AH725	GH130	NS9530					
DTE265-015	3	2.65	0.104	0.006	●	▲	●	●	●		●			0.787	0.197
DTE300-020	3	3	0.118	0.008	●	▲	●	●	●		●			0.787	0.197
DTE300-040	3	3	0.118	0.016	●	▲	●	●	●		●			0.787	0.197
DTE315-015	3	3.15	0.124	0.006	●	▲	●	●	●		●			0.787	0.197
DTE400-040	4	4	0.157	0.016	●	▲	●	●	●		●			0.787	0.197
DTE400-080	4	4	0.157	0.031	●	▲	●	●	●		●			0.787	0.197
DTE415-015	4	4.15	0.163	0.006	●	▲	●	●	●		●			0.787	0.197
DTE478-055	5	4.78	0.188	0.022	●	▲	●	●	●		●			0.984	0.217
DTE500-040	5	5	0.197	0.016	●	▲	●	●	●		●			0.984	0.217
DTE500-080	5	5	0.197	0.031	●	▲	●	●	●		●			0.984	0.217
DTE515-015	5	5.15	0.203	0.006	●	▲	●	●	●					0.984	0.217
DTE600-080	6	6	0.236	0.031	●	▲	●	●	●					0.984	0.217
DTE600-120	6	6	0.236	0.047	●	▲	●	●	●					0.984	0.217
DTE800-080	8	8	0.315	0.031	●	▲	●	●	●					1.181	0.264
DTE800-120	8	8	0.315	0.047	●	▲	●	●	●					1.181	0.264

● : Line up
▲ : To be discontinued

DTE

External face grooving and turning

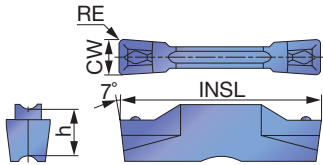

P	Steel	★	★		★	☆	☆		★			
M	Stainless	★			★	☆	★					
K	Cast iron	☆			★		☆					
N	Non-ferrous											
S	Superalloys					★	☆					
H	Hard materials											

★ : First choice
☆ : Second choice

Designation	Seat size	CW±0.05 (mm)	CW±0.002 (in)	RE (in)	Coated					Cermets			INSL (in)	h (in)	
					T9225	T9125	T515	AH7025	AH725	GH130	NS9530				
DTE3-040	3	3	0.118	0.016	●	▲	●	●	●	●		●		0.787	0.197
DTE4-040	4	4	0.157	0.016	●	▲	●	●	●	●		●		0.787	0.197
DTE5-040	5	5	0.197	0.016			●	●						0.984	0.217
DTE6-080	6	6	0.236	0.031			●	●						0.984	0.217

● : Line up
▲ : To be discontinued

Reference pages: Toolholders → F209 - F210, Standard cutting conditions → F224

DTX

External/Internal face grooving and turning

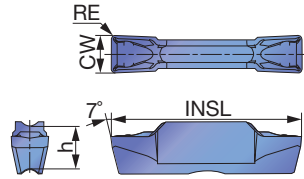

	P	M	K	N	S	H
Steel	★	★	★	☆	☆	★
Stainless	★	★	★	☆	★	
Cast iron	☆	★	★	☆	☆	★
Non-ferrous						
Superalloys			★	☆		
Hard materials						

★ : First choice
☆ : Second choice

Designation	Seat size	CW±0.05 (mm)	CW±0.002 (in)	RE (in)	Coated					Cermets			INSL (in)	h (in)	
					T9225	T9125	AH7025	AH725	GH130	NS9530					
DTX3-030	3	3	0.118	0.012	●	▲	●	●	●		●			0.787	0.197
DTX4-040	4	4	0.157	0.016	●	▲	●	●	●		●			0.787	0.197
DTX5-040	5	5	0.197	0.016	●	▲	●	●	●		●			0.984	0.217
DTX6-080	6	6	0.236	0.031			●	●	●					0.984	0.197

● : Line up
▲ : To be discontinued

DTR

Profiling and undercutting (for high precision)

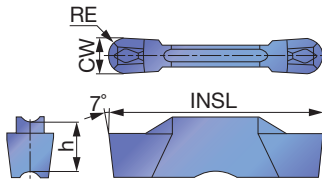

	P	M	K	N	S	H
Steel	★	★	★	☆	☆	★
Stainless	★	★	★	☆	★	
Cast iron	☆	★	★	☆	☆	★
Non-ferrous						
Superalloys			★	☆		
Hard materials						

★ : First choice
☆ : Second choice

Designation	Seat size	CW±0.02 (mm)	CW±0.0008 (in)	RE (in)	Coated					Cermets			INSL (in)	h (in)	
					T9225	T9125	AH7025	AH725	GH130	NS9530					
DTR300-150	3	3	0.118	0.059	●	▲	●	●	●		●			0.787	0.197
DTR400-200	4	4	0.157	0.079	●	▲	●	●	●		●			0.787	0.197
DTR478-239	5	4.78	0.188	0.094	●	▲	●	●	●		●			0.984	0.217
DTR500-250	5	5	0.197	0.098	●	▲	●	●	●		●			0.984	0.217
DTR600-300	6	6	0.236	0.118	●	▲	●	●	●					0.984	0.217

● : Line up
▲ : To be discontinued

Reference pages: Toolholders → **F209 - F210**, Standard cutting conditions → **F224**

Grade
Insert
Toolholder
Ext. Toolholder
Int. Toolholder
Threading
Grooving
Miniature Tool
Milling Cutter
Endmill
Drilling Tool
Tooling System
User's Guide
Index



DTR

Profiling and undercutting

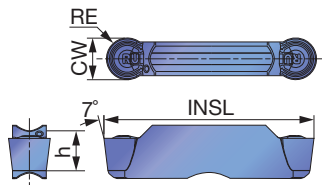

P Steel	★	★	★	☆	☆		★			
M Stainless	★		★	☆		★				
K Cast iron	☆		★		☆	☆	☆			
N Non-ferrous										
S Superalloys			★	☆	★					
H Hard materials										

★ : First choice
☆ : Second choice

Designation	Seat size	CW±0.05 (mm)	CW±0.002 (in)	RE (in)	Coated						Cermets		INSL (in)	h (in)	
					T9225	T9125	AH7025	AH725	AH905	GH130	NS9530				
DTR3-150	3	3	0.118	0.059	●	▲	●	●	●	●		●		0.787	0.197
DTR4-200	4	4	0.157	0.079	●	▲	●	●	●	●		●		0.787	0.197
DTR5-250	5	5	0.197	0.098	●	▲	●	●	●	●		●		0.984	0.217
DTR6-300	6	6	0.236	0.118	●	▲	●	●	●	●				0.984	0.217
DTR8-400	8	8	0.315	0.157	●	▲	●	●	●	●				1.181	0.264

● : Line up
▲ : To be discontinued

External

Internal

Face

Parting

Others

DTIU

Profiling and undercutting (for high precision)

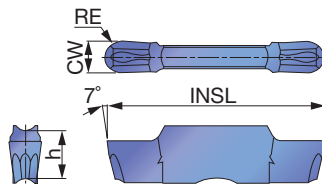

P Steel	★	☆	☆							
M Stainless	★	☆	★							
K Cast iron	★		☆							
N Non-ferrous										
S Superalloys	★	☆								
H Hard materials										

★ : First choice
☆ : Second choice

Designation	Seat size	CW±0.02 (mm)	CW±0.0008 (in)	RE (in)	Coated							INSL (in)	h (in)
					AH7025	AH725	GH130						
DTIU300-150	3	3	0.118	0.059	●	●	●					0.787	0.197
DTIU400-200	4	4	0.157	0.079	●	●	●					0.787	0.197
DTIU500-250	5	5	0.197	0.098	●	●	●					0.984	0.217
DTIU600-300	6	6	0.236	0.118	●	●	●					0.984	0.217

● : Line up

Reference pages: Toolholders → **F209 - F210**, Standard cutting conditions → **F224**

DTA

Aluminum wheel machining (for high precision)

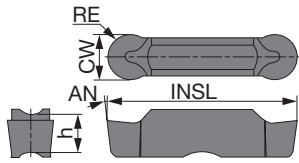

P	Steel								
M	Stainless								
K	Cast iron								
N	Non-ferrous	★							
S	Superalloys								
H	Hard materials								

★ : First choice
☆ : Second choice

Designation	Seat size	CW±0.02 (mm)	CW±0.0008 (in)	RE (in)	Uncoated							INSL (in)	h (in)	AN	
					TH10										
DTA600-300	6	6	0.236	0.118	●								0.984	0.217	7°
DTA800-400	8	8	0.315	0.157	●								1.181	0.264	10°

● : Line up

SGN

External grooving of hardened steel

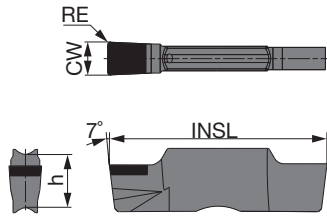

P	Steel								
M	Stainless								
K	Cast iron								
N	Non-ferrous								
S	Superalloys								
H	Hard materials	★							







★ : First choice
☆ : Second choice

Designation	Seat size	CW±0.025 (mm)	CW±0.001 (in)	RE (in)	CBN							INSL (in)	h (in)	
					BX360									
SGN200-020	2	2	0.079	0.008	●								0.787	0.197
SGN300-020	3	3	0.118	0.008	●								0.787	0.197
SGN400-020	4	4	0.157	0.008	●								0.787	0.197

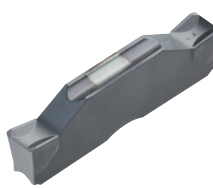
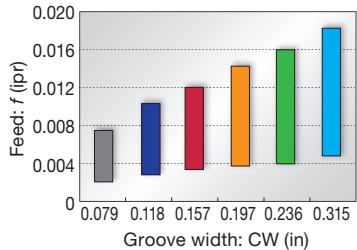
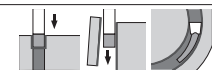
● : Line up

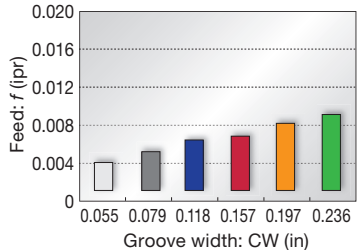
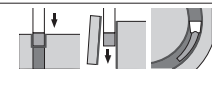
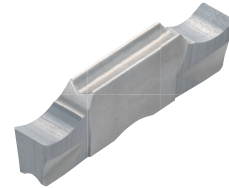
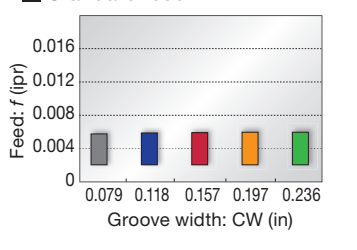
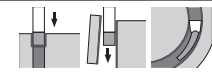

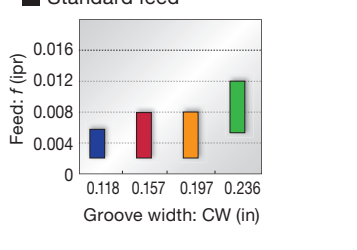
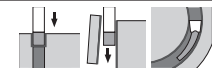
External grooving and parting

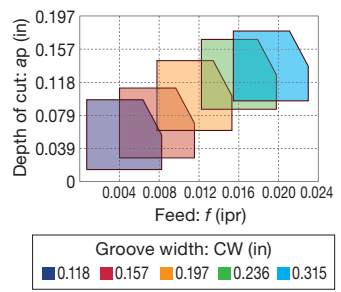
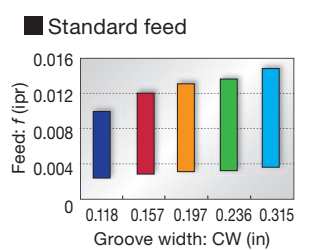
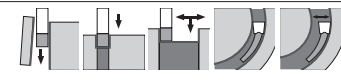
<p>DGM type (2 corners) SGM type (1 corner)</p>  <p>F211, F212 page</p>	<p>1st choice for grooving and parting</p> <p>Smooth chip evacuation Well-designed edge with high strength Handed insert available CW = 0.079" - 0.315"</p>	<p>Standard feed</p>  
<p>DGS type (2 corners) SGS type (1 corner)</p>  <p>F213, F214 page</p>	<p>Lower cutting force and superior sharpness</p> <p>Unique-designed edge and chipbreaker Handed insert available CW = 0.055" - 0.236"</p>	<p>Standard feed</p>  
<p>DGG type (2 corners)</p>  <p>F214 page</p>	<p>For non-ferrous materials and titanium</p> <p>Chipbreaker with low cutting force Sharp cutting edge that prevents vibration and delivers fine surface finish CW = 0.079" - 0.236"</p>	<p>Standard feed</p>  
<p>DGL type (2 corners)</p>  <p>F215 page</p>	<p>1st choice for mild steel</p> <p>Chipbreaker with excellent chip control at low feed Suitable for mild steel that often has difficulties with chip control CW = 0.118" - 0.236"</p>	<p>Standard feed</p>  
<p>DTM type (2 corners)</p>  <p>F215 page</p>	<p>General purpose</p> <p>1st choice for grooving and turning Suitable for light to medium cutting Excellent chip control in machining steel, alloy steel, stainless steel, and heat-resistant alloy CW = 0.118" - 0.315"</p>	<p>Standard feed and DoC</p>  <p>Standard feed</p>  

External grooving and turning

DTE type
(2 corners)



F216 page

General purpose

Unique chipbreaker makes chips shorter
Molded and ground inserts available
CW = 0.118" - 0.315"

Standard feed and DoC

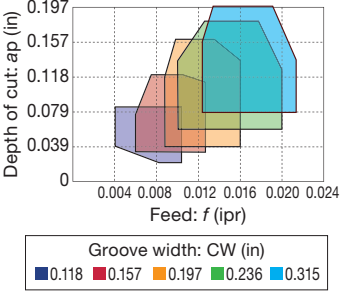

Standard feed

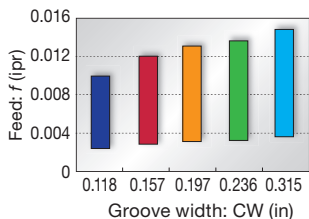

DTX type
(2 corners)



F217 page

Multi-functional type

Well balanced sharpness and strength
Multi-functional insert
CW = 0.118" - 0.236"

Standard feed and DoC

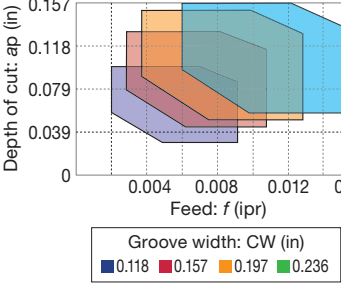

Standard feed

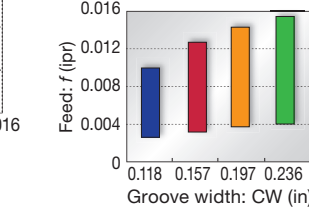

Profiling and undercutting

DTR type
(2 corners)

Molded



Ground



F217, F218 page

Full radius type

Excellent chip control
Molded and ground inserts available
CW = 0.118" - 0.315"

Standard feed and DoC

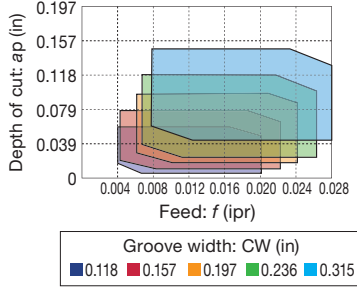

DTIU type
(2 corners)

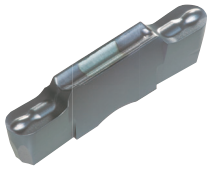

F218 page

Full radius type

Excellent chip control
For undercutting
CW = 0.118" - 0.236"

Standard feed and DoC

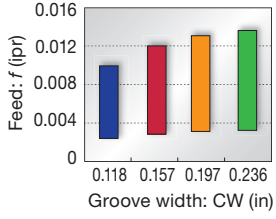

Aluminum wheel machining

DTA type (2 corners)

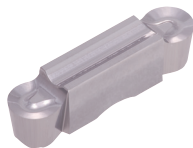

F219 page

Full radius type

Excellent chip control
For aluminum wheel profiling
Ground insert
CW = 0.236" - 0.315"

Standard feed and DoC

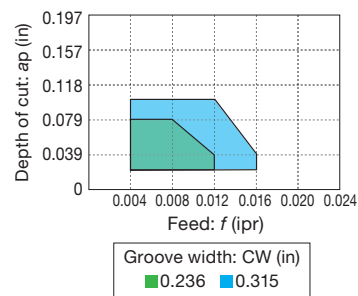

External grooving of hardened steel

SGN-CBN type (1 corner)

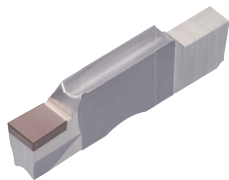

F219 page

For hardened steel cutting

Optimum cutting edge shape for grooving of hardened steels
High tolerance width for finishing
CW = 0.079" - 0.157"
(CW = ±0.001")

Standard feed

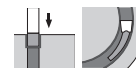
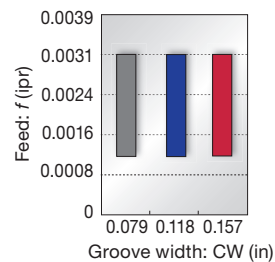

AH7025 Cutting performance

First choice grade for grooving

AH7025 grade: Tungaloy's unique coating technology for drastically improved reliability

Tool life comparison



Tool wear after 60 grooves

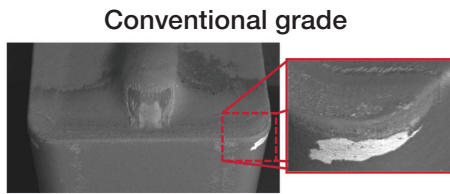

Tool wear after 30 grooves

P Alloy steel
(4140)

Insert : DTE3-040 AH7025
Cutting speed: $V_c = 492$ sfm
Feed : $f = 0.007$ ipr
Groove depth : 0.669"
Machining : External grooving
Coolant : Wet

AH7025 provides stability, while preventing coating from peeling off even after machining twice the number of passes compared to the conventional grade.

→ **The combination of Nano-multi-layered AlTiN Coating with high Al content and tough substrate provides highly efficient machining in various grooving operations.**

Grades

AH7025

P M K S

- First choice for various applications
- New PVD coating with high Al content provides excellent adhesion strength
- Improved wear and chipping resistance

AH725

P M S

- Recommended for various applications
- Newly developed coating with well controlled crystal structure and fracture resistance
- Improved adhesion strength

T515

K

- First recommended grade for cast iron
- Excellent wear resistance in high-speed machining

T9225

P

- Suitable for steel machining at high speeds
- New CVD coating and substrate deliver an outstanding balance of wear and chipping resistance

NS9530

P

- Advanced cermet for finish cutting of steel
- Innovative grade with incredible fracture and high wear resistance

GH130

P M K

- Recommended for interrupted machining
- TiCNO PVD coating layer with high wear resistance
- High hardness wear resistance

AH905

S

- Remarkable for machining of heat resistant alloys
- Exclusive coating layer improves adhesion strength and wear resistance

KS05F

N S

- Recommended for non-ferrous materials and titanium

TH10

N

- Recommended for non-ferrous materials

BX360

H

- Suitable for hardened steel machining
- Ideal balance of wear and chipping resistance due to the optimum CBN content and grain size



STANDARD CUTTING CONDITIONS

ISO	Workpiece material	Hardness	Priority	Grade	Cutting speed Vc (sfm)
P	Steel 1045, 4135, etc.	< 300 HB	First choice	AH7025, AH725	164 - 591
		< 300 HB	Priority for wear resistance	T9225	262 - 984
		< 300 HB	Priority for impact resistance	GH130	164 - 394
		< 300 HB	Priority for surface finish	NS9530	262 - 722
M	Stainless steel 304SS, 316SS, 17-4 PH, etc.	< 200 HB	First choice	AH7025, AH725	164 - 394
		< 200 HB	Priority for impact resistance	GH130	164 - 394
K	Gray cast iron No.250B, No.300B, etc.	-	First choice	T515, AH7025	164 - 591
		-	Priority for impact resistance	GH130	164 - 591
	Ductile cast iron 60-40-18, 60-55-06, etc.	-	First choice	T515, AH7025	164 - 394
		-	Priority for impact resistance	GH130	164 - 394
N	Aluminum alloys Si < 12%	-	First choice	TH10	328 - 1640
		-	First choice	KS05F	328 - 1969
S	Superalloys Inconel 718, etc.	< HRC 40	First choice	AH7025	66 - 197
		< HRC 40	Priority for wear resistance	AH905	66 - 262
	Titanium alloys Ti-6Al-4V, etc.	< HRC 40	First choice	AH905	66 - 262
		< HRC 40	Priority for impact resistance	AH7025, AH725	66 - 262
		< HRC 40	Priority for surface finish	KS05F	66 - 197
H	Hardened steel 4137, etc.	> HRC 50	First choice	BX360	262 - 492

*See page F220 - F222 for feed: f (ipr).

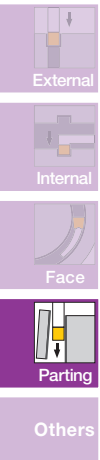

MY-T SERIES

CCH-W

External grooving and parting blade, for 2 corner inserts

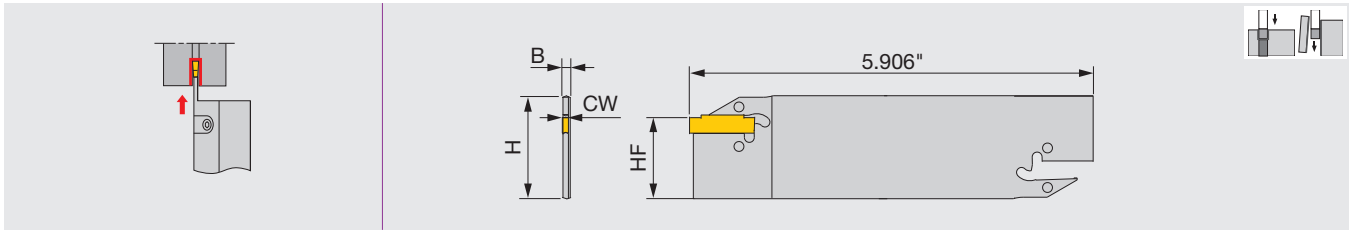

Inch	CW	CUTDIA	H	B	HF	Insert
CCH32-W20	0.079	1.3	(1.26)	0.063	0.968	WGE20, WGE20R/L
CCH32-W30	0.118	1.3	(1.26)	0.087	0.968	WG*30, WGE30R/L
CCH32-W40	0.157	1.65	(1.26)	0.126	0.965	WG*40, WGE40R/L
CCH32-W50	0.197	1.65	(1.26)	0.165	0.965	WG*50, WGE50R/L

SPARE PARTS

Designation	Wrench (Optional)
CCH32-W...	CRW33

MY-T SERIES

CCBS-32

Tool block for CCH blade

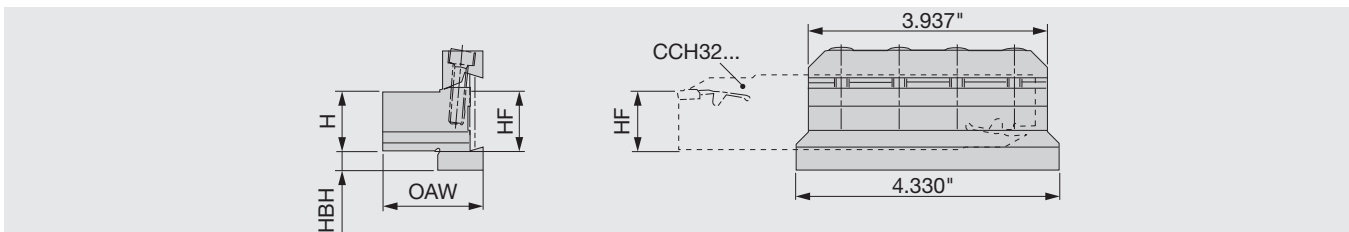

Inch	H	HF	HBH	OAW	Blade*
CCBS12-32-U	0.75	0.75	0.55	1.49	CCH32...
CCBS16-32-U	1.00	1.00	0.30	1.66	CCH32...
CCBS20-32-U	1.25	1.25	0.21	1.66	CCH32...

* Blade sold separately.

SPARE PARTS

Designation	Clamp	Screw	Wrench
CCBS**-32-U	CC-32	CM6X25	P-5

Reference pages: Inserts → [F226 - F227](#), Standard cutting conditions → [F227](#)

Grade
Insert
Toolholder
Ext. Toolholder
Int. Toolholder
Threading
Grooving
Milling Cutter
Miniature Tool
Endmill
Drilling Tool
User's Guide
Tooling System
Index



INSERT

WGE

For external grooving and parting

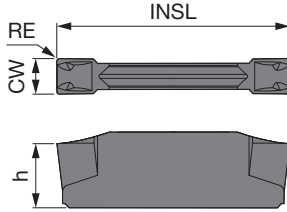

P	Steel	★	☆	★	★			★				
M	Stainless	★		★	★							
K	Cast iron	☆		★	☆			☆				
N	Non-ferrous											
S	Superalloys				☆							
H	Hard materials											

★ : First choice
☆ : Second choice

Designation	CW ^{+0.1} ₀ (mm)	CW ^{+0.004} ₀ (in)	RE (in)	Coated				Cermets			INSL (in)	h (in)
				T9225	T9125	AH120	GH730	NS9530				
WGE20	2	0.079	0.008	●	▲	●	●	●			0.787	0.185
WGE30	3	0.118	0.008	●	▲	●	●	●			0.787	0.217
WGE40	4	0.157	0.008	●	▲	●	●	●			0.984	0.224
WGE50	5	0.197	0.008	●	▲	●	●	●			0.984	0.232

● : Line up
▲ : To be discontinued



WGT

For turning (External grooving and parting)

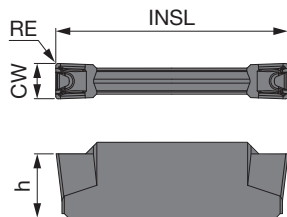

P	Steel	★	☆	★	★			★				
M	Stainless	★		★	★							
K	Cast iron	☆		★	☆			☆				
N	Non-ferrous											
S	Superalloys				☆							
H	Hard materials											

★ : First choice
☆ : Second choice

Designation	CW ^{+0.1} ₀ (mm)	CW ^{+0.004} ₀ (in)	RE (in)	Coated				Cermets			INSL (in)	h (in)
				T9225	T9125	AH120	GH730	NS9530				
WGT30	3	0.118	0.016	●	▲	●	●	●			0.787	0.217
WGT40	4	0.157	0.016	●	▲	●	●	●			0.984	0.224
WGT50	5	0.197	0.016	●	▲	●	●	●			0.984	0.232

● : Line up
▲ : To be discontinued

WGE(R/L)

For parting (with hand)

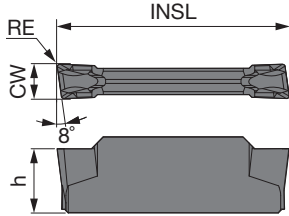

Right hand (R) shown.

P	Steel	★	★					
M	Stainless	★	★					
K	Cast iron	★	☆					
N	Non-ferrous							
S	Superalloys	☆						
H	Hard materials							

★ : First choice
☆ : Second choice

Designation	HAND	CW ₀ ^{+0.1} (mm)	CW ₀ ^{+0.004} (in)	RE (in)	Coated								INSL (in)	h (in)	
					AH120	GH730									
WGE20R	R	2	0.079	0.008	●	●								0.787	0.185
WGE20L	L	2	0.079	0.008	●	●								0.787	0.185
WGE30R	R	3	0.118	0.008	●	●								0.787	0.217
WGE30L	L	3	0.118	0.008	●	●								0.787	0.217
WGE40R	R	4	0.157	0.008	●	●								0.984	0.224
WGE40L	L	4	0.157	0.008	●	●								0.984	0.224
WGE50R	R	5	0.197	0.008	●	●								0.984	0.232
WGE50L	L	5	0.197	0.008	●	●								0.984	0.232

● : Line up

STANDARD CUTTING CONDITIONS

ISO	Workpiece material	Grade	Cutting speed V _c (sfm)	Operation	Feed: f (ipr)								
					Groove width: CW (in)								
					2 mm (0.079")	3 mm (0.118")	4 mm (0.157")	5 mm (0.197")					
P	Low carbon steel Alloy steel (~ HB150)	T9225	262 - 984	Grooving (WGE**)	0.0024 - 0.008	0.0024 - 0.010	0.0028 - 0.011	0.0028 - 0.012					
		NS9530	328 - 656										
		GH730	164 - 591										
	Medium carbon steel Alloy steel (HB150 ~ 250)	T9225	262 - 722						Parting (WGE**R/L)	0.0016 - 0.004	0.0016 - 0.006	0.0016 - 0.006	0.0016 - 0.006
		NS9530	262 - 591										
		GH730	164 - 492										
High carbon steel Alloy steel (HB250 ~)	T9225	262 - 722	Turning (WGT**)	-	ap = 0.020 - 0.059 f = 0.0024 - 0.008	ap = 0.020 - 0.079 f = 0.0024 - 0.010	ap = 0.020 - 0.098 f = 0.0024 - 0.011						
	NS9530	262 - 492											
	GH730	164 - 492											
M	Stainless steel	T9225						262 - 591					
		GH730						164 - 394					
K	Gray iron, Ductile cast iron	T9225						262 - 820					
		GH730	164 - 591										

Reference pages: Toolholders → **F225**

Grade
Insert
Toolholder
Ext. Toolholder
Int. Toolholder
Threading
Grooving
Miniature Tool
Milling Cutter
Endmill
Drilling Tool
Tooling System
User's Guide
Index



2 corner insert

External grooving and parting

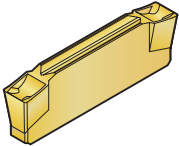
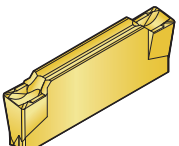
<p>WGE</p>  <p>F226 page</p>	<p>1st choice for external grooving and parting Excellent chip control for grooving CW = 0.079" - 0.197"</p>	<table border="1"> <caption>WGE Feed Performance Data</caption> <thead> <tr> <th>Groove width : CW (in)</th> <th>External (ipr)</th> <th>Internal (ipr)</th> <th>Face (ipr)</th> <th>Parting (ipr)</th> </tr> </thead> <tbody> <tr> <td>0.079</td> <td>0.008</td> <td>0.002</td> <td>0.009</td> <td>0.002</td> </tr> <tr> <td>0.118</td> <td>0.010</td> <td>0.002</td> <td>0.009</td> <td>0.002</td> </tr> <tr> <td>0.157</td> <td>0.011</td> <td>0.002</td> <td>0.009</td> <td>0.002</td> </tr> <tr> <td>0.197</td> <td>0.012</td> <td>0.002</td> <td>0.010</td> <td>0.002</td> </tr> </tbody> </table>	Groove width : CW (in)	External (ipr)	Internal (ipr)	Face (ipr)	Parting (ipr)	0.079	0.008	0.002	0.009	0.002	0.118	0.010	0.002	0.009	0.002	0.157	0.011	0.002	0.009	0.002	0.197	0.012	0.002	0.010	0.002
Groove width : CW (in)	External (ipr)	Internal (ipr)	Face (ipr)	Parting (ipr)																							
0.079	0.008	0.002	0.009	0.002																							
0.118	0.010	0.002	0.009	0.002																							
0.157	0.011	0.002	0.009	0.002																							
0.197	0.012	0.002	0.010	0.002																							
<p>WGE R/L</p>  <p>F227 page</p>	<p>Handed insert Minimize burr generation when workpiece is cut off CW = 0.079" - 0.197"</p>	<table border="1"> <caption>WGE R/L Feed Performance Data</caption> <thead> <tr> <th>Groove width : CW (in)</th> <th>Parting (ipr)</th> </tr> </thead> <tbody> <tr> <td>0.079</td> <td>0.003</td> </tr> <tr> <td>0.118</td> <td>0.006</td> </tr> <tr> <td>0.157</td> <td>0.006</td> </tr> <tr> <td>0.197</td> <td>0.006</td> </tr> </tbody> </table>	Groove width : CW (in)	Parting (ipr)	0.079	0.003	0.118	0.006	0.157	0.006	0.197	0.006															
Groove width : CW (in)	Parting (ipr)																										
0.079	0.003																										
0.118	0.006																										
0.157	0.006																										
0.197	0.006																										

- External
- Internal
- Face
- Parting
- Others

External grooving and turning

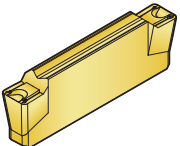
<p>WGT</p>  <p>F226 page</p>	<p>1st choice for turning Low cutting force and good chip control for traversing CW = 0.118" - 0.197"</p>	<table border="1"> <caption>WGT Depth of Cut vs Feed Performance</caption> <thead> <tr> <th>Feed: f (ipr)</th> <th>WGT50 (ap in)</th> <th>WGT40 (ap in)</th> <th>WGT30 (ap in)</th> </tr> </thead> <tbody> <tr> <td>0.002</td> <td>0.079</td> <td>0.079</td> <td>0.039</td> </tr> <tr> <td>0.004</td> <td>0.079</td> <td>0.079</td> <td>0.039</td> </tr> <tr> <td>0.006</td> <td>0.079</td> <td>0.079</td> <td>0.039</td> </tr> <tr> <td>0.008</td> <td>0.079</td> <td>0.079</td> <td>0.039</td> </tr> <tr> <td>0.010</td> <td>0.079</td> <td>0.079</td> <td>0.039</td> </tr> <tr> <td>0.012</td> <td>0.079</td> <td>0.079</td> <td>0.039</td> </tr> </tbody> </table>	Feed: f (ipr)	WGT50 (ap in)	WGT40 (ap in)	WGT30 (ap in)	0.002	0.079	0.079	0.039	0.004	0.079	0.079	0.039	0.006	0.079	0.079	0.039	0.008	0.079	0.079	0.039	0.010	0.079	0.079	0.039	0.012	0.079	0.079	0.039
Feed: f (ipr)	WGT50 (ap in)	WGT40 (ap in)	WGT30 (ap in)																											
0.002	0.079	0.079	0.039																											
0.004	0.079	0.079	0.039																											
0.006	0.079	0.079	0.039																											
0.008	0.079	0.079	0.039																											
0.010	0.079	0.079	0.039																											
0.012	0.079	0.079	0.039																											

MY-T SERIES

CCH

External grooving and parting blade, for 1 corner inserts

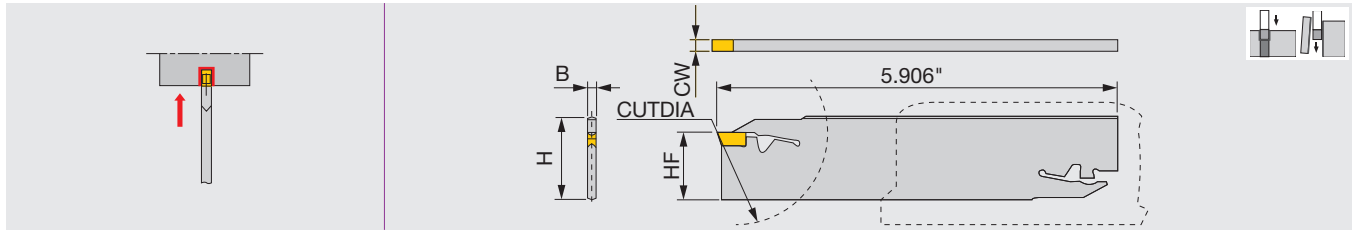

Inch	CW	CUTDIA	H	B	HF	Insert
CCH26-30	0.118	2.76	0.979	0.087	0.843	GE30,GE30R/L,GE30-AL
CCH26-40	0.157	2.76	0.968	0.126	0.837	GE40,GE40R/L,GE40-AL
CCH32-30U	0.118	3.94	1.230	0.087	0.968	GE30,GE30R/L,GE30-AL
CCH32-40U	0.157	3.94	1.220	0.126	0.963	GE40,GE40R/L,GE40-AL
CCH32-50U	0.197	4.72	1.210	0.165	0.958	GE50,GE50R/L,GE50-AL

CUTDIA: Max. parting dia.

SPARE PARTS

Designation	Wrench
CCH**-...	CTL-2

CCBS-32

Tool block for CCH blade

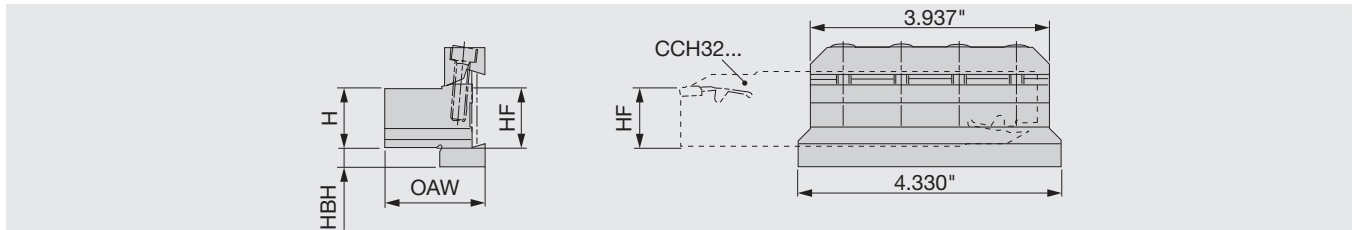

Inch	H	HF	HBH	OAW	Blade
CCBS12-32-U	0.750	0.75	0.55	1.49	CCH32...
CCBS16-32-U	1.000	1.00	0.30	1.66	CCH32...
CCBS20-32-U	1.250	1.25	0.21	1.66	CCH32...

SPARE PARTS

Designation	Clamp	Screw	Wrench
CCBS**-32-U	CC-32	CM6X25	P-5

Reference pages: Inserts → **F230 - F232**, Standard cutting conditions → **F235**

INSERT

GE-R/L

For parting (with hand)

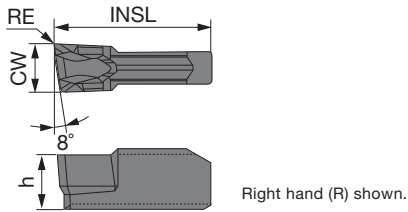

P	Steel	★	★							
M	Stainless	★	★							
K	Cast iron	★	☆							
N	Non-ferrous									
S	Superalloys	☆								
H	Hard materials									

★ : First choice
☆ : Second choice

Designation	HAND	CW ₀ ^{+0.1} (mm)	CW ₀ ^{+0.004} (in)	RE (in)	Coated						INSL (in)	h (in)	
					AH120	GH730							
GE30R	R	3	0.118	0.008	●	●						0.394	0.138
GE30L	L	3	0.118	0.008		●						0.394	0.138
GE40R	R	4	0.157	0.008	●	●						0.394	0.157
GE40L	L	4	0.157	0.008		●						0.394	0.157
GE50R	R	5	0.197	0.008		●						0.472	0.177
GE50L	L	5	0.197	0.008	●	●						0.472	0.177

● : Line up

GE

For general grooving

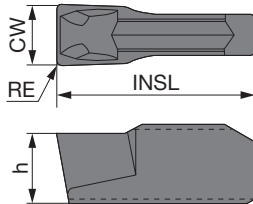

P	Steel	★	☆	★	★				★				
M	Stainless	★		★	★								
K	Cast iron	☆		★	☆				☆				
N	Non-ferrous												
S	Superalloys				☆								
H	Hard materials												

★ : First choice
☆ : Second choice

Designation	CW ₀ ^{+0.1} (mm)	CW ₀ ^{+0.004} (in)	RE (in)	Coated				Cermet		INSL (in)	h (in)
				T9225	T9125	AH120	GH730	NS9530			
GE20	2	0.079	0.008			●	●	●		0.394	0.138
GE30	3	0.118	0.008	●	▲	●	●	●		0.394	0.138
GE40	4	0.157	0.008	●	▲	●	●	●		0.394	0.157
GE50	5	0.197	0.008	●	▲	●	●	●		0.472	0.177

● : Line up
▲ : To be discontinued

Reference pages: Toolholders → **F229**, Standard cutting conditions → **F235**

GF

For face grooving

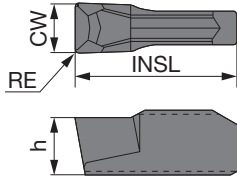

P	Steel	★			★				
M	Stainless	★							
K	Cast iron	☆			☆				
N	Non-ferrous								
S	Superalloys								
H	Hard materials								

★ : First choice
☆ : Second choice

Designation	CW ^{+0.1} ₀ (mm)	CW ^{+0.004} ₀ (in)	RE (in)	Coated		Cermets		INSL (in)	h (in)
				GH730		NS9530			
GF30	3	0.118	0.008	●		●		0.394	0.138
GF40	4	0.157	0.008	●		●		0.394	0.157
GF50	5	0.197	0.008	●		●		0.472	0.177

● : Line up

GN

For internal grooving

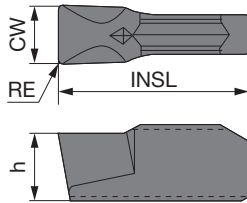

P	Steel	★							
M	Stainless	★							
K	Cast iron	☆							
N	Non-ferrous								
S	Superalloys								
H	Hard materials								

★ : First choice
☆ : Second choice

Designation	CW ^{+0.1} ₀ (mm)	CW ^{+0.004} ₀ (in)	RE (in)	Coated				INSL (in)	h (in)
				GH730					
GN30	3	0.118	0.008	●				0.394	0.138
GN40	4	0.157	0.008	●				0.394	0.157
GN50	5	0.197	0.008	●				0.472	0.177

● : Line up



GT

For turning

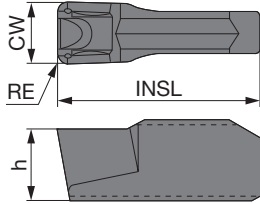

P	Steel	★	☆	★	★			★				
M	Stainless	★		★	★							
K	Cast iron	☆		★	☆			☆				
N	Non-ferrous											
S	Superalloys				☆							
H	Hard materials											

★ : First choice
☆ : Second choice

Designation	CW ^{+0.1} ₀ (mm)	CW ^{+0.004} ₀ (in)	RE (in)	Coated				Cermets				INSL (in)	h (in)	
				T9225	T9125	AH120	GH730	NS9530						
GT30	3	0.118	0.016			●	●			●			0.394	0.138
GT40	4	0.157	0.016			●	●			●			0.394	0.157
GT50	5	0.197	0.016	●	▲	●	●			●			0.472	0.177

● : Line up
▲ : To be discontinued

- External
- Internal
- Face
- Parting
- Others

GE-AL

For aluminum and non-ferrous metal

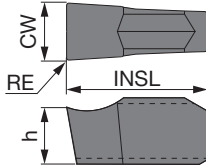

P	Steel											
M	Stainless											
K	Cast iron											
N	Non-ferrous	★										
S	Superalloys											
H	Hard materials											

★ : First choice
☆ : Second choice



Designation	CW ^{+0.1} ₀ (mm)	CW ^{+0.004} ₀ (in)	RE (in)	Uncoated								INSL (in)	h (in)	
				KS05F										
GE20-AL	2	0.079	0.008	●									0.394	0.138
GE30-AL	3	0.118	0.008	●									0.394	0.138
GE40-AL	4	0.157	0.008	●									0.394	0.157

● : Line up

Reference pages: Toolholders → **F229**, Standard cutting conditions → **F235**

1 corner insert

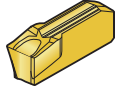
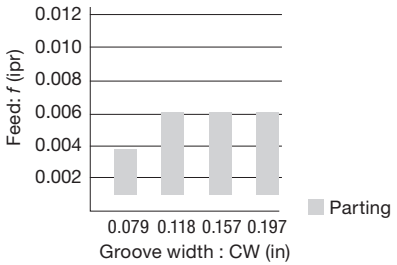
External grooving and parting

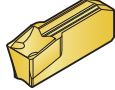
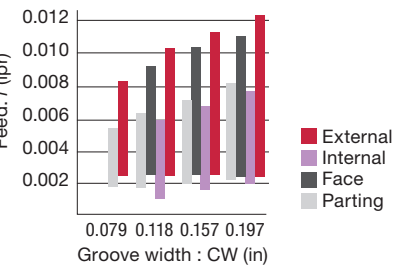
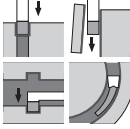
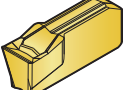
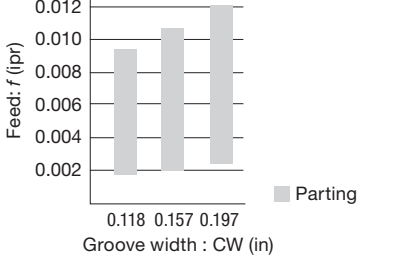
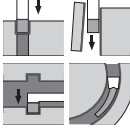
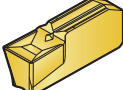
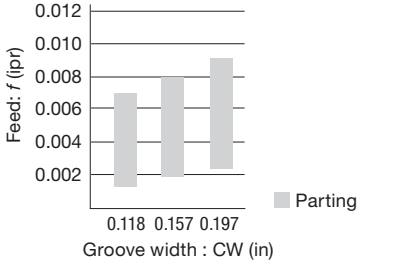
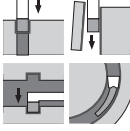

<p>GE R/L</p>  <p>F230 page</p>	<p>Handed insert Minimize burr generation when workpiece is cut off</p> <p>CW = 0.118" - 0.197"</p>	 
<p>GE</p>  <p>F230 page</p>	<p>1st choice for external grooving and parting Excellent chip control</p> <p>CW = 0.079" - 0.197"</p>	 
<p>GF</p>  <p>F231 page</p>	<p>1st choice for face grooving Low cutting force and good chip control for face grooving</p> <p>CW = 0.118" - 0.197"</p>	 
<p>GN</p>  <p>F231 page</p>	<p>1st choice for internal grooving Low cutting force and good chip control for internal grooving</p> <p>CW = 0.118" - 0.197"</p>	 

1 corner insert

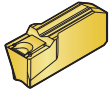
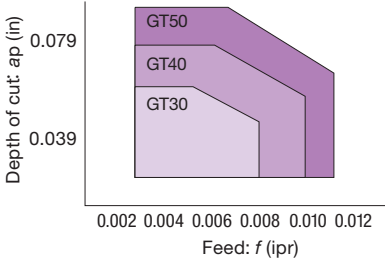
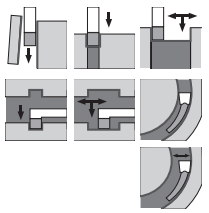
External grooving and turning

<p>GT</p>  <p>F232 page</p>	<p>1st choice for turning Low cutting force and good chip control for traversing</p> <p>CW = 0.118" - 0.197"</p>	 
---	--	--

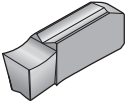
For aluminum and non-ferrous metal

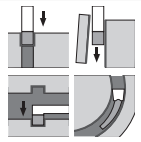
<p>GE-AL</p>  <p>F232 page</p>	<p>Reduce cutting force and welding due to sharp chipbreaker</p> <p>CW = 0.079" - 0.157"</p>	 
--	--	---

STANDARD CUTTING CONDITIONS

ISO	Workpiece material	Grade	Cutting speed Vc (sfm)
P	Low carbon steel, Alloy steel (- HB150)	T9225	262 - 984
		NS9530	328 - 656
		GH730	164 - 591
	Medium carbon steel, Alloy steel (HB150 - 250)	T9225	262 - 722
		NS9530	262 - 591
		GH730	164 - 492
High carbon steel, Alloy steel (HB250 -)	T9225	262 - 722	
	NS9530	262 - 492	
	GH730	164 - 394	
M	Stainless steel	T9225	262 - 591
GH730		164 - 394	
K	Gray iron, Ductile cast iron	T9225	262 - 820
		GH730	164 - 591
N	Aluminum alloys, Non-ferrous metal	KS05F	656 - 984

For Parting off

Operation	Feed: <i>f</i> (ipr)			
	Groove width: CW (in)			
	2 mm (0.079")	3 mm (0.118")	4 mm (0.157")	5 mm (0.197")
Grooving (GE**)	0.0024 - 0.008	0.0024 - 0.010	0.0028 - 0.011	0.0028 - 0.012
Parting off (GE**R/L)	0.0016 - 0.004	0.0016 - 0.006	0.0016 - 0.006	0.0016 - 0.006
Traversing (GT**)	-	Depth of cut <i>ap</i> = 0.020 - 0.059 <i>f</i> = 0.0024 - 0.008	Depth of cut <i>ap</i> = 0.020 - 0.079 <i>f</i> = 0.0024 - 0.010	Depth of cut <i>ap</i> = 0.020 - 0.098 <i>f</i> = 0.0024 - 0.011
Parting off for Aluminum alloys (GE**-AL)	0.0012 - 0.004	0.0012 - 0.004	0.0012 - 0.004	-

For diameter compensation values in traversing, see page **F111**.

Grade
Insert
Ext. Toolholder
Int. Toolholder
Threading
Grooving
Miniature Tool
Milling Cutter
Endmill
Drilling Tool
Tooling System
User's Guide
Index



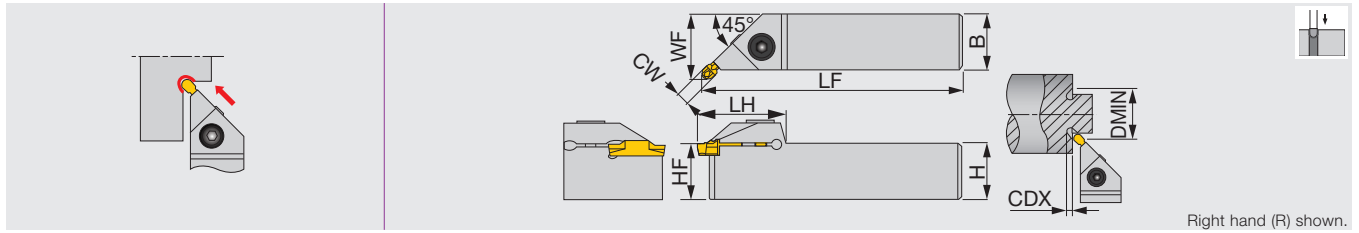

Right hand (R) shown.

Metric	CW	DMIN	Seat size	CDX	H	B	LF	LH	HF	WF (1)	Insert	Torque
CGEUR/L1616-3T02	3	32	3	2.8	16	16	110	30	16	19.3	DTIU...	5
CGEUR/L2020-3T02	3	32	3	2.8	20	20	125	30	20	23.3	DTIU...	5
CGEUR/L2525-3T02	3	32	3	2.8	25	25	150	30	25	28.3	DTIU...	5
CGEUR/L1616-4T02	4	32	4	2.8	16	16	110	31	16	19.5	DTIU...	8.5
CGEUR/L2020-4T02	4	32	4	2.8	20	20	125	31	20	23.5	DTIU...	8.5
CGEUR/L2525-4T02	4	32	4	2.8	25	25	150	31	25	28.5	DTIU...	8.5
CGEUR/L2525-6T03	6	34	5, 6	3.4	25	25	150	35	25	28.9	DTIU...	8.5

(1) "WF" value is calculated with groove width "CW" shown in the table.
Torque: Recommended clamping torque: N·m

SPARE PARTS		
Designation	Clamping screw	Wrench
CGEUR/L****-3T02	CM5X0.8X16-A	P-4
CGEUR/L1616-4T02	CM6X1X16-A	P-5
CGEUR/L2020-4T02	CM6X1X20-A	P-5
CGEUR/L2525-4T02/6T03	CM6X1X25-A	P-5

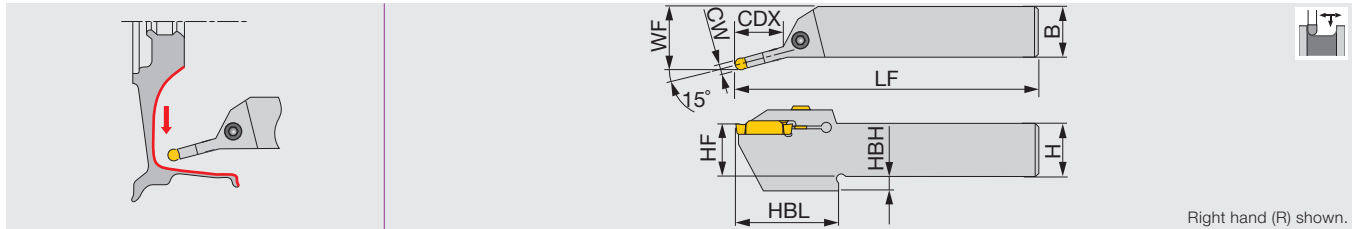

Right hand (R) shown.

Metric	CW	Seat size	CDX	H	B	LF	HF	WF	HBH	HBL	Insert	Torque
CTER/L2525-6T25-15A	6	6	25	25	25	150	25	32.2	7	50.5	DTA...	5
CTER/L2525-8T30-15A	8	8	30	25	25	150	25	32.9	7	55	DTA...	5

Torque: Recommended clamping torque: N·m

SPARE PARTS		
Designation	Clamping screw	Wrench
CTER/L2525-****-15A	CM6X1X25-A	P-5

INSERT

DTIU

Profiling and undercutting (for high precision)

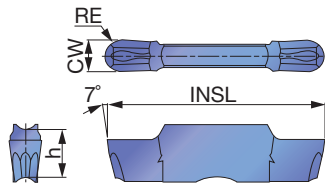

P	Steel	★	☆	☆																
M	Stainless	★	☆	★																
K	Cast iron	★		☆																
N	Non-ferrous																			
S	Superalloys	★	☆																	
H	Hard materials																			

★ : First choice
☆ : Second choice

Designation	Seat size	CW±0.0008 (in)	CW±0.02 (mm)	RE (mm)	Coated							INSL (in)	h (in)		
					AH7025	AH725	GH130								
DTIU300-150	3	0.118	3	1.5	●	●	●							0.787	0.197
DTIU400-200	4	0.157	4	2	●	●	●							0.787	0.197
DTIU500-250	5	0.197	5	2.5	●	●	●							0.984	0.217
DTIU600-300	6	0.236	6	3	●	●	●							0.984	0.217

● : Line up

DTA

Aluminum wheel machining (for high precision)

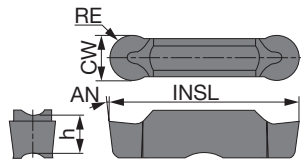

P	Steel																			
M	Stainless																			
K	Cast iron																			
N	Non-ferrous				★															
S	Superalloys																			
H	Hard materials																			

★ : First choice
☆ : Second choice

Designation	Seat size	CW±0.0008 (in)	CW±0.02 (mm)	RE (mm)	Uncoated							INSL (in)	h (in)	AN		
					TH10											
DTA600-300	6	0.236	6	3	●									0.984	0.217	7°
DTA800-400	8	0.315	8	4	●									1.181	0.264	10°

● : Line up

Grade
Insert
Ext. Toolholder
Int. Toolholder
Threading
Grooving
Miniature Tool
Endmill
Drilling Tool
Tooling System
Index



STANDARD CUTTING CONDITIONS

ISO	Workpiece material	Hardness	Priority	Grade	Cutting speed Vc (sfm)
P	Steel 1045, 4135, etc.	< 300 HB	First choice	AH7025, AH725	164 - 591
		< 300 HB	Priority for wear resistance	T9225	262 - 984
		< 300 HB	Priority for impact resistance	GH130	164 - 394
		< 300 HB	Priority for surface finish	NS9530	262 - 722
M	Stainless steel 304SS, 316SS, 17-4 PH, etc.	< 200 HB	First choice	AH7025, AH725	164 - 394
		< 200 HB	Priority for impact resistance	GH130	164 - 394
K	Gray cast iron No.250B, No.300B, etc.	-	First choice	T515, AH7025	164 - 591
		-	Priority for impact resistance	GH130	164 - 591
	Ductile cast iron 60-40-18, 60-55-06, etc.	-	First choice	T515, AH7025	164 - 394
		-	Priority for impact resistance	GH130	164 - 394
N	Aluminum alloys Si < 12%	-	First choice	TH10	328 - 1640
		-	First choice	KS05F	328 - 1969
S	Superalloys Inconel 718, etc.	< HRC 40	First choice	AH7025	66 - 197
		< HRC 40	Priority for wear resistance	AH905	66 - 262
	Titanium alloys Ti-6Al-4V, etc.	< HRC 40	First choice	AH905	66 - 262
		< HRC 40	Priority for impact resistance	AH7025, AH725	66 - 262
		< HRC 40	Priority for surface finish	KS05F	66 - 197
H	Hardened steel 4137, etc.	> HRC 50	First choice	BX360	262 - 492

*Please see below for feed: f (ipr).



TUNGCUT - Chipbreaker Guide

Profiling and undercutting

**DTIU type
(2 corners)**

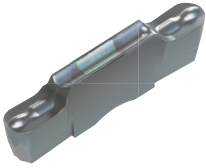

F237 page

Full radius type

Excellent chip control
For undercutting
CW = 0.118" - 0.236"

Standard feed and DoC

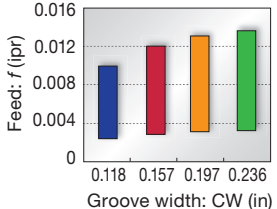

Aluminum wheel machining

**DTA type
(2 corners)**

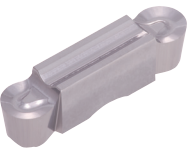

F237 page

Full radius type

Excellent chip control
For aluminum wheel profiling
Ground insert
CW = 0.236" - 0.315"

Standard feed and DoC

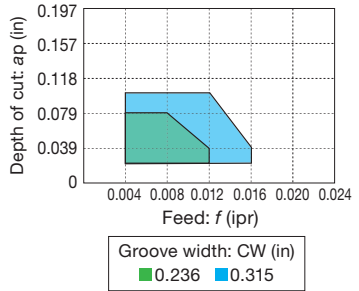

AH7025 Cutting performance

First choice grade for grooving

AH7025 grade: Tungaloy's unique coating technology for drastically improved reliability

Tool life comparison



Tool wear after 60 grooves

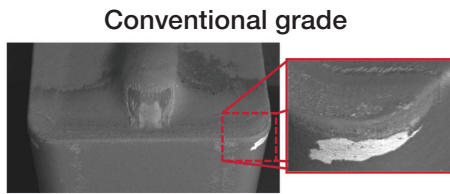

Tool wear after 30 grooves

P Alloy steel
(4140)

Insert : DTE3-040 AH7025
Cutting speed: $V_c = 492$ sfm
Feed : $f = 0.007$ ipr
Groove depth : 0.669"
Machining : External grooving
Coolant : Wet

AH7025 provides stability, while preventing coating from peeling off even after machining twice the number of passes compared to the conventional grade.

→ **The combination of Nano-multi-layered AlTiN Coating with high Al content and tough substrate provides highly efficient machining in various grooving operations.**

Grades

AH7025

P M K S

- First choice for various applications
- New PVD coating with high Al content provides excellent adhesion strength
- Improved wear and chipping resistance

AH725

P M S

- Recommended for various applications
- Newly developed coating with well controlled crystal structure and fracture resistance
- Improved adhesion strength

T515

K

- First recommended grade for cast iron
- Excellent wear resistance in high-speed machining

T9225

P

- Suitable for steel machining at high speeds
- New CVD coating and substrate deliver an outstanding balance of wear and chipping resistance

NS9530

P

- Advanced cermet for finish cutting of steel
- Innovative grade with incredible fracture and high wear resistance

GH130

P M K

- Recommended for interrupted machining
- TiCNO PVD coating layer with high wear resistance
- High hardness wear resistance

AH905

S

- Remarkable for machining of heat resistant alloys
- Exclusive coating layer improves adhesion strength and wear resistance

KS05F

N S

- Recommended for non-ferrous materials and titanium

TH10

N

- Recommended for non-ferrous materials

BX360

H

- Suitable for hardened steel machining
- Ideal balance of wear and chipping resistance due to the optimum CBN content and grain size



PARTS FOR COOLANT HOSE

Connecting hose

Fig.1

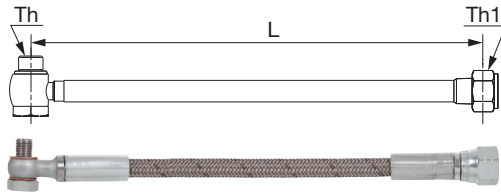
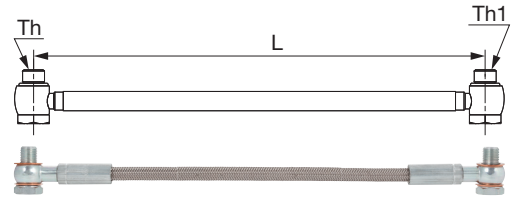
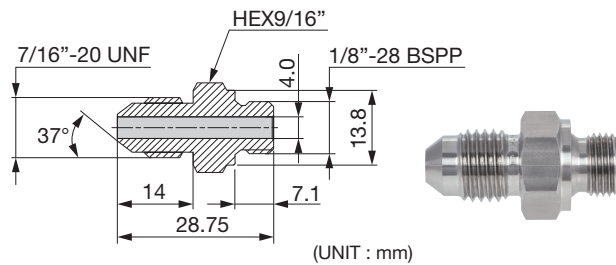

Fig.2



Designation	Length L (in)	Screw		Max. pressure (Mpa)	Fig.
		Th	Th1		
CHP-HOSE-G1/8-7/16-200BS	7.874	G1/8"-28 BSPP	7/16"-20 UNF	26	1
CHP-HOSE-G1/8-7/16-250BS	9.843	G1/8"-28 BSPP	7/16"-20 UNF	26	1
CHP-HOSE-5/16-7/16-200BS	7.874	5/16"-24UNF	7/16"-20 UNF	20	1
CHP-HOSE-5/16-G1/8-200BS	7.874	5/16"-24UNF	G1/8"-28 BSPP	20	1
CHP-HOSE-G1/8-G1/8-200BB	7.874	G1/8"-28 BSPP	G1/8"-28 BSPP	26	2
CHP-HOSE-G1/8-G1/8-250BB	9.843	G1/8"-28 BSPP	G1/8"-28 BSPP	26	2

Connector



Designation

CHP-NIPPLE-G1/8-7/16UNF

Seal washer

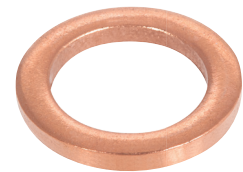
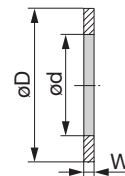

Designation

Designation	øD	ød	W
CHP-COPPER-SEAL1/8	0.591	0.394	0.039
CHP-COPPER-SEAL5/16	0.469	0.321	0.053
CHP-COPPER-SEAL5/16-2.5	0.370	0.315	0.098

(UNIT : in)

Connector for small lathe with seal washer

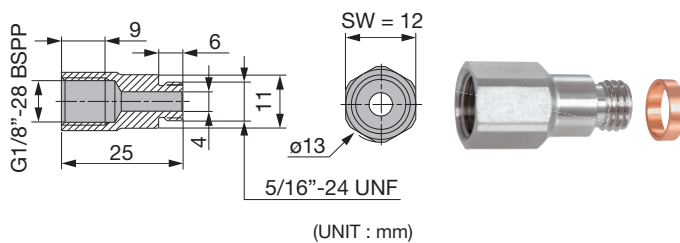

Designation

CHP-CONNECTOR5/16-G1/8

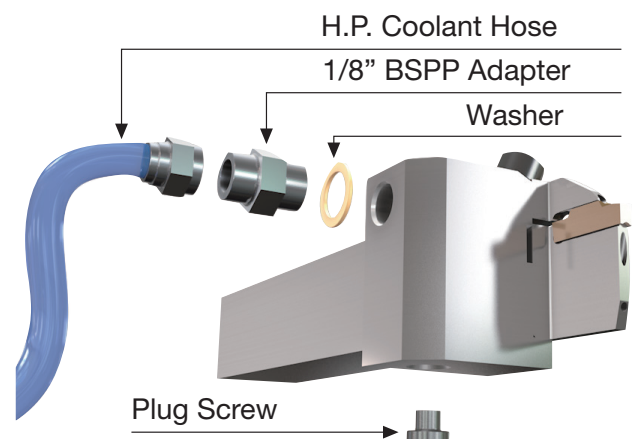

Miniature Machining



Miniature Machining - Content structure

- Products are listed by application.
- In the same application, products are listed by cutting edge shape.
- The same cutting edge shape are sorted by insert.
- Items are listed by product series.
- Toolholders in the catalog are our standard stock items.

How to use the page

Method ① Select the application and the cutting edge shape described at the left end of each page, jump to the page on the left index, and choose a designation you need (⑤) in the dimension table (④). Applicable inserts are shown in (⑦) and (⑨).

Method ② Select the cutting edge on **G003** and check the details on the product page.

Method ③ Select the series name on **G003** and check the details on each page.

Method ④ Select an item from Quick Guide on **G004 - G019**.

③ **MINIFURN**
Screw-on toolholder with 95° approach angle, for WXGU inserts

① Application: JPWL2XR/L

② Cutting edge shape: L

Cutting edge style L2									
Inch	H	B	LF	LH	HF	WF	RE**	Insert	Torque
JPWL2XR/L082	0.375	0.375	4.750	0.500	0.375	0	0.008	WXGU0402**LR	0.66
JPWL2XR/L082	0.500	0.500	4.750	0.500	0.500	0	0.008	WXGU0402**LR	0.66
JPWL2XR/L082	0.625	0.625	4.750	0.500	0.625	0	0.008	WXGU0402**LR	0.66
Metric									
JPWL2XR/L1010D04	10	10	120	11	10	0	0.2	WXGU0402**LR	0.9
JPWL2XR/L1212F04	12	12	85	11	12	0	0.2	WXGU0402**LR	0.9
JPWL2XR/L1212F04	12	12	120	11	12	0	0.2	WXGU0402**LR	0.9
JPWL2XR/L1616D04	16	16	120	13	16	0	0.2	WXGU0402**LR	0.9

⑤ Toolholder designation: JPWL2XR/L

④ Dimension table

⑦ Applicable insert: WXGU0402**LR

SPARE PARTS

Description	Clamping screw	Coolant unit	Wrench 1	Coolant plug	Wrench 2	Direct/lat plug	Wrench
JPWL2XR/L	SU-V2	Bu-PC-2	SPH00001	HW003	HW002	HW001	HW004

INSERT SELECTION

Swiss lathes

Application	Grade	Chipbreaker shape	Chipbreaker slope	Cutting conditions
Finish cutting	JSS	SH725	JS	SH725
Medium to finish cutting	MS	SH725	TS	SH725
Application	Grade	Chipbreaker shape	Chipbreaker slope	Cutting conditions
Finish cutting	JSS	SH725	JS	SH725
Medium to finish cutting	MS	SH725	TS	SH725

Small CNC lathes

Application	Grade	Chipbreaker shape	Chipbreaker slope	Cutting conditions
Finish cutting	SS	AN725	TS	AN725
Medium cutting	MS	AN725	TS	AN725
Application	Grade	Chipbreaker shape	Chipbreaker slope	Cutting conditions
Finish cutting	SS	AN725	TS	AN725
Medium cutting	MS	AN725	TS	AN725

Reference pages: JPWL2XR/L: Inserts → B161 -, Standard cutting conditions → G069

G024 www.tungaloy.com/us

TUNGLAY
Screw-on toolholder with 95° approach angle, for WXGU inserts, with high pressure coolant capability

⑥ Dimension drawing (conforming to ISO13399)

Cutting edge style L2										
Inch	H	B	LF	LH	HF	WF	OAW	RE**	Insert	Torque
JSWL2XR/L082-CHP	0.500	0.500	4.750	0.728	0.500	0	0.650	0.008	WXGU0402**LR	0.66
JSWL2XR/L082-CHP	0.625	0.625	4.750	0.728	0.625	0	0.650	0.008	WXGU0402**LR	0.66
JSWL2XR/L1212D04-CHP	12	12	120	18.5	12	0	16.5	0.2	WXGU0402**LR	0.9
JSWL2XR/L1616D04-CHP	16	16	120	18.5	16	0	16.5	0.2	WXGU0402**LR	0.9

⑧ Spare parts

Description	Clamping screw	Coolant unit	Wrench 1	Coolant plug	Wrench 2	Direct/lat plug	Wrench
JSWL2XR/L-CHP	SP34-514	S-CU-CHP	T-3F	SRU16UNF1L300	P-4	SRM44-6-18	P-2

⑨ Insert selection

Swiss lathes

Application	Grade	Chipbreaker shape	Chipbreaker slope	Cutting conditions
Finish cutting	JSS	SH725	JS	SH725
Medium to finish cutting	MS	SH725	TS	SH725
Application	Grade	Chipbreaker shape	Chipbreaker slope	Cutting conditions
Finish cutting	JSS	SH725	JS	SH725
Medium to finish cutting	MS	SH725	TS	SH725

Small CNC lathes

Application	Grade	Chipbreaker shape	Chipbreaker slope	Cutting conditions
Finish cutting	SS	AN725	TS	AN725
Medium cutting	MS	AN725	TS	AN725
Application	Grade	Chipbreaker shape	Chipbreaker slope	Cutting conditions
Finish cutting	SS	AN725	TS	AN725
Medium cutting	MS	AN725	TS	AN725

Reference pages: JSWL2XR/L-CHP: Inserts → B161 -, Standard cutting conditions → G069

Tungaloy G025

- ① : Application
- ② : Cutting edge shape
- ③ : Tool series name
- ④ : Dimension table
- ⑤ : Toolholder designation
e.g. right-hand, 25x25 square shank
- ⑥ : Dimension drawing (conforming to ISO13399)
- ⑦ : Applicable insert
- ⑧ : Spare parts
- ⑨ : Insert selection
- ⑩ : Reference page

→ **JSDJ2XR082** X-CHP

When ordering

- Please specify the designation and quantity.

e.g. **JSWL2XR082X-CHP** ... 1 (one toolholder per package)

* Inserts are not included. Please order those separately.

Main products

L		G023
J		G031
N		G047
P		G050
A		G051
G		G053
D		G054
F		G055
Special		G056





			Inch	Metric
	MINIFORCE Economical double-sided inserts with excellent sharpness 	G022 - G024, G026, G031 - G032 G035, G040, G042 - G043, G069	✓	✓
	J-SERIES Toolholders for small-part machining 	G004 - G008, G013, G015 G027 - G030, G036, G038 - G039 G044, G046 - G056, G058, G060 - G069, G096 - G102, G108 - G110, F103 - F110	✓	✓
	TETRAMCUT Unique insert pocket geometry for grooving with high quality and precision 	CW = 0.013" - 0.118" (0.33 - 3.0 mm) G012 - G013, G016, G080 - G090 F006 - F007, F037 - F048	✓	✓
	TETRAFORCE 4-cornered insert with good clamping rigidity for highly precise grooving and parting 	CW = 0.020" - 0.125" (0.5 - 3.18 mm) G013, G091 - G095, F006 - F007, F049 - F057	✓	✓
	DUOJUST Innovative clamping system for high rigidity in parting 	CW = 0.039" - 0.079" (1.0 - 2.0 mm) G014, G016 G111 - G112, G114 - G119	✓	✓
	TUNG CUT Multi-functional tool series for various grooving operations 	CW = 0.055" - 0.157" (1.4 - 4.0 mm) G015, G102 - G130, F006 - F036 F116 - F136, F171 - F192	✓	✓
	TINY M TURN Solid boring bar for turning small diameters with high precision 	G019, G070 - G079	☐	✓
	TUNG HEAVY GROOVE Highly rigid clamping for wide grooving and profiling in one pass CW = 0.394" - 0.984" (10 - 25 mm)	G014, G103 - G104 F006 - F007, F089 - F092	✓	☐

Miniature External Turning - Quick Guide

Facing





Application	Designation	Insert		Shank size (mm)				Clamping style	Page
		Positive type	Negative type	0	10	20	30		
	JSDFCR/L Cutting edge angle 91° Insert: DC□□	✓			12	16		Screw-on clamping with offset	G055

External Turning

Application	Designation	Insert		Shank size (mm)				Clamping style	Page
		Positive type	Negative type	0	10	20	30		
	JTTACR/L Cutting edge angle 91° Insert: TC□□	✓			8	16		Back side clamping without offset	G051
	JSTACR/L Cutting edge angle 91° Insert: TC□□	✓			8	16		Screw-on clamping without offset	G051
	JSCGCR/L Cutting edge angle 91° Insert: CC□□	✓			12	16		Screw-on clamping with offset	G053
	JTTANR/L Cutting edge angle 91° Insert: TN□□		✓		12	16		Back side clamping without offset	G060

Back Turning

Application	Designation	Insert		Shank size (in)					Clamping style	Page
		Positive type	Negative type	0	0.375	0.500	0.750	1.000		
	JSTBR/L Insert: JTBR/L3□□	✓			0.375"	0.625"			Screw-on clamping	G061



Application	Designation	Insert		Shank size (mm)				Clamping style	Page
		Positive type	Negative type	0	10	20	30		
	JSTBR/L Insert: JTBR/L3□□	✓			10	16		Screw-on clamping	G061
	JS-TBL3 Insert: JTBR3□□	✓			ø19.05	ø25.4		Screw-on clamping	G061
	JSEGR/L Insert: J10ER/L□□	✓			10	16		Screw-on clamping	G064
	JSXBR/L Insert: JXBR/L8□□	✓			10	25		Screw-on clamping	G067

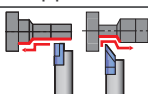

Miniature External Turning - Quick Guide

Front & Reverse Turning

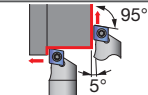
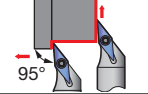
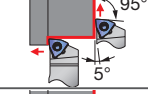
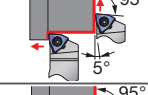
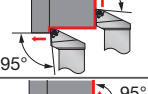
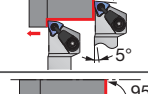
Metric	Application	Designation	Insert		Shank size (mm)				Clamping style	Page
			Positive type	Negative type	0	10	20	30		
		JSXGR/L Insert: JXFR/L8 JXRR/L8	✓		10			25	Screw-on clamping	G056

External Turning & Facing

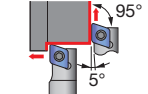
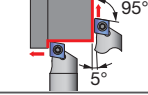
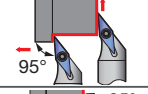
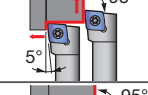
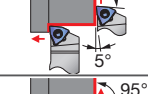
Inch	Application	Designation	Insert			Shank size (in)					Clamping style	Page
			MiniForce-Turn	ISO Positive type	ISO Negative type	0	0.375	0.500	0.750	1.000		
		JSCL2CR/L Cutting edge angle 95° Insert: CC□□		✓		0.375"				0.625"	Screw-on clamping without offset	G027
		JSVL2PR/L Cutting edge angle 95° Insert: VP□□		✓		0.500"				0.625"	Screw-on clamping without offset	G030
		JPWL2XR/L Cutting edge angle 95° Insert: WXGU	✓	✓		0.375"				0.625"	Side clamping without offset	G024
		JSWL2XR/L Cutting edge angle 95° Insert: WXGU	✓	✓		0.375"				0.625"	Screw-on clamping without offset	G023
		JSWLXR/L Cutting edge angle 95° Insert: WXGU	✓	✓						0.750" 1.000"	Screw-on clamping with offset	G034
		JSWL2XR/L-CHP Cutting edge angle 95° Insert: WXGU	✓	✓		0.500"				0.625"	Screw-on clamping without offset	G025
		JSWLXR-F Cutting edge angle 95° Insert: WXGU	✓	✓		0.500"				0.625"	Screw-on clamping with offset	G026

Metric	Application	Designation	Insert			Shank size (mm)				Clamping style	Page	
			MiniForce-Turn	ISO Positive type	ISO Negative type	0	10	20	30			
		JTCL2CR/L Cutting edge angle 95° Insert: CC□□		✓		8				16	Back side clamping without offset	G028
		JSCL2CR/L Cutting edge angle 95° Insert: CC□□		✓		10				16	Screw-on clamping without offset	G027
		JSVL2PR/L Cutting edge angle 95° Insert: VP□□		✓		10				16	Screw-on clamping without offset	G030
		JSCLCR/L Cutting edge angle 95° Insert: CC□□		✓		8				16	Screw-on clamping with offset	G029
		JPWL2XR/L Cutting edge angle 95° Insert: WXGU	✓	✓		10				16	Side clamping without offset	G024
		JSWL2XR/L Cutting edge angle 95° Insert: WXGU	✓	✓		10				20	Screw-on clamping without offset	G023

Grade
Insert
Toolholder
Ext. Toolholder
Int. Toolholder
Threading
Grooving
Miniature Tool
Milling Cutter
Endmill
Drilling Tool
Tooling System
User's Guide
Index





Miniature External Turning - Quick Guide

External Turning & Facing

Metric		Insert			Shank size (mm)				Clamping style	Page
Application	Designation	MiniForce-Turn	ISO Positive type	ISO Negative type	0	10	20	30		
	JSWLXR/L Cutting edge angle 95° Insert: WXGU	✓	✓				20	25	Screw-on clamping with offset	G034
	JSWL2XR/L-CHP Cutting edge angle 95° Insert: WXGU	✓	✓			12		16	Screw-on clamping without offset	G025
	JSWLXR-F Cutting edge angle 95° Insert: WXGU	✓	✓			10		16	Screw-on clamping with offset	G026
	PCLNR Cutting edge angle 95° Insert: CN□□			✓				20	Lever-lock clamping with offset	G057
	PCL2NR Cutting edge angle 95° Insert: CN□□			✓				20	Lever-lock clamping without offset	G057
	JTTLNR/L Cutting edge angle 95° Insert: TN□□			✓		12		16	Back side clamping without offset	G058
	PTL2NR/L Cutting edge angle 95° Insert: TN□□			✓				20	Lever-lock clamping without offset	G058

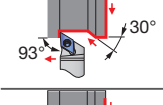
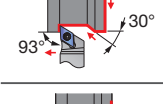
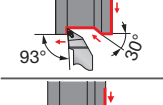
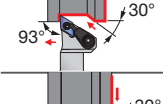
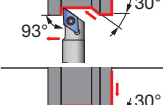
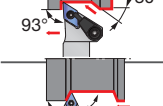
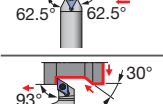
External Turning & Profiling

Inch		Insert			Shank size (in)					Clamping style	Page
Application	Designation	MiniForce-Turn	ISO Positive type	ISO Negative type	0	0.375	0.500	0.750	1.000		
	JPDJ2XR/L Cutting edge angle 93° Insert: DXGU	✓	✓			0.375"			0.625"	Side clamping without offset	G032
	JSDJ2XR/L Cutting edge angle 93° Insert: DXGU	✓	✓			0.375"			0.625"	Screw-on clamping without offset	G031
	JSDJXR/L Cutting edge angle 93° Insert: DXGU	✓	✓					0.750"	1.000"	Screw-on clamping with offset	C042
	JSDJ2XR/L-CHP Cutting edge angle 93° Insert: DXGU	✓	✓			0.500"			0.625"	Screw-on clamping without offset	G033
	JSDJ2CR/L Cutting edge angle 93° Insert: DC□□		✓			0.375"			0.625"	Screw-on clamping without offset	G036
	JSDJ2CR/L-CHP Cutting edge angle 93° Insert: DC□□		✓			0.500"				Screw-on clamping without offset	G037
	JSDNCN Cutting edge angle 62.5° Insert: DC□□		✓			0.375"			0.625"	Screw-on clamping with offset	G047
	JSDJXR-F Cutting edge angle 93° Insert: DXGU	✓	✓			0.500"			0.625"	Screw-on clamping with offset	G034

Miniature External Turning - Quick Guide

External Turning & Profiling

Inch	Application	Designation	Insert			Shank size (in)					Clamping style	Page
			MiniForce-Turn	ISO Positive type	ISO Negative type	0	0.375	0.500	0.750	1.000		
	JPVJ2XR/L Cutting edge angle 93° Insert: VXGU	✓	✓		0.375"			0.625"			Side clamping without offset	G040
	JSVJ2XR/L-CHP Cutting edge angle 93° Insert: VXGU	✓	✓			0.500"		0.625"			Screw-on clamping without offset	G041
	JSVJ2XR/L Cutting edge angle 93° Insert: VXGU	✓	✓		0.375"			0.625"			Screw-on clamping without offset	G040
	JSVJXR/L Cutting edge angle 93° Insert: VXGU	✓	✓					0.750"	1.000"		Screw-on clamping with offset	C059
	JSVJ2BR/L Cutting edge angle 93° Insert: VB□□		✓		0.375"			0.625"			Screw-on clamping without offset	G044
	JSVJ2BR/L-CHP Cutting edge angle 93° Insert: VB□□		✓			0.500"					Screw-on clamping without offset	G045



Metric	Application	Designation	Insert			Shank size (mm)				Clamping style	Page	
			MiniForce-Turn	ISO Positive type	ISO Negative type	0	10	20	30			
	JPDJ2XR/L Cutting edge angle 93° Insert: DXGU		✓		10			16			Side clamping without offset	G032
	JSDJ2XR/L Cutting edge angle 93° Insert: DXGU		✓		10			20			Screw-on clamping without offset	G031
	JSDJXR/L Cutting edge angle 93° Insert: DXGU		✓				20	25			Screw-on clamping with offset	C042
	JSDJ2XR/L-CHP Cutting edge angle 93° Insert: DXGU	✓	✓		12			16			Screw-on clamping without offset	G033
	JTDJ2CR/L Cutting edge angle 93° Insert: DC□□		✓		10			16			Back side clamping without offset	G036
	JSDJ2CR/L Cutting edge angle 93° Insert: DC□□		✓		8			16			Screw-on clamping without offset	G036
	JSDJ2CR/L-CHP Cutting edge angle 93° Insert: DC□□		✓		12			16			Screw-on clamping without offset	G037
	JSDJCR/L Cutting edge angle 93° Insert: DC□□		✓		8			16			Screw-on clamping with offset	G038
	JSDNCN Cutting edge angle 62.5° Insert: DC□□		✓		10			16			Screw-on clamping with offset	G047
	JSDN3CR/L Cutting edge angle 62.5° Insert: DC□□		✓		12			16			Screw-on clamping with offset	G048

Grade
Insert
Toolholder
Ext. Toolholder
Int. Toolholder
Threading
Grooving
Miniature Tool
Milling Cutter
Endmill
Drilling Tool
Tooling System
User's Guide
Index

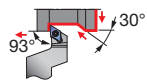
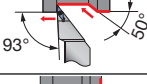
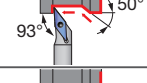

Miniature External Turning - Quick Guide

External Turning & Profiling

Metric	Application	Designation	Insert			Shank size (mm)				Clamping style	Page
			MiniForce-Turn	ISO Positive type	ISO Negative type	0	10	20	30		
		JSDJXR-F Cutting edge angle 93° Insert: DXGU	✓	✓		10	16			Screw-on clamping with offset	G034
		JPVJ2XR/L Cutting edge angle 93° Insert: VXGU	✓	✓		10	16			Side clamping without offset	G040
		JSVJ2XR/L-CHP Cutting edge angle 93° Insert: VXGU		✓		12	16			Screw-on clamping without offset	G041
		JSVJ2XR/L Cutting edge angle 93° Insert: VXGU	✓	✓		10	20			Screw-on clamping without offset	G040
		JSVJXR/L Cutting edge angle 93° Insert: VXGU	✓	✓			20	25		Screw-on clamping with offset	C059
		JSVJ2BR/L Cutting edge angle 93° Insert: VB□□		✓		10	16			Screw-on clamping without offset	G044
		JSVJ2BR/L-CHP Cutting edge angle 93° Insert: VB□□		✓		12				Screw-on clamping without offset	G045

Miniature Internal Turning - Quick Guide

Positive type

StreamJet-Bar

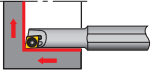
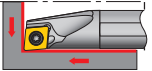
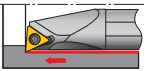
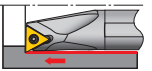
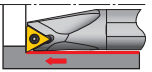
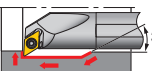
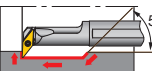
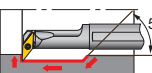
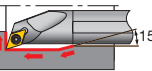
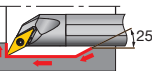
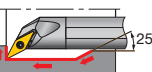
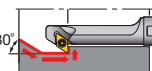
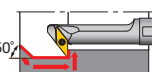
Inch Application	Description & Application	ISO insert	Y-Pro	Shank material	Shank size (in)	Min. bore diameter: DMIN (in)					Page
						0	0.400	0.800	1.200	1.600	
	SEXP/L Boring & Internal facing Insert: EP□□	✓		Steel Carbide	∅0.313" ∅0.313"	∅0.250" ∅0.250"					D040 D041
	SCLCR/L Boring & Internal facing Insert: CC□□	✓		Steel Carbide	∅0.375" - ∅1.000" ∅0.375" - ∅1.000"	∅0.500" ∅0.500"	∅1.250"				D022
	STUPR/L Boring Insert: TP□□	✓		Steel Carbide	∅0.313" - ∅1.000" ∅0.438" - ∅1.000"	∅0.438" ∅0.438"	∅1.250"				D066
	STFPR/L Blind hole boring Insert: TP□□	✓		Carbide	∅0.375" - ∅1.000"	∅0.500"	∅1.000"				D050
	SCLPR/L Boring & Internal facing Insert: CP□□	✓		Steel Carbide	∅0.375" - ∅0.625" ∅0.375" - ∅0.625"	∅0.500" ∅0.500"	∅0.875"				D025
	STFCR/L Blind hole boring Insert: TC□□	✓		Carbide	∅0.375" - ∅0.750"	∅0.500"	∅1.000"				D049
	SDUCR/L Boring & Internal profiling Insert: DC□□	✓		Steel Carbide	∅0.375" - ∅0.750" ∅0.375" - ∅0.750"	∅0.625" ∅0.625"	∅1.000"				D058
	SVUCR/L Boring & Internal profiling Insert: VC□□	✓		Steel	∅0.625" - ∅0.750"		∅0.875"	∅1.000"			D076
	SVUBR/L Boring & Internal profiling Insert: VB□□	✓		Steel	∅0.750"			∅1.000"			D072
	SDQCR/L Boring & Internal profiling Insert: DC□□	✓		Steel	∅0.375" - ∅0.625"	∅0.625"	∅0.875"				D085
	SVQCR/L Boring & Internal profiling Insert: VC□□	✓		Steel	∅0.500" - ∅0.625"	∅0.688"	∅1.000"				D090
	SVQBR/L Boring & Internal profiling Insert: VB□□	✓		Steel	∅0.625"			∅1.000"			D088
	SDZCR/L Internal retracting Insert: DC□□	✓		Steel	∅0.625"			∅0.875"			D094
	SVZCR/L Internal retracting Insert: VC□□	✓		Steel	∅0.500" - ∅0.750"	∅0.750"	∅1.000"				D099



Grade
Insert
Ext. Toolholder
Int. Toolholder
Threading
Grooving
Miniature Tool
Milling Cutter
Endmill
Drilling Tool
User's Guide Tooling System
Index



Miniature Internal Turning - Quick Guide

Positive type

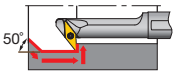
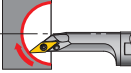
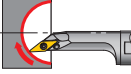
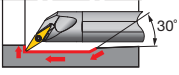
StreamJet-Bar



Inch	Application	Description & Application	ISO insert		Shank material	Shank size (in)	Min. bore diameter: DMIN (in)					Page
			ISO insert	Y-Pro			0	0.400	0.800	1.200	1.600	
		SVZBR/L Internal retracting Insert: VB□□	✓		Steel	ø0.750"					ø1.000"	D098
		SVJCR/L Internal sphere cutting Insert: VC□□	✓		Steel	ø0.625"					ø1.000"	D044
		SVJBR/L Internal sphere cutting Insert: VB□□	✓		Steel	ø0.625"					ø1.000"	D043
		SYQBR/L Internal undercut & profiling Insert: YW□□		✓	Steel Carbide	ø0.500" - ø0.625"	ø0.750"	ø0.875"				D092
		SYUBR/L Boring & Internal profiling Insert: YW□□		✓	Steel Carbide	ø0.625"					ø1.000"	D084

Miniature Internal Turning - Quick Guide

Positive type

StreamJet-Bar

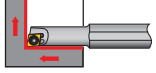
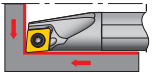
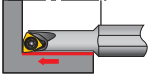
Metric

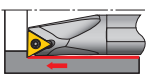
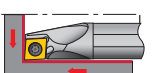
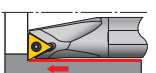
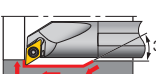
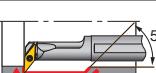
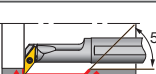
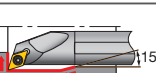
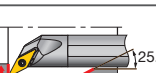
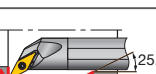
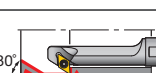
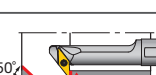
Application	Description & Application	ISO insert	Y-Pro	Shank material	Shank size (mm)	Min. bore diameter: DMIN (mm)					Page	
						0	10	20	30	40		50
	SEXPR/L Boring & Internal facing Insert: EP□□	✓		Steel	ø4 - ø8	ø4.5	ø7					D040 D041
				Carbide	ø4 - ø8	ø4.5	ø7					
	SCLCR/L Boring & Internal facing Insert: CC□□	✓		Steel	ø4 - ø25	ø5	ø27					D023 D024
				Carbide	ø4 - ø25	ø5	ø27					
	SWUBR/L Boring Insert: WB□□	✓		Steel	ø5 - ø8	ø6	ø8					D083
				Carbide	ø5 - ø8	ø6	ø8					
	STUPR/L Boring Insert: TP□□	✓		Steel	ø7 - ø32	ø8	ø34					D067 D068
				Carbide	ø7 - ø25	ø8	ø27					
	STFPR/L Blind hole boring Insert: TP□□	✓		Steel	ø8 - ø25	ø10	ø27					D050
				Carbide	ø8 - ø20	ø10	ø22					
	SCLPR/L Boring & Internal facing Insert: CP□□	✓		Steel	ø8 - ø25	ø10	ø27					D026 D027
				Carbide	ø8 - ø16	ø10	ø20					
	STFCR/L Blind hole boring Insert: TC□□	✓		Steel	ø10 - ø16	ø12	ø18					D049
				Carbide	ø10 - ø16	ø12	ø18					
	SDUCR/L Boring & Internal profiling Insert: DC□□	✓		Steel	ø10 - ø25	ø13	ø32					D058
				Carbide	ø10 - ø20	ø13	ø27					
	SVUCR/L Boring & Internal profiling Insert: VC□□	✓		Steel	ø12 - ø25	ø16	ø32					D076
				Carbide	ø12 - ø25	ø18	ø32					
	SVUBR/L Boring & Internal profiling Insert: VB□□	✓		Steel	ø16 - ø25	ø20	ø32					D072
				Carbide	ø16 - ø25	ø24.5	ø34					
	SDQCR/L Boring & Internal profiling Insert: DC□□	✓		Steel	ø10 - ø25	ø13	ø30					D085 D086
				Carbide	ø10 - ø20	ø13	ø25					
	SVQCR/L Boring & Internal profiling Insert: VC□□	✓		Steel	ø10 - ø16	ø13.5	ø21.5					D090
				Carbide	ø10 - ø16	ø13.5	ø21.5					
	SVQBR/L Boring & Internal profiling Insert: VB□□	✓		Steel	ø12 - ø25	ø17	ø30.5					D088
				Carbide	ø12 - ø25	ø17	ø30.5					
	SDZCR/L Internal retracting Insert: DC□□	✓		Steel	ø12 - ø25	ø14	ø25					D094
				Carbide	ø12 - ø16	ø18	ø22					
	SVZCR/L Internal retracting Insert: VC□□	✓		Steel	ø12	ø16					D099	



Grade
Insert
Ext. Toolholder
Int. Toolholder
Threading
Grooving
Miniature Tool
Milling Cutter
Endmill
Drilling Tool
Tooling System
User's Guide
Index



Miniature Internal Turning - Quick Guide

Positive type

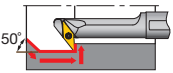
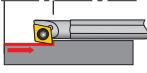
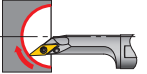
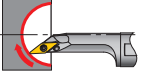
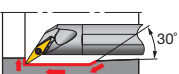
StreamJet-Bar

Metric Application	Description & Application	ISO insert		Shank material	Shank size (mm)	Min. bore diameter: DMIN (mm)						Page
		Y	Y-Pro			0	10	20	30	40	50	
	SVZBR/L Internal retracting Insert: VB□□	✓		Steel	ø16 - ø32			ø20			ø40	D098
	SEZPR/L Internal retracting Insert: EP□□	✓		Steel	ø4 - ø5	ø5.5		ø6.5				D097
				Carbide	ø4 - ø5	ø5.5		ø6.5				
	SVJCR/L Internal sphere cutting Insert: VC□□	✓		Steel	ø12 - ø16			ø16		ø20		D044
	SVJBR/L Internal sphere cutting Insert: VB□□	✓		Steel	ø20 - ø25					ø25	ø30	D043
	SYQBR/L Internal undercut & profiling Insert: YW□□		✓	Steel	ø12 - ø16			ø17		ø21.5		D092
				Carbide	ø12 - ø16			ø17		ø21.5		
	SYUBR/L Boring & Internal profiling Insert: YW□□		✓	Steel	ø16			ø20				D084
				Carbide	ø12 - ø16			ø20		ø24.5		

Miniature Internal Turning - Quick Guide

Double-sided insert with positive cutting edges

MiniForce-Turn

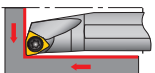
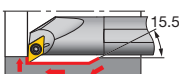
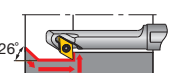

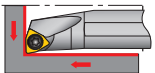
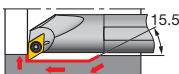
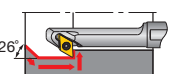
Inch Application	Description & Application	MiniForce-Turn	Shank material	Shank size (in)	Min. bore diameter: DMIN (in)						Page
					0	0.400	0.800	1.200	1.600	2.000	
	SWLXR/L Boring & Internal facing Insert: WXGU	✓	Steel	ø0.375" - ø1.000"	ø0.500"					ø1.250"	D034
			Carbide	ø0.375" - ø1.000"	ø0.500"					ø1.250"	
	SDXXR/L Boring & Internal profiling Insert: DXGU	✓	Steel	ø0.375" - ø1.000"	ø0.625"					ø1.250"	D042
			Carbide	ø0.375" - ø1.000"	ø0.625"					ø1.250"	
	SDZXR/L Internal retracting Insert: DXGU	✓	Steel	ø0.500" - ø0.750"	ø0.625"			ø0.875"			D093

Metric Application	Description & Application	MiniForce-Turn	Shank material	Shank size (mm)	Min. bore diameter: DMIN (mm)						Page
					0	10	20	30	40	50	
	SWLXR/L Boring & Internal facing Insert: WXGU	✓	Steel	ø10 - ø20			ø12			ø22	D034
			Carbide	ø10 - ø20			ø12			ø22	
	SDXXR/L Boring & Internal profiling Insert: DXGU	✓	Steel	ø10 - ø20			ø13			ø24	D042
			Carbide	ø10 - ø20			ø13			ø24	
	SDZXR/L Internal retracting Insert: DXGU	✓	Steel	ø12 - ø20			ø14			ø20	D093
			Carbide	ø12 - ø16			ø18			ø22	

Miniature Grooving - Quick Guide

External Grooving

TetraMini-Cut



Inch	Application	Designation	Insert	Shank size (in)					Groove width (in)	Max. groove depth (in)	Page
				0	0.375	0.500	0.750	1.250			
		STCR/L-18-CHP	TC*18R/L...			ø0.500"	ø0.625"	0.013" - 0.118"	0.031" - 0.138"	G080 G081	
		STCR/L-18	TC*18R/L...			ø0.375"	ø1.000"	0.013" - 0.118"	0.031" - 0.138"	G080	





Metric	Application	Designation	Insert	Shank size (mm)				Groove width (mm)	Max. groove depth (mm)	Page
				0	10	20	30			
		JS-STCL18	TC*18R...			ø14	ø25.4	0.33 - 3.0	0.8 - 3.5	G081

TetraForce-Cut

Inch	Application	Designation	Insert	Shank size (in)					Groove width (in)	Max. groove depth (in)	Page
				0	0.375	0.500	0.750	1.000			
		STCR/L-27	TC*27...			ø0.375"	ø1.000"	0.020" - 0.125"	0.039" - 0.252"	G090	

J-series

Inch	Application	Designation	Insert	Shank size (in)					Groove width (in)	Max. groove depth (in)	Page
				0	0.375	0.500	0.750	1.000			
		JSTGR/L	JTGR/L3...			ø0.375"	ø0.625"	0.013" - 0.118"	0.028" - 0.102"	G096	
		JSVGR/L	JVGR/L...			ø0.375"	ø0.625"	0.013" - 0.079"	0.028" - 0.217"	G101	

Metric	Application	Designation	Insert	Shank size (mm)				Groove width (mm)	Max. groove depth (mm)	Page
				0	10	20	30			
		JSTGR/L	JTGR/L3...		10	16		0.33 - 3.0	0.7 - 2.6	G096
		JS-TGL3	JTGR3...			ø19.05	ø25.4	0.33 - 3.0	0.7 - 2.6	G096
		JSVGR/L	JVGR/L...		10	16		0.33 - 2.0	0.7 - 5.5	G101
		JSXGR/L	JXGR/L8...		10		25	0.7 - 2.0	4.5 - 6.0	G100

Grade
Insert
Toolholder
Ext. Toolholder
Int. Toolholder
Threading
Grooving
Miniature Tool
Milling Cutter
Endmill
Drilling Tool
User's Guide Tooling System
Index

A
B
C
D
E
F
G
H
I
J
K
L
M

Miniature Grooving - Quick Guide



External Grooving

GTGN

Application	Designation	Insert	Shank size (in)					Groove width (in)	Max. groove depth (in)	Page
			0	0.375	0.500	0.750	1.000			
	CER/L	GTGN-16E...						0.039" - 0.089"	0.049" - 0.071"	F087





Application	Designation	Insert	Shank size (mm)					Groove width (mm)	Max. groove depth (mm)	Page
			0	10	20	30	40			
	CER/L	GTGN-16E...			12		20	1.0 - 2.25	1.0 - 6.4	F087

TungHeavyGroove

Application	Designation	Insert	Shank size (in)					Groove width (in)	Max. groove depth (in)	Page
			0	0.375	0.500	0.750	1.000			
	FPGN	PSGB...						0.394" - 0.984"	Wide grooving and profiling	G103
	SPGN	PSGB...						0.394" - 0.984"	Wide grooving and profiling	G103

Parting



DuoJustCut



Application	Designation	Insert	Shank size (in)					Groove width (in)	Max. parting diameter (mm)	Page
			0	0.375	0.500	0.750	1.000			
	JSXXR/L-X-CHP	JXPG...						0.039" - 0.079"	ø20	G112
	JSXXR/L-X-S-CHP	JXPG...						0.039" - 0.079"	ø20	G113
	JSXXR/L-F-S-CHP	JXPG...						0.039" - 0.079"	ø20	G113
	JSXXR/L	JXPG...						0.039" - 0.079"	ø20	G111
	JSXXR/L-S	JXPG...						0.039" - 0.079"	ø20	G111

Miniature Parting - Quick Guide

Parting

TungCut

Application	Designation	Insert	Shank size (in)					Groove width (in)	Max. parting diameter (in)	Page
			0	0.375	0.500	0.750	1.000			
	JCTER/L-CHP	DG.../SG...	0.500"		0.750"		0.079"	ø1.260"	G121	
	JCTER/L	DG.../SG...	0.500"		0.625"		0.079" - 0.118"	ø1.260"	G120	



Application	Designation	Insert	Shank size (mm)					Groove width (mm)	Max. parting diameter (mm)	Page
			0	10	20	30	40			
	JCTER/L-CHP	DG.../SG...	12		20		1.4 - 3.0	ø32	G121	
	JCTER/L	DG.../SG...	10		20		1.4 - 3.0	ø32	G120	
	CGER/L	DG.../SG...	10		20		1.4 - 3.0	ø55	G121	

My-T

Application	Designation	Insert	Shank size (mm)				Groove width (mm)	Max. parting diameter (mm)	Page
			0	10	20	30			
	JCGSSR/L	GE20...	10		25		2.0	ø32	F063

J-series

Application	Designation	Insert	Shank size (in)					Groove width (in)	Max. parting diameter (in)	Page
			0	0.375	0.500	0.750	1.000			
	JCCWSR/L	JCC*200F...	0.375"		0.625"		0.079"	ø0.787"	F105	

Application	Designation	Insert	Shank size (mm)				Groove width (mm)	Max. parting diameter (mm)	Page
			0	10	20	30			
	JCCWSR/L	JCC*200F...	10		25		2.0	ø20	F105
	JCGWSR/L	JCGN200F...	10		16		2.0	ø20	F106

Grade
Insert
Toolholder
Ext. Toolholder
Int. Toolholder
Threading
Grooving
Miniature Tool
Milling Cutter
Endmill
Drilling Tool
User's Guide Tooling System
Index



Miniature Grooving - Quick Guide

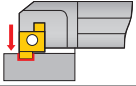

Internal Grooving

SNG

Metric	Application	Designation	Insert	Shank size (mm)				Groove width (mm)	Max. groove depth (mm)	Min. bore diameter (mm)	Page
				0	10	20	30				
		SNGR/L	*GR/L...	ø8.0			ø20.0	1.0 - 3.5	1.5 - 3.0	8.0 - 24.0	F159



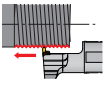

External Threading

TetraMini-Cut

Inch	Application	Designation	Insert	Shank size (in)					Corner R (mm)	Pitch (mm)	Page	
				0	0.375	0.500	0.750	1.000				
		STCR/L-18-CHP	TCT18R/L...					ø0.500"	ø1.000"	0.05 - 0.2	0.4 - 3.0	G080 G081
		STCR/L-18	TCT18R/L...					ø0.375"	ø1.000"	0.05 - 0.2	0.4 - 3.0	G080

Metric	Application	Designation	Insert	Shank size (mm)				Corner R (mm)	Pitch (mm)	Page
				0	10	20	30			
		JS-STCL18	TCT18R...			ø14	ø25.4	0.05 - 0.2	0.4 - 3.0	G081

DuoJust-Cut



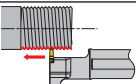

Inch	Application	Designation	Insert	Shank size (in)					Corner R (mm)	Pitch (mm)	Page
				0	0.375	0.500	0.750	1.000			
		JSXXR/L-X-CHP	JXTG12...			ø0.500"	ø0.625"	0.05Max. - 0.1	0.2 - 1.5	G112	
		JSXXR/L-X-S-CHP JSXXR/L-F-S-CHP	JXTG12...			ø0.500"	ø0.625"	0.05Max. - 0.1	0.2 - 1.5	G113	
		JSXXR/L	JXTG12...			ø0.375"	ø0.625"	0.05Max. - 0.1	0.2 - 1.5	G111	
		JSXXR/L-S	JXTG12...			ø0.375"	ø0.500"	0.05Max. - 0.1	0.2 - 1.5	G111	

Metric	Application	Designation	Insert	Shank size (mm)				Corner R (mm)	Pitch (mm)	Page
				0	10	20	30			
		JS-SXXL09	JXTG12R...			ø19.05	ø25.4	0.05Max. - 0.1	0.2 - 1.5	G115





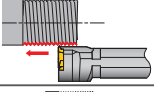

Miniature Threading - Quick Guide

External Threading

J-series

Inch		Designation	Insert	Shank size (in)					Corner R (mm)	Pitch (mm)	Page
Application	0			0.375	0.500	0.750	1.000				
	JSTTR/L	JTTR/L3...						0.05 - 0.1	0.5 - 1.0	G109	
				ø0.375"		ø0.625"					
Metric		Designation	Insert	Shank size (mm)				Corner R (mm)	Pitch (mm)	Page	
Application	0			10	20	30					
	JSTTR/L	JTTR/L3...		10		16		0.05 - 0.1	0.5 - 1.0	G109	
	JS-TTL3	JTTR3...			ø19.05		ø25.4	0.05 - 0.1	0.5 - 1.0	G109	
	JSXBR/L	JXT*R6000F		10			25	0.03	0.5 - 1.0	G108	

TungThread

Inch		Designation	Insert	Shank size (in)						Corner R (mm)	Pitch (mm)	Page
Application	0			0.375	0.500	0.750	1.000	1.250				
	JSE2R16-CHP	16ER/L...			ø0.500"		ø0.625"		0.05 - 0.22	0.5 - 3.0	G105	
	CER/L	16ER/L...						ø0.750"	ø1.250"	0.05 - 0.22	0.5 - 3.0	F087
Metric		Designation	Insert	Shank size (mm)					Corner R (mm)	Pitch (mm)	Page	
Application	0			10	20	30	40					
	JSE2R16-CHP	16ER/L...		12		16			0.05 - 0.22	0.5 - 3.0	G105	
	CER/L	16ER/L...		12			25		0.05 - 0.22	0.5 - 3.0	F087	
	B-S/CER/L	16ER/L...					-		0.05 - 0.22	0.5 - 3.0	G106	
	BC-SER	16ER/L...					-		0.05 - 0.22	0.5 - 3.0	G107	

Grade
Insert
Ext. Toolholder
Int. Toolholder
Threading
Grooving
Miniature Tool
Milling Cutter
Endmill
Drilling Tool
Tooling System
User's Guide
Index



Miniature Threading - Quick Guide

Internal Threading

TungThread

Metric

Application	Designation	Insert	Shank size (mm)				Groove width (mm)	Max. groove depth (mm)	Min. bore diameter (mm)	Page
			0	10	20	30				
	SNR/L	6IR/L...	8				-	0.5 - 2.0	8.0 - 10.0	E036

Miniature Internal Turning - Quick Guide

TinyMini-Turn - Solid carbide tools for small diameter turning

Boring, profiling & chamfering

TinyMini-Turn

Application	Description & Application	Shank Size	Min. bore diameter: DMIN (mm)						Page	
			0	2	4	6	8	10		
	JBT Boring, profiling & chamfering	ø4 & ø7	ø0.6	[Red bar from 0 to 7]				ø7	G070	
	JBP Face grooving	ø4 & ø7	ø2.8		[Red bar from 2.8 to 5]				ø5	G071
	JBU Back boring & chamfering	ø7	ø5				[Red bar from 5 to 5]			G071
	JBC Boring & 45° chamfering	ø7	ø5		[Red bar from 5 to 6.8]				ø6.8	G071
	JBB Back boring	ø4 & ø7	ø3		[Red bar from 3 to 7]				ø7	G072

Threading

TinyMini-Turn

Application	Description & Application	Shank Size	Min. bore diameter: DMIN (mm)						Page	
			0	2	4	6	8	10		
	JBI Threading (Metric thread)	ø4 & ø7	ø4		[Red bar from 4 to 7]				ø7	G072

Internal Grooving

TinyMini-Turn

Application	Description & Application	Shank Size	Groove width	Min. bore diameter: DMIN (mm)										Page
				0	2	4	6	8	10	12	14	15		
	JBG Internal Grooving	ø4 & ø7	0.5 - 2	ø2		[Red bar from 2 to 6.8]				ø6.8			G073	
	JBF Face grooving	ø7	1 - 3	ø6				[Red bar from 6 to 15]				ø15	G074	
	JBS Face grooving (for shaft)	ø7	2	ø6				[Red bar from 6 to 6]					G074	
	JBR Boring & profiling (full radius type)	ø7	1	ø5		[Red bar from 5 to 6.8]				ø6.8			G075	

Grade
Insert
Toolholder
Ext. Toolholder
Int. Toolholder
Threading
Grooving
Miniature Tool
Milling Cutter
Endmill
Drilling Tool
Tooling System
User's Guide
Index





Thru-coolant holder system

High pressure coolant is supplied through the holder to facilitate smooth chip evacuation, improved chip breaking and reduced machine down-time

External coolant supply at normal pressure



High pressure coolant (7 MPa)

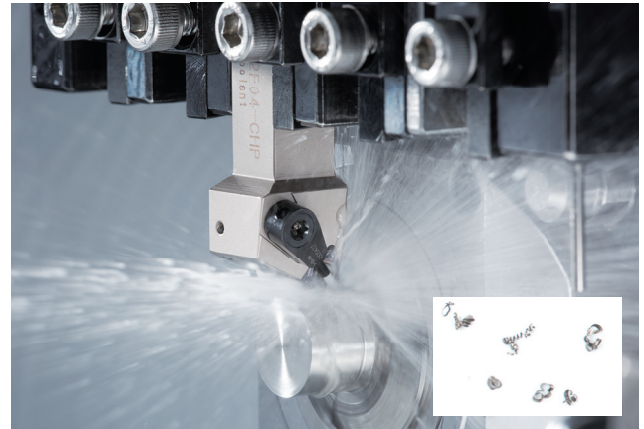

Coolant jets from two outlets ensure high cutting efficiency and extended tool life

Directly to the cutting edge

- Reliable chip control
- Reduces crater and notch wears

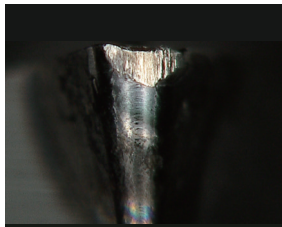
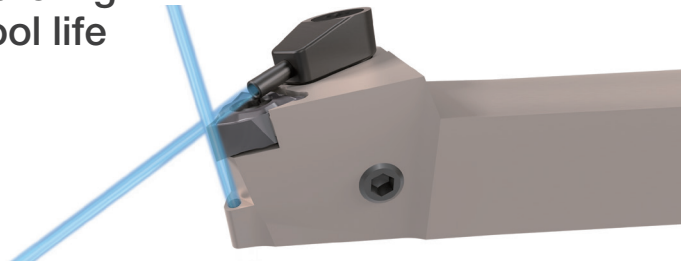

Excessive wear with external coolant supply (at normal pressure)

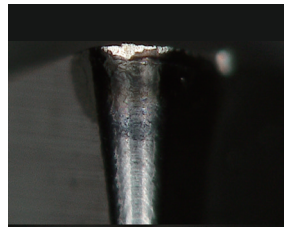

High pressure coolant (7 MPa)



Excessive crater wear with external coolant supply (at normal pressure)

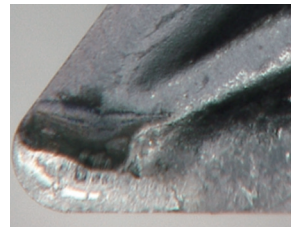

High pressure coolant (7 MPa)

Reference pages: [G025](#), [G028](#), [G033](#), [G037](#), [G041](#), [G045](#), [G080](#), [G091](#) - [G095](#), [G112](#) - [G113](#)

Tube-free design streamlines tool setup. Through-coolant supply enables high productivity.

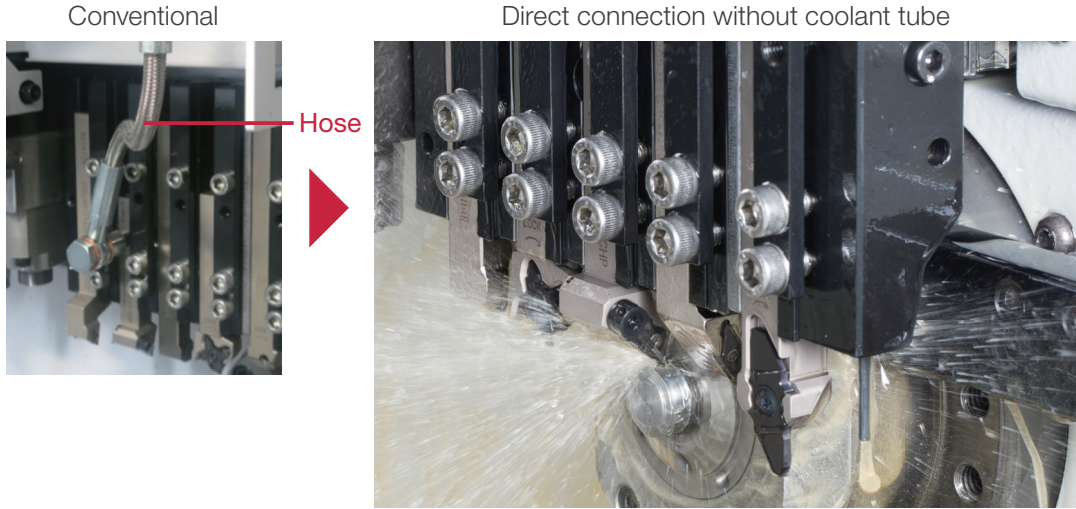

No need for coolant tube setup. Eliminates chip entanglement on tubes and streamlines tool replacement.

Coolant is supplied from the tool post directly to the tools.

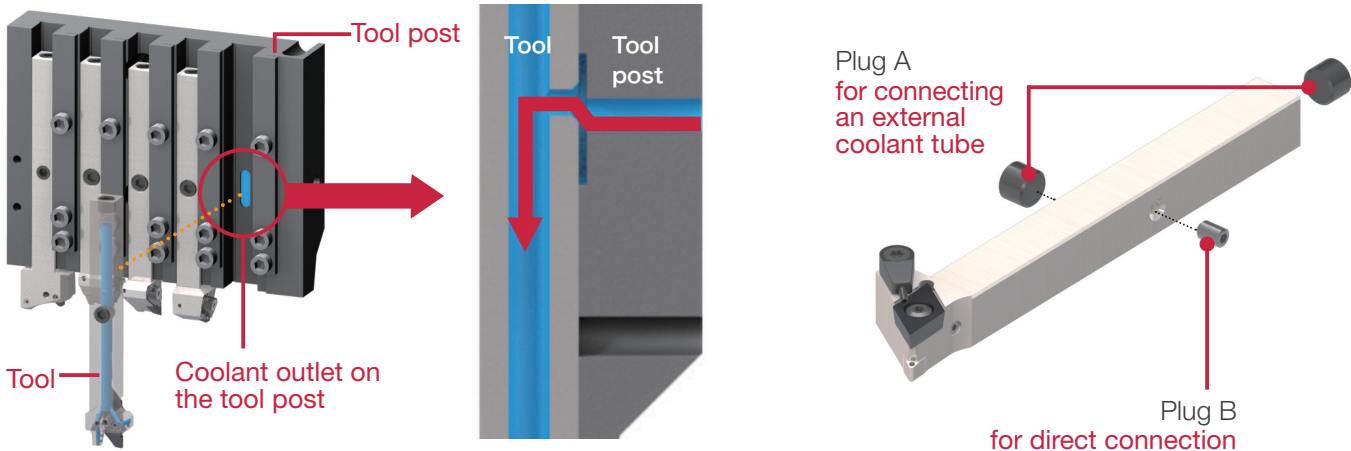

Use a non-coolant-through tool when a coolant supply is not needed through the tool.

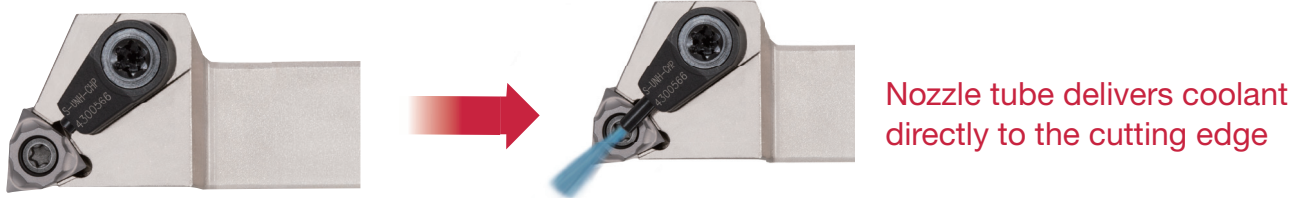

Nozzle tube delivers coolant directly to the cutting edge

Reference pages : G025, G028, G033, G037, G041, G045, G080, G091, G105, G112 - G113, G121

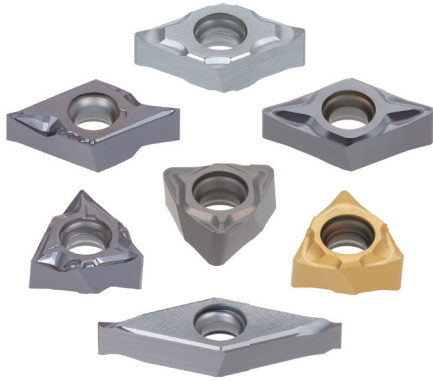

Economical double-sided positive insert

Innovative geometry and seat interface ensures stability and high performance.

Insert

WXGU0403.. 6 positive cutting edges

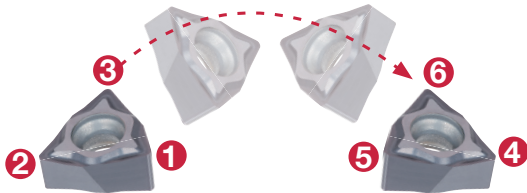

DXGU0703.. 4 positive cutting edges

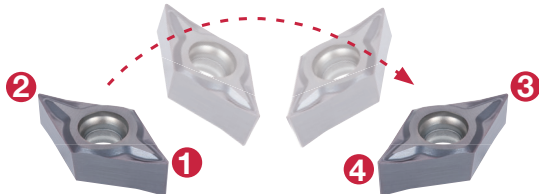

VXGU09T2.. 4 positive cutting edges

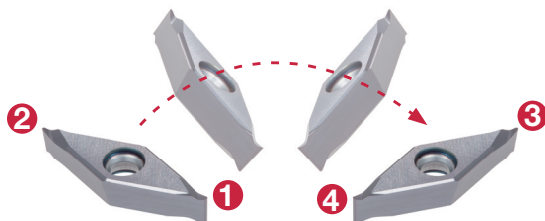

High rake angle

External turning

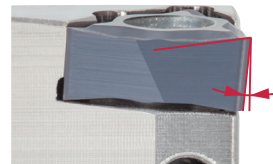

Internal turning

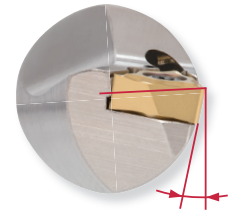

External turning

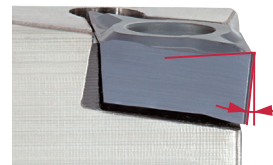

Internal turning

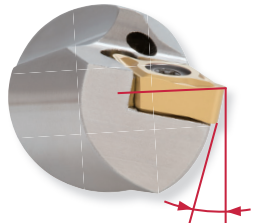

External turning



Screw-on toolholder with 95° approach angle, for WXGU inserts

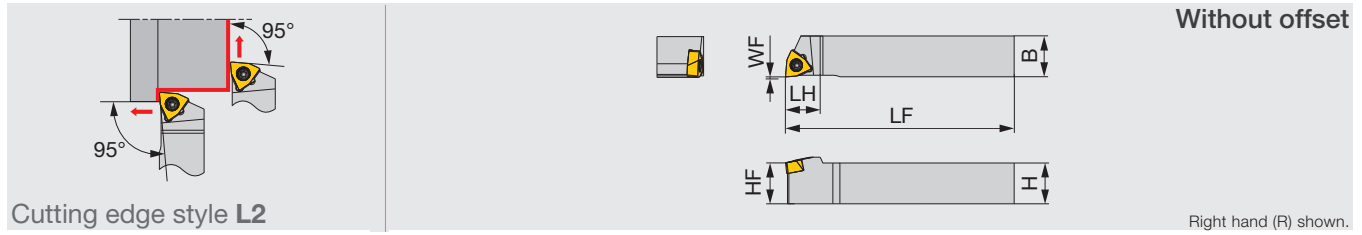

Cutting edge style L2

Inch	H	B	LF	LH	HF	WF	RE**	Insert	Torque
JSWL2XR/L062	0.375	0.375	4.750	0.500	0.375	0	0.008	WXGU0403**L/R...	0.66
JSWL2XR/L082	0.500	0.500	4.750	0.500	0.500	0	0.008	WXGU0403**L/R...	0.66
JSWL2XR/L102	0.625	0.625	4.750	0.500	0.625	0	0.008	WXGU0403**L/R...	0.66

Metric	H	B	LF	LH	HF	WF	RE**	Insert	Torque*
JSWL2XR/L1010X04	10	10	120	11	10	0	0.2	WXGU0403**L/R...	0.9
JSWL2XR/L1212F04	12	12	85	11	12	0	0.2	WXGU0403**L/R...	0.9
JSWL2XR/L1212X04	12	12	120	11	12	0	0.2	WXGU0403**L/R...	0.9
JSWL2XR/L1616X04	16	16	120	13	16	0	0.2	WXGU0403**L/R...	0.9
JSWL2XR/L2020H04	20	20	100	13	20	0	0.2	WXGU0403**L/R...	0.9

Torque: Recommended clamping torque: lbs-ft (*N-m) **RE: Standard corner radius
Use right-hand toolholders (R) with left-hand inserts (L); and left-hand toolholders (L) with right-hand inserts (R).

SPARE PARTS

Designation	Clamping screw	Wrench
JSWL2XR/L...	SR34-514	T-7F

INSERT SELECTION

Swiss lathes

P	Application	Finish cutting	Medium to finish cutting	M	Application	Finish cutting	Medium to finish cutting
	Grade	SH725	SH725		SH725	Grade	SH725
Chipbreaker shape	JSS	JS	JS	Chipbreaker shape	JSS	JS	JS
Cutting conditions	G069			Cutting conditions	G069		

Small CNC lathes

P	Application	Finish cutting	Medium cutting	M	Application	Finish cutting	Medium cutting
	Grade	AH725	AH725		AH725	Grade	AH8015
Chipbreaker shape	SS	TS	TS	Chipbreaker shape	SS	TS	TS
Cutting conditions	G069			Cutting conditions	G069		

Reference pages: JSWL2XR/L: Inserts → B161 -, Standard cutting conditions → G069

Lever-lock toolholder with 95° approach angle, for WXGU inserts

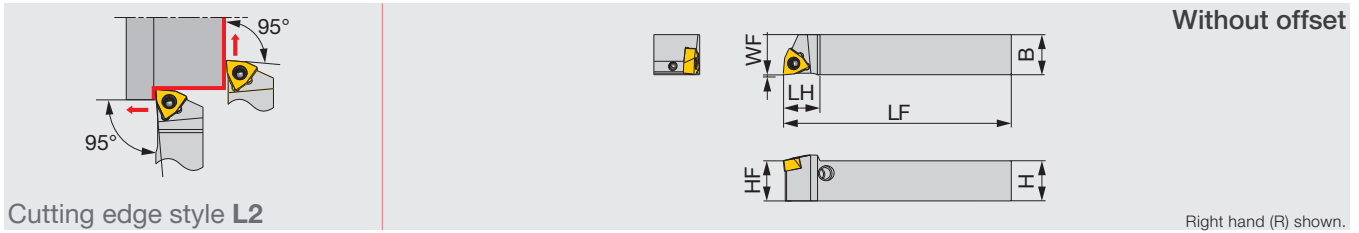

Cutting edge style **L2**

Right hand (R) shown.

Inch	H	B	LF	LH	HF	WF	RE**	Insert	Torque
JPWL2XR/L062	0.375	0.375	4.750	0.500	0.375	0	0.008	WXGU0403**L/R...	0.66
JPWL2XR/L082	0.500	0.500	4.750	0.500	0.500	0	0.008	WXGU0403**L/R...	0.66
JPWL2XR/L102	0.625	0.625	4.750	0.500	0.625	0	0.008	WXGU0403**L/R...	0.66

Metric	H	B	LF	LH	HF	WF	RE**	Insert	Torque*
JPWL2XR/L1010X04	10	10	120	11	10	0	0.2	WXGU0403**L/R...	0.9
JPWL2XR/L1212F04	12	12	85	11	12	0	0.2	WXGU0403**L/R...	0.9
JPWL2XR/L1212X04	12	12	120	11	12	0	0.2	WXGU0403**L/R...	0.9
JPWL2XR/L1616X04	16	16	120	13	16	0	0.2	WXGU0403**L/R...	0.9

Torque: Recommended clamping torque: lbs-ft (*N-m) **RE: Standard corner radius
Use right-hand toolholders (R) with left-hand inserts (L); and left-hand toolholders (L) with right-hand inserts (R).

SPARE PARTS

Designation	Lever	Pin	Clamping screw	Wrench
JPWL2XR/L...	SLLV-2	SL-PI-2	SR10400611	HW2.0/5RED

INSERT SELECTION

Swiss lathes

P	Application	Finish cutting	Medium to finish cutting	M	Application	Finish cutting	Medium to finish cutting
	Grade	SH725	SH725		SH725	Grade	SH725
Chipbreaker shape	JSS	JS	JS	Chipbreaker shape	JSS	JS	JS
Cutting conditions	G069			Cutting conditions	G069		

Small CNC lathes

P	Application	Finish cutting	Medium cutting	M	Application	Finish cutting	Medium cutting
	Grade	AH725	AH725		AH725	Grade	AH8015
Chipbreaker shape	SS	TS	TS	Chipbreaker shape	SS	TS	TS
Cutting conditions	G069			Cutting conditions	G069		

Reference pages: JPWL2XR/L: Inserts → **B161** -, Standard cutting conditions → **G069**

Screw-on toolholder with 95° approach angle, for WXGU inserts, with high pressure coolant capability

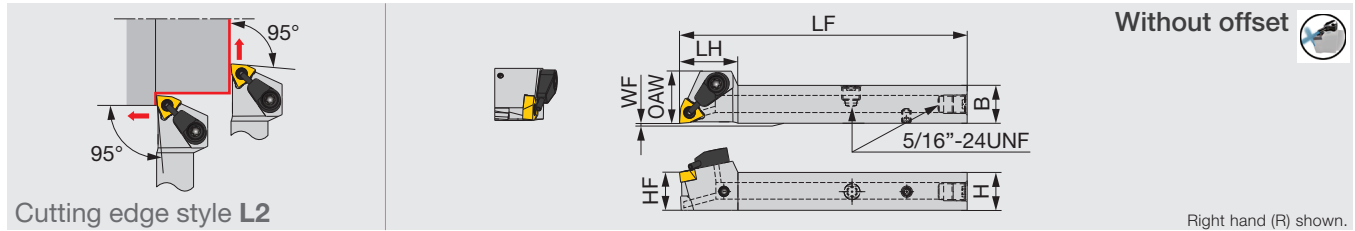

Inch	H	B	LF	LH	HF	WF	OAW	RE**	Insert	Torque
JSWL2XR082X-CHP	0.500	0.500	4.750	0.728	0.500	0	0.650	0.008	WXGU0403**L...	0.66
JSWL2XR102X-CHP	0.625	0.625	4.750	0.728	0.625	0	0.650	0.008	WXGU0403**L...	0.66
Metric	H	B	LF	LH	HF	WF	OAW	RE**	Insert	Torque*
JSWL2XR1212X04-CHP	12	12	120	18.5	12	0	16.5	0.2	WXGU0403**L...	0.9
JSWL2XR1616X04-CHP	16	16	120	18.5	16	0	16.5	0.2	WXGU0403**L...	0.9

Torque: Recommended clamping torque: lbs-ft (*N-m) **RE: Standard corner radius
Use right-hand toolholders (R) with left-hand inserts (L).

SPARE PARTS

Designation	Clamping screw	Coolant unit	Wrench 1	Coolant plug	Wrench 2	DirectJet plug	Wrench
JSWL2XR**-CHP	SR34-514	S-CU-CHP	T-7F	SR5/16UNFTL360	P-4	SSHM4-6-TB	P-2

Please see Tungaloy report (TR432) for tool overhang length and coolant plug.

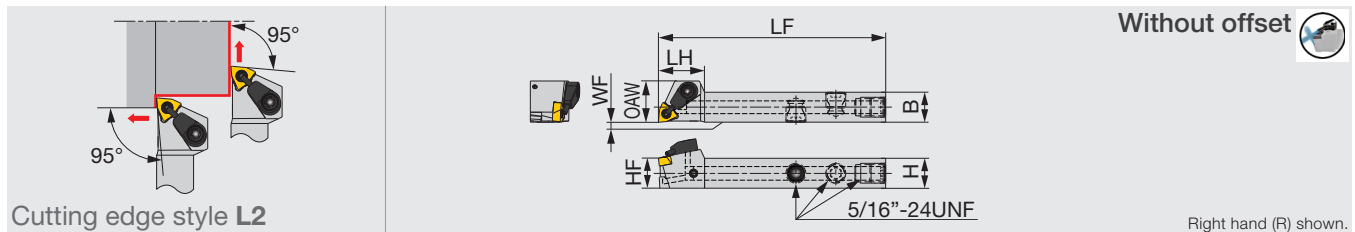

Inch	H	B	LF	LH	HF	WF	OAW	RE**	Insert	Torque
JSWL2XR/L082-CHP	0.500	0.500	3.344	0.750	0.500	0	0.650	0.008	WXGU0403**L/R...	0.66
Metric	H	B	LF	LH	HF	WF	OAW	RE**	Insert	Torque*
JSWL2XR/L1212F04-CHP	12	12	85	18	12	0	16.5	0.2	WXGU0403**L/R...	0.9

Torque: Recommended clamping torque: lb-ft (*N-m) **RE: Standard corner radius
Use right-hand toolholders (R) with left-hand inserts (L); and left-hand toolholders (L) with right-hand inserts (R).

SPARE PARTS

Designation	Clamping screw	Coolant unit	Wrench 1	Coolant plug	Wrench 2
JSWL2XR/L**-CHP	SR34-514	S-CU-CHP	T-7F	SR5/16UNFTL360	P-4

INSERT SELECTION

Swiss lathes

Application	Finish cutting		Application	Medium to finish cutting	
	Grade	SH725		Grade	SH725
Chipbreaker shape	JSS	JS	Chipbreaker shape	JSS	JS
Cutting conditions	G069		Cutting conditions	G069	

Small CNC lathes

Application	Finish cutting		Application	Medium cutting	
	Grade	AH725		Grade	AH8015
Chipbreaker shape	SS	TS	Chipbreaker shape	SS	TS
Cutting conditions	G069		Cutting conditions	G069	

Reference pages: JSWL2XR/L-CHP: Inserts → **B161 -**, Standard cutting conditions → **G069**



Screw-on stepped-head toolholder with 95° approach angle, for WXGU inserts

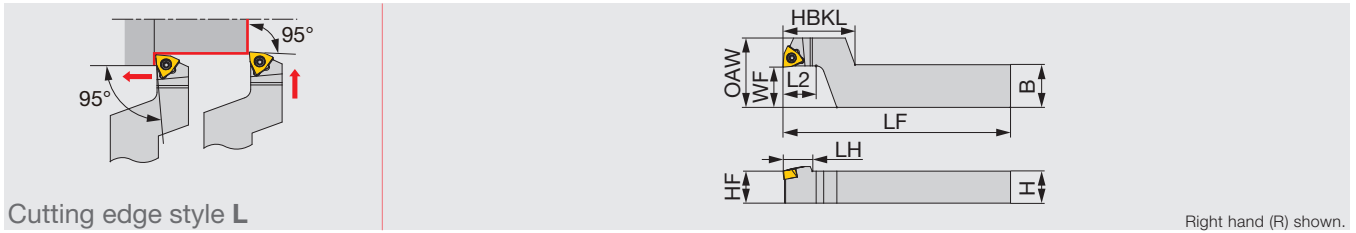

Cutting edge style L

Right hand (R) shown.

Inch	H	B	LF	L2	HBKL	LH	HF	WF	OAW	RE**	Insert	Torque
JSWLXR082-F10	0.500	0.625	4.750	0.500	1.100	0.500	0.500	0.625	1.000	0.008	WXGU22**L...	0.66
JSWLXR102-F10	0.625	0.750	4.750	0.500	1.100	0.500	0.625	0.625	1.000	0.008	WXGU22**L...	0.66

Metric	H	B	LF	L2	HBKL	LH	HF	WF	OAW	RE**	Insert	Torque*
JSWLXR1016X04-F15	10	16	120	12	27	11	10	15	26	0.2	WXGU0403**L...	0.9
JSWLXR1216F04-F15	12	16	85	12	27	11	12	15	26	0.2	WXGU0403**L...	0.9
JSWLXR1216X04-F15	12	16	120	12	27	11	12	15	26	0.2	WXGU0403**L...	0.9
JSWLXR1620X04-F15	16	20	120	12	27	11	16	15	26	0.2	WXGU0403**L...	0.9

Torque: Recommended clamping torque: lbs-ft (*N-m) **RE: Standard corner radius
Use right-hand toolholders (R) with left-hand inserts (L).

SPARE PARTS

Designation	Clamping screw	Wrench
JSWLXR**-F10, JSWLXR**-F15	SR34-514	T-7F

INSERT SELECTION

Swiss lathes

P	Application	Finish cutting	Medium to finish cutting	M	Application	Finish cutting	Medium to finish cutting
	Grade	SH725	SH725		SH725	Grade	SH725
Chipbreaker shape	JSS	JS	JS	Chipbreaker shape	JSS	JS	JS
Cutting conditions	G069			Cutting conditions	G069		

Small CNC lathes

P	Application	Finish cutting	Medium cutting	M	Application	Finish cutting	Medium cutting
	Grade	AH725	AH725		AH725	Grade	AH8015
Chipbreaker shape	SS	TS	TS	Chipbreaker shape	SS	TS	TS
Cutting conditions	G069			Cutting conditions	G069		

Reference pages: JSWLXR-F: Inserts → **B161** -, Standard cutting conditions → **G069**

Screw-on toolholder with 95° approach angle, for positive 80° rhombic inserts

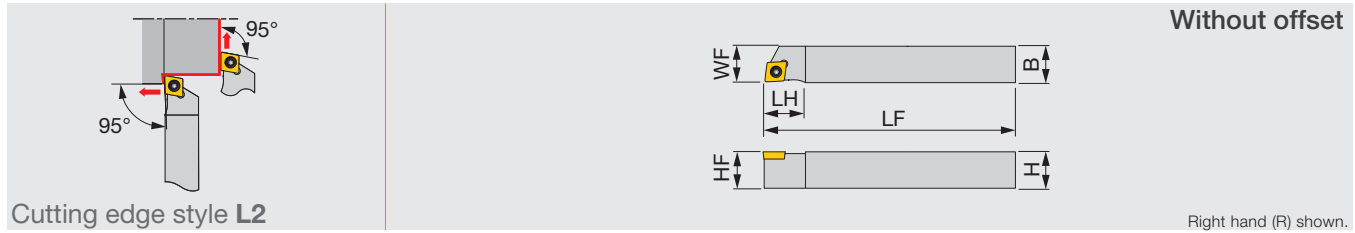

Inch	H	B	LF	LH	HF	WF	RE**	Insert	Torque
JSCL2CR/L062	0.375	0.375	5.000	0.438	0.375	0.375	0.008	CC**21.5...	0.89
JSCL2CR/L082	0.500	0.500	5.000	0.438	0.500	0.500	0.008	CC**21.5...	0.89
JSCL2CR/L103	0.625	0.625	5.000	0.625	0.625	0.625	0.008	CC**32.5...	0.89

Metric	H	B	LF	LH	HF	WF	RE**	Insert	Torque*
JSCL2CR/L1010X06	10	10	120	12	10	10	0.2	CC**0602...	1.2
JSCL2CR/L1212F06	12	12	85	12	12	12	0.2	CC**0602...	1.2
JSCL2CR/L1212X06	12	12	120	12	12	12	0.2	CC**0602...	1.2
JSCL2CR/L1212F09	12	12	85	16	12	12	0.2	CC**09T3...	1.2
JSCL2CR/L1212X09	12	12	120	16	12	12	0.2	CC**09T3...	1.2
JSCL2CR/L1616X09	16	16	120	16	16	16	0.2	CC**09T3...	1.2

Torque: Recommended clamping torque: lbs-ft (*N·m)

**RE: Standard corner radius

SPARE PARTS

Designation	Clamping screw	Wrench
JSCL2CR/L062/082, JSCL2CR/L*06	CSTB-2.5	T-8F
JSCL2CR/L103, JSCL2CR/L*09	CSTB-4SD	T-8F

INSERT SELECTION

Application	Precision finishing	Finish cutting	Medium to finish cutting	Medium to finish cutting
	SH725	SH725	AH725	SH725
Grade	01	JS	JS	J10
Chipbreaker shape				
Cutting conditions	G069			

Application	Precision finishing	Finish cutting	Medium to finish cutting	Medium to finish cutting
	SH725	SH725	AH725	SH725
Grade	01	JS	JS	J10
Chipbreaker shape				
Cutting conditions	G069			

Application	medium to finish cutting
	T515
Grade	CM
Chipbreaker shape	
Cutting conditions	B024

Application	Precision finishing	Finish cutting	Medium cutting
	DX120	TH10	KS05F
Grade	T-DIA	with rake W20	AL
Chipbreaker shape			
Cutting conditions	B026		

Application	Finish cutting	Medium to finish cutting
	SH725	AH725
Grade	JS	JS
Chipbreaker shape		
Cutting conditions	G069	

Application	Precision finishing	Finish cutting
	BXM10	BXM20
Grade	T-CBN	T-CBN
Chipbreaker shape		
Cutting conditions	B030	

Reference pages: JSCL2CR/L: Inserts → B111 -, CBN → B182, PCD → B196 -



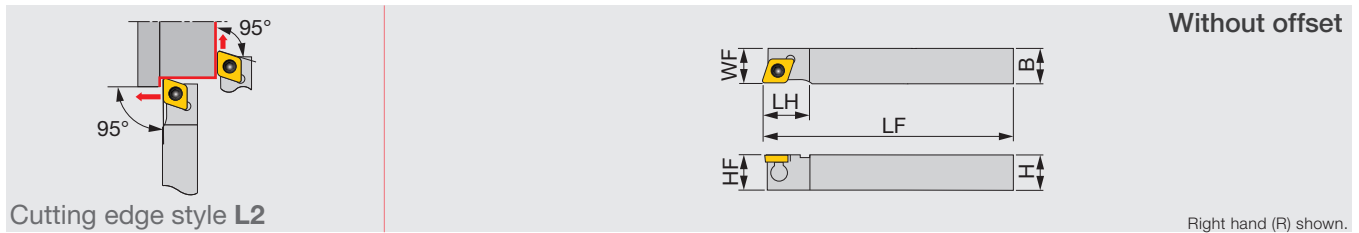

Without offset

Right hand (R) shown.

Metric	H	B	LF	LH	HF	WF	RE**	Insert	Torque
JTCL2CR/L1010X06	10	10	120	12	10	10	0.2	CC**0602...	0.9
JTCL2CR/L1212F09	12	12	85	16	12	12	0.2	CC**09T3...	1.2
JTCL2CR/L1212X09	12	12	120	16	12	12	0.2	CC**09T3...	1.2
JTCL2CR/L1616X09	16	16	120	16	16	16	0.2	CC**09T3...	1.2

Torque: Recommended clamping torque: N·m
 **RE: Standard corner radius

SPARE PARTS

Designation	Clamp	Clamping screw	Wrench
JTCL2CR/L**06	JCP-2	JDS-3525	P-2F
JTCL2CR/L**09	JCP-3	JDS-5040	P-2.5F

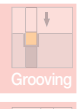

TUNG T^{URN}JET

JSCL2CR-CHP

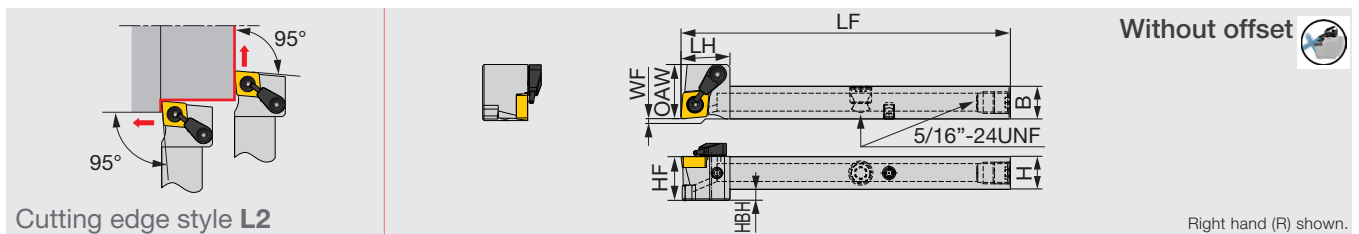

Without offset

Right hand (R) shown.

Inch	H	B	LF	LH	HF	HBH	WF	OAW	RE**	Insert	Torque
JSCL2CR083X-CHP	0.500	0.500	4.750	0.709	0.500	0.031	0	0.787	0.008	CC**09T3...	0.89
JSCL2CR103X-CHP	0.625	0.625	4.750	0.709	0.625	-	0	0.787	0.008	CC**09T3...	0.89

Metric	H	B	LF	LH	HF	HBH	WF	OAW	RE**	Insert	Torque*
JSCL2CR1212X09-CHP***	12	12	120	18	12	4	0	20	0.2	CC**09T3...	1.2
JSCL2CR1212X09B-CHP	12	12	120	18	12	1.5	0	20	0.2	CC**09T3...	1.2
JSCL2CR1616X09-CHP	16	16	120	18	16	0	0	20	0.2	CC**09T3...	1.2

Torque: Recommended clamping torque: lbs-ft (**N·m) **RE: Standard corner radius
 ***: This item will be replaced with a new product in the future.

SPARE PARTS

Designation	Clamping screw	Coolant unit	Wrench
JSCL2CR**-CHP	CSTB-4SD	S-CU-CHP	T-8F

Screw-on toolholder with 95° approach angle, for positive 80° rhombic inserts

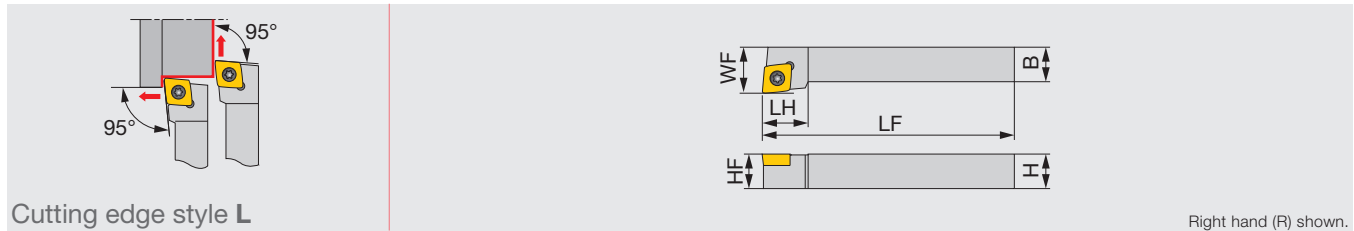

Cutting edge style L

Right hand (R) shown.

Metric	H	B	LF	LH	HF	WF	RE**	Insert	Torque
JSCLCR/L0808H06	8	8	100	12	8	10	0.4	CC**0602...	1.2
JSCLCR/L1010H06	10	10	100	12	10	12	0.4	CC**0602...	1.2
JSCLCR/L1212H09	12	12	100	16	12	16	0.8	CC**09T3...	1.2
JSCLCR/L1616H09	16	16	100	16	16	20	0.8	CC**09T3...	1.2

SPARE PARTS



Torque: Recommended clamping torque: N·m
**RE: Standard corner radius

Designation	Clamping screw	Wrench
JSCLCR/L**H06	CSTB-2.5	T-8F
JSCLCR/L**H09	CSTB-4SD	T-8F

Screw-on stepped-head toolholder with 95° approach angle, for positive 80° rhombic inserts

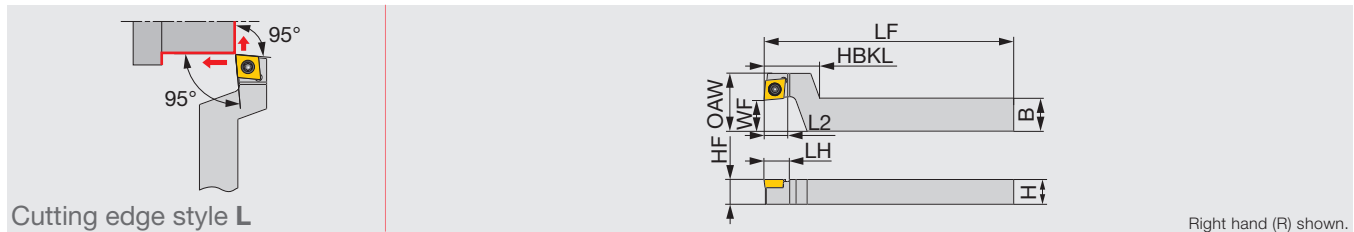

Cutting edge style L

Right hand (R) shown.

Metric	H	B	LF	L2	HBKL	LH	HF	WF	OAW	RE**	Insert	Torque
JSCLCR1216F09-F15	12	16	85	12	27	12.5	12	15	28	0.2	CC**09T3...	1.2
JSCLCR1216X09-F15	12	16	120	12	27	12.5	12	15	28	0.2	CC**09T3...	1.2
JSCLCR1620X09-F15	16	20	120	12	27	12.5	16	15	28	0.2	CC**09T3...	1.2

SPARE PARTS



Torque: Recommended clamping torque: N·m
**RE: Standard corner radius

Designation	Clamping screw	Wrench
JSCLCR**F15	CSTB-4SD	T-8F

INSERT SELECTION

P

Application	Precision finishing	Finish cutting	Medium to finish cutting	Medium to finish cutting
Grade	01 SH725	JS SH725	JS AH725	J10 SH725
Chipbreaker shape				
Cutting conditions	G069			

M

Application	Precision finishing	Finish cutting	Medium to finish cutting	Medium to finish cutting
Grade	01 SH725	JS SH725	JS AH725	J10 SH725
Chipbreaker shape				
Cutting conditions	G069			

K

Application	Medium to finish cutting
Grade	CM T515
Chipbreaker shape	
Cutting conditions	B024

N

Application	Precision finishing	Finish cutting	Medium cutting
Grade	DX120	TH10	KS05F
Chipbreaker shape	T-DIA with rake W20	AL	
Cutting conditions	B026		

S

Application	Finish cutting	Medium to finish cutting
Grade	JS SH725	JS AH725
Chipbreaker shape		
Cutting conditions	G069	

H

Application	Precision finishing	Finish cutting
Grade	BXM10	BXM20
Chipbreaker shape	T-CBN	T-CBN
Cutting conditions	B030	

Reference pages: JSCLCR/L, JSCLCR-F: Inserts → **B111** -, CBN → **B182**, PCD → **B196** -

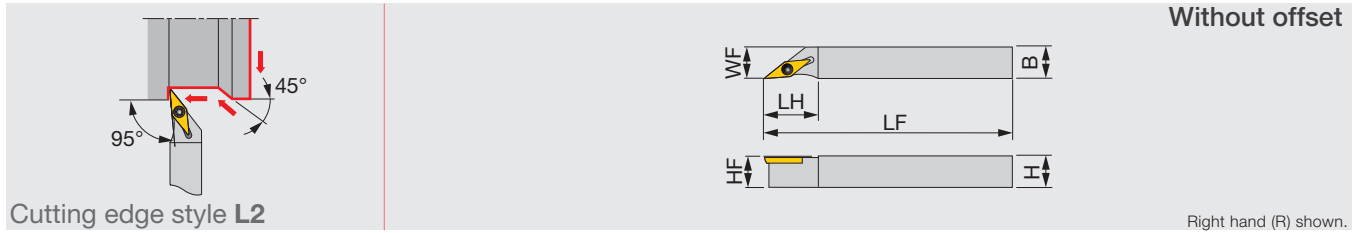

Right hand (R) shown.

Inch	H	B	LF	LH	HF	WF	RE**	Insert	Torque
JSVL2PR/L082	0.500	0.500	5.000	0.813	0.500	0.500	0.008	VP**1103...	0.89
JSVL2PR/L102	0.625	0.625	5.000	0.813	0.625	0.625	0.008	VP**1103...	0.89

Metric	H	B	LF	LH	HF	WF	RE**	Insert	Torque*
JSVL2PR/L1010X08	10	10	120	16	10	10	0.2	VP**0802...	0.6
JSVL2PR/L1010K08	10	10	125	16	10	10	0.2	VP**0802...	0.6
JSVL2PR/L1212F08	12	12	85	16	12	12	0.2	VP**0802...	0.6
JSVL2PR/L1212F11	12	12	85	21	12	12	0.2	VP**1103...	1.2
JSVL2PR/L1212X08	12	12	120	16	12	12	0.2	VP**0802...	0.6
JSVL2PR/L1212X11	12	12	120	21	12	12	0.2	VP**1103...	1.2
JSVL2PR/L1212K08	12	12	125	16	12	12	0.2	VP**0802...	0.6
JSVL2PR/L1616X08	16	16	120	16	16	16	0.2	VP**0802...	0.6
JSVL2PL1616K08	16	16	125	16	16	16	0.2	VP**0802...	0.6
JSVL2PR/L1616X11	16	16	120	21	16	16	0.2	VP**1103...	1.2

Torque: Recommended clamping torque: lbs-ft (*N·m)

**RE: Standard corner radius

SPARE PARTS

Designation	Clamping screw	Wrench
JSVL2PR/L082/102	CSTB-2.5	T-8F
JSVL2PR/L**08	CSTB-2L	T-6F
JSVL2PR/L**11	CSTB-2.5	T-8F

INSERT SELECTION

Application	Finish cutting	
	Grade	Grade
	SH725	SH725
	JRP	JSP
Chipbreaker shape		
Cutting conditions	G069	

Application	Finish cutting	
	Grade	Grade
	SH725	SH725
	JRP	JSP
Chipbreaker shape		
Cutting conditions	G069	

Application	Finish cutting	
	Grade	Grade
	SH725	SH725
	JRP	JSP
Chipbreaker shape		
Cutting conditions	G069	

Screw-on toolholder with 93° approach angle, for DXGU inserts

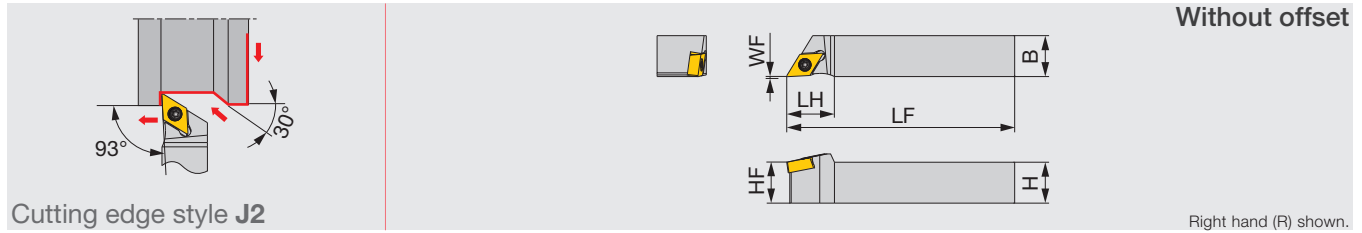

Inch	H	B	LF	LH	HF	WF	RE**	Insert	Torque
JSDJ2XR/L062	0.375	0.375	4.750	0.625	0.375	0	0.008	DXGU0703**L/R...	0.66
JSDJ2XR/L082	0.500	0.500	4.750	0.625	0.500	0	0.008	DXGU0703**L/R...	0.66
JSDJ2XR/L102	0.625	0.625	4.750	0.625	0.625	0	0.008	DXGU0703**L/R...	0.66

Metric	H	B	LF	LH	HF	WF	RE**	Insert	Torque*
JSDJ2XR/L1010X07	10	10	120	14	10	0	0.2	DXGU0703**L/R...	0.9
JSDJ2XR/L1212F07	12	12	85	14	12	0	0.2	DXGU0703**L/R...	0.9
JSDJ2XR/L1212X07	12	12	120	14	12	0	0.2	DXGU0703**L/R...	0.9
JSDJ2XR/L1616X07	16	16	120	18	16	0	0.2	DXGU0703**L/R...	0.9
JSDJ2XR/L2020H07	20	20	100	18	20	0	0.2	DXGU0703**L/R...	0.9

Torque: Recommended clamping torque: lbs-ft (*N-m) **RE: Standard corner radius
Use right-hand toolholders (R) with left-hand inserts (L); and left-hand toolholders (L) with right-hand inserts (R).

SPARE PARTS

Designation	Clamping screw	Wrench
JSDJ2XR/L...	SR34-514	T-7F

INSERT SELECTION

Swiss lathes

P	Application	Finish cutting	Medium to finish cutting	M	Application	Finish cutting	Medium to finish cutting
	Grade	SH725	SH725		SH725	Grade	SH725
Chipbreaker shape	JSS	JS	JS	Chipbreaker shape	JSS	JS	JS
Cutting conditions	G069			Cutting conditions	G069		

Small CNC lathes

P	Application	Finish cutting	Medium cutting	M	Application	Finish cutting	Medium cutting
	Grade	AH725	AH725		AH725	Grade	AH8015
Chipbreaker shape	SS	TS	TS	Chipbreaker shape	SS	TS	TS
Cutting conditions	G069			Cutting conditions	G069		

Reference pages: JSDJ2XR/L: Inserts → B127 -, Standard cutting conditions → G069

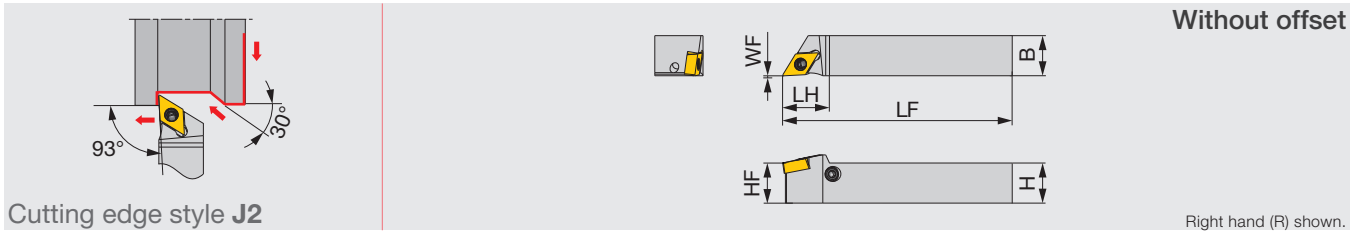

Cutting edge style **J2**

Right hand (R) shown.

Inch	H	B	LF	LH	HF	WF	RE**	Insert	Torque
JPDJ2XR/L062	0.375	0.375	4.750	0.625	0.375	0	0.008	DXGU22**L/R...	0.66
JPDJ2XR/L082	0.500	0.500	4.750	0.625	0.500	0	0.008	DXGU22**L/R...	0.66
JPDJ2XR/L102	0.625	0.625	4.750	0.625	0.625	0	0.008	DXGU22**L/R...	0.66

Metric	H	B	LF	LH	HF	WF	RE**	Insert	Torque*
JPDJ2XR/L1010X07	10	10	120	14	10	0	0.2	DXGU0703**L/R...	0.9
JPDJ2XR/L1212F07	12	12	85	14	12	0	0.2	DXGU0703**L/R...	0.9
JPDJ2XR/L1212X07	12	12	120	14	12	0	0.2	DXGU0703**L/R...	0.9
JPDJ2XR/L1616X07	16	16	120	18	16	0	0.2	DXGU0703**L/R...	0.9

Torque: Recommended clamping torque: lbs-ft (*N-m) **RE: Standard corner radius
Use right-hand toolholders (R) with left-hand inserts (L); and left-hand toolholders (L) with right-hand inserts (R).

SPARE PARTS

Designation	Lever	Pin	Clamping screw	Wrench
JPDJ2XR/L...	SLLV-2	SL-PI-2	SR10400611	HW2.0/5RED

INSERT SELECTION

Swiss lathes

Application	Finish cutting		Medium to finish cutting	
	Grade	SH725	Grade	SH725
Chipbreaker shape	JSS	JS	JSS	JS
Cutting conditions	G069			

Small CNC lathes

Application	Finish cutting		Medium cutting	
	Grade	AH725	Grade	AH8015
Chipbreaker shape	SS	TS	SS	TS
Cutting conditions	G069			

Reference pages: JPDJ2XR/L: Inserts → **B127 -**, Standard cutting conditions → **G069**

Screw-on toolholder with 93° approach angle, for DXGU inserts, with high pressure coolant capability

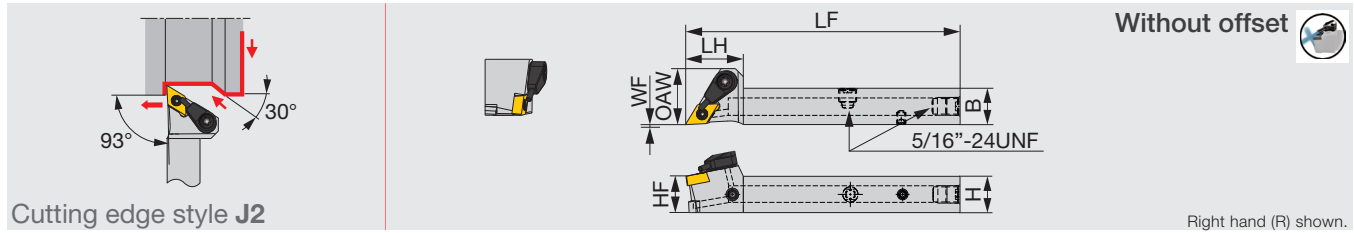

Inch	H	B	LF	LH	HF	WF	OAW	RE**	Insert	Torque
JSDJ2XR082X-CHP	0.500	0.500	4.750	0.748	0.500	0	0.728	0.008	DXGU0703**L...	0.66
JSDJ2XR102X-CHP	0.625	0.625	4.750	0.748	0.625	0	0.728	0.008	DXGU0703**L...	0.66

Metric	H	B	LF	LH	HF	WF	OAW	RE**	Insert	Torque*
JSDJ2XR1212X07-CHP	12	12	120	19	12	0	18.5	0.2	DXGU0703**L...	0.9
JSDJ2XR1616X07-CHP	16	16	120	19	16	0	18.5	0.2	DXGU0703**L...	0.9

Torque: Recommended clamping torque: lbs-ft (*N-m) **RE: Standard corner radius
Use right-hand toolholders (R) with left-hand inserts (L).

SPARE PARTS

Designation	Clamping screw	Coolant unit	Wrench 1	Coolant plug	Wrench 2	DirectJet plug	Wrench 3
JSDJ2XR*-CHP	SR34-514	S-CU-CHP	T-7F	SR5/16UNFTL360	P-4	SSHM4-6-TB	P-2

Please see Tungaloy report (TR432) for tool overhang length and coolant plug.

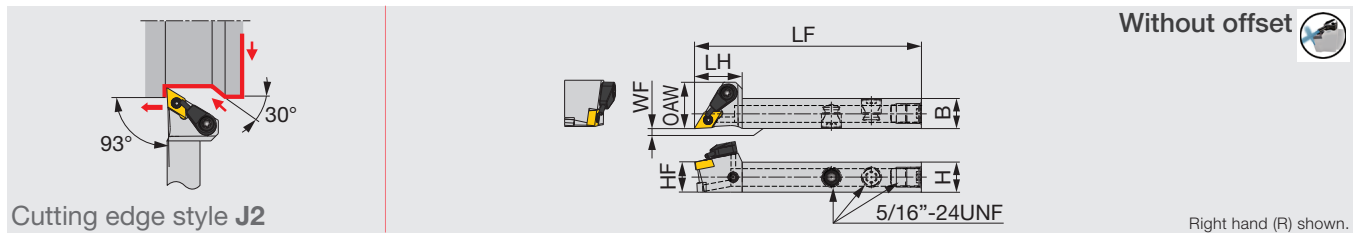

Inch	H	B	LF	LH	HF	WF	OAW	RE**	Insert	Torque
JSDJ2XR/L082-CHP	0.500	0.500	3.344	0.750	0.500	0	0.730	0.008	DXGU0703**L/R...	0.66

Metric	H	B	LF	LH	HF	WF	OAW	RE**	Insert	Torque*
JSDJ2XR/L1212F07-CHP	12	12	85	19	12	0	18.5	0.2	DXGU0703**L/R...	0.9

Torque: Recommended clamping torque: lb-ft (*N-m) **RE: Standard corner radius
Use right-hand toolholders (R) with left-hand inserts (L); and left-hand toolholders (L) with right-hand inserts (R).

SPARE PARTS

Designation	Clamping screw	Coolant unit	Wrench 1	Coolant plug	Wrench 2
JSDJ2XR/L*-CHP	SR34-514	S-CU-CHP	T-7F	SR5/16UNFTL360	P-4

INSERT SELECTION

Swiss lathes

Application	Finish cutting		Application	Finish cutting	
	Grade	Medium to finish cutting		Grade	Medium to finish cutting
Grade	SH725	SH725	Grade	SH725	SH725
Chipbreaker shape	JSS	JS	Chipbreaker shape	JSS	JS
Cutting conditions	G069		Cutting conditions	G069	

Small CNC lathes

Application	Finish cutting		Application	Finish cutting	
	Grade	Medium cutting		Grade	Medium cutting
Grade	AH725	AH725	Grade	AH8015	AH8015
Chipbreaker shape	SS	TS	Chipbreaker shape	SS	TS
Cutting conditions	G069		Cutting conditions	G069	

Reference pages: JSDJ2XR/L-CHP: Inserts → **B127 -**, Standard cutting conditions → **G069**



Screw-on stepped-head toolholder with 93° approach angle, for DXGU inserts

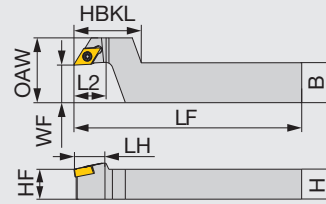
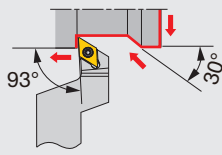

Cutting edge style J

Right hand (R) shown.

Inch	H	B	LF	L2	HBKL	LH	HF	WF	OAW	RE**	Insert	Torque
JSDJXR082-F10	0.500	0.625	4.750	0.500	1.130	0.625	0.500	0.625	1.000	0.008	DXGU0703**L...	0.66
JSDJXR102-F10	0.625	0.750	4.750	0.500	1.130	0.625	0.625	0.625	1.000	0.008	DXGU0703**L...	0.66

Metric	H	B	LF	L2	HBKL	LH	HF	WF	OAW	RE**	Insert	Torque*
JSDJXR1016X07-F15	10	16	120	12	27	14	10	15	26	0.2	DXGU0703**L...	0.9
JSDJXR1216F07-F15	12	16	85	12	27	14	12	15	26	0.2	DXGU0703**L...	0.9
JSDJXR1216X07-F15	12	16	120	12	27	14	12	15	26	0.2	DXGU0703**L...	0.9
JSDJXR1620X07-F15	16	20	120	12	27	14	16	15	26	0.2	DXGU0703**L...	0.9

Torque: Recommended clamping torque: lbs-ft (*N-m) **RE: Standard corner radius
Use right-hand toolholders (R) with left-hand inserts (L).

SPARE PARTS



Designation	Clamping screw	Wrench
JSDJXR**-F...	SR34-514	T-7F

INSERT SELECTION

Swiss lathes

P	Application	Finish cutting	Medium to finish cutting
	Grade	SH725	SH725
Chipbreaker shape	JSS	JS	
Cutting conditions	G069		

M	Application	Finish cutting	Medium to finish cutting
	Grade	SH725	SH725
Chipbreaker shape	JSS	JS	
Cutting conditions	G069		

Small CNC lathes

P	Application	Finish cutting	Medium cutting
	Grade	AH725	AH725
Chipbreaker shape	SS	TS	
Cutting conditions	G069		

M	Application	Finish cutting	Medium cutting
	Grade	AH8015	AH8015
Chipbreaker shape	SS	TS	
Cutting conditions	G069		

Reference pages: JSDJXR-F: Inserts → **B127 -**, Standard cutting conditions → **G069**

Screw-on round-shank toolholder with 93° approach angle, for DXGU inserts

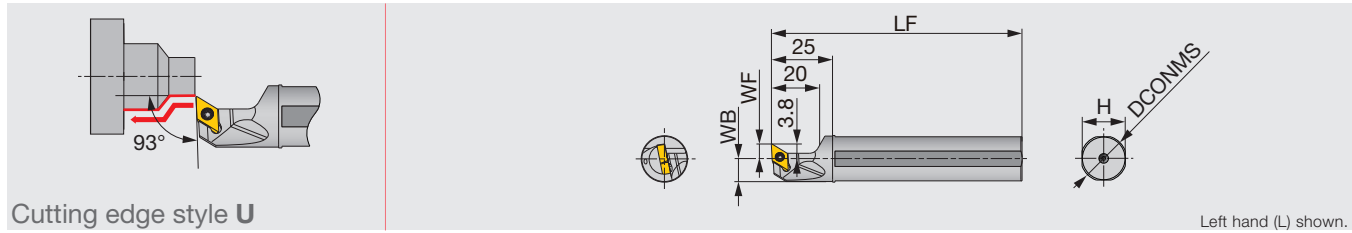

Cutting edge style U

Left hand (L) shown.

Inch	DCONMS	WF	LF	H	WB	RE**	Insert	Torque
JS159F-SDUXL07	0.625	0.236	3.346	0.591	0.303	0.008	DXGU0703**L...	0.66
JS19G-SDUXL07	0.750	0.236	3.543	0.709	0.366	0.008	DXGU0703**L...	0.66
JS19X-SDUXL07	0.750	0.236	4.724	0.709	0.366	0.008	DXGU0703**L...	0.66
JS254X-SDUXL07	1.000	0.394	4.724	0.945	0.492	0.008	DXGU0703**L...	0.66

Metric	DCONMS	WF	LF	H	WB	RE**	Insert	Torque*
JS14H-SDUXL07	14	6	100	13	6.75	0.2	DXGU0703**L...	0.9
JS159F-SDUXL07	15.875	6	85	15	7.687	0.2	DXGU0703**L...	0.9
JS16F-SDUXL07	16	6	85	15	7.75	0.2	DXGU0703**L...	0.9
JS19G-SDUXL07	19.05	6	90	18	9.275	0.2	DXGU0703**L...	0.9
JS19X-SDUXL07	19.05	6	120	18	9.275	0.2	DXGU0703**L...	0.9
JS20G-SDUXL07	20	6	90	19	9.75	0.2	DXGU0703**L...	0.9
JS20X-SDUXL07	20	6	120	19	9.75	0.2	DXGU0703**L...	0.9
JS22X-SDUXL07	22	10	120	21	10.75	0.2	DXGU0703**L...	0.9
JS25H-SDUXL07	25	10	100	24	12.25	0.2	DXGU0703**L...	0.9
JS254X-SDUXL07	25.4	10	120	24	12.45	0.2	DXGU0703**L...	0.9

Torque: Recommended clamping torque: lbs-ft (**N-m) **RE: Standard corner radius
Use left-hand toolholders (L) with left-hand inserts (L).

SPARE PARTS

Designation	Clamping screw	Wrench
JS**-SDUXL07	SR34-514	T-7F

INSERT SELECTION

Swiss lathes

P	Application	Finish cutting	Medium to finish cutting	M	Application	Finish cutting	Medium to finish cutting
	Grade	SH725	SH725		Grade	SH725	SH725
Chipbreaker shape	JSS	JS	Chipbreaker shape	JSS	JS		
Cutting conditions	G069		Cutting conditions	G069			

Small CNC lathes

P	Application	Finish cutting	Medium cutting	M	Application	Finish cutting	Medium cutting
	Grade	AH725	AH725		Grade	AH8015	AH8015
Chipbreaker shape	SS	TS	Chipbreaker shape	SS	TS		
Cutting conditions	G069		Cutting conditions	G069			

Reference pages: JS-SDUXL: Inserts → B127 -, Standard cutting conditions → G069



J-SERIES

JSDJ2CR/L

Screw-on toolholder with 93° approach angle, for positive 55° rhombic inserts

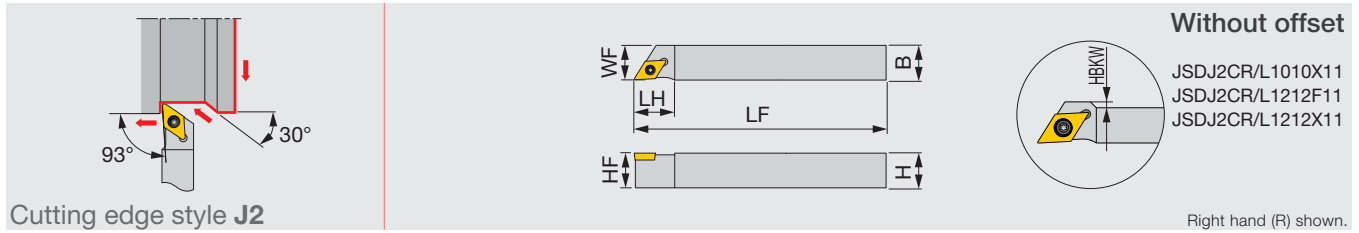

Inch	H	B	LF	LH	HF	WF	HBKW	RE**	Insert	Torque
JSDJ2CR/L062	0.375	0.375	5.000	0.563	0.375	0.380	-	0.008	DC**0702...	0.89
JSDJ2CR/L082	0.500	0.500	5.000	0.563	0.500	0.500	-	0.008	DC**0702...	0.89
JSDJ2CR/L103	0.625	0.625	5.000	0.813	0.625	0.630	-	0.008	DC**11T3...	0.89

Metric	H	B	LF	LH	HF	WF	HBKW	RE**	Insert	Torque*
JSDJ2CR/L0808F07	8	8	85	14	8	8	-	0.2	DC**0702...	1.2
JSDJ2CR/L1010X07	10	10	120	14	10	10	-	0.2	DC**0702...	1.2
JSDJ2CR/L1010X11	10	10	120	20	10	10	4	0.2	DC**11T3...	1.2
JSDJ2CR/L1212F07	12	12	85	14	12	12	-	0.2	DC**0702...	1.2
JSDJ2CR/L1212F11	12	12	85	20	12	12	2	0.2	DC**11T3...	1.2
JSDJ2CR/L1212X07	12	12	120	14	12	12	-	0.2	DC**0702...	1.2
JSDJ2CR/L1212X11	12	12	120	20	12	12	2	0.2	DC**11T3...	1.2
JSDJ2CR/L1616X11	16	16	120	20	16	16	-	0.2	DC**11T3...	1.2

Torque: Recommended clamping torque: lbs-ft (*N-m) **RE: Standard corner radius

SPARE PARTS

Designation	Clamping screw	Wrench
JSDJ2CR/L062/082, JSDJ2CR/L**07	CSTB-2.5	T-8F
JSDJ2CR/L103, JSDJ2CR/L**11	CSTB-4SD	T-8F

J-SERIES

JTDJ2CR/L

Back-clamp toolholder with 93° approach angle, for positive 55° rhombic inserts

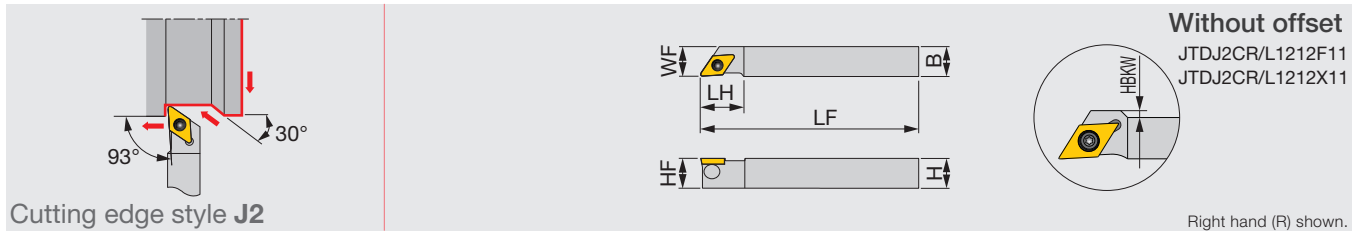

Metric	H	B	LF	LH	HF	WF	HBKW	RE**	Insert	Torque
JTDJ2CR/L1010X07	10	10	120	14	10	10	-	0.2	DC**0702...	0.9
JTDJ2CR/L1212F07	12	12	85	14	12	12	-	0.2	DC**0702...	0.9
JTDJ2CR/L1212X07	12	12	120	14	12	12	-	0.2	DC**0702...	0.9
JTDJ2CR/L1212F11	12	12	85	20	12	12	2	0.2	DC**11T3...	1.2
JTDJ2CR/L1212X11	12	12	120	20	12	12	2	0.2	DC**11T3...	1.2
JTDJ2CR/L1616X11	16	16	120	20	16	16	-	0.2	DC**11T3...	1.2

Torque: Recommended clamping torque: N-m **RE: Standard corner radius

SPARE PARTS

Designation	Clamp	Clamping screw	Wrench
JTDJ2CR/L**07	JCP-2	JDS-3525	P-2F
JTDJ2CR/L**11	JCP-3	JDS-5040	P-2.5F

Reference pages: JSDJ2CR/L, JTDJ2CR/L: Inserts → **B121 -**, CBN → **B184-**, PCD → **B196 -**

Screw-on toolholder with 93° approach angle, for positive 55° rhombic inserts, with high pressure coolant capability

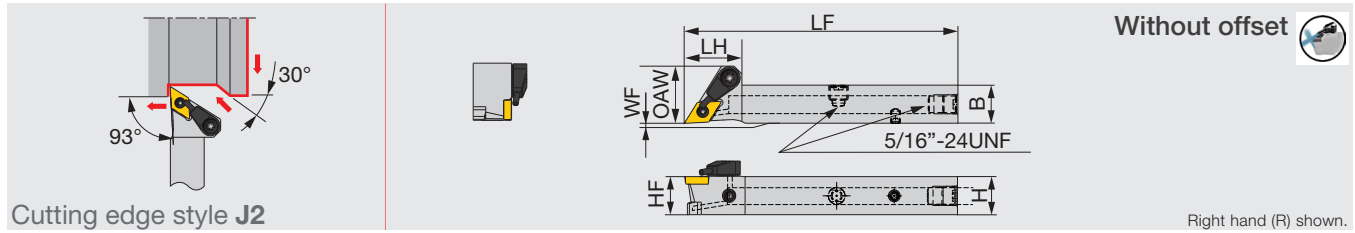

Metric	H	B	LF	LH	HF	WF	OAW	RE	Insert	Torque
JSDJ2CR1212X11-CHP	12	12	120	19	12	0	20.5	0.2	DC**11T3...	1.2
JSDJ2CR1616X11-CHP	16	16	120	19	16	0	20.5	0.2	DC**11T3...	1.2

Torque: Recommended clamping torque: N·m **RE: Standard corner radius

SPARE PARTS

Designation	Clamping screw	Coolant unit	Wrench 1	Coolant plug	Wrench 2	DirectJet plug	Wrench 3
JSDJ2CR**11-CHP	CSTB-4SD	S-CU-CHP	T-8F	SR5/16UNFTL360	P-4	SSH4-6-TB	P-2

Please see Tungaloy report (TR432) for tool overhang length and coolant plug.

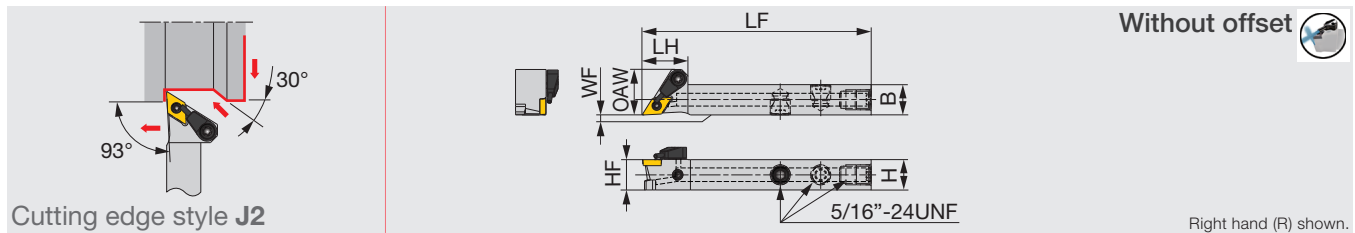

Inch	H	B	LF	LH	HF	WF	OAW	RE	Insert	Torque
JSDJ2CR/L082-CHP	0.500	0.500	3.344	0.710	0.500	0.500	0.710	0.2	DC**0702...	0.89

Metric	H	B	LF	LH	HF	WF	OAW	RE**	Insert	Torque*
JSDJ2CR/L1212F07-CHP	12	12	85	18	12	0	18	0.2	DC**0702...	1.2
JSDJ2CR/L1212F11-CHP	12	12	85	19	12	0	20.5	0.2	DC**11T3...	1.2

Torque: Recommended clamping torque: lb-ft (*N·m) **RE: Standard corner radius

SPARE PARTS

Designation	Clamping screw	Coolant unit	Wrench 1	Coolant plug	Wrench 2
JSDJ2CR/L082-CHP, JSDJ2CR/L1212F07-CHP	CSTB-2.5	S-CU-CHP	T-8F	SR5/16UNFTL360	P-4
JSDJ2CR/L1212F11-CHP	CSTB-4SD	S-CU-CHP	T-8F	SR5/16UNFTL360	P-4

INSERT SELECTION

P

Application	Precision finishing	Finish cutting	Medium to finish cutting	Medium to finish cutting
Grade	SH725	SH725	AH725	SH725
Chipbreaker shape	01	JS	JS	J10
Cutting conditions	G069			

M

Application	Precision finishing	Finish cutting	Medium to finish cutting	Medium to finish cutting
Grade	SH725	SH725	AH725	SH725
Chipbreaker shape	01	JS	JS	J10
Cutting conditions	G069			

K

Application	Medium to finish cutting
Grade	T515
Chipbreaker shape	CM
Cutting conditions	B024

N

Application	Precision finishing	Medium cutting
Grade	DX120	KS05F
Chipbreaker shape	T-DIA with rake	AL
Cutting conditions	B026	

S

Application	Finish cutting	Medium to finish cutting
Grade	SH725	AH725
Chipbreaker shape	JS	JS
Cutting conditions	G069	

H

Application	Precision finishing	Finish cutting
Grade	BXM10	BXM20
Chipbreaker shape	T-CBN	T-CBN
Cutting conditions	B030	

Reference pages: JSDJ2CR/L-CHP: Inserts → B121 -, CBN → B184 -, PCD → B196 -



J-SERIES

JSDJCR/L

Screw-on toolholder with 93° approach angle, for positive 55° rhombic inserts

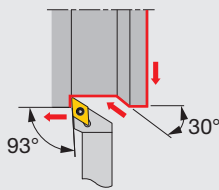

Cutting edge style J



Right hand (R) shown.

Metric	H	B	LF	LH	HF	WF	RE**	Insert	Torque
JSDJCR/L0808H07	8	8	100	14	8	10	0.4	DC**0702...	1.2
JSDJCR/L1010H11	10	10	100	18	10	12	0.8	DC**11T3...	1.2
JSDJCR/L1212H07	12	12	100	14	12	16	0.4	DC**0702...	1.2
JSDJCR/L1212H11	12	12	100	18	12	16	0.8	DC**11T3...	1.2
JSDJCR/L1616H11	16	16	100	18	16	20	0.8	DC**11T3...	1.2

Torque: Recommended clamping torque: N·m

**RE: Standard corner radius

SPARE PARTS

Designation	Clamping screw	Wrench
JSDJC**H07	CSTB-2.5	T-8F
JSDJC**H11	CSTB-4SD	T-8F

J-SERIES

JSDJCR-F

Screw-on stepped-head toolholder with 93° approach angle, for positive 55° rhombic inserts

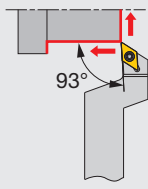

Cutting edge style J

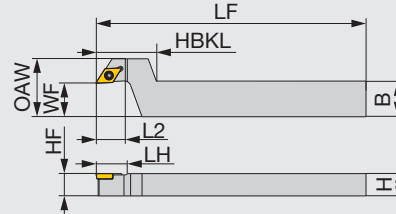

Right hand (R) shown.

Metric	H	B	LF	L2	HBKL	LH	HF	WF	OAW	RE**	Insert	Torque
JSDJCR1016X07-F15	10	16	120	12.5	27	14	10	15	26	0.2	DC**0702...	1.2
JSDJCR1216F07-F15	12	16	85	12.5	27	14	12	15	26	0.2	DC**0702...	1.2
JSDJCR1216X07-F15	12	16	120	12.5	27	14	12	15	26	0.2	DC**0702...	1.2
JSDJCR1216F11-F15	12	16	85	12.5	27	20	12	15	28	0.2	DC**11T3...	1.2
JSDJCR1216X11-F15	12	16	120	12.5	27	20	12	15	28	0.2	DC**11T3...	1.2
JSDJCR1620X11-F15	16	20	120	12.5	27	20	16	15	28	0.2	DC**11T3...	1.2

Torque: Recommended clamping torque: N·m

**RE: Standard corner radius

SPARE PARTS

Designation	Clamping screw	Wrench
JSDJCR**07-F15	CSTB-2.5	T-8F
JSDJCR**11-F15	CSTB-4SD	T-8F

Reference pages: JSDJCR/L, JSDJCR-F: Inserts → **B121** -, CBN → **B184** -, PCD → **B196** -

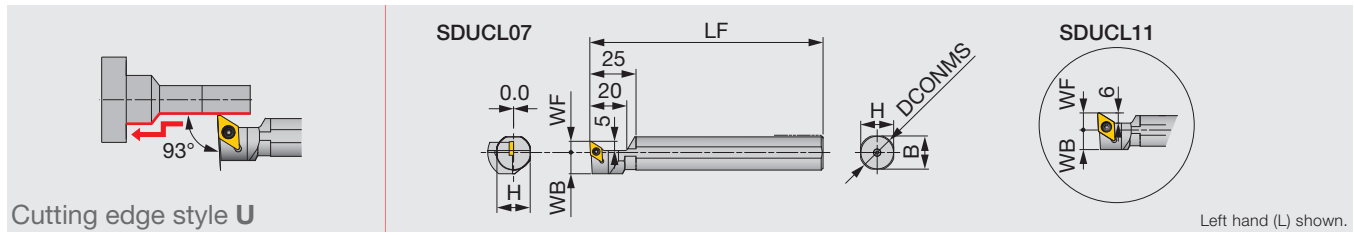

Cutting edge style U

Left hand (L) shown.

Metric	DCONMS	WF	LF	H	B	WB	RE**	Insert	Torque
JS19K-SDUCL07	19.05	6	125	18	18	11.5	0.4	DC**0702...	1.2
JS20K-SDUCL07	20	6	125	19	19	11.5	0.4	DC**0702...	1.2
JS22K-SDUCL07	22	6	125	21	21	11.5	0.4	DC**0702...	1.2
JS19K-SDUCL11	19.05	10	125	18	18	11.5	0.8	DC**11T3...	1.2
JS20K-SDUCL11	20	10	125	19	19	11.5	0.8	DC**11T3...	1.2
JS22K-SDUCL11	22	11	125	21	21	11.5	0.8	DC**11T3...	1.2
JS25K-SDUCL11	25.4	12	125	24	24	12.7	0.8	DC**11T3...	1.2

Torque: Recommended clamping torque: N·m

**RE: Standard corner radius

SPARE PARTS



Designation	Clamping screw	Wrench
JS**K-SDUCL07	CSTB-2.5	T-8F
JS**K-SDUCL11	CSTB-4SD	T-8F

INSERT SELECTION

Application	Precision finishing	Finish cutting	Medium to finish cutting	Medium to finish cutting
	SH725	SH725	AH725	SH725
Grade	01	JS	JS	J10
Chipbreaker shape				
Cutting conditions	G069			

Application	Precision finishing	Finish cutting	Medium to finish cutting	Medium to finish cutting
	SH725	SH725	AH725	SH725
Grade	01	JS	JS	J10
Chipbreaker shape				
Cutting conditions	G069			

Application	Medium to finish cutting
	T515
Grade	CM
Chipbreaker shape	
Cutting conditions	B024

Application	Precision finishing	Finish cutting	Medium cutting
	DX120	DX140	KS05F
Grade	T-DIA	with rake T-DIA	AL
Chipbreaker shape			
Cutting conditions	B026		

Application	Finish cutting	Medium to finish cutting
	SH725	AH725
Grade	JS	JS
Chipbreaker shape		
Cutting conditions	G069	

Application	Precision finishing	Finish cutting
	BXM10	BXM10
Grade	T-CBN	T-CBN
Chipbreaker shape		
Cutting conditions	B030	

Reference pages: JS-SDUCL: Inserts → B121 -, CBN → B184 -, PCD → B196 -

Screw-on toolholder with 93° approach angle, for VXGU inserts

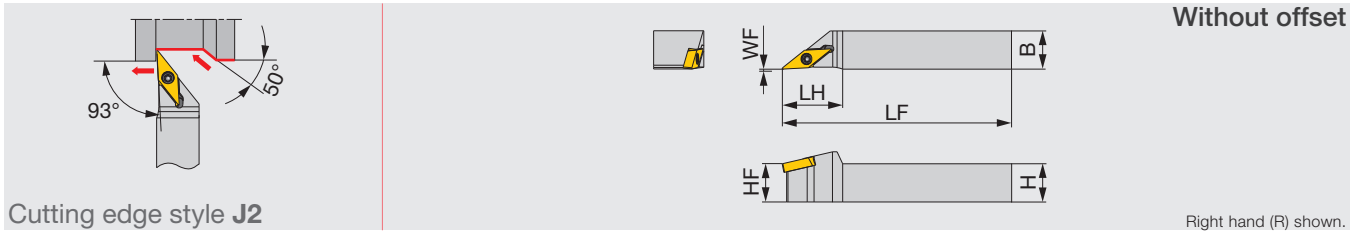

Inch	H	B	LF	LH	HF	WF	RE**	Insert	Torque
JSVJ2XR/L067	0.375	0.375	4.750	0.669	0.375	0	0.008	VXGU09T2**/L/R...	0.66
JSVJ2XR/L087	0.500	0.500	4.750	0.748	0.500	0	0.008	VXGU09T2**/L/R...	0.66
JSVJ2XR/L107	0.625	0.625	4.750	0.748	0.625	0	0.008	VXGU09T2**/L/R...	0.66

Metric	H	B	LF	LH	HF	WF	RE**	Insert	Torque*
JSVJ2XR/L1010X09	10	10	120	17	10	0	0.2	VXGU09T2**/L/R...	0.9
JSVJ2XR/L1212F09	12	12	85	19	12	0	0.2	VXGU09T2**/L/R...	0.9
JSVJ2XR/L1212X09	12	12	120	19	12	0	0.2	VXGU09T2**/L/R...	0.9
JSVJ2XR/L1616X09	16	16	120	19	16	0	0.2	VXGU09T2**/L/R...	0.9
JSVJ2XR/L2020H09	20	20	100	19	20	0	0.2	VXGU09T2**/L/R...	0.9

Torque: Recommended clamping torque: lbs-ft (*N-m) **RE: Standard corner radius
Use right-hand toolholders (R) with left-hand inserts (L). Use left-hand toolholders (L) with right-hand inserts (R).

SPARE PARTS

Designation	Clamping screw	Wrench
JSVJ2XR/L...	SR34-508	T-7F

Lever-lock toolholder with 93° approach angle, for VXGU inserts

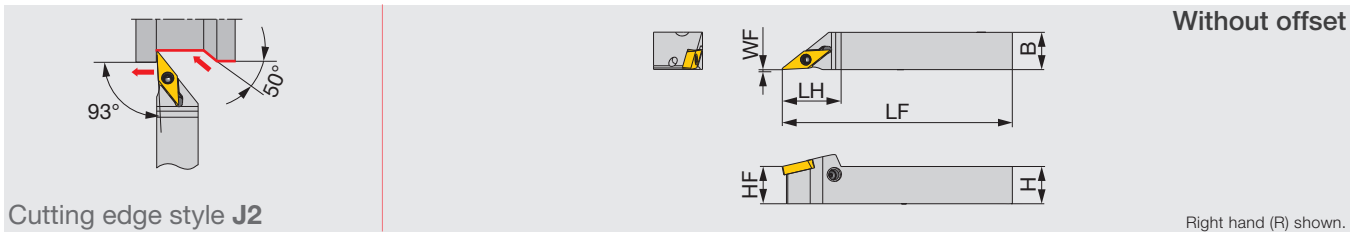

Inch	H	B	LF	LH	HF	WF	RE**	Insert	Torque
JPVJ2XR/L067	0.375	0.375	4.750	0.669	0.375	0	0.008	VXGU09T2**/L/R...	0.66
JPVJ2XR/L087	0.500	0.500	4.750	0.748	0.500	0	0.008	VXGU09T2**/L/R...	0.66
JPVJ2XR/L107	0.625	0.625	4.750	0.748	0.625	0	0.008	VXGU09T2**/L/R...	0.66

Metric	H	B	LF	LH	HF	WF	RE**	Insert	Torque*
JPVJ2XR/L1010X09	10	10	120	19	10	0	0.2	VXGU09T2**/L/R...	0.9
JPVJ2XR/L1212F09	12	12	85	19	12	0	0.2	VXGU09T2**/L/R...	0.9
JPVJ2XR/L1212X09	12	12	120	19	12	0	0.2	VXGU09T2**/L/R...	0.9
JPVJ2XR/L1616X09	16	16	120	19	16	0	0.2	VXGU09T2**/L/R...	0.9

Torque: Recommended clamping torque: lbs-ft (*N-m) **RE: Standard corner radius
Use right-hand toolholders (R) with left-hand inserts (L). Use left-hand toolholders (L) with right-hand inserts (R).

SPARE PARTS

Designation	Lever	Pin	Clamping screw	Wrench
JPVJ2XR/L...	SLLV-1	SL-PI-2	SR10400611	HW2.0/5RED

Reference pages: JSVJ2XR/L, JPVJ2XR/L: Inserts → **B158**, Standard cutting conditions → **G069**

Screw-on toolholder with 93° approach angle, for VXGU inserts, with high pressure coolant capability

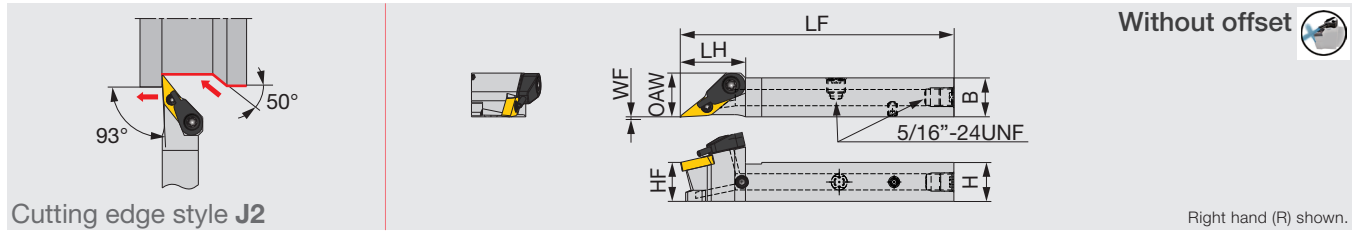

Inch	H	B	LF	LH	HF	WF	OAW	RE**	Insert	Torque
JSVJ2XR087X-CHP	0.500	0.500	4.750	0.768	0.500	0	0.528	0.008	VXGU09T2**L...	0.66
JSVJ2XR107X-CHP	0.625	0.625	4.750	0.768	0.625	0	0.625	0.008	VXGU09T2**L...	0.66

Metric	H	B	LF	LH	HF	WF	OAW	RE**	Insert	Torque*
JSVJ2XR1212X09-CHP	12	12	120	19.5	12	0	13.4	0.2	VXGU09T2**L...	0.9
JSVJ2XR1616X09-CHP	16	16	120	19.5	16	0	16	0.2	VXGU09T2**L...	0.9

Torque: Recommended clamping torque: lbs-ft (*N-m) **RE: Standard corner radius
Use right-hand toolholders (R) with left-hand inserts (L).

SPARE PARTS							
Designation	Clamping screw	Coolant unit	Wrench 1	Coolant plug	Wrench 2	DirectJet plug	Wrench 3
JSVJ2XR**-CHP	SR34-508	S-CU-CHP	T-7F	SR5/16UNFTL360	P-4	SSHM4-6-TB	P-2

Please see Tungaloy report (TR432) for tool overhang length and coolant plug.

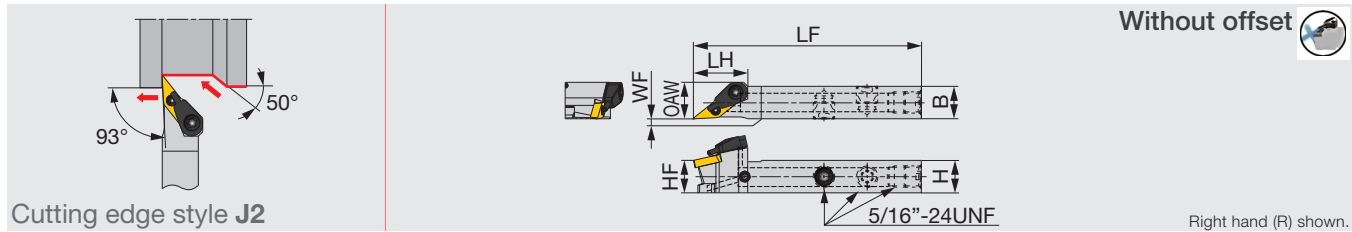

Inch	H	B	LF	LH	HF	WF	OAW	RE**	Insert	Torque
JSVJ2XR/L087-CHP	0.500	0.500	4.750	0.748	0.500	0	0.020	0.008	VXGU09T2**L/R...	0.66

Metric	H	B	LF	LH	HF	WF	OAW	RE**	Insert	Torque*
JSVJ2XR/L1212F09-CHP	12	12	85	20	12	0	13.5	0.2	VXGU09T2**L/R...	0.9

Torque: Recommended clamping torque: lb-ft (*N-m) **RE: Standard corner radius
Use right-hand toolholders (R) with left-hand inserts (L); and left-hand toolholders (L) with right-hand inserts (R).

SPARE PARTS					
Designation	Clamping screw	Coolant unit	Wrench 1	Coolant plug	Wrench 2
JSVJ2XR/L**-CHP	SR34-508	S-CU-CHP	T-7F	SR5/16UNFTL360	P-4

INSERT SELECTION

P	Application	Finish cutting	Medium to finish cutting
	Grade	SH725	SH725
Chipbreaker shape	JRP	JS	JS
Chipbreaker shape			
Cutting conditions	G069		

M	Application	Finish cutting	Medium to finish cutting
	Grade	SH725	SH725
Chipbreaker shape	JRP	JS	JS
Chipbreaker shape			
Cutting conditions	G069		

Reference pages: JSVJ2XR/L-CHP: Inserts → **B158**, Standard cutting conditions → **G069**

Grade
Insert
Toolholder
Ext. Toolholder
Int. Toolholder
Threading
Grooving
Miniature Tool
Milling Cutter
Endmill
Drilling Tool
User's Guide Tooling System
Index



Screw-on stepped-head toolholder with 93° approach angle, for VXGU inserts

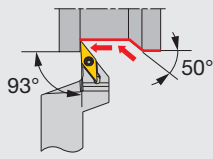

Cutting edge style J

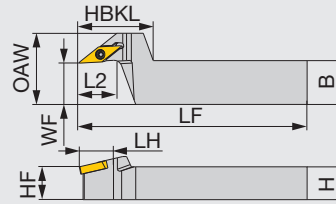

Right hand (R) shown.

Inch	H	B	LF	L2	HBKL	LH	HF	WF	OAW	RE**	Insert	Torque
JSVJXR087-F10	0.500	0.625	4.750	0.500	1.130	0.750	0.500	0.625	1.000	0.008	VXGU09T2**L...	0.66
JSVJXR107-F10	0.625	0.750	4.750	0.500	1.130	0.750	0.625	0.625	1.000	0.008	VXGU09T2**L...	0.66
Metric	H	B	LF	L2	HBKL	LH	HF	WF	OAW	RE**	Insert	Torque*
JSVJXR1016X09-F15	10	16	120	12	27	19	10	15	26	0.2	VXGU09T2**L...	0.9
JSVJXR1216F09-F15	12	16	85	12	27	19	12	15	26	0.2	VXGU09T2**L...	0.9
JSVJXR1216X09-F15	12	16	120	12	27	19	12	15	26	0.2	VXGU09T2**L...	0.9
JSVJXR1620X09-F15	16	20	120	12	27	19	16	15	26	0.2	VXGU09T2**L...	0.9

Torque: Recommended clamping torque: lbs-ft (*N-m) **RE: Standard corner radius
Use right-hand toolholders (R) with left-hand inserts (L).

SPARE PARTS



Designation	Clamping screw	Wrench
JSVJXR**-F10, JSVJXR**-F15	SR34-508	T-7F

INSERT SELECTION

Application	Finish cutting	Medium to finish cutting
	Grade	SH725
	JRP	JS
Chipbreaker shape		
Cutting conditions	G069	

Application	Finish cutting	Medium to finish cutting
	Grade	SH725
	JRP	JS
Chipbreaker shape		
Cutting conditions	G069	

Reference pages: JSVJXR-F: Inserts → B158, Standard cutting conditions → G069

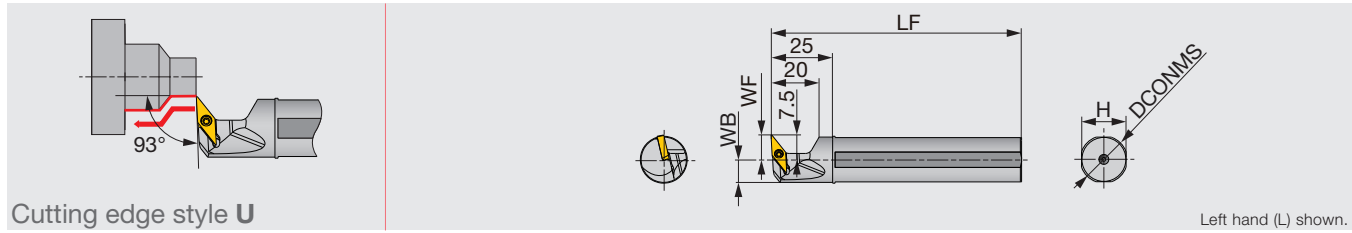

Cutting edge style U

Inch	DCONMS	WF	LF	H	WB	RE**	Insert	Torque
JS159F-SVUXL09	0.625	0.394	3.346	0.591	0.303	0.008	VXGU09T2**L...	0.66
JS19G-SVUXL09	0.750	0.394	3.543	0.709	0.362	0.008	VXGU09T2**L...	0.66
JS19X-SVUXL09	0.750	0.394	4.724	0.709	0.362	0.008	VXGU09T2**L...	0.66
JS254X-SVUXL09	1.000	0.394	4.724	0.945	0.488	0.008	VXGU09T2**L...	0.66

Metric	DCONMS	WF	LF	H	WB	RE**	Insert	Torque*
JS159F-SVUXL09	15.875	10	85	15	7.7	0.2	VXGU09T2**L...	0.9
JS16F-SVUXL09	16	10	85	15	7.7	0.2	VXGU09T2**L...	0.9
JS19G-SVUXL09	19.05	10	90	18	9.2	0.2	VXGU09T2**L...	0.9
JS19X-SVUXL09	19.05	10	120	18	9.2	0.2	VXGU09T2**L...	0.9
JS20G-SVUXL09	20	10	90	19	9.7	0.2	VXGU09T2**L...	0.9
JS20X-SVUXL09	20	10	120	19	9.7	0.2	VXGU09T2**L...	0.9
JS22X-SVUXL09	22	10	120	21	10.7	0.2	VXGU09T2**L...	0.9
JS25H-SVUXL09	25	10	100	24	12.2	0.2	VXGU09T2**L...	0.9
JS254X-SVUXL09	25.4	10	120	24	12.4	0.2	VXGU09T2**L...	0.9

Torque: Recommended clamping torque: lbs-ft (**N-m) **RE: Standard corner radius
Use left-hand toolholders (L) with left-hand inserts (L).

SPARE PARTS

Designation	Clamping screw	Wrench
JS**-SVUXL09	SR34-508	T-7F

INSERT SELECTION

Application	Finish cutting		Application	Medium to finish cutting	
	SH725	SH725		SH725	SH725
Grade	JRP	JS	Grade	JRP	JS
Chipbreaker shape			Chipbreaker shape		
Cutting conditions	G069		Cutting conditions	G069	

Reference pages: JS-SVUXL: Inserts → **B158**, Standard cutting conditions → **G069**

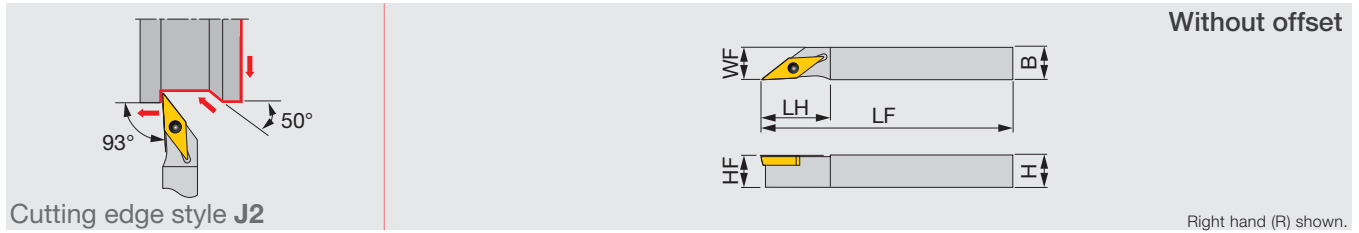

Inch	H	B	LF	LH	HF	WF	RE**	Insert	Torque
JSVJ2BR/L062	0.375	0.375	5.000	0.813	0.375	0.375	0.008	VB**1103...	0.89
JSVJ2BR/L082	0.500	0.500	5.000	0.813	0.500	0.500	0.008	VB**1103...	0.89
JSVJ2BR/L102	0.625	0.625	5.000	0.813	0.625	0.625	0.008	VB**1103...	0.89

Metric	H	B	LF	LH	HF	WF	RE**	Insert	Torque*
JSVJ2BR/L1010X11	10	10	120	21	10	10	0.2	VB**1103...	1.2
JSVJ2BR/L1212F11	12	12	85	21	12	12	0.2	VB**1103...	1.2
JSVJ2BR/L1212X11	12	12	120	21	12	12	0.2	VB**1103...	1.2
JSVJ2BR/L1616X11	16	16	120	21	16	16	0.2	VB**1103...	1.2

Torque: Recommended clamping torque: lbs-ft (*N-m)
 **RE: Standard corner radius

SPARE PARTS

Designation	Clamping screw	Wrench
JSVJ2BR/L...	CSTB-2.5	T-8F

INSERT SELECTION

Application	Finish cutting	Medium to finish cutting	Medium to finish cutting
	Grade	SH725	AH725
Chipbreaker shape	JS	JS	J10
Cutting conditions	G069		

Application	Finish cutting	Medium to finish cutting	Medium to finish cutting
	Grade	SH725	AH725
Chipbreaker shape	JS	JS	J10
Cutting conditions	G069		

Application	Medium to finish cutting
Grade	T515
Chipbreaker shape	CM
Cutting conditions	B024

Application	Finish cutting	Medium to finish cutting
Grade	SH725	AH725
Chipbreaker shape	JS	JS
Cutting conditions	G069	

Application	Precision finishing	Finish cutting
	Grade	BXM10
Chipbreaker shape	T-CBN	T-CBN
Cutting conditions	B030	

Reference pages: JSVJ2BR/L: Inserts → B152 -, CBN → B191 -

Screw-on toolholder with 93° approach angle, for positive 35° rhombic inserts, with high pressure coolant capability

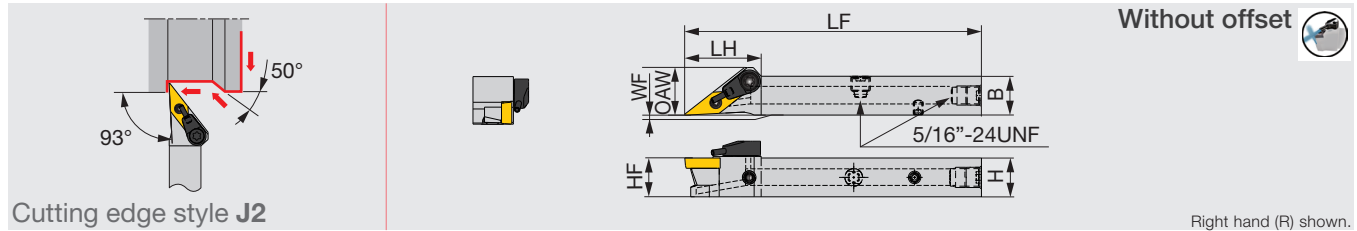

Metric	H	B	LF	LH	HF	WF	OAW	RE**	Insert	Torque
JSVJ2BR1212X11-CHP	12	12	120	23.6	12	0	14.7	0.2	VB**1103...	1.2
JSVJ2BR1616X11-CHP	16	16	120	23.6	16	0	16	0.2	VB**1103...	1.2

Torque: Recommended clamping torque: N·m **RE: Standard corner radius

SPARE PARTS

Designation	Clamping screw	Coolant unit	Wrench 1	Coolant plug	Wrench 2	DirectJet plug	Wrench 3
JSVJ2BR**11-CHP	CSTB-2.5	S-CU-CHP	T-8F	SR5/16UNFTL360	P-4	SSHM4-6-TB	P-2

Please see Tungaloy report (TR432) for tool overhang length and coolant plug.

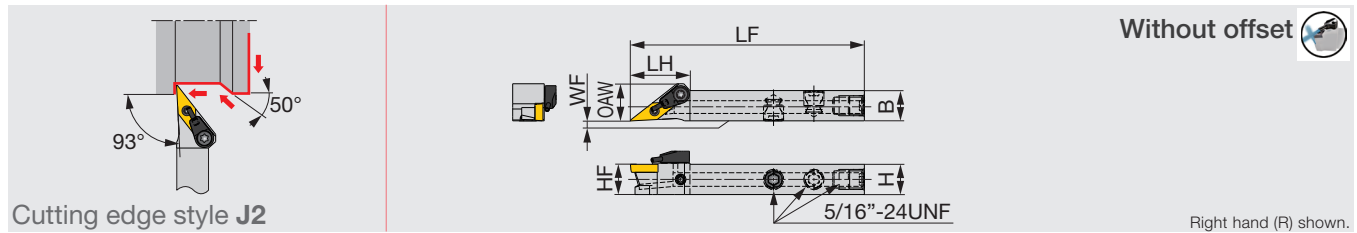

Inch	H	B	LF	LH	HF	WF	OAW	RE**	Insert	Torque
JSVJ2BR/L082-CHP	0.500	0.500	3.344	0.930	0.500	0	0.610	0.008	VB**1103...	0.89

Metric	H	B	LF	LH	HF	WF	OAW	RE**	Insert	Torque*
JSVJ2BR/L1212F11-CHP	12	12	85	23.6	12	0	14.7	0.2	VB**1103...	1.2

Torque: Recommended clamping torque: lb-ft (*N·m) **RE: Standard corner radius

SPARE PARTS

Designation	Clamping screw	Coolant unit	Wrench 1	Coolant plug	Wrench 2
JSVJ2BR/L*-CHP	CSTB-2.5	S-CU-CHP	T-8F	SR5/16UNFTL360	P-4

INSERT SELECTION

P

Application	Finish cutting	Medium to finish cutting	Medium to finish cutting
Grade	SH725	AH725	SH725
Chipbreaker shape	JS	JS	J10
Cutting conditions	G069		

M

Application	Finish cutting	Medium to finish cutting	Medium to finish cutting
Grade	SH725	AH725	SH725
Chipbreaker shape	JS	JS	J10
Cutting conditions	G069		

K

Application	Medium to finish cutting
Grade	T515
Chipbreaker shape	CM
Cutting conditions	B024

S

Application	Finish cutting	Medium to finish cutting
Grade	SH725	AH725
Chipbreaker shape	JS	JS
Cutting conditions	G069	

H

Application	Precision finishing	Finish cutting
Grade	BXM10	BXM10
Chipbreaker shape	T-CBN	T-CBN
Cutting conditions	B030	

Reference pages: JSVJ2BR/L-CHP: Inserts → B152 -, CBN → B191 -



J-SERIES

JSVJBR/L

Screw-on toolholder with 93° approach angle, for positive 35° rhombic inserts

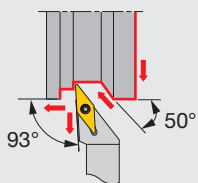

Cutting edge style J

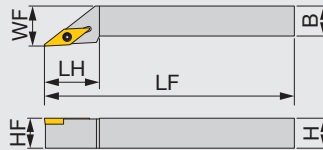

Right hand (R) shown.

Metric	H	B	LF	LH	HF	WF	RE**	Insert	Torque
JSVJBR/L1010H11	10	10	100	20	10	12	0.4	VB**1103...	1.2
JSVJBR/L1212H11	12	12	100	22	12	16	0.4	VB**1103...	1.2
JSVJBR/L1616H11	16	16	100	22	16	20	0.4	VB**1103...	1.2

SPARE PARTS



Torque: Recommended clamping torque: N·m
**RE: Standard corner radius

Designation	Clamping screw	Wrench
JSVJBR/L...	CSTB-2.5	T-8F

J-SERIES

JSVJBR-F

Screw-on stepped-head toolholder with 93° approach angle, for positive 35° rhombic inserts

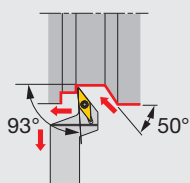

Cutting edge style J

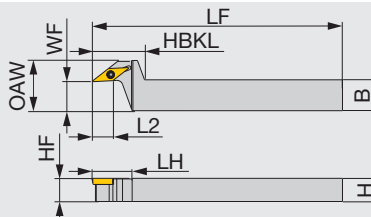

Right hand (R) shown.

Metric	H	B	LF	L2	HBKL	LH	HF	WF	OAW	RE**	Insert	Torque
JSVJBR1216F11-F15	12	16	85	12.6	27	21	12	15	26	0.2	VB**1103...	1.2
JSVJBR1216X11-F15	12	16	120	12.6	27	21	12	15	26	0.2	VB**1103...	1.2
JSVJBR1620X11-F15	16	20	120	12.6	27	21	16	15	26	0.2	VB**1103...	1.2

SPARE PARTS



Torque: Recommended clamping torque: N·m
**RE: Standard corner radius

Designation	Clamping screw	Wrench
JSVJBR**-F15	CSTB-2.5	T-8F

INSERT SELECTION

P	Application	Finish cutting	Medium to finish cutting	Medium to finish cutting
	Grade	JS	SH725	AH725
Chipbreaker shape				
Cutting conditions	G069			

M	Application	Finish cutting	Medium to finish cutting	Medium to finish cutting
	Grade	JS	SH725	AH725
Chipbreaker shape				
Cutting conditions	G069			

K	Application	Medium to finish cutting
	Grade	T515
Chipbreaker shape		
Cutting conditions	B024	

S	Application	Finish cutting	Medium to finish cutting
	Grade	JS	SH725
Chipbreaker shape			
Cutting conditions	G069		

H	Application	Precision finishing	Finish cutting
	Grade	T-CBN	BXM10
Chipbreaker shape			
Cutting conditions	B030		

Reference pages: JSVJBR/L, JSVJBR-F: Inserts → B152 -, CBN → B191 -

Screw-on toolholder with 62.5° approach angle, for positive 55° rhombic inserts

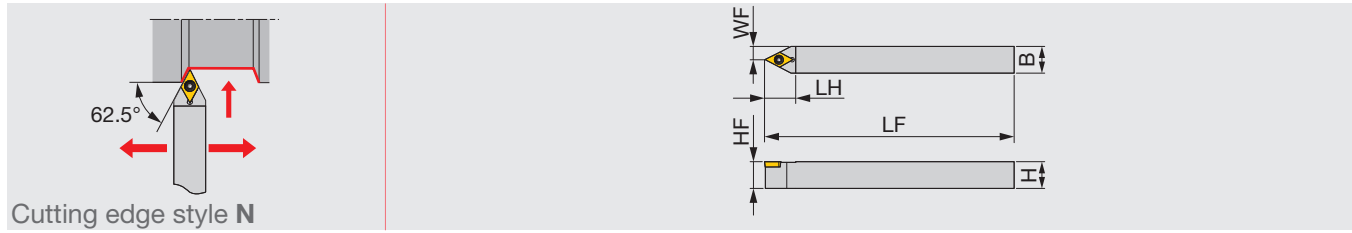

Inch	H	B	LF	LH	HF	WF	RE**	Insert	Torque
JSDNCN062	0.375	0.375	5.000	0.563	0.375	0.188	0.008	DC**0702...	0.89
JSDNCN082	0.500	0.500	5.000	0.563	0.500	0.250	0.008	DC**0702...	0.89
JSDNCN103	0.625	0.625	5.000	0.813	0.625	0.313	0.008	DC**11T3...	0.89

Metric	H	B	LF	LH	HF	WF	RE**	Insert	Torque*
JSDNCN1010X07	10	10	120	15	10	5	0.2	DC**0702...	1.2
JSDNCN1010X11	10	10	120	21	10	5	0.2	DC**11T3...	1.2
JSDNCN1212F07	12	12	85	15	12	6	0.2	DC**0702...	1.2
JSDNCN1212X07	12	12	120	15	12	6	0.2	DC**0702...	1.2
JSDNCN1212F11	12	12	85	21	12	6	0.2	DC**11T3...	1.2
JSDNCN1212X11	12	12	120	21	12	6	0.2	DC**11T3...	1.2
JSDNCN1616X11	16	16	120	21	16	8	0.2	DC**11T3...	1.2

Torque: Recommended clamping torque: lbs-ft (*N-m)
 **RE: Standard corner radius

SPARE PARTS

Designation	Clamping screw	Wrench
JSDNCN062/082, JSDNCN**07	CSTB-2.5	T-8F
JSDNCN103, JSDNCN**11	CSTB-4SD	T-8F

INSERT SELECTION

P

Application	Precision finishing	Finish cutting	Medium to finish cutting	Medium to finish cutting
Grade	SH725	SH725	AH725	SH725
Chipbreaker shape	01	JS	JS	J10
Cutting conditions	G069			

M

Application	Precision finishing	Finish cutting	Medium to finish cutting	Medium to finish cutting
Grade	SH725	SH725	AH725	SH725
Chipbreaker shape	01	JS	JS	J10
Cutting conditions	G069			

K

Application	Medium to finish cutting
Grade	T515
Chipbreaker shape	CM
Cutting conditions	B024

N

Application	Precision finishing	Finish cutting	Medium cutting
Grade	DX120	DX140	KS05F
Chipbreaker shape	T-DIA	with rake T-DIA	AL
Cutting conditions	B026		

S

Application	Finish cutting	Medium to finish cutting
Grade	SH725	AH725
Chipbreaker shape	JS	JS
Cutting conditions	G069	

H

Application	Precision finishing	Finish cutting
Grade	BXM10	BXM10
Chipbreaker shape	T-CBN	T-CBN
Cutting conditions	B030	

Reference pages: JSDNCN: Inserts → **B121 -**, CBN → **B184 -**, PCD → **B196 -**



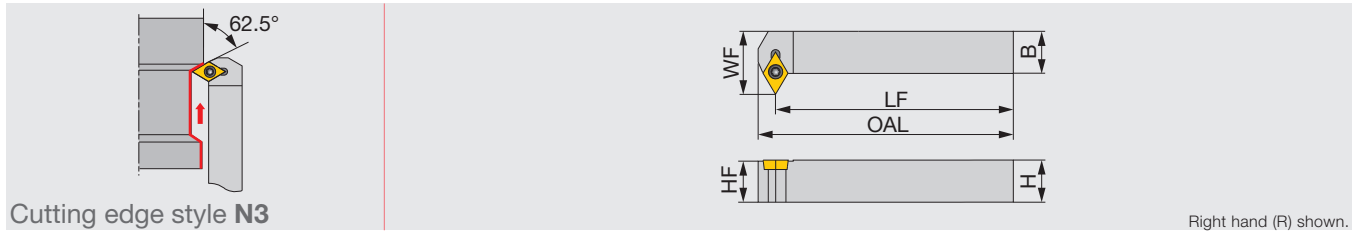

Cutting edge style N3

Right hand (R) shown.

Metric	H	B	OAL	LF	HF	WF	RE**	Insert	Torque
JSDN3CR1212H07	12	12	105	100	12	18	0.4	DC**0702...	1.2
JSDN3CR1616H11	16	16	107	100	16	25	0.8	DC**11T3...	1.2

Torque: Recommended clamping torque: N·m

**RE: Standard corner radius

SPARE PARTS

Designation	Clamping screw	Wrench
JSDN3CR1212H07	CSTB-2.5	T-8F
JSDN3CR1616H11	CSTB-4SD	T-8F



INSERT SELECTION

Application	Precision finishing	Finish cutting	Medium to finish cutting	Medium to finish cutting
	SH725	SH725	AH725	SH725
Grade	01	JS	JS	J10
Chipbreaker shape				
Cutting conditions	G069			

Application	Precision finishing	Finish cutting	Medium to finish cutting	Medium to finish cutting
	SH725	SH725	AH725	SH725
Grade	01	JS	JS	J10
Chipbreaker shape				
Cutting conditions	G069			

Application	Medium to finish cutting
	T515
Grade	CM
Chipbreaker shape	
Cutting conditions	B024

Application	Precision finishing	Finish cutting	Medium cutting
	DX120	DX140	KS05F
Grade	T-DIA	with rake T-DIA	AL
Chipbreaker shape			
Cutting conditions	B026		

Application	Finish cutting	Medium to finish cutting
	SH725	AH725
Grade	JS	JS
Chipbreaker shape		
Cutting conditions	G069	

Application	Precision finishing	Finish cutting
	BXM10	BXM10
Grade	T-CBN	T-CBN
Chipbreaker shape		
Cutting conditions	B030	

Reference pages: JSDN3CR/L: Inserts → B121 -, CBN → B184 -, PCD → B196 -

Screw-on toolholder with 72.5° approach angle, for positive 35° rhombic inserts

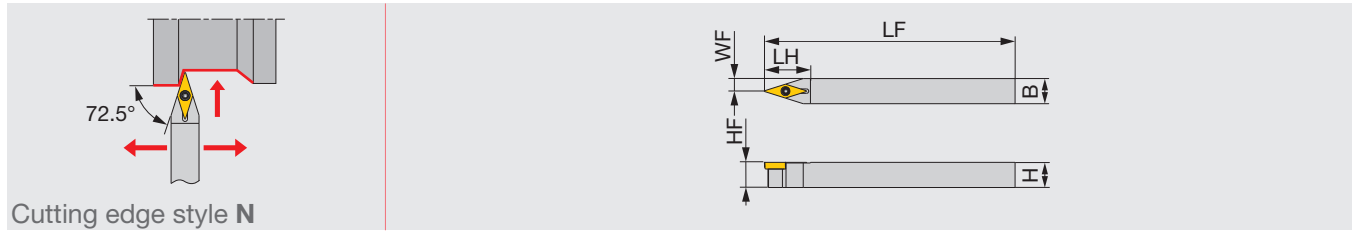

Metric	H	B	LF	LH	HF	WF	RE**	Insert	Torque
JSVNB1010X11	10	10	120	22	10	5	0.2	VB**1103...	1.2
JSVNB1212F11	12	12	85	22	12	6	0.2	VB**1103...	1.2
JSVNB1212X11	12	12	120	22	12	6	0.2	VB**1103...	1.2
JSVNB1616X11	16	16	120	22	16	8	0.2	VB**1103...	1.2

Torque: Recommended clamping torque: N·m
 **RE: Standard corner radius

SPARE PARTS

Designation	Clamping screw	Wrench
JSVNB...	CSTB-2.5	T-8F

INSERT SELECTION

Application areas	Finish cutting	Medium to finish cutting	Medium to finish cutting
	SH725	AH725	SH725
Grade	JS	JS	J10
Chipbreaker shape			
Cutting conditions	G069		

Application	Finish cutting	Medium to finish cutting	Medium to finish cutting
	SH725	AH725	SH725
Grade	JS	JS	J10
Chipbreaker shape			
Cutting conditions	G069		

Application	Medium to finish cutting
	T515
Grade	CM
Chipbreaker shape	
Cutting conditions	B024

Application	Finish cutting	Medium to finish cutting
	SH725	AH725
Grade	JS	JS
Chipbreaker shape		
Cutting conditions	G069	

Application	Precision finishing	Finish cutting
	BXM10	BXM10
Grade	T-CBN	T-CBN
Chipbreaker shape		
Cutting conditions	B030	

Reference pages: JSVNB: Inserts → B152 -, CBN → B191 -

Screw-on toolholder with 117.5° approach angle, for positive 35° rhombic inserts

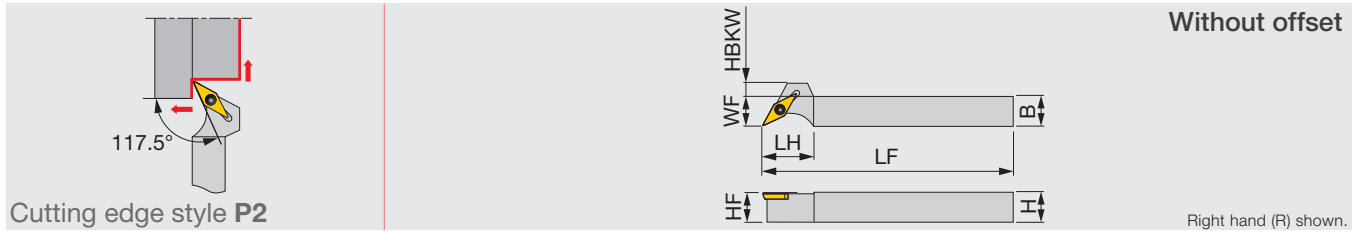

Metric	H	B	LF	LH	HF	WF	HBKW	RE**	Insert	Torque
JSVP2PR/L1010K08	10	10	125	16	10	10	4	0.2	VP**0802...	0.6
JSVP2PR/L1010K11	10	10	125	20	10	10	8	0.2	VP**1103...	1.2
JSVP2PR/L1212K08	12	12	125	16	12	12	2	0.2	VP**0802...	0.6
JSVP2PR/L1212K11	12	12	125	20	12	12	6	0.2	VP**1103...	1.2
JSVP2PR/L1616K08	16	16	125	16	16	16	2	0.2	VP**0802...	0.6
JSVP2PR/L1616K11	16	16	125	20	16	16	6	0.2	VP**1103...	1.2

Torque: Recommended clamping torque: N·m
 **RE: Standard corner radius

SPARE PARTS

Designation	Clamping screw	Wrench
JSVP2PR/L*08	CSTB-2L	T-6F
JSVP2PR/L*11	CSTB-2.5	T-8F

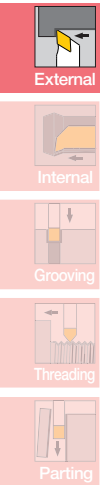

INSERT SELECTION

P	Application	Finish cutting	Finish cutting
	Grade	SH725	SH725
	JRP	JSP	
Chipbreaker shape			
Cutting conditions	G069		

M	Application	Finish cutting	Finish cutting
	Grade	SH725	SH725
	JRP	JSP	
Chipbreaker shape			
Cutting conditions	G069		

S	Application	Finish cutting	Finish cutting
	Grade	SH725	SH725
	JRP	JSP	
Chipbreaker shape			
Cutting conditions	G069		

Reference pages: JSVP2PR/L: Inserts → **B157 -**

Screw-on toolholder with 91° approach angle, for positive 60° triangular inserts

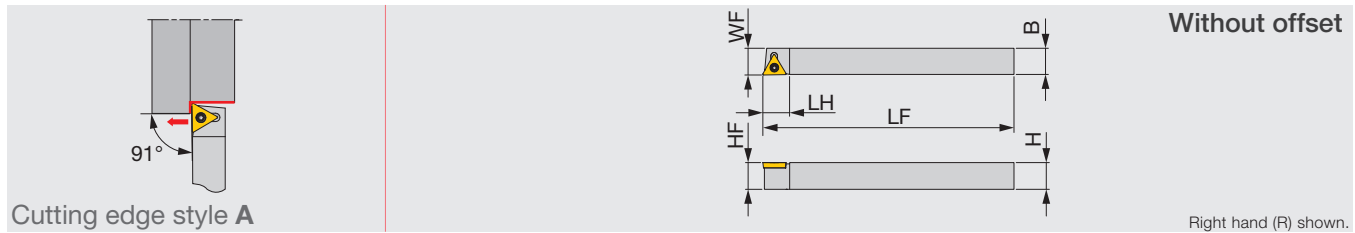

Metric	H	B	LF	LH	HF	WF	RE**	Insert	Torque
JSTACR/L0808K08	8	8	125	10	8	8	0.2	TC**0802...	0.6
JSTACR/L1010K08	10	10	125	10	10	10	0.2	TC**0802...	0.6
JSTACR/L1212K11	12	12	125	12	12	12	0.4	TC**1102...	1.2
JSTACR/L1616H11	16	16	100	12	16	16	0.4	TC**1102...	1.2

Torque: Recommended clamping torque: N·m **RE: Standard corner radius

SPARE PARTS

Designation	Clamping screw	Wrench
JSTACR/L**K08	CSTB-2L	T-6F
JSTACR/L**11	CSTB-2.5	T-8F

Back-clamp toolholder with 91° approach angle, for positive 60° triangular inserts

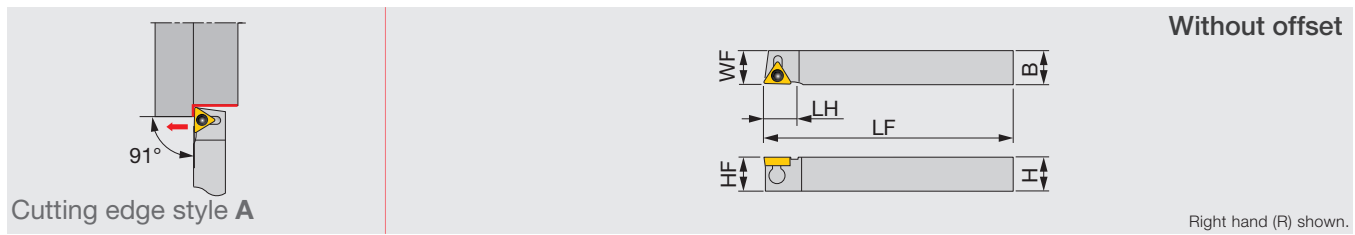

Metric	H	B	LF	LH	HF	WF	RE**	Insert	Torque
JTTACL0810K08	8	10	125	10	8	10	0.2	TC**0802...	0.9
JTTACR/L1212M11	12	12	150	12	12	12	0.4	TC**1102...	0.9
JTTACR/L1616M11	16	16	150	12	16	16	0.4	TC**1102...	0.9

Torque: Recommended clamping torque: N·m **RE: Standard corner radius

SPARE PARTS

Designation	Clamp	Clamping screw	Wrench
JTTACL0810K08	JCP-1	JDS-3525	P-2F
JTTACR/L**M11	JCP-2	JDS-3525	P-2F

INSERT SELECTION

P	Application	Precision finishing	Finish cutting	Medium to finish cutting	Medium to finish cutting
	Grade	SH725	SH725	AH725	SH725
Chipbreaker shape	01	JS	JS	J10	
Cutting conditions	G069				

K	Application	Medium to finish cutting
	Grade	T515
Chipbreaker shape	CM	
Cutting conditions	B024	

M	Application	Precision finishing	Finish cutting	Medium to finish cutting	Medium to finish cutting
	Grade	SH725	SH725	AH725	SH725
Chipbreaker shape	01	JS	JS	J10	
Cutting conditions	G069				

N	Application	Precision finishing	Medium cutting
	Grade	DX120	KS05F
Chipbreaker shape	T-DIA	with rake AL	
Cutting conditions	B026		

Reference pages: JSTACR/L, JTTACR/L: Inserts → B139 -, PCD → B196

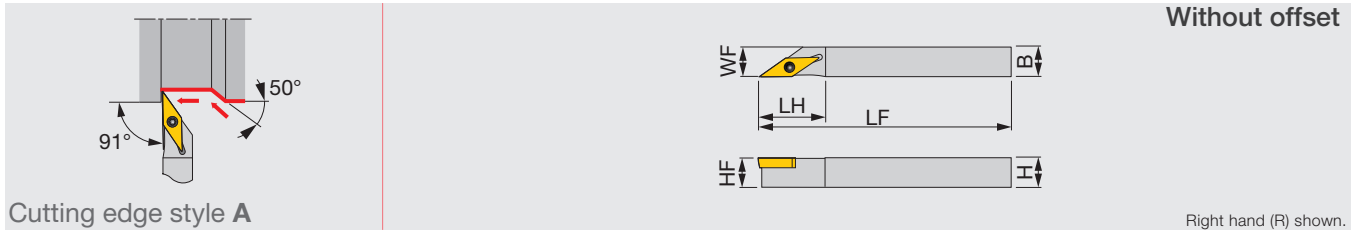

Metric	H	B	LF	LH	HF	WF	RE**	Insert	Torque
JSVABR/L1010K11	10	10	125	21	10	10	0.2	VB**1103...	1.2
JSVABL1212K11	12	12	125	21	12	12	0.2	VB**1103...	1.2

Torque: Recommended clamping torque: N·m

**RE: Standard corner radius

SPARE PARTS

Designation	Clamping screw	Wrench
JSVABR/L...	CSTB-2.5	T-8F

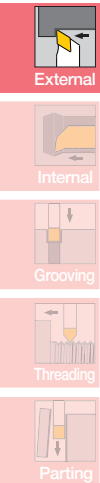

INSERT SELECTION

Application	Finish cutting	Medium to finish cutting	Medium to finish cutting
	Grade	SH725	AH725
Chipbreaker shape	JS	JS	J10
Cutting conditions	G069		

Application	Finish cutting	Medium to finish cutting	Medium to finish cutting
	Grade	SH725	AH725
Chipbreaker shape	JS	JS	J10
Cutting conditions	G069		

Application	Medium to finish cutting
	Grade
Chipbreaker shape	CM
Cutting conditions	B024

Application	Finish cutting	Medium to finish cutting
	Grade	SH725
Chipbreaker shape	JS	JS
Cutting conditions	G069	

Application	Precision finishing	Finish cutting
	Grade	BXM10
Chipbreaker shape	T-CBN	T-CBN
Cutting conditions	B030	

Reference pages: JSVABR/L: Inserts → B152 -, CBN → B191 -

Screw-on toolholder with 91° approach angle, for positive 80° rhombic inserts

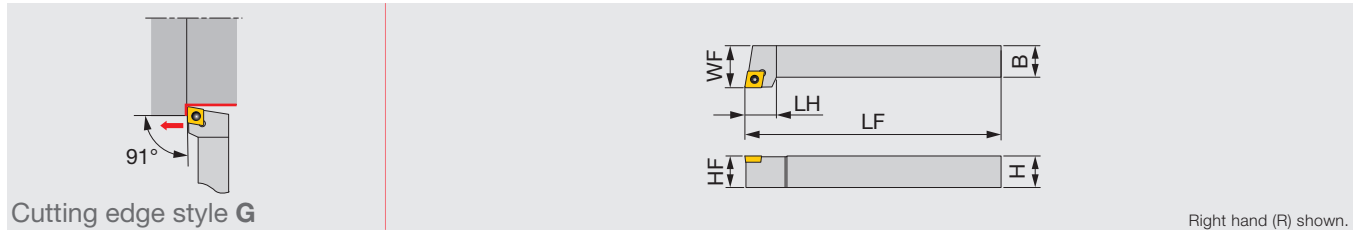

Cutting edge style G

Right hand (R) shown.

Metric	H	B	LF	LH	HF	WF	RE**	Insert	Torque
JSCGCR/L1212H06	12	12	100	12	12	16	0.4	CC**0602...	1.2
JSCGCR/L1616H09	16	16	100	16	16	20	0.8	CC**09T3...	1.2

Torque: Recommended clamping torque: N·m

**RE: Standard corner radius

SPARE PARTS

Designation	Clamping screw	Wrench
JSCGCR/L1212H06	CSTB-2.5	T-8F
JSCGCR/L1616H09	CSTB-4SD	T-8F

INSERT SELECTION

Application	Precision finishing	Finish cutting	Medium to finish cutting	Medium to finish cutting
	SH725	SH725	AH725	SH725
Grade	01	JS	JS	J10
Chipbreaker shape				
Cutting conditions	G069			

Application	Precision finishing	Finish cutting	Medium to finish cutting	Medium to finish cutting
	SH725	SH725	AH725	SH725
Grade	01	JS	JS	J10
Chipbreaker shape				
Cutting conditions	G069			

Application	Medium to finish cutting
	T515
Grade	CM
Chipbreaker shape	
Cutting conditions	B024

Application	Precision finishing	Finish cutting	Medium cutting
	DX120	TH10	KS05F
Grade	T-DIA	with rake W20	AL
Chipbreaker shape			
Cutting conditions	B026		

Application	Finish cutting	Medium to finish cutting
	SH725	AH725
Grade	JS	JS
Chipbreaker shape		
Cutting conditions	G069	

Application	Precision finishing	Finish cutting
	BXM10	BXM20
Grade	T-CBN	T-CBN
Chipbreaker shape		
Cutting conditions	B030	

Reference pages: JSCGCR/L: Inserts → B111 -, CBN → B182, PCD → B196 -



Screw-on toolholder with 45° approach angle, for positive square inserts

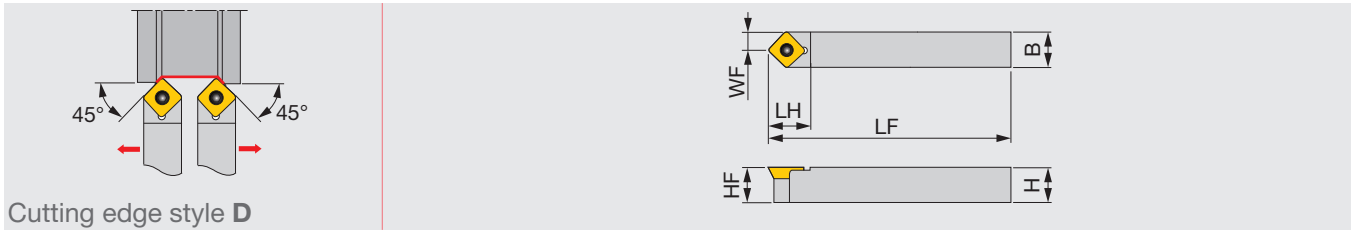

Cutting edge style **D**





Metric	H	B	LF	LH	HF	WF	RE**	Insert
SSDCN1010K07	10	10	125	12	10	5	0.4	SC**0702...
SSDPN1010H	10	10	100	12	10	5	0.4	SP*P042...
SSDCN1212K09	12	12	125	15	12	6	0.8	SC**09T3...
SSDPN1212H	12	12	100	12	12	6	0.4	SP*P042...
SSDCN1616H09	16	16	100	15	16	8	0.8	SC**09T3...
SSDPN1616H	16	16	100	14	16	8	0.8	SP*M322...

**RE: Standard corner radius

SPARE PARTS

Designation	Clamping screw	Shim screw	Shim	Wrench 1	Wrench 2
SSDCN1010K07	CSTB-3	-	-	-	T-9F
SSDPN1010H	CSTA-NO3	-	-	-	T-9F
SSDCN1212K09	CSTB-4	-	-	-	T-15F
SSDPN1212H	CSTA-NO3	-	-	-	T-9F
SSDCN1616H09	CSTB-3.5L	DTS5-3.5	SSS32	P-3.5	T-15F
SSDPN1616H	CSTA-NO5	-	-	-	T-9F

INSERT SELECTION

P	Application	Medium to finish cutting	Medium cutting	M	Application	Medium cutting
	Grade	AH725	AH725		Grade	AH725
	Chipbreaker shape	PS 	PM 		Chipbreaker shape	PM 
Cutting conditions		B020		Cutting conditions		B022
K	Application	Medium to finish cutting				
	Grade	T515				
	Chipbreaker shape	CM 				
Cutting conditions		B024				

Reference pages: SSDC/PN: Inserts → **B135** -

Screw-on toolholder for facing with 91° approach angle, for positive 55° rhombic inserts

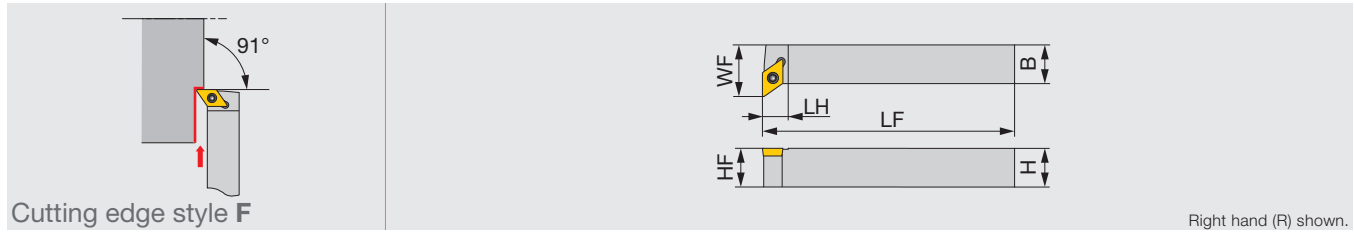

Metric	H	B	LF	LH	HF	WF	RE**	Insert	Torque
JSDFCR/L1212H07	12	12	100	8	12	16	0.4	DC**0702...	1.2
JSDFCR/L1616H11	16	16	100	10.5	16	22	0.8	DC**11T3...	1.2

Torque: Recommended clamping torque: N·m
 **RE: Standard corner radius

SPARE PARTS

Designation	Clamping screw	Wrench
JSDFCR/L1212H07	CSTB-2.5	T-8F
JSDFCR/L1616H11	CSTB-4SD	T-8F

INSERT SELECTION

Application	Precision finishing	Finish cutting	Medium to finish cutting	Medium to finish cutting
	SH725	SH725	AH725	SH725
Grade	01	JS	JS	J10
Chipbreaker shape				
Cutting conditions	G069			

Application	Precision finishing	Finish cutting	Medium to finish cutting	Medium to finish cutting
	SH725	SH725	AH725	SH725
Grade	01	JS	JS	J10
Chipbreaker shape				
Cutting conditions	G069			

Application	Medium to finish cutting
	T515
Grade	CM
Chipbreaker shape	
Cutting conditions	B024

Application	Precision finishing	Finish cutting	Medium cutting
	DX120	DX140	KS05F
Grade	T-DIA	with rake T-DIA	AL
Chipbreaker shape			
Cutting conditions	B026		

Application	Finish cutting	Medium to finish cutting
	SH725	AH725
Grade	JS	JS
Chipbreaker shape		
Cutting conditions	G069	

Application	Precision finishing	Finish cutting
	BXM10	BXM10
Grade	T-CBN	T-CBN
Chipbreaker shape		
Cutting conditions	B030	

Reference pages: JSDFCR/L: Inserts → B121 -, CBN → B184 -, PCD → B196 -

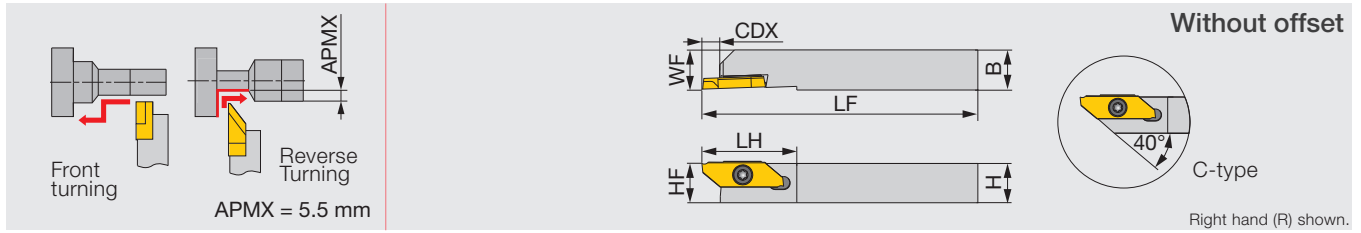

Metric	H	B	LF	LH	CDX	HF	WF	Insert
JSXGR/L1010K8-C	10	10	125	29	6.7	10	10	JXFR/L8..., JXRR/L8...
JSXGR/L1212K8-C	12	12	125	29	6.7	12	12	JXFR/L8..., JXRR/L8...
JSXGR/L1616K8	16	16	125	29	6.5	16	16	JXFR/L8..., JXRR/L8...
JSXGR/L2020K8	20	20	125	29	6.5	20	20	JXFR/L8..., JXRR/L8...
JSXGR/L2525K8	25	25	125	29	6.5	25	25	JXFR/L8..., JXRR/L8...

Can be used with JXG insert for parting and grooving.
Can be wrenched also from the back with a double-head screw.

SPARE PARTS

Designation	Clamping screw	Wrench 1	Wrench 2 *Optional
JSXGR/L...	CSTB-4SD	T-8F	(T-8L)

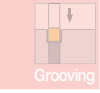
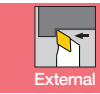

PCL2NR

Lever-lock toolholder with 95° approach angle, for negative 80° rhombic inserts

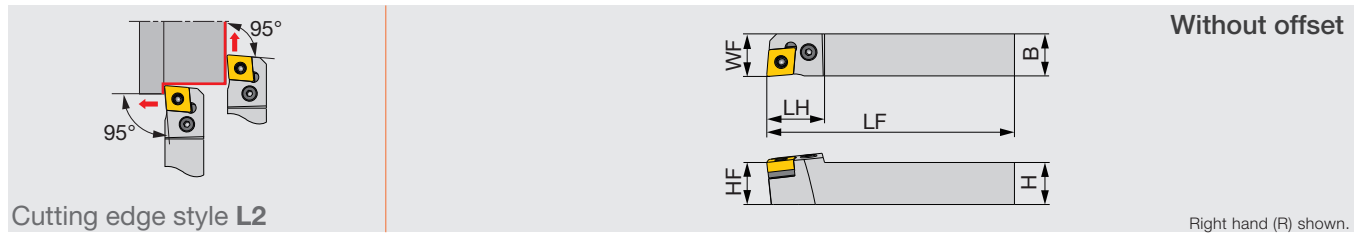

Metric	H	B	LF	LH	HF	WF	RE**	Insert	Torque
PCL2NR2020H12	20	20	100	26	20	20	0.8	CN/GN**1204...	3

Torque: Recommended clamping torque: N·m
 **RE: Standard corner radius

SPARE PARTS

Designation	Shim	Clamping screw	Lever	Spring pin	Wrench
PCL2NR2020H12	LSC42	LCS4	LCL4	LSP4	P-3

PCLNR

Lever-lock toolholder with 95° approach angle, for negative 80° rhombic inserts

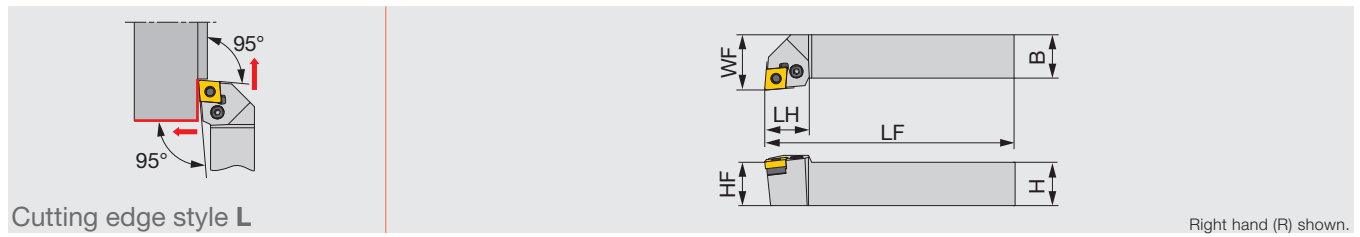

Metric	H	B	LF	LH	HF	WF	RE**	Insert	Torque
PCLNR2020H12	20	20	100	26	20	25	0.8	CN/GN**1204...	3

Torque: Recommended clamping torque: N·m
 **RE: Standard corner radius

SPARE PARTS

Designation	Shim	Clamping screw	Lever	Spring pin	Wrench
PCLNR2020H12	LSC42	LCS4	LCL4	LSP4	P-3

INSERT SELECTION

P	Application	Precision finishing	Finish cutting	Medium cutting	Medium to heavy cutting
	Grade	NS9530	GT9530	T9215	T9215
	Chipbreaker shape	TF	TSF	TM	TH
	Cutting conditions	B008			
M	Application	Finish cutting	Medium cutting	Medium to heavy cutting	
	Grade	T6120	T6130	T6130	
	Chipbreaker shape	SF	SM	SH	
	Cutting conditions	B010			
K	Application	Finish cutting	Medium cutting	Medium to heavy cutting	
	Grade	T515	T515	T515	
	Chipbreaker shape	All-round	All-round	All-round	
	Cutting conditions	B012			
N	Application	Finish cutting	Medium cutting		
	Grade	DX140	TH10		
	Chipbreaker shape	T-DIA	P		
	Cutting conditions	B014			
S	Application	Precision finishing	Finish cutting	Medium cutting	
	Grade	BX950	AH8005	AH8005	
	Chipbreaker shape	T-CBN	HRF	HRM	
	Cutting conditions	B016			

Reference pages: PCL2NR, PCLNR: Inserts → B056 -, CBN → B172 -, PCD → B194 -



Back-clamp toolholder with 95° approach angle, for negative 60° triangular inserts

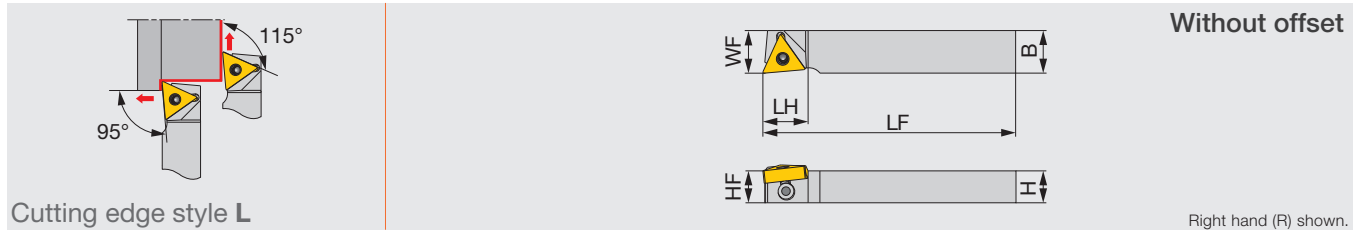

Metric	H	B	LF	LH	HF	WF	RE**	Insert	Torque
JTTLNR/L1216F16	12	16	85	17	12	16	0.4	TN**1604...	1
JTTLNR/L1216X16	12	16	120	17	12	16	0.4	TN**1604...	1
JTTLNR/L1616X16	16	16	120	17	16	16	0.4	TN**1604...	1

Torque: Recommended clamping torque: N·m **RE: Standard corner radius

SPARE PARTS

Designation	Clamp	Clamping screw	Wrench
JTTLNR/L...	JCP-3N	JDS-5040	P-2.5F

PTL2NR/L

Lever-lock toolholder with 95° approach angle, for negative 60° triangular inserts

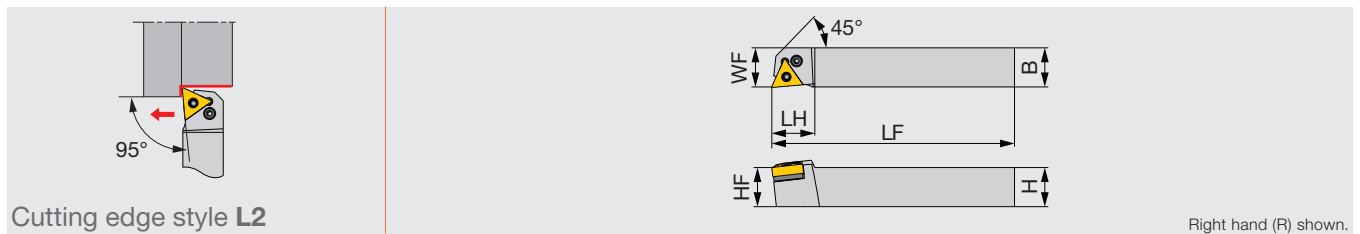

Metric	H	B	LF	LH	HF	WF	RE**	Insert	Torque
PTL2NR/L2020H16	20	20	100	22	20	20	0.4	TN**1604...	2

Torque: Recommended clamping torque: N·m **RE: Standard corner radius

SPARE PARTS

Designation	Shim	Clamping screw	Wrench	Spring pin	Lever
PTL2NR/L...	LST317 D30	LCS3	P-2.5	LSP3	LCL3

INSERT SELECTION

P	Application	Precision finishing	Finish cutting		Medium cutting	Medium to heavy cutting
	Grade	SH725	SH725	GT9530	T9215	T9215
	Chipbreaker shape	01	JRP	TSF	TM	TH
Cutting conditions		G069			B008	
K	Application	Finish cutting	Medium cutting	Medium to heavy cutting		
	Grade	T515	T515	T515		
	Chipbreaker shape	All-round	All-round	All-round		
Cutting conditions		B012				
S	Application	Precision finishing	Finish cutting	Medium cutting		
	Grade	BX950	AH8005	AH8005		
	Chipbreaker shape	T-CBN	HRF	HRM		
Cutting conditions		B016				
M	Application	Precision finishing	Finish cutting	Medium cutting		
	Grade	SH725	SH725	T6130		
	Chipbreaker shape	01	JRP	SM		
Cutting conditions		G069		B010		
N	Application	Precision finishing	Finish cutting	Medium cutting		
	Grade	DX120	DX140	TH10		
	Chipbreaker shape	T-DIA	with rake T-DIA	P		
Cutting conditions		B014				
H	Application	Precision finishing	Finish cutting			
	Grade	BXM10	BXM10			
	Chipbreaker shape	T-CBN	T-CBN			
Cutting conditions		B018				

Reference pages: JTTLNR/L, PTL2NR/L: Inserts → **B086 -**, CBN → **B178 -**, PCD → **B194 -**

PDJNR

Lever-lock toolholder with 93° approach angle, for negative 55° rhombic inserts

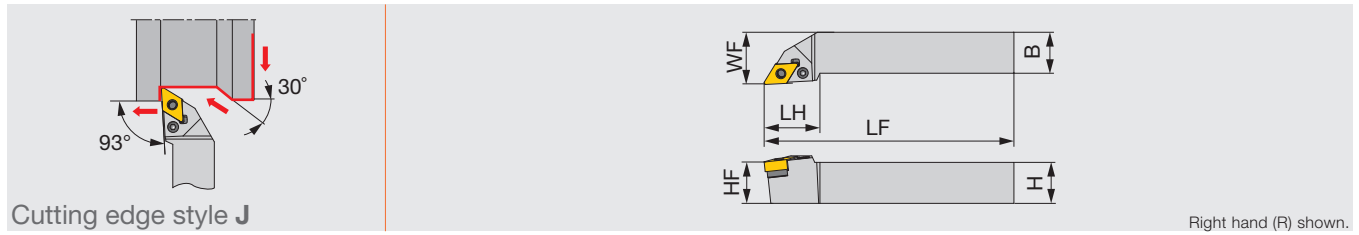

Metric	H	B	LF	LH	HF	WF	RE**	Insert	Torque
PDJNR2020H15	20	20	100	32	20	25	0.8	DN**1504...	3

Torque: Recommended clamping torque: N·m
 **RE: Standard corner radius

SPARE PARTS					
Designation	Shim	Clamping screw	Lever	Spring pin	Wrench
PDJNR2020H15	LSD42	LCS4	LCL4	LSP4	P-3

INSERT SELECTION

Application	Precision finishing	Finish cutting	Medium cutting	Medium to heavy cutting
	Grade	NS9530	GT9530	T9215
Chipbreaker shape	TF	TSF	TM	TH
Images				
Cutting conditions	B008			

Application	Finish cutting	Medium cutting	Medium to heavy cutting
	Grade	T6120	T6130
Chipbreaker shape	SF	SM	SH
Images			
Cutting conditions	B010		

Application	Finish cutting	Medium cutting	Medium to heavy cutting
	Grade	T515	T515
Chipbreaker shape	All-round	All-round	All-round
Images			
Cutting conditions	B012		

Application	Precision finishing	Finish cutting	Medium cutting
	Grade	DX120	DX140
Chipbreaker shape	T-DIA	with rake T-DIA	P
Images			
Cutting conditions	B014		

Application	Precision finishing	Finish cutting	Medium cutting
	Grade	BX950	AH8005
Chipbreaker shape	T-CBN	HRF	HRM
Images			
Cutting conditions	B016		

Application	Precision finishing	Finish cutting
	Grade	BXM10
Chipbreaker shape	T-CBN	T-CBN
Images		
Cutting conditions	B018	

Reference pages: PDJNR: Inserts → B067 -, CBN → B174 -, PCD → B194 -

Grade
Insert
Toolholder
Ext. Toolholder
Int. Toolholder
Threading
Grooving
Miniature Tool
Milling Cutter
Endmill
Drilling Tool
Tooling System
User's Guide
Index



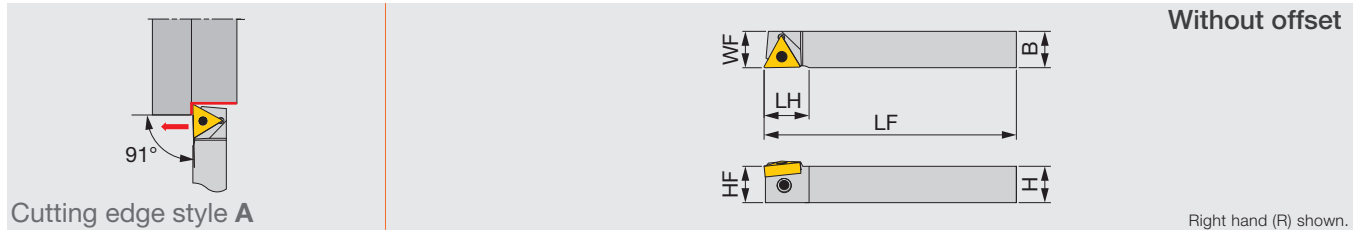

Metric	H	B	LF	LH	HF	WF	RE**	Insert	Torque
JTTANR/L1216K16	12	16	125	19.8	12	16	0.4	TN**1604...	1.2
JTTANR/L1616K16	16	16	125	19.8	16	16	0.4	TN**1604...	1.2

Torque: Recommended clamping torque: N·m
 **RE: Standard corner radius

SPARE PARTS

Designation	Clamp	Clamping screw	Wrench
JTTANR/L...	JCP-3N	JDS-5040	P-2.5F

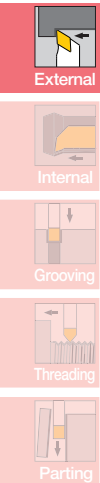

INSERT SELECTION

Application	Precision finishing	Finish cutting		Medium cutting	Medium to heavy cutting
	Grade	SH725	SH725	GT9530	T9215
Chipbreaker shape	01	JRP	TSF	TM	TH
Cutting conditions	G069			B008	

Application	Precision finishing	Finish cutting	Medium cutting
	Grade	SH725	SH725
Chipbreaker shape	01	JRP	SM
Cutting conditions	G069		B010

Application	Finish cutting	Medium cutting	Medium to heavy cutting
	Grade	T515	T515
Chipbreaker shape	All-round	All-round	All-round
Cutting conditions	B012		

Application	Precision finishing	Finish cutting	Medium cutting
	Grade	DX120	DX140
Chipbreaker shape	T-DIA	with rake T-DIA	P
Cutting conditions	B014		

Application	Precision finishing	Finish cutting	Medium cutting
	Grade	BX950	AH8005
Chipbreaker shape	T-CBN	HRF	HRM
Cutting conditions	B016		

Application	Precision finishing	Finish cutting
	Grade	BXM10
Chipbreaker shape	T-CBN	T-CBN
Cutting conditions	B018	

Reference pages: JTTANR/L: Inserts → B086 -, CBN → B178 -, PCD → B194 -

J-SERIES

JSTBR/L

Screw-on toolholder for back turning

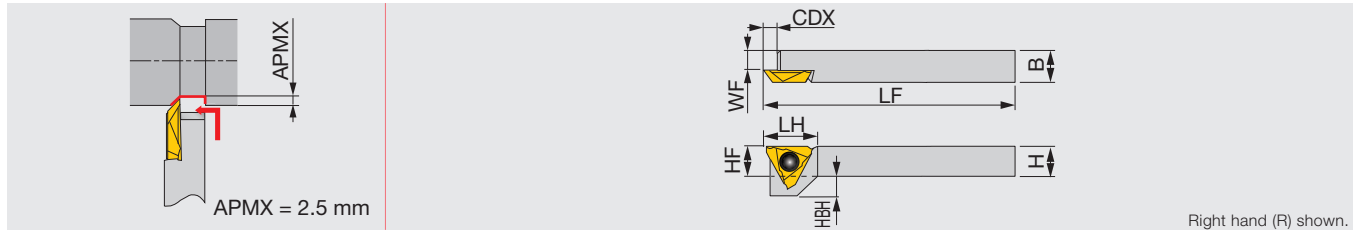

Right hand (R) shown.

Inch	H	B	LF	LH	CDX	HF	WF	HBH	Insert	Torque
JSTBR/L063	0.375	0.375	5.000	0.625	0.197	0.375	0.219	0.250	JTBR/L3...	0.89
JSTBR/L083	0.500	0.500	5.000	0.625	0.197	0.500	0.313	0.125	JTBR/L3...	0.89
JSTBR/L103	0.625	0.625	5.000	0.625	0.197	0.625	0.469	-	JTBR/L3...	0.89

Metric	H	B	LF	LH	CDX	HF	WF	HBH	Insert	Torque*
JSTBR/L1010X3	10	10	120	15	5	10	6	5	JTBR/L3...	1.2
JSTBL1010K3	10	10	125	15	5	10	6	5	JTBR/L3...	1.2
JSTBR/L1212F3	12	12	85	15	5	12	8	3	JTBR/L3...	1.2
JSTBR/L1212X3	12	12	120	15	5	12	8	3	JTBR/L3...	1.2
JSTBR/L1616X3	16	16	120	15	5	16	12	-	JTBR/L3...	1.2

Torque: Recommended clamping torque: lbs-ft (*N-m)

SPARE PARTS

Designation	Clamping screw	Wrench
JSTBR/L...	CSTB-4SD	T-8F

J-SERIES

JS-TBL3

Screw-on toolholder for back turning

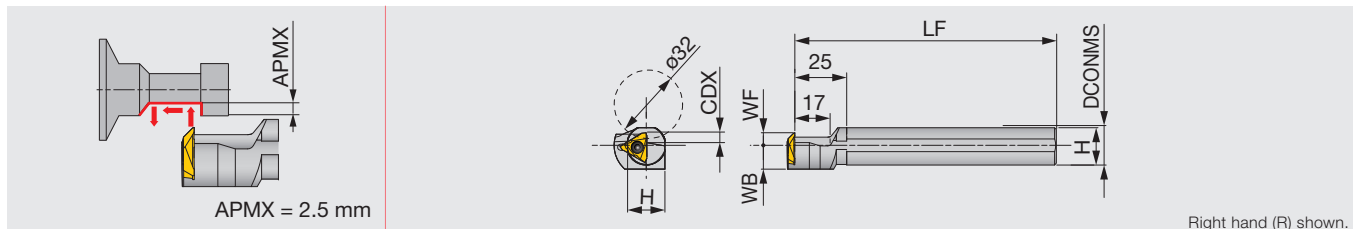

Right hand (R) shown.

Metric	DCONMS	H	LF	CDX	WF	WB	Insert	Torque
JS19K-TBL3	19.05	18	125	4.5	6	11.5	JTBR3...	3
JS20K-TBL3	20	19	125	4.5	6	11.5	JTBR3...	3
JS22K-TBL3	22	21	125	4.5	6	11.5	JTBR3...	3
JS25K-TBL3	25.4	24	125	4.5	10	12.7	JTBR3...	3

Torque: Recommended clamping torque: N-m

SPARE PARTS

Designation	Clamping screw	Wrench
JS**-TBL3	CSTB-4S	T-15F

Reference pages: JSTBR/L, JS-TBL3: Inserts, Standard cutting conditions → [G062](#)

INSERT

JTB (Sharp edge)

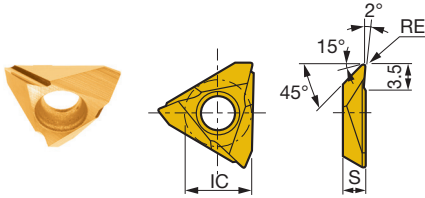

Right hand (R) shown.

P	Steel	★	☆		★						
M	Stainless	★	☆								
K	Cast iron	★			☆		☆				
N	Non-ferrous							★			
S	Superalloys	☆	☆					★			
H	Hard materials							★			

★ : First choice
☆ : Second choice

Designation	HAND	RE (in)	Coated		Cermet	Uncoated	IC (mm)	S (mm)	Max. depth of cut (mm)
			SH725	J740	NS9530	TH10			
JTBR3000F	R	0.0012	●	●		●	9.438	3.18	2.5
JTBL3000F	L	0.0012	●	●		●	9.438	3.18	2.5
JTBR3005F	R	0.002	●	●		●	9.438	3.18	2.5
JTBL3005F	L	0.002	●	●		●	9.438	3.18	2.5
JTBR3010F	R	0.004	●	●	●	●	9.438	3.18	2.5
JTBL3010F	L	0.004	●	●	●	●	9.438	3.18	2.5
JTBR3015F	R	0.006	●	●			9.438	3.18	2.5
JTBL3015F	L	0.006	●				9.438	3.18	2.5

● : Line up

JTBR/L (Honed edge)

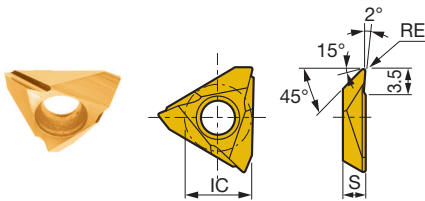

Right hand (R) shown.

P	Steel	★		★					
M	Stainless	★							
K	Cast iron	★		☆					
N	Non-ferrous								
S	Superalloys	☆							
H	Hard materials								

★ : First choice
☆ : Second choice

Designation	HAND	RE (in)	Coated	Coated cermet	IC (mm)	S (mm)	Max. depth of cut (mm)
			J740	J9530			
JTBR3000	R	0.002	●	●	9.438	3.18	2.5
JTBL3000	L	0.002	●		9.438	3.18	2.5
JTBR3005	R	0.004	●	●	9.438	3.18	2.5
JTBL3005	L	0.004	●		9.438	3.18	2.5

● : Line up

Reference pages: Toolholders → **G061**

STANDARD CUTTING CONDITIONS

ISO	Workpiece material	Grade	Cutting speed Vc (sfm)	Feed f (ipr)
P	Steel 1045, etc.	SH725	164 - 656	0.0004 - 0.004
		J740	33 - 328	0.0004 - 0.004
		NS9530	164 - 492	0.0004 - 0.004
		J9530	164 - 492	0.0004 - 0.004
	Free-cutting steel	SH725	164 - 656	0.0004 - 0.004
		J740	33 - 328	0.0004 - 0.004
M	Stainless steel 303, etc.	SH725	164 - 656	0.0004 - 0.004
		J740	33 - 328	0.0004 - 0.004
		NS9530	164 - 492	0.0004 - 0.004
		J9530	164 - 492	0.0004 - 0.004
N	Aluminum alloys, Brass Si < 12%, 5056, 6061, etc.	TH10	33 - 656	0.0004 - 0.004
S	Difficult-to-machine material, Titanium alloys Ti-6Al-4V, etc.	TH10	33 - 98	0.0004 - 0.004

Grade
Insert
Ext. Toolholder
Int. Toolholder
Threading
Grooving
Miniature Tool
Milling Cutter
Endmill
Drilling Tool
Tooling System
User's Guide
Index



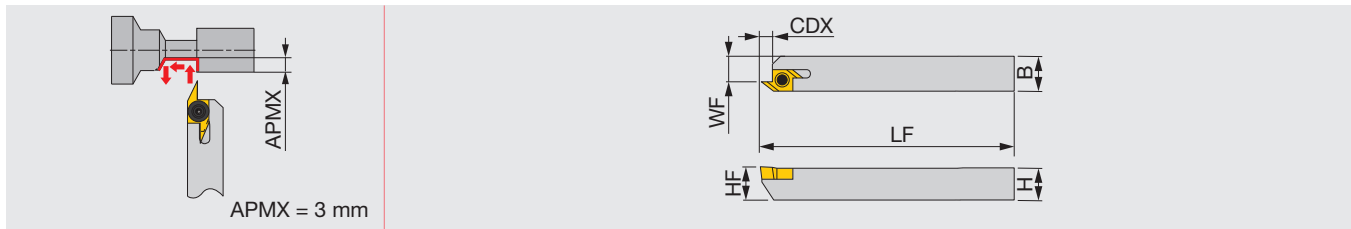

Metric	H	B	LF	CDX	HF	WF	Insert	Torque
JSEGR/L1010K10	10	10	125	3.3	10	7.5	J10ER/L...	1.2
JSEGR/L1212K10	12	12	125	3.3	12	9.5	J10ER/L...	1.2
JSEGR/L1616K10	16	16	125	3.3	16	13.5	J10ER/L...	1.2

Torque: Recommended clamping torque: N·m

SPARE PARTS



Designation	Clamping screw	Wrench
JSEGR/L...	CSTB-2.5	T-8F

STANDARD CUTTING CONDITIONS (J10E type insert)

ISO	Workpiece material	Grade	Cutting speed Vc (sfm)	Feed f (ipr)
P	Steel 1045, etc.	SH725	164 - 656	0.0004 - 0.004
		J740	33 - 328	0.0004 - 0.004
		NS9530	164 - 492	0.0004 - 0.004
		J9530	164 - 492	0.0004 - 0.004
	Free-cutting steel	SH725	164 - 656	0.0004 - 0.004
		J740	33 - 328	0.0004 - 0.004
M	Stainless steel 303, etc.	SH725	164 - 656	0.0004 - 0.004
		J740	33 - 328	0.0004 - 0.004
		NS9530	164 - 492	0.0004 - 0.004
		J9530	164 - 492	0.0004 - 0.004
N	Aluminum alloys, Brass Si < 12%, 5056, 6061, etc.	TH10	33 - 656	0.0004 - 0.004
S	Difficult-to-machine material, Titanium alloys Ti-6Al-4V, etc.	TH10	33 - 98	0.0004 - 0.004

INSERT

J10E (Sharp edge)

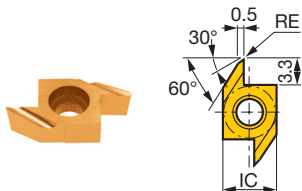

Right hand (R) shown.

P	Steel	★	☆		★						
M	Stainless	★	☆								
K	Cast iron	★			☆		☆				
N	Non-ferrous							★			
S	Superalloys	☆						★			
H	Hard materials							★			

★ : First choice
☆ : Second choice

Designation	HAND	RE (mm)	Coated		Cermet	Uncoated		IC (mm)	S (mm)	Max. depth of cut (mm)
			SH725	J740	NS9530	TH10				
J10ER/L005BF	R	0.05	●	●				6.35	3.18	3
J10ER/L005BF	L	0.05	●	●				6.35	3.18	3
J10ER/L010BF	R	0.1	●	●				6.35	3.18	3
J10ER/L010BF	L	0.1	●	●				6.35	3.18	3
J10ER/L015BF	R	0.15	●		●			6.35	3.18	3
J10ER/L015BF	L	0.15	●		●			6.35	3.18	3

● : Line up

J10E (Honed edge)

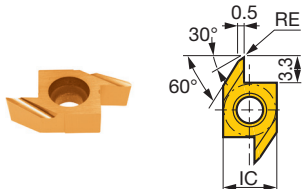

Right hand (R) shown.

P	Steel	★		★						
M	Stainless	★								
K	Cast iron	★		☆						
N	Non-ferrous									
S	Superalloys	☆								
H	Hard materials									

★ : First choice
☆ : Second choice

Designation	HAND	RE (mm)	Coated	Coated cermet	IC (mm)	S (mm)	Max. depth of cut (mm)
			J740	J9530			
J10ER005B	R	0.05	●	●	6.35	3.18	3
J10EL005B	L	0.05	●		6.35	3.18	3
J10ER010B	R	0.1	●	●	6.35	3.18	3
J10EL010B	L	0.1	●		6.35	3.18	3

● : Line up



INSERT

10E (Insert blank)

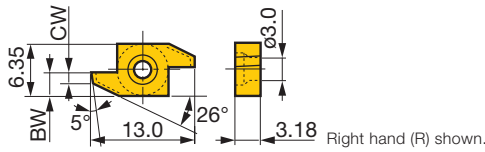

Right hand (R) shown.

Designation	HAND	Uncoated		
		TH10		
10ER100B	R	●		
10EL100B	L	●		
10ER150B	R	●		
10EL150B	L	●		

● : Line up

Note: Right hand holder (JSEGR...) use right hand insert (10ER...) and left hand holder (JSEGL...) use left hand insert (10EL...)

10E (Insert blank)

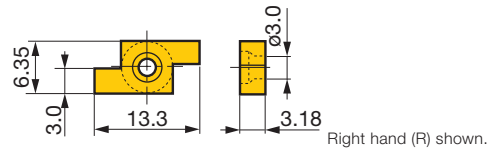

Right hand (R) shown.

Designation	HAND	Uncoated		
		TH10		
10ER300	R	●		
10EL300	L	●		

● : Line up

Note: Right hand holder (JSEGR...) use right hand insert (10ER...) and left hand holder (JSEGL...) use left hand insert (10EL...)

Formed examples of insert blanks

Front turning

Back turning

Threading

Grooving

Parting-off

Notes:

- Front relief angle, side relief angle, edge width can be ground depending on the application.
- Insert blanks can be formed to a profiling tool which has a width up to 0.118".

Standard cutting conditions

Operations		Workpiece material			
		Carbon steel	Stainless steel	Brass	
Lateral feed (external turning)	Cutting speed (sfm)	~ 330	~ 160	~ 650	
	Feed (ipr)	Roughing	~ 0.002	~ 0.001	~ 0.004
		Medium	~ 0.001	~ 0.001	~ 0.002
		Finishing	~ 0.0007	~ 0.0006	~ 0.0016
Parting-off Grooving Forming	Cutting speed (sfm)	~ 260	~ 100	~ 500	
	Feed (ipr)	Roughing	~ 0.0007	~ 0.0006	~ 0.002
		Medium	~ 0.0006	~ 0.0004	~ 0.001
		Finishing	~ 0.0004	~ 0.0003	~ 0.0006

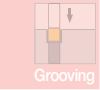
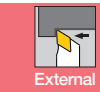

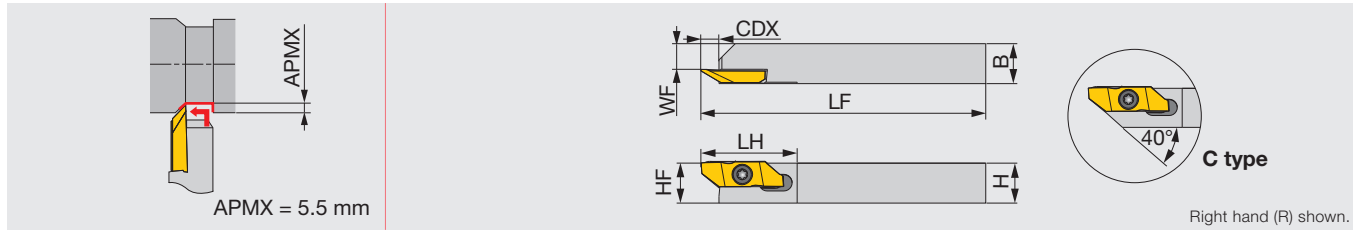

Metric	H	B	LF	LH	CDX	HF	WF	Insert
JSXBR/L1010K8-C	10	10	125	29	6.7	10	5.7	JXBR/L8..., JXT*R...
JSXBR/L1212K8-C	12	12	125	29	6.7	12	7.7	JXBR/L8..., JXT*R...
JSXBR/L1616K8	16	16	125	29	6.4	16	11.7	JXBR/L8..., JXT*R...
JSXBR/L2020K8	20	20	125	29	6.4	20	15.7	JXBR/L8..., JXT*R...
JSXBR/L2525K8	25	25	125	29	6.4	25	20.7	JXBR/L8..., JXT*R...

Can be used with JXT insert for threading.

Can be wrenched also from the back with a double-head screw.

SPARE PARTS



Designation	Clamping screw	Wrench
JSXBR/L...	CSTB-4SD	T-8F

INSERT

JXB (Sharp edge)

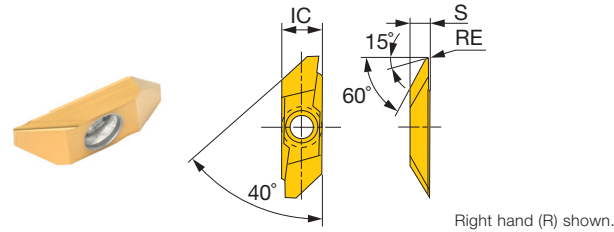

	P	M	K	N	S	H
Steel	★					
Stainless	★					
Cast iron	★		☆			
Non-ferrous				★		
Superalloys			☆		★	
Hard materials						★

★ : First choice
☆ : Second choice

Designation	HAND	RE (mm)	Coated		Uncoated					IC (mm)	S (mm)	Max. depth of cut (mm)
			J740	TH10								
JXBR8000F	R	0.03	●	●						8	3.97	5.5
JXBL8000F	L	0.03	●	●						8	3.97	5.5
JXBR8005F	R	0.05	●	●						8	3.97	5.5
JXBL8005F	L	0.05	●	●						8	3.97	5.5
JXBR8010F	R	0.1	●	●						8	3.97	5.5
JXBL8010F	L	0.1	●	●						8	3.97	5.5
JXBR8015F	R	0.15	●	●						8	3.97	5.5
JXBL8015F	L	0.15	●	●						8	3.97	5.5

● : Line up

JXB (Honed edge)

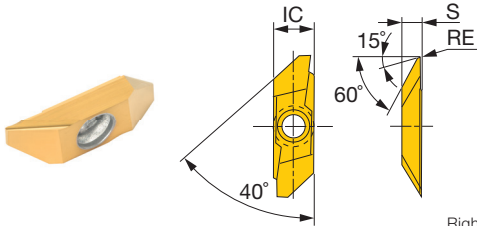

Right hand (R) shown.

P	Steel	★									
M	Stainless	★									
K	Cast iron	★									
N	Non-ferrous										
S	Superalloys	☆									
H	Hard materials										

★ : First choice
☆ : Second choice

Designation	HAND	RE (mm)	Coated								IC (mm)	S (mm)	Max. depth of cut (mm)
			J740										
JXBR/L8005	R	0.05	●								8	3.97	5.5
JXBR/L8005	L	0.05	●								8	3.97	5.5
JXBR/L8010	R	0.1	●								8	3.97	5.5
JXBR/L8010	L	0.1	●								8	3.97	5.5
JXBR/L8015	R	0.15	●								8	3.97	5.5
JXBR/L8015	L	0.15	●								8	3.97	5.5

● : Line up

STANDARD CUTTING CONDITIONS (JXB type insert)

ISO	Workpiece material	Grade	Cutting speed Vc (sfm)	Feed: f (ipr)	
				Grooving	Turning
P	Steel 1045, etc.	J740	33 - 328	0.0004 - 0.0012	0.0008 - 0.004
	Free-cutting steel	J740	33 - 328	0.0004 - 0.0012	0.0008 - 0.004
M	Stainless steel 303, etc.	J740	33 - 328	0.0004 - 0.0008	0.0008 - 0.003
N	Aluminum alloys, Brass Si < 12%, 5056, 6061, etc.	TH10	164 - 656	0.0004 - 0.0020	0.0008 - 0.004
S	Difficult-to-machine material, Titanium alloys Ti-6Al-4V, etc.	TH10	33 - 98	0.0004 - 0.0008	0.0008 - 0.002

Reference pages: Toolholders → [G067](#)

MINIFORCE

STANDARD CUTTING CONDITIONS

FOR EXTERNAL TURNING

Applications	ISO	Workpiece material	Priority	Chip breaker	Grade	Cutting speed Vc (sfm)	Depth of cut ap (in)	Feed f (ipr)
For swiss type automatic lathes	P	Low carbon steel, Carbon steel 1045, etc. Low alloy steel, Alloy steel 4140, etc.	First choice	JS	SH725	164 - 590	0.004 - 0.118	0.001 - 0.004
			With high sharpness	JSS	SH725	164 - 590	0.004 - 0.059	0.001 - 0.004
	M	Stainless steel (Austenitic) 304, etc. Stainless steel (Martensitic and ferritic) 430, etc. Stainless steel (Precipitation hardened) 174, etc.	First choice	JS	SH725	164 - 590	0.004 - 0.049	0.001 - 0.004
			With high sharpness	JSS	SH725	164 - 590	0.004 - 0.059	0.001 - 0.004
For small size CNC lathes	P	Low carbon steel, Carbon steel 1045, etc. Low alloy steel, Alloy steel 4140, etc.	First choice	SS	AH725	164 - 590	0.006 - 0.059	0.002 - 0.008
			For improved surface finish	TS	AH725	164 - 590	0.012 - 0.079	0.003 - 0.012
				SS	NS9530	164 - 656	0.006 - 0.059	0.002 - 0.008
			TS	NS9530	164 - 656	0.012 - 0.079	0.003 - 0.012	
	For wear resistance	SS	GT9530	164 - 820	0.006 - 0.059	0.002 - 0.008		
		TS	GT9530	164 - 820	0.012 - 0.079	0.003 - 0.012		
M	Stainless steel (Austenitic) 304, etc. Stainless steel (Martensitic and ferritic) 430, etc. Stainless steel (Precipitation hardened) 174, etc.	First choice	SS	AH8015	164 - 492	0.006 - 0.059	0.002 - 0.008	
		For impact resistance	TS	AH8015	164 - 492	0.012 - 0.079	0.003 - 0.012	

J-SERIES

STANDARD CUTTING CONDITIONS

ISO	Workpiece material	Priority	Grade	Cutting speed Vc (sfm)	Feed f (ipr)
P	Low carbon steel, Carbon steel 1045, etc. Low alloy steel, Alloy steel 4140, etc.	First choice	SH725	164 - 656	0.0004 - 0.008
		For impact resistance	AH725	164 - 656	0.0004 - 0.008
M	Stainless steel (Austenitic) 304, etc. Stainless steel (Martensitic and ferritic) 430, etc. Stainless steel (Precipitation hardened) 174, etc.	First choice	SH725	164 - 656	0.0004 - 0.008
		For impact resistance	AH725	164 - 656	0.0004 - 0.008
S	Titanium alloys Ti-6Al-4V, etc. Superalloys Inconel718, etc.	First choice	SH725	66 - 262	0.0004 - 0.008
		For impact resistance	AH725	66 - 262	0.0004 - 0.008

Grade
Insert
Toolholder
Ext. Toolholder
Int. Toolholder
Threading
Grooving
Miniature Tool
Milling Cutter
Endmill
Drilling Tool
Tooling System
User's Guide
Index



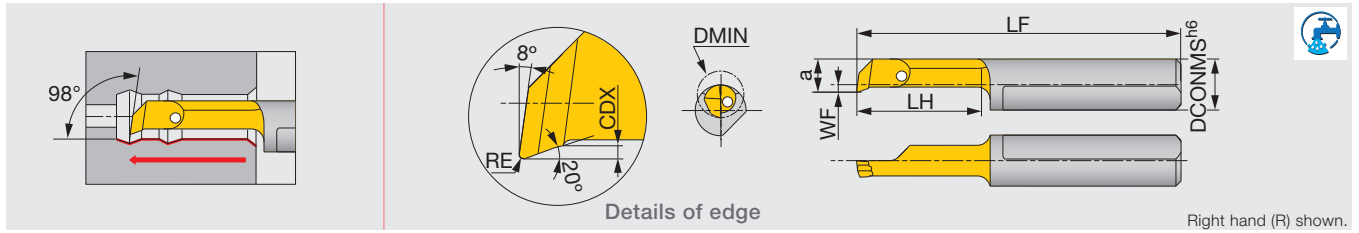

Right hand (R) shown.

Metric	SH730	DMIN	DCONMS	WF	a	LF	LH	CDX	RE ^{+0.05} ₀
JBTR04020004-D006	●	0.6	4	-	0.5	18.5	2	0.08	0.04
JBTR04030004-D006	●	0.6	4	-	0.5	19.5	3	0.08	0.04
JBTR04045005-D010	●	1	4	-	0.9	21	4.5	0.1	0.05
JBTR04065005-D010	●	1	4	-	0.9	23	6.5	0.1	0.05
JBTR04040005-D020	●	2	4	-	1.7	20.5	4	0.1	0.05
JBTR04090005-D020	●	2	4	-	1.7	25.5	9	0.1	0.05
JBTR04140005-D020	●	2	4	-	1.7	30.5	14	0.1	0.05
JBTR/L04090010-D028	●	2.8	4	0.6	2.6	25.5	9	0.2	0.1
JBTR/L04150010-D028	●	2.8	4	0.6	2.6	31.5	15	0.2	0.1
JBTR/L04190010-D028	●	2.8	4	0.6	2.6	35.5	19	0.2	0.1
JBTR/L04090010-D040	●	4	4	1.5	3.5	25.5	9	0.3	0.1
JBTR/L04150010-D040	●	4	4	1.5	3.5	31.5	15	0.3	0.1
JBTR/L04190010-D040	●	4	4	1.5	3.5	35.5	19	0.3	0.1
JBTR04230010-D040	●	4	4	1.5	3.5	39.5	23	0.3	0.1
JBTR04270010-D040	●	4	4	1.5	3.5	43.5	27	0.3	0.1
JBTR/L07090015-D050	●	5	7	0.9	4.4	25	9	0.5	0.15
JBTR/L07140015-D050	●	5	7	0.9	4.4	30	14	0.5	0.15
JBTR/L07190015-D050	●	5	7	0.9	4.4	35	19	0.5	0.15
JBTR/L07240015-D050	●	5	7	0.9	4.4	40	24	0.5	0.15
JBTR/L07290015-D050	●	5	7	0.9	4.4	45	29	0.5	0.15
JBTR07340015-D050	●	5	7	0.9	4.4	50	34	0.5	0.15
JBTR/L07140015-D060	●	6	7	1.8	5.3	30	14	0.5	0.15
JBTR/L07210015-D060	●	6	7	1.8	5.3	37	21	0.5	0.15
JBTR/L07240015-D060	●	6	7	1.8	5.3	40	24	0.5	0.15
JBTR/L07290015-D060	●	6	7	1.8	5.3	45	29	0.5	0.15
JBTR07340015-D060	●	6	7	1.8	5.3	50	34	0.5	0.15
JBTR07410015-D060	●	6	7	1.8	5.3	57	41	0.5	0.15
JBTR/L07190015-D068	●	6.8	7	2.8	6.3	35	19	0.6	0.15
JBTR07240015-D068	●	6.8	7	2.8	6.3	40	24	0.6	0.15
JBTR/L07290015-D068	●	6.8	7	2.8	6.3	45	29	0.6	0.15
JBTR/L07340015-D070	●	7	7	2.8	6.3	50	34	0.6	0.15
JBTR07390015-D070	●	7	7	2.8	6.3	55	39	0.6	0.15
JBTR07440015-D070	●	7	7	2.8	6.3	60	44	0.6	0.15
JBTR07490015-D070	●	7	7	2.8	6.3	65	49	0.6	0.15

● : Line up

TINYM^{INI}TURN

JBP R

Solid boring bar for boring and chamfering

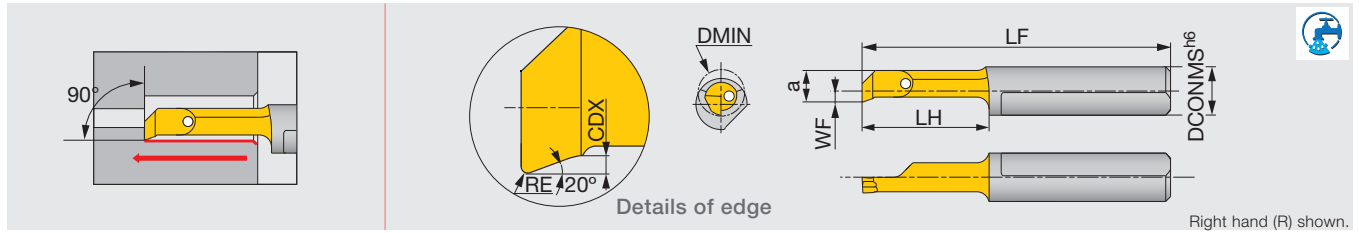

Metric	SH730	DMIN	DCONMS	WF	a	LF	LH	CDX	RE ^{+0.05} ₀
JBPR04090010-D028	●	2.8	4	0.9	2.6	25.5	9	0.2	0.1
JBPR04150010-D028	●	2.8	4	0.9	2.6	31.5	15	0.2	0.1
JBPR04090010-D040	●	4	4	1.5	3.5	25.5	9	0.3	0.1
JBPR04150010-D040	●	4	4	1.5	3.5	31.5	15	0.3	0.1
JBPR07140015-D050	●	5	7	0.9	4.4	30	14	0.5	0.15
JBPR07190015-D050	●	5	7	0.9	4.4	35	19	0.5	0.15

● : Line up

TINYM^{INI}TURN

JBU R

Solid boring bar for back boring and chamfering

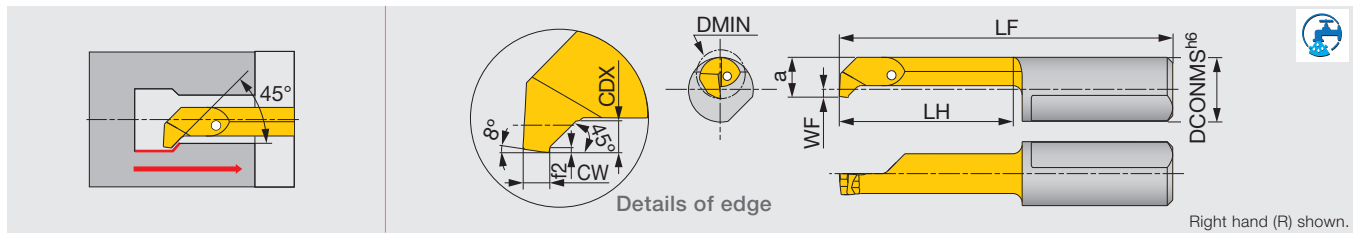

Metric	SH730	DMIN	DCONMS	WF	a	LF	LH	f2	CDX	CW ^{+0.05} ₀
JBUR07140010-D050	●	5	7	0.9	4.4	30	14	0.2	1	1
JBUR07190010-D050	●	5	7	0.9	4.4	35	19	0.2	1	1

● : Line up

TINYM^{INI}TURN

JBC R

Solid boring bar for boring and 45° chamfering

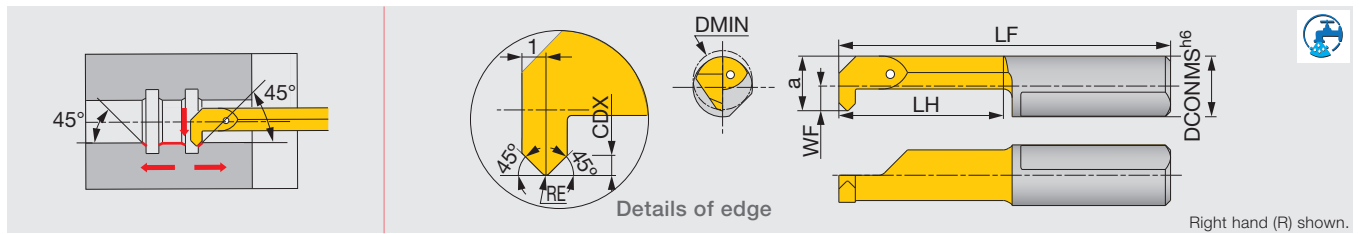

Metric	SH730	DMIN	DCONMS	WF	a	LF	LH	CDX	RE ^{+0.05} ₀
JBCR07140020-D050	●	5	7	0.9	4.4	30	14	0.7	0.2
JBCR07190020-D050	●	5	7	0.9	4.4	35	19	0.7	0.2
JBCR07190020-D068	●	6.8	7	2.8	6.3	35	19	0.7	0.2

● : Line up

Reference pages: JBP R, JBU R, JBC R: Standard cutting conditions → G078

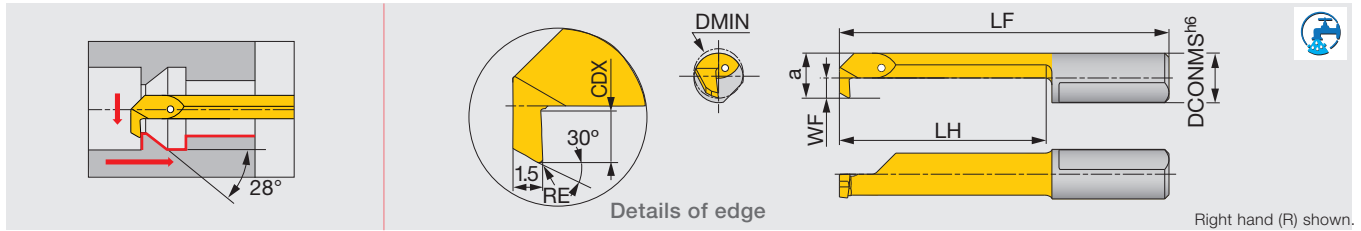

Right hand (R) shown.

Metric	SH730	DMIN	DCONMS	WF	a	LF	LH	CDX	RE ^{+0.05}
JBBR04140020-D030	●	3	4	0.6	2.6	30	14	0.5	0.2
JBBR04190020-D030	●	3	4	0.6	2.6	35	19	0.5	0.2
JBBR04140015-D040	●	4	4	1.5	3.5	30	14	0.8	0.15
JBBR04240015-D040	●	4	4	1.5	3.5	40	24	0.8	0.15
JBBR07190020-D050	●	5	7	0.9	4.4	35	19	1	0.2
JBBR07290020-D050	●	5	7	0.9	4.4	45	29	1	0.2
JBBR07190020-D060	●	6	7	1.8	5.3	35	19	1.8	0.2
JBBR07290020-D060	●	6	7	1.8	5.3	45	29	1.8	0.2
JBBR07190020-D070	●	7	7	2.8	6.3	35	19	2.5	0.2
JBBR07290020-D070	●	7	7	2.8	6.3	45	29	2.5	0.2

● : Line up

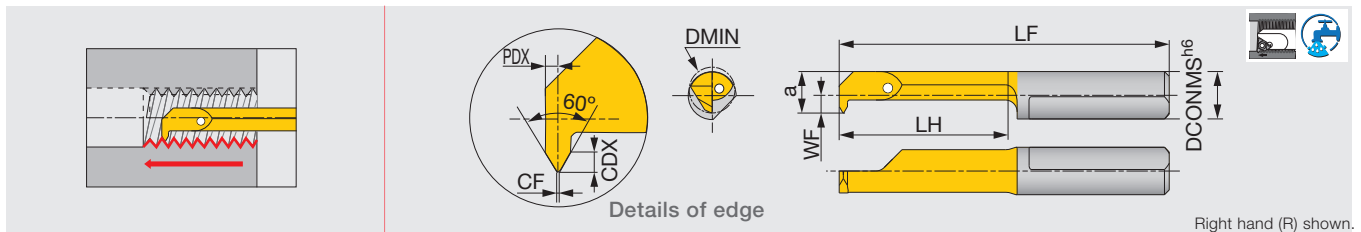

Right hand (R) shown.

Metric	SH730	Pitch	DMIN	CF _{0.02}	DCONMS	WF	a	LF	LH	CDX	PDX
JBIR04140050-D040	●	0.5	4	0.06	4	1.5	3.5	30	14	0.3	0.35
JBIR07140050-D050	●	0.5	5	0.06	7	0.9	4.4	30	14	0.3	0.35
JBIR07140075-D050	●	0.75	5	0.09	7	0.9	4.4	30	14	0.4	0.45
JBIR07140100-D048	●	1	4.8	0.12	7	0.9	4.4	30	14	0.6	0.55
JBIR07140100-D060	●	1	6	0.12	7	1.8	5.3	30	14	0.6	0.55
JBIR07140125-D060	●	1.25	6	0.15	7	1.8	5.3	30	14	0.7	0.65
JBIR07140150-D060	●	1.5	6	0.18	7	1.8	5.3	30	14	0.8	0.75
JBIR07140150-D070	●	1.5	7	0.18	7	2.8	6.3	30	14	0.8	0.75

● : Line up

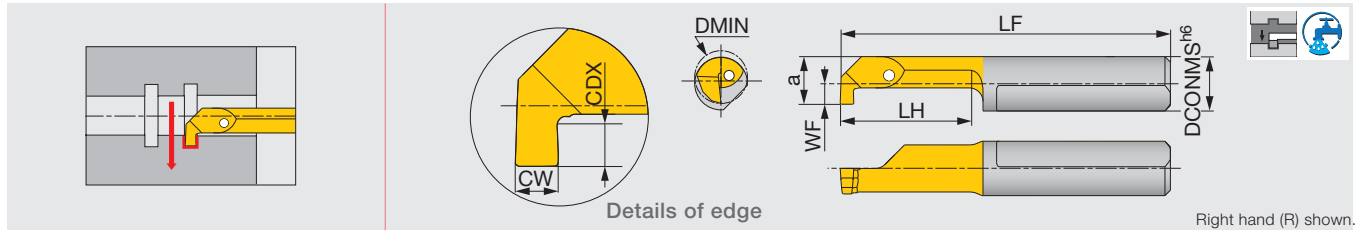

Metric	SH730	CW ^{+0.05} ₀	DMIN	DCONMS	WF	a	LF	LH	CDX
JBGR04050050-D020	●	0.5	2	4	0.2	1.8	21	5	0.4
JBGR04100050-D020	●	0.5	2	4	0.2	1.8	26	10	0.4
JBGR04050070-D030	●	0.7	3	4	0.7	2.7	21	5	0.6
JBGR04100070-D030	●	0.7	3	4	0.7	2.7	26	10	0.6
JBGR04090100-D040	●	1	4	4	1.5	3.5	25.5	9	0.8
JBGR04150100-D040	●	1	4	4	1.5	3.5	31.5	15	0.8
JBGR07090100-D050	●	1	5	7	0.9	4.4	25	9	1
JBGR07140100-D050	●	1	5	7	0.9	4.4	30	14	1
JBGR07090150-D050	●	1.5	5	7	0.9	4.4	25	9	1
JBGR07140150-D050	●	1.5	5	7	0.9	4.4	30	14	1
JBGR07090200-D050	●	2	5	7	0.9	4.4	25	9	1
JBGR07190200-D050	●	2	5	7	0.9	4.4	35	19	1
JBGR/L07090100-D060	●	1	6	7	1.8	5.3	25	9	1.8
JBGR07140100-D060	●	1	6	7	1.8	5.3	30	14	1.8
JBGR07210100-D060	●	1	6	7	1.8	5.3	37	21	1.8
JBGR07290100-D060	●	1	6	7	1.8	5.3	45	29	1.8
JBGR/L07090150-D060	●	1.5	6	7	1.8	5.3	25	9	1.8
JBGR07140150-D060	●	1.5	6	7	1.8	5.3	30	14	1.8
JBGR07210150-D060	●	1.5	6	7	1.8	5.3	37	21	1.8
JBGR07240150-D060	●	1.5	6	7	1.8	5.3	40	24	1.8
JBGR07290150-D060	●	1.5	6	7	1.8	5.3	45	29	1.8
JBGR07090200-D060	●	2	6	7	1.8	5.3	25	9	1.8
JBGR07140200-D060	●	2	6	7	1.8	5.3	30	14	1.8
JBGR07210200-D060	●	2	6	7	1.8	5.3	37	21	1.8
JBGR07240200-D060	●	2	6	7	1.8	5.3	40	24	1.8
JBGR07290200-D060	●	2	6	7	1.8	5.3	45	29	1.8
JBGR07090100-D068	●	1	6.8	7	2.7	6.2	25	9	2.5
JBGR07140100-D068	●	1	6.8	7	2.7	6.2	30	14	2.5
JBGR07210100-D068	●	1	6.8	7	2.7	6.2	37	21	2.5
JBGR07090150-D068	●	1.5	6.8	7	2.7	6.2	25	9	2.5
JBGR07140150-D068	●	1.5	6.8	7	2.7	6.2	30	14	2.5
JBGR07210150-D068	●	1.5	6.8	7	2.7	6.2	37	21	2.5
JBGR07290150-D068	●	1.5	6.8	7	2.7	6.2	45	29	2.5
JBGR07090200-D068	●	2	6.8	7	2.7	6.2	25	9	2.5
JBGR/L07140200-D068	●	2	6.8	7	2.7	6.2	30	14	2.5
JBGR07210200-D068	●	2	6.8	7	2.7	6.2	37	21	2.5
JBGR07250200-D068	●	2	6.8	7	2.7	6.2	40	25	2.5
JBGR07290200-D068	●	2	6.8	7	2.7	6.2	45	29	2.5

Corner radius: less than 0.004" (0.1 mm)

● : Line up

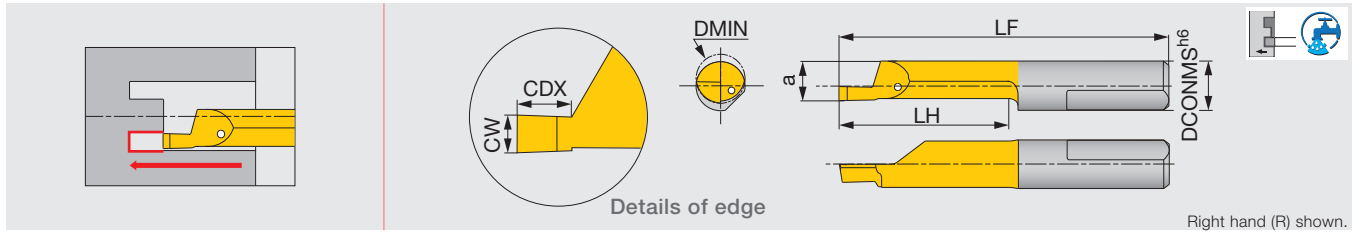

Right hand (R) shown.

Metric	SH730	$CW^{+0.05}_0$	DMIN	DCONMS	a	LF	LH	CDX
JBFR07110100-D060	●	1	6	7	5.2	26	10	1.5
JBFR07110150-D060	●	1.5	6	7	5.2	26	10	2
JBFR07110200-D060	●	2	6	7	5.2	26	10	3
JBFR07110100-D080	●	1	8	7	5.9	27	11	1.5
JBFR07110150-D080	●	1.5	8	7	5.9	27	11	2.5
JBFR07110200-D080	●	2	8	7	5.9	27	11	3
JBFR07110250-D080	●	2.5	8	7	5.9	27	11	3.5
JBFR07110300-D080	●	3	8	7	5.9	27	11	3.5
JBFR/L07210150-D080	●	1.5	8	7	5.9	36	21	2.5
JBFR07210200-D080	●	2	8	7	5.9	36	21	3
JBFR07210250-D080	●	2.5	8	7	5.9	36	21	3.5
JBFR07210300-D080	●	3	8	7	5.9	36	21	3.5
JBFR/L07300200-D080	●	2	8	7	5.9	46	30	3
JBFR07300300-D080	●	3	8	7	5.9	46	30	3.5
JBFR07200200-D080	●	2	8	7	5.9	36	20	3
JBFR07200250-D150	●	2.5	15	7	5.9	36	20	20
JBFR07200300-D150	●	3	15	7	5.9	36	20	20
JBFR07300300-D150	●	3	15	7	5.9	46	30	30

Corner radius: less than 0.004" (0.1 mm)

● : Line up

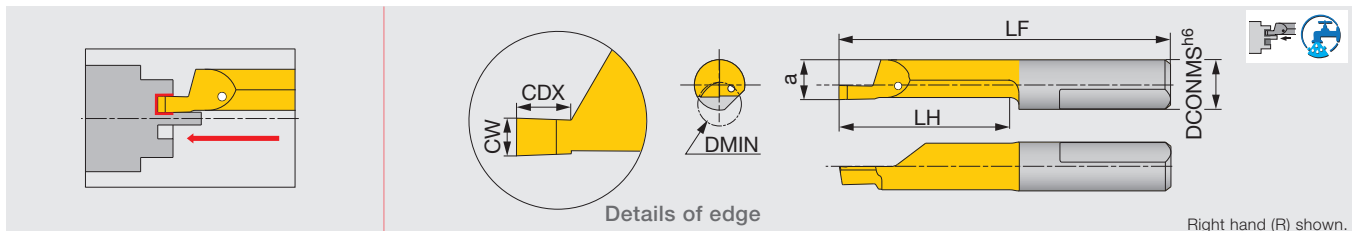
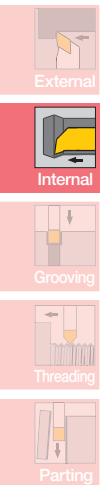

Right hand (R) shown.

Metric	SH730	$CW^{+0.05}_0$	DMIN	DCONMS	a	LF	LH	CDX
JBSR07200200-D060	●	2	6	7	5.2	36	20	4

Corner radius: less than 0.004" (0.1 mm)

● : Line up

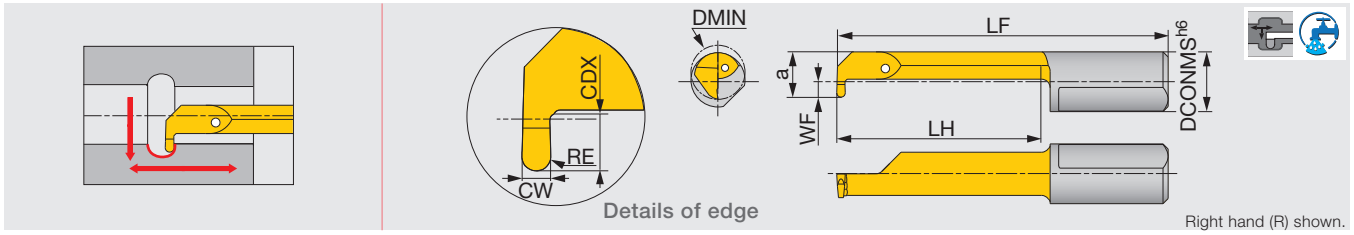

Metric	SH730	CW ^{+0.05} ₀	DMIN	DCONMS	WF	a	LF	LH	CDX	RE
JBRR07190050-D050	●	1	5	7	0.9	4.4	35	19	1	0.5
JBRR07240050-D060	●	1	6	7	1.8	5.3	40	24	1.8	0.5
JBRR07290050-D068	●	1	6.8	7	2.8	6.3	45	29	2.5	0.5

● : Line up

TINYTURN^{INI}

JBBS

Sleeve for external coolant supply

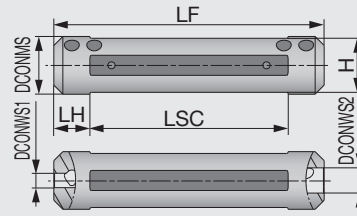

Metric	DCONMS	DCONWS1	DCONWS2	LF	LH	LSC	H
JBBS12-4-4	12	4	4	75	10	55	10.3
JBBS127-4-4	12.7	4	4	76.2	10	56.2	11.6
JBBS14-4-4	14	4	4	75	10	55	12
JBBS159-4-7	15.875	4	7	76.2	10	56.2	14
JBBS16-4-7	16	4	7	75	10	55	15
JBBS19-4-7	19.05	4	7	89	10	69	17.2
JBBS20-4-7	20	4	7	90	10	70	18
JBBS22-4-7	22	4	7	90	10	70	20
JBBS25-4-7	25	4	7	100	10	80	23
JBBS254-4-7	25.4	4	7	90	10	70	23.4

SPARE PARTS



Designation	Clamping screw	Wrench
JBBS12-4-4	SSHM5-4PF-S	P-2.5
JBBS127-4-4	SSHM5-6PF-S	P-2.5
JBBS14-4-4	SSHM5-4PF-S	P-2.5
JBBS**-4-7	SSHM5-6PF-S	P-2.5



TINYTURN^{INI}

JBBS-C

Sleeve for internal coolant supply

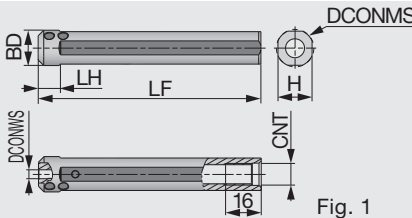

Fig. 1

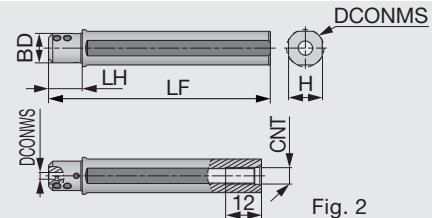

Fig. 2

Metric	DCONMS	BD	DCONWS	LF	LH	H	CNT	Fig.
JBBS159-4-L100C	15.875	15.875	4	100	10	14.58	R1/8	1
JBBS159-7-L100C	15.875	15.875	7	100	10	14.58	R1/8	1
JBBS16-4-L100C	16	16	4	100	10	15	R1/8	1
JBBS16-7-L100C	16	16	7	100	10	15	R1/8	1
JBBS19-4-L100C	19.05	17.5	4	100	20	17.2	R1/8	2
JBBS19-7-L100C	19.05	17.5	7	100	20	17.2	R1/8	2
JBBS20-4-L100C	20	17.5	4	100	20	18	R1/8	2
JBBS20-7-L100C	20	17.5	7	100	20	18	R1/8	2
JBBS22-4-L100C	22	17.5	4	100	20	20	R1/8	2
JBBS22-7-L100C	22	17.5	7	100	20	20	R1/8	2
JBBS25-4-L100C	25	18	4	100	23	23	R1/8	2
JBBS25-7-L100C	25	18	7	100	23	23	R1/8	2
JBBS254-4-L100C	25.4	18	4	100	23	23.4	R1/8	2
JBBS254-7-L100C	25.4	18	7	100	23	23.4	R1/8	2

SPARE PARTS



Designation	Clamping screw	Wrench
JBBS**-4-L100C	SSHM5-6PF-S	P-2.5
JBBS**-7-L100C	SSHM5-4PF-S	P-2.5

Collet chuck sleeve for solid carbide bars

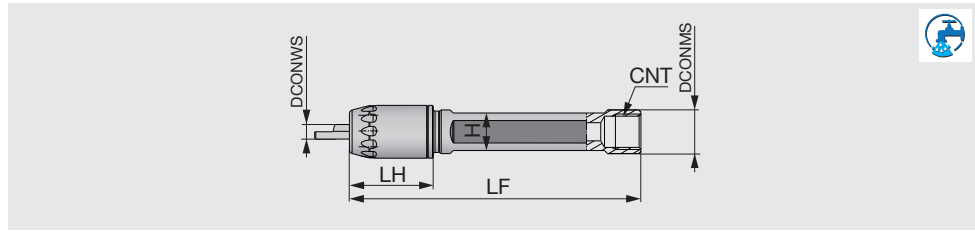

Metric	DCONMS	DCONWS	LF	LH	H	CNT
JBBSA16-4-L100C	16	4	100	23	14	Rc1/8
JBBSA16-7-L100C	16	7	100	23	14	Rc1/8
JBBSA20-4-L120C	20	4	120	23	18	Rc1/8
JBBSA20-7-L120C	20	7	120	23	18	Rc1/8

SPARE PARTS



Designation	Cap	Wrench
JBBSA*-4-L100C	CAP-A-4	WRENCH-A-4
JBBSA*-7-L100C	CAP-A-7	WRENCH-A-7

Grade

Insert

Toolholder

Ext. Toolholder

Int. Toolholder

Threading

Grooving

Miniature Tool

Milling Cutter

Endmill

Drilling Tool

Tooling System

User's Guide

Index

A

B

C

D

E

F

G

H

I

J

K

L

M

STANDARD CUTTING CONDITIONS



Boring, profiling, chamfering, back boring

ISO	Workpiece material	Grade	Cutting speed		Feed	
			Vc (m/min)	Vc (sfm)	f (mm/rev)	f (ipr)
P	Low carbon steel 1015, 1025, etc.	SH730	40 - 140	131 - 459	0.01 - 0.08 *	0.0004 - 0.003 *
	Carbon steel, Alloy steel 1055, 4140, etc.	SH730	40 - 140	131 - 459	0.01 - 0.08 *	0.0004 - 0.003 *
	Prehardened steel NAK80, PX5, etc.	SH730	40 - 140	131 - 459	0.01 - 0.08 *	0.0004 - 0.003 *
M	Stainless steel 304, 316, etc.	SH730	40 - 140	131 - 459	0.01 - 0.08 *	0.0004 - 0.003 *
K	Gray cast iron No.250B, No.300B, etc.	SH730	30 - 100	98 - 328	0.01 - 0.08 *	0.0004 - 0.003 *
	Ductile cast iron 65-45-12, 80-55-06, etc.	SH730	30 - 100	98 - 328	0.01 - 0.08 *	0.0004 - 0.003 *
N	Aluminium alloys, Copper alloys Si < 12%	SH730	90 - 200	295 - 656	0.01 - 0.08 *	0.0004 - 0.003 *
S	Titanium alloys Ti-6Al-4V, etc.	SH730	30 - 100	98 - 328	0.01 - 0.08 *	0.0004 - 0.003 *
	Superalloys Inconel718, etc.	SH730	30 - 100	98 - 328	0.01 - 0.08 *	0.0004 - 0.003 *

* JBTR/L04020004-D006, JBTR/L04030004-D006 : Max. f = 0.0004 ipr (0.01 mm/rev)

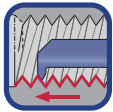

Threading (metric thread)

ISO	Workpiece material	Grade	Cutting speed		Number of passes Pitch (mm)				
			Vc (m/min)	Vc (sfm)	0.5 (0.020")	0.75 (0.030")	1 (0.039")	1.25 (0.049")	1.5 (0.059")
P	Low carbon steel 1015, 1025, etc.	SH730	40 - 140	131 - 459	6 - 8	8 - 10	10 - 12	12 - 15	15 - 18
	Carbon steel, Alloy steel 1055, 4140, etc.	SH730	40 - 140	131 - 459	6 - 8	8 - 10	10 - 12	12 - 15	15 - 18
	Prehardened steel NAK80, PX5, etc.	SH730	40 - 140	131 - 459	6 - 8	8 - 10	10 - 12	12 - 15	15 - 18
M	Stainless steel 304, 316, etc.	SH730	40 - 140	131 - 459	8	10	12	15	18
K	Gray cast iron No.250B, No.300B, etc.	SH730	30 - 100	98 - 328	7	9	12	14	17
	Ductile cast iron 65-45-12, 80-55-06, etc.	SH730	30 - 100	98 - 328	7	9	12	14	17
N	Aluminium alloys, Copper alloys Si < 12%	SH730	90 - 200	295 - 656	6	8	10	12	15



Internal grooving

ISO	Workpiece material	Grade	Cutting speed		Feed	
			Vc (m/min)	Vc (sfm)	f (mm/rev)	f (ipr)
P	Low carbon steel 1015, 1025, etc.	SH730	40 - 140	131 - 459	0.01 - 0.03	0.0004 - 0.001
	Carbon steel, Alloy steel 1055, 4140, etc.	SH730	40 - 140	131 - 459	0.01 - 0.03	0.0004 - 0.001
	Prehardened steel NAK80, PX5, etc.	SH730	40 - 140	131 - 459	0.01 - 0.03	0.0004 - 0.001
M	Stainless steel 304, 316, etc.	SH730	40 - 140	131 - 459	0.01 - 0.03	0.0004 - 0.001
K	Gray cast iron No.250B, No.300B, etc.	SH730	30 - 100	98 - 328	0.01 - 0.03	0.0004 - 0.001
	Ductile cast iron 65-45-12, 80-55-06, etc.	SH730	30 - 100	98 - 328	0.01 - 0.03	0.0004 - 0.001
N	Aluminium alloys, Copper alloys Si < 12%	SH730	90 - 200	295 - 656	0.01 - 0.03	0.0004 - 0.001
S	Titanium alloys Ti-6Al-4V, etc.	SH730	30 - 100	98 - 328	0.01 - 0.03	0.0004 - 0.001
	Superalloys Inconel718, etc.	SH730	30 - 100	98 - 328	0.01 - 0.03	0.0004 - 0.001



Face grooving

ISO	Workpiece material	Grade	Cutting speed		Feed	
			Vc (m/min)	Vc (sfm)	f (mm/rev)	f (ipr)
P	Low carbon steel 1015, 1025, etc.	SH730	40 - 140	131 - 459	0.01 - 0.05	0.0004 - 0.002
	Carbon steel, Alloy steel 1055, 4140, etc.	SH730	40 - 140	131 - 459	0.01 - 0.05	0.0004 - 0.002
	Prehardened steel NAK80, PX5, etc.	SH730	40 - 140	131 - 459	0.01 - 0.05	0.0004 - 0.002
M	Stainless steel 304, 316, etc.	SH730	40 - 140	131 - 459	0.01 - 0.05	0.0004 - 0.002
K	Gray cast iron No.250B, No.300B, etc.	SH730	30 - 100	98 - 328	0.01 - 0.05	0.0004 - 0.002
	Ductile cast iron 65-45-12, 80-55-06, etc.	SH730	30 - 100	98 - 328	0.01 - 0.05	0.0004 - 0.002
N	Aluminium alloys, Copper alloys Si < 12%	SH730	90 - 200	295 - 656	0.01 - 0.05	0.0004 - 0.002
S	Titanium alloys Ti-6Al-4V, etc.	SH730	30 - 100	98 - 328	0.01 - 0.05	0.0004 - 0.002
	Superalloys Inconel718, etc.	SH730	30 - 100	98 - 328	0.01 - 0.05	0.0004 - 0.002

Grade
Insert
Toolholder
Ext. Toolholder
Int. Toolholder
Threading
Grooving
Miniature Tool
Milling Cutter
Endmill
Drilling Tool
Tooling System
Index



TETRAMCUT

STCR/L-18

External grooving and threading toolholder

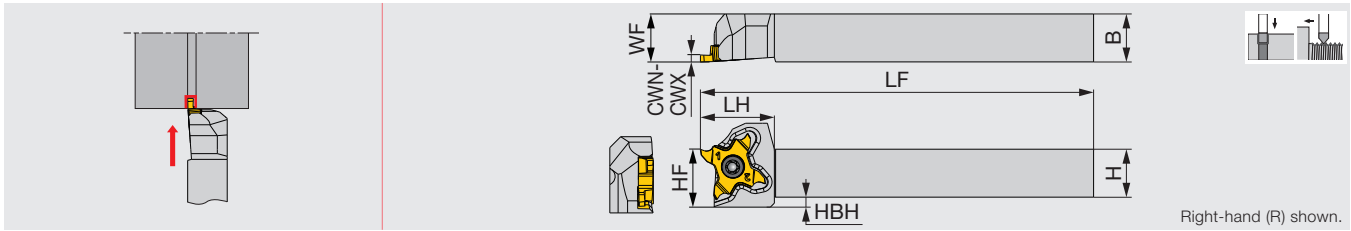

Right-hand (R) shown.

Inch	CWN	CWX	H	B	LF	LH	HF	WF	HBH	Insert	Torque
STCR/L06-18	0.013	0.118	0.375	0.375	4.750	0.740	0.375	0.375	0.177	TC*18...	0.89
STCR/L08-18	0.013	0.118	0.500	0.500	4.750	0.740	0.500	0.500	0.098	TC*18...	0.89
STCR/L10-18	0.013	0.118	0.625	0.625	4.750	0.740	0.625	0.625	-	TC*18...	0.89
STCR/L12-18	0.013	0.118	0.750	0.750	4.750	0.900	0.750	1.000	-	TC*18...	0.89
STCR/L16-18	0.013	0.118	1.000	1.000	5.500	0.900	1.000	1.250	-	TC*18...	0.89

The right hand insert (TC*18R...) is used for the right hand toolholders (STCR...), and the left hand insert is used for the left hand toolholders
Torque: Recommended clamping torque: lbs-ft

SPARE PARTS

Designation	Clamping screw	Wrench
STCR**18	CSTC-4L100DL	T-1008/5
STCL**18	CSTC-4L100DR	T-1008/5

Left-Hand Insert

Right-Hand Insert



TCP18L...



TCP18R...

TUNG T^{URN}JET

STCR/L-18-CHP

TETRAMCUT

External grooving and threading toolholder, with high pressure coolant capability

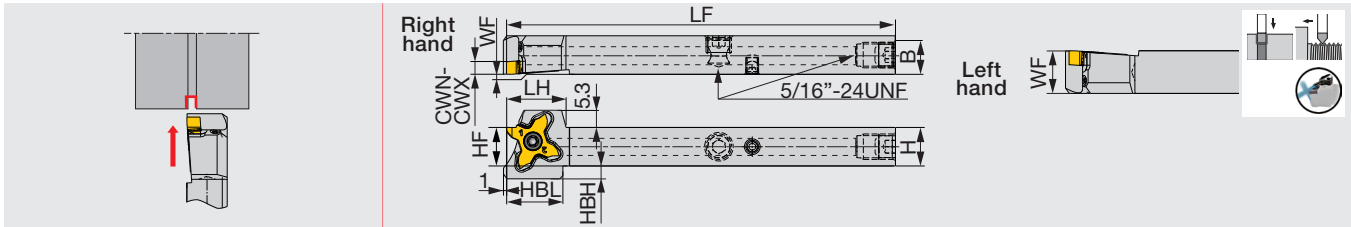

Inch	CWN	CWX	H	B	LF	LH	HBL	HF	WF	HBH	Insert	Torque
STCR/L08X18-CHP ⁽¹⁾	0.013	0.118	0.500	0.500	4.750	0.728	0.689	0.500	0/0.500	0.130	TC*18...	0.89
STCR/L10X18-CHP ⁽¹⁾	0.013	0.118	0.625	0.625	4.750	0.728	-	0.625	0/0.625	-	TC*18...	0.89

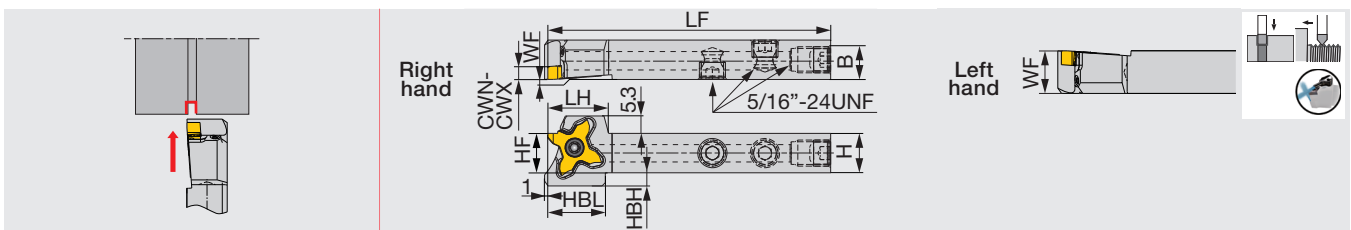

Inch	CWN	CWX	H	B	LF	LH	HBL	HF	WF	HBH	Insert	Torque
STCR/L08F18-CHP	0.013	0.118	0.500	0.500	3.344	0.728	0.689	0.500	0/0.500	0.130	TC*18...	0.89

SPARE PARTS

Designation	Clamping screw	Wrench
STCL**18-CHP	CSTC-4L100DR	T-1008/5
STCR**18-CHP	CSTC-4L100DL	T-1008/5

Use the right hand insert (TC*18R...) with the right hand toolholders (STCR...).
Use the left hand insert (TC*18L...) with the left hand holder (STCL...).
(1) Compatible to the direct internal coolant supply system without the use of external coolant hose.
Torque: Recommended clamping torque: lbs-ft

Reference pages: STCR/L-18: Inserts → G083 - G088, Standard cutting conditions → G089 - G090

Threading tool - for external threading with high pressure coolant capability

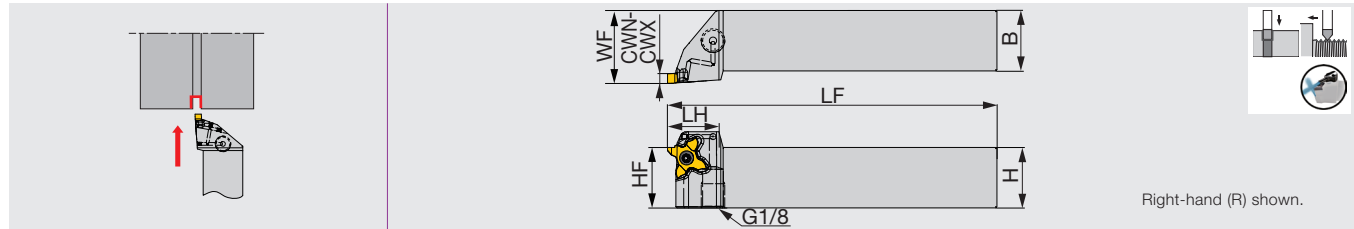

Inch	CWN	CWX	H	B	LF	LH	HBL	HF	WF	HBH	Insert	Torque
STCR/L12-18-CHP	0.013	0.118	0.750	0.750	4.750	0.900	-	0.750	1.000	-	TC*18...	0.89
STCR/L16-18-CHP	0.013	0.118	1.000	1.000	5.500	.900	-	1.000	1.250	-	TC*18...	0.89

Use the right hand insert (TC*18R...) with the right hand toolholders (STCR...). Use the left hand insert (TC*18L) with the left hand holder (STCL...).
Torque: Recommended clamping torque: lbs-ft

SPARE PARTS

Designation	Clamping screw	Wrench
STCL**18-CHP	CSTC-4L100DR	T-1008/5
STCR**18-CHP	CSTC-4L100DL	T-1008/5

TETRAMCUT

JS-STCL18

External grooving and threading toolholder with round shank, for Swiss lathes

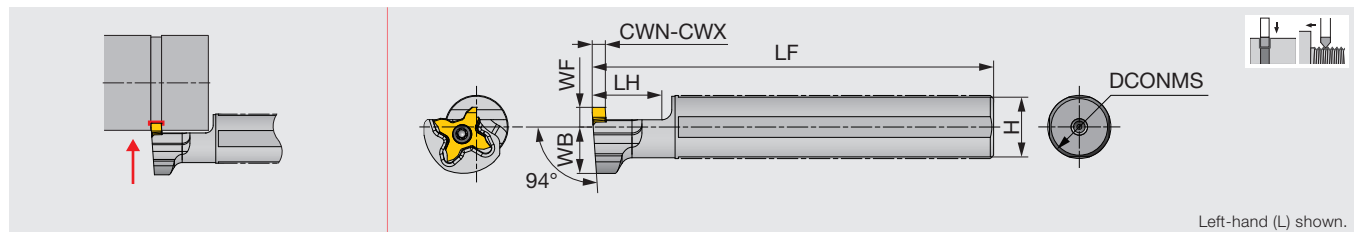

Metric	CWN	CWX	DCONMS	H	LF	LH	WB	WF	Insert	Torque
JS14H-STCL18	0.33	3	14	13	100	20	14	6	TC*18R...	1.2
JS159F-STCL18	0.33	3	15.875	15	85	20	14	6	TC*18R...	1.2
JS16F-STCL18	0.33	3	16	15	85	20	14	6	TC*18R...	1.2
JS19G-STCL18	0.33	3	19.05	18	90	20	14	6	TC*18R...	1.2
JS19X-STCL18	0.33	3	19.05	18	120	20	14	6	TC*18R...	1.2
JS20G-STCL18	0.33	3	20	19	90	20	14	6	TC*18R...	1.2
JS20X-STCL18	0.33	3	20	19	120	20	14	6	TC*18R...	1.2
JS22X-STCL18	0.33	3	22	21	120	20	12.25	10	TC*18R...	1.2
JS25H-STCL18	0.33	3	25	24	100	20	12.25	10	TC*18R...	1.2
JS254X-STCL18	0.33	3	25.4	24	120	20	12.25	10	TC*18R...	1.2

The left hand toolholder (STCL...) is used with the right hand inserts (TC*18R...)
Torque: Recommended clamping torque: N-m

SPARE PARTS

Designation	Clamping screw	Wrench
JS...STCL18	CSTC-4L100DL	T-1008/5

Selection guide for TetraMini-Cut inserts

Groove width		Corner rad.		TCS18R (G083)	TCG18R/L (G084 - 85)	TCP18R/L (G086)	TCP18R/L-F (G087)
CW (in)	CW (mm)	RE (in)	RE (mm)	AH7025	AH7025	AH725	SH725
				Honed edge	Honed edge	Lightly honed edge	Sharp edge
0.013	0.33	0.002	0.05			●	●
0.017	0.43	0.002	0.05			●	●
0.020	0.50	0.002	0.05			●	●
0.030	0.75	0.002	0.05			●	●
0.037	0.95	0.002	0.05			●	●
0.039	1.00	0.002	0.05				●
		0.004	0.1	●	●	●	●
0.047	1.20	0.002	0.05				●
		0.004	0.1	●	●	●	●
0.049	1.25	0.002	0.05				●
		0.004	0.1	●	●	●	●
		0.008	0.2	●	●		
0.051	1.30	0.008	0.2	●	●		
0.055	1.40	0.004	0.1	●	●	●	●
		0.008	0.2	●	●		
0.057	1.45	0.002	0.05				●
		0.004	0.1	●	●	●	●
		0.008	0.2		●		
0.059	1.50	0.002	0.05				●
		0.004	0.1	●	●	●	●
		0.008	0.2	●	●		
0.063	1.60	0.008	0.2	●	●		
0.067	1.70	0.008	0.2	●	●		
		0.002	0.05				●
0.069	1.75	0.004	0.1	●	●	●	●
		0.008	0.2	●	●		
		0.008	0.2				
0.073	1.85	0.008	0.2	●	●		
0.077	1.95	0.008	0.2	●	●		
0.079	2.00	0.002	0.05				●
		0.004	0.1	●	●	●	●
		0.008	0.2	●	●		
0.089	2.25	0.008	0.2	●	●		
0.091	2.30	0.008	0.2	●	●		
0.098	2.50	0.004	0.1	●	●	●	●
		0.008	0.2	●	●		
		0.012	0.3	●	●		
0.104	2.65	0.012	0.3	●	●		
0.110	2.80	0.012	0.3	●	●		
0.118	3.00	0.004	0.1	●	●	●	●
		0.008	0.2	●	●		
		0.012	0.3	●	●		

● : Line up

INSERT

TCS18R (3D chipbreaker, honed edge)

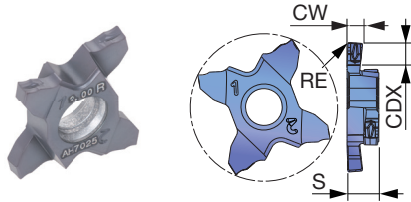

P	Steel	★						
M	Stainless	★						
K	Cast iron	★						
N	Non-ferrous							
S	Superalloys	★						
H	Hard materials							

★ : First choice
☆ : Second choice

Designation	HAND	CW±0.02 (mm)	CW±0.001 (in)	RE (in)	Coated								CDX (in)	S (in)
					AH7025									
TCS18R100-010	R	1	0.039	0.004	●								0.079	0.157
TCS18R120-010	R	1.2	0.047	0.004	●								0.079	0.157
TCS18R125-010	R	1.25	0.049	0.004	●								0.079	0.157
TCS18R125-020	R	1.25	0.049	0.008	●								0.079	0.157
TCS18R130-020	R	1.3	0.051	0.008	●								0.138	0.157
TCS18R140-010	R	1.4	0.055	0.004	●								0.138	0.157
TCS18R140-020	R	1.4	0.055	0.008	●								0.138	0.157
TCS18R145-010	R	1.45	0.057	0.004	●								0.138	0.157
TCS18R150-010	R	1.5	0.059	0.004	●								0.138	0.157
TCS18R150-020	R	1.5	0.059	0.008	●								0.138	0.157
TCS18R160-020	R	1.6	0.063	0.008	●								0.138	0.157
TCS18R170-020	R	1.7	0.067	0.008	●								0.138	0.157
TCS18R175-010	R	1.75	0.069	0.004	●								0.138	0.157
TCS18R175-020	R	1.75	0.069	0.008	●								0.138	0.157
TCS18R185-020	R	1.85	0.073	0.008	●								0.138	0.157
TCS18R195-020	R	1.95	0.077	0.008	●								0.138	0.157
TCS18R200-010	R	2	0.079	0.004	●								0.138	0.157
TCS18R200-020	R	2	0.079	0.008	●								0.138	0.157
TCS18R225-020	R	2.25	0.089	0.008	●								0.138	0.157
TCS18R230-020	R	2.3	0.091	0.008	●								0.138	0.157
TCS18R250-010	R	2.5	0.098	0.008	●								0.138	0.157
TCS18R250-020	R	2.5	0.098	0.008	●								0.138	0.157
TCS18R250-030	R	2.5	0.098	0.012	●								0.138	0.157
TCS18R265-030	R	2.65	0.104	0.012	●								0.138	0.157
TCS18R280-030	R	2.8	0.110	0.012	●								0.138	0.157
TCS18R300-010	R	3	0.118	0.004	●								0.138	0.157
TCS18R300-020	R	3	0.118	0.008	●								0.138	0.157
TCS18R300-030	R	3	0.118	0.012	●								0.138	0.157

See page G089 for precautions of processing.

5 pieces per package
● : Line up

Reference pages: Toolholders → G080 - G081, Standard cutting conditions → G089 - G090

Grade
Insert
Toolholder
Ext. Toolholder
Int. Toolholder
Threading
Grooving
Miniature Tool
Milling Cutter
Endmill
Drilling Tool
Tooling System
User's Guide
Index



INSERT

TCG18R/L (with edge preparation)

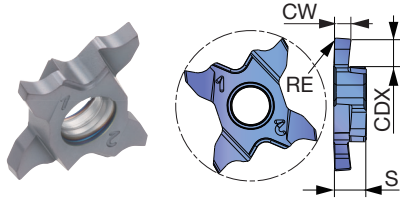

P	Steel	★				
M	Stainless	★				
K	Cast iron	★				
N	Non-ferrous					
S	Superalloys	★				
H	Hard materials					

★ : First choice
☆ : Second choice

Designation	HAND	CW±0.02 (mm)	CW±0.001 (in)	RE (in)	Coated										CDX (in)	S (in)			
					AH7025														
TCG18R100-010	R	1	0.039	0.004	●													0.079	0.157
TCG18L100-010	L	1	0.039	0.004	●													0.079	0.157
TCG18R120-010	R	1.2	0.047	0.004	●													0.079	0.157
TCG18L120-010	L	1.2	0.047	0.004	●													0.079	0.157
TCG18R125-010	R	1.25	0.049	0.004	●													0.079	0.157
TCG18L125-010	L	1.25	0.049	0.004	●													0.079	0.157
TCG18R125-020	R	1.25	0.049	0.008	●													0.079	0.157
TCG18L125-020	L	1.25	0.049	0.008	●													0.079	0.157
TCG18R130-020	R	1.3	0.051	0.008	●													0.079	0.157
TCG18L130-020	L	1.3	0.051	0.008	●													0.079	0.157
TCG18R140-010	R	1.4	0.055	0.004	●													0.138	0.157
TCG18L140-010	L	1.4	0.055	0.004	●													0.138	0.157
TCG18R140-020	R	1.4	0.055	0.008	●													0.138	0.157
TCG18L140-020	L	1.4	0.055	0.008	●													0.138	0.157
TCG18R145-010	R	1.45	0.057	0.004	●													0.138	0.157
TCG18L145-010	L	1.45	0.057	0.004	●													0.138	0.157
TCG18R145-020	R	1.45	0.057	0.008	●													0.138	0.157
TCG18L145-020	L	1.45	0.057	0.008	●													0.138	0.157
TCG18R150-010	R	1.5	0.059	0.004	●													0.138	0.157
TCG18L150-010	L	1.5	0.059	0.004	●													0.138	0.157
TCG18R150-020	R	1.5	0.059	0.008	●													0.138	0.157
TCG18L150-020	L	1.5	0.059	0.008	●													0.138	0.157
TCG18R160-020	R	1.6	0.063	0.008	●													0.138	0.157
TCG18L160-020	L	1.6	0.063	0.008	●													0.138	0.157
TCG18R170-020	R	1.7	0.067	0.008	●													0.138	0.157
TCG18L170-020	L	1.7	0.067	0.008	●													0.138	0.157
TCG18R175-010	R	1.75	0.069	0.004	●													0.138	0.157
TCG18L175-010	L	1.75	0.069	0.004	●													0.138	0.157
TCG18R175-020	R	1.75	0.069	0.008	●													0.138	0.157
TCG18L175-020	L	1.75	0.069	0.008	●													0.138	0.157
TCG18R185-020	R	1.85	0.073	0.008	●													0.138	0.157
TCG18L185-020	L	1.85	0.073	0.008	●													0.138	0.157
TCG18R195-020	R	1.95	0.077	0.008	●													0.138	0.157
TCG18L195-020	L	1.95	0.077	0.008	●													0.138	0.157

See page G089 for precautions of processing.

5 pieces per package

● : Line up

Reference pages: Toolholders → G080 - G081, Standard cutting conditions → G089 - G090

P	Steel	★			
M	Stainless	★			
K	Cast iron	★			
N	Non-ferrous				
S	Superalloys	★			
H	Hard materials				

★ : First choice
 ☆ : Second choice

Designation	HAND	CW±0.02 (mm)	CW±0.001 (in)	RE (in)	Coated					CDX (in)	S (in)	
					AH7025							
TCG18R200-010	R	2	0.079	0.004	●						0.138	0.157
TCG18L200-010	L	2	0.079	0.004	●						0.138	0.157
TCG18R200-020	R	2	0.079	0.008	●						0.138	0.157
TCG18L200-020	L	2	0.079	0.008	●						0.138	0.157
TCG18R225-020	R	2.25	0.089	0.008	●						0.138	0.157
TCG18L225-020	L	2.25	0.089	0.008	●						0.138	0.157
TCG18R230-020	R	2.3	0.091	0.008	●						0.138	0.157
TCG18L230-020	L	2.3	0.091	0.008	●						0.138	0.157
TCG18R250-010	R	2.5	0.098	0.004	●						0.138	0.157
TCG18L250-010	L	2.5	0.098	0.004	●						0.138	0.157
TCG18R250-020	R	2.5	0.098	0.008	●						0.138	0.157
TCG18L250-020	L	2.5	0.098	0.008	●						0.138	0.157
TCG18R250-030	R	2.5	0.098	0.012	●						0.138	0.157
TCG18L250-030	L	2.5	0.098	0.012	●						0.138	0.157
TCG18R265-030	R	2.65	0.104	0.012	●						0.138	0.157
TCG18L265-030	L	2.65	0.104	0.012	●						0.138	0.157
TCG18R280-030	R	2.8	0.110	0.012	●						0.138	0.157
TCG18L280-030	L	2.8	0.110	0.012	●						0.138	0.157
TCG18R300-010	R	3	0.118	0.004	●						0.138	0.157
TCG18L300-010	L	3	0.118	0.004	●						0.138	0.157
TCG18R300-020	R	3	0.118	0.008	●						0.138	0.157
TCG18L300-020	L	3	0.118	0.008	●						0.138	0.157
TCG18R300-030	R	3	0.118	0.012	●						0.138	0.157
TCG18L300-030	L	3	0.118	0.012	●						0.138	0.157

See page G089 for precautions of processing.

5 pieces per package
 ● : Line up

INSERT

TCP18R/L (lightly honed edge)

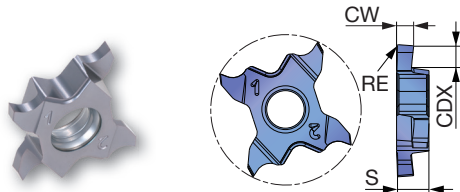

P	Steel	★			
M	Stainless	★			
K	Cast iron	★			
N	Non-ferrous				
S	Superalloys	★			
H	Hard materials				

★ : First choice
☆ : Second choice

Designation	HAND	CW±0.02 (mm)	CW±0.001 (in)	RE (in)	Coated					CDX (in)	S (in)	
					AH725							
TCP18R033-005	R	0.33	0.013	0.002	●						0.031	0.157
TCP18L033-005	L	0.33	0.013	0.002	●						0.031	0.157
TCP18R043-005	R	0.43	0.017	0.002	●						0.047	0.157
TCP18L043-005	L	0.43	0.017	0.002	●						0.047	0.157
TCP18R050-005	R	0.50	0.020	0.002	●						0.047	0.157
TCP18L050-005	L	0.50	0.020	0.002	●						0.047	0.157
TCP18R075-005	R	0.75	0.030	0.002	●						0.079	0.157
TCP18L075-005	L	0.75	0.030	0.002	●						0.079	0.157
TCP18R095-005	R	0.95	0.037	0.002	●						0.079	0.157
TCP18L095-005	L	0.95	0.037	0.002	●						0.079	0.157
TCP18R100-010	R	1	0.039	0.004	●						0.079	0.157
TCP18L100-010	L	1	0.039	0.004	●						0.079	0.157
TCP18R120-010	R	1.2	0.047	0.004	●						0.079	0.157
TCP18L120-010	L	1.2	0.047	0.004	●						0.079	0.157
TCP18R125-010	R	1.25	0.049	0.004	●						0.079	0.157
TCP18L125-010	L	1.25	0.049	0.004	●						0.079	0.157
TCP18R140-010-35	R	1.4	0.055	0.004	●						0.138	0.157
TCP18L140-010-35	L	1.4	0.055	0.004	●						0.138	0.157
TCP18R145-010	R	1.45	0.057	0.004	●						0.079	0.157
TCP18L145-010	L	1.45	0.057	0.004	●						0.079	0.157
TCP18R145-010-35	R	1.45	0.057	0.004	●						0.138	0.157
TCP18L145-010-35	L	1.45	0.057	0.004	●						0.138	0.157
TCP18R150-010	R	1.5	0.059	0.004	●						0.079	0.157
TCP18L150-010	L	1.5	0.059	0.004	●						0.079	0.157
TCP18R150-010-35	R	1.5	0.059	0.004	●						0.138	0.157
TCP18L150-010-35	L	1.5	0.059	0.004	●						0.138	0.157
TCP18R175-010	R	1.75	0.069	0.004	●						0.079	0.157
TCP18L175-010	L	1.75	0.069	0.004	●						0.079	0.157
TCP18R175-010-35	R	1.75	0.069	0.004	●						0.138	0.157
TCP18L175-010-35	L	1.75	0.069	0.004	●						0.138	0.157
TCP18R200-010	R	2	0.079	0.004	●						0.098	0.157
TCP18L200-010	L	2	0.079	0.004	●						0.098	0.157
TCP18R200-010-35	R	2	0.079	0.004	●						0.138	0.157
TCP18L200-010-35	L	2	0.079	0.004	●						0.138	0.157
TCP18R250-010	R	2.5	0.098	0.004	●						0.098	0.157
TCP18L250-010	L	2.5	0.098	0.004	●						0.098	0.157
TCP18R250-010-35	R	2.5	0.098	0.004	●						0.138	0.157
TCP18L250-010-35	L	2.5	0.098	0.004	●						0.138	0.157
TCP18R300-010	R	3	0.118	0.004	●						0.098	0.157
TCP18L300-010	L	3	0.118	0.004	●						0.098	0.157
TCP18R300-010-35	R	3	0.118	0.004	●						0.138	0.157
TCP18L300-010-35	L	3	0.118	0.004	●						0.138	0.157

See page G089 for precautions of processing.

5 pieces per package

● : Line up

Reference pages: Toolholders → G080 - G081, Standard cutting conditions → G089 - G090

TCP18R/L-F (sharp edge)

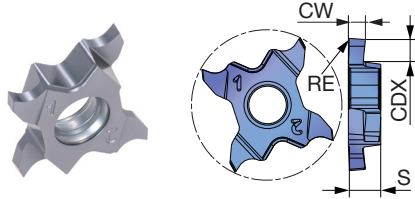

P	Steel	★			
M	Stainless	★			
K	Cast iron	★			
N	Non-ferrous				
S	Superalloys	★			
H	Hard materials				

★ : First choice
☆ : Second choice

Designation	HAND	CW±0.02 (mm)	CW±0.001 (in)	RE (in)	Coated								CDX (in)	S (in)		
					SH725											
TCP18R033F-005	R	0.33	0.013	0.002	●										0.031	0.157
TCP18L033F-005	L	0.33	0.013	0.002	●										0.031	0.157
TCP18R043F-005	R	0.43	0.017	0.002	●										0.047	0.157
TCP18L043F-005	L	0.43	0.017	0.002	●										0.047	0.157
TCP18R050F-005	R	0.5	0.020	0.002	●										0.047	0.157
TCP18L050F-005	L	0.5	0.020	0.002	●										0.047	0.157
TCP18R075F-005	R	0.75	0.030	0.002	●										0.079	0.157
TCP18L075F-005	L	0.75	0.030	0.002	●										0.079	0.157
TCP18R095F-005	R	0.95	0.037	0.002	●										0.079	0.157
TCP18L095F-005	L	0.95	0.037	0.002	●										0.079	0.157
TCP18R100F-005	R	1	0.039	0.002	●										0.079	0.157
TCP18R100F-010	R	1	0.039	0.004	●										0.079	0.157
TCP18L100F-010	L	1	0.039	0.004	●										0.079	0.157
TCP18R120F-005	R	1.2	0.047	0.002	●										0.079	0.157
TCP18R120F-010	R	1.2	0.047	0.004	●										0.079	0.157
TCP18L120F-010	L	1.2	0.047	0.004	●										0.079	0.157
TCP18R125F-005	R	1.25	0.049	0.002	●										0.079	0.157
TCP18R125F-010	R	1.25	0.049	0.004	●										0.079	0.157
TCP18L125F-010	L	1.25	0.049	0.004	●										0.079	0.157
TCP18R140F-010-35	R	1.4	0.055	0.004	●										0.138	0.157
TCP18R145F-005-35	R	1.45	0.057	0.002	●										0.138	0.157
TCP18R145F-010	R	1.45	0.057	0.004	●										0.079	0.157
TCP18L145F-010	L	1.45	0.057	0.004	●										0.079	0.157
TCP18R145F-010-35	R	1.45	0.057	0.004	●										0.138	0.157
TCP18R145F-010-35	L	1.45	0.057	0.004	●										0.138	0.157
TCP18R150F-005-35	R	1.5	0.059	0.002	●										0.138	0.157
TCP18R150F-010	R	1.5	0.059	0.004	●										0.079	0.157
TCP18L150F-010	L	1.5	0.059	0.004	●										0.079	0.157
TCP18R150F-010-35	R	1.5	0.059	0.004	●										0.138	0.157
TCP18L150F-010-35	L	1.5	0.059	0.004	●										0.138	0.157
TCP18R175F-005-35	R	1.75	0.069	0.002	●										0.138	0.157
TCP18R175F-010	R	1.75	0.069	0.004	●										0.079	0.157
TCP18L175F-010	L	1.75	0.069	0.004	●										0.079	0.157
TCP18R175F-010-35	R	1.75	0.069	0.004	●										0.138	0.157
TCP18L175F-010-35	L	1.75	0.069	0.004	●										0.138	0.157
TCP18R200F-005-35	R	2	0.079	0.002	●										0.138	0.157
TCP18R200F-010	R	2	0.079	0.004	●										0.098	0.157
TCP18L200F-010	L	2	0.079	0.004	●										0.098	0.157
TCP18R200F-010-35	R	2	0.079	0.004	●										0.138	0.157
TCP18L200F-010-35	L	2	0.079	0.004	●										0.138	0.157
TCP18R250F-010	R	2.5	0.098	0.004	●										0.098	0.157
TCP18L250F-010	L	2.5	0.098	0.004	●										0.098	0.157
TCP18R250F-010-35	R	2.5	0.098	0.004	●										0.138	0.157
TCP18L250F-010-35	L	2.5	0.098	0.004	●										0.138	0.157
TCP18R300F-010	R	3	0.118	0.004	●										0.098	0.157
TCP18L300F-010	L	3	0.118	0.004	●										0.098	0.157
TCP18R300F-010-35	R	3	0.118	0.004	●										0.138	0.157
TCP18L300F-010-35	L	3	0.118	0.004	●										0.138	0.157

See page G089 for precautions of processing.

5 pieces per package

● : Line up

Reference pages: Toolholders → G080 - G081, Standard cutting conditions → G089 - G090

INSERT

TCT18R/L (for threading)

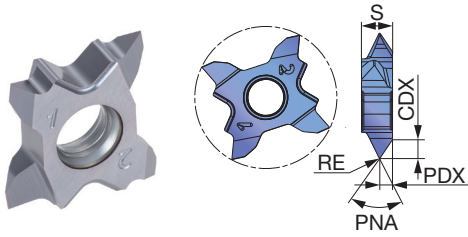

P	Steel	★			
M	Stainless	★			
K	Cast iron	★			
N	Non-ferrous				
S	Superalloys	★			
H	Hard materials				

★ : First choice
☆ : Second choice

Designation	HAND	RE (in)	Coated			Pitch min		Pitch max		PDX (in)	CDX (in)	PNA	S (in)
			AH725			(in)	(mm)	(in)	(mm)				
TCT18R-60N-010	R	0.004	●			0.031	0.8	0.118	3	0.063	0.105	60°	0.157
TCT18L-60N-010	L	0.004	●			0.031	0.8	0.118	3	0.063	0.105	60°	0.157
TCT18R-60N-020	R	0.008	●			0.031	0.8	0.118	3	0.063	0.101	60°	0.157
TCT18L-60N-020	L	0.008	●			0.031	0.8	0.118	3	0.063	0.101	60°	0.157

● : Line up

TCT18FR (sharp edge for threading)

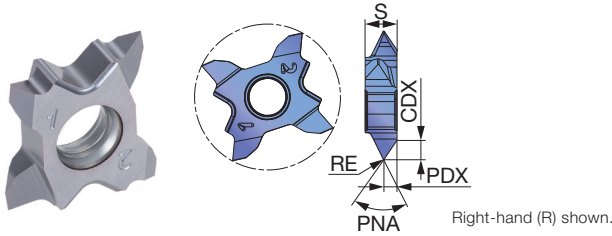

P	Steel	★			
M	Stainless	★			
K	Cast iron	★			
N	Non-ferrous				
S	Superalloys	★			
H	Hard materials				

★ : First choice
☆ : Second choice

Designation	HAND	RE (in)	Coated			Pitch min		Pitch max		PDX (in)	CDX (in)	PNA	S (in)
			SH725			(in)	(mm)	(in)	(mm)				
TCT18FR-60A-005	R	0.004	●			0.016	0.4	0.039	1	0.024	0.039	60°	0.157
TCT18FR-60A-010	L	0.004	●			0.039	1	0.079	2	0.039	0.064	60°	0.157

● : Line up

PRECAUTIONS OF PROCESSING

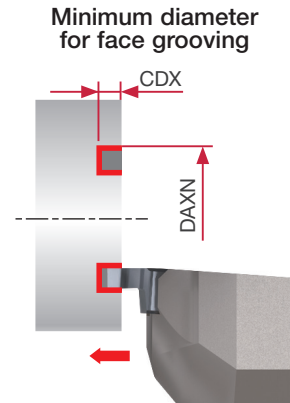
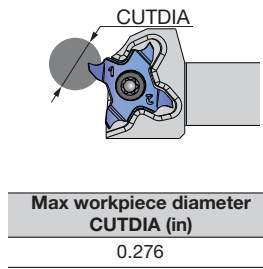
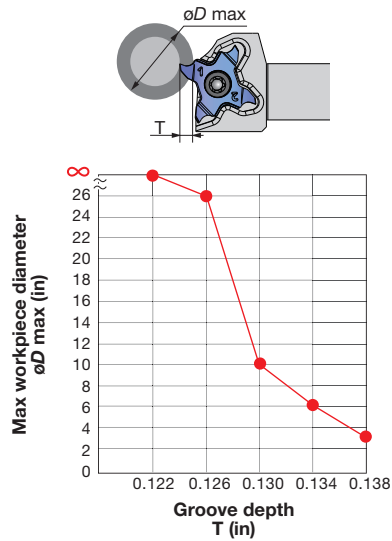

*Groove depth and max workpiece diameter (øD max)

Maximum workpiece diameter is limited relative to depth of cut in order to avoid collision between insert and workpiece.

STANDARD CUTTING CONDITIONS

TCS18R (3D chipbreaker), TCG18R/L (honed edge)

ISO	Workpiece materials	Grades	Cutting speed Vc (sfm)	Feed: f (ipr)	
				TCG	TCS
P	Low carbon steel 1015, etc.	AH7025	262 - 591	0.001 - 0.005	0.001 - 0.006
	Carbon steel, Alloy steel 1055, etc.	AH7025	262 - 591	0.001 - 0.005	0.001 - 0.006
	Prehardened steel NAK80, PX5, etc.	AH7025	262 - 591	0.001 - 0.005	0.001 - 0.006
M	Stainless steel S30400, etc.	AH7025	164 - 394	0.001 - 0.005	0.001 - 0.006
K	Gray cast iron No.250B, No.300B, etc.	AH7025	164 - 591	0.001 - 0.005	0.001 - 0.006
	Ductile cast iron 60-40-18, 80-55-06, etc.	AH7025	164 - 591	0.001 - 0.005	0.001 - 0.006
S	Titanium alloys Ti-6Al-4V, etc.	AH7025	98 - 262	0.001 - 0.005	0.001 - 0.006
	Superalloys Inconel718, etc.	AH7025	66 - 197	0.001 - 0.005	0.001 - 0.006

TCP18R/L (lightly honed edge) / TCP18R/L-F (sharp edge)

ISO	Workpiece materials	Priority	Grades	Cutting speed Vc (sfm)	Feed f (ipr)
P	Low carbon steel 1015, etc.	First choice	SH725	262 - 591	0.001 - 0.004
		Toughness	AH725	262 - 591	0.001 - 0.004
	Carbon steel, Alloy steel 1055, etc.	First choice	SH725	262 - 591	0.001 - 0.004
		Toughness	AH725	262 - 591	0.001 - 0.004
M	Prehardened steel NAK80, PX5, etc.	First choice	SH725	262 - 591	0.001 - 0.004
		Toughness	AH725	262 - 591	0.001 - 0.004
	Stainless steel S30400, etc.	First choice	SH725	164 - 394	0.001 - 0.004
		Toughness	AH725	164 - 394	0.001 - 0.004
K	Gray cast iron No.250B, No.300B, etc.	First choice	AH725	164 - 591	0.001 - 0.004
		Sharpness	SH725	164 - 591	0.001 - 0.004
	Ductile cast iron 60-40-18, 80-55-06, etc.	First choice	AH725	164 - 591	0.001 - 0.004
		Sharpness	SH725	164 - 591	0.001 - 0.004
S	Titanium alloys Ti-6Al-4V, etc.	First choice	SH725	98 - 262	0.001 - 0.004
		Toughness	AH725	98 - 262	0.001 - 0.004
	Superalloys Inconel718, etc.	First choice	SH725	66 - 197	0.001 - 0.004
		Toughness	AH725	66 - 197	0.001 - 0.004

STANDARD CUTTING CONDITIONS

TCT18R/L (for threading / lightly honed edge) / TCT18FR (for threading / sharp edge)

ISO	Workpiece material	Priority	Grades	Cutting speed Vc (sfm)	Pitch (in)	TPI
P	Low carbon steel 1015, etc.	First choice	SH725	197 - 492	0.016 - 0.079	64 - 12
		Toughness	AH725	197 - 492	0.031 - 0.118	32 - 8
	Carbon steel, Alloy steel 1055, etc.	First choice	SH725	197 - 492	0.016 - 0.079	64 - 12
		Toughness	AH725	197 - 492	0.031 - 0.118	32 - 8
M	Prehardened steel NAK80, PX5, etc.	First choice	SH725	197 - 492	0.016 - 0.079	64 - 12
		Toughness	AH725	197 - 492	0.031 - 0.118	32 - 8
K	Gray cast iron No.250B, No.300B, etc.	First choice	AH725	164 - 328	0.031 - 0.118	32 - 8
		Sharpness	SH725	164 - 328	0.016 - 0.079	64 - 12
	Ductile cast iron 60-40-18, 80-55-06, etc.	First choice	AH725	164 - 328	0.031 - 0.118	32 - 8
		Sharpness	SH725	164 - 328	0.016 - 0.079	64 - 12
S	Titanium alloys Ti-6Al-4V, etc.	First choice	SH725	98 - 328	0.016 - 0.079	64 - 12
		Toughness	AH725	98 - 328	0.031 - 0.118	32 - 8
	Superalloys Inconel718, etc.	First choice	SH725	98 - 328	0.016 - 0.079	64 - 12
		Toughness	AH725	98 - 328	0.031 - 0.118	32 - 8

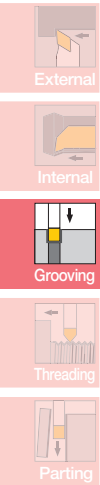

TETRAFORCE STCR/L-27

External grooving toolholder

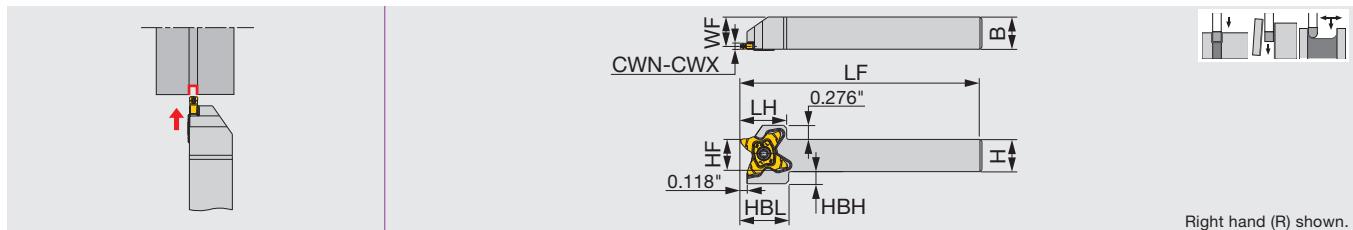

Inch	CWN	CWX	H	B	LF	LH	HBL	HF	WF	HBH	Insert	Torque
STCR/L06-27	0.02	0.125	0.375	0.375	5.000	0.906	0.945	0.375	0.315	0.374	TC*27...	1.84
STCR/L08-27	0.02	0.125	0.500	0.500	5.000	0.906	0.945	0.500	0.440	0.287	TC*27...	1.84
STCR/L10-27	0.02	0.125	0.625	0.625	5.000	0.906	0.945	0.625	0.570	0.236	TC*27...	1.84
STCR/L12-27	0.02	0.125	0.750	0.750	5.000	0.906	0.945	0.750	0.690	0.118	TC*27...	1.84
STCR/L16-27	0.02	0.125	1.000	1.000	5.000	0.906	-	1.000	0.940	-	TC*27...	1.84

Torque: Recommended clamping torque: lbs-ft

SPARE PARTS

Designation	Screw	Wrench
STCR**-27	SR16-212-01397L	T-2010/5
STCL**-27	SR16-212-01397	T-2010/5

Reference pages: STCR/L-27:

Inserts → **G092 - G095**, Standard cutting conditions → **G095**

Grooving and parting-off tool with high pressure coolant capability

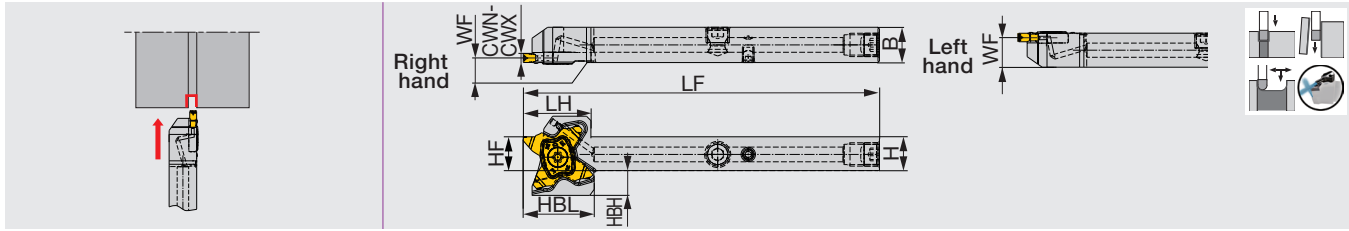

Inch	CWN	CWX	H	B	LF	LH	HF	WF ⁽¹⁾	HBH	HBL	Insert	Torque
STCR/L08-27-CHP	0.020	0.125	0.500	0.500	4.750	0.906	0.500	0.590/0.441	0.287	0.945	TC*27...	1.84

Make sure to avoid tool interferences when used on Swiss machines

Torque: Recommended clamping torque: lb-ft

(1) The above WF value is valid when an insert width of CW=3 is mounted.

SPARE PARTS

Designation	Screw	Wrench
STCR*-27-CHP	SR16-212-01397L	T-2010/5
STCL*-27-CHP	SR16-212-01397	T-2010/5

External grooving and parting-off toolholder, high pressure coolant compatible

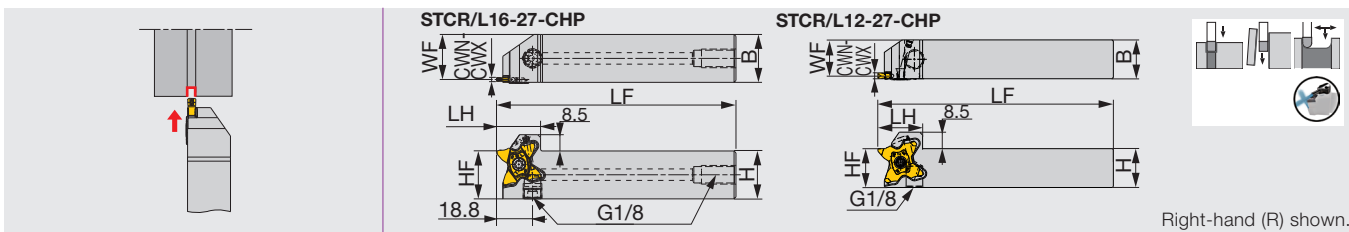

Inch	CWN	CWX	H	B	LF	LH	HF	WF	Insert	Torque
STCR/L12-27-CHP	0.02	0.125	0.750	0.750	5.000	0.906	0.750	0.690	TC*27...	1.84
STCR/L16-27-CHP	0.02	0.125	1.000	1.000	4.920	0.906	1.000	0.940	TC*27...	1.84

Torque: Recommended clamping torque: lbs-ft

SPARE PARTS

Designation	Screw	Wrench
STCR*-27-CHP	SR16-212-01397L	T-2010/5
STCL*-27-CHP	SR16-212-01397	T-2010/5

Reference pages: STCR/L08-27-CHP, STCR/L12/16-27-CHP:

Inserts → **G092 - G095**, Standard cutting conditions → **G095**

INSERT - FOR GROOVING AND PARTING OFF

TCS27

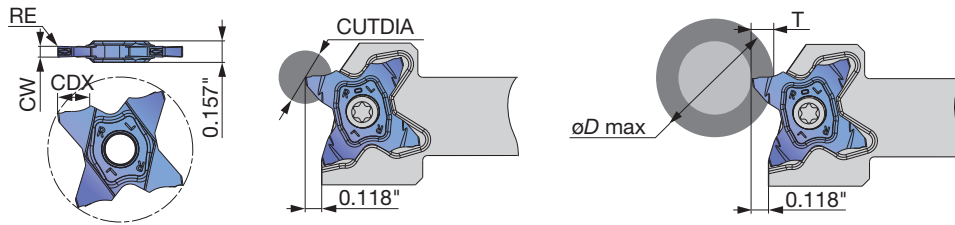

P	Steel	★
M	Stainless	★
K	Cast iron	★
N	Non-ferrous	★
S	Superalloys	★
H	Hard materials	★

★ : First choice
☆ : Second choice

Designation	CW±0.02 (mm)	CW±0.001 (in)	RE (in)	Coated AH725	CDX (in)	CUTDIA (in)	Relation of groove depth (T) and Max. diameter (øD max) (in)												
							T≤0.039	T≤0.079	T≤0.118	T≤0.138	T≤0.157	T≤0.177	T≤0.197	T≤0.217	T≤0.224	T≤0.236	T≤0.244	T≤0.252	
							TCS27-050-000	0.5	0.020	0	●	0.039	0.079	∞	-	-	-	-	-
TCS27-050-004	0.5	0.020	0.0016	●	0.098	0.197	∞	∞	-	-	-	-	-	-	-	-	-	-	-
TCS27-075-010	0.75	0.030	0.004	●	0.098	0.197	∞	∞	-	-	-	-	-	-	-	-	-	-	-
TCS27-080-000	0.8	0.031	0	●	0.063	0.126	∞	-	-	-	-	-	-	-	-	-	-	-	-
TCS27-100-006	1	0.039	0.0024	●	0.138	0.276	∞	∞	∞	23.622	-	-	-	-	-	-	-	-	-
TCS27-100-010	1	0.039	0.004	●	0.138	0.276	∞	∞	∞	23.622	-	-	-	-	-	-	-	-	-
TCS27-104-000	1.04	0.041	0	●	0.079	0.157	∞	∞	-	-	-	-	-	-	-	-	-	-	-
TCS27-120-000	1.2	0.047	0	●	0.079	0.157	∞	∞	-	-	-	-	-	-	-	-	-	-	-
TCS27-125-010	1.25	0.049	0.004	●	0.138	0.276	∞	∞	∞	23.622	-	-	-	-	-	-	-	-	-
TCS27-125-020	1.25	0.049	0.008	●	0.138	0.276	∞	∞	∞	23.622	-	-	-	-	-	-	-	-	-
TCS27-140-000	1.4	0.055	0	●	0.079	0.157	∞	∞	-	-	-	-	-	-	-	-	-	-	-
TCS27-147-000	1.47	0.058	0	●	0.098	0.197	∞	∞	-	-	-	-	-	-	-	-	-	-	-
TCS27-150-010	1.5	0.059	0.004	●	0.224	0.449	∞	∞	∞	23.622	11.024	7.087	5.118	1.969	1.378	-	-	-	-
TCS27-150-020	1.5	0.059	0.008	●	0.224	0.449	∞	∞	∞	23.622	11.024	7.087	5.118	1.969	1.378	-	-	-	-
TCS27-157-015	1.57	0.062	0.006	●	0.118	0.236	∞	∞	∞	-	-	-	-	-	-	-	-	-	-
TCS27-170-010	1.7	0.067	0.004	●	0.118	0.236	∞	∞	∞	-	-	-	-	-	-	-	-	-	-
TCS27-175-010	1.75	0.069	0.004	●	0.118	0.236	∞	∞	∞	-	-	-	-	-	-	-	-	-	-
TCS27-175-020	1.75	0.069	0.008	●	0.118	0.236	∞	∞	∞	-	-	-	-	-	-	-	-	-	-
TCS27-178-018	1.78	0.070	0.007	●	0.118	0.236	∞	∞	∞	-	-	-	-	-	-	-	-	-	-
TCS27-185-020	1.85	0.073	0.008	●	0.118	0.236	∞	∞	∞	-	-	-	-	-	-	-	-	-	-
TCS27-196-015	1.96	0.077	0.006	●	0.118	0.236	∞	∞	∞	-	-	-	-	-	-	-	-	-	-
TCS27-200-010	2	0.079	0.004	●	0.252	0.504	∞	∞	∞	23.622	11.024	7.087	5.118	4.134	3.346	2.362	1.969	1.181	-
TCS27-200-020	2	0.079	0.008	●	0.252	0.504	∞	∞	∞	23.622	11.024	7.087	5.118	4.134	3.346	2.362	1.969	1.181	-
TCS27-222-015	2.22	0.087	0.006	●	0.138	0.276	∞	∞	∞	23.622	-	-	-	-	-	-	-	-	-
TCS27-230-020	2.3	0.091	0.008	●	0.138	0.276	∞	∞	∞	23.622	-	-	-	-	-	-	-	-	-
TCS27-239-015	2.39	0.094	0.006	●	0.224	0.449	∞	∞	∞	23.622	11.024	7.087	5.118	1.969	1.378	-	-	-	-
TCS27-247-020	2.47	0.097	0.008	●	0.224	0.449	∞	∞	∞	23.622	11.024	7.087	5.118	1.969	1.378	-	-	-	-
TCS27-250-010	2.5	0.098	0.004	●	0.224	0.449	∞	∞	∞	23.622	11.024	7.087	5.118	1.969	1.378	-	-	-	-
TCS27-250-030	2.5	0.098	0.012	●	0.224	0.449	∞	∞	∞	23.622	11.024	7.087	5.118	1.969	1.378	-	-	-	-
TCS27-270-010	2.7	0.106	0.004	●	0.244	0.488	∞	∞	∞	23.622	11.024	7.087	5.315	4.134	3.740	3.346	3.071	-	-
TCS27-287-020	2.87	0.113	0.008	●	0.244	0.488	∞	∞	∞	23.622	11.024	7.087	5.315	4.134	3.740	3.346	3.071	-	-
TCS27-300-000	3	0.118	0	●	0.252	0.504	∞	∞	∞	23.622	11.024	7.087	5.315	4.134	3.740	3.346	3.071	2.165	-
TCS27-300-020	3	0.118	0.008	●	0.252	0.504	∞	∞	∞	23.622	11.024	7.087	5.315	4.134	3.740	3.346	3.071	2.165	-
TCS27-300-030	3	0.118	0.012	●	0.252	0.504	∞	∞	∞	23.622	11.024	7.087	5.315	4.134	3.740	3.346	3.071	2.165	-
TCS27-300-040	3	0.118	0.016	●	0.252	0.504	∞	∞	∞	23.622	11.024	7.087	5.315	4.134	3.740	3.346	3.071	2.165	-
TCS27-315-015	3.15	0.124	0.006	●	0.252	0.504	∞	∞	∞	23.622	11.024	7.087	5.315	4.134	3.740	3.346	3.071	2.677	-
TCS27-318-020	3.18	0.125	0.008	●	0.252	0.504	∞	∞	∞	23.622	11.024	7.087	5.315	4.134	3.740	3.346	3.071	2.677	-

5 pieces per package
● : Line up

Reference pages: Toolholders → G090 - G091, Standard cutting conditions → G095

INSERT- FOR PARTING OFF

TCS27-R/L

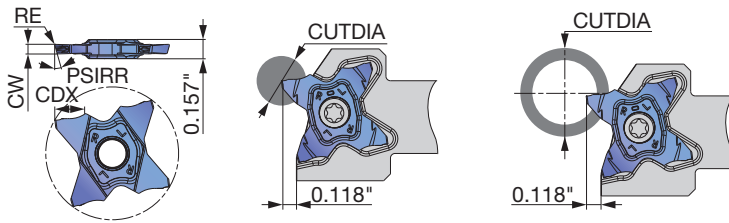

Right hand (R) shown.

P	Steel	★		
M	Stainless	★		
K	Cast iron	★		
N	Non-ferrous			
S	Superalloys	★		
H	Hard materials			

★ : First choice
☆ : Second choice

Designation	HAND	CW±0.02 (mm)	CW±0.001 (in)	RE (in)	Coated		CDX (in)	PSIRL	PSIRR	Max. parting off dia. CUTDIA (in)	
					AH725					Solid bar	Tube
TCS27-100-15R	R	1	0.039	0.0024	●		0.138	0°	15°	0.276	23.622
TCS27-100-15L	L	1	0.039	0.0024	●		0.138	15°	0°	0.276	23.622
TCS27-150-6R	R	1.5	0.059	0.0024	●		0.224	0°	6°	0.449	1.378
TCS27-150-6L	L	1.5	0.059	0.0024	●		0.224	6°	0°	0.449	1.378
TCS27-150-15R	R	1.5	0.059	0.0024	●		0.224	0°	15°	0.449	1.378
TCS27-150-15L	L	1.5	0.059	0.0024	●		0.224	15°	0°	0.449	1.378
TCS27-200-6R	R	2	0.079	0.004	●		0.252	0°	6°	0.504	1.181
TCS27-200-6L	L	2	0.079	0.004	●		0.252	6°	0°	0.504	1.181
TCS27-200-15R	R	2	0.079	0.004	●		0.252	0°	15°	0.504	1.181
TCS27-200-15L	L	2	0.079	0.004	●		0.252	15°	0°	0.504	1.181

5 pieces per package
● : Line up

INSERT- FOR GROOVING AND PROFILING

TCS27 (Full R)

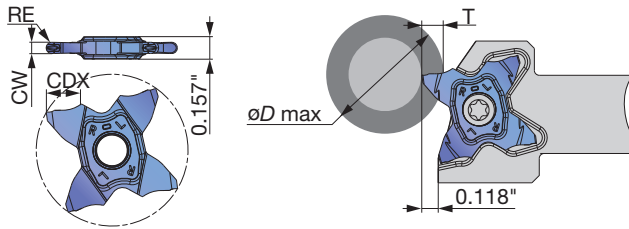

P	Steel	★		
M	Stainless	★		
K	Cast iron	★		
N	Non-ferrous			
S	Superalloys	★		
H	Hard materials			

★ : First choice
☆ : Second choice

Designation	CW±0.02 (mm)	CW±0.001 (in)	RE (in)	Coated		CDX (in)	Relation of groove depth (T) and Max. diameter (øD max) (in)											
				AH725			T≤0.039	T≤0.079	T≤0.118	T≤0.138	T≤0.157	T≤0.177	T≤0.197	T≤0.217	T≤0.224	T≤0.236	T≤0.244	T≤0.252
TCS27-157-079	1.57	0.062	0.031	●		0.118	∞	-	-	-	-	-	-	-	-	-	-	
TCS27-200-100	2	0.079	0.039	●		0.118	∞	-	-	-	-	-	-	-	-	-	-	
TCS27-239-120	2.39	0.094	0.047	●		0.224	∞	23.622	11.024	7.087	5.118	1.969	1.378	-	-	-	-	
TCS27-300-150	3	0.118	0.059	●		0.252	∞	23.622	11.024	7.087	5.315	4.134	3.740	3.346	3.071	2.165		

5 pieces per package
● : Line up

Reference pages: Toolholders → **G090 - G091**, Standard cutting conditions → **G095**

Grade
Insert
Ext. Toolholder
Int. Toolholder
Threading
Grooving
Miniature Tool
Milling Cutter
Endmill
Drilling Tool
User's Guide Tooling System
Index



INSERT- FOR GROOVING AND PARTING OFF

TCM27

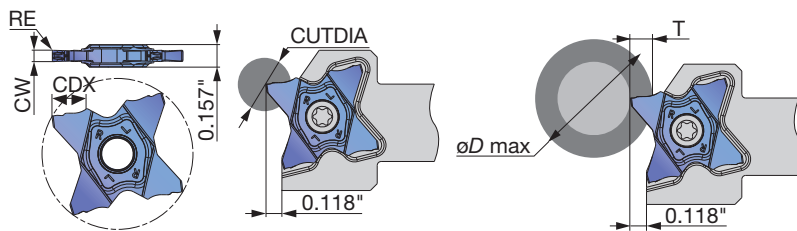

P	Steel	★	
M	Stainless	★	
K	Cast iron	★	
N	Non-ferrous		
S	Superalloys	★	
H	Hard materials		

★ : First choice
☆ : Second choice

Designation	CW±0.02 (mm)	CW±0.001 (in)	RE (in)	Coated		CDX (in)	CUTDIA (in)	Relation of groove depth (T) and Max. diameter (øD max) (in)									
				AH725				T≤0.039	T≤0.138	T≤0.157	T≤0.177	T≤0.197	T≤0.217	T≤0.224	T≤0.236	T≤0.244	T≤0.252
								T≤0.079	T≤0.118								
TCM27-150-010	1.5	0.059	0.004	●		0.224	0.449	∞	23.622	11.024	7.087	5.118	1.969	1.378	-	-	-
TCM27-150-020	1.5	0.059	0.008	●		0.224	0.449	∞	23.622	11.024	7.087	5.118	1.969	1.378	-	-	-
TCM27-157-015	1.57	0.062	0.006	●		0.118	0.236	∞	-	-	-	-	-	-	-	-	-
TCM27-170-010	1.7	0.067	0.004	●		0.118	0.236	∞	-	-	-	-	-	-	-	-	-
TCM27-175-010	1.75	0.069	0.004	●		0.118	0.236	∞	-	-	-	-	-	-	-	-	-
TCM27-175-020	1.75	0.069	0.008	●		0.118	0.236	∞	-	-	-	-	-	-	-	-	-
TCM27-178-018	1.78	0.070	0.007	●		0.118	0.236	∞	-	-	-	-	-	-	-	-	-
TCM27-185-020	1.85	0.073	0.008	●		0.118	0.236	∞	-	-	-	-	-	-	-	-	-
TCM27-196-015	1.96	0.077	0.006	●		0.118	0.236	∞	-	-	-	-	-	-	-	-	-
TCM27-200-010	2	0.079	0.004	●		0.252	0.504	∞	23.622	11.024	7.087	5.118	4.134	3.346	2.362	1.969	1.181
TCM27-200-020	2	0.079	0.008	●		0.252	0.504	∞	23.622	11.024	7.087	5.118	4.134	3.346	2.362	1.969	1.181
TCM27-222-015	2.22	0.087	0.006	●		0.138	0.276	∞	23.622	-	-	-	-	-	-	-	-
TCM27-230-020	2.3	0.091	0.008	●		0.138	0.276	∞	23.622	-	-	-	-	-	-	-	-
TCM27-239-015	2.39	0.094	0.006	●		0.224	0.449	∞	23.622	11.024	7.087	5.118	1.969	1.378	-	-	-
TCM27-247-020	2.47	0.097	0.008	●		0.224	0.449	∞	23.622	11.024	7.087	5.118	1.969	1.378	-	-	-
TCM27-250-010	2.5	0.098	0.004	●		0.224	0.449	∞	23.622	11.024	7.087	5.118	1.969	1.378	-	-	-
TCM27-250-030	2.5	0.098	0.012	●		0.224	0.449	∞	23.622	11.024	7.087	5.118	1.969	1.378	-	-	-
TCM27-270-010	2.7	0.106	0.004	●		0.244	0.488	∞	23.622	11.024	7.087	5.315	4.134	3.740	3.346	3.071	-
TCM27-287-020	2.87	0.113	0.008	●		0.244	0.488	∞	23.622	11.024	7.087	5.315	4.134	3.740	3.346	3.071	-
TCM27-300-000	3	0.118	0	●		0.252	0.504	∞	23.622	11.024	7.087	5.315	4.134	3.740	3.346	3.071	2.165
TCM27-300-020	3	0.118	0.008	●		0.252	0.504	∞	23.622	11.024	7.087	5.315	4.134	3.740	3.346	3.071	2.165
TCM27-300-030	3	0.118	0.012	●		0.252	0.504	∞	23.622	11.024	7.087	5.315	4.134	3.740	3.346	3.071	2.165
TCM27-300-040	3	0.118	0.016	●		0.252	0.504	∞	23.622	11.024	7.087	5.315	4.134	3.740	3.346	3.071	2.165
TCM27-315-015	3.15	0.124	0.006	●		0.252	0.504	∞	23.622	11.024	7.087	5.315	4.134	3.740	3.346	3.071	2.677
TCM27-318-020	3.18	0.125	0.008	●		0.252	0.504	∞	23.622	11.024	7.087	5.315	4.134	3.740	3.346	3.071	2.677

5 pieces per package

● : Line up

Reference pages: Toolholders → G090 - G091, Standard cutting conditions → G095

INSERT - FOR GROOVING AND PROFILING

TCM27 (Full R)

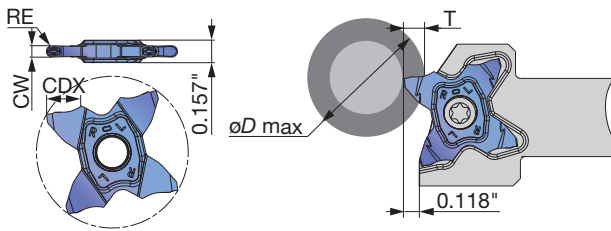

P	Steel	★		
M	Stainless	★		
K	Cast iron	★		
N	Non-ferrous			
S	Superalloys	★		
H	Hard materials			

★ : First choice
☆ : Second choice

Designation	CW±0.02 (mm)	CW±0.001 (in)	RE (in)	Coated		CDX (in)	CUTDIA (in)	Relation of groove depth (T) and Max. diameter (øD max) (in)									
				AH725				T≤0.039	T≤0.138	T≤0.157	T≤0.177	T≤0.197	T≤0.217	T≤0.224	T≤0.236	T≤0.244	T≤0.252
								T≤0.079	T≤0.118								
TCM27-157-079	1.57	0.059	0.031	●		0.118	0.236	∞	-	-	-	-	-	-	-	-	-
TCM27-200-100	2	0.059	0.039	●		0.118	0.236	∞	23.622	-	-	-	-	-	-	-	-
TCM27-239-120	2.39	0.062	0.047	●		0.224	0.449	∞	23.622	11.024	7.087	5.118	1.969	1.378	-	-	-
TCM27-300-150	3	0.125	0.059	●		0.252	0.504	∞	23.622	11.024	7.087	5.315	4.134	3.740	3.346	3.071	2.165

5 pieces per package
● : Line up

HOW TO INDEX INSERTS

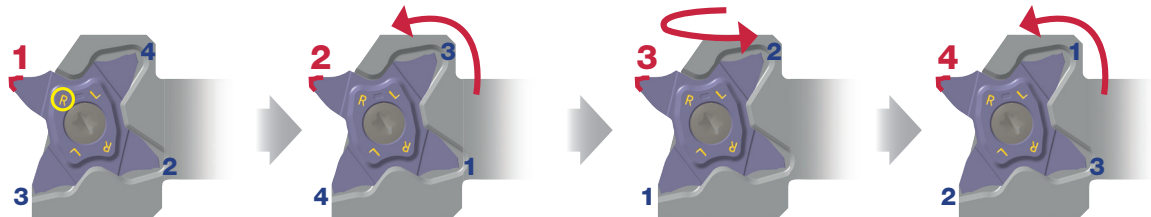

1. Right-hand edge (R) is used for the right-hand toolholders.
2. Rotate the insert
3. Flip over the insert
4. Rotate the insert

STANDARD CUTTING CONDITIONS

ISO	Workpiece materials	Grades	Cutting speed Vc (sfm)	Feed: f (ipr)					Depth of cut for profiling (with full radius insert)	
				Grooving, parting-off		Parting-off (with hand)		Profiling (with full radius insert)		
				TCS	TCM	TCS	TCS	TCM		
P	Steel 1045, etc.	AH725	330 - 660	0.002 - 0.006	0.002 - 0.010	0.0016 - 0.005	0.002 - 0.004	0.002 - 0.006	0.020	
	Alloy steel 4137, etc.	AH725	165 - 590	0.002 - 0.006	0.002 - 0.010	0.0016 - 0.005	0.002 - 0.004	0.002 - 0.006	0.020	
M	Stainless steel 304, etc.	AH725	165 - 490	0.002 - 0.006	0.002 - 0.008	0.0016 - 0.005	0.002 - 0.004	0.002 - 0.006	0.020	
K	Gray cast iron No.250, etc.	AH725	165 - 590	0.002 - 0.006	0.002 - 0.010	0.0016 - 0.005	0.002 - 0.004	0.002 - 0.006	0.020	
	Ductile cast iron 60-40-18, etc.	AH725	165 - 390	0.002 - 0.006	0.002 - 0.008	0.0016 - 0.005	0.002 - 0.004	0.002 - 0.006	0.020	
S	Titanium alloys Ti-6Al-4V, etc.	AH725	100 - 200	0.002 - 0.006	0.002 - 0.006	0.0016 - 0.005	0.002 - 0.004	0.002 - 0.004	0.020	
	Superalloys Inconel718, etc.	AH725	65 - 165	0.002 - 0.006	0.002 - 0.006	0.0016 - 0.005	0.002 - 0.004	0.002 - 0.004	0.020	

Reference pages: Toolholders → **G090 - G091**

Grade
Insert
Toolholder
Ext. Toolholder
Int. Toolholder
Threading
Grooving
Milling Cutter
Miniature Tool
Endmill
Drilling Tool
Tooling System
User's Guide
Index



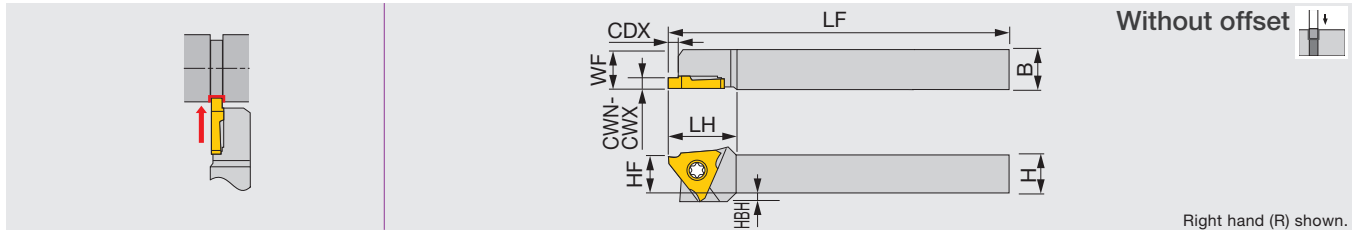

Inch	CWN	CWX	CDX	H	B	LF	LH	HF	WF	HBH	Insert	Torque
JSTGR/L063	0.013	0.118	0.028 - 0.102	0.375	0.375	5	0.75	0.375	0.375	0.100	JTGR/L3...	0.89
JSTGR/L083	0.013	0.118	0.028 - 0.102	0.500	0.500	5	0.75	0.500	0.500	-	JTGR/L3...	0.89
JSTGR/L103	0.013	0.118	0.028 - 0.102	0.625	0.625	5	0.75	0.625	0.625	-	JTGR/L3...	0.89

Metric	CWN	CWX	CDX	H	B	LF	LH	HF	WF	HBH	Insert	Torque*
JSTGR/L1010X3	0.33	3	0.7 - 2.6	10	10	120	18.5	10	10	2	JTGR/L3...	1.2
JSTGR/L1212F3	0.33	3	0.7 - 2.6	12	12	85	18.5	12	12	-	JTGR/L3...	1.2
JSTGR/L1212X3	0.33	3	0.7 - 2.6	12	12	120	18.5	12	12	-	JTGR/L3...	1.2
JSTGR/L1616X3	0.33	3	0.7 - 2.6	16	16	120	18.5	16	16	-	JTGR/L3...	1.2
JSTGL1616K3	0.33	3	0.7 - 2.6	16	16	125	18.5	16	16	-	JTGR/L3...	1.2

Can be wrenched also from the back with a double-head screw
Torque: Recommended clamping torque: lbs-ft (*N·m)

SPARE PARTS

Designation	Clamping screw	Wrench
JSTGR/L...	CSTB-4SD	T-8F (Optional T-8L)

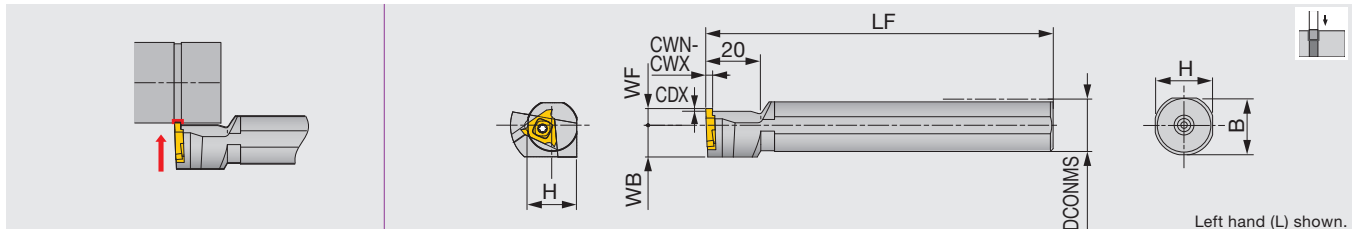

Metric	CWN	CWX	CDX	DCONMS	H	B	LF	WF	WB	Insert	Torque
JS19K-TGL3	0.33	3	0.7 - 2.6	19.05	18	18	125	6	11.5	JTGR3...	3
JS20K-TGL3	0.33	3	0.7 - 2.6	20	19	19	125	6	11.5	JTGR3...	3
JS22K-TGL3	0.33	3	0.7 - 2.6	22	21	21	125	6	11.5	JTGR3...	3
JS25K-TGL3	0.33	3	0.7 - 2.6	25.4	24	24	125	10	12.7	JTGR3...	3

Use left-hand toolholders (L) with right-hand inserts (R).
Torque: Recommended clamping torque: N·m

SPARE PARTS

Designation	Clamping screw	Wrench
JS***-TGL3	CSTB-4S	T-15F

INSERT

JTG (Sharp edge)

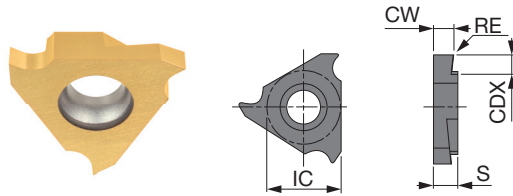

Right hand (R) shown.

P	Steel	★	★		★		☆			
M	Stainless	★	★							
K	Cast iron					☆	★			
N	Non-ferrous						★			
S	Superalloys						★			
H	Hard materials									

★ : First choice
☆ : Second choice

Designation	HAND	CW ₀ ^{+0.05} (mm)	CW ₀ ^{+0.002} (in)	RE (in)	Coated		Cermet	Uncoated		CDX (in)	IC (mm)	S (mm)
					SH725	J740	NS9530	TH10				
JTGR3033F	R	0.33	0.013	0.0012	●	●			●	0.028	9.53	3.18
JTGL3033F	L	0.33	0.013	0.0012		●			●	0.028	9.53	3.18
JTGR3033F-005	R	0.33	0.013	0.002	●					0.028	9.53	3.18
JTGR3043F	R	0.43	0.017	0.0012		●				0.043	9.53	3.18
JTGR3050F	R	0.5	0.020	0.0012	●	●	●		●	0.043	9.53	3.18
JTGL3050F	L	0.5	0.020	0.0012	●	●			●	0.043	9.53	3.18
JTGR3050F-005	R	0.5	0.020	0.002	●					0.043	9.53	3.18
JTGL3050F-005	L	0.5	0.020	0.002	●					0.043	9.53	3.18
JTGR3065F	R	0.65	0.026	0.0012	●	●				0.075	9.53	3.18
JTGR3065F-010	R	0.65	0.026	0.004	●					0.075	9.53	3.18
JTGR3075F	R	0.75	0.030	0.0012	●	●	●		●	0.075	9.53	3.18
JTGL3075F	L	0.75	0.030	0.0012	●	●	●		●	0.075	9.53	3.18
JTGR3075F-010	R	0.75	0.030	0.004	●					0.075	9.53	3.18
JTGL3075F-010	L	0.75	0.030	0.004	●					0.075	9.53	3.18
JTGR3080F	R	0.8	0.031	0.0012	●	●				0.075	9.53	3.18
JTGR3080F-010	R	0.8	0.031	0.004	●					0.075	9.53	3.18
JTGR3085F	R	0.85	0.033	0.0012	●	●				0.075	9.53	3.18
JTGR3095F	R	0.95	0.037	0.0012	●	●	●		●	0.075	9.53	3.18
JTGL3095F	L	0.95	0.037	0.0012	●	●			●	0.075	9.53	3.18
JTGR3095F-010	R	0.95	0.037	0.004	●					0.075	9.53	3.18
JTGL3095F-010	L	0.95	0.037	0.004	●					0.075	9.53	3.18
JTGR3100F	R	1	0.039	0.002	●	●	●		●	0.083	9.53	3.18
JTGL3100F	L	1	0.039	0.002	●	●			●	0.083	9.53	3.18
JTGR3100F-010	R	1	0.039	0.004	●					0.083	9.53	3.18
JTGL3100F-010	L	1	0.039	0.004	●					0.083	9.53	3.18
JTGR3110F	R	1.1	0.043	0.002	●	●				0.083	9.53	3.18
JTGR3120F	R	1.2	0.047	0.002	●	●				0.083	9.53	3.18
JTGR3120F-010	R	1.2	0.047	0.004	●					0.083	9.53	3.18
JTGR3125F	R	1.25	0.049	0.002	●	●	●		●	0.083	9.53	3.18
JTGL3125F	L	1.25	0.049	0.002	●	●			●	0.083	9.53	3.18
JTGR3125F-010	R	1.25	0.049	0.004	●					0.083	9.53	3.18
JTGL3125F-010	L	1.25	0.049	0.004	●					0.083	9.53	3.18
JTGR3130F	R	1.3	0.051	0.002	●	●				0.083	9.53	3.18
JTGR3140F	R	1.4	0.055	0.002	●	●				0.083	9.53	3.18
JTGR3140F-010	R	1.4	0.055	0.004	●					0.083	9.53	3.18
JTGR3145F	R	1.45	0.057	0.002	●	●	●		●	0.083	9.53	3.18
JTGL3145F	L	1.45	0.057	0.002	●	●			●	0.083	9.53	3.18
JTGR3145F-010	R	1.45	0.057	0.004	●					0.083	9.53	3.18
JTGR3150F	R	1.5	0.059	0.002	●	●	●		●	0.083	9.53	3.18
JTGL3150F	L	1.5	0.059	0.002	●	●			●	0.083	9.53	3.18
JTGR3150F-010	R	1.5	0.059	0.004	●					0.083	9.53	3.18
JTGL3150F-010	L	1.5	0.059	0.004	●					0.083	9.53	3.18

● : Line up

Reference pages: Toolholders → G096, Standard cutting conditions → G099



INSERT

JTG (Sharp edge)

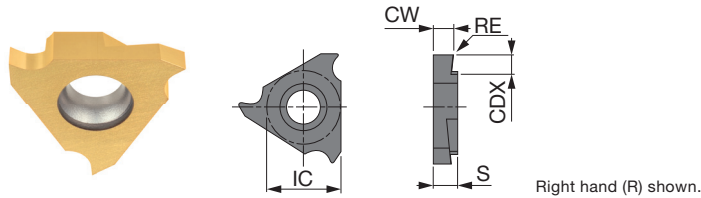

P	Steel	★	★		★		☆		
M	Stainless	★	★						
K	Cast iron				☆		★		
N	Non-ferrous						★		
S	Superalloys						★		
H	Hard materials								

★ : First choice
☆ : Second choice

Designation	HAND	CW ₀ ^{+0.05} (mm)	CW ₀ ^{+0.002} (in)	RE (in)	Coated		Cermet	Uncoated		CDX (in)	IC (mm)	S (mm)
					SH725	J740	NS9530	TH10				
JTGR3175F	R	1.75	0.069	0.002	●	●	●	●		0.083	9.53	3.18
JTGL3175F	L	1.75	0.069	0.002	●		●	●		0.083	9.53	3.18
JTGR3175F-010	R	1.75	0.069	0.004	●					0.083	9.53	3.18
JTGR3180F	R	1.8	0.071	0.002	●	●				0.083	9.53	3.18
JTGR3200F	R	2	0.079	0.002	●	●	●	●		0.102	9.53	3.18
JTGL3200F	L	2	0.079	0.002	●	●		●		0.102	9.53	3.18
JTGR3200F-010	R	2	0.079	0.004	●					0.102	9.53	3.18
JTGL3200F-010	L	2	0.079	0.004	●					0.102	9.53	3.18
JTGR3225F	R	2.25	0.089	0.002	●	●				0.102	9.53	3.18
JTGR3250F	R	2.5	0.098	0.002	●	●	●	●		0.102	9.53	3.18
JTGL3250F	L	2.5	0.098	0.002	●	●		●		0.102	9.53	3.18
JTGR3250F-010	R	2.5	0.098	0.004	●					0.102	9.53	3.18
JTGL3250F-010	L	2.5	0.098	0.004	●					0.102	9.53	3.18
JTGR3275F	R	2.75	0.108	0.002		●				0.102	9.53	3.18
JTGR3300F	R	3	0.118	0.002	●	●				0.102	9.53	3.18
JTGR3300F-010	R	3	0.118	0.004	●					0.102	9.53	3.18

● : Line up

JTG (honed edge)

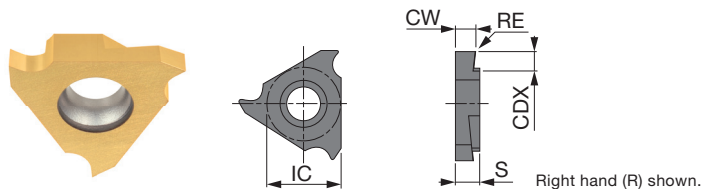

P	Steel	★							
M	Stainless								
K	Cast iron	☆							
N	Non-ferrous								
S	Superalloys								
H	Hard materials								

★ : First choice
☆ : Second choice

Designation	HAND	CW ₀ ^{+0.05} (mm)	CW ₀ ^{+0.002} (in)	RE (in)	Coated cermet				CDX (in)	IC (mm)	S (mm)
					J9530						
JTGR3100	R	1	0.039	0.002	●				0.083	9.53	3.18
JTGR3125	R	1.25	0.049	0.002	●				0.083	9.53	3.18
JTGR3150	R	1.5	0.059	0.002	●				0.083	9.53	3.18
JTGR3200	R	2	0.079	0.002	●				0.102	9.53	3.18

● : Line up

Reference pages: Toolholders → **G096**, Standard cutting conditions → **G099**

STANDARD CUTTING CONDITIONS (J-Series grooving tool)

ISO	Workpiece material	Grade	Cutting speed Vc (sfm)	Feed f (ipr)
P	General steel 1045, etc.	SH725	164 - 656	0.0004 - 0.004
		J740	33 - 328	0.0004 - 0.004
		NS9530	164 - 492	0.0004 - 0.004
		J9530	164 - 492	0.0004 - 0.004
	Free-cutting steel	SH725	164 - 656	0.0004 - 0.004
		J740	33 - 328	0.0004 - 0.004
M	Stainless steel 303, etc.	SH725	164 - 656	0.0004 - 0.004
		J740	33 - 328	0.0004 - 0.004
		NS9530	164 - 492	0.0004 - 0.004
		J9530	164 - 492	0.0004 - 0.004
N	Aluminium alloys, Brass Si < 12%, etc.	TH10	33 - 656	0.0004 - 0.004
S	Difficult-to-cut materials, Titanium alloys Ti-6Al-4V, etc.	TH10	33 - 98	0.0004 - 0.004

Grade
Insert
Ext. Toolholder
Int. Toolholder
Threading
Grooving
Miniature Tool
Milling Cutter
Endmill
Drilling Tool
Tooling System
User's Guide
Index



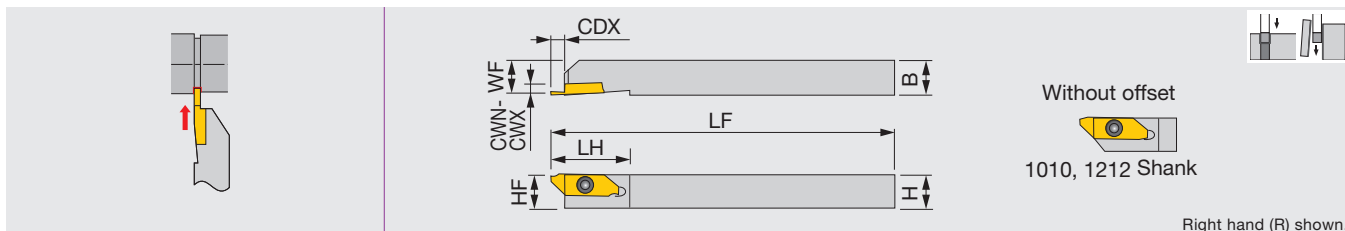

Metric	CWN	CWX	CDX	H	B	LF	LH	HF	WF	Insert	Torque
JSXGR/L1010K8-C	0.7	2	4.5 - 6	10	10	125	29	10	9.9	JXG...	1.3
JSXGR/L1212K8-C	0.7	2	4.5 - 6	12	12	125	29	12	11.9	JXG...	1.3
JSXGR/L1616K8	0.7	2	4.5 - 6	16	16	125	29	16	15.9	JXG...	1.3
JSXGR/L2020K8	0.7	2	4.5 - 6	20	20	125	29	20	19.9	JXG...	1.3
JSXGR/L2525K8	0.7	2	4.5 - 6	25	25	125	29	25	24.9	JXG...	1.3

Can be wrenched also from the back with a double-head screw.

This toolholder can be used for JXF front-turning insert, JXR reverse-turning insert and JXG parting and grooving insert.

Torque: Recommended clamping torque: N·m

SPARE PARTS

Designation	Clamping screw	Wrench
JSXGR/L...	CSTB-4SD	T-8F (Optional T-8L)

INSERT

JXG (with hand, sharp edge)

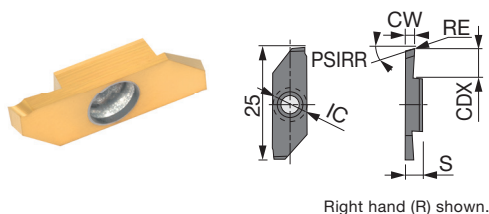

	P	M	K	N	S	H
Steel	★					☆
Stainless	★					
Cast iron					☆	
Non-ferrous				★		
Superalloys				★		
Hard materials						

★ : First choice
☆ : Second choice

Designation	HAND	CW±0.001 (in)	CW±0.025 (mm)	RE (mm)	Coated		Uncoated		CDX (mm)	IC (mm)	PSIRR	S (mm)
					J740	TH10						
JXGR8070FA	R	0.028	0.7	0	●		●		4.5	8	15°	3.97
JXGL8070FA	L	0.028	0.7	0	●		●		4.5	8	15°	3.97
JXGR8070FA-005	R	0.028	0.7	0.05	●				4.5	8	15°	3.97
JXGR8100FA	R	0.039	1	0	●		●		6	8	15°	3.97
JXGL8100FA	L	0.039	1	0	●		●		6	8	15°	3.97
JXGR8100FA-005	R	0.039	1	0.05	●				6	8	15°	3.97
JXGR8100FA45	R	0.039	1	0	●		●		4.5	8	15°	3.97
JXGR8100FA45-005	R	0.039	1	0.05	●				4.5	8	15°	3.97
JXGR8150FA	R	0.059	1.5	0	●		●		6	8	15°	3.97
JXGL8150FA	L	0.059	1.5	0	●		●		6	8	15°	3.97
JXGR8150FA-005	R	0.059	1.5	0.05	●				6	8	15°	3.97
JXGR8150FA50	R	0.059	1.5	0	●		●		5	8	15°	3.97
JXGR8150FA50-005	R	0.059	1.5	0.05	●				5	8	15°	3.97
JXGR8180FA	R	0.071	1.8	0	●		●		6	8	15°	3.97
JXGR8180FA-005	R	0.071	1.8	0.05	●				6	8	15°	3.97
JXGR8200FA	R	0.079	2	0	●		●		6	8	15°	3.97
JXGL8200FA	L	0.079	2	0	●		●		6	8	15°	3.97
JXGR8200FA-005	R	0.079	2	0.05	●				6	8	15°	3.97
JXGR8200FN	R	0.079	2	0	●		●		6	8	0°	3.97
JXGL8200FN	L	0.079	2	0	●		●		6	8	0°	3.97
JXGR8200FN-005	R	0.079	2	0.05	●				6	8	0°	3.97

● : Line up

Reference pages: Standard cutting conditions → **G102**

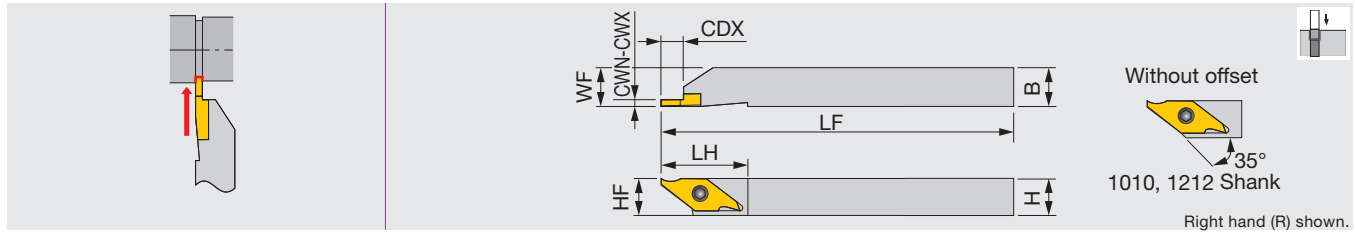

Inch	CWN	CWX	CDX	H	B	LF	LH	HF	WF	Insert	Torque
JSVGR/L062.5	0.013	0.079	0.028 - 0.217	0.375	0.375	5	0.875	0.375	0.375	JVGR/L...	1.70
JSVGR/L082.5	0.013	0.079	0.028 - 0.217	0.500	0.500	5	0.875	0.500	0.500	JVGR/L...	1.70
JSVGR/L102.5	0.013	0.079	0.028 - 0.217	0.625	0.625	5	0.875	0.625	0.625	JVGR/L...	1.70

Metric	CWN	CWX	CDX	H	B	LF	LH	HF	WF	Insert	Torque*
JSVGR/L1010K-C	0.33	2	0.7 - 5.5	10	10	125	23	10	10	JVGR/L...	2.3
JSVGR/L1212K-C	0.33	2	0.7 - 5.5	12	12	125	23	12	12	JVGR/L...	2.3
JSVGR/L1616K	0.33	2	0.7 - 5.5	16	16	125	23	16	16	JVGR/L...	2.3

Torque: Recommended clamping torque: lbs-ft (*N·m)

SPARE PARTS

Designation	Clamping screw	Wrench
JSVGR/L...	CSTB-3S	T-9F (Optional T-9L)

INSERT

JVG (with hand, sharp edge)

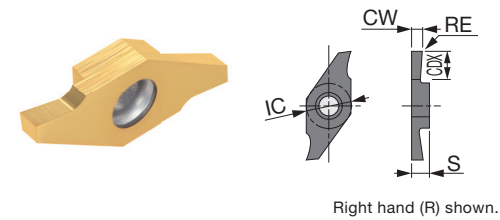

	SH725	J740	NS9530	TH10
P Steel	★	★		☆
M Stainless	★	★		
K Cast iron				☆
N Non-ferrous				★
S Superalloys				★
H Hard materials				

★ : First choice
☆ : Second choice

Designation	HAND	CW ₀ ^{+0.05} (mm)	CW ₀ ^{+0.002} (in)	RE (in)	Coated			Cermet	Uncoated	CDX (in)	IC (mm)	S (mm)
					SH725	J740	NS9530	TH10				
JVGR033F	R	0.33	0.013	0	●	●			●	0.028	7.94	3.18
JVGL033F	L	0.33	0.013	0	●					0.028	7.94	3.18
JVGR050F	R	0.5	0.020	0	●	●			●	0.043	7.94	3.18
JVGL050F	L	0.5	0.020	0	●					0.043	7.94	3.18
JVGR075F	R	0.75	0.030	0	●	●			●	0.075	7.94	3.18
JVGL075F	L	0.75	0.030	0	●					0.075	7.94	3.18
JVGR095F	R	0.95	0.037	0	●	●			●	0.075	7.94	3.18
JVGL095F	L	0.95	0.037	0	●					0.075	7.94	3.18
JVGR100F	R	1	0.039	0	●	●	●		●	0.217	7.94	3.18
JVGL100F	L	1	0.039	0	●		●		●	0.217	7.94	3.18
JVGR125F	R	1.25	0.049	0	●	●			●	0.197	7.94	3.18
JVGL125F	L	1.25	0.049	0	●					0.197	7.94	3.18
JVGR150F	R	1.5	0.059	0	●	●	●		●	0.217	7.94	3.18
JVGL150F	L	1.5	0.059	0	●		●		●	0.217	7.94	3.18
JVGR200F	R	2	0.079	0	●	●	●		●	0.217	7.94	3.18
JVGL200F	L	2	0.079	0	●					0.217	7.94	3.18

● : Line up

Reference pages: Standard cutting conditions → **G102**

STANDARD CUTTING CONDITIONS (JXG and JVG inserts)

ISO	Workpiece material	Grade	Cutting speed Vc (sfm)	Feed f (ipr)
P	General steel 1045, etc.	SH725	164 - 656	0.0004 - 0.004
		J740	33 - 328	0.0004 - 0.004
		NS9530	164 - 492	0.0004 - 0.004
	Free-cutting steel	SH725	164 - 656	0.0004 - 0.004
J740		33 - 328	0.0004 - 0.004	
M	Stainless steel 303, etc.	SH725	164 - 656	0.0004 - 0.004
		J740	33 - 328	0.0004 - 0.004
		NS9530	164 - 492	0.0004 - 0.004
N	Aluminium alloys, Brass Si < 12%, etc.	TH10	33 - 656	0.0004 - 0.004
S	Difficult-to-cut materials, Titanium alloys Ti-6Al-4V, etc.	TH10	33 - 98	0.0004 - 0.004

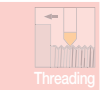
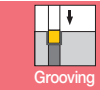



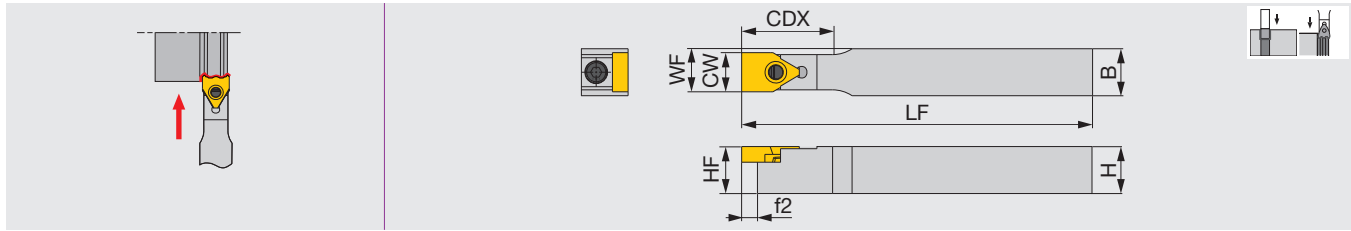

Lever-lock external wide profile grooving toolholder



Inch	CW	CDX	H	B	LF	HF	WF	f2	Insert	Torque
FPGN08-10T20	0.394	0.984	0.500	0.500	4.946	0.500	0.450	0.216	PSGB10...	1.62
FPGN10-10T20	0.394	0.984	0.625	0.625	4.946	0.625	0.510	0.216	PSGB10...	1.62
FPGN12-10T20	0.394	0.984	0.750	0.750	5.196	0.750	0.570	0.216	PSGB10...	1.62
FPGN10-15T25	0.590	1.181	0.625	0.625	4.946	0.625	0.610	0.216	PSGB15...	1.62
FPGN12-15T25	0.590	1.181	0.750	0.750	5.196	0.750	0.670	0.216	PSGB15...	1.62
FPGN12-20T32	0.787	1.456	0.750	0.750	5.196	0.750	0.770	0.216	PSGB20...	6.27
FPGN16-20T32	0.787	1.456	1.000	1.000	6.196	1.000	0.890	0.216	PSGB20...	6.27
FPGN16-25T36	0.984	1.614	1.000	1.000	6.196	1.000	0.990	0.216	PSGB25...	6.27

PSGB insert blank is available for tailored inserts.
Torque: Recommended clamping torque: lbs-ft

SPARE PARTS				
Designation	Lever	Clamping screw	Spring	Wrench
FPGN*-10T..., 15T...	FCL4	FCS3	BP-5	P-2.5
FPGN*-20T..., 25T...	FCL8	FCS6	BP-9	P-5

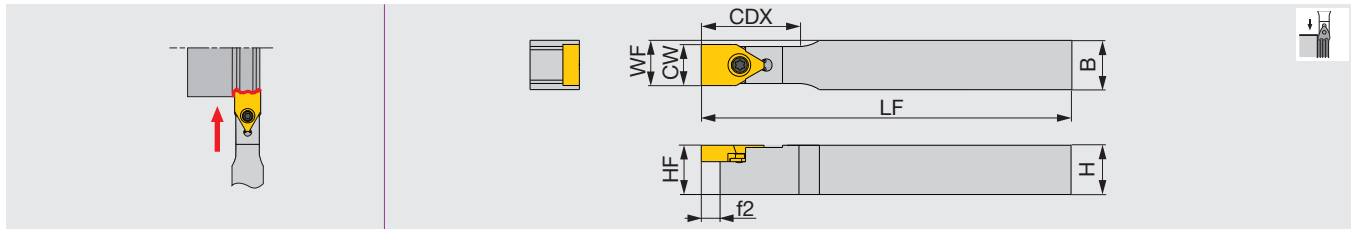

SPGN

Screw-on external wide profile grooving toolholder



Inch	CW	CDX	H	B	LF	HF	WF	f2	Insert	Torque
SPGN08-10T20	0.394	0.984	0.500	0.500	4.946	0.500	0.450	0.216	PSGB10	0.96
SPGN10-10T20	0.394	0.984	0.625	0.625	4.946	0.625	0.510	0.216	PSGB10	0.96
SPGN12-10T20	0.394	0.984	0.750	0.750	5.196	0.750	0.570	0.216	PSGB10	0.96
SPGN10-15T25	0.590	1.181	0.625	0.625	4.946	0.625	0.610	0.216	PSGB15	2.58
SPGN12-15T25	0.590	1.181	0.750	0.750	5.196	0.750	0.670	0.216	PSGB15	2.58
SPGN12-20T32	0.787	1.456	0.750	0.750	5.196	0.750	0.770	0.216	PSGB20	3.69
SPGN16-20T32	0.787	1.456	1.000	1.000	6.196	1.000	0.890	0.216	PSGB20	3.69
SPGN16-25T36	0.984	1.614	1.000	1.000	6.196	1.000	0.990	0.216	PSGB25	3.69

PSGB insert blank is available for tailored inserts.
Torque: Recommended clamping torque: lbs-ft

SPARE PARTS		
Designation	Clamping screw	Wrench
SPGN*-10T20	CSTB-3L081	T-8F
SPGN*-15T25	CSTB-4	T-15F
SPGN*-20T..., 25T...	CSTB-5	T-20F

INSERT

PSGB (Blank for wide profile grooving inserts*)

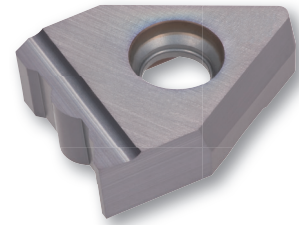
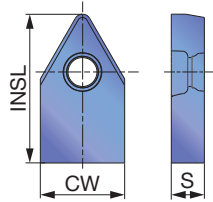

Specially tailored profile insert

P Steel	☆	★					
M Stainless		★					
K Cast iron	★						
N Non-ferrous	★						
S Superalloys	☆						
H Hard materials							

★ : First choice
☆ : Second choice

Designation	CW±0.025 (mm)	CW±0.001 (in)	Uncoated		INSL (in)	S (in)
			TH10	UX30		
PSGB10	10.2	0.402	●	●	0.709	0.157
PSGB15	15.2	0.598	●	●	0.787	0.197
PSGB20	20.2	0.795	●	●	1.062	0.256
PSGB25	25.2	0.992	●	●	1.062	0.256

*These are blanks (semi-finished products) for wide profile grooving inserts that can be tailored.

Package quantity = 5pcs.
● : Line up

STANDARD CUTTING CONDITIONS

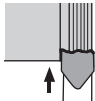

Wide profile grooving (PSGB insert)

ISO	Workpiece material	Hardness (HB)	Grade	Cutting speed Vc (sfm)
P	Steel 1045, 1055, etc.	< 200	UX30	165 - 490
	Alloy steel 4140, 8620, etc.	< 300	UX30	165 - 390
M	Stainless steel 304SS, 316SS, 17-4 PH, etc.	< 200	UX30	165 - 390
K	Gray cast iron Class 25, Class 30, etc.	-	TH10	165 - 490
	Ductile cast iron 60-40-18, 60-55-06, etc.	-	TH10	165 - 390
N	Aluminum alloys Si < 12%, etc.	-	TH10	330 - 1640

Custom shaped inserts can be supplied on customer's request, according to the designated final shape on part drawing.

Semi-finished blanks PSGB types are offered for purchase.

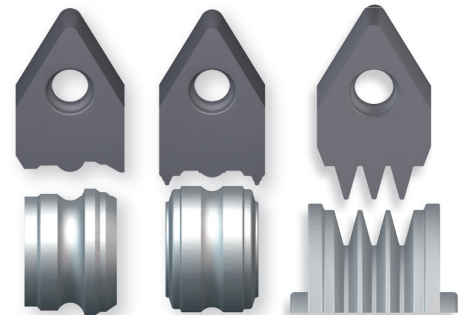

Reference pages: Toolholders → **G103**

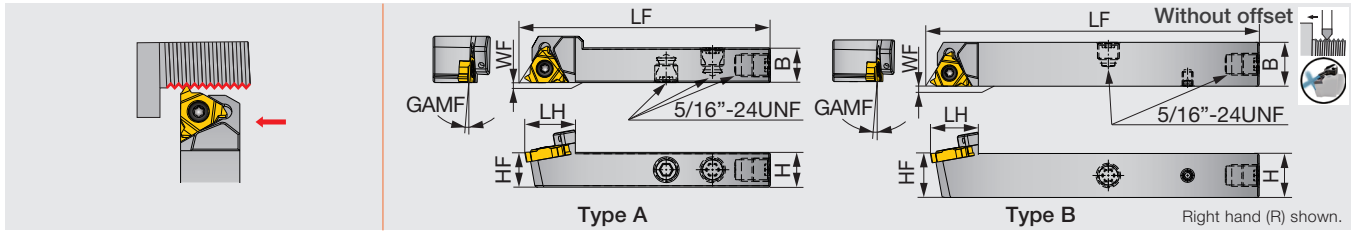

Inch	H	B	LF	LH	HF	WF	GAMF	Type	Insert
JSE2R1212X16-CHP	0.500	0.500	4.750	0.748	0.500	0.000	1°	B	16ER...
JSE2R1616X16-CHP	0.625	0.625	4.750	0.748	0.625	0.000	1°	B	16ER...

Metric	H	B	LF	LH	HF	WF	GAMF	Type	Insert
JSE2R1212F16-CHP *	12	12	85	19	12	0	1°	A	16ER...
JSE2R1212X16-CHP	12	12	120	19	12	0	1°	B	16ER...
JSE2R1616X16-CHP	16	16	120	19	16	0	1°	B	16ER...

* Connection with external coolant tube

SPARE PARTS



Designation	Clamping screw	Wrench
JSE2R**16-CHP	CSTB-3.5	T-15F

No need for coolant tube setup.

Eliminates chip entanglement on tubes and streamlines tool replacement.

Coolant is supplied from the tool post directly to the tools

Internal thread

Optional connection with external coolant tube

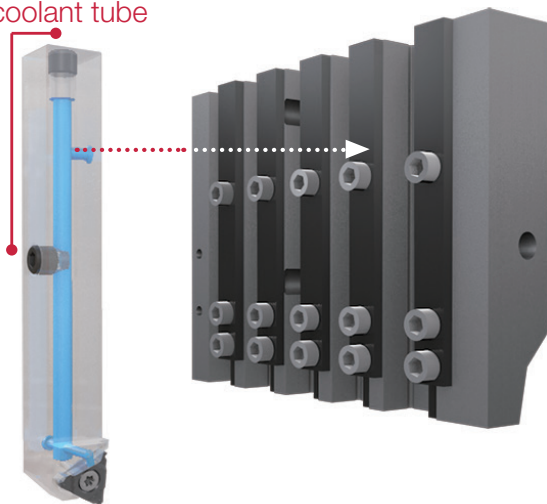

Detailed view of the coolant flow after connection

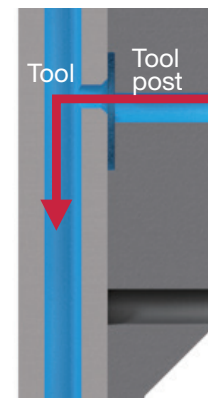

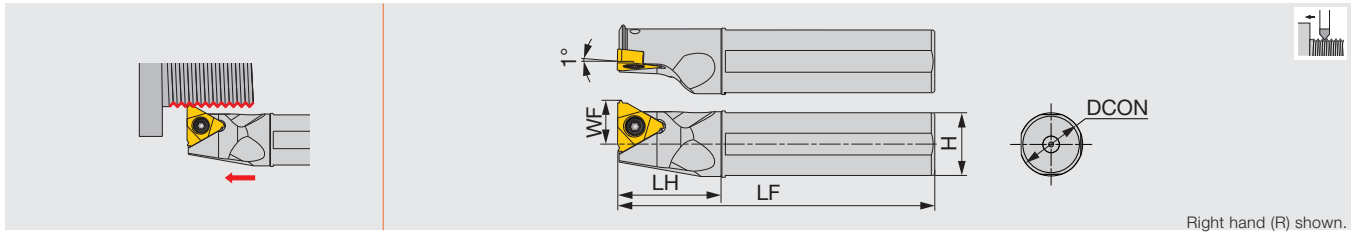

Right hand (R) shown.

Inch	DCON	H	LF	LH	WF	Insert
JS16F-SEL16	0.630	0.630	0.984	3.346	0.433	16ER...
JS19G-SEL16	0.750	0.750	1.181	3.543	0.492	16ER...
JS19X-SEL16	0.750	0.750	1.181	4.724	0.492	16ER...
JS20G-SEL16	0.787	0.787	1.181	3.543	0.512	16ER...
JS20X-SEL16	0.787	0.787	1.181	4.724	0.512	16ER...
JS25HSEL16	0.984	0.984	1.181	3.937	0.61	16ER...
JS254X-SEL16	1.181	0.984	1.181	4.724	0.618	16ER...

Metric	DCON	H	LF	LH	WF	Insert
JS16F-SEL16	16	15	85	25	11	16ER...
JS19G-SEL16	19.05	18	90	30	12.5	16ER...
JS19X-SEL16	19.05	18	120	30	12.5	16ER...
JS20G-SEL16	20	19	90	30	13	16ER...
JS20X-SEL16	20	19	120	30	13	16ER...
JS25HSEL16	25	24	100	30	15.5	16ER...
JS254X-SEL16	25.4	24	120	30	15.7	16ER...

Use left-hand toolholders (L) with right-hand inserts (R).

SPARE PARTS

Designation	Clamping screw	Wrench
JS***-SEL16	CSTB-3.5	T-15F

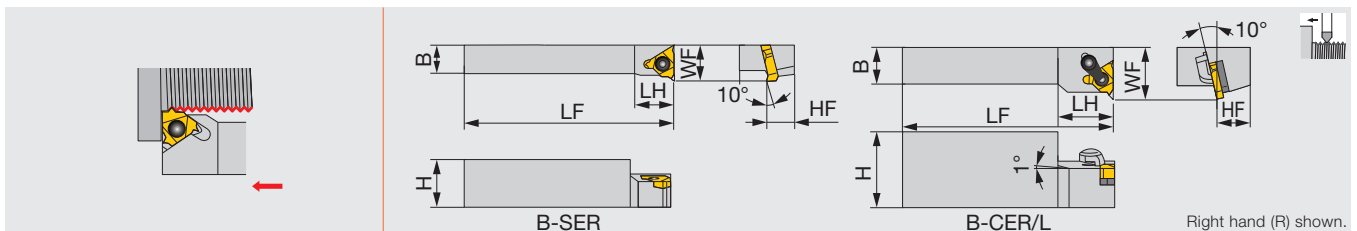

Right hand (R) shown.

Metric	H	B	LF	LH	HF	WF	Insert
B-SER10H16	20	10	100	15	10	16	16ER...
B-SER12K16	24	12	125	18	12	18	16ER...
B-CER/L16M16	32	16	150	24	16	22	16ER/L...

SPARE PARTS

Designation	Clamp set	Shim set	Clamping screw	Wrench
B-SER**16	-	-	CSTB-3.5	T-15F
B-CER/L16M16	CSP16	A16-1	-	T-15F

Reference pages: JS-SEL16, B-S/CER/L: Inserts → E010 -, Standard cutting conditions → E054

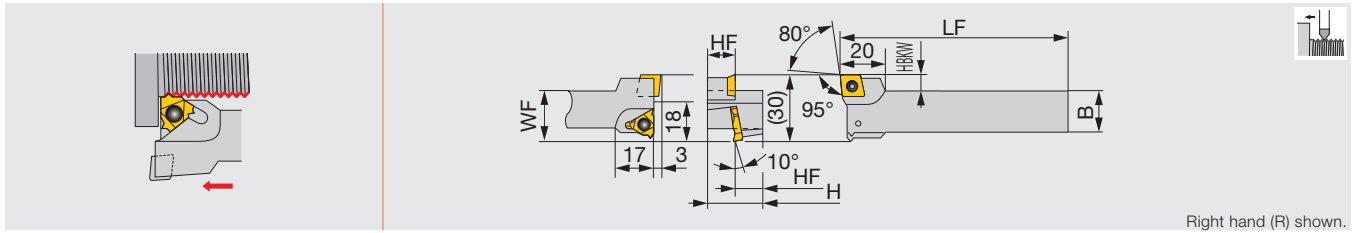

Right hand (R) shown.

Metric	H	B	LF	HF	WF	HBKW	Insert
BC-SER12K16	24	16	125	12	23	7	16ER..., CC*T09T3...

SPARE PARTS

Designation	Clamping screw	Wrench
BC-SER12K16	CSTB-3.5	T-15F

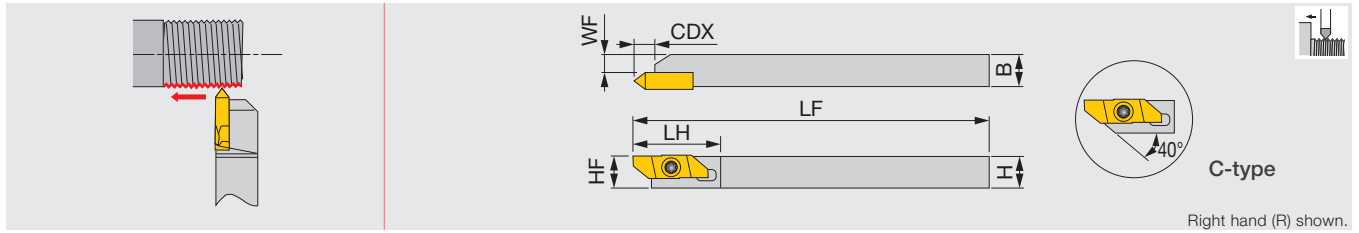

Metric	H	B	LF	LH	CDX	HF	WF	Insert
JSXBR1010K8-C	10	10	125	29	6.4	10	5.7	JXT*R...
JSXBR1212K8-C	12	12	125	29	6.4	12	7.7	JXT*R...
JSXBR1616K8	16	16	125	29	6.4	16	11.7	JXT*R...
JSXBR2020K8	20	20	125	29	6.4	20	15.7	JXT*R...
JSXBR2525K8	25	25	125	29	6.4	25	20.7	JXT*R...

Can be wrenched from back side with both end torx screw.
This toolholder is compatible with JXB-type inserts and JXT-type inserts.

SPARE PARTS

Designation	Clamping screw	Wrench 1	Wrench 2 (optional)
JSXBR...	CSTB-4SD	T-8F	(T-8L)

INSERT

JXT (sharp edge)

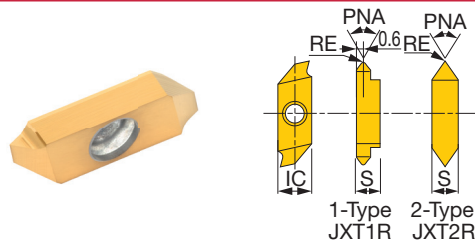

	P	M	K	N	S	H
Steel	★					
Stainless	★					
Cast iron						
Non-ferrous				☆		
Superalloys				☆		
Hard materials				☆		

★ : First choice
☆ : Second choice

Designation	RE (mm)	Coated		Uncoated		PNA	IC (mm)	S (mm)
		J740	TH10					
JXT1R6000F	0.03	●	●			60°	8	3.97
JXT2R6000F	0.03	●	●			60°	8	3.97

● : Line up

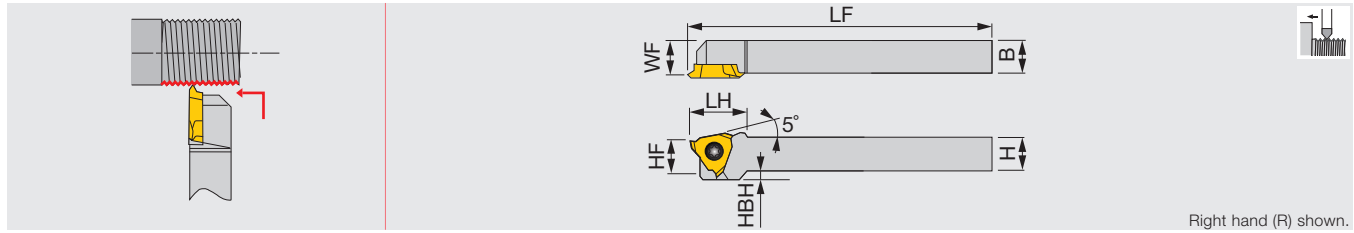

Right hand (R) shown.

Inch	H	B	LF	LH	HF	WF	HBH	Insert
JSTTR/L063	0.375	0.375	5.000	0.6875	0.375	0.375	0.100	JTTR/L30...
JSTTR/L083	0.500	0.500	5.000	0.6875	0.500	0.500	-	JTTR/L30...
JSTTR/L103	0.625	0.625	5.000	0.6875	0.625	0.625	-	JTTR/L30...

Metric	H	B	LF	LH	HF	WF	HBH	Insert
JSTTR/L1010X3	10	10	120	18.5	10	9.5	2	JTTR/L30...
JSTTR/L1212F3	12	12	85	18.5	12	11.5	-	JTTR/L30...
JSTTR/L1212X3	12	12	120	18.5	12	11.5	-	JTTR/L30...
JSTTR/L1616X3	16	16	120	18.5	16	15.5	-	JTTR/L30...

Recommended clamping torque: 0.89 lbs-ft, 1.2 N-m

SPARE PARTS

Designation	Clamping screw	Wrench 1	Wrench 2 (optional)
JSTTR/L...	CSTB-4SD	T-8F	(T-8L)

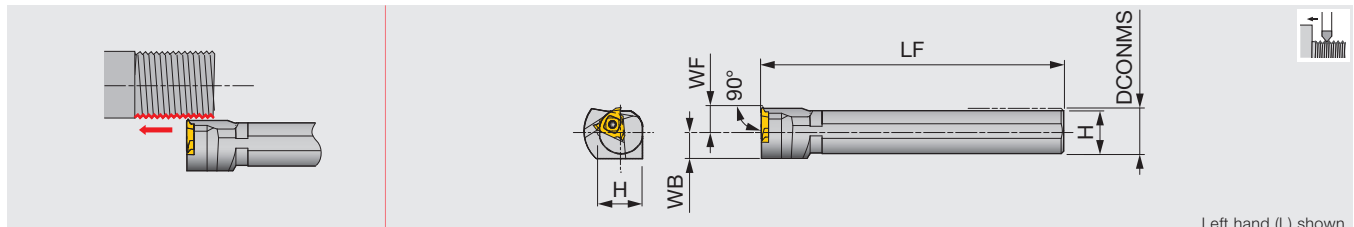

Left hand (L) shown.

Metric	DCONMS	WF	LF	H	WB	Insert
JS19K-TTL3	19.05	10	125	18	11.5	JTTR30...
JS20K-TTL3	20	10	125	19	11.5	JTTR30...
JS22K-TTL3	22	10	125	21	11.5	JTTR30...
JS25K-TTL3	25.4	10	125	24	12.7	JTTR30...

Recommended clamping torque: 3.5 N-m

SPARE PARTS

Designation	Clamping screw	Wrench
JS*-TTL3	CSTB-4S	T-15F

INSERT

JTT (sharp edge)

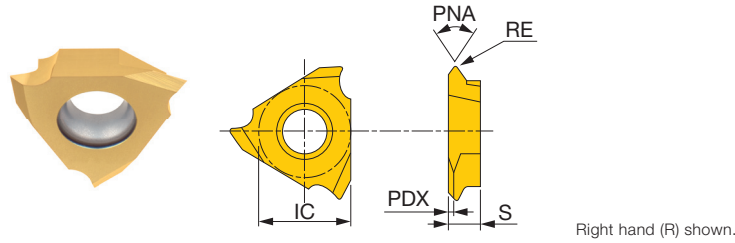

P	Steel	★	☆		★					
M	Stainless	★	☆							
K	Cast iron	★			☆		★			
N	Non-ferrous						★			
S	Superalloys	☆					★			
H	Hard materials	☆					★			

★ : First choice
☆ : Second choice

Designation	RE (in)	Coated		Cermet	Uncoated	PNA	IC (mm)	S (mm)	PDX (mm)
		SH725	J740	NS9530	TH10				
JTTR3005F-55	0.002	●	●			55°	9.525	3.18	0.6
JTTL3005F-55	0.002					55°	9.525	3.18	0.6
JTTR3005F	0.002	●	●	●	●	60°	9.525	3.18	0.9
JTTL3005F	0.002	●				60°	9.525	3.18	0.9
JTTR3010F	0.004	●	●	●	●	60°	9.525	3.18	0.9
JTTL3010F	0.004	●				60°	9.525	3.18	0.9

Machinable pitch range: 0.020" to 0.039" (0.5 to 1 mm)

● : Line up

STANDARD CUTTING CONDITIONS

ISO	Workpiece material	Grade	Cutting speed Vc (sfm)	Pitch (in)	TPI
P	Low carbon steel 1025, etc.	SH725	197 - 492	0.020 - 0.039	50 - 25
	Carbon steel, Alloy steel 1045, 4140, etc.	SH725	197 - 492	0.020 - 0.039	50 - 25
	Pre-hardened steel NAK80, PX5, etc.	SH725	197 - 492	0.020 - 0.039	50 - 25
M	Stainless steel 304SS, 316SS, 17-4 PH, etc.	SH725	164 - 262	0.020 - 0.039	50 - 25
K	Gray cast iron Class 25, Class 30, etc.	TH10	164 - 328	0.020 - 0.039	50 - 25
	Ductile cast iron 60-40-18, etc.	TH10	164 - 328	0.020 - 0.039	50 - 25
S	Titanium alloy Ti-6Al-4V, etc.	SH725	98 - 328	0.020 - 0.039	50 - 25
	Heat resistant alloy Inconel 718, etc.	SH725	98 - 328	0.020 - 0.039	50 - 25

Parting toolholder, for Swiss lathes

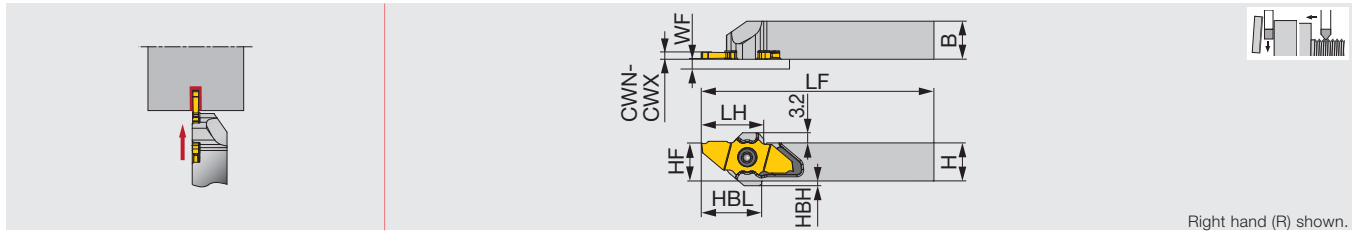

Inch	CWN	CWX	H	B	LF**	LH**	HF	WF	HBL**	HBH	Insert	Torque
JSXXR/L063	0.039	0.079	0.375	0.375	4.750	0.774	0.375	0.008	0.748	0.12	JX*G06...,12...,16..., 20...	0.89
JSXXR/L083	0.039	0.079	0.500	0.500	4.750	0.774	0.500	0.008	0.748	0.06	JX*G06...,12...,16..., 20...	0.89
JSXXR/L103	0.039	0.079	0.625	0.625	4.750	0.774	0.625	0.008	-	-	JX*G06...,12...,16..., 20...	0.89

Torque: Recommended clamping torque: lbs-ft

**LF (Functional Length), LH (Head Length), and HBL (Head-bottom Offset Length) values shown above are true with JXPG16... insert. LF, LH, and HBL will all be 0.079" shorter than the above values with JX*G12... and JXPG20... inserts, and 0.157" shorter for JXPG06... insert.

Use the right-hand insert (JX*G**R...) for a right-hand holder (JSXXR...); the left-hand insert (JX*G**L...) for a left-hand holder (JSXXL...).

SPARE PARTS

Designation	Clamping screw	Wrench
JSXXR...	CSTC-4L100DL	T-1008/5
JSXXL...	CSTC-4L100DR	T-1008/5

Parting toolholder, for Swiss lathes (for sub spindle)

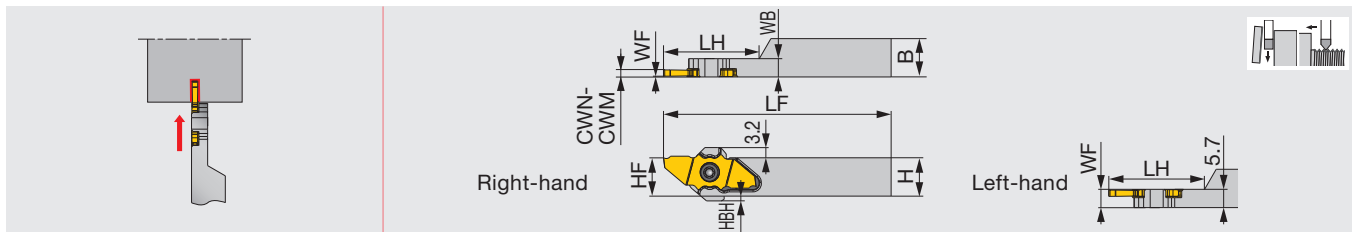

Inch	CWN	CWM	H	B	LF**	LH**	HF	WF	HBH	Insert	Torque
JSXXR/L063-S	0.039	0.079	0.375	0.375	4.750	1.030	0.383	0.008/0.217	0.120	JX*G06...,12...,16..., 20...	0.89
JSXXR/L083-S	0.039	0.079	0.500	0.500	4.750	1.030	0.500	0.008/0.217	0.060	JX*G06...,12...,16..., 20...	0.89

Torque: Recommended clamping torque: lbs-ft

**LF (Functional Length) and LH (Head Length) values shown above are true with JXPG16... insert. LF and LH will be 0.079" shorter than the above values with JX*G12... insert, and 0.157" shorter for JXPG06... insert. LF, LH, and HBL will all be 0.079" shorter with JXPG20... insert.

JXPG20... insert will not fit.

Use the right-hand insert (JX*G**R...) for a right-hand holder (JSXXR...); the left-hand insert (JX*G**L...) for a left-hand holder (JSXXL...).

SPARE PARTS

Designation	Clamping screw	Wrench
JSXXR***-S	CSTC-4L055DL	T-1008/5
JSXXL***-S	CSTC-4L055DR	T-1008/5



Parting-off tool for swiss lathes with high pressure coolant capability

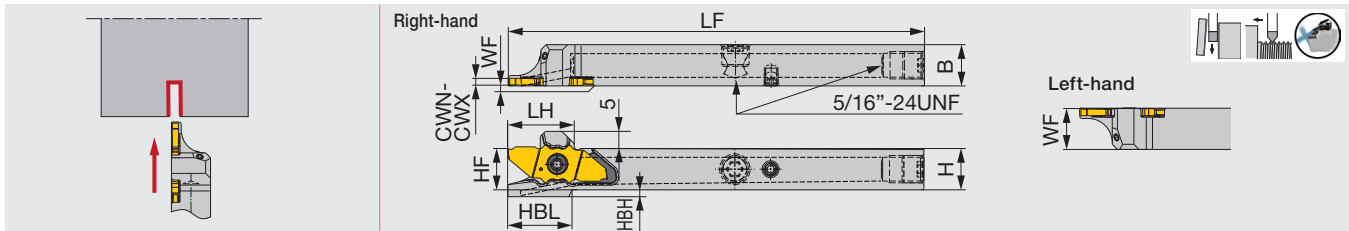

Inch	CWN	CWX	H	B	WF	LF**	HF	HBH	LH**	HBL**	Insert	Torque
JSXXR/L083X-CHP	0.039	0.079	0.500	0.500	0.008/0.492	4.750	0.500	0.051	0.764	0.736	JX*G06...,12...,16..., 20...	0.89
JSXXR/L103X-CHP	0.039	0.079	0.625	0.625	0.008/0.617	4.750	0.625	0	0.764	0	JX*G06...,12...,16..., 20...	0.89

Torque: Recommended clamping torque: lbs-ft
 **LF (Functional Length) LH (Head Length), and HBL (Head-bottom Offset Length) values shown above are true with JXPG16... insert. LF, LH, and HBL will all be 0.079" shorter than the above values with JX*G12... and JXPG20... inserts, and 0.157" shorter for JXPG06... insert.
 Use the right-hand insert (JX*G**R...) for a right-hand holder (JSXXR...); the left-hand insert (JX*G**L...) for a left-hand holder (JSXXL...).

SPARE PARTS

Designation	Clamping screw	Wrench 1	Coolant plug	Wrench 2	DirectJet plug	Wrench 3
JSXXR...	CSTC-4L100DL	T-1008/5	SR5/16UNFTL360	P-4	SSHM4-6-TB	P-2
JSXXL...	CSTC-4L100DR	T-1008/5	SR5/16UNFTL360	P-4	SSHM4-6-TB	P-2

Parting-off widths : 0.039" and 0.059" (for a max parting diameter of ϕ 0.236")
 : 0.059" and 0.079" (for max parting diameters of ϕ 0.472", ϕ 0.630" and ϕ 0.787")
 Threading pitch range : 0.008" - 0.059"

DUOJUST CUT

JSXXR/L-F-CHP

Parting-off tool for swiss lathes

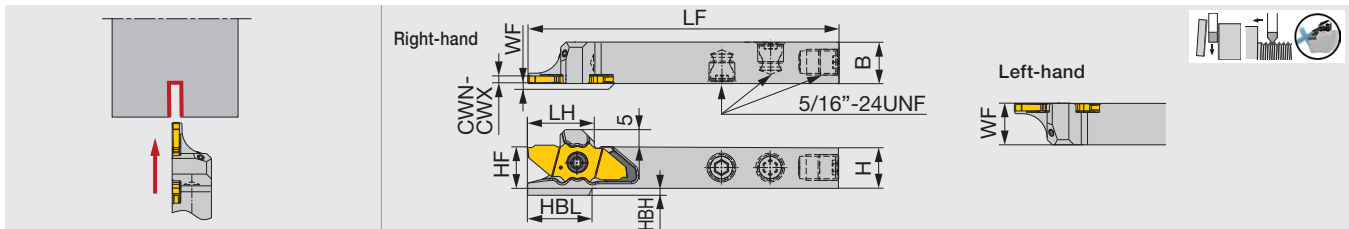

Inch	CWN	CWX	H	B	LF**	LH**	HF	WF	HBL**	HBH	Insert	Torque
JSXXR/L083F-CHP	0.039	0.079	0.500	0.500	3.344	≤ 0.764	0.5	0.008/0.492	0.736	0.051	JX*G06...,12...,16..., 20...	0.89

Torque: Recommended clamping torque: lb-ft
 **LF (Functional Length) LH (Head Length), and HBL (Head-bottom Offset Length) values shown above are true with JXPG16... insert. LF, LH, and HBL will all be 0.079" shorter than the above values with JX*G12... and JXPG20... inserts, and 0.157" shorter for JXPG06... insert.
 Use the right-hand insert (JX*G**R...) for a right-hand holder (JSXXR...); the left-hand insert (JX*G**L...) for a left-hand holder (JSXXL...).

SPARE PARTS

Designation	Clamping screw	Wrench 1	Coolant plug	Wrench 2
JSXXR...	CSTC-4L100DL	T-1008/5	SR5/16UNFTL360	P-4
JSXXL...	CSTC-4L100DR	T-1008/5	SR5/16UNFTL360	P-4

Parting-off widths : 0.039" and 0.059" (for a max parting diameter of ϕ 0.236")
 : 0.059" and 0.079" (for max parting diameters of ϕ 0.472", ϕ 0.630" and ϕ 0.787")
 Threading pitch range : 0.008" - 0.059"

Reference pages: JSXXR/L-CHP, JSXXR/L-F-CHP: Inserts → **G116 - G117**,
 Standard cutting conditions → **G119**

Parting toolholder with high pressure coolant capability, for Swiss lathes (for sub spindle)

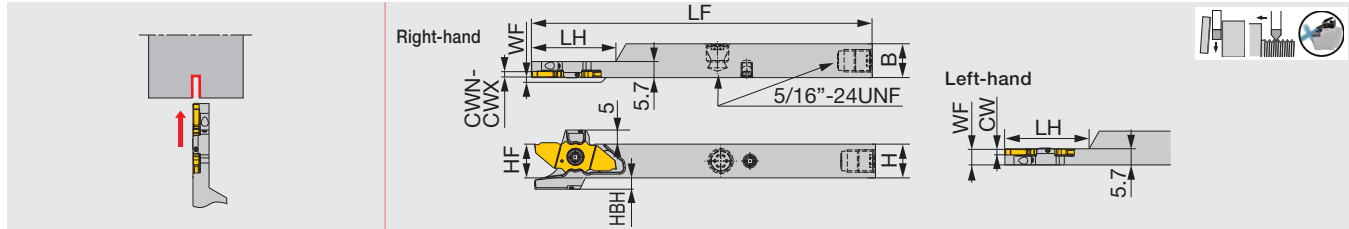

Inch	CWN	CWX	H	B	LF**	LH**	HF	WF	HBH	Insert	Torque
JSXXR/L083X-S-CHP	0.039	0.079	0.500	0.500	4.750	1.181	0.500	0.008/0.217	0.051	JX*G06...,12...,16..., 20...	0.89
JSXXR/L103X-S-CHP	0.039	0.079	0.625	0.625	4.750	1.181	0.625	0.008/0.217	0	JX*G06...,12...,16..., 20...	0.89

Torque: Recommended clamping torque: lbs-ft

**LF (Overall Tool Length) and LH (Head Length) values shown above are true with JXPG16... insert. Both LF and LH will be 0.079" shorter than the above value with JX*G12... and JXPG20... inserts; 0.157" shorter with JXPG06... insert.

Use the right-hand insert (JX*G**R...) for a right-hand holder (JSXXR...); the left-hand insert (JX*G**L...) for a left-hand holder (JSXXL...).

SPARE PARTS

Designation	Clamping screw	Wrench 1	Coolant plug	Wrench 2	DirectJet plug	Wrench 3
JSXXR***-S-CHP	CSTC-4L055DL	T-1008/5	SR5/16UNFTL360	P-4	SSHM4-6-TB	P-2
JSXXL***-S-CHP	CSTC-4L055DR	T-1008/5	SR5/16UNFTL360	P-4	SSHM4-6-TB	P-2

Parting-off widths : 0.039" and 0.059" (for a max parting diameter of ϕ 0.236")
: 0.059" and 0.079" (for max parting diameters of ϕ 0.472", ϕ 0.630" and ϕ 0.787")

Parting toolholder, with high pressure coolant capability, for Swiss lathes (for sub spindle)

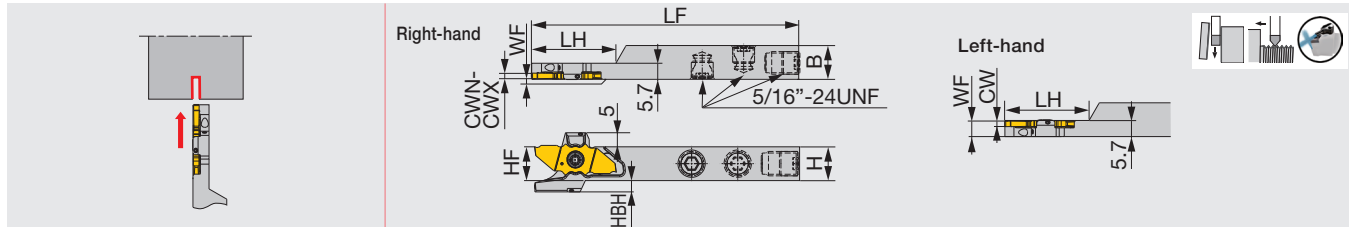

Inch	CWN	CWX	H	B	LF**	LH**	HF	WF	HBH	Insert	Torque
JSXXR/L083F-S-CHP	0.039	0.079	0.500	0.500	3.344	1.024	0.500	0.008/0.217	0.051	JX*G06...,12...,16..., 20...	0.89

Torque: Recommended clamping torque: lbs-ft

**LF (Overall Tool Length) and LH (Head Length) values shown above are true with JXPG16... insert. Both LF and LH will be 0.079" shorter than the above value with JX*G12... and JXPG20... inserts; 0.157" shorter with JXPG06... insert.

Use the right-hand insert (JX*G**R...) for a right-hand holder (JSXXR...); the left-hand insert (JX*G**L...) for a left-hand holder (JSXXL...).

SPARE PARTS

Designation	Clamping screw	Wrench 1	Coolant plug	Wrench 2
JSXXR***-S-CHP	CSTC-4L055DL	T-1008/5	SR5/16UNFTL360	P-4
JSXXL***-S-CHP	CSTC-4L055DR	T-1008/5	SR5/16UNFTL360	P-4

Parting-off widths : 0.039" and 0.059" (for a max parting diameter of ϕ 0.236")
: 0.059" and 0.079" (for max parting diameters of ϕ 0.472", ϕ 0.630" and ϕ 0.787")

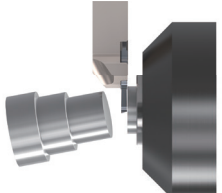
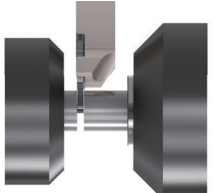
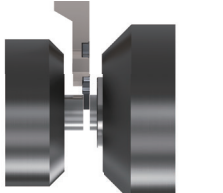
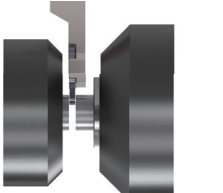

HOW TO SELECT TOOLS

Application	Large-diameter machining of workpiece with rigidity		Small-diameter machining of workpiece with short overhang	
	Main-spindle tooling	Sub-spindle tooling	Sub-spindle tooling	
			Workpiece with long overhang at the side of sub-spindle for the process after parting-off	Short workpiece with low rigidity
 <p>Main spindle</p> <p>Position of parting-off is at the side of the main spindle</p>	 <p>Sub-spindle Main spindle</p> <p>Position of parting-off is at the side of the sub-spindle</p>	 <p>Sub-spindle Main spindle</p> <p>Position of parting-off is at the side of the main spindle</p>	 <p>Sub-spindle Main spindle</p> <p>Position of parting-off is at the side of the sub-spindle</p>	
Toolholder	R-hand (JSXXR type)	L-hand (JSXXL type)	R-hand (JSXXR-S type)	L-hand (JSXXL-S type)
Insert	Right-hand insert with lead angle to remove center core (JXPG**R***-15 type)	Left-hand insert (JXPG**L*** type)	Right-hand insert (JXPG**R*** type)	Left-hand insert (JXPG**L*** type)

HOW TO SELECT TOOLHOLDERS FOR SUB-SPINDLE

Sub-spindle dia.	Parting-off dia.	B	LF	Insert	Toolholder
ø1.575	- ø0.236	0.375	4.514	JXPG06*	JSXXR/L063-S
ø1.575	- ø0.236	0.500	4.514	JXPG06*	JSXXR/L083-S
ø1.575	- ø0.472	0.375	4.593	JXPG12*	JSXXR/L063-S
ø1.575	- ø0.472	0.500	4.593	JXPG12*	JSXXR/L083-S
ø1.575	- ø0.630	0.375	4.750	JXPG16*	JSXXR/L063-S
ø1.575	- ø0.630	0.500	4.750	JXPG16*	JSXXR/L083-S
ø1.575	- ø0.787	0.500	3.423	JXPG20*	JSXXR/L083F-S-CHP
ø1.969	- ø0.236	0.500	4.514	JXPG06*	JSXXR/L083-S
ø1.969	- ø0.236	0.625	4.514	JXPG06*	JSXXR/L103X-S-CHP
ø1.969	- ø0.472	0.500	4.593	JXPG12*	JSXXR/L083-S
ø1.969	- ø0.472	0.625	4.593	JXPG12*	JSXXR/L103X-S-CHP
ø1.969	- ø0.630	0.500	4.750	JXPG16*	JSXXR/L083-S
ø1.969	- ø0.630	0.500	4.750	JXPG16*	JSXXR/L083-S
ø1.969	- ø0.630	0.625	4.750	JXPG16*	JSXXR/L103X-S-CHP
ø1.969	- ø0.787	0.500	3.423	JXPG20*	JSXXR/L083F-S-CHP
ø1.969	- ø0.787	0.500	4.829	JXPG20*	JSXXR/L083X-S-CHP
ø1.969	- ø0.787	0.625	4.829	JXPG20*	JSXXR/L103X-S-CHP

MAX. PARTING-OFF DIA. & DEPTH

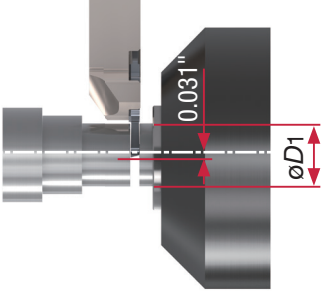
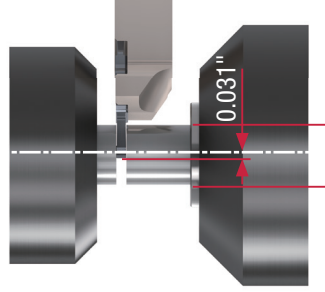
Main-spindle tooling	Sub-spindle tooling
 <p>Main spindle</p>	 <p>Sub-spindle Main spindle</p>

There will be no tool-workpiece interference when parting off the workpiece with the cutting edge position apart from the workpiece center by 0.031" or more.

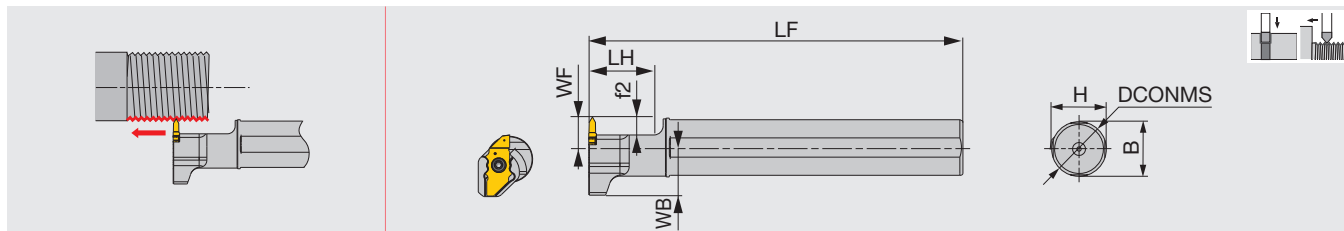

Metric	DCONMS	H	B	LF	LH	WB	WF	f2	Insert	Torque
JS19G-SXXL09	19.05	18	18	90	21	15.43	10	6	JX*G06,12*R	1.2
JS19X-SXXL09	19.05	18	18	120	21	15.43	10	6	JX*G06,12*R	1.2
JS20G-SXXL09	20	19	19	90	21	15.4	10	6	JX*G06,12*R	1.2
JS20X-SXXL09	20	19	19	120	21	15.4	10	6	JX*G06,12*R	1.2
JS22X-SXXL09	22	21	21	120	21	15.4	10	6	JX*G06,12*R	1.2
JS25H-SXXL09	25	24	24	100	21	15.4	10	6	JX*G06,12*R	1.2
JS254X-SXXL09	25.4	24	24	120	21	15.4	10	6	JX*G06,12*R	1.2

Torque: Recommended clamping torque: N·m

Threading insert (JXTG12FR) and parting-off inserts (JXPG06R, 12R) fit this holder.

SPARE PARTS



Designation	Clamping screw	Wrench
JS***-SXXL09	CSTC-4L100DL	T-1008/5

INSERT

JXPG**R/L-F (sharp edge)

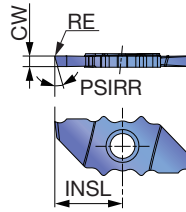

Right hand (R) shown.

P	Steel	★
M	Stainless	★
K	Cast iron	★
N	Non-ferrous	★
S	Superalloys	★
H	Hard materials	★

★ : First choice
☆ : Second choice

Designation	HAND	CW±0.025 (mm)	CW±0.001 (in)	RE (in)	Coated								CUTDIA (mm)	INSL (mm)	PSIRR/L	
					SH725											
JXPG06R10F	R	1	0.039	0.002	●									6	10.5	0°
JXPG06L10F	L	1	0.039	0.002	●									6	10.5	0°
JXPG06R15F	R	1.5	0.059	0.002	●									6	10.5	0°
JXPG06L15F	L	1.5	0.059	0.002	●									6	10.5	0°
JXPG06R10F-15	R	1	0.039	0.002	●									6	10.5	15°
JXPG06L10F-15	L	1	0.039	0.002	●									6	10.5	15°
JXPG06R15F-15	R	1.5	0.059	0.002	●									6	10.5	15°
JXPG06L15F-15	L	1.5	0.059	0.002	●									6	10.5	15°
JXPG12R15F	R	1.5	0.059	0.002	●									12	12.5	0°
JXPG12L15F	L	1.5	0.059	0.002	●									12	12.5	0°
JXPG12R20F	R	2	0.079	0.002	●									12	12.5	0°
JXPG12L20F	L	2	0.079	0.002	●									12	12.5	0°
JXPG12R15F-15	R	1.5	0.059	0.002	●									12	12.5	15°
JXPG12L15F-15	L	1.5	0.059	0.002	●									12	12.5	15°
JXPG12R20F-15	R	2	0.079	0.002	●									12	12.5	15°
JXPG12L20F-15	L	2	0.079	0.002	●									12	12.5	15°
JXPG16R15F	R	1.5	0.059	0.002	●									16	14.5	0°
JXPG16L15F	L	1.5	0.059	0.002	●									16	14.5	0°
JXPG16R20F	R	2	0.079	0.002	●									16	14.5	0°
JXPG16L20F	L	2	0.079	0.002	●									16	14.5	0°
JXPG16R15F-15	R	1.5	0.059	0.002	●									16	14.5	15°
JXPG16L15F-15	L	1.5	0.059	0.002	●									16	14.5	15°
JXPG16R20F-15	R	2	0.079	0.002	●									16	14.5	15°
JXPG16L20F-15	L	2	0.079	0.002	●									16	14.5	15°
JXPG20R15F	R	1.5	0.059	0.002	●									20	16.5	0°
JXPG20L15F	L	1.5	0.059	0.002	●									20	16.5	0°
JXPG20R20F	R	2	0.079	0.002	●									20	16.5	0°
JXPG20L20F	L	2	0.079	0.002	●									20	16.5	0°
JXPG20R15F-15	R	1.5	0.059	0.002	●									20	16.5	15°
JXPG20L15F-15	L	1.5	0.059	0.002	●									20	16.5	15°
JXPG20R20F-15	R	2	0.079	0.002	●									20	16.5	15°
JXPG20L20F-15	L	2	0.079	0.002	●									20	16.5	15°

● : Line up
CUTDIA: Max. parting-off dia.
Packing quantity = 5 pcs.

JXTG12FR/L-60 (For Threading / Sharp edge)

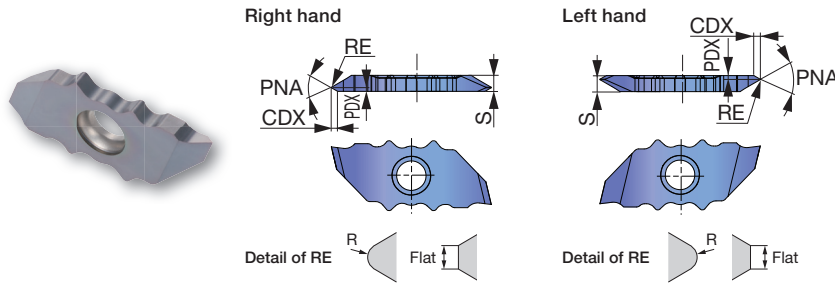

P	Steel	★							
M	Stainless	★							
K	Cast iron	★							
N	Non-ferrous	★							
S	Superalloys	★							
H	Hard materials	★							

★ : First choice
☆ : Second choice

Designation	HAND	RE (mm)	Coated					Pitches (mm)	PDX (mm)	CDX (mm)	S (mm)	PNA
			SH725									
JXTG12FR-60A-000	R	Flat 0.05 max	●					0.2 - 0.4	0.25	0.4	2.5	60°
JXTG12FL-60A-000	L	Flat 0.05 max	●					0.2 - 0.4	0.25	0.4	2.5	60°
JXTG12FR-60B-000	R	Flat 0.05 max	●					0.2 - 0.4	0.25	0.4	2.5	60°
JXTG12FL-60B-000	L	Flat 0.05 max	●					0.2 - 0.4	0.25	0.4	2.5	60°
JXTG12FR-60A-005	R	R 0.05	●					0.4 - 1	0.6	0.99	2.5	60°
JXTG12FL-60A-005	L	R 0.05	●					0.4 - 1	0.6	0.99	2.5	60°
JXTG12FR-60B-005	R	R 0.05	●					0.4 - 1	1.9	0.99	2.5	60°
JXTG12FL-60B-005	L	R 0.05	●					0.4 - 1	1.9	0.99	2.5	60°
JXTG12FR-60N-010	R	R 0.1	●					1 - 1.5	1.25	2.07	2.5	60°
JXTG12FL-60N-010	L	R 0.1	●					1 - 1.5	1.25	2.07	2.5	60°

● : Line up
Packing quantity = 5 pcs.

EDGE ORIENTATION AND DESCRIPTION OF THREADING INSERTS

		Edge Orientation		
		Type A	Type B	Type N
Right hand				
Left hand				

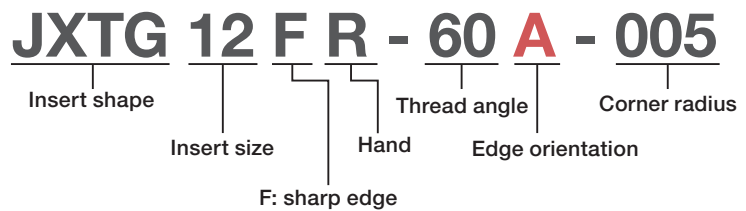

Grade
Insert
Ext. Toolholder
Int. Toolholder
Threading
Grooving
Miniature Tool
Milling Cutter
Endmill
Drilling Tool
User's Guide Tooling System
Index

WHEN TO USE TYPE A AND TYPE B INSERT

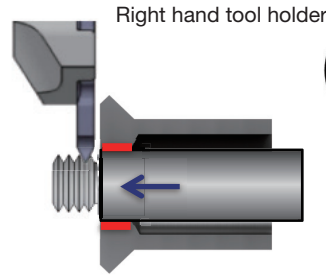
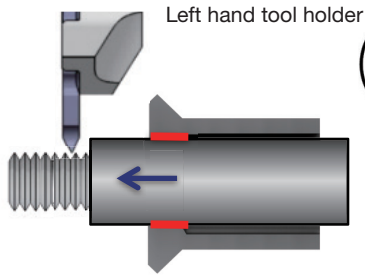

Threading close to the wall

Threading operation following back-turning

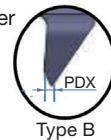
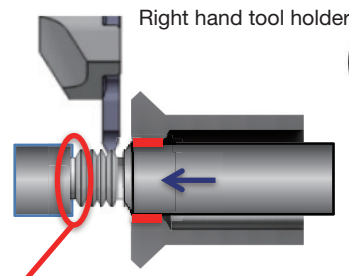
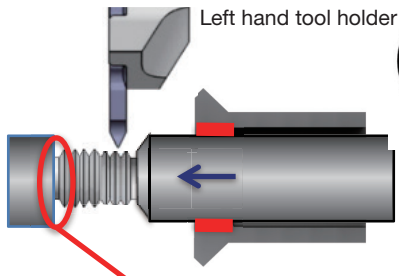

Undercutting needed in previous process

THREADING WORKPIECE IN MAIN SPINDLE

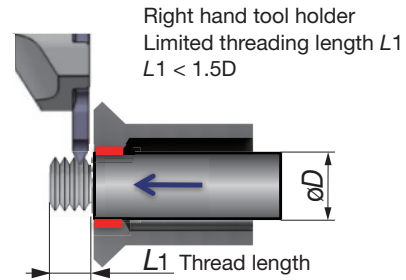
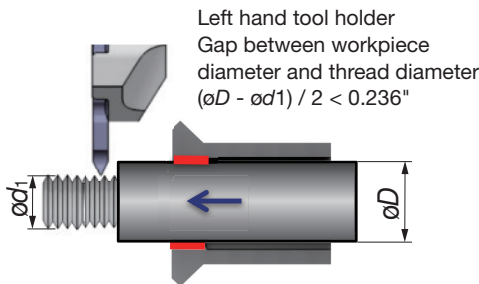

Threading operation following back-turning

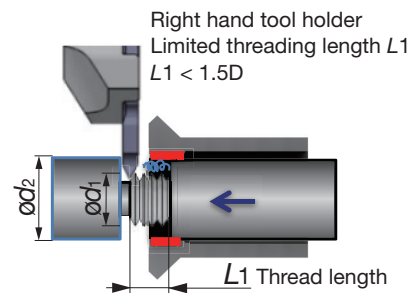
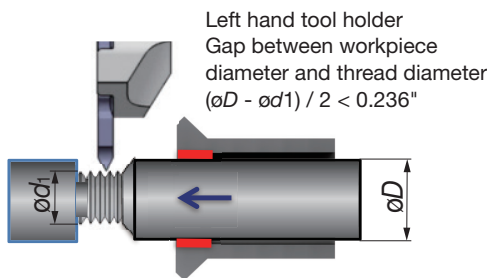

STANDARD CUTTING CONDITIONS (Parting-off)

ISO	Workpiece materials	Grades	Cutting speed Vc (sfm)	Feed f (ipr)
P	Low carbon steel 1015, etc.	SH725	164 - 656	0.0004 - 0.002
	Carbon steel, Alloy steel 1055, etc.	SH725	164 - 656	0.0004 - 0.002
	Free cutting steel SUH22, SUH23, etc.	SH725	164 - 656	0.0004 - 0.002
M	Stainless steel S30400, etc.	SH725	164 - 656	0.0004 - 0.002
N	Aluminium alloys 5056, 6061, etc.	SH725	492 - 656	0.0004 - 0.002
	Copper alloys C2600, C280C, etc.	SH725	328 - 656	0.0004 - 0.002
S	Titanium alloys Ti-6Al-4V, etc.	SH725	98 - 262	0.0004 - 0.002
	Superalloys Inconel718, etc.	SH725	98 - 262	0.0004 - 0.002

Grade
Insert
Toolholder
Ext. Toolholder
Int. Toolholder
Threading
Grooving
Miniature Tool
Milling Cutter
Endmill
Drilling Tool
Tooling System
User's Guide
Index



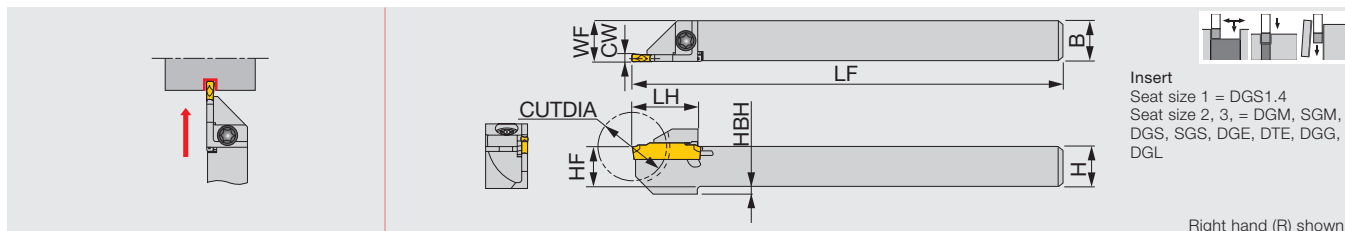

Inch	CW (in)	CW (mm)	Seat size	CUTDIA	H	B	LF	LH	HF	WF ⁽¹⁾	HBH	Torque
JCTER/L08-2T12	0.079	2	2	0.945	0.500	0.500	4.750	0.748	0.500	0.504	0.079	2.21
JCTER/L08-3T12	0.118	3	3	0.945	0.500	0.500	4.750	0.748	0.500	0.512	0.079	2.21
JCTER/L10-2T16	0.079	2	2	1.260	0.625	0.625	4.750	0.945	0.625	0.629	-	2.21
JCTER/L10-3T16	0.118	3	3	1.260	0.625	0.625	4.750	0.945	0.625	0.637	-	2.21

Metric	CW	Seat size	CUTDIA	H	B	LF	LH	HF	WF ⁽¹⁾	HBH	Torque*
JCTER/L1010X1.4T10	1.4	1	20	10	10	120	18	10	10.2	-	3
JCTER/L1010-1.4T10	1.4	1	20	10	10	125	18	10	10.2	-	3
JCTER/L1212F1.4T12	1.4	1	24	12	12	85	19.5	12	12.2	-	3
JCTER/L1212X1.4T12	1.4	1	24	12	12	120	19.5	12	12.2	-	3
JCTER/L1212-1.4T12	1.4	1	24	12	12	125	19.5	12	12.2	-	3
JCTER/L1414-1.4T12	1.4	1	24	14	14	125	19.5	14	14.2	-	3
JCTER/L1616X1.4T16	1.4	1	32	16	16	120	24	16	16.2	-	3
JCTER/L1010X2T10	2	2	20	10	10	120	19	10	10.1	2	3
JCTER/L1212F2T12	2	2	24	12	12	85	19	12	12.1	2	3
JCTER/L1212X2T12	2	2	24	12	12	120	19	12	12.1	2	3
JCTER/L1414-2T12	2	2	24	14	14	125	19	14	14.1	-	3
JCTER/L1616X2T16	2	2	32	16	16	120	24	16	16.1	-	3
JCTER/L1212F3T12	3	3	24	12	12	85	19	12	12.3	2	3
JCTER/L1212X3T12	3	3	24	12	12	120	19	12	12.3	2	3
JCTER/L1616X3T16	3	3	32	16	16	120	24	16	16.3	-	3
JCTER/L2020H3T16	3	3	32	20	20	100	24	20	20.3	-	3

(1) "WF" value is calculated with groove width "CW" shown in the table.
 CUTDIA: Max. parting diameter
 Torque: Recommended clamping torque: lbs-ft (*N-m)

SPARE PARTS

Designation	Clamping screw	Wrench
JCTER/L...	CSHB-4-A	T-15F

External deep grooving and parting toolholder, for Swiss lathes

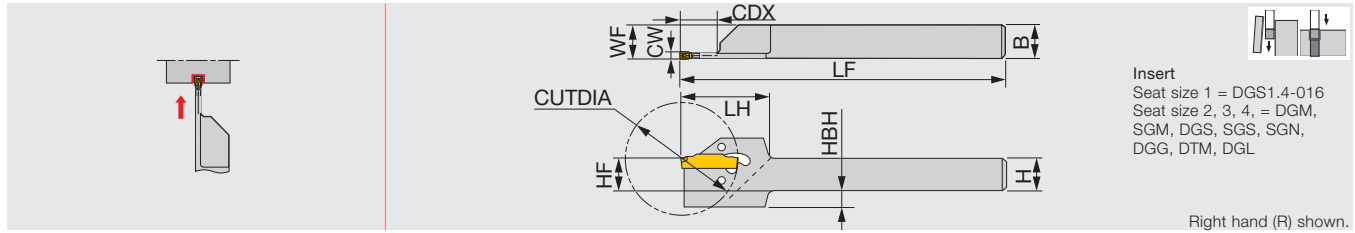

Insert
Seat size 1 = DGS1.4-016
Seat size 2, 3, 4, = DGM,
SGM, DGS, SGS, SGN,
DGG, DTM, DGL

Right hand (R) shown.

Metric	CW	Seat size	CUTDIA ⁽¹⁾	CDX	H	B	LF	LH	HF	WF ⁽²⁾	HBH
CGER/L2020-1.4T14	1.4	1	29/29	9.7	20	20	125	31	20	20.2	-
CGER/L1212-2T17	2	2	35/35	11.8	12	12	150	31	12	12.1	6
CGER/L1616-2T17	2	2	35/35	11.8	16	16	150	31	16	16.1	2
CGER/L2020-2T17	2	2	35/35	9.8	20	20	125	31	20	20.1	-
CGER/L1212-3T19	3	3	38/40	12	12	12	150	31	12	12.3	6
CGER/L1616-3T19	3	3	38/45	14.9	16	16	150	31	16	16.3	2
CGER/L2020-3T19	3	3	38/45	13.2	20	20	125	31	20	20.3	-
CGER/L2020-4T19	4	4	38/55	20.3	20	20	125	33	20	20.4	-

Wrench (CRW**) is not included. Please order it separately. Insert is clamped by the elastic deformation of the upper jaw.

(1) DG*/SG* maximum parting diameter will depend on the insert.

(2) "WF" value is calculated with groove width "CW" shown in the table.

SPARE PARTS



Designation	Wrench (Option)
CGER/L2020-1.4T14	CRW23
CGER/L****-2T17 - 4T19	CRW33

TUNG T^{URN}JET

JCTER/L-CHP



External grooving and parting toolholder with high pressure coolant capability

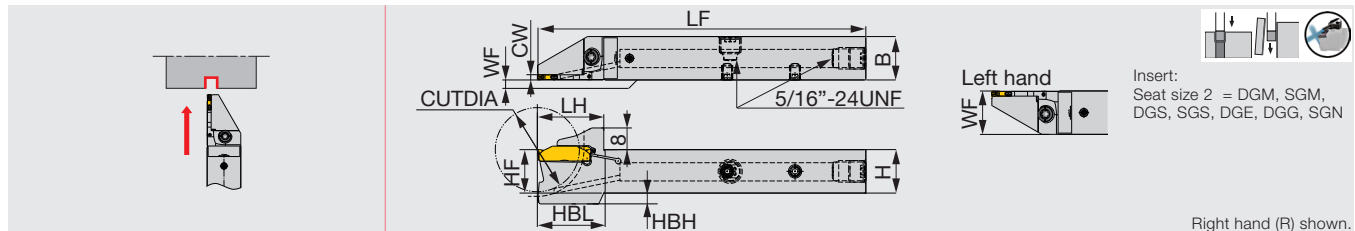

Insert:
Seat size 2 = DGM, SGM,
DGS, SGS, DGE, DGG, SGN

Right hand (R) shown.

Inch	CW (in)	CW (mm)	Seat size	CUTDIA	H	B	LF	LH	HBL	HF	WF ⁽¹⁾	HBH	Torque
JCTER/L08X2T12-CHP	0.079	2	2	0.984	0.500	0.500	4.750	0.972	0.965	0.500	0.000/0.500	0.169	2.21
JCTER/L10X2T12-CHP	0.079	2	2	0.984	0.625	0.625	4.750	0.972	0.965	0.625	0.000/0.625	0.039	2.21
JCTER/L10X2T16-CHP	0.079	2	2	1.260	0.625	0.625	4.750	0.972	0.965	0.625	0.000/0.625	0.157	2.21
JCTER/L12X2T16-CHP	0.079	2	2	1.260	0.750	0.750	4.750	0.972	0.965	0.750	0.000/0.750	0.037	2.21

Metric	CW	Seat size	CUTDIA	H	B	LF	LH	HF	WF ⁽¹⁾	HBH	HBL	Torque*
JCTER/L1212X2T12-CHP	2	2	25	12	12	120	24.7	12	0/12	5	24.7	3
JCTER/L1616X2T12-CHP	2	2	25	16	16	120	24.7	16	0/16	1	24.5	3
JCTER/L1616X2T16-CHP	2	2	32	16	16	120	24.7	16	0/16	4	24.7	3
JCTER/L2020X2T16-CHP	2	2	32	20	20	120	24.7	20	0/20	-	-	3

(1) "WF" value is calculated with groove width "CW" shown in the table. "WF" value depends on the tool hand. With 0/12, WF is 0 for the right hand and 12 for the left hand.

CUTDIA: Max. parting diameter

Torque: Recommended clamping torque: lbs-ft (*N-m)

SPARE PARTS







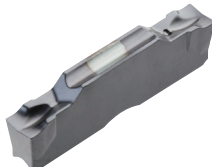
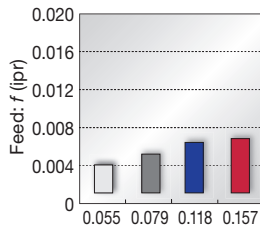
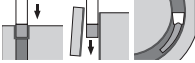
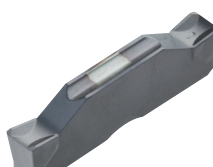
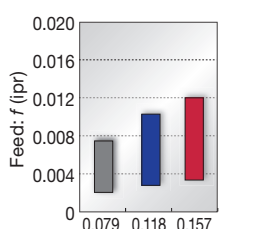
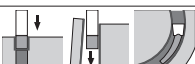

Designation	Clamping screw	Wrench 1	Coolant plug	Wrench 2	DirectJet plug	Wrench 3
JCTER/L...	C5HB-4-A	T-15F	SR5/16UNFTL360	P-4	SSHM4-6-TB	P-2

Groove width: 0.079" (2.0 mm)

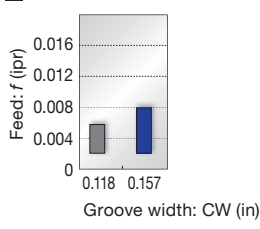
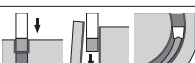
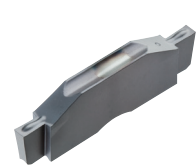
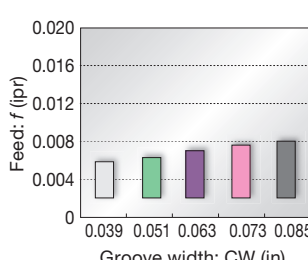
Reference pages: CGER/L, JCTER/L-CHP: Inserts → **G124 - G129**, Standard cutting conditions → **G130**

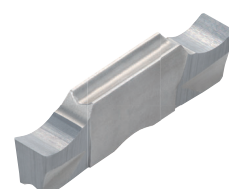
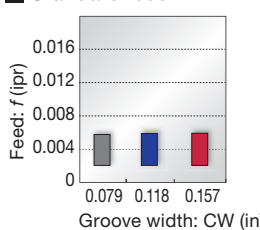
External grooving and parting

<p>DGS type (2 corners) SGS type (1 corner)</p>  <p>G124, G127 page</p>	<p>For Swiss lathes</p> <p>Unique-designed edge and chipbreaker</p> <p>Handed insert available</p> <p>CW = 0.055" - 0.157"</p>	<p>■ Standard feed</p>  <table border="1"> <caption>Feed: f (ipr) vs Groove width: CW (in)</caption> <thead> <tr> <th>Groove width: CW (in)</th> <th>Feed: f (ipr)</th> </tr> </thead> <tbody> <tr> <td>0.055</td> <td>0.004</td> </tr> <tr> <td>0.079</td> <td>0.006</td> </tr> <tr> <td>0.118</td> <td>0.007</td> </tr> <tr> <td>0.157</td> <td>0.008</td> </tr> </tbody> </table>	Groove width: CW (in)	Feed: f (ipr)	0.055	0.004	0.079	0.006	0.118	0.007	0.157	0.008			
Groove width: CW (in)	Feed: f (ipr)														
0.055	0.004														
0.079	0.006														
0.118	0.007														
0.157	0.008														
<p>DGM type (2 corners) SGM type (1 corner)</p>  <p>G125, G126 page</p>	<p>High fracture resistance</p> <p>Smooth chip evacuation</p> <p>Well-designed edge with high strength</p> <p>Handed insert available</p> <p>CW = 0.079" - 0.157"</p>	<p>■ Standard feed</p>  <table border="1"> <caption>Feed: f (ipr) vs Groove width: CW (in)</caption> <thead> <tr> <th>Groove width: CW (in)</th> <th>Feed: f (ipr)</th> </tr> </thead> <tbody> <tr> <td>0.079</td> <td>0.006</td> </tr> <tr> <td>0.118</td> <td>0.010</td> </tr> <tr> <td>0.157</td> <td>0.012</td> </tr> </tbody> </table>	Groove width: CW (in)	Feed: f (ipr)	0.079	0.006	0.118	0.010	0.157	0.012					
Groove width: CW (in)	Feed: f (ipr)														
0.079	0.006														
0.118	0.010														
0.157	0.012														
<p>DGL type (2 corners)</p>  <p>G129 page</p>	<p>1st choice for mild steel</p> <p>Chipbreaker with excellent chip control at low feed</p> <p>Suitable for mild steel that often gives difficulties in chip control</p> <p>CW = 0.118" - 0.157"</p>	<p>■ Standard feed</p>  <table border="1"> <caption>Feed: f (ipr) vs Groove width: CW (in)</caption> <thead> <tr> <th>Groove width: CW (in)</th> <th>Feed: f (ipr)</th> </tr> </thead> <tbody> <tr> <td>0.118</td> <td>0.006</td> </tr> <tr> <td>0.157</td> <td>0.008</td> </tr> </tbody> </table>	Groove width: CW (in)	Feed: f (ipr)	0.118	0.006	0.157	0.008							
Groove width: CW (in)	Feed: f (ipr)														
0.118	0.006														
0.157	0.008														
<p>DGE type (2 corners)</p>  <p>G128 page</p>	<p>For high accurate and shallow groove</p> <p>Excellent chip control</p> <p>CW = 0.039" - 0.085"</p>	<p>■ Standard feed</p>  <table border="1"> <caption>Feed: f (ipr) vs Groove width: CW (in)</caption> <thead> <tr> <th>Groove width: CW (in)</th> <th>Feed: f (ipr)</th> </tr> </thead> <tbody> <tr> <td>0.039</td> <td>0.005</td> </tr> <tr> <td>0.051</td> <td>0.006</td> </tr> <tr> <td>0.063</td> <td>0.007</td> </tr> <tr> <td>0.073</td> <td>0.008</td> </tr> <tr> <td>0.085</td> <td>0.008</td> </tr> </tbody> </table>	Groove width: CW (in)	Feed: f (ipr)	0.039	0.005	0.051	0.006	0.063	0.007	0.073	0.008	0.085	0.008	
Groove width: CW (in)	Feed: f (ipr)														
0.039	0.005														
0.051	0.006														
0.063	0.007														
0.073	0.008														
0.085	0.008														
<p>DGG type (2 corners)</p>  <p>G128 page</p>	<p>For non-ferrous materials and titanium</p> <p>Chipbreaker with low cutting force</p> <p>Sharp cutting edge that prevents vibration and delivers fine surface finish</p> <p>CW = 0.079" - 0.157"</p>	<p>■ Standard feed</p>  <table border="1"> <caption>Feed: f (ipr) vs Groove width: CW (in)</caption> <thead> <tr> <th>Groove width: CW (in)</th> <th>Feed: f (ipr)</th> </tr> </thead> <tbody> <tr> <td>0.079</td> <td>0.005</td> </tr> <tr> <td>0.118</td> <td>0.006</td> </tr> <tr> <td>0.157</td> <td>0.006</td> </tr> </tbody> </table>	Groove width: CW (in)	Feed: f (ipr)	0.079	0.005	0.118	0.006	0.157	0.006					
Groove width: CW (in)	Feed: f (ipr)														
0.079	0.005														
0.118	0.006														
0.157	0.006														

External grooving of hardened steel

**SGN-CBN type
(1 corner)**

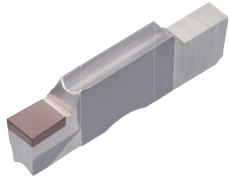

G129 page

For hardened steel cutting

Optimum cutting edge shape for grooving of hardened steels
High tolerance width for finishing
CW = 0.079" - 0.157"
(CW = ±0.001")

■ Standard feed

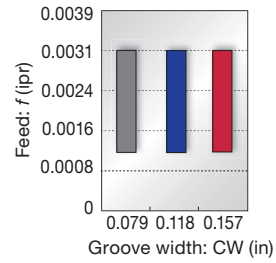

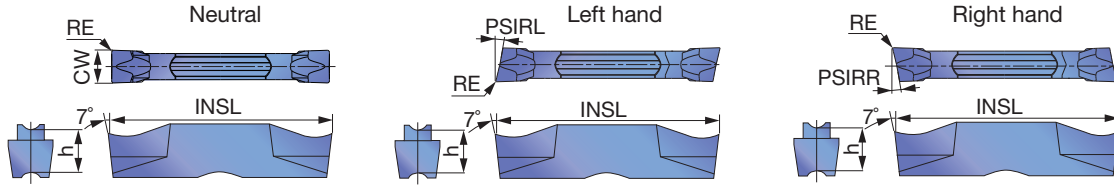

P	Steel	★	★	★	☆	☆			★				
M	Stainless	★		★	☆	★							
K	Cast iron	☆		★		☆			☆				
N	Non-ferrous												
S	Superalloys				★	☆							
H	Hard materials												

★ : First choice
☆ : Second choice

Designation	Seat size	HAND	CW±0.05 (mm)	CW±0.002 (in)	RE (in)	Coated					Cermet		INSL (in)	h (in)	PSIRL	PSIRR
						T9225	T9125	AH7025	AH725	GH130	NS9530					
DGS1.4-016	1	N	1.4	0.055	0.006				●	●			0.630	0.169	0°	0°
DGS2-020	2	N	2	0.079	0.008	●	●	●	●	●	●		0.787	0.197	0°	0°
DGS2-020-6R	2	R	2	0.079	0.008				●	●	●		0.785	0.197	0°	6°
DGS2-020-6L	2	L	2	0.079	0.008				●	●	●		0.785	0.197	6°	0°
DGS2-002-6R	2	R	2	0.079	0.0008				●	●	●		0.768	0.197	0°	6°
DGS2-002-6L	2	L	2	0.079	0.0008				●	●	●		0.768	0.197	6°	0°
DGS2-020-15R	2	R	2	0.079	0.008				●	●	●		0.785	0.197	0°	15°
DGS2-020-15L	2	L	2	0.079	0.008				●	●	●		0.785	0.197	15°	0°
DGS2-002-15R	2	R	2	0.079	0.0008				●	●	●		0.768	0.197	0°	15°
DGS2-002-15L	2	L	2	0.079	0.0008				●	●	●		0.768	0.197	15°	0°
DGS3-020	3	N	3	0.118	0.008	●	●	●	●	●	●		0.787	0.197	0°	0°
DGS3-020-6R	3	R	3	0.118	0.008				●	●	●		0.783	0.197	0°	6°
DGS3-020-6L	3	L	3	0.118	0.008				●	●	●		0.783	0.197	6°	0°
DGS3-002-6R	3	R	3	0.118	0.0008				●	●	●		0.766	0.197	0°	6°
DGS3-002-6L	3	L	3	0.118	0.0008				●	●	●		0.766	0.197	6°	0°
DGS3-020-15R	3	R	3	0.118	0.008				●	●	●		0.783	0.197	0°	15°
DGS3-020-15L	3	L	3	0.118	0.008				●	●	●		0.783	0.197	15°	0°
DGS3-002-15R	3	R	3	0.118	0.0008				●	●	●		0.766	0.197	0°	15°
DGS3-002-15L	3	L	3	0.118	0.0008				●	●	●		0.766	0.197	15°	0°
DGS4-030	4	N	4	0.157	0.012	●	●	●	●	●	●		0.787	0.197	0°	0°
DGS4-030-4R	4	R	4	0.157	0.012				●	●	●		0.780	0.197	0°	4°
DGS4-030-4L	4	L	4	0.157	0.012				●	●	●		0.781	0.197	4°	0°
DGS5-030	5	N	5	0.197	0.012	●	●	●	●	●	●		0.984	0.217	0°	0°
DGS6-030	6	N	6	0.236	0.012	●	●	●	●	●	●		0.984	0.217	0°	0°

● : Line up

Caution

The tool will interfere with the workpiece when grooving larger diameter than ϕD_{max} .

Designation	ϕD_{max} (in)	Designation	ϕD_{max} (in)
DGM2-002-15R/L	1.102	DGS2-002-15R/L	1.102
DGM3-002-15R/L	1.141	DGS3-002-15R/L	1.141
DGM4-030-15R/L	1.181	SGS3-020-15R/L	4.055
SGM3-020-15R/L	4.055	SGS3-002-15R/L	1.338

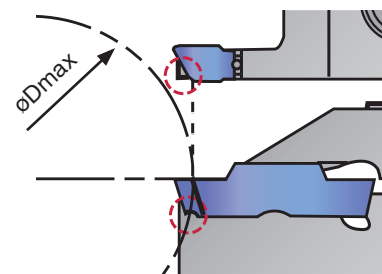

DGM

External grooving and parting, 2 corners

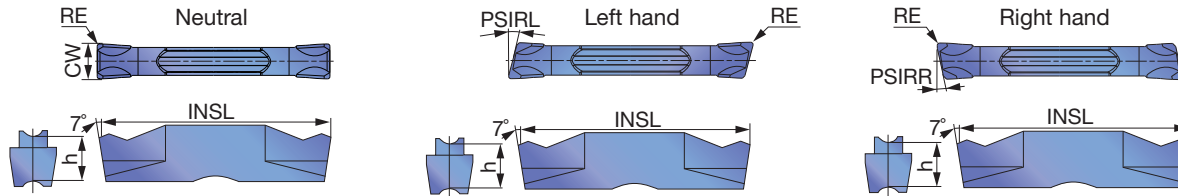

P	Steel	★	★	★	☆	☆	★					
M	Stainless	★		★	☆	★						
K	Cast iron	☆		★		☆	☆			☆		
N	Non-ferrous											
S	Superalloys				★	☆	★					
H	Hard materials											

★ : First choice
☆ : Second choice

Designation	Seat size	HAND	CW±0.05 (mm)	CW±0.002 (in)	RE (in)	Coated						Cermet		INSL (in)	h (in)	PSIRL	PSIRR
						T9225	T9125	AH7025	AH725	AH905	GH130	NS9530					
DGM2-020	2	N	2	0.079	0.008	●	●	●	●	●	●	●		0.787	0.197	0°	0°
DGM2-020-6R	2	R	2	0.079	0.008			●	●	●	●	●		0.780	0.197	0°	6°
DGM2-020-6L	2	L	2	0.079	0.008			●	●	●	●	●		0.780	0.197	6°	0°
DGM2-020-8R	2	R	2	0.079	0.008			●	●	●	●	●		0.780	0.197	0°	8°
DGM2-020-8L	2	L	2	0.079	0.008			●	●	●	●	●		0.780	0.197	8°	0°
DGM2-020-15R	2	R	2	0.079	0.008			●	●	●	●	●		0.780	0.197	0°	15°
DGM2-020-15L	2	L	2	0.079	0.008			●	●	●	●	●		0.780	0.197	15°	0°
DGM2-002-15R	2	R	2	0.079	0.0008			●	●	●	●	●		0.762	0.197	0°	15°
DGM2-002-15L	2	L	2	0.079	0.0008			●	●	●	●	●		0.762	0.197	15°	0°
DGM3-020	3	N	3	0.118	0.008	●	●	●	●	●	●	●		0.787	0.197	0°	0°
DGM3-020-6R	3	R	3	0.118	0.008			●	●	●	●	●		0.783	0.197	0°	6°
DGM3-020-6L	3	L	3	0.118	0.008			●	●	●	●	●		0.783	0.197	6°	0°
DGM3-002-6R	3	R	3	0.118	0.0008			●	●	●	●	●		0.766	0.197	0°	6°
DGM3-002-6L	3	L	3	0.118	0.0008			●	●	●	●	●		0.766	0.197	6°	0°
DGM3-020-15R	3	R	3	0.118	0.008			●	●	●	●	●		0.783	0.197	0°	15°
DGM3-020-15L	3	L	3	0.118	0.008			●	●	●	●	●		0.783	0.197	15°	0°
DGM4-030	4	N	4	0.157	0.012	●	●	●	●	●	●	●		0.787	0.197	0°	0°
DGM4-030-4R	4	R	4	0.157	0.012			●	●	●	●	●		0.780	0.197	0°	4°
DGM4-030-4L	4	L	4	0.157	0.012			●	●	●	●	●		0.780	0.197	4°	0°
DGM4-030-15R	4	R	4	0.157	0.012			●	●	●	●	●		0.780	0.197	0°	15°
DGM4-030-15L	4	L	4	0.157	0.012			●	●	●	●	●		0.780	0.197	15°	0°
DGM5-030	5	N	5	0.197	0.012	●	●	●	●	●	●	●		0.984	0.217	0°	0°
DGM5-030-4R	5	R	5	0.197	0.012			●	●	●	●	●		0.980	0.217	0°	4°
DGM6-030	6	N	6	0.236	0.012	●	●	●	●	●	●	●		0.984	0.217	0°	0°
DGM8-040	8	N	8	0.315	0.016	●	●	●	●	●	●	●		1.181	0.264	0°	0°

● : Line up

Grade
Insert
Toolholder
Ext. Toolholder
Int. Toolholder
Threading
Grooving
Miniature Tool
Milling Cutter
Endmill
Drilling Tool
Tooling System
User's Guide
Index



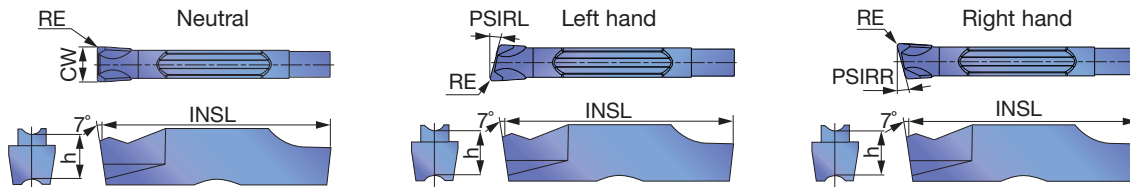

P	Steel	★	☆	☆									
M	Stainless	★	☆	★									
K	Cast iron	★		☆									
N	Non-ferrous												
S	Superalloys	★	☆										
H	Hard materials												

★ : First choice
☆ : Second choice

Designation	Seat size	HAND	CW±0.05 (mm)	CW±0.002 (in)	RE (in)	Coated			INSL (in)	h (in)	PSIRL	PSIRR
						AH7025	AH725	GH130				
SGM2-020	2	N	2	0.079	0.008	●	●	●	0.787	0.197	0°	0°
SGM2-020-6R	2	R	2	0.079	0.008	●	●	●	0.787	0.197	0°	6°
SGM2-020-6L	2	L	2	0.079	0.008	●	●	●	0.787	0.197	6°	0°
SGM3-020	3	N	3	0.118	0.008	●	●	●	0.787	0.197	0°	0°
SGM3-020-6R	3	R	3	0.118	0.008	●	●	●	0.787	0.197	0°	6°
SGM3-020-6L	3	L	3	0.118	0.008	●	●	●	0.787	0.197	6°	0°
SGM3-020-15R	3	R	3	0.118	0.008	●	●	●	0.787	0.197	0°	15°
SGM3-020-15L	3	L	3	0.118	0.008	●	●	●	0.787	0.197	15°	0°
SGM4-030	4	N	4	0.157	0.012	●	●	●	0.787	0.197	0°	0°
SGM4-030-4R	4	R	4	0.157	0.012	●	●	●	0.787	0.197	0°	4°
SGM4-030-4L	4	L	4	0.157	0.012	●	●	●	0.787	0.197	4°	0°
SGM5-030	5	N	5	0.197	0.012	●	●	●	0.984	0.217	0°	0°
SGM6-030	6	N	6	0.236	0.012	●	●	●	0.984	0.217	0°	0°

● : Line up

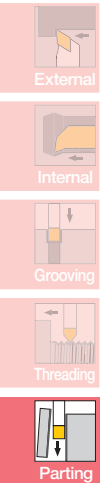

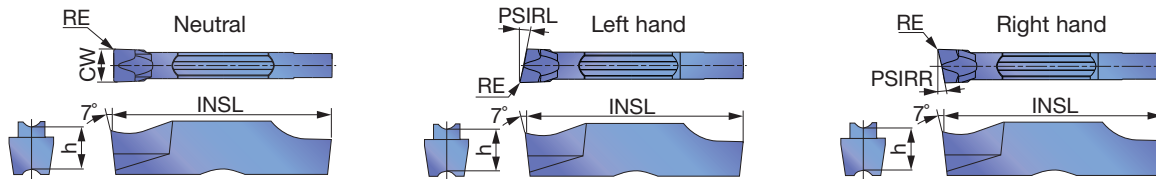

P	Steel	★	☆	☆								
M	Stainless	★	☆	★								
K	Cast iron	★		☆								
N	Non-ferrous											
S	Superalloys	★	☆									
H	Hard materials											

★ : First choice
☆ : Second choice

Designation	Seat size	HAND	CW±0.05 (mm)	CW±0.002 (in)	RE (in)	Coated			INSL (in)	h (in)	PSIRL	PSIRR
						AH7025	AH725	GH130				
SGS2-020	2	N	2	0.079	0.008	●	●	●	0.787	0.197	0°	0°
SGS2-020-6R	2	R	2	0.079	0.008	●	●	●	0.787	0.197	0°	6°
SGS2-020-6L	2	L	2	0.079	0.008	●	●	●	0.787	0.197	6°	0°
SGS2-020-15R	2	R	2	0.079	0.008	●	●	●	0.787	0.197	0°	15°
SGS2-020-15L	2	L	2	0.079	0.008	●	●	●	0.787	0.197	15°	0°
SGS3-020	3	N	3	0.118	0.008	●	●	●	0.787	0.197	0°	0°
SGS3-020-6R	3	R	3	0.118	0.008	●	●	●	0.787	0.197	0°	6°
SGS3-020-6L	3	L	3	0.118	0.008	●	●	●	0.787	0.197	6°	0°
SGS3-002-6R	3	R	3	0.118	0.0008		●	●	0.780	0.197	0°	6°
SGS3-002-6L	3	L	3	0.118	0.0008		●	●	0.780	0.197	6°	0°
SGS3-020-15R	3	R	3	0.118	0.008	●	●	●	0.787	0.197	0°	15°
SGS3-020-15L	3	L	3	0.118	0.008	●	●	●	0.787	0.197	15°	0°
SGS3-002-15R	3	R	3	0.118	0.0008		●	●	0.780	0.197	0°	15°
SGS3-002-15L	3	L	3	0.118	0.0008		●	●	0.780	0.197	15°	0°
SGS4-030	4	N	4	0.157	0.012	●	●	●	0.787	0.197	0°	0°
SGS5-030	5	N	5	0.197	0.012	●	●	●	0.984	0.217	0°	0°
SGS6-030	6	N	6	0.236	0.012	●	●	●	0.984	0.217	0°	0°

● : Line up



DGE

External grooving (for high precision)

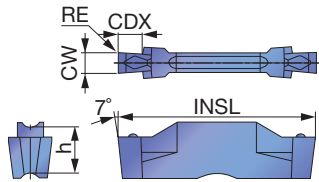

P	Steel	★	☆	☆				★				
M	Stainless	★	☆	★								
K	Cast iron	★		☆				☆				
N	Non-ferrous											
S	Superalloys	★	☆									
H	Hard materials											

★ : First choice
☆ : Second choice

Designation	Seat size	CW±0.05 (mm)	CW±0.002 (in)	RE (in)	Coated			Cermet	CDX (in)	INSL (in)	h (in)	
					AH7025	AH725	GH130	NS9530				
DGE100-000	2	1	0.039	0		●	●		●	0.098	0.787	0.197
DGE130-000	2	1.3	0.051	0		●	●		●	0.098	0.787	0.197
DGE160-010	2	1.6	0.063	0.004	●	●	●		●	0.098	0.787	0.197
DGE185-010	2	1.85	0.073	0.004	●	●	●		●	0.138	0.787	0.197
DGE215-015	2	2.15	0.085	0.006	●	●	●		●	0.138	0.787	0.197

● : Line up

Caution

øDmax is limited as shown in the picture to the right according to the groove depth, G.D. Please refer to the following table.

G.D = Groove depth

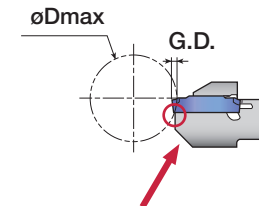

Relevant area (Interference)

Designation	Max. groove depth (in)	øDmax (in)				
		G.D. = 0.039	G.D. = 0.059	G.D. = 0.079	G.D. = 0.098	G.D. = 0.118
DGE100-000	0.079	∞	0.73	0.45	-	-
DGE130-000					-	-
DGE160-010	0.118	∞	0.73	0.45	0.35	0.28
DGE185-010					0.35	0.28
DGE215-015					0.35	0.28

DGG

External grooving (for high precision)

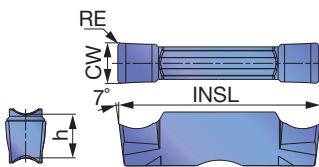

P	Steel	★		★								
M	Stainless	★										
K	Cast iron	★		☆				☆				
N	Non-ferrous							★				
S	Superalloys	★						☆				
H	Hard materials											

★ : First choice
☆ : Second choice

Designation	Seat size	CW±0.02 (mm)	CW±0.001 (in)	RE (in)	Coated	Cermet	Uncoated	INSL (in)	h (in)
					AH7025	NS9530	KS05F		
DGG200-020	2	2	0.079	0.008	●	●	●	0.787	0.197
DGG300-020	3	3	0.118	0.008	●	●	●	0.787	0.197
DGG400-040	4	4	0.157	0.016	●	●	●	0.787	0.197
DGG500-040	5	5	0.197	0.016	●	●	●	0.984	0.217
DGG600-040	6	6	0.236	0.016	●	●	●	0.984	0.217

● : Line up

Reference pages: Toolholders → G121, Standard cutting conditions → G130

DGL

External grooving and parting

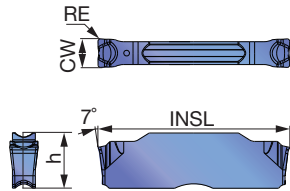

P	Steel	★								
M	Stainless	★								
K	Cast iron	★								
N	Non-ferrous									
S	Superalloys	★								
H	Hard materials									

★ : First choice
☆ : Second choice

Designation	Seat size	CW±0.05 (mm)	CW±0.002 (in)	RE (in)	Coated						INSL (in)	h (in)	
					AH7025								
DGL3-025	3	3	0.118	0.010	●							0.787	0.197
DGL4-030	4	4	0.157	0.012	●							0.787	0.197
DGL5-030	5	5	0.197	0.012	●							0.984	0.217
DGL6-080	6	6	0.236	0.031	●							0.984	0.217

● : Line up

SGN

External grooving of hardened steel

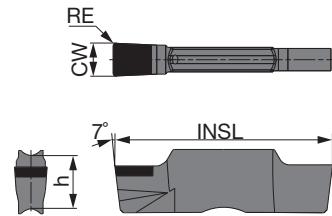

P	Steel									
M	Stainless									
K	Cast iron									
N	Non-ferrous									
S	Superalloys									
H	Hard materials	★								

★ : First choice
☆ : Second choice

Designation	Seat size	CW±0.025 (mm)	CW±0.001 (in)	RE (in)	CBN						INSL (in)	h (in)	
					BX360								
SGN200-020	2	2	0.079	0.008	●							0.787	0.197
SGN300-020	3	3	0.118	0.008	●							0.787	0.197
SGN400-020	4	4	0.157	0.008	●							0.787	0.197

● : Line up



STANDARD CUTTING CONDITIONS

ISO	Workpiece material	Hardness	Chipbreaker	Priority	Grade	Cutting speed Vc (sfm)
P	Steel 1045, 4135, etc.	< 300 HB	DGS	First choice	AH7025, AH725	164 - 591
		< 300 HB	DGM	Priority for wear resistance	T9225	262 - 984
		< 300 HB	DGM	Priority for wear resistance	T9125	262 - 656
		< 300 HB	DGS	Priority for fracture resistance	GH130	164 - 394
		< 300 HB	DGS	Priority for surface finish	NS9530	262 - 722
		< 300 HB	DGL	For mild steel Chip control	AH7025	164 - 591
M	Stainless steel 304SS, 316SS, 17-4 PH, etc.	< 200 HB	DGS	First choice	GH130	164 - 394
		< 200 HB	DGM	Priority for impact resistance	AH7025, AH725	164 - 394
K	Gray cast iron No.250B, No.300B, etc.	-	DGM	First choice	GH130	164 - 591
	Ductile cast iron 60-40-18, 60-55-06, etc.	-	DGM	First choice	GH130	164 - 394
N	Aluminum alloys Si < 12%	-	DGG	First choice	KS05F	328 - 1640
S	Titanium alloys Ti-6Al-4V, etc.	< HRC 40	DGM	First choice	AH905	66 - 262
		< HRC 40	DGS	Priority for fracture resistance	AH7025, AH725	66 - 262
H	Hardened steel 4137, etc.	> HRC 50	DGN	First choice	BX360	262 - 492

See page **G122 - G123** for feed: f (ipr).

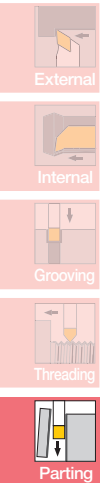

Reference pages: Toolholders → **G121**

Milling Cutter



Milling Cutter - Content structure

- Products are listed by application.
- Please refer the table of contents and the icons.

How to use the page

Method ①

Select the application (1) and the approach angle (2) at the left end of each page and choose a designation you need (5) in the dimension table (4). Applicable inserts are shown in (8).

TUNEFREE EXLS
High feed endmill, shank type

① Application icons: Face Milling, Shoulder Milling, Slot Milling, Profile Milling, Thread Milling, Other

② Approach angle selection: 10°, 45°, 70°, 85°, 90°, Custom

④ Dimension table (APAX, DCX, CICT, DC, DCONMS, LS, LH, LF, WT (kg), Air hole, Insert)

⑤ Tool designation table

⑧ Applicable inserts

TUNEFREE HXLS
High feed endmill, shank type

④ Dimension table (APAX, DCX, CICT, DC, DAL, LF, H, DCSFMS, CRMS, WT (kg), Air hole, Insert)

Method ②

Select the tool series name on **H008 - H009** and check the details on the product page.

Application Overview

Face milling, High feed milling H020 - H091 page

- General face milling: **DO TALL** (H003 page), **DO OCTO** (H003 page), **DO Q MILL** (H007 page), **DO PENT** (H009 page)
- Aluminum machining: **TUNE MILL** (H079 page), **TPE** (H081 page), **TUNE-ALUMILL** (H143 page)

High feed milling

- DO FEED** (H026 page)
- DO TALL** (H036 page)
- MILLO FEED** (H046 page)

Profile milling H162 - H188 page

- Roughing: **TUNE FEED** (H022 page), **DO FEED** (H026 page), **DO TALL** (H036 page)
- Semi-finishing: **TUNEMASTER** (H008 page)
- Finishing: **BALL FINISH** (H166 page)

H008 www.tungaloy.com/us

Method ③

Select the tool series or the tool specification on **H010 - H019** and see the details on each page.

High-Feed Milling - Quick Guide

	TUNEFREE	DO FEED	DO TALL	DO PENT	MILLO FEED
Cutting edge angle	12°	15° / 13°	20° / 25°	13°	7° / 10° / 12° / 14°
Depth of cut (APM)	0.015"	0.025" / 0.020"	0.051" / 0.025"	0.075"	0.025" / 0.020" / 0.015" / 0.010"
Tool diameter	Ø0.075 - Ø0.090	Ø0.090 - Ø0.095	Ø1.000 - Ø0.010	Ø2.000 - Ø5.000	Ø1.000 - Ø5.000
Workpiece material	Al, Cu, S, H	Al, Cu, S, H	Al, Cu, S, H	Al, Cu, S, H	Al, Cu, S, H
ISO 6500 series	2	4	4	5	4
Face milling	★	★	★	★	★
Shoulder milling	★	★	★	★	★
Profile milling	★	★	★	★	★
Slot milling	★	★	★	★	★
Other applications	★	★	★	★	★
Reference pages	H022 - H025	H026 - H035	H036 - H042	H043 - H045	H046 - H050

Icon: ★ Most suitable, ☆ Suitable

H010 www.tungaloy.com/us

Icon

Approach angle

- 10° ~ 20°
- 45°
- 70°
- 85°
- 88°
- 90°

Application

- Thin workpiece
- Ramping
- Long overhang
- Axial plunging
- Hole enlarging
- Slot milling

- Deep shoulder milling
- Face milling
- External threading
- Back facing
- Peck milling
- Hollow workpiece

- Chamfering
- Shoulder milling
- Internal threading
- Profiling
- Edging / Contouring
- Interrupted surface
- Cutting off

3 BALL NOSE EBRU...
Ball nose endmill for semi-roughing, shank type, with screw clamp system

6

5

Inch	APMX	DC	CICT	DCONMS	LS	LF	LH	LB	BHTA	WT(kg)	Air hole	Insert
EBRU0625W0625D475	0.475	0.625	2	0.625	3.375	4.748	1.373	0.331	3.000	0.330	With	ZRBUE02-MM
EBRU075W075D600	0.610	0.750	2	0.750	4.000	6.000	2.000	0.656	3.000	0.610	With	ZRBUE075-MM
EBRU100W100D600	0.985	1.000	2	1.000	3.250	6.000	2.250	1.250	3.000	1.250	With	ZRBUE100-MM

4

7

SPARE PARTS

Description	Coating	Grade	Material
EBRU0625...	TS20064	T-4D	
EBRU075...	TS30072	T-9D	
EBRU100...	TS30085HG	T-15D	

*Recommended clamping torque : TS20064 = 0.96 lbs-ft, TS30085HG = 2.58 lbs-ft

10 Reference pages: Inserts, Standard cutting conditions → H165

H164 www.tungaloy.com/us

8 INSERT ZRBM...

9

Designation	RE	APMX	LE	S
ZRBU062-MM	0.313	0.313	0.586	0.118
ZRBU075-MM	0.375	0.375	0.648	0.140
ZRBU100-MM	0.500	0.500	0.855	0.173

5 piece per package

STANDARD CUTTING CONDITIONS

ISO	Workpiece materials	Hardness	Selection criteria	Recommended grade	Chip-breaker	Cutting speed Vc (sfm)	Feed per tooth Fz (ip)
P	Low carbon steel 1015, 1020, etc.	- 300HB	First choice	APH730	MM	490 - 1145	0.004 - 0.024
	High carbon and alloy steel 1055, 4140, etc.	- 300HB	First choice	APH730	MM	390 - 1045	0.002 - 0.02
M	Phenolic steels INVAR, P20, etc.	30 - 40HRC	First choice	APH730	MM	325 - 655	0.002 - 0.02
	Austenitic stainless steel 304SS, 316SS, etc.	- 200HB	First choice	APH730	MM	325 - 915	0.002 - 0.024
K	Martensitic stainless steel 420SS, etc.	- 200HB	First choice	APH730	MM	325 - 980	0.002 - 0.024
	Gray cast irons Class25, Class30, etc.	150 - 250HB	First choice	APH730	MM	390 - 1245	0.004 - 0.024
S	Ductile cast iron 60-40-18, 80-50-05, etc.	150 - 250HB	First choice	APH730	MM	325 - 915	0.004 - 0.02
	Titanium alloy Ti-6Al-4V, etc.	-	First choice	APH730	MM	65 - 260	0.002 - 0.024
H	Heat-treated alloys Inconel718, etc.	-	First choice	APH730	MM	65 - 195	0.002 - 0.016
	Hardened steel H13, etc.	40 - 50HRC	First choice	APH730	MM	130 - 260	0.002 - 0.008
	Hardened steel D2, etc.	50 - 60HRC	First choice	APH730	MM	95 - 195	0.002 - 0.006

The above cutting parameters are for reference. Adjustments may be required depending on applications, machine powers and rigidity, and/or workpiece lubricating methods.

Tungaloy H165

- 1 : Application
- 2 : Approach angle
- 3 : Tool series name
- 4 : Dimension table
- 5 : Mill designation
- 6 : Dimension drawing (conforming to ISO13399)
- 7 : Spare parts
- 8 : Insert
- 9 : Standard cutting conditions
- 10 : Reference page

Machining accuracy

F	Finishing
M	Medium cutting
R	Roughing



Coolant hole

Workpiece material

P	Steel
M	Stainless
K	Cast iron
N	Non-ferrous
S	Superalloys
H	Hard material

When ordering

- Please specify the designation and quantity for mills.
e.g. **TPW13R200U0075A03** ... 1 (one mill per package)
- Please specify the designation, grade, and quantity for inserts.
e.g. **SWMT1304PDPR-MJ AH120** ... 10 (10 inserts per package)

*You will find a note if the number per package is not 10.

Designation system for Cutter



Symbol	Type
T	Bore type
E	Endmill type
L	Longedge type
H	Modular
1	Type

Symbol	Type
TN	TN**
SN	SN**
LN	LN**
LS	LS**
3	First alphabet of insert

Symbol	Type
B	Bore type
C	Cylindrical shank
M	Modular
W	Weldon shank
S	TungMeister
7	Type of connection

Symbol	Size	Symbol	Size
B: Bore type Hole diameter		C: Cylindrical W: Weldon shank Shank diameter	
0.75	0.75 in	0.75	0.75 in
1.25	1.25 in	1.25	1.25 in
20.0	20 mm	10.0	10 mm
47.6	47.6 mm	25.0	25 mm
M: Modular Thread size		V: TungMeister Connection size	
06	M6	05	S05
10	M10	08	S08
8	Attachment size		

Symbol	Type
10	No. of inserts

1 **T** **2** **A** **3** **SN** **4** **13** **5** **U** **6** **3.00** **7** **B** **8** **1.00** **9** **R** **10** **08**

1 **E** **2** **P** **3** **TN** **4** **12** **5** **U** **6** **1.25** **7** **C** **8** **1.25** **9** **R** **10** **03** **11** **N**

Symbol	Type
A	40° ~ 45°
E	70°
H	88°
P	90°
X	High feed
F	Special
T	Thread mill

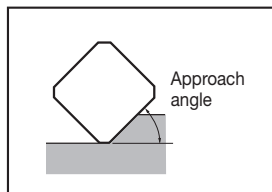

Symbol	Size (ℓ)
S	
T	
R	
H	
A	

Symbol	Type
M	ISO
J	JIS
U	Inch

Symbol	Size
M / J: Unit in mm	
080	80 mm
200	200 mm
U: Unit in inch	
2.00	2 in

Symbol	Hand
R	Right hand
L	Left hand
N	Neutral

Symbol	Type
L	Long shank
N	No coolant hole

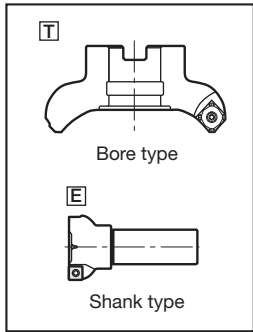

H Hybrid TAC Mill Series

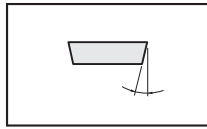

Symbol	Relief angle
C	7°
P	11°
D	15°
E	20°
F	25°
N	0°
Others	Special

Symbol	Type
T~: General type	
-	JIS
E	ISO
A	ANSI
E~: Shank type	
-	Cylindrical
W	Weldon
C	Combination

Symbol	Type
T	Bore type
E	Shank type

Symbol	Hand
R	Right
L	Left

Symbol	Unit
M	mm
U	in

10 Number of inserts

1 T **2** P **3** A **4** 10 **5** R **6** 200 **7** U **8** 0075 **9** A **10** 04

1 E **2** P **3** A **4** 15 **5** R **6** 150 **7** U **8** 0125 **9** W **10** 02 **11** L

2 Angle, Category

Symbol	Cutting edge angle
P	90° ~ 80°
E	80° ~ 70°
D	60° ~ 50°
A	50° ~ 40°
L	With long cutting edge
Others	Special

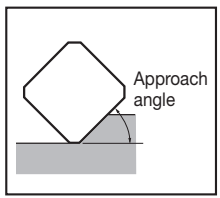

4 Cutting edge length

Symbol	Size (ℓ)
S	
T	
R	
H	
A	

6 Effective cutter diameter

Symbol	Size
M: Unit in mm	
080	80 mm
200	200 mm
I: Unit in inch	
200	2 in

8 Attachment size

Symbol	Size
M: Unit in mm Hole diameter	
20.0	20 mm
25.4	25.4 mm
31.7	31.75 mm
47.6	47.625 mm
I: Unit in inch Hole diameter	
0075	0.75 in
0125	1.25 in
0200	2 in
E~: Shank type Shank diameter	
10.0	10 mm
12.0	12 mm
16.0	16 mm
25.0	25 mm
32.0	32 mm

11 Additional feature

Symbol	Type
W	Wedge clamp
L	Long shank
LE	Long edge
CS	Carbide shank
N	No coolant hole

Designation system for Insert



Symbol	Hole	Shape of hole	Chipbreaker	Shape
N	Without	-	Without	
R			Single-sided	
F			Double-sided	
W	With	Partly cylindrical hole, single-side 40° ~ 60° Counter sink	Without	
T			Single-sided	
Q		Partly cylindrical hole, double-side 40° ~ 60° Counter sink	Without	
U			Double-sided	
B		Partly cylindrical hole, single-side 70° ~ 90° Counter sink	Without	
H			Single-sided	
C	Partly cylindrical hole, double-side 70° ~ 90° Counter sink	Without		
J		Double-sided		
X	-	-	-	-

4 Groove and hole

Shape	Cutting edge length (ℓ)
S	
T	
R	
H	
A	

5 Cutting edge length

Symbol	Thickness (mm)
02	2.38
03	3.18
T3	3.97
04	4.76
05	5.56
06	6.35
07	7.94
09	9.52

6 Thickness

(Example)

Metric

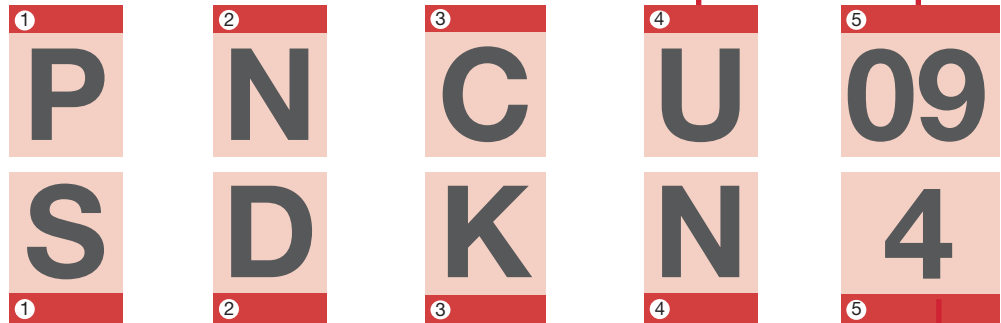

(Example)

Inch



1 Shape			
Symbol	Shape	Nose angle (degree)	Figure
H	Hexagonal	120°	
S	Square	90°	
T	Triangular	60°	
C	Rhombic	80°	
E		75°	
G		70°	
L	Rectangular	90°	
A	Parallelogram	85°	
R	Round		
W	Wiper	80°	
W	Special	-	
O	Octagonal	135°	
P	Pentagonal	108°	
X	Special	Others	
Y	Special		
Z	Special		

2 Relief angle	
Symbol	Relief angle
C	7°
D	15°
E	20°
F	25°
G	30°
M	Others
N	0°
P	11°
Q	Other applications
O	Other applications
X	Other applications
S	Other applications
W	2-step relief

3 Accuracy (mm)			
Symbol (class)	Corner height (m)	Thickness (s)	I. C. dia. (ød)
A	± 0.005	± 0.025	± 0.025
C	± 0.013	± 0.025	± 0.025
E	± 0.025	± 0.025	± 0.025
G	± 0.025	± 0.13	± 0.025
H	± 0.013	± 0.025	± 0.013
K	± 0.013	± 0.025	± 0.05 ~ ± 0.13
M	± 0.08 ~ ± 0.18	± 0.13	± 0.05 ~ ± 0.13
N	± 0.08 ~ ± 0.18	± 0.025	± 0.05 ~ ± 0.13

Standard I. C. dia.	I. C. dia. (ød) tolerance		Corner height (mm) tolerance	
	J, K, L, M, N	U	M, N	U
6.35	± 0.05	± 0.08	± 0.08	± 0.13
9.525				
12.7	± 0.08	± 0.13	± 0.13	± 0.2
15.875				
19.05	± 0.1	± 0.18	± 0.15	± 0.27
25.4				
	± 0.13	± 0.25	± 0.18	± 0.38

Symbol	Cutting edge angle
A	45°
D	60°
E	75°
F	85°
G	70°
H	87°
P	90°
U	Special, small entering angle
Z	Special, universal

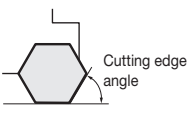

7 Cutting edge angle

Symbol	Relief angle
A	3°
B	5°
C	7°
D	15°
E	20°
F	25°
G	30°
N	0°
P	11°
Z	Special



8 Wiper relief angle

Symbol	Cutting edge	Shape
F	Sharp	
E	Round	
T	Chamfer	
S	Combination	
P	Combination	

9 Major cutting edge

Symbol	Hand of insert
R	Right
L	Left
N	Without

10 Hand of insert

Symbol	Description
HM	General-purpose high feed milling chipbreaker
MM	General-purpose milling chipbreaker
MW	Milling insert with wiper edge
B	Milling insert for burr removal
D	Insert with diamond sintered body
W	Wiper insert (multiple corners)
WS	Wiper insert (single corner)
WD	Wiper insert (with diamond sintered body)
BD	Wiper for burr removal (diamond sintered body)
MJ	General-purpose milling chipbreaker
MH	Milling chipbreaker with reinforced cutting edge
ML	Milling chipbreaker for low cutting force
MS	Milling chipbreaker for stainless steel
HJ	High feed milling chipbreaker
AJ	Milling chipbreaker for non-ferrous metal
NMJ	General-purpose milling chipbreaker with serration
NAJ	Milling chipbreaker with serration for non-ferrous metal

11 Supplementary symbol

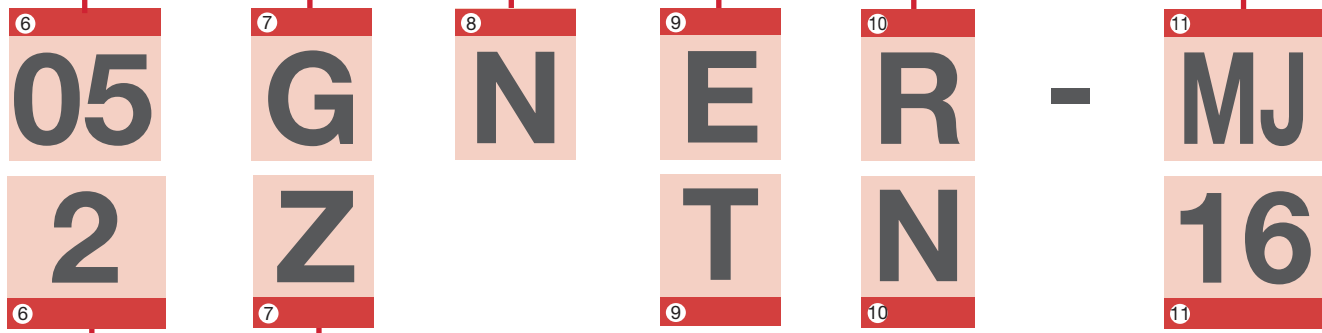

4 Groove and hole		
Symbol	Shape of hole	Hole
A	Without	With
F	Double side	Without
G	Double side	With
M	Single side	With
N	Without	With
U	Without	Without
W	Without	With

5 Inscribed circle (I. C.)		
	Symbol	I. C. dia. (mm)
Inch	3	9.525
	4	12.7
	5	15.875
	6	19.05

6 Thickness		
	Symbol	Thickness (mm)
Inch	2	3.18
	3	4.76
	4	6.35
	6	9.52

7 Corner radius	
Symbol	Corner radius (mm)
1	0.4 (0.397)
2	0.8 (0.794)
3	1.2 (1.191)
4	1.6 (1.588)
5	2.0 (1.984)
6	2.4 (2.381)

Symbol	Description
F	Special design (e.g. for MS cutter)
H	 Chamfer for corner angle 60°
S	 Chamfer for corner angle 15°
Z	 Flat chamfer

*For wiper inserts, the designation uses "W" as the shape symbol of inch items. For metric items, the shape symbol is the same as that of regular inserts, and a supplementary symbol, such as W, WS, and WD, is at the end of each designation.



Application Overview

Face milling, High feed milling H020 - H091 page

General face milling

DO^TMILL H060 page

DOOCTO H063 page

DO^{UAP}Q^{UAP}MILL H067 page

DOPENT H069 page



Aluminum machining

TUNG^SMILL H079 page

TFE H081 page

TUNG-ALUMILL H143 page



High feed milling

DO^{FEED}FEED H026 page

DO^{TWIST}TBALL H036 page

MILL^{UAP}Q^{UAP}FEED H046 page

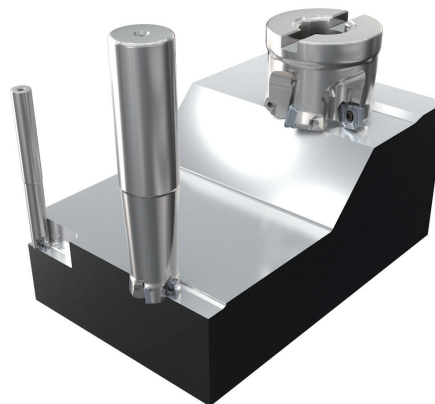

Profile milling H162 - H188 page

Roughing

TUNG^{FORCE}FEED H022 page

DO^{FEED}FEED H026 page

DO^{TWIST}TBALL H036 page

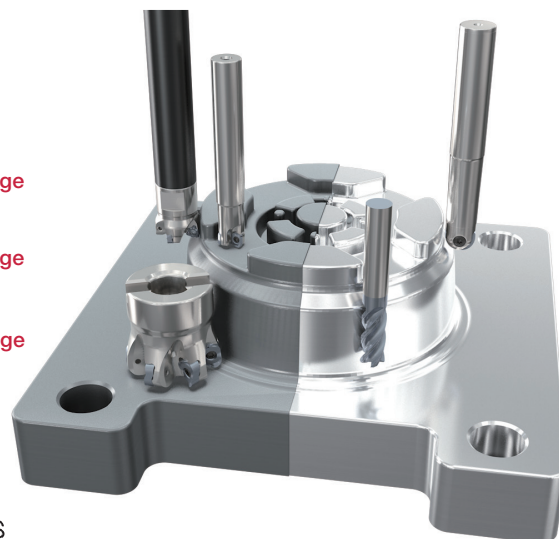

Semi-finishing

TUNGMEISTER I019 page

Finishing

BALL^{FINISH}NOSE H166 page

Shoulder milling H092 - H149 page

Shoulder milling (double side)

DOFTRI H094 page

DOREC H136 page

TECMILL H140 page

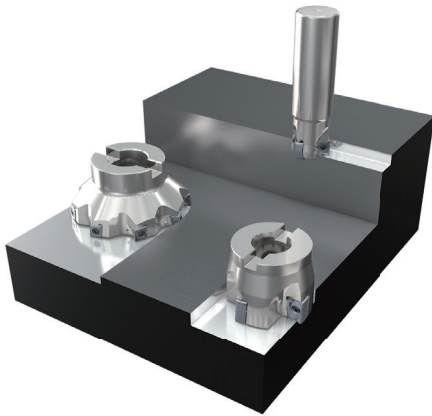

Shoulder milling (single side)

TUNG-TRI H097 page

TUNG^{TS}SHRED H108 page

TUNG^{FORCE}REC H111 page

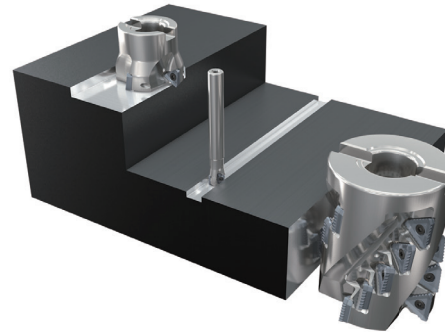

Other applications H150 - H161 page

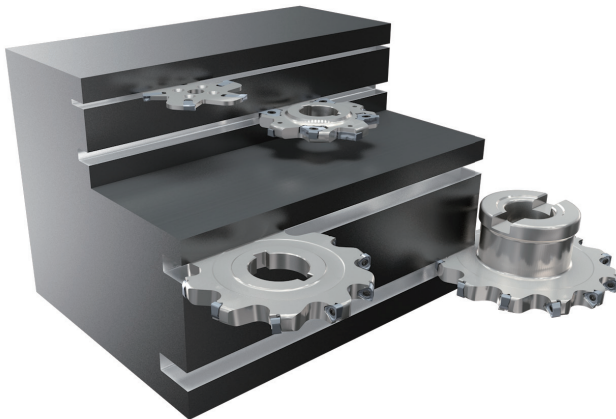

Slot milling

TUNG^MSLIT H151 page

TUNG^{MIN}SLIT H155 page

TUNG^{UNIVERSAL}SLIT H157 page

TEC^TSLIT H159 page

Thread milling H190, H204, H210 page

TUNG^{MEISTER} I006 page

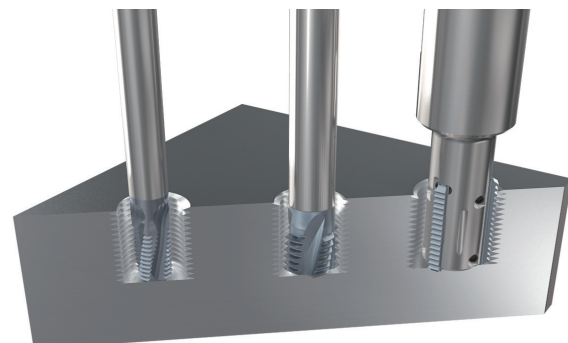



















★ : Most suitable
 ☆ : Suitable
 ☆ : Usable









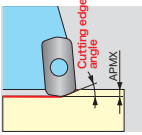

High-Feed Milling - Quick Guide

- High Feed Milling
- Face Milling
- Shoulder Milling
- Slot Milling
- Profile Milling
- Thread Milling
- Other

	TUNG ^{FORCE} FEED	DOFEED	DO ^{TWIST} BALL	DOFEEDQUAD	MILL ^Q FEED
					
	Inch <input checked="" type="checkbox"/> Metric <input checked="" type="checkbox"/>	Inch <input checked="" type="checkbox"/> Metric <input checked="" type="checkbox"/>	Inch <input checked="" type="checkbox"/> Metric <input checked="" type="checkbox"/>	Inch <input checked="" type="checkbox"/> Metric <input type="checkbox"/>	Inch <input checked="" type="checkbox"/> Metric <input type="checkbox"/>
Cutting edge angle	12°	15° / 17°	20° / 25°	13°	7° / 10° / 12° / 14°
Depth of cut (APMX)	0.019" (0.5 mm)	0.039" / 0.059" (1 mm / 1.5 mm)	0.051" / 0.079" (1.3 mm / 2 mm)	0.079"	0.039" / 0.059" / 0.079" / 0.098"
Tool diameter	ø0.375" - ø0.625" (ø8 mm - ø16 mm)	ø0.625" - ø6.000" (ø16 mm - ø200 mm)	ø1.000" - ø3.000" (ø20 mm - ø83 mm)	ø2.000" - ø6.000"	ø1.000" - ø6.000"
Workpiece material	P M K S H	P M K S H	P M K S H	P M K S H	P M K S H
No. of corners (insert)	2	4	4	8	4
 Face milling					
 Shoulder milling					
 Profile milling					
 Slot milling					
Other applications					
Reference pages	H022 - H025	H026 - H035	H036 - H042	H043 - H045	H046 - H050

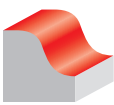
Icon











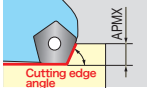























 Thin workpiece	 Ramping	 Long overhang	 Axial plunging	 Hole enlarging	 Slot milling	 Deep shoulder milling
 Face milling	 External threading	 Back facing	 Peck milling	 Hollow workpiece	 Chamfering	 Shoulder milling
 Internal threading	 Profiling	 Edging / Contouring	 Interrupted surface	 Cutting off		

	 <p>MILLFEED TXP</p>  <p>Inch <input checked="" type="checkbox"/> Metric <input type="checkbox"/></p>				
Cutting edge angle	10° / 15° / 20°				
Depth of cut (APMX)	0.060" / 0.118"				
Tool diameter	ø0.750" - ø6.000"				
Workpiece material	P M K H				
No. of corners (insert)	3				
 Face milling					
 Shoulder milling					
 Profile milling					
 Slot milling					
Other applications					
Reference pages	H051 - H056				

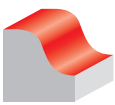

















A
 B
 C
 D
 E
 F
 G
 H
 I
 J
 K
 L
 M











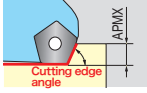

Face Milling - Quick Guide

★ : Most suitable
☆ : Suitable
☆ : Usable

	DO T MILL	DO OCTO	DO PENT	DO Q MILL	TUNG MILL
					
	Inch <input checked="" type="checkbox"/> Metric <input type="checkbox"/>	Inch <input checked="" type="checkbox"/> Metric <input type="checkbox"/>	Inch <input checked="" type="checkbox"/> Metric <input type="checkbox"/>	Inch <input checked="" type="checkbox"/> Metric <input type="checkbox"/>	Inch <input checked="" type="checkbox"/> Metric <input checked="" type="checkbox"/>
Cutting edge angle	45°	44° / 45° / 15°	70°	88°	30°~45°
Depth of cut (APMX)	0.236" / 0.134"	0.187" / 0.295" / 0.138" / 0.059"	0.252"	0.375"	0.157" / 0.197" / 0.079"
Tool diameter	ø2.000" - ø6.000"	ø2.500" - ø8.000"	ø1.250" - ø6.000"	ø2.000" - ø4.000"	ø2.000" - ø6.000"
Workpiece material	P M K S H	P M K S H	P M K N S	P M K S H	P M K S N
No. of corners (insert)	8 / 16	8 / 16	10	8	4
 Face milling	 ★  ☆  ★  ★	 ★  ★  ☆  ★	 ★  ★  ☆  ☆	 ★  ★  ☆  ☆	 ★  ★  ★  ☆
 Shoulder milling				 ☆	
 Profile milling	 ☆				
 Slot milling				 ☆	
Other applications	 ☆	 ☆			 ☆
Reference pages	H060 - H062	H063 - H066	H069 - H071	H067 - H068	H074 - H078

Icon

 Thin workpiece	 Ramping	 Long overhang	 Axial plunging	 Hole enlarging	 Slot milling	 Deep shoulder milling
 Face milling	 External threading	 Back facing	 Peck milling	 Hollow workpiece	 Chamfering	 Shoulder milling
 Internal threading	 Profiling	 Edging / Contouring	 Interrupted surface	 Cutting off		

	TFE	TUNGSMILL	DPD EDPD
	 Inch <input checked="" type="checkbox"/> Metric <input checked="" type="checkbox"/>	 Inch <input checked="" type="checkbox"/> Metric <input type="checkbox"/>	 Inch <input type="checkbox"/> Metric <input checked="" type="checkbox"/>
Cutting edge angle	85°	90°	90°
Depth of cut (APMX)	0.315" / 0.138" / 0.059"	0.177"	8 mm
Tool diameter	ø2.000" - ø4.000"	ø2.500" - ø6.000"	ø63 mm - ø160 mm
Workpiece material	P M K N	N	N
No. of corners (insert)	4 / 1 / 2	1	1
 Face milling			
 Shoulder milling			
 Profile milling			
 Slot milling			
Other applications			
Reference pages	H081 - H084	H079 - H080	H085 - H086

A
 B
 C
 D
 E
 F
 G
 H
 I
 J
 K
 L
 M

Shoulder milling - Quick Guide

★ : Most suitable
 ☆ : Suitable
 ☆ : Usable













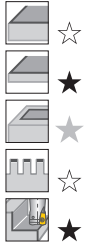
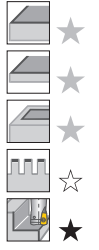

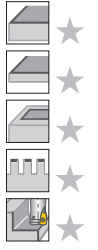
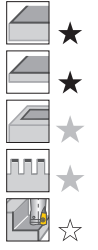
- High Feed Milling
- Face Milling
- Shoulder Milling
- Slot Milling
- Profile Milling
- Thread Milling
- Other

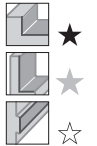
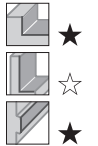
	TUNGFRÄC	TUNGREC	TUNG-TRI
	 <p>Inch <input checked="" type="checkbox"/> Metric <input checked="" type="checkbox"/></p>	 <p>Inch <input checked="" type="checkbox"/> Metric <input checked="" type="checkbox"/></p>	 <p>Inch <input checked="" type="checkbox"/> Metric <input checked="" type="checkbox"/></p>
Cutting edge angle	90°	90°	90°
Depth of cut (APMX)	0.236" (6 mm)	0.276" / 0.417" / 0.657" (7 mm / 10.6 mm / 16.7 mm)	0.236" / 0.394" / 0.590" (6 mm / 10 mm / 15 mm)
Tool diameter	ø0.315" - ø1.000" (ø8 mm - ø40 mm)	ø0.500" - ø6.000" (ø12 mm - ø160 mm)	ø0.500" - ø6.000" (ø12 mm - ø160 mm)
Workpiece material	P M K N S H	P M K N S	P M K N S
No. of corners (insert)	2	2	3
Face milling	★ ☆ ☆ ☆ ☆	☆ ☆ ☆ ☆ ☆	☆ ☆ ☆ ☆ ☆
Shoulder milling	★ ★ ★	★ ☆ ★	★ ★ ☆
Profile milling	☆ ☆ ☆	☆ ☆ ★	☆ ★ ☆
Slot milling	★	☆	★
Other applications	☆	☆	☆
Reference pages	H111 - H115	H116 - H128	H097 - H107

Icon

Thin workpiece	Ramping	Long overhang	Axial plunging	Hole enlarging	Slot milling	Deep shoulder milling
Face milling	External threading	Back facing	Peck milling	Hollow workpiece	Chamfering	Shoulder milling
Internal threading	Profiling	Edging / Contouring	Interrupted surface	Cutting off		

★ : Most suitable
 ☆ : Suitable
 ☆ : Usable

	TUNG T ^S HRED		TUNGQUAD		TUNG-ALUMILL
		Roughing		Roughing	
	Inch <input checked="" type="checkbox"/> Metric <input type="checkbox"/>	Inch <input checked="" type="checkbox"/> Metric <input type="checkbox"/>	Inch <input checked="" type="checkbox"/> Metric <input checked="" type="checkbox"/>	Inch <input checked="" type="checkbox"/> Metric <input type="checkbox"/>	Inch <input checked="" type="checkbox"/> Metric <input type="checkbox"/>
Cutting edge angle	90°		90°		90°
Depth of cut (APMX)	0.630"		2.402" - 2.992"		0.157" (4 mm)
Tool diameter	ø2.000" - ø4.000"		ø2.500" - ø3.000"		ø0.500" - ø2.000" (ø12 mm - ø40 mm)
Workpiece material	P M K S		P M K S		P M K N S
No. of corners (insert)	3		3		4
Face milling					
Shoulder milling					
Profile milling					
Slot milling					
Other applications					
Reference pages	H108 - H110		H108		H129 - H131
					H143 - H145











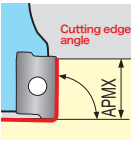
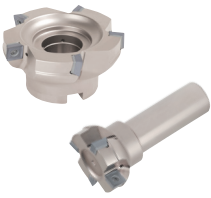











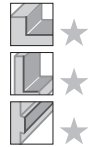

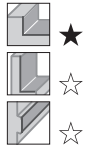

Grade
 Insert
 Ext. Toolholder
 Int. Toolholder
 Threading
 Grooving
 Milling Cutter
 Miniature Tool
 Endmill
 Drilling Tool
 Tooling System
 User's Guide
 Index





















★ : Most suitable
 ☆ : Suitable
 ☆ : Usable

Shoulder milling - Quick Guide

- High Feed Milling
- Face Milling
- Shoulder Milling**
- Slot Milling
- Profile Milling
- Thread Milling
- Other

	TUNG MILL	DO FTR I	DOREC	TEC MILL	
	 Inch <input checked="" type="checkbox"/> Metric <input checked="" type="checkbox"/>	 Inch <input checked="" type="checkbox"/> Metric <input type="checkbox"/>	 Inch <input checked="" type="checkbox"/> Metric <input type="checkbox"/>	 Inch <input checked="" type="checkbox"/> Metric <input type="checkbox"/>	Roughing  Inch <input checked="" type="checkbox"/> Metric <input type="checkbox"/>
Cutting edge angle	90°	90°	90°	90°	90°
Depth of cut (APMX)	0.394" (10 mm)	0.433"	0.354" / 0.630"	0.381" / 0.594"	2.303" / 2.634"
Tool diameter	ø2.000" - ø6.000" (ø32 mm - ø200 mm)	ø0.750" - ø6.000"	ø1.000" - ø6.000"	ø1.250" - ø5.000"	ø2.000" - ø2.500"
Workpiece material	P M K N S H	P M K S H	P M K S H	P M K S H	P M K S H
No. of corners (insert)	4	6	4	4	4
 Face milling					
 Shoulder milling					
 Profile milling					
 Slot milling					
Other applications					
Reference pages	H132- H135	H094 - H096	H136 - H139	H1140 - H142	

Icon

 Thin workpiece	 Ramping	 Long overhang	 Axial plunging	 Hole enlarging	 Slot milling	 Deep shoulder milling
 Face milling	 External threading	 Back facing	 Peck milling	 Hollow workpiece	 Chamfering	 Shoulder milling
 Internal threading	 Profiling	 Edging / Contouring	 Interrupted surface	 Cutting off		

Slot milling - Quick Guide

★ : Most suitable
 ☆ : Suitable
 ☆ : Usable

	TUNGMSLIT	TUNGTSLIT	TUNGUŚLÖT	TECTSLÖT	TUNGMEISTER
	Inch <input checked="" type="checkbox"/> Metric <input checked="" type="checkbox"/>	Inch <input checked="" type="checkbox"/> Metric <input checked="" type="checkbox"/>	Inch <input checked="" type="checkbox"/> Metric <input type="checkbox"/>	Inch <input checked="" type="checkbox"/> Metric <input type="checkbox"/>	Inch <input checked="" type="checkbox"/> Metric <input checked="" type="checkbox"/>
Depth of cut (W)	1.6 mm - 4.1 mm	0.250" - 0.313" (4 mm - 8 mm)	0.375" - 0.625"	0.630" - 0.984"	0.030" - 0.394"
Tool diameter	ø63 - ø125	ø3.000" - ø8.000" (ø80 mm - ø200 mm)	ø3.000" - ø6.000"	ø3.937" - ø9.843"	ø0.500" - ø1.000" (ø15.7 mm - ø27.7 mm)
Workpiece material	P M K	P M K S	P M K S	P M K S	P M K N S
No. of corners (insert)	1	6	6	4	1
Other applications					
Reference pages	H151 - H154	H155 - H156	H157 - H158	H159 - H160	H204 - H205

Icon

Grade
 Insert
 Ext. Toolholder
 Int. Toolholder
 Threading
 Grooving
 Milling Cutter
 Miniature Tool
 Endmill
 Drilling Tool
 Tooling System
 Index

A
 B
 C
 D
 E
 F
 G
 H
 I
 J
 K
 L
 M

★ : Most suitable
 ☆ : Suitable
 ☆ : Usable

Profile milling - Quick Guide



- High Feed Milling
- Face Milling
- Shoulder Milling
- Slot Milling
- Profile Milling
- Thread Milling
- Other

	DO T^{WIST}BALL	ROUND^{SPLIT}	BALL^{ROUN}NÖSE	BALL^{FIN}NÖSE	DO M^{INI}MILL
	Inch <input checked="" type="checkbox"/> Metric <input checked="" type="checkbox"/>	Inch <input checked="" type="checkbox"/> Metric <input type="checkbox"/>	Inch <input checked="" type="checkbox"/> Metric <input checked="" type="checkbox"/>	Inch <input checked="" type="checkbox"/> Metric <input checked="" type="checkbox"/>	Inch <input type="checkbox"/> Metric <input checked="" type="checkbox"/>
Depth of cut (APMX)	0.157" / 0.236" (4 mm / 5 mm / 6 mm)	0.236" / 0.315"	0.470" / 0.510" / 0.690" (11.8 mm / 13.6 mm / 17.7 mm)	0.157" / 0.630" (4 mm - 16 mm)	1 mm
Tool diameter	ø1.000" - ø3.000" (ø20 mm - ø63 mm)	ø1.250" - ø5.000"	ø0.625" - ø1.000" (ø16 mm - ø25 mm)	ø0.375" - ø1.250" (ø8 mm - ø32 mm)	ø16 - ø25
Workpiece material	P M K S H	P M K N S	P M K S H	P M K N S H	P H
No. of corners (insert)	4	4 / 8	2	1	6
	<input type="checkbox"/> ☆ <input type="checkbox"/> ☆ <input checked="" type="checkbox"/> ☆	<input type="checkbox"/> ☆ <input type="checkbox"/> ☆ <input checked="" type="checkbox"/> ★	<input type="checkbox"/> ☆ <input type="checkbox"/> ☆ <input type="checkbox"/> ☆	<input type="checkbox"/> ☆ <input type="checkbox"/> ☆ <input type="checkbox"/> ☆	<input type="checkbox"/> ☆ <input type="checkbox"/> ☆ <input type="checkbox"/> ☆
	<input checked="" type="checkbox"/> ★	<input type="checkbox"/> ☆	<input type="checkbox"/> ☆	<input type="checkbox"/> ☆	<input type="checkbox"/> ☆
	<input checked="" type="checkbox"/> ★ <input checked="" type="checkbox"/> ★ <input type="checkbox"/> ☆	<input checked="" type="checkbox"/> ★ <input type="checkbox"/> ☆ <input type="checkbox"/> ☆	<input checked="" type="checkbox"/> ★ <input type="checkbox"/> ☆ <input type="checkbox"/> ☆	<input checked="" type="checkbox"/> ★ <input type="checkbox"/> ☆ <input type="checkbox"/> ☆	<input checked="" type="checkbox"/> ★ <input type="checkbox"/> ☆ <input checked="" type="checkbox"/> ★
	<input type="checkbox"/> ☆	<input type="checkbox"/> ☆	<input type="checkbox"/> ☆	<input type="checkbox"/> ☆	<input type="checkbox"/> ☆
	<input type="checkbox"/> ☆	<input type="checkbox"/> ☆	<input type="checkbox"/> ☆	<input type="checkbox"/> ☆	<input type="checkbox"/> ☆
Reference pages	H036 - H042	H177 - H181	H164 - H165	H166 - H170	H171



















Icon

Thread milling - Quick Guide

★ : Most suitable
 ☆ : Suitable
 ☆ : Usable

	SOLIDTHREAD	TUNGMEISTER	THREADMILLING	
			ETTL, ETLN	Thread milling cutter
				
	Inch <input type="checkbox"/> Metric <input checked="" type="checkbox"/>	Inch <input type="checkbox"/> Metric <input checked="" type="checkbox"/>	Inch <input type="checkbox"/> Metric <input checked="" type="checkbox"/>	Inch <input type="checkbox"/> Metric <input checked="" type="checkbox"/>
Pitch	0.25 - 3.5	0.5 - 4.5	1 - 3	1.5 - 6
Tool diameter	∅0.7 - ∅20	∅10 - ∅21.7	∅17 - ∅30	∅23 - ∅80
Workpiece material	P M K S	P M K S	P M K S	P M K
No. of corners (insert)	-	-	1 / 2	2
Thread milling	 ★  ★	 ★  ★	 ★  ★	 ★  ★
Reference pages	H191 - H209	H204 - H205	H210 - H213	H214 - H215

Icon

 Thin workpiece	 Ramping	 Long overhang	 Axial plunging	 Hole enlarging	 Slot milling	 Deep shoulder milling
 Face milling	 External threading	 Back facing	 Peck milling	 Hollow workpiece	 Chamfering	 Shoulder milling
 Internal threading	 Profiling	 Edging / Contouring	 Interrupted surface	 Cutting off		

Grade
Insert
Ext. Toolholder
Int. Toolholder
Threading
Grooving
Miniature Tool
Endmill
Drilling Tool
Tooling System
User's Guide
Index



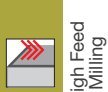

High Feed Milling



Face Milling



Shoulder Milling



Slot Milling



Profile Milling



Thread Milling



Other

Innovative high-feed cutters!

DoFeed offers outstanding productivity thanks to its close-pitch insert orientation and light cutting geometry. The rich lineup is suitable for a wide variety of applications.



Outstanding productivity

Excellent chip evacuation prevents chip packing

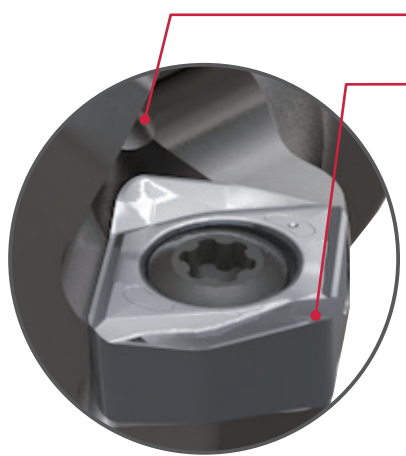
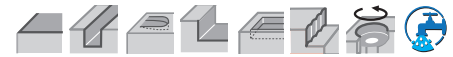

Optimized coolant jet delivery effectively removes chips and prevents it from re-cutting

Large inclination forms ideal chips and controls the chips flow



DOFEED

Good
Curl consistently at ideal length









Competitor Poor
Crushed or unstable

P
Steel

Cutter	: TXN06R200U0075A05
Insert	: LN*U06X5ZER-MJ
Grade	: AH725
Workpiece material	: Carbon steels (1055)
Cutting speed	: Vc = 590 sfm
Feed per tooth	: fz = 0.070 ipt
Depth of cut	: ap = 0.039"
Coolant	: Dry
Machine	: Vertical M/C, BT50

Rich lineup of cutter bodies from ø0.625" to ø6.000"

Insert	Bore type	Shank type	Modular type
LN*U03  Max. ap = 0.039"	TXN03 (DCX = 1.500" - 2.000") 	EXN03 (DCX = 0.630" - 1.250") 	HXN03 (DCX = 0.630" - 1.260") 
LN*U06  Max. ap = 0.059"	TXN06 (DCX = 2.000" - 6.000") 	EXN06 (DCX = 1.250" - 1.500") 	

Applicable area

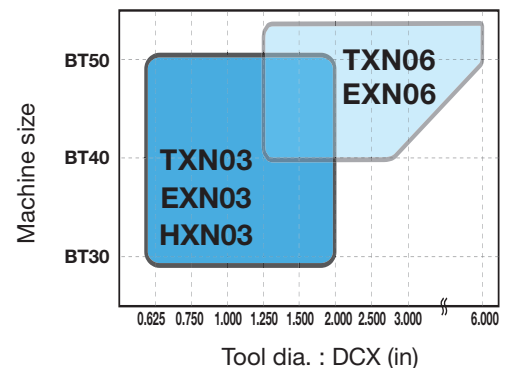

Reference pages: **H026 - H035**



Small-diameter high feed milling cutter with impressive machining efficiency and reliability

Built to perform at higher machining conditions

Strong insert corner for high feed operations

- Thick insert corner is designed to withstand fracturing force

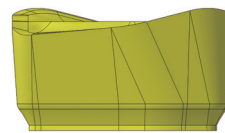

Thick insert corner
Max 10 % thicker
than competitors'

Robust and easy-to-handle insert screws

- M2 screws reduce screw neck shears under high cutting forces. A larger screw enhances insert's fixation and easy handling.



TUNGF^{ORCE}FEED
(M2)



Competitor
(M1.8)

Proper chip formation assures a reliable machining process

Positive inclination angle of the insert promotes smooth chip evacuation

- The positive cutting edge position contributes to a controlled chip formation and easy chip evacuation when machining next to shoulder and slotting operation.

Positive inclination angle

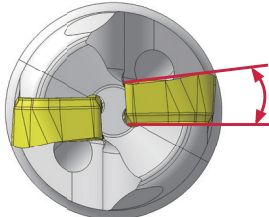

TUNGF^{ORCE}FEED



Competitor

Proper chip control eliminates
recuts and premature insert failure

Chip formation



Ideal curled chips



Crushed chips

P Steel	Cutter	: EXLS02U0.50C0.50LH2.00R02
	Insert	: LSMT0202ZER-HM AH3225
	Workpiece material	: 1055
	Cutting speed	: Vc = 656 sfm
	Application	: Slotting
	Depth of cut	: ap = 0.020" × 20 passes
	Coolant	: Dry
Machine	: Vertical M/C, CAT40	





TUNGFEED^{ORCE} EXLS

High feed endmill, shank type

GAMP = +4°, GAMF = -21° ~ -17°

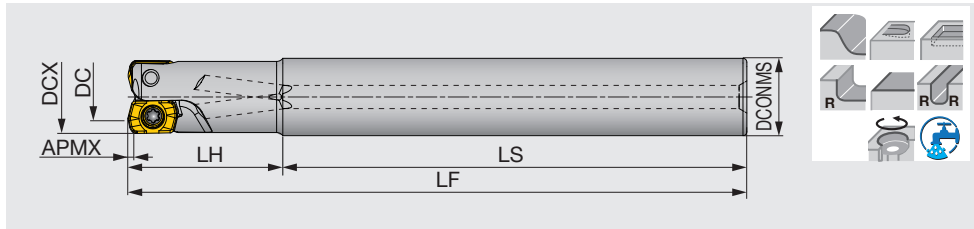

Inch	APMX	DCX	CICT	DC	DCONMS	LS	LH	LF	WT (lb)	Air hole	Insert
EXLS02U0.37C0.37LH0.75R01	0.020	0.375	1	0.228	0.375	2.250	0.750	3.000	0.088	With	LSMT02...
EXLS02U0.37C0.37LH1.25R01	0.020	0.375	1	0.228	0.375	2.250	1.250	3.500	0.110	With	LSMT02...
EXLS02U0.37C0.31LH0.75R01	0.020	0.375	1	0.228	0.3125	2.250	0.750	3.000	0.066	With	LSMT02...
EXLS02U0.50C0.50LH0.75R03	0.020	0.500	3	0.354	0.500	2.250	0.750	3.000	0.132	With	LSMT02...
EXLS02U0.50C0.50LH2.00R02	0.020	0.500	2	0.354	0.500	2.250	2.000	4.250	0.176	With	LSMT02...
EXLS02U0.50C0.37LH0.75R03	0.020	0.500	3	0.354	0.375	2.250	0.750	3.000	0.088	With	LSMT02...
EXLS02U0.62C0.62LH1.50R05	0.020	0.625	5	0.479	0.625	2.500	1.500	4.000	0.308	With	LSMT02...
EXLS02U0.62C0.62LH2.00R03	0.020	0.625	3	0.479	0.625	2.500	2.000	4.500	0.375	With	LSMT02...

Metric	APMX	DCX	CICT	DC	DCONMS	LS	LH	LF	WT (kg)	Air hole	Insert
EXLS02M008C08.0LH16R01	0.5	8	1	4.29	8	59	16	75	0.02	With	LSMT02...
EXLS02M008C08.0LH30R01	0.5	8	1	4.29	8	59	31	90	0.03	With	LSMT02...
EXLS02M010C10.0LH20R02	0.5	10	2	6.28	10	60	20	80	0.04	With	LSMT02...
EXLS02M010C10.0LH40R02	0.5	10	2	6.28	10	60	40	100	0.05	With	LSMT02...
EXLS02M010C08.0LH20R02	0.5	10	2	6.28	8	60	20	80	0.03	With	LSMT02...
EXLS02M012C12.0LH20R03	0.5	12	3	8.31	12	60	20	80	0.06	With	LSMT02...
EXLS02M012C12.0LH50R02	0.5	12	2	8.31	12	60	50	110	0.08	With	LSMT02...
EXLS02M012C10.0LH20R03	0.5	12	3	8.31	10	60	20	80	0.04	With	LSMT02...
EXLS02M016C16.0LH30R05	0.5	16	5	12.31	16	70	30	100	0.14	With	LSMT02...
EXLS02M016C16.0LH50R03	0.5	16	3	12.31	16	70	50	120	0.17	With	LSMT02...

SPARE PARTS

Designation	Clamping screw	Lubricant	Wrench
EXLS02U..., EXLS02M...	CSPB-2H	M-1000	IP-6DB

*Recommended clamping torque: CSPB-2H = 0.52 lbs·ft, 0.7 N·m

Approach angle



Others

TUNGFEED^{ORCE} HXLS

High feed endmill, shank type

GAMP = +4°, GAMF = -21° ~ -17°

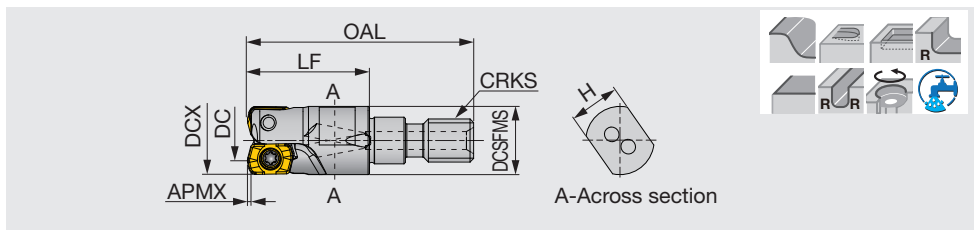

Metric	APMX	DCX	CICT	DC	OAL	LF	H	DCSFMS	CRKS	WT (kg)	Air hole	Insert
HXLS02M008M06R01	0.5	8	1	4.29	33.5	19	7	9.5	M6	0.01	With	LSMT02...
HXLS02M010M06R02	0.5	10	2	6.28	31.5	17	7	9.5	M6	0.01	With	LSMT02...
HXLS02M012M06R02	0.5	12	2	8.31	31.5	17	7	10	M6	0.01	With	LSMT02...
HXLS02M012M06R03	0.5	12	3	8.31	31.5	17	7	10	M6	0.01	With	LSMT02...
HXLS02M016M08R03	0.5	16	3	12.31	40	23	10	13	M8	0.03	With	LSMT02...
HXLS02M016M08R05	0.5	16	5	12.31	40	23	10	13	M8	0.03	With	LSMT02...

SPARE PARTS

Designation	Clamping screw	Lubricant	Wrench
HXLS02M...	CSPB-2H	M-1000	IP-6DB

*Recommended clamping torque : CSPB-2H = 0.7 N·m

Reference pages: Inserts → **H023**, Standard cutting conditions → **H024 - H025**, TungFlex → **H167**

INSERT

LSMT-HM (High feed)

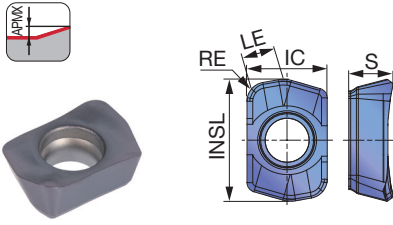

LSMT-MM (Radius)

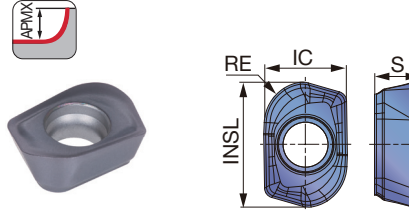

P Steel	★	☆																	
M Stainless	★																		
K Cast iron	☆	★																	
N Non-ferrous																			
S Superalloys	☆	★																	
H Hard materials		★																	

★ : First choice
☆ : Second choice

Designation	RE	APMX	Coated									LE	INSL	IC	S
			AH3225	AH8015											
LSMT0202ZER-HM	0.039	0.020	●	●								0.067	0.252	0.165	0.091
LSMT0202R2-MM	0.079	0.079	●	●								-	0.252	0.169	0.091

● : Line up

APPLICATION

LSMT02-HM

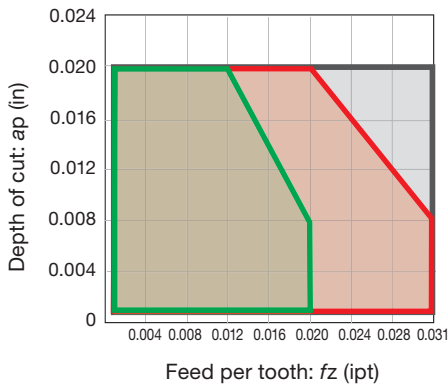

- For standard shanks in $\leq 3xD$
- For long-neck shanks in $\geq 4xD$
- For modular head shanks in $\geq 7xD$

LSMT02-MM

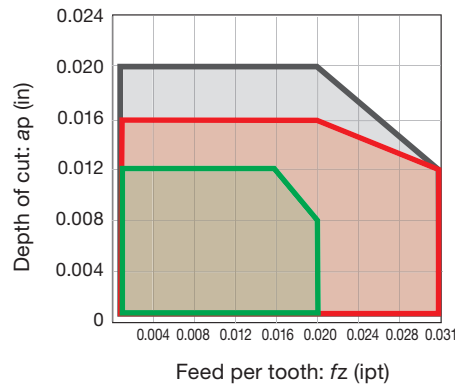

- For standard shanks in $\leq 3xD$
- For long-neck shanks in $\geq 4xD$
- For modular head shanks in $\geq 7xD$

* When the DOC is 0.020" or more, the feed less than 0.006 ipt is recommended.

STANDARD CUTTING CONDITIONS



ISO	Workpiece materials	Hardness	Priority	Grades	Cutting speed Vc (sfm)	Feed per tooth fz (ipt)
P	Carbon steels 1045, 1055, etc.	- 300HB	First choice	AH3225	330 - 990	0.008 - 0.031
		- 300HB	Wear resistance	AH8015	330 - 990	0.008 - 0.031
	Alloy steels 4140, SCr415, etc.	- 300HB	First choice	AH3225	330 - 990	0.008 - 0.031
		- 300HB	Wear resistance	AH8015	330 - 990	0.008 - 0.031
	Prehardened steels NAK80, PX5, etc.	30 - 40HRC	First choice	AH8015	330 - 660	0.008 - 0.020
		30 - 40HRC	Fracture resistance	AH3225	330 - 660	0.008 - 0.020
M	Stainless steels 304, 316, etc.	- 200HB	First choice	AH3225	330 - 660	0.008 - 0.020
K	Gray cast irons No.250B, etc.	150 - 250HB	First choice	AH8015	330 - 990	0.008 - 0.031
		150 - 250HB	Fracture resistance	AH3225	330 - 990	0.008 - 0.031
	Ductile cast irons 65-45-12, etc.	150 - 250HB	First choice	AH8015	260 - 660	0.008 - 0.031
		150 - 250HB	Fracture resistance	AH3225	260 - 660	0.008 - 0.031
S	Titanium alloy Ti-6Al-4V, etc.	- 40HRC	First choice	AH3225	100 - 200	0.004 - 0.012
		- 40HRC	Wear resistance	AH8015	100 - 200	0.004 - 0.012
	Heat resistant alloy Inconel, Hastelloy, etc.	- 40HRC	First choice	AH8015	70 - 170	0.004 - 0.012
- 40HRC		Fracture resistance	AH3225	70 - 170	0.004 - 0.012	
H	Hardened steel	H13, etc.	First choice	AH8015	260 - 490	0.004 - 0.020
		D2, D3, etc.	First choice	AH8015	160 - 230	0.004 - 0.012

APPLICATION RANGE

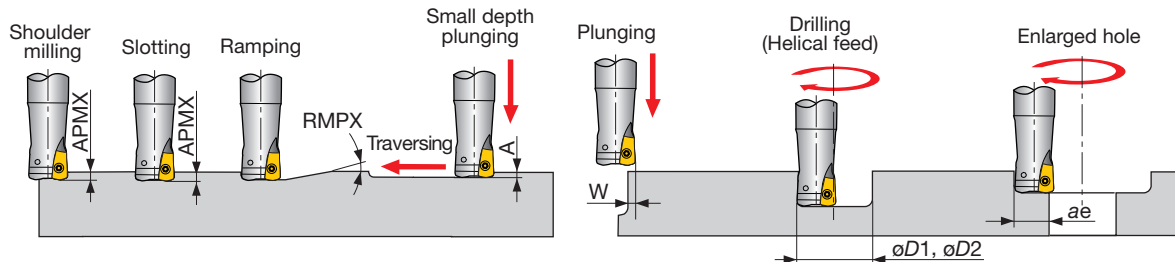

Inch	DCX	Max. depth of cut APMX	Max. ramping angle RMPX	Max. plunging depth A	Max. cutting width in plunging W	Min. machining øD1	Max. machining øD2	Max. cutting width in enlarged hole ae
EXLS02U0.37...	0.375	0.020	3.6°	0.007	0.078	0.513	0.730	0.292
EXLS02U0.50...	0.500	0.020	1.8°	0.007	0.078	0.763	0.980	0.417
EXLS02U0.62...	0.625	0.020	1.3°	0.007	0.078	1.013	1.230	0.542

Tool geometry on programming

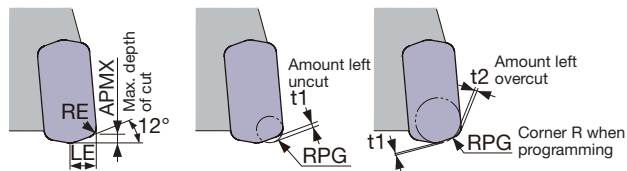

LSMT02...-HM

Corner R when programming: RPG	Amount left uncut t1 (in)	Amount left overcut t2 (in)
0.039 *Recommend	0.006	0
0.059	0.003	0.006
0.079	0	0.013

Tool dia.: DC (in), Number of revolutions: <i>n</i> (rpm), Feed speed: <i>Vf</i> (ipm), Max. depth of cut: <i>ap</i> = 0.020", Number of teeth: CICT									
ø0.315", CICT = 1		ø0.394", CICT = 2		ø0.472"			ø0.630"		
<i>n</i>	<i>Vf</i>	<i>n</i>	<i>Vf</i>	<i>n</i>	<i>Vf</i>		<i>n</i>	<i>Vf</i>	
					CICT = 2	CICT = 3		CICT = 3	CICT = 5
7960	160	6370	255	5310	215	320	3980	240	400
Vc = 656 sfm, fz = 0.020 ipt									
7960	160	6370	255	5310	215	320	3980	240	400
Vc = 656 sfm, fz = 0.020 ipt									
5970	95	4780	153	3980	125	190	2990	145	240
Vc = 492 sfm, fz = 0.016 ipt									
4780	75	3820	122	3190	100	155	2390	115	190
Vc = 394 sfm, fz = 0.016 ipt									
7960	160	6370	255	5310	210	320	3980	240	400
Vc = 656 sfm, fz = 0.020 ipt									
5970	120	4780	190	3980	160	240	2990	180	300
Vc = 492 sfm, fz = 0.020 ipt									
1590	13	1270	20	1060	17	25	800	19	32
Vc = 131 sfm, fz = 0.008 ipt									
1190	10	1000	16	800	13	20	600	15	25
Vc = 98 sfm, fz = 0.008 ipt									
4780	57	3820	92	3190	76	115	2390	86	190
Vc = 394 sfm, fz = 0.012 ipt									
2390	19	1910	30	1590	25	35	1190	30	50
Vc = 197 sfm, fz = 0.008 ipt									

Grade
Insert
Ext. Toolholder
Int. Toolholder
Threading
Grooving
Miniature Tool
Milling Cutter
Endmill
Drilling Tool
Tooling System
User's Guide
Index





DOFEED TXN03

High feed mill, for 4-corner double sided inserts

GAMP = +6°, GAMF = +12° ~ 13°

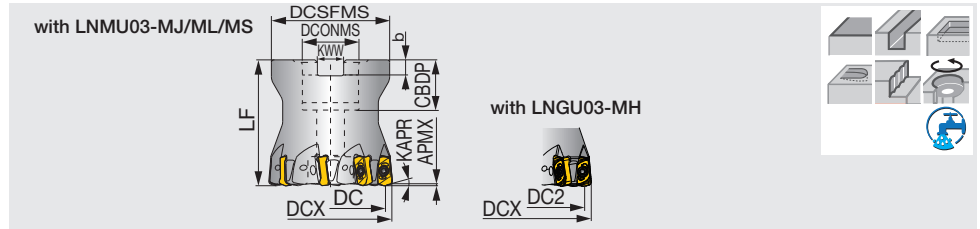

Inch	APMX	DCX	CICT	DC	DC2	DCSFMS	DCONMS	CDBP	LF	b	KWW	KAPR	WT(lb)	Air hole	Insert
TXN03R150U0050A05	0.039	1.500	5	1.248	1.247	1.460	0.500	0.750	1.575	0.160	0.252	17°	0.530	With	LN*U03...
TXN03R150U0050A06	0.039	1.500	6	1.248	1.247	1.380	0.500	0.600	1.575	0.160	0.252	17°	0.510	With	LN*U03...
TXN03R200U0075A05	0.039	2.000	5	1.718	1.757	1.693	0.750	0.750	1.969	0.197	0.315	17°	1.100	With	LN*U03...
TXN03R200U0075A08	0.039	2.000	8	1.718	1.757	1.693	0.750	0.750	1.969	0.197	0.315	17°	1.100	With	LN*U03...
TXN03R200U0075A10	0.039	2.000	10	1.718	1.757	1.693	0.750	0.750	1.969	0.197	0.315	17°	1.100	With	LN*U03...

SPARE PARTS



Designation	Clamping screw	Lubricant	Shell locking bolt (Optional parts)	Wrench
TXN03R150U...	CSPB-2.5	M-1000	(SR UNF 1/4X3/4 B18.3)	IP-8D
TXN03R200U...	CSPB-2.5	M-1000	(C0.375X1.125H)	IP-8D

*Recommended clamping torque : CSPB-2.5 = 0.96 lbs·ft

DOFEED EXN03

High feed endmill, shank type, with center through coolant hole, for 4-corner double sided inserts

GAMP = +6°, GAMF = +5° ~ +11°

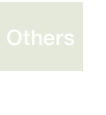
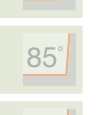
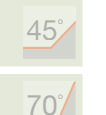
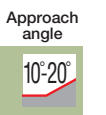
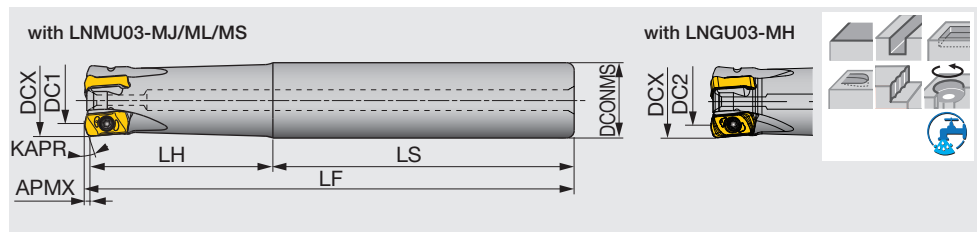

Inch	APMX	DCX	CICT	DC	DC2	DCONMS	LF	LH	LS	KAPR	WT(lb)	Air hole	Insert
EXN03R062U0062-02	0.039	0.625	2	0.372	0.381	0.625	4.000	1.250	2.750	15°	0.310	With	LN*U03...
EXN03R062U0062-02L	0.039	0.625	2	0.372	0.381	0.625	6.000	2.000	4.000	15°	0.460	With	LN*U03...
EXN03R068U0062-02	0.039	0.688	2	0.434	0.436	0.625	4.000	1.250	2.750	17°	0.310	With	LN*U03...
EXN03R068U0062-02L	0.039	0.688	2	0.434	0.436	0.625	6.000	1.000	5.000	17°	0.490	With	LN*U03...
EXN03R075U0075-02	0.039	0.750	2	0.495	0.498	0.750	5.000	2.000	3.000	17°	0.550	With	LN*U03...
EXN03R075U0075-03	0.039	0.750	3	0.495	0.498	0.750	5.000	2.000	3.000	17°	0.550	With	LN*U03...
EXN03R075U0075-03L	0.039	0.750	3	0.495	0.498	0.750	6.500	3.500	3.000	17°	0.710	With	LN*U03...
EXN03R087U0075-02	0.039	0.875	2	0.621	0.623	0.750	5.000	2.000	3.000	17°	0.570	With	LN*U03...
EXN03R087U0075-03	0.039	0.875	3	0.621	0.623	0.750	5.000	2.000	3.000	17°	0.570	With	LN*U03...
EXN03R087U0075-03L	0.039	0.875	3	0.621	0.623	0.750	6.500	1.250	5.250	17°	0.750	With	LN*U03...
EXN03R100U0100-04	0.039	1.000	4	0.746	0.748	1.000	5.500	2.500	3.000	17°	1.080	With	LN*U03...
EXN03R100U0100-04L	0.039	1.000	4	0.746	0.748	1.000	7.000	4.000	3.000	17°	1.340	With	LN*U03...
EXN03R100U0100-05	0.039	1.000	5	0.746	0.748	1.000	5.500	2.500	3.000	17°	1.080	With	LN*U03...
EXN03R112U0100-04	0.039	1.125	4	0.871	0.872	1.000	5.500	2.500	3.000	17°	1.120	With	LN*U03...
EXN03R112U0100-04L	0.039	1.125	4	0.871	0.872	1.000	7.000	1.500	5.500	17°	1.460	With	LN*U03...
EXN03R112U0100-05	0.039	1.125	5	0.871	0.872	1.000	5.500	2.500	3.000	17°	1.120	With	LN*U03...
EXN03R125U0125-05	0.039	1.250	5	0.997	0.997	1.250	6.000	3.000	3.000	17°	1.870	With	LN*U03...
EXN03R125U0125-05L	0.039	1.250	5	0.997	0.997	1.250	8.000	5.000	3.000	17°	2.430	With	LN*U03...
EXN03R125U0125-06	0.039	1.250	6	0.997	0.997	1.250	6.000	3.000	3.000	17°	1.850	With	LN*U03...

SPARE PARTS



Designation	Clamping screw	Lubricant	Wrench
EXN03...	CSPB-2.5	M-1000	IP-8D

*Recommended clamping torque : CSPB-2.5 = 0.96 lbs·ft

Reference pages: Inserts → **H029**, Standard cutting conditions → **H030 - H031**

High feed endmill, shank type, with coolant directly to the tool tips, for 4-corner double sided inserts

GAMP = +6°, GAMF = +5° ~ +11°

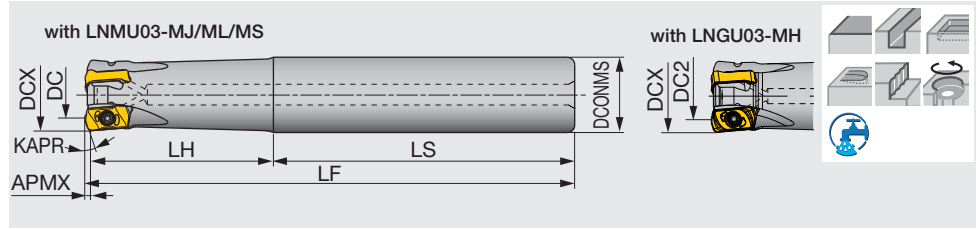

Inch	APMX	DCX	CICT	DC	DC2	DCONMS	LF	LH	LS	KAPR	WT(lb)	Air hole	Insert
EXN03R075U0075-03-C	0.039	0.750	3	0.494	0.498	0.750	5.000	2.000	3.000	17°	0.660	With	LN*U03...
EXN03R087U0075-03-C	0.039	0.875	3	0.634	0.623	0.750	5.000	2.000	3.000	17°	0.660	With	LN*U03...
EXN03R100U0100-05-C	0.039	1.000	5	0.756	0.748	1.000	5.500	2.500	3.000	17°	1.100	With	LN*U03...
EXN03R125U0125-06-C	0.039	1.250	6	1.008	0.997	1.250	6.000	3.000	3.000	17°	1.760	With	LN*U03...

Metric	APMX	DCX	CICT	DC	DC2	DCONMS	LF	LH	LS	KAPR	WT(kg)	Air hole	Insert
EXN03R016M16.0-02-C	1	16	2	9.6	9.8	16	100	30	70	15°	0.2	With	LN*U03...
EXN03R016M16.0-02L-C	1	16	2	9.6	9.8	16	150	50	100	15°	0.2	With	LN*U03...
EXN03R020M20.0-03-C	1	20	3	13.5	13.6	20	130	50	80	17°	0.3	With	LN*U03...
EXN03R020M20.0-03L-C	1	20	3	13.5	13.6	20	160	80	80	17°	0.3	With	LN*U03...
EXN03R020M20.0-04-C	1	20	4	13.5	13.6	20	130	50	80	17°	0.3	With	LN*U03...
EXN03R025M25.0-04-C	1	25	4	18.5	18.6	25	140	60	80	17°	0.5	With	LN*U03...
EXN03R025M25.0-04L-C	1	25	4	18.5	18.6	25	180	100	80	17°	0.6	With	LN*U03...
EXN03R025M25.0-05-C	1	25	5	18.5	18.6	25	130	60	80	17°	0.5	With	LN*U03...
EXN03R032M32.0-05-C	1	32	5	25.5	25.6	32	150	70	80	17°	0.8	With	LN*U03...
EXN03R032M32.0-05L-C	1	32	5	25.5	25.6	32	200	120	80	17°	1.1	With	LN*U03...
EXN03R032M32.0-06-C	1	32	6	25.5	25.6	32	150	70	80	17°	0.8	With	LN*U03...
EXN03R040M32.0-06-C	1	40	6	33.6	33.7	32	150	45	105	17°	1	With	LN*U03...
EXN03R040M32.0-06L-C	1	40	6	33.6	33.7	32	220	45	175	17°	1.4	With	LN*U03...

SPARE PARTS



Designation	Clamping screw	Lubricant	Wrench
EXN03...	CSPB-2.5	M-1000	IP-8D

*Recommended clamping torque : CSPB-2.5 = 0.96 lbs·ft, 1.3 N·m

High feed endmill (Eco), shank type, for double sided inserts

GAMP = +6°, GAMF = +5° ~ +11°

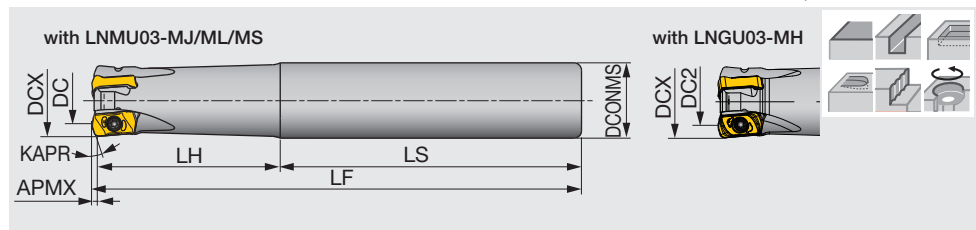

Metric	APMX	DCX	CICT	DC	DC2	DCONMS	LF	LH	LS	KAPR	WT(kg)	Air hole	Insert
EXN03R016M16.0-02N	1	16	2	9.6	9.8	16	100	30	70	15°	0.2	Without	LN*U03...
EXN03R020M20.0-03N	1	20	3	13.5	13.6	20	130	50	80	17°	0.3	Without	LN*U03...
EXN03R025M25.0-04N	1	25	4	18.5	18.6	25	140	60	80	17°	0.5	Without	LN*U03...
EXN03R032M32.0-05N	1	32	5	25.5	25.6	32	150	70	80	17°	0.8	Without	LN*U03...

SPARE PARTS



Designation	Clamping screw	Lubricant	Wrench
EXN03...	CSPB-2.5	M-1000	IP-8D

*Recommended clamping torque : CSPB-2.5 = 1.3 N·m

Reference pages: Inserts → **H029**, Standard cutting conditions → **H030 - H031**





DOFEED

HXN03

High feed endmill, modular type, with center through coolant hole (TungFlex)

GAMP= +6°, GAMF= +5° ~ +11°

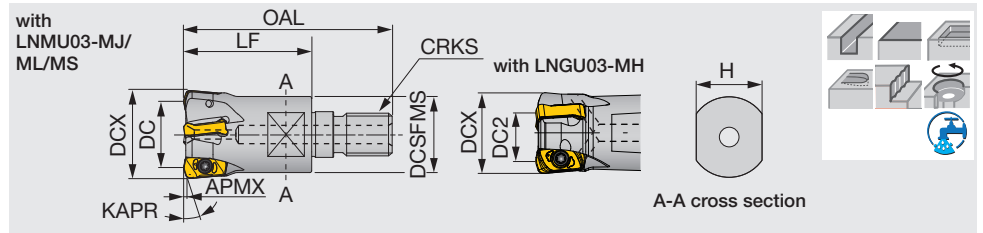

Metric	APMX	DCX	CICT	DC	DC2	OAL	LF	H	DCSFMS	KAPR	CRKS	WT(kg)	Air hole	Insert
HXN03R016MM08-02	1	16	2	9.6	9.8	42	25	10	12.8	15°	M8	0.03	With	LN*U03...
HXN03R018MM08-02	1	18	2	11.5	11.7	42	25	10	14.5	17°	M8	0.04	With	LN*U03...
HXN03R020MM10-03	1	20	3	13.5	13.6	49	30	15	17.8	17°	M10	0.06	With	LN*U03...
HXN03R020MM10-04	1	20	4	13.5	13.6	49	30	15	17.8	17°	M10	0.06	With	LN*U03...
HXN03R022MM10-03	1	22	3	15.5	15.6	49	30	15	17.8	17°	M10	0.06	With	LN*U03...
HXN03R022MM10-04	1	22	4	15.5	15.6	49	30	15	17.8	17°	M10	0.07	With	LN*U03...
HXN03R025MM12-04	1	25	4	18.5	18.6	57	35	17	20.8	17°	M12	0.1	With	LN*U03...
HXN03R025MM12-05	1	25	5	18.5	18.6	57	35	17	20.8	17°	M12	0.11	With	LN*U03...
HXN03R028MM12-04	1	28	4	21.5	21.6	57	35	17	23	17°	M12	0.12	With	LN*U03...
HXN03R028MM12-05	1	28	5	21.5	21.6	57	35	17	23	17°	M12	0.12	With	LN*U03...
HXN03R030MM16-04	1	30	4	23.5	23.6	63	40	22	28.8	17°	M16	0.19	With	LN*U03...
HXN03R030MM16-05	1	30	5	23.5	23.6	63	40	22	28.8	17°	M16	0.2	With	LN*U03...
HXN03R032MM16-05	1	32	5	25.5	25.6	63	40	22	28.8	17°	M16	0.2	With	LN*U03...
HXN03R032MM16-06	1	32	6	25.5	25.6	63	40	22	28.8	17°	M16	0.21	With	LN*U03...

See page H167 for TungFlex modular shank.

SPARE PARTS

Designation	Clamping screw	Lubricant	Wrench
HXN03...	CSPB-2.5	M-1000	IP-8D

*Recommended clamping torque : CSPB-2.5 = 1.3 N·m

Approach angle

10°-20°

45°

70°

85°

88°

90°

Others

DOFEED

HXN03-C

High feed endmill, modular type, with coolant directly to the tool tips (TungFlex)

GAMP= +6°, GAMF= +5° ~ +11°

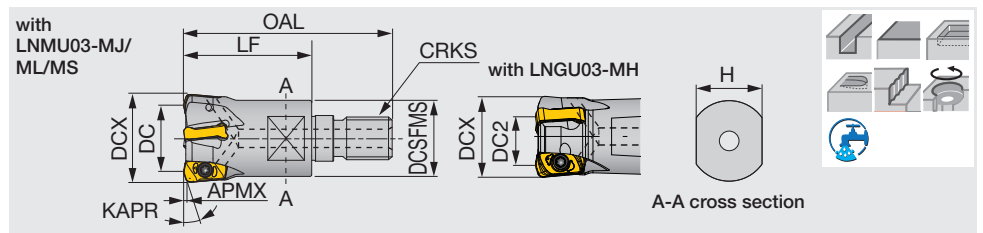

Metric	APMX	DCX	CICT	DC	DC2	OAL	LF	H	DCSFMS	KAPR	CRKS	WT(kg)	Air hole	Insert
HXN03R016MM08-02-C	1	16	2	9.6	9.8	42	25	10	12.8	15°	M8	0.03	With	LN*U03...
HXN03R020MM10-03-C	1	20	3	13.5	13.6	49	30	15	17.8	17°	M10	0.06	With	LN*U03...
HXN03R020MM10-04-C	1	20	4	13.5	13.6	49	30	15	17.8	17°	M10	0.06	With	LN*U03...
HXN03R025MM12-04-C	1	25	4	18.5	18.6	57	35	17	20.8	17°	M12	0.1	With	LN*U03...
HXN03R025MM12-05-C	1	25	5	18.5	18.6	57	35	17	20.8	17°	M12	0.1	With	LN*U03...
HXN03R032MM16-05-C	1	32	5	25.5	25.6	63	40	22	28.8	17°	M16	0.2	With	LN*U03...
HXN03R032MM16-06-C	1	32	6	25.5	25.6	63	40	22	28.8	17°	M16	0.2	With	LN*U03...
HXN03R040MM16-06-C	1	40	6	33.6	33.7	63	40	22	28.8	17°	M16	0.27	With	LN*U03...

See page H167 for TungFlex modular shank.

SPARE PARTS

Designation	Clamping screw	Lubricant	Wrench
HXN03...	CSPB-2.5	M-1000	IP-8D

*Recommended clamping torque : CSPB-2.5 = 1.3 N·m

Reference pages: Inserts → H029, Standard cutting conditions → H030 - H031, TungFlex → H167

INSERT

LNMU03-MJ (General purpose)

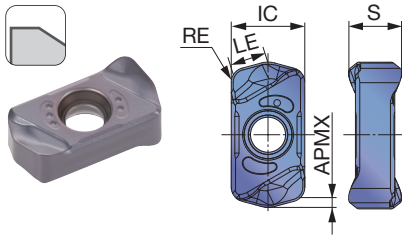

LNMU03-ML (Low cutting force)

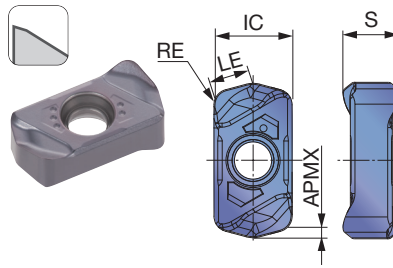

LNMU03-MS (For stainless steel)

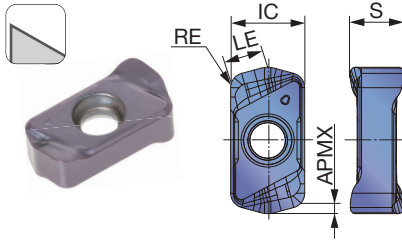

LNGU03-MH (Reinforced cutting edge)

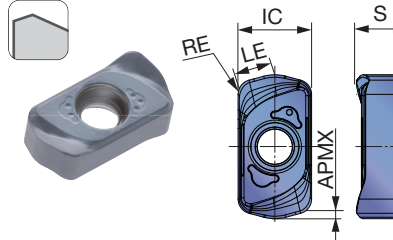

P Steel		★	☆					
M Stainless	★	☆	☆					
K Cast iron		☆	☆	★				
N Non-ferrous								
S Superalloys	★	☆		☆	★			
H Hard materials				☆	★	☆		

★ : First choice
☆ : Second choice

Designation	RE	APMX	Coated						LE	IC	S
			AH130	AH3225	AH3035	AH725	AH8015	AH8005			
LNMU0303ZER-MJ	0.047	0.039	●	●	●	●	●		0.126	0.236	0.169
LNMU0303ZER-ML	0.047	0.039	●	●	●	●	●		0.126	0.236	0.169
LNMU0303ZER-MS	0.047	0.039	●	●					0.126	0.236	0.169
LNGU0303ZER-MH	0.047	0.039					●	●	0.126	0.236	0.169

● : Line up

Grade
Insert
Toolholder
Ext. Toolholder
Int. Toolholder
Threading
Grooving
Miniature Tool
Endmill
Drilling Tool
Tooling System
User's Guide
Index



STANDARD CUTTING CONDITIONS TXN03/EXN03/HXN03

ISO	Workpiece material	Hardness	Priority	Grade	Chip-breaker	Cutting speed Vc (sfm)	Feed per tooth: fz (ipt)										
							Tool dia.: DCX (in)			Plunging		ø0.625", CICT = 2		ø0.688", CICT = 2		ø0.75	
							ø0.625-ø0.875	ø1.000-ø2.000		n	Vf	n	Vf	n	Vf	CICT = 2	CICT = 3
P	Carbon steels 1045, 1055, etc.	- 300HB	First choice	AH3225	MJ	330 - 980	0.020 - 0.047	0.020 - 0.059	0.004	4,030	250	3,660	227	3,360	208	312	
	Alloy steels 4140, etc.	- 300HB	First choice	AH3225	MJ	330 - 980	0.020 - 0.047	0.020 - 0.059	0.004	4,030	250	3,660	227	3,360	208	312	
	Prehardened steels NAK80, PX5, etc.	30 - 40HRC	First choice	AH3225	MJ	330 - 660	0.020 - 0.039	0.020 - 0.039	0.004	2,990	167	2,720	152	2,500	140	210	
M	Stainless steels 304SS, 316SS, etc.	- 200HB	First choice	AH130	MS	260 - 490	0.012 - 0.031	0.012 - 0.031	0.004	2,380	95	2,170	87	1,990	80	119	
	Precipitation hardening stainless steels 17-4 PH, etc.	28HRC - (H1150)	First choice	AH130	MS	260 - 490	0.008 - 0.020	0.008 - 0.020	0.004	2,380	57	2,170	52	1,990	48	72	
		40HRC - (H900)	First choice	AH3035	ML	260 - 390	0.004 - 0.012	0.004 - 0.012	0.004	2,020	32	1,830	29	1,680	27	40	
K	Gray cast irons Class 25, etc.	150 - 250HB	First choice	AH725	MJ	330 - 980	0.020 - 0.047	0.020 - 0.059	0.004	4,030	250	3,660	227	3,360	208	312	
	Ductile cast irons 65-45-12, etc.	150 - 250HB	First choice	AH725	MJ	260 - 660	0.020 - 0.047	0.020 - 0.059	0.004	2,990	185	2,720	169	2,500	155	233	
S	Titanium alloy Ti-6Al-4V, etc.	- 40HRC	First choice	AH130	ML	100 - 200	0.012 - 0.028	0.012 - 0.028	0.003	790	25	720	23	660	21	32	
		Fracture resistance	AH130	MJ	0.004 - 0.012		0.004 - 0.012	0.002	610	10	560	9	510	8	12		
	Heat-resistant alloy Inconel, Hastelloy, etc.	- 40HRC	First choice	AH8015	ML	70 - 160	0.004 - 0.012	0.004 - 0.012	0.002	610	10	560	9	510	8	12	
H	Hot mold steel HB, etc.	40 - 55HRC	First choice	AH8015	MH	260 - 490	0.004 - 0.020	0.004 - 0.020	0.002	2,390	57	2,170	52	1,990	48	72	
		Low resistance	AH8015	MJ	0.004 - 0.012		0.004 - 0.012	0.002	1,590	25	1,440	23	1,320	21	32		
	Hot mold steel of D.T.C materials DAC**, DH**, DIEVER, etc.	40 - 55HRC	First choice	AH8015	MJ	160 - 330	0.004 - 0.020	0.004 - 0.020	0.002	1,590	25	1,440	23	1,320	21	32	
	Cold mold steel D2, etc.	55 - 60HRC	First choice	AH8005	MH	160 - 230	0.002 - 0.008	0.001 - 0.004	0.001	1,220	12	1,110	11	1,020	10	15	
		Fracture resistance	AH8015	MH	160 - 230	0.001 - 0.004	0.002 - 0.008	0.001	1,220	5	1,110	4	1,020	4	6		

- When chips stay in the cutting zone during slotting or pocketing, use air blast to remove chips from the work area.
 - Tool overhang length must be as short as possible to avoid chatter. When the tool overhang length is long, decrease the number of revolutions and feed.

Cautionary points in use

The use of a standard or long shank

When using a long shank, please lower the cutting conditions (Vc, fz, ap) to 70% of the maximum conditions for the standard shank.

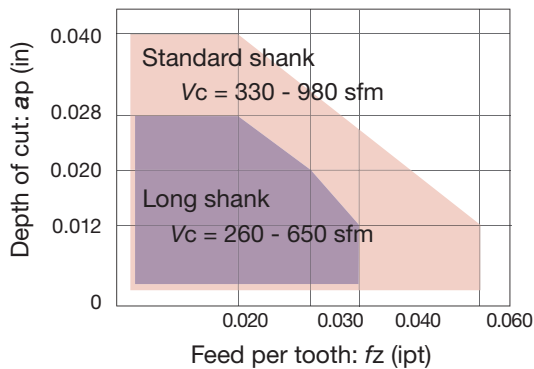

Tool dia.: DCX = ø0.625 - 1.250"
 Workpiece: 1015 (200HB)
L/D ratio of overhang
 Standard shank: L/D ≤ 3
 Long shank: L/D = 4

Tool geometry on programming

When programming for CAM, the tool should be considered as a radius cutter. Usually, the corner radius should be set as R = 0.060". If a larger radius is used, overcutting will occur. The following table shows the amount left uncut (t1) and overcut (t2).

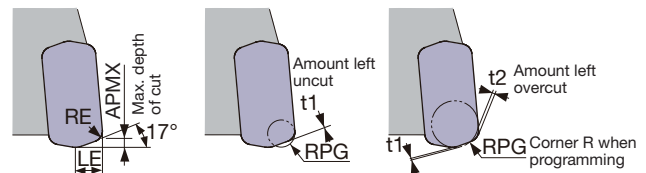

LNXM03-MJ/ML

Max. depth of cut APMX (in)	Corner radius RE (in)	LE (in)	Corner R when programming: RPG	Amount left uncut t1 (in)	Amount left overcut t2 (in)
0.039	0.047	0.118	0.039	0.018	-
0.039	0.047	0.118	0.060	0.014	-
0.039	0.047	0.118	0.079	0.008	0.004
0.039	0.047	0.118	0.098	0.003	0.011

LNGU03-MH

Max. depth of cut APMX (in)	Corner radius RE (in)	LE (in)	Corner R when programming: RPG	Amount left uncut t1 (in)	Amount left overcut t2 (in)
0.039	0.047	0.118	0.039	0.018	-
0.039	0.047	0.118	0.060	0.014	-
0.039	0.047	0.118	0.079	0.008	0.004
0.039	0.047	0.118	0.098	0.003	0.011

Each value in table is calculated theoretically at the maximum condition.

Tool dia.: DCX (in), Number of revolutions: n (rpm), Feed speed: V_f (ipm), Max. depth of cut: $a_p = 0.004''$

$\phi 0.875$		$\phi 1$		$\phi 1.125$		$\phi 1.25$		$\phi 1.5$		$\phi 2$								
n	V_f	n	V_f	n	V_f	n	V_f	n	V_f	n	V_f							
CICT = 2 CICT = 3		CICT = 4 CICT = 5		CICT = 4 CICT = 5		CICT = 5 CICT = 6		CICT = 5 CICT = 6		CICT = 5 CICT = 8 CICT = 10								
2,880	230	346	2,520	403	504	2,240	358	448	2,020	404	485	1,680	336	403	1,260	252	403	504
$V_c = 660 \text{ sfm}, f_z = 0.04 \text{ ipt}$																		
2,880	230	346	2,520	403	504	2,240	358	448	2,020	404	485	1,680	336	403	1,260	252	403	504
$V_c = 660 \text{ sfm}, f_z = 0.04 \text{ ipt}$																		
2,140	120	180	1,870	209	262	1,660	186	232	1,500	210	252	1,250	175	210	940	132	211	263
$V_c = 490 \text{ sfm}, f_z = 0.028 \text{ ipt}$																		
2,140	120	180	1,870	209	262	1,660	186	232	1,500	210	252	1,250	175	210	940	132	211	263
$V_c = 490 \text{ sfm}, f_z = 0.028 \text{ ipt}$																		
1,700	68	102	1,490	119	149	1,320	106	132	1,190	119	143	990	99	119	740	74	118	148
$V_c = 390 \text{ sfm}, f_z = 0.02 \text{ ipt}$																		
1,700	41	61	1,490	72	89	1,320	63	79	1,190	71	86	990	59	71	740	44	71	89
$V_c = 390 \text{ sfm}, f_z = 0.012 \text{ ipt}$																		
1,440	23	35	1,260	40	50	1,120	36	45	1,010	40	48	840	34	40	630	25	40	50
$V_c = 330 \text{ sfm}, f_z = 0.008 \text{ ipt}$																		
2,880	230	346	2,520	403	504	2,240	358	448	2,020	404	485	1,680	336	403	1,260	252	403	504
$V_c = 660 \text{ sfm}, f_z = 0.04 \text{ ipt}$																		
2,140	171	257	1,870	299	374	1,660	266	332	1,500	300	360	1,250	250	300	940	188	301	376
$V_c = 490 \text{ sfm}, f_z = 0.04 \text{ ipt}$																		
570	23	34	500	40	50	440	35	44	400	40	48	330	33	40	250	25	40	50
$V_c = 130 \text{ sfm}, f_z = 0.02 \text{ ipt}$																		
440	7	11	380	12	15	340	11	14	310	12	15	250	10	12	190	8	12	15
$V_c = 100 \text{ sfm}, f_z = 0.008 \text{ ipt}$																		
1,700	41	61	1,490	72	89	1,320	63	79	1,190	71	86	990	59	71	740	44	71	89
$V_c = 390 \text{ sfm}, f_z = 0.012 \text{ ipt}$																		
1,140	18	27	990	32	40	880	28	35	790	32	38	660	26	32	500	20	32	40
$V_c = 260 \text{ sfm}, f_z = 0.008 \text{ ipt}$																		
870	7	10	760	12	15	680	11	14	610	12	15	510	10	12	380	8	12	15
$V_c = 200 \text{ sfm}, f_z = 0.004 \text{ ipt}$																		
870	3	5	760	6	8	680	5	7	610	6	7	510	5	6	380	4	6	8
$V_c = 200 \text{ sfm}, f_z = 0.002 \text{ ipt}$																		

- The above table shows the conditions for standard shank type cutters. When using long shank type cutters, the number of teeth may be different. In this case, the cutting conditions should be changed by referring to: "The usage of standard and long shanks" shown in previous page.

- Cutting conditions are generally limited by the rigidity and power of the machine and the rigidity of the workpiece. When setting the conditions, start from half of the values of the standard cutting conditions and then increase the value gradually while making sure the machine is running normally.

Applications

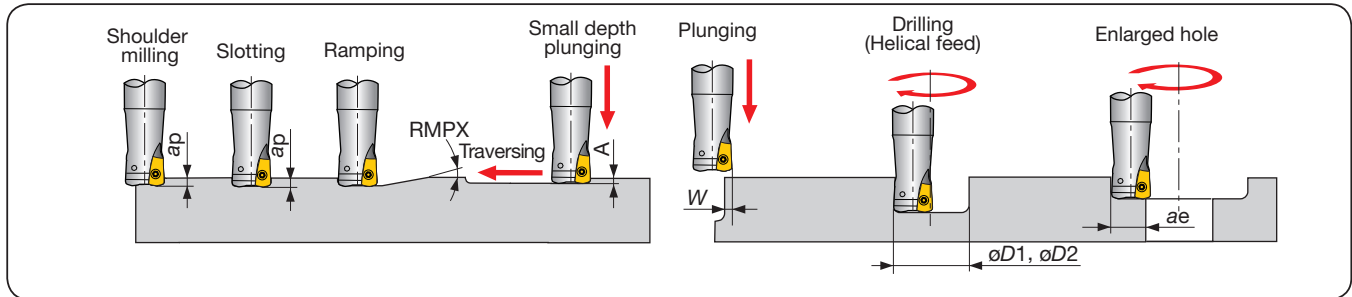

Inch	Tool dia. DCX	Max. depth of cut APMX	Max. ramping angle RMPX	Max. plunging depth A	Max. cutting width in plunging W	Min. machinable hole dia. øD1	Max. machinable hole dia. øD2	Max. cutting width in enlarged hole ae
EXN03R062U0062...	ø0.625	0.039	1.7°	0.012	0.118	0.897	1.181	0.492
EXN03R068U0062...	ø0.688	0.039	1.7°	0.012	0.118	0.991	1.339	0.571
EXN03R075U0075...	ø0.750	0.039	1.2°	0.012	0.118	1.132	1.496	0.650
EXN03R087U0075...	ø0.875	0.039	1°	0.012	0.118	1.371	1.654	0.728
EXN03R100U0100...	ø1.000	0.039	0.9°	0.012	0.118	1.610	1.890	0.846
EXN03R112U0100...	ø1.125	0.039	0.8°	0.012	0.118	1.857	2.126	0.965
EXN03R125U0125...	ø1.250	0.039	0.7°	0.012	0.118	2.104	2.441	1.122
TXN03R150U0075...	ø1.500	0.039	0.5°	0.012	0.118	2.750	3.070	1.437
TXN03R200U0075...	ø2.000	0.039	0.4°	0.012	0.118	3.540	3.858	1.830

For DCX above ø1.300", slot milling, ramping or contouring is not recommended as chips may be re-cut.



DOFEED TXN06

High feed mill, for 4-corner double sided inserts

GAMP = +10°, GAMF = +2° ~ +6°

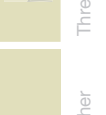
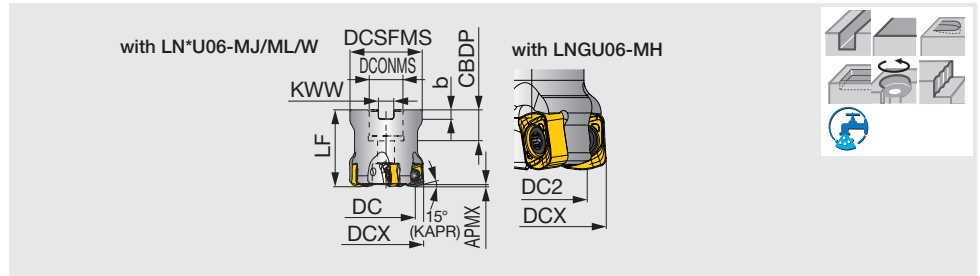

Inch	APMX	DCX	CICT	DC	DC2	DCSFMS	LF	DCONMS	CBDP	KWW	b	WT(lb)	Air hole	Insert
TXN06R200U0075A04	0.059	2.000	4	1.513	1.485	1.850	1.969	0.750	0.750	0.315	0.197	0.970	With	LN*U06...
TXN06R200U0075A05	0.059	2.000	5	1.513	1.485	1.850	1.969	0.750	0.750	0.315	0.197	0.990	With	LN*U06...
TXN06R250U0075A04	0.059	2.500	4	2.012	1.983	2.323	1.969	0.750	0.750	0.315	0.197	1.740	With	LN*U06...
TXN06R250U0075A06	0.059	2.500	6	2.012	1.983	2.323	1.969	0.750	0.750	0.315	0.197	1.760	With	LN*U06...
TXN06R300U0100A05	0.059	3.000	5	2.512	2.481	2.835	2.480	1.000	1.049	0.374	0.236	3.130	With	LN*U06...
TXN06R300U0100A07	0.059	3.000	7	2.512	2.481	2.835	2.480	1.000	1.049	0.374	0.236	3.280	With	LN*U06...
TXN06R400U0150A06	0.059	4.000	6	3.512	3.481	3.819	2.480	1.500	1.610	0.626	0.394	4.850	With	LN*U06...
TXN06R400U0150A10	0.059	4.000	10	3.512	3.481	3.819	2.480	1.500	1.610	0.626	0.394	4.850	With	LN*U06...
TXN06R500U0150A08	0.059	5.000	8	4.512	4.481	3.819	2.480	1.500	1.610	0.626	0.394	7.050	With	LN*U06...
TXN06R500U0150A12	0.059	5.000	12	4.512	4.481	3.819	2.480	1.500	1.610	0.626	0.394	7.280	With	LN*U06...
TXN06R600U0200A10	0.059	6.000	10	5.512	5.480	4.331	2.480	2.000	1.496	0.748	0.433	9.480	With	LN*U06...
TXN06R600U0200A14	0.059	6.000	14	5.512	5.480	4.331	2.480	2.000	1.496	0.748	0.433	9.260	With	LN*U06...

SPARE PARTS



Designation	Clamping screw	Grip	Lubricant	Torx bit	Shell locking bolt (Optional parts)
TXN06R200U..., 250U...	CSPB-5	H-TB2W	M-1000	BLDIP20/S7	(C0.375X1.125H)
TXN06R300U...	CSPB-5	H-TB2W	M-1000	BLDIP20/S7	(C0.500X1.375H)
TXN06R400U..., 500U...	CSPB-5	H-TB2W	M-1000	BLDIP20/S7	(TMBA-0.750H)
TXN06R600U...	CSPB-5	H-TB2W	M-1000	BLDIP20/M7	-

*Recommended clamping torque: CSPB-5 = 3.69 lbs·ft

Approach angle



DOFEED EXN06

High feed endmill, shank type, for 4-corner double sided inserts

GAMP = +10°, GAMF = -2° ~ +6°

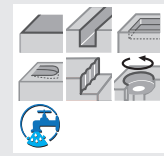
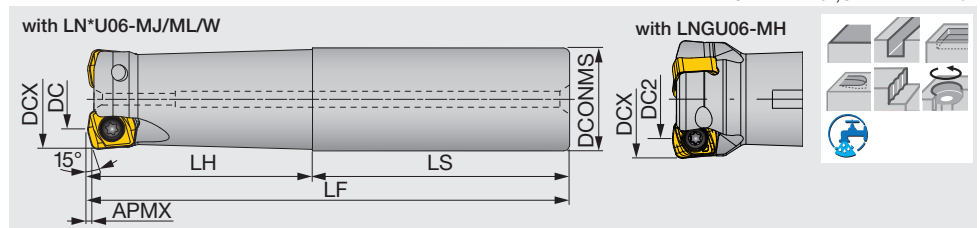

Inch	APMX	DCX	CICT	DC	DC2	DCONMS	LF	LH	LS	WT(lb)	Air hole	Insert
EXN06R125U0125W02	0.059	1.250	2	0.766	0.745	1.250	5.281	3.000	2.281	1.540	With	LN*U06...
EXN06R125U0125-02L	0.059	1.250	2	0.766	0.745	1.250	8.000	5.000	3.000	2.360	With	LN*U06...
EXN06R150U0125W03	0.059	1.500	3	1.014	0.989	1.250	5.781	3.500	2.281	1.830	With	LN*U06...
EXN06R150U0125-03L	0.059	1.500	3	1.014	0.989	1.250	10.000	2.000	8.000	3.310	With	LN*U06...

SPARE PARTS



Designation	Clamping screw	Lubricant	Wrench
EXN06	CSPB-5	M-1000	IP-20D

*Recommended clamping torque: CSPB-5 = 3.69 lbs·ft

Reference pages: Inserts → **H033**, Standard cutting conditions → **H034 - H035**

INSERT

LNMU06-MJ

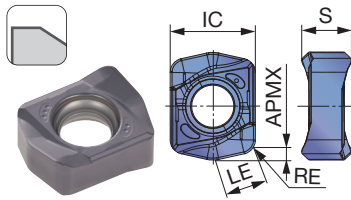

LNMU06-ML

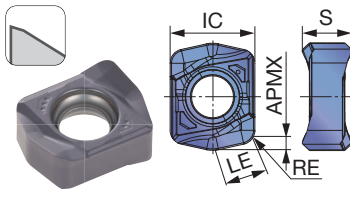

LNGU06-MH

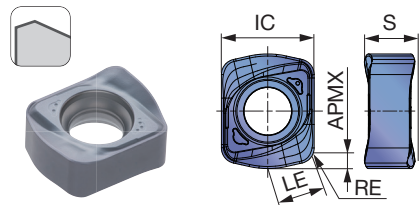

LNGU06-W (2 corners)

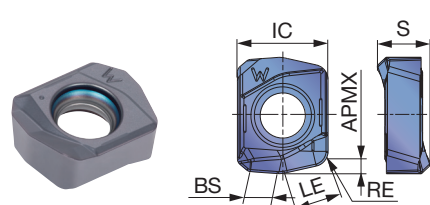

P	Steel		★	☆						
M	Stainless	★	☆	☆						
K	Cast iron		☆	☆	☆	★				
N	Non-ferrous									
S	Superalloys	★	☆		☆		★			
H	Hard materials				☆			★	☆	

★ : First choice
☆ : Second choice

Designation	RE	APMX	Coated							LE	IC	S	BS
			AH130	AH3225	AH3035	AH725	AH120	AH8015	AH8005				
LNMU06X5ZER-MJ	0.079	0.059	●	●	●	●	●	●		0.236	0.472	0.276	-
LNMU06X5ZER-ML	0.079	0.059	●	●	●	●	●	●		0.236	0.472	0.276	-
LNGU06X5ZER-MH	0.079	0.059						●	●	0.236	0.472	0.276	-
LNGU06X5ZER-W	0.079	0.059				●				0.236	0.472	0.276	0.142

● : Line up



STANDARD CUTTING CONDITIONS TXN06 / EXN06

ISO	Workpiece material	Hardness	Priority	Grade	Chip-breaker	Cutting speed Vc (sfm)	Feed per tooth: fz (ipt)		ø1.25", CICT = 2		ø1.5", CICT = 3	
							Tool dia.: DCX (in) ø1.25" - ø6"	Plunging	n	Vf	n	Vf
P	Carbon steels 1045, 1055, etc.	- 300HB	First choice	AH3225	MJ	330 - 980	0.020 - 0.059	0.006	2,020	162	1,680	202
	Alloy steels 4140, etc.	- 300HB	First choice	AH3225	MJ	330 - 660	0.020 - 0.059	0.006	2,020	162	1,680	202
	Prehardened steels NAK80, PX5, etc.	30 - 40HRC	First choice	AH3225	MJ	330 - 660	0.020 - 0.047	0.006	1,500	93	1,250	116
30 - 40HRC		Wear resistance	AH8015	MJ	330 - 660	0.020 - 0.060	0.006	1,500	120	1,250	150	
M	Stainless steels 304SS, 316SS, etc.	- 200HB	First choice	AH130	ML	260 - 490	0.012 - 0.031	0.004	1,190	57	990	71
	Precipitation hardening stainless steels 17-4 PH, etc.	28HRC - (H1150)	First choice	AH130	MS	260 - 490	0.008 - 0.020	0.004	1,190	29	990	36
		28HRC - (H1150)	Wear resistance	AH3225	MS	260 - 490	0.008 - 0.020	0.004	1,190	29	990	36
		40HRC - (H900)	First choice	AH3035	ML	260 - 390	0.004 - 0.012	0.004	1,010	16	840	20
K	Gray cast irons Class 25, etc.	150 - 250HB	First choice	AH120	MJ	330 - 980	0.020 - 0.059	0.006	2,020	162	1,680	202
		150 - 250HB	First choice	AH120	MJ	260 - 660	0.020 - 0.059	0.006	1,500	120	1,250	150
S	Titanium alloy Ti-6Al-4V, etc.	- 40HRC	First choice	AH130	ML	100 - 200	0.012 - 0.028	0.003	400	16	330	20
		- 40HRC	Fracture resistance	AH130	MJ	100 - 200	0.012 - 0.028	0.003	400	16	330	20
	Heat-resistant alloy Inconel, Hastelloy, etc.	- 40HRC	First choice	AH8015	ML	70 - 160	0.004 - 0.012	0.002	310	5	250	6
H	Hot mold steel HB, etc.	40 - 55HRC	First choice	AH8015	MH	260 - 490	0.004 - 0.020	0.002	1,190	29	990	36
		40 - 55HRC	Low resistance	AH8015	MJ	260 - 490	0.004 - 0.012	0.002	1,190	29	990	36
	Hot mold steel of D.T.C materials DAC**, DH**, DIEVER, etc	40 - 55HRC	First choice	AH8015	MJ	160 - 330	0.004 - 0.012	0.002	790	13	660	16
		40 - 55HRC	Fracture resistance	AH8015	MH	160 - 330	0.004 - 0.020	0.002	790	13	660	16
Cold mold steel D2, etc.	55 - 60HRC	First choice	AH8005	MH	160 - 230	0.002 - 0.012	0.001	610	5	510	6	
	55 - 60HRC	Fracture resistance	AH8015	MH	160 - 230	0.002 - 0.012	0.001	610	2	510	3	

The above table shows the conditions for standard shank type cutters. When using long shank type cutters, the number of teeth may be different. In this case, the cutting conditions should be changed by referring to: "The usage of standard and long shanks" shown in previous page.

Cutting conditions are generally limited by the rigidity and power of the machine and the rigidity of the workpiece. When setting the conditions, start from half of the values of the standard cutting conditions and then increase the value gradually while making sure the machine is running normally.

Cautionary points in use

The use of a standard or long shank

When using a long shank, please lower the cutting conditions (Vc, fz, ap) to 70% of the maximum conditions for the standard shank.

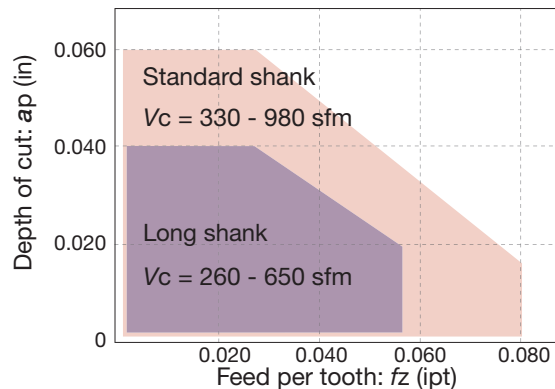

Tool dia.: DCX = ø1.250" - 1.500"
Workpiece: 1055 (200HB)

L/D ratio of overhang
Standard shank: L/D ≤ 3
Long shank: L/D = 4

Tool geometry on programming

When programming for CAM, the tool should be considered as a radius cutter. Usually, the corner radius should be set as R = 0.118". If a larger radius is used, overcutting will occur. The following table shows the amount left uncut (t1) and overcut (t2).

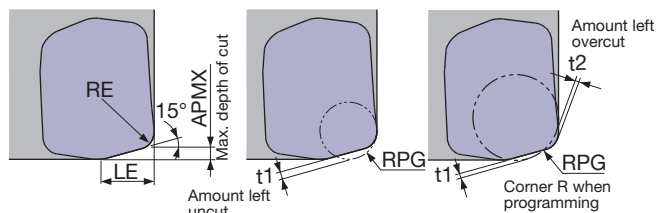

LNMU06-MJ/ML

Max. depth of cut APMX (in)	Corner radius RE	LE (in)	Corner R when programming: RPG	Amount left uncut t1 (in)	Amount left overcut t2 (in)
0.059	0.079	0.236	0.079	0.039	-
			0.118	0.030	-
			0.157	0.021	0.010

LNGU06-MH

Max. depth of cut APMX (in)	Corner radius RE	LE (in)	Corner R when programming: RPG	Amount left uncut t1 (in)	Amount left overcut t2 (in)
0.059	0.079	0.236	0.079	0.035	-
			0.118	0.026	-
			0.157	0.016	0.010

Each value in table is calculated theoretically at the maximum condition.

Tool dia: DCX (in), Number of revolution: n (min-1), Feed speed: V_f (ipm), Max. depth of cut: $ap=0.059"$, Number of teeth: CICT

$\phi 2"$		$\phi 2.5"$		$\phi 3"$		$\phi 4"$		$\phi 5"$		$\phi 6"$	
n	V_f	n	V_f	n	V_f	n	V_f	n	V_f	n	V_f
1,260	CICT = 4 CICT = 5 202 252	1,010	CICT = 4 CICT = 6 162 242	840	CICT = 5 CICT = 7 168 235	630	CICT = 6 CICT = 10 151 252	500	CICT = 8 CICT = 12 160 240	420	CICT = 10 CICT = 14 168 235
$V_c = 660 \text{ sfm}, f_z = 0.040 \text{ ipt}$											
1,260	202 252	1,010	162 242	840	168 235	630	151 252	500	160 240	420	168 235
$V_c = 660 \text{ sfm}, f_z = 0.040 \text{ ipt}$											
940	117 146	750	93 140	620	96 135	470	87 146	370	92 138	310	96 135
$V_c = 490 \text{ sfm}, f_z = 0.031 \text{ ipt}$											
940	150 188	750	120 180	620	124 174	470	113 188	370	118 178	310	124 174
$V_c = 490 \text{ sfm}, f_z = 0.040 \text{ ipt}$											
740	71 89	600	58 86	500	60 84	370	53 89	300	58 86	250	60 84
$V_c = 390 \text{ sfm}, f_z = 0.024 \text{ ipt}$											
740	36 44	600	29 43	500	30 42	370	27 44	300	29 43	250	30 42
$V_c = 390 \text{ sfm}, f_z = 0.012 \text{ ipt}$											
630	20 25	500	16 24	420	17 24	320	15 26	250	16 24	210	17 24
$V_c = 330 \text{ sfm}, f_z = 0.008 \text{ ipt}$											
1,260	202 252	1,010	162 242	840	168 235	630	151 252	500	160 240	420	168 235
$V_c = 660 \text{ sfm}, f_z = 0.040 \text{ ipt}$											
940	150 188	750	120 180	620	124 174	470	113 188	370	118 178	310	124 174
$V_c = 490 \text{ sfm}, f_z = 0.040 \text{ ipt}$											
250	20 25	200	16 24	170	17 24	120	14 24	100	16 24	80	16 22
$V_c = 130 \text{ sfm}, f_z = 0.020 \text{ ipt}$											
190	6 8	150	5 7	130	5 7	100	5 8	80	5 8	60	5 7
$V_c = 100 \text{ sfm}, f_z = 0.008 \text{ ipt}$											
740	36 44	600	29 43	500	30 42	370	27 44	300	29 43	250	30 42
$V_c = 390 \text{ sfm}, f_z = 0.012 \text{ ipt}$											
500	16 20	400	13 19	330	13 18	250	12 20	200	13 19	170	14 19
$V_c = 260 \text{ sfm}, f_z = 0.008 \text{ ipt}$											
380	6 8	310	5 7	250	5 7	190	5 8	150	5 7	130	5 7
$V_c = 200 \text{ sfm}, f_z = 0.004 \text{ ipt}$											
380	3 4	310	2 4	250	3 4	190	2 4	150	2 4	130	3 4
$V_c = 200 \text{ sfm}, f_z = 0.002 \text{ ipt}$											

Applications

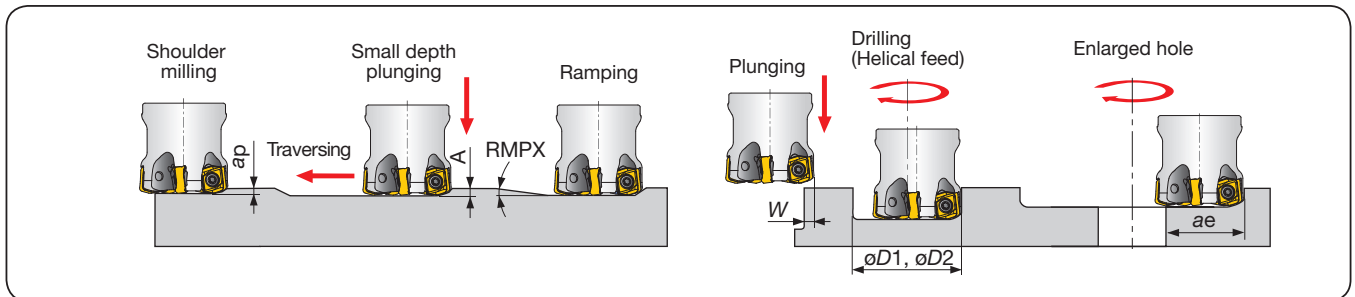

Inch	Tool dia. DCX	Max. depth of cut APMX	Max. ramping angle RMPX	Max. plunging depth A	Max. cutting width in plunging W	Min. machinable hole dia. $\phi D1$	Max. machinable hole dia. $\phi D2$	Max. cutting width in enlarged hole ae
EXN06R125U...	$\phi 1.250$	0.059	1.4°	0.016	0.236	1.830	2.300	0.970
EXN06R150U...	$\phi 1.500$	0.059	0.9°	0.016	0.236	2.330	2.800	1.220
TXN06R200U...	$\phi 2.000$	0.059	0.7°	0.016	0.236	3.330	3.800	1.720
TXN06R250U...	$\phi 2.500$	0.059	0.5°	0.016	0.236	4.330	4.800	2.220
TXN06R300U...	$\phi 3.000$	0.059	0.3°	0.016	0.236	5.330	5.800	2.720

For DCX above 4.000", slot milling, ramping or contouring is not recommended as chips may be re-cut.

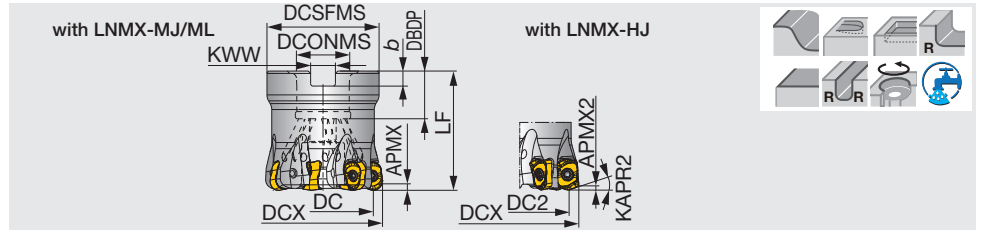
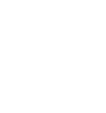
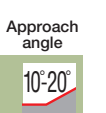

Inch	APMX	APMX2	DCX	CICT	DC	DC2	KAPR2	DCSFMS	LF	DCONMS	CBDP	KWW	b	WT(lb)	Air hole	Insert
TXLN04U1.50B0.50R06	0.157	0.051	1.500	6	1.200	1.169	20°	1.378	1.574	0.500	0.610	0.258	0.157	0.84	With	LNMX04...
TXLN04U2.00B0.75R07	0.157	0.051	2.000	7	1.700	1.669	20°	1.850	1.969	0.750	0.750	0.315	0.197	1.10	With	LNMX04...
TXLN06U2.00B0.75R05	0.236	0.079	2.000	5	1.512	1.500	25°	1.850	1.969	0.750	0.750	0.315	0.197	1.17	With	LNMX04...
TXLN06U2.50B0.75R06	0.236	0.079	2.500	6	2.008	2.000	25°	2.323	1.969	0.750	0.750	0.315	0.197	1.90	With	LNMX04...
TXLN06U3.00B1.00R07	0.236	0.079	3.000	7	2.508	2.500	25°	2.835	2.480	1.000	1.024	0.374	0.236	3.47	With	LNMX04...

Metric	APMX	APMX2	DCX	CICT	DC	DC2	KAPR2	DCSFMS	LF	DCONMS	CBDP	KWW	b	WT(kg)	Air hole	Insert
TXLN04M040B16.0R06	4	1.3	40	6	32.2	31.6	20°	35	40	16	18	8.4	5.6	0.21	With	LNMX04...
TXLN04M042B16.0R06	4	1.3	42	6	34.2	33.6	20°	35	40	16	18	8.4	5.6	0.21	With	LNMX04...
TXLN04M050B22.0R07	4	1.3	50	7	42.2	41.6	20°	47	50	22	20	10.4	6.3	0.45	With	LNMX04...
TXLN04M052B22.0R07	4	1.3	52	7	44.2	43.6	20°	47	50	22	20	10.4	6.3	0.47	With	LNMX04...
TXLN04M063B22.0R07	4	1.3	63	7	55.2	54.6	20°	59	50	22	20	10.4	6.3	0.76	With	LNMX04...
TXLN05M040B16.0R05	5	-	40	5	29.8	-	-	35	40	16	18	8.4	5.6	0.26	With	LNMX05...
TXLN05M050B22.0R06	5	-	50	6	39.8	-	-	47	50	22	20	10.4	6.3	0.50	With	LNMX05...
TXLN06M050B22.0R05	6	2	50	5	37.6	37.3	25°	47	50	22	20	10.4	6.3	0.50	With	LNMX06...
TXLN06M052B22.0R05	6	2	52	5	39.6	39.3	25°	49	50	22	20	10.4	6.3	0.55	With	LNMX06...
TXLN06M063B22.0R06	6	2	63	6	50.6	50.3	25°	59	50	22	20	10.4	6.3	0.82	With	LNMX06...

SPARE PARTS



Designation	Clamping screw	Torx bit	Grip	Shell locking bolt (Optional parts)
TXLN04U1.50B0.50R06	CSPD-3	BLD IP10/S7	SW6-SD	(SR UNF 1/4X3/4 B18.3)
TXLN04U2.00B0.75R07	CSPD-3	BLD IP10/S7	SW6-SD	(C0.375X1.125H)
TXLN06U2.00B..., TXLN06U2.50B...	CSPB-5	BLDIP20/S7	H-TB2W	(C0.375X1.125H)
TXLN06U3.00B1.00R07	CSPB-5	BLDIP20/S7	H-TB2W	(C0.500X1.375H)
TXLN04M04*B16.0R06	CSPD-3	BLD IP10/S7	SW6-SD	FSHM8-30H
TXLN04M05*B22.0R07	CSPD-3	BLD IP10/S7	SW6-SD	CM10X30H
TXLN04M063B22.0R07	CSPD-3	BLD IP10/S7	SW6-SD	CM10X30H
TXLN05M040B16.0R05	CSPB-4S	BLDIP15/S7	H-TB2W	FSHM8-30H
TXLN05M050B22.0R06	CSPB-4S	BLDIP15/S7	H-TB2W	CM10X30H
TXLN06M050B22.0R05	CSPB-5	BLDIP20/S7	H-TB2W	FSHM10-40H
TXLN06M052B22.0R05	CSPB-5	BLDIP20/S7	H-TB2W	CM10X30H
TXLN06M063B22.0R06	CSPB-5	BLDIP20/S7	H-TB2W	CM10X30H

*Recommended clamping torque: CSPD-3 = 1.84 lbs·ft, 2.5 N·m, CSPB-4S = 2.58 lbs·ft, 3.5 N·m, CSPB-5 = 3.69 lbs·ft, 5 N·m

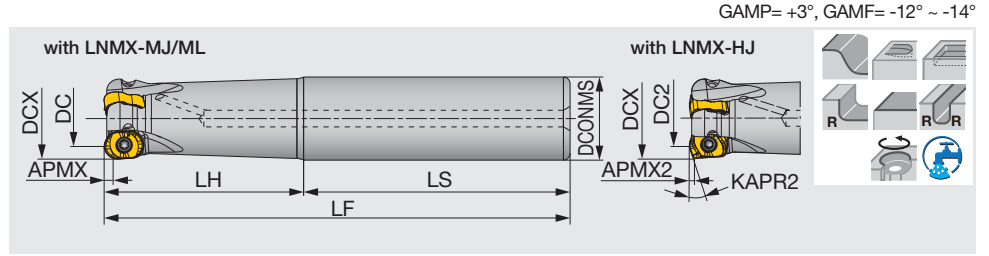

Inch	APMX	APMX2	DCX	CICT	DC	DC2	KAPR2	DCONMS	LS	LH	LF	WT(lb)	Air hole	Insert
EXLN04U1.00C1.00R03	0.157	0.051	1.000	3	0.685	0.669	20°	1.000	3.000	2.500	5.500	1.000	With	LNMX04...
EXLN04U1.25C1.25R04	0.157	0.051	1.250	4	0.935	0.919	20°	1.250	3.000	3.000	6.000	1.800	With	LNMX04...
EXLN04U1.25C1.25R05	0.157	0.051	1.250	5	0.935	0.919	20°	1.250	3.000	3.000	6.000	1.800	With	LNMX04...
EXLN06U1.25C1.25R02	0.236	0.079	1.250	2	0.764	0.750	25°	1.250	3.000	3.000	6.000	1.900	With	LNMX04...
EXLN06U1.50C1.25R03	0.236	0.079	1.500	3	1.012	1.000	25°	1.250	4.000	2.000	6.000	2.060	With	LNMX05..

Metric	APMX	APMX2	DCX	CICT	DC	DC2	KAPR2	DCONMS	LS	LH	LF	WT(kg)	Air hole	Insert
EXLN04M020C20.0R02	4	1.3	20	2	12.2	11.6	20°	20	80	50	130	0.28	With	LNMX04...
EXLN04M025C25.0R03	4	1.3	25	3	17.2	16.6	20°	25	80	60	140	0.46	With	LNMX04...
EXLN04M032C32.0R04	4	1.3	32	4	24.2	23.6	20°	32	80	70	150	0.83	With	LNMX04...
EXLN04M032C32.0R05	4	1.3	32	5	24.2	23.6	20°	32	80	70	150	0.83	With	LNMX04...
EXLN05M025C25.0R02	5	-	25	2	15	-	-	25	90	60	150	0.54	With	LNMX05..
EXLN05M032C32.0R04	5	-	32	4	21.9	-	-	32	80	70	150	0.87	With	LNMX05..
EXLN06M032C32.0R02	6	2	32	2	19.6	19.3	25°	32	80	70	150	0.90	With	LNMX06..
EXLN06M040C32.0R04	6	2	40	4	27.6	27.3	25°	32	100	50	150	0.95	With	LNMX06..

SPARE PARTS



Designation	Clamping screw	Mono block wrench	Torx bit	Grip
EXLN04...	CSPD-3	IP-10D	-	-
EXLN05...	CSPB-4S	-	BLDIP15/S7	H-TB2W
EXLN06...	CSPB-5	-	BLDIP20/S7	H-TB2W

*Recommended clamping torque: CSPD-3 = 1.84 lbs·ft, 2.5 N·m, CSPB-5 = 3.69 lbs·ft, 5 N·m





DOTWIST HXLN04-M

Radius endmill, modular type, for 4-corner double sided inserts (TungFlex)

GAMP= +3°, GAMF= -12° ~ -14°

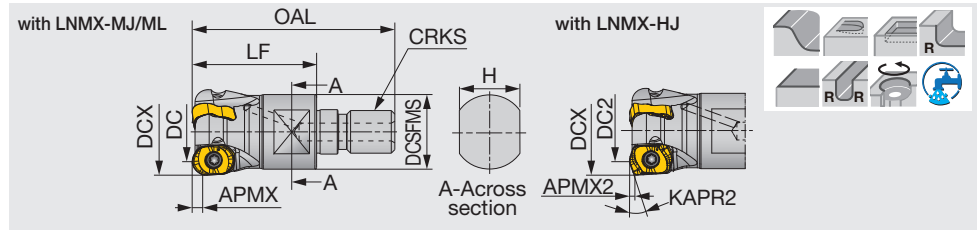
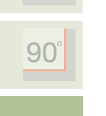
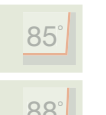
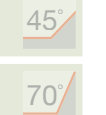

Metric	APMX	APMX2	DCX	CICT	DC	DC2	KAPR2	OAL	LF	H	DCSFMS	CRKS	WT(kg)	Air hole	Insert
HXLN04M020M10R02	4	1.3	20	2	12.2	11.6	20°	49	30	15	18	M10	0.07	With	LNMX04...
HXLN04M025M12R03	4	1.3	25	3	17.2	16.6	20°	57	35	17	21	M12	0.16	With	LNMX04...
HXLN04M032M16R04	4	1.3	32	4	24.2	23.6	20°	63	40	22	29	M16	0.20	With	LNMX04...
HXLN05M025M12R02	5	-	25	2	15	-	-	57	35	17	21	M12	0.10	With	LNMX05...
HXLN05M032M16R04	5	-	32	4	21.9	-	-	63	40	22	28.8	M16	0.20	With	LNMX05...
HXLN06M032M16R02	6	2	32	2	19.6	19.3	25°	63	40	22	28.8	M16	0.24	With	LNMX06...

See page H167 for TungFlex modular shank.

SPARE PARTS



Designation	Clamping screw	Mono block wrench	Torx bit	Grip
HXLN04...	CSPD-3	IP-10D	-	-
HXLN05...	CSPB-4S	-	BLDIP15/S7	H-TB2W
HXLN06...	CSPB-5	-	BLDIP20/S7	H-TB2W

*Recommended clamping torque: CSPD-3 = 2.5 N·m, CSPB-4S = 3.5 N·m, CSPB-5 = 5 N·m

INSERT

LNMX-MJ

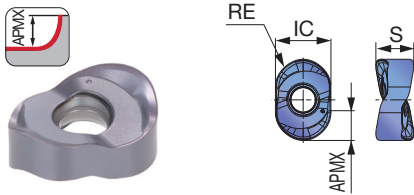

LNMX-ML

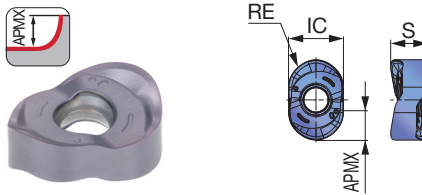

LNMX-HJ

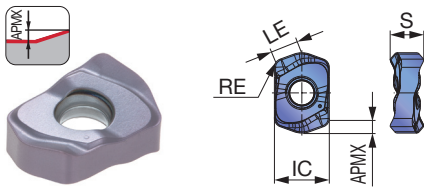

P	Steel	☆	★												
M	Stainless		★												
K	Cast iron	★													
N	Non-ferrous														
S	Superalloys	★	☆												
H	Hard materials	★	★												

★ : First choice
☆ : Second choice

Designation	RE	APMX	Coated		LE	IC	S
			AH120	AH3135			
LNMX0405R4-MJ	0.157	0.157	●	●	-	0.323	0.220
LNMX0405R4-ML	0.157	0.157	●	●	-	0.323	0.220
LNMX0405ZER-HJ	0.051	0.051	●	●	0.169	0.323	0.197
LNMX0506R5-MJ	0.197	0.197	●	●	-	0.409	0.240
LNMX0607R6-MJ	0.236	0.236	●	●	-	0.496	0.291
LNMX0607ZER-HJ	0.079	0.079	●	●	0.264	0.500	0.283

● : Line up

STANDARD CUTTING CONDITIONS

For MJ,ML

ISO	Workpiece material	Hardness	Priority	Grade	Chip-breaker	Cutting speed Vc (sfm)	Feed per tooth fz (ipt)	
P	Low carbon steel 1015, 1020, etc.	- 200 HB	First choice	AH3135	MJ	325 - 980	0.008 - 0.024	
		- 200 HB	Low cutting force	AH3135	ML	325 - 980	0.008 - 0.024	
	Carbon steel, Alloy steel 1055, 4140, etc.	- 300 HB	First choice	AH3135	MJ	325 - 820	0.008 - 0.024	
		- 300 HB	Low cutting force	AH3135	ML	325 - 820	0.008 - 0.024	
	Prehardened steel NAK80, PX5, etc.	30 - 40 HRC	First choice	AH3135	MJ	325 - 655	0.006 - 0.016	
		30 - 40 HRC	Low cutting force	AH3135	ML	325 - 655	0.006 - 0.016	
M	Austenitic Stainless steel 304SS, 316SS, etc.	- 200 HB	First choice	AH3135	MJ	325 - 655	0.008 - 0.024	
		- 200 HB	Low cutting force	AH3135	ML	325 - 655	0.008 - 0.024	
	Martensitic Stainless steel 420SS etc.	- 200 HB	First choice	AH3135	ML	325 - 980	0.008 - 0.024	
		- 200 HB	Fracture resistance	AH3135	MJ	325 - 980	0.008 - 0.024	
K	Gray cast iron Class 25, Class 30, etc.	150 - 250 HB	First choice	AH120	MJ	325 - 980	0.008 - 0.024	
		150 - 250 HB	Low cutting force	AH120	ML	325 - 980	0.008 - 0.024	
	Ductile cast iron 60-40-18, 80-55-06, etc.	150 - 250 HB	First choice	AH120	MJ	260 - 820	0.008 - 0.024	
		150 - 250 HB	Low cutting force	AH120	ML	260 - 820	0.008 - 0.024	
S	Titanium alloy Ti-6Al-4V, etc.	-	First choice	AH3135	ML	95 - 195	0.006 - 0.024	
		-	Fracture resistance	AH3135	MJ	95 - 195	0.006 - 0.024	
	Superalloys Inconel718, etc.	-	First choice	AH120	ML	65 - 160	0.002 - 0.012	
		-	Fracture resistance	AH120	MJ	65 - 160	0.002 - 0.012	
H	Hardened steel	H13, etc.	40 - 50 HRC	First choice	AH3135	MJ	160 - 490	0.004 - 0.012
			40 - 50 HRC	Wear resistance	AH120	MJ	160 - 490	0.004 - 0.012
	D2, etc.	50 - 60 HRC	First choice	AH120	MJ	160 - 225	0.002 - 0.006	

Grade
Insert
Toolholder
Ext. Toolholder
Int. Toolholder
Threading
Grooving
Miniature Tool
Milling Cutter
Endmill
Drilling Tool
Tooling System
User's Guide
Index



STANDARD CUTTING CONDITIONS

LNMX04-HJ

ISO	Workpiece material	Hardness	Priority	Grade	Chip-breaker	Cutting speed Vc (sfm)	Feed per tooth fz (ipt)	
P	Low carbon steel 1015, 1020, etc.	- 300HB	First choice	AH3135	HJ	325 - 980	0.020 - 0.051	
			Wear resistance	AH120				
	Carbon steel, Alloy steel 1055, 4140, etc.	- 300HB	First choice	AH3135	HJ	325 - 820	0.020 - 0.051	
			Wear resistance	AH120				
M	Prehardened steel NAK80, PX5, etc.	30 - 40HRC	First choice	AH3135	HJ	325 - 655	0.016 - 0.039	
			Wear resistance	AH120				
M	Austenitic Stainless steel 304SS, 316SS, etc.	- 200HB	First choice	AH3135	HJ	325 - 655	0.012 - 0.035	
	Martensitic Stainless steel 420SS, etc.	- 200HB	First choice	AH3135	HJ	325 - 980	0.012 - 0.035	
K	Gray cast iron Class 25, Class 30, etc.	150 - 250HB	First choice	AH120	HJ	325 - 980	0.020 - 0.051	
			Fracture resistance	AH3135				
K	Ductile cast iron 60-40-18, 80-55-06, etc.	150 - 250HB	First choice	AH120	HJ	260 - 820	0.020 - 0.051	
			Fracture resistance	AH3135				
S	Titanium alloy Ti-6Al-4V, etc.	150 - 250HB	First choice	AH3135	HJ	95 - 195	0.012 - 0.028	
	Superalloys Inconel718, etc.	150 - 250HB	First choice	AH120	HJ	65 - 160	0.004 - 0.012	
H	Hardened steel	H13, etc.	40 - 50HRC	First choice	AH3135	HJ	160 - 490	0.004 - 0.020
				Wear resistance	AH120			
		D2, etc.	50 - 60HRC	First choice	AH120	HJ	160 - 225	0.002 - 0.008

LNMX06-HJ

ISO	Workpiece material	Hardness	Priority	Grade	Chip-breaker	Cutting speed Vc (sfm)	Feed per tooth fz (ipt)	
P	Low carbon steel 1015, 1020, etc.	- 300HB	First choice	AH3135	HJ	325 - 980	0.012 - 0.044	
			Wear resistance	AH120				
	Carbon steel, Alloy steel 1055, 4140, etc.	- 300HB	First choice	AH3135	HJ	325 - 820	0.012 - 0.044	
			Wear resistance	AH120				
M	Prehardened steel NAK80, PX5, etc.	30 - 40HRC	First choice	AH3135	HJ	325 - 655	0.008 - 0.028	
			Wear resistance	AH120				
M	Austenitic Stainless steel 304SS, 316SS, etc.	- 200HB	First choice	AH3135	HJ	325 - 655	0.008 - 0.028	
	Martensitic Stainless steel 420SS, etc.	- 200HB	First choice	AH3135	HJ	325 - 980	0.008 - 0.028	
K	Gray cast iron Class 25, Class 30, etc.	150 - 250HB	First choice	AH120	HJ	325 - 980	0.012 - 0.044	
			Fracture resistance	AH3135				
K	Ductile cast iron 60-40-18, 80-55-06, etc.	150 - 250HB	First choice	AH120	HJ	260 - 820	0.012 - 0.044	
			Fracture resistance	AH3135				
S	Titanium alloy Ti-6Al-4V, etc.	150 - 250HB	First choice	AH3135	HJ	95 - 195	0.006 - 0.024	
	Superalloys Inconel718, etc.	150 - 250HB	First choice	AH120	HJ	65 - 160	0.002 - 0.012	
H	Hardened steel	H13, etc.	40 - 50HRC	First choice	AH3135	HJ	160 - 490	0.004 - 0.012
				Wear resistance	AH120			
		D2, etc.	50 - 60HRC	First choice	AH120	HJ	160 - 225	0.002 - 0.006

Tool dia: ϕDc (in), Number of revolution: n (rpm), Feed speed: Vf (ipm), Max. depth of cut: $ap = 0.051"$, Number of teeth: z

$\phi 0.787"$, CICT = 2		$\phi 0.984"$, CICT = 3		$\phi 1.260"$			$\phi 1.575"$, CICT = 6		$\phi 1.654"$, CICT = 6		$\phi 1.969"$, CICT = 7		$\phi 2.047"$, CICT = 7		$\phi 2.480"$, CICT = 7	
n	Vf	n	Vf	n	Vf		n	Vf	n	Vf	n	Vf	n	Vf	n	Vf
					Coarse pitch (CICT = 4)	Close pitch (CICT = 5)										
3,180	225	2,550	271	1,990	282	353	1,590	338	1,520	323	1,270	315	1,220	303	1,010	250
Vc = 656 sfm, fz = 0.036 ipt																
2,860	203	2,290	243	1,790	254	317	1,430	304	1,360	289	1,150	285	1,100	273	910	226
Vc = 590 sfm, fz = 0.036 ipt																
2,390	132	1,910	158	1,490	164	206	1,190	197	1,140	189	950	183	920	178	760	146
Vc = 492 sfm, fz = 0.028 ipt																
2,390	113	1,910	135	1,490	141	176	1,190	169	1,140	161	950	157	920	152	760	126
Vc = 492 sfm, fz = 0.024 ipt																
3,180	150	2,550	181	1,990	188	235	1,590	225	1,520	215	1,270	210	1,220	202	1,010	167
Vc = 656 sfm, fz = 0.024 ipt																
3,180	225	2,550	271	1,990	282	353	1,590	338	1,520	323	1,270	315	1,220	303	1,010	250
Vc = 656 sfm, fz = 0.036 ipt																
2,550	181	2,040	217	1,590	225	282	1,270	270	1,210	257	1,020	253	980	243	810	201
Vc = 525 sfm, fz = 0.036 ipt																
720	28	570	34	450	35	44	360	43	340	40	290	40	280	39	230	32
Vc = 148 sfm, fz = 0.02 ipt																
480	7	380	9	300	9	12	240	11	230	11	190	11	180	10	150	8
Vc = 98 sfm, fz = 0.008 ipt																
1,590	37	1,270	45	990	47	59	800	57	760	54	640	53	610	50	510	42
Vc = 328 sfm, fz = 0.012 ipt																
950	9	760	11	600	12	15	480	14	450	13	380	13	370	13	300	10
Vc = 197 sfm, fz = 0.005 ipt																

Tool dia: DCX (in), Number of revolution: n (rpm), Feed speed: Vf (ipm), Max. depth of cut: $ap = 0.079"$, Number of teeth: z

$\phi 1.260$, $z = 2$		$\phi 1.575$, $z = 4$		$\phi 1.969$, $z = 5$		$\phi 2.047$, $z = 5$		$\phi 2.480$, $z = 6$	
n	Vf	n	Vf	n	Vf	n	Vf	n	Vf
2,010	110	1,670	140	1,250	180	1,000	170	840	160
Vc = 656 sfm, fz = 0.028 ipt									
1,800	100	1,500	130	1,130	160	900	150	750	150
Vc = 590 sfm, fz = 0.028 ipt									
1,500	50	1,250	70	940	80	750	80	630	80
Vc = 492 sfm, fz = 0.018 ipt									
1,500	50	1,250	70	940	80	750	80	630	80
Vc = 492 sfm, fz = 0.018 ipt									
2,010	70	1,670	90	1,250	110	1,000	110	840	110
Vc = 656 sfm, fz = 0.018 ipt									
2,010	110	1,670	140	1,250	180	1,000	170	840	160
Vc = 656 sfm, fz = 0.028 ipt									
1,600	90	1,340	110	1,000	140	800	130	670	130
Vc = 525 sfm, fz = 0.028 ipt									
450	14	380	17	280	21	230	21	190	20
Vc = 148 sfm, fz = 0.015 ipt									
300	4	250	5	190	7	150	6	130	6
Vc = 98 sfm, fz = 0.007 ipt									
1,000	16	840	20	630	25	500	24	420	24
Vc = 328 sfm, fz = 0.008 ipt									
600	5	500	6	380	8	300	7	250	7
Vc = 197 sfm, fz = 0.004 ipt									

MACHINING APPLICATIONS

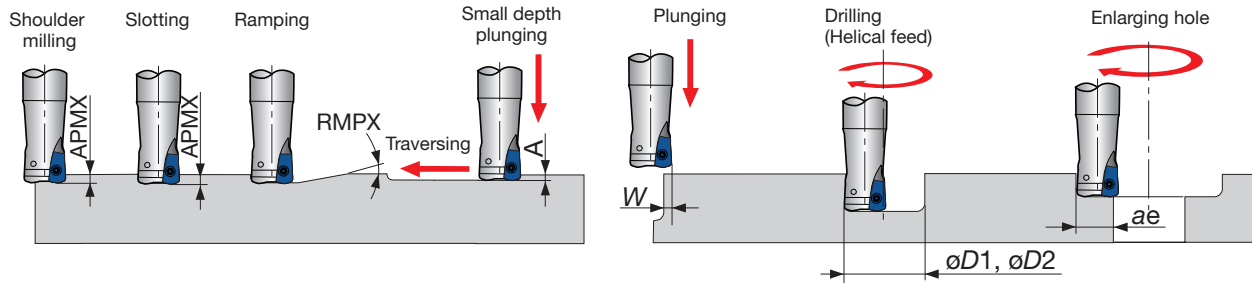

MJ, ML

Inch	DCX	Max. depth of cut	Max. ramping angle	Max. plunging	Max. cutting width in plunging	Min. machining dia.	Max. machining dia.	Max. cutting width in enlarging
		APMX	RMPX	A	W	øD1	øD2	ae
EXLN04U1.00C1.00R03	1.000	0.157	3°	0.031	0.157	1.535	1.929	0.803
EXLN04U1.25C1.25R04	1.250	0.157	1.9°	0.031	0.157	2.047	2.402	1.053
EXLN04U1.25C1.25R05	1.250	0.157	1.9°	0.031	0.157	2.047	2.402	1.053
TXLN04U1.50B0.50R06	1.500	0.157	1.2°	0.024	0.157	2.511	2.905	1.342
TXLN04U2.00B0.75R07	2.000	0.157	1°	0.027	0.157	3.496	3.889	1.842
HXLN04M020M10R02	0.787	0.157	4.7°	0.031	0.157	1.102	1.496	0.591
HXLN04M025M12R03	0.984	0.157	3°	0.031	0.157	1.496	1.890	0.787
HXLN04M032M16R04	1.260	0.157	2°	0.031	0.157	2.047	2.441	1.063
EXLN06U1.25C01.25R02	1.250	0.236	3.7°	0.039	0.394	1.732	2.421	0.827
EXLN06U1.50C01.25R03	1.500	0.236	4°	0.067	0.394	2.165	2.921	1.063
TXLN06U2.00B0.75R05	2.000	0.236	2.7°	0.067	0.394	3.150	3.921	1.575
TXLN06U2.50B0.75R06	2.500	0.236	2.3°	0.079	0.394	4.134	4.921	2.047
TXLN06U3.00B1.00R07	3.000	0.236	1.6°	0.071	0.394	5.157	5.921	2.559

HJ

Inch	DCX	Max. depth of cut	Max. ramping angle	Max. plunging	Max. cutting width in plunging	Min. machining	Max. machining	Max. cutting width in enlarging
		APMX	RMPX	A	W	øD1	øD2	ae
EXLN04U1.00C1.00R03	1.000	0.051	3°	0.030	0.161	1.496	1.929	0.803
EXLN04U1.25C1.25R04	1.250	0.051	2°	0.030	0.161	2.008	2.441	1.053
EXLN04U1.25C1.25R05	1.250	0.051	2°	0.030	0.161	2.008	2.441	1.053
TXLN04U1.50B0.50R06	1.500	0.157	1.3°	0.024	0.161	2.456	2.905	1.342
TXLN04U2.00B0.75R07	2.000	0.157	1°	0.027	0.161	3.456	3.889	1.842
HXLN04M020M10R02	0.787	0.051	4.9°	0.030	0.161	1.063	1.496	0.610
HXLN04M025M12R03	0.984	0.051	3°	0.030	0.161	1.457	1.890	0.807
HXLN04M032M16R04	1.260	0.051	2°	0.030	0.161	2.008	2.441	1.083
EXLN06U1.25C01.25R02	1.250	0.079	5.7°	0.055	0.433	1.614	2.421	0.787
EXLN06U1.50C01.25R03	1.500	0.079	4.3°	0.059	0.433	2.087	2.921	1.024
TXLN06U2.00B0.75R05	2.000	0.079	2.7°	0.063	0.433	3.110	4.000	1.535
TXLN06U2.50B0.75R06	2.500	0.079	2°	0.067	0.433	4.094	4.921	2.008
TXLN06U3.00B1.00R07	3.000	0.079	1.4°	0.067	0.433	5.079	5.921	2.520

TOOL GEOMETRY ON PROGRAMMING FOR HIGH FEED

The following table shows the amount left uncut (t1) and overcut (t2).

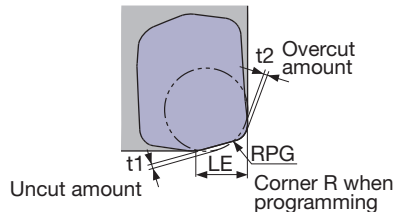

	Max. depth of cut APMX (in)	LE (in)	Programmed corner R (in)	Amount left uncut t1 (in)	Amount left overcut t2 (in)
LNMx04-HJ	0.051	0.161	R0.059	0.031	-
	0.051	0.161	R0.079	0.026	-
	0.051	0.161	R0.098	0.020	0.002
	0.051	0.161	R0.118	0.014	0.008
LNMx06-HJ	0.079	0.236	R0.079	0.055	-
	0.079	0.236	R0.118	0.043	-
	0.079	0.236	R0.138	0.036	-
	0.079	0.236	R0.157	0.029	0.002
	0.079	0.236	R0.197	0.016	0.014

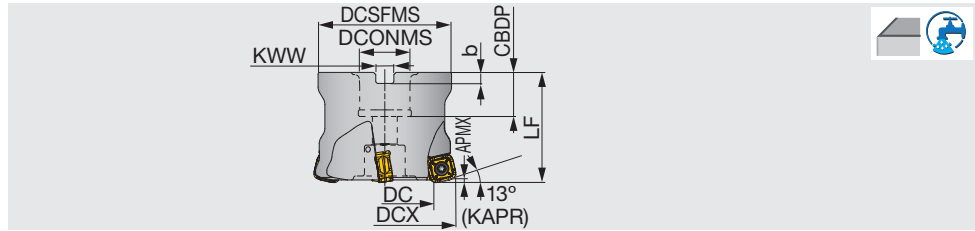

Inch	APMX	DCX	CICT	DC	DCSFMS	LF	DCONMS	CBDP	KWW	b	WT(lb)	Air hole	Insert
TXQ12R200U0075A03	0.079	2.000	3	1.362	1.850	1.969	0.750	0.750	0.315	0.197	1.120	With	SQMU1206ZSR-MJ
TXQ12R200U0075A04	0.079	2.000	4	1.362	1.850	1.969	0.750	0.750	0.315	0.197	1.120	With	SQMU1206ZSR-MJ
TXQ12R250U0075A04	0.079	2.500	4	1.862	2.323	1.969	0.750	0.750	0.315	0.197	1.760	With	SQMU1206ZSR-MJ
TXQ12R300U0100A05	0.079	3.000	5	2.362	2.835	2.480	1.000	1.024	0.374	0.236	3.770	With	SQMU1206ZSR-MJ
TXQ12R400U0150A06	0.079	4.000	6	3.362	3.780	2.480	1.500	1.457	0.626	0.394	5.710	With	SQMU1206ZSR-MJ
TXQ12R500U0150A07	0.079	5.000	7	4.362	3.780	2.480	1.500	1.457	0.626	0.394	7.010	With	SQMU1206ZSR-MJ
TXQ12R600U0200AZ08	0.079	6.000	8	5.37	3.937	2.480	2.000	1.496	0.748	0.433	9.700	With	SQMU1206ZSR-MJ

SPARE PARTS



Designation	Clamping screw	Grip	Lubricant	Torx bit	Shell locking bolt (Optional parts)
TXQ12R**U0075A...	CSPB-4	H-TBS	M-1000	BLDIP15/S7	(C0.375X1.125H)
TXQ12R300U0100A05	CSPB-4	H-TBS	M-1000	BLDIP15/S7	(C0.500X1.375H)
TXQ12R**U0150A...	CSPB-4	H-TBS	M-1000	BLDIP15/S7	(TMBA-0.750H)
TXQ12R600U0200AZ08	CSPB-4	H-TBS	M-1000	BLDIP15/S7	-

*Recommended clamping torque: CSPB-4 = 2.58 lbs·ft

INSERT

SQMU-MJ

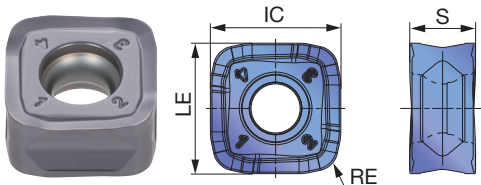

P	Steel	☆	★	☆								
M	Stainless		★	☆								
K	Cast iron	★		☆								
N	Non-ferrous											
S	Superalloys	★	☆	★								
H	Hard materials			★								

★ : First choice
☆ : Second choice

Designation	RE	APMX	Coated				LE	S	IC
			AH120	AH130	AH725	T3130			
SQMU1206ZSR-MJ	0.079	0.079	●	●	●	●	0.461	0.236	0.461

● : Line up

STANDARD CUTTING CONDITIONS



ISO	Workpiece material	Hardness	Priority	Grades	Cutting speed Vc (sfm)	Feed per tooth fz (ipt)
P	Carbon steels 1045, 1055, etc.	~ 300HB	First choice	AH725	330 - 980	0.020 - 0.080
			Wear resistance	T3130	330 - 980	0.020 - 0.080
			Fracture resistance	AH130	330 - 980	0.020 - 0.080
	Alloy steels 4140, etc.	~ 300HB	First choice	AH725	330 - 660	0.020 - 0.060
			Wear resistance	T3130	330 - 660	0.020 - 0.060
			Fracture resistance	AH130	330 - 660	0.020 - 0.060
	Prehardened steels NAK80, PX5, etc.	30 ~ 40HRC	-	AH725	330 - 660	0.020 - 0.040
M	Stainless steels 304, 316, etc.	~ 200HB	-	AH130	330 - 500	0.012 - 0.030
K	Gray cast irons No.25, No.30, etc.	-	-	AH120	100 - 300	0.020 - 0.080
	Ductile cast irons 60-40-18, 65-45-12, etc.	-	-	AH120	260 - 660	0.020 - 0.080
S	Titanium alloy Ti-6Al-4V, etc.	~ 40HRC	-	AH725	100 - 200	0.012 - 0.028
H	Hardened steels H13, D2, etc.	40 ~ 50HRC	-	AH725	260 - 43	0.004 - 0.012
		50 ~ 60HRC	-	AH725	160 - 230	0.001 - 0.003

- Slot or pocket milling is not recommended, since chip re-cutting easily occurs.
- Tool overhang length must be as short as possible to avoid chatter. When the tool overhang length is long, decrease the number of revolutions and feed.

- Cutting conditions are generally limited by the rigidity and power of the machine and the rigidity of the workpiece. When setting the conditions, start from half of the values of the standard cutting conditions and then increase the value gradually while making sure the machine is running normally.



Tool dia: DCX (in), Number of revolution: *n* (rpm), Feed speed: *Vf* (ipm), Max. depth of cut: APMX = 0.079"

ø2.000"		ø2.500"		ø3.000"		ø4.000"		ø5.000"	
<i>n</i>	<i>Vf</i>	<i>n</i>	<i>Vf</i>	<i>n</i>	<i>Vf</i>	<i>n</i>	<i>Vf</i>	<i>n</i>	<i>Vf</i>
1,260	227	1,010	242	790	237	630	227	500	210
Vc = 660 sfm, fz = 0.060 ipt									
950	114	750	120	590	118	470	113	380	106
Vc = 500 sfm, fz = 0.040 ipt									
950	86	750	90	590	89	470	85	380	80
Vc = 490 sfm, fz = 0.030 ipt									
760	46	600	48	470	47	380	46	300	42
Vc = 400 sfm, fz = 0.020 ipt									
1,260	227	1,010	242	790	237	630	227	500	210
Vc = 660 sfm, fz = 0.060 ipt									
950	171	750	180	590	177	470	170	380	160
Vc = 500 sfm, fz = 0.060 ipt									
250	15	200	16	150	15	120	14	100	14
Vc = 130 sfm, fz = 0.020 ipt									
630	15	500	16	390	16	310	15	250	14
Vc = 330 sfm, fz = 0.008 ipt									
380	2	300	2	240	2	190	2	150	2
Vc = 200 sfm, fz = 0.002 ipt									

Grade
Insert
Ext. Toolholder
Int. Toolholder
Threading
Grooving
Miniature Tool
Milling Cutter
Endmill
Drilling Tool
User's Guide Tooling System
Index





MILLQ^{UAD}FEED

TXSW09

High feed mill, for 4-corner single sided inserts

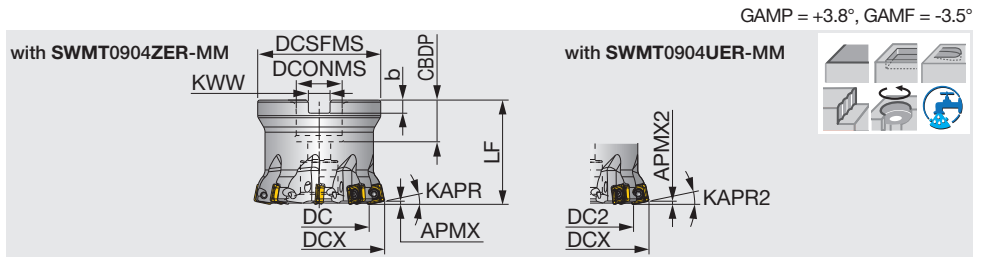

Inch	APMX	APMX2	DCX	CICT	DC	DC2	DCSFMS	DCONMS	CBBDP	LF	KWW	b	KAPR	KAPR2	WT(lb)	Air hole	Insert
TXSW09U1.50B0.50R05	0.059	0.039	1.500	5	0.909	0.870	1.378	0.500	0.630	1.575	0.258	0.157	12°	7°	0.180	With	SWMT09...
TXSW09U2.00B0.75R07	0.059	0.039	2.000	7	1.405	1.366	1.772	0.750	0.750	1.969	0.315	0.197	12°	7°	0.380	With	SWMT09...

SPARE PARTS

Designation	Clamping screw	Torx bit	Grip	Shell locking bolt (optional parts)	Lubricant
TXSW09U1.50B0.50R05	CSPD-3	BLDIP10/S7	H-TB2W	(SR UNF 1/4X3/4 B18.3)	M-1000
TXSW09U2.00B0.75R07	CSPD-3	BLDIP10/S7	H-TB2W	(C0.375X1.125H)	M-1000

*Recommended clamping torque : CSPD-3 = 1.84 lbs·ft



MILLQ^{UAD}FEED

EXSW09

High feed mill, for 4-corner single sided inserts

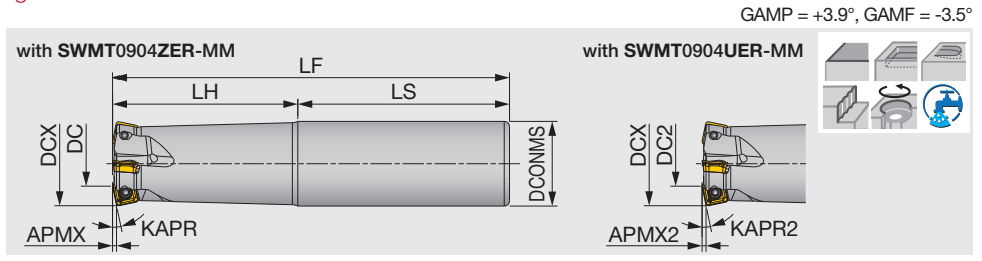

Inch	APMX	APMX2	DCX	CICT	DC	DC2	DCONMS	LF	LH	LS	KAPR	KAPR2	WT(lb)	Air hole	Insert
EXSW09U1.00C1.00R03	0.059	0.039	1.000	3	0.409	0.370	1.000	5.500	2.500	3.000	12°	7°	0.460	With	SWMT09...
EXSW09U1.00C1.00R03L	0.059	0.039	1.000	3	0.409	0.370	1.000	7.000	4.000	3.000	12°	7°	0.580	With	SWMT09...
EXSW09U1.25C1.25R04	0.059	0.039	1.250	4	0.657	0.618	1.250	6.000	3.000	3.000	12°	7°	0.810	With	SWMT09...
EXSW09U1.25C1.25R04L	0.059	0.039	1.250	4	0.657	0.618	1.250	8.000	5.000	3.000	12°	7°	1.070	With	SWMT09...

SPARE PARTS

Designation	Clamping screw	Wrench	Lubricant
EXSW09...	CSPD-3	IP-10D	M-1000

*Recommended clamping torque : CSPD-3 = 1.84 lbs·ft

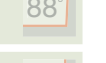
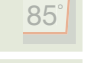
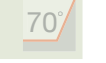
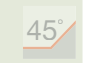
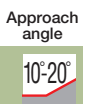

Reference pages: Inserts → [H047](#), Standard cutting conditions → [H048 - H049](#)

High feed mill, for 4-corner single sided inserts

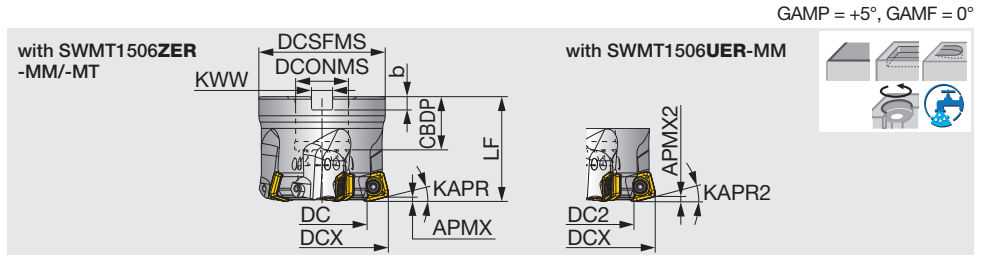

Inch	APMX	APMX2	DCX	CICT	DC	DC2	DCSFMS	LF	DCONMS	CBDP	KWW	b	KAPR	KAPR2	WT(lb)	Air hole	Insert
TXSW15U2.00B0.75R03	0.098	0.079	2.000	3	0.929	0.905	1.850	1.969	0.750	0.750	0.315	0.197	14°	10°	0.950	With	SWMT15...
TXSW15U2.50B0.75R04	0.098	0.079	2.500	4	1.480	1.405	2.323	1.969	0.750	0.750	0.315	0.197	14°	10°	1.520	With	SWMT15...
TXSW15U3.00B1.00R05	0.098	0.079	3.000	5	1.980	1.905	2.835	2.480	1.000	1.024	0.374	0.236	14°	10°	2.710	With	SWMT15...
TXSW15U4.00B1.50R06	0.098	0.079	4.000	6	2.980	2.905	3.819	2.480	1.500	1.063	0.626	0.394	14°	10°	4.870	With	SWMT15...
TXSW15U5.00B1.50R07	0.098	0.079	5.000	7	3.980	3.905	3.819	2.480	1.500	1.614	0.626	0.394	14°	10°	6.370	With	SWMT15...
TXSW15U6.00B2.00R08	0.098	0.079	6.000	8	4.980	4.905	4.331	2.480	2.000	1.496	0.748	0.433	14°	10°	8.290	With	SWMT15...

SPARE PARTS

Designation	Clamping screw	Grip	Lubricant	Shell locking bolt 1 (Optional parts)	Shell locking bolt 2	Torx bit
TXSW15U2.00B0.75R03	TS50115I	H-TB2W	M-1000	-	SR 5/16-32UNEF_3/8-2	BT20S
TXSW15U2.50B0.75R04	TS50115I	H-TB2W	M-1000	(C0.375X1.125H)	-	BT20S
TXSW15U3.00B1.00R05	TS50115I	H-TB2W	M-1000	(C0.500x1.375H)	-	BT20S
TXSW15U4.00B1.50R06	TS50115I	H-TB2W	M-1000	(TMBA-0.750H)	-	BT20S
TXSW15U5.00B1.50R07	TS50115I	H-TB2W	M-1000	(TMBA-0.750H)	-	BT20M
TXSW15U6.00B2.00R08	TS50115I	H-TB2W	M-1000	-	-	BT20M

*Recommended clamping torque : TS50115I = 3.69 lbs·ft

When installing TXSW15U2.00B0.75R03 on the arbor

- Always use the dedicated shell locking bolt (part code: SRPS118-0273) included in the package.
- Thoroughly read the installation manual included in the package before installation.

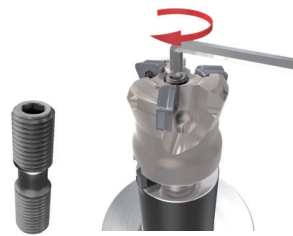

INSERT

SWMT09/15ZER-MM

SWMT09/15UER-MM

SWMT15ZER-MT

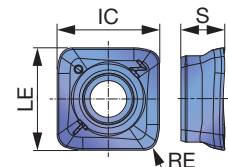
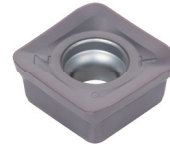
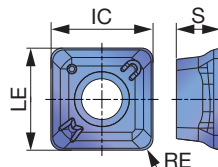
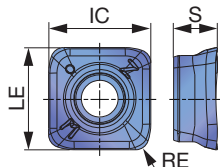

Material	RE	APMX	Coated
P Steel	☆	★	
M Stainless		★	
K Cast iron	★		
N Non-ferrous			
S Superalloys	★	☆	
H Hard materials	★	★	

★ : First choice
☆ : Second choice

Designation	RE	APMX	Coated		LE	IC	S
			AH120	AH3135			
SWMT0904ZER-MM	0.039	0.059	●	●	0.339	0.339	0.157
SWMT0904UER-MM	0.039	0.039	●	●	0.356	0.356	0.157
SWMT1506ZER-MM	0.079	0.098	●	●	0.630	0.630	0.268
SWMT1506UER-MM	0.079	0.079	●	●	0.641	0.641	0.268
SWMT1506ZER-MT	0.079	0.098	●	●	0.627	0.627	0.268

● : Line up

Reference pages: Standard cutting conditions → **H048 - H049**



STANDARD CUTTING CONDITIONS

09 type

ISO	Workpiece material	Hardness	Priority	Insert type	Chip-breaker	Grade	Cutting speed Vc (sfm)	Feed per tooth fz (ipt)	
P	Carbon steel 1045, 1055, etc.	- 300HB	First choice	ZER	MM	AH3135	330 - 990	0.020 - 0.060	
			for wear resistance	UER	MM	AH3135	330 - 990	0.020 - 0.060	
	Alloy steel 4140, etc.	- 300HB	First choice	ZER	MM	AH3135	330 - 660	0.020 - 0.060	
			for wear resistance	UER	MM	AH3135	330 - 660	0.020 - 0.060	
	Prehardened steel NAK80, PX5, etc.	30 - 40HRC	First choice	ZER	MM	AH3135	330 - 660	0.020 - 0.047	
			for wear resistance	UER	MM	AH3135	330 - 660	0.020 - 0.047	
M	Austenitic stainless steel 304, etc.	- 200HB	First choice	UER	MM	AH3135	330 - 490	0.020 - 0.047	
			Low cutting load	ZER	MM	AH3135	330 - 490	0.020 - 0.047	
	Precipitation hardening stainless steel 174, etc.	28HRC - (H1150)	First choice	UER	MM	AH3135	260 - 490	0.012 - 0.047	
			Low cutting load	ZER	MM	AH3135	260 - 490	0.012 - 0.047	
		40HRC - (H900)	First choice	UER	MM	AH3135	260 - 400	0.012 - 0.031	
			Low cutting load	ZER	MM	AH3135	260 - 400	0.012 - 0.031	
K	Gray cast iron No.250B, No.300B, etc.	150 - 250HB	First choice	ZER	MM	AH3135	330 - 990	0.020 - 0.080	
S	Titanium alloys Ti-6Al-4V, etc.	- 40HRC	First choice	UER	MM	AH3135	100 - 200	0.012 - 0.028	
			Low cutting load	ZER	MM	AH3135	100 - 200	0.012 - 0.028	
H	Heat-resistant alloys Inconel, Hastelloy, etc.	- 40HRC	First choice	UER	MM	AH3135	70 - 170	0.004 - 0.012	
			for wear resistance	ZER	MM	AH3135	70 - 170	0.004 - 0.012	
H	Hardened steel	H13, etc.	40 - 50HRC	First choice	ZER	MM	AH3135	260 - 430	0.004 - 0.012

15 type

ISO	Workpiece material	Hardness	Priority	Insert type	Chip-breaker	Grade	Cutting speed Vc (sfm)	Feed per tooth fz (ipt)	
P	Carbon steel 1045, 1055, etc.	- 300HB	First choice	ZER	MM	AH3135	330 - 990	0.020 - 0.060	
			for wear resistance	ZER	MM	AH120	330 - 990	0.020 - 0.060	
	Alloy steel 4140, etc.	- 300HB	for impact resistance	ZER	MT	AH3135	330 - 990	0.020 - 0.080	
			First choice	ZER	MM	AH3135	330 - 660	0.020 - 0.060	
		Prehardened steel NAK80, PX5, etc.	30 - 40HRC	for wear resistance	ZER	MM	AH120	330 - 660	0.020 - 0.047
				for impact resistance	ZER	MT	AH3135	330 - 660	0.020 - 0.060
M	Austenitic stainless steel 304, etc.	- 200HB	First choice	UER	MM	AH3135	330 - 490	0.020 - 0.047	
			Low cutting load	ZER	MM	AH3135	330 - 490	0.020 - 0.047	
	Precipitation hardening stainless steel 174, etc.	28HRC - (H1150)	First choice	UER	MM	AH3135	260 - 490	0.012 - 0.047	
			Low cutting load	ZER	MM	AH3135	260 - 490	0.012 - 0.047	
		40HRC - (H900)	First choice	UER	MM	AH3135	260 - 400	0.012 - 0.031	
			Low cutting load	ZER	MM	AH3135	260 - 400	0.012 - 0.031	
K	Gray cast iron No.250B, No.300B, etc.	150 - 250HB	First choice	ZER	MT	AH120	330 - 990	0.020 - 0.080	
			for impact resistance	ZER	MT	AH3135	330 - 990	0.020 - 0.080	
			Low cutting load	ZER	MM	AH120	330 - 990	0.020 - 0.060	
S	Titanium alloys Ti-6Al-4V, etc.	- 40HRC	First choice	ZER	MT	AH120	260 - 660	0.020 - 0.080	
			for impact resistance	ZER	MT	AH3135	260 - 660	0.020 - 0.080	
			Low cutting load	ZER	MM	AH120	260 - 660	0.020 - 0.060	
H	Heat-resistant alloys Inconel, Hastelloy, etc.	- 40HRC	First choice	UER	MM	AH3135	100 - 200	0.012 - 0.028	
			for impact resistance	ZER	MT	AH3135	100 - 200	0.012 - 0.028	
			Low cutting load	ZER	MM	AH120	100 - 200	0.012 - 0.028	
H	Hardened steel	H13, etc.	40 - 50HRC	First choice	ZER	MT	AH3135	260 - 430	0.004 - 0.012
			for wear resistance	ZER	MT	AH120	260 - 430	0.004 - 0.012	
H		D2, etc.	50 - 60HRC	First choice	ZER	MT	AH120	160 - 230	0.002 - 0.008

Tool dia.: DC (in), Number of revolutions: *n* (rpm), Feed speed: *Vf* (ipm), Number of inserts: CICT

ø1.000", CICT = 3		ø1.250", CICT = 4		ø1.500", CICT = 5		ø2.000", CICT = 7	
<i>n</i>	<i>Vf</i>	<i>n</i>	<i>Vf</i>	<i>n</i>	<i>Vf</i>	<i>n</i>	<i>Vf</i>
2,550	301	1,990	313	1,590	313	1,270	350
Vc = 660 sfm, fz = 0.040 ipt							
1,910	226	1,490	235	1,190	234	960	265
Vc = 490 sfm, fz = 0.040 iptt							
1,910	180	1,490	188	1,190	187	960	212
Vc = 490 sfm, fz = 0.031 ipt							
1,530	144	1,190	150	960	151	760	168
Vc = 400 sfm, fz = 0.031 ipt							
1,530	144	1,190	150	960	151	760	168
Vc = 400 sfm, fz = 0.031 ipt							
1,270	90	1,000	94	800	94	640	106
Vc = 330 sfm, fz = 0.024 ipt							
2,550	361	1,990	376	1,590	376	1,270	420
Vc = 660 sfm, fz = 0.047 ipt							
1,910	271	1,490	281	1,190	281	1,270	420
Vc = 490 sfm, fz = 0.047 ipt							
510	30	400	31	320	31	250	35
Vc = 150 sfm, fz = 0.020 ipt							
380	9	300	9	240	9	190	11
Vc = 120 sfm, fz = 0.008 ipt							
1,270	30	1,000	31	800	31	640	35
Vc = 100 sfm, fz = 0.200 ipt							

Tool dia.: DC (in), Number of revolutions: *n* (rpm), Feed speed: *Vf* (ipm), Number of inserts: CICT

ø2.000", CICT = 3		ø2.500", CICT = 4		ø3.000", CICT = 5		ø4.000", CICT = 6		ø5.000", CICT = 7		ø6.000", CICT = 8	
<i>n</i>	<i>Vf</i>	<i>n</i>	<i>Vf</i>	<i>n</i>	<i>Vf</i>	<i>n</i>	<i>Vf</i>	<i>n</i>	<i>Vf</i>	<i>n</i>	<i>Vf</i>
1,270	150	1,010	159	800	157	640	151	510	141	400	126
Vc = 660 sfm, fz = 0.040 ipt											
1,270	180	1,010	191	800	189	640	181	510	169	400	151
Vc = 660 sfm, fz = 0.047 ipt											
960	113	760	120	600	118	480	113	380	105	300	94
Vc = 490 sfm, fz = 0.040 ipt											
960	136	760	144	600	142	480	136	380	126	300	113
Vc = 490 sfm, fz = 0.047 ipt											
960	91	760	96	600	94	480	91	380	84	300	76
Vc = 490 sfm, fz = 0.031 ipt											
960	113	760	120	600	118	480	113	380	105	300	94
Vc = 490 sfm, fz = 0.040 ipt											
760	72	610	77	480	76	380	72	310	69	240	61
Vc = 400 sfm, fz = 0.031 ipt											
760	72	610	77	480	76	380	72	310	69	240	61
Vc = 400 sfm, fz = 0.031 ipt											
640	45	510	48	400	47	320	45	250	41	200	38
Vc = 330 sfm, fz = 0.024 ipt											
1,270	180	1,010	191	800	189	640	181	510	169	400	151
Vc = 660 sfm, fz = 0.047 ipt											
1,270	150	1,010	159	800	157	640	151	510	141	400	126
Vc = 660 sfm, fz = 0.040 ipt											
960	136	760	144	600	142	480	136	380	126	300	113
Vc = 490 sfm, fz = 0.047 ipt											
960	113	760	120	600	118	480	113	380	105	300	94
Vc = 490 sfm, fz = 0.040 ipt											
250	15	200	16	160	16	130	15	100	14	80	13
Vc = 150 sfm, fz = 0.020 ipt											
200	5	150	5	120	5	100	5	80	4	60	4
Vc = 120 sfm, fz = 0.008 ipt											
640	15	510	16	400	16	320	15	250	14	200	13
Vc = 100 sfm, fz = 0.200 ipt											
380	6	300	6	240	6	190	6	150	5	120	5
Vc = 60 sfm, fz = 0.120 ipt											

Grade
Insert
Ext. Toolholder
Int. Toolholder
Threading
Grooving
Miniature Tool
Milling Cutter
Endmill
Drilling Tool
Tooling System
User's Guide
Index



APPLICATION RANGE

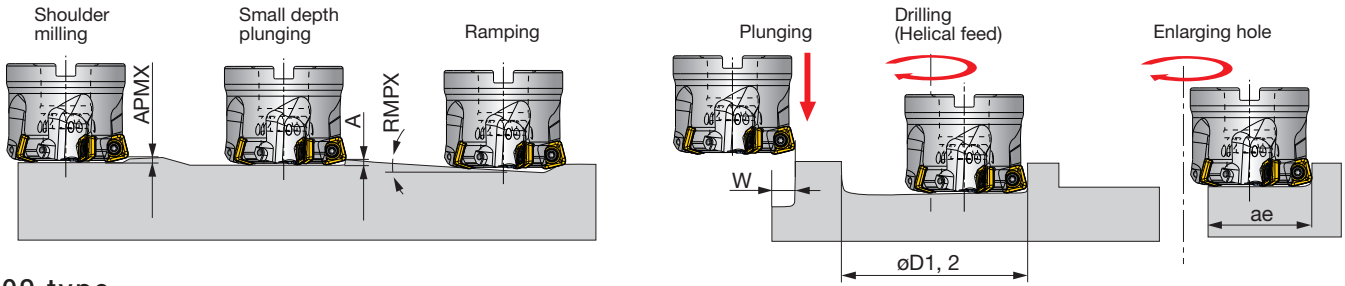

09 type

Inch	Tool dia. DCX	Max. depth of cut		Max. plunging depth A	Max. ramping angle		Max. cutting width in plunging		Min. machining dia. øD1		Max. machining dia. øD2		Max. cutting width in enlarging ae	
		APMX			RMPX		W							
		SWMT 09**ZER	SWMT 09**UER	SWMT 09**ZER	SWMT 09**UER	SWMT 09**ZER	SWMT 09**UER	SWMT 09**ZER	SWMT 09**UER	SWMT 09**ZER	SWMT 09**UER	SWMT 09**ZER	SWMT 09**UER	SWMT 09**ZER
EXSW09U1.00...	1.000	0.059	0.039	0.012	4.6°	5.8°	0.275	0.295	1.370	1.331	1.881	1.881	0.665	0.645
EXSW09U1.25...	1.250	0.059	0.039	0.012	2.7°	3.2°	0.275	0.295	1.870	1.831	2.381	2.381	0.914	0.894
TXSW09U1.50...	1.500	0.059	0.039	0.012	1.9°	2.2°	0.275	0.295	2.370	2.331	2.881	2.881	1.165	1.145
TXSW09U2.00...	2.000	0.059	0.039	0.012	1.2°	1.4°	0.275	0.295	3.370	3.331	3.881	3.881	1.663	1.643

15 type

Inch	Tool dia. DCX	Max. depth of cut		Max. plunging depth A	Max. ramping angle		Max. cutting width in plunging		Min. machining dia. øD1	Max. machining dia. øD2	Max. cutting width in enlarging ae	
		APMX			RMPX		W					
		SWMT 15**ZER	SWMT 15**UER	SWMT 15**ZER	SWMT 15**UER	SWMT 15**ZER	SWMT 15**UER	SWMT 15**ZER	SWMT 15**UER	SWMT 15**ZER	SWMT 15**UER	SWMT 15**ZER
TXSW15M050B...	2.000	0.098	0.079	0.028	4.6°	5.8°	0.591	0.630	2.787	3.772	1.433	1.393
TXSW15M063B...	2.500	0.098	0.079	0.028	2.9°	3.2°	0.591	0.630	3.819	4.803	1.949	1.909
TXSW15J, M080B...	3.000	0.098	0.079	0.028	2.1°	2.2°	0.591	0.630	4.819	5.803	2.449	2.409
TXSW15J, M100B...	4.000	0.098	0.079	0.028	1.4°	1.4°	0.591	0.630	6.819	7.803	3.449	3.409
TXSW15J, M125B...	5.000	0.098	0.079	0.028	1°	1°	0.591	0.630	8.819	9.803	4.449	4.409
TXSW15J, M160B...	6.000	0.098	0.079	0.028	0.8°	0.8°	0.591	0.630	10.819	11.803	5.449	5.409

TOOL GEOMETRY FOR PROGRAMMING

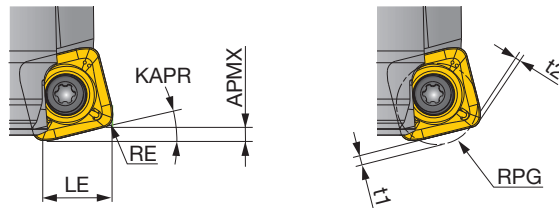

09 type

APMX (in)		Actual corner radius RE (in)	LE (in)		KAPR		Programmed corner radius RPG	Uncut amount: t1 (in)		Overcut amount: t2 (in)	
SWMT 09**ZER	SWMT 09**UER		SWMT 09**ZER	SWMT 09**UER	SWMT 09**ZER	SWMT 09**UER		SWMT 09**ZER	SWMT 09**UER	SWMT 09**ZER	SWMT 09**UER
0.059	0.039	0.039	0.291	0.311	12°	7°	0.025	0.054	0.033	-	-
0.059	0.039	0.039	0.291	0.311	12°	7°	0.050	0.049	0.031	-	-
0.059	0.039	0.039	0.291	0.311	12°	7°	0.075	0.045	0.028	-	0.0002
0.059	0.039	0.039	0.291	0.311	12°	7°	0.100	0.040	0.025	0.001	0.006
0.059	0.039	0.039	0.291	0.311	12°	7°	0.125	0.036	0.022	0.006	0.015

15 type

APMX (in)		Actual corner radius RE (in)	LE (in)		KAPR		Programmed corner radius RPG	Uncut amount: t1 (in)		Overcut amount: t2 (in)	
SWMT 15**ZER	SWMT 15**UER		SWMT 15**ZER	SWMT 15**UER	SWMT 15**ZER	SWMT 15**UER		SWMT 15**ZER	SWMT 15**UER	SWMT 15**ZER	SWMT 15**UER
0.098	0.079	0.079	0.500	0.543	14°	10°	0.138	0.083	0.073	-	-
0.098	0.079	0.079	0.500	0.543	14°	10°	0.157	0.078	0.070	-	-
0.098	0.079	0.079	0.500	0.543	14°	10°	0.178	0.074	0.067	-	0.001
0.098	0.079	0.079	0.500	0.543	14°	10°	0.197	0.070	0.063	0.0003	0.005

When programming for CAM, the tool should be considered as a radius cutter. Usually, the corner radius should be set in SWMT**ZER insert: RPG = 0.177", SWMT**UER insert: RPG = 0.157". If a larger radius is used, overcutting may occur. The above table shows the uncut (t1) and overcut (t2) amounts for the programmed corner radius.

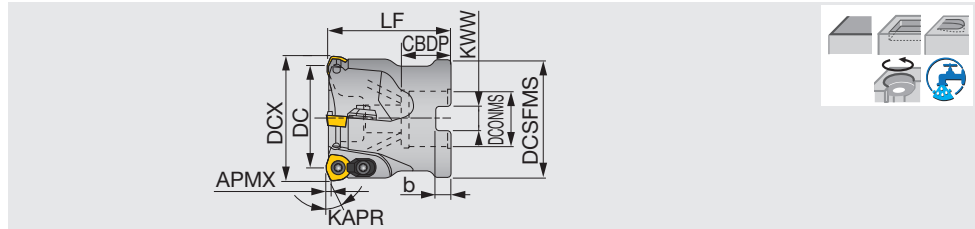

Inch	APMX	DCX	CICT	DC	DCSFMS	LF	DCONMS	CBDP	KWW	b	KAPR	WT(lb)	Air hole	Insert
TXP05250RBU	0.060	2.500	6	2.190	2.323	1.969	0.750	0.750	0.315	0.197	15°	1.76	With	WPM*05...
TXP05300RBU	0.060	3.000	7	2.690	2.835	2.480	1.000	1.024	0.374	0.236	20°	3.31	With	WPM*05...
TXP06200RBU	0.060	2.000	4	1.650	1.850	1.969	0.750	0.750	0.315	0.197	20°	1.10	With	WPM*06...
TXP06250RBU	0.060	2.500	5	2.150	2.323	1.969	0.750	0.750	0.315	0.197	20°	1.76	With	WPM*06...
TXP06300RBU	0.060	3.000	6	2.650	2.835	2.480	1.000	1.024	0.374	0.236	20°	3.09	With	WPM*06...
TXP08050RU	0.060	2.000	3	1.547	1.850	1.969	0.750	0.750	0.315	0.197	10°	0.87	Without	WPMT08...
TXP08200RU-A	0.060	2.000	3	1.547	1.850	1.969	0.750	0.750	0.315	0.197	10°	0.87	With	WPMT08...
TXP08300RU-A	0.060	3.000	5	2.547	2.835	2.480	1.000	1.024	0.375	0.236	10°	3.20	With	WPMT08...
TXP08400RU-A	0.060	4.000	6	3.547	3.819	2.480	1.500	1.260	0.625	0.394	10°	5.80	With	WPMT08...
TXP09250RU	0.118	2.500	3	1.971	2.323	1.969	0.750	0.750	0.315	0.197	20°	1.54	With	WPMT09...
TXP09300RU	0.118	3.000	4	2.470	2.835	2.480	1.000	1.024	0.374	0.236	20°	2.65	With	WPMT09...
TXP09400RU	0.118	4.000	5	3.471	3.780	2.480	1.500	1.457	0.626	0.394	20°	4.41	With	WPMT09...
TXP09500RU	0.118	5.000	6	4.471	3.780	2.480	1.500	1.457	0.626	0.394	20°	6.83	With	WPMT09...
TXP09600RU	0.118	6.000	7	5.471	4.331	2.480	2.000	1.496	0.748	0.433	20°	9.48	Without	WPMT09...

SPARE PARTS



Designation	Clamp set	Clamping screw	Lubricant	Wrench	Wrench 1	Shell locking bolt (Optional parts)
TXP05250RBU	-	CSPB-3.5S	M-1000	IP-15D	-	(C0.375X1.125H)
TXP05300RBU	-	CSPB-3.5S	M-1000	IP-15D	-	(C0.500X1.375H)
TXP06200RBU, TXP06250RBU	CSY-15	CSPB-4S	M-1000	IP-15D	-	(C0.375X1.125H)
TXP06300RBU	CSY-15	CSPB-4S	M-1000	IP-15D	-	(C0.500X1.375H)
TXP08050RU, TXP08200RU-A	CSX20	CSTB-5	M-1000	-	T-20T	(C0.375X1.125H)
TXP08300RU-A	CSX20	CSTB-5	M-1000	-	T-20T	(C0.500X1.375H)
TXP08400RU-A	CSX20	CSTB-5	M-1000	-	T-20T	(TMBA-0.750H)
TXP09250RU	CSY-20	CSPB-5	M-1000	-	IP-20T	(C0.375X1.125H)
TXP09300RU	CSY-20	CSPB-5	M-1000	-	IP-20T	(C0.500X1.375H)
TXP09400RU, TXP09500RU	CSY-20	CSPB-5	M-1000	-	IP-20T	(TMBA-0.750H)
TXP09600RU	CSY-20	CSPB-5	M-1000	-	IP-20T	-

*Recommended clamping torque : CSPB-3.5S/CSPB-4S = 2.58 lbs·ft, CSTB-5 = 3.69 lbs·ft





High Feed Milling



Face Milling



Shoulder Milling



Slot Milling



Profile Milling



Thread Milling



Other

Approach angle



Others

MILLFEED

EXP05/06/08/09

High feed endmill, shank type

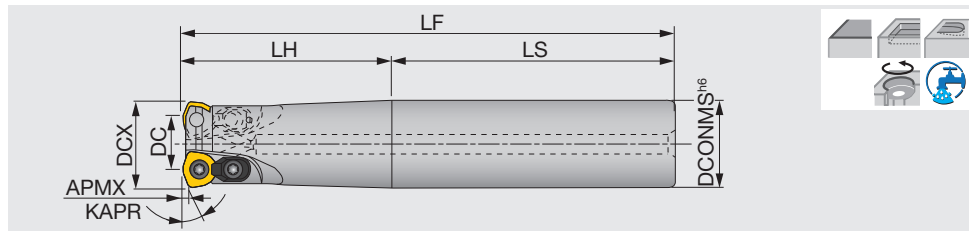

Inch	APMX	DCX	CICT	DC	DCONMS	LF	LH	LS	KAPR	Air hole	Insert	Shank
EXP05075RSU	0.060	0.750	2	0.480	0.750	4.031	2.000	2.031	15°	With	WPM*05...	Cylindrical
EXP05075RLU	0.060	0.750	2	0.480	0.750	7.000	2.000	2.031	15°	With	WPM*05...	Cylindrical
EXP05075RLLU	0.060	0.750	2	0.480	0.750	10.000	4.000	3.000	15°	With	WPM*05...	Cylindrical
EXP06100RSU	0.060	1.000	2	0.697	1.000	4.781	5.000	3.000	15°	With	WPM*06...	Cylindrical
EXP06100RLU	0.060	1.000	2	0.697	1.000	8.000	5.000	3.000	15°	With	WPM*06...	Cylindrical
EXP06100RLLU	0.060	1.000	2	0.697	1.000	12.000	7.000	5.000	15°	With	WPM*06...	Cylindrical
EXP06125RSBU	0.060	1.250	3	0.929	1.250	5.281	3.000	2.281	20°	With	WPM*06...	Cylindrical
EXP06125RLBU	0.060	1.250	3	0.929	1.250	8.000	5.000	3.000	20°	With	WPM*06...	Cylindrical
EXP06125RLLBU	0.060	1.250	3	0.929	1.250	12.000	7.000	5.000	20°	With	WPM*06...	Cylindrical
EXP06150RSU	0.060	1.500	3	1.169	1.250	5.781	3.500	2.281	20°	With	WPM*06...	Cylindrical
EXP06150RLU	0.060	1.500	3	1.169	1.250	10.000	2.000	8.000	20°	With	WPM*06...	Cylindrical
EXP06150RLLU	0.060	1.500	3	1.169	1.250	12.000	2.000	10.000	20°	With	WPM*06...	Cylindrical
EXP09200RU	0.118	2.000	2	1.477	1.250	4.781	2.500	2.281	20°	With	WPMT09...	Cylindrical
EXP09200RLU	0.118	2.000	2	1.477	1.250	9.750	2.000	7.750	20°	With	WPMT09...	Cylindrical

SPARE PARTS



Designation	Clamp set	Clamping screw	Lubricant	Wrench 1	Wrench 2
EXP05...	-	CSPB-3.5S	M-1000	IP-15D	-
EXP06...	CSY-15	CSPB-4S	M-1000	IP-15D	-
EXP09...	CSY-20	CSPB-5	M-1000	-	IP-20T

*Recommended clamping torque : CSPB-3.5S/CSPB-4S = 2.58 lbs·ft, CSTB-5 = 3.69 lbs·ft

Reference pages: Inserts → **H053**, Standard cutting conditions → **H054 - H055**

INSERT

WPMW05/06

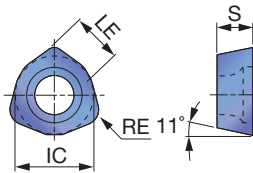

WPMT08/09

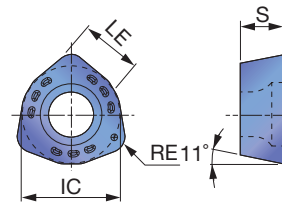

WPMT05/06/08/09-ML

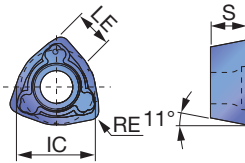

WPMT05/06/08/09-MH

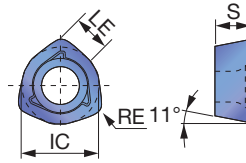

WPMT05/06/08/09-DML

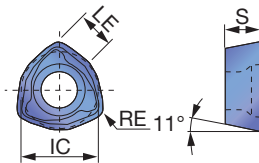

P	Steel	☆				☆	★		
M	Stainless		★	☆			★		
K	Cast iron	★							
N	Non-ferrous								
S	Superalloys	★	☆						
H	Hard materials				★				

★ : First choice
☆ : Second choice

Designation	RE	APMX	Coated						LE	IC	S
			AH120	AH130	AH140	AH730	T3130	AH3135			
WPMW05H315ZPR	0.059	0.060	●	●	●	●	●	0.197	0.3130	0.138	
WPMT05H315ZPR-ML	0.059	0.060	●	●	●	●	●	0.197	0.3130	0.138	
WPMT05H315ZPR-MH	0.059	0.060	●	●	●	●	●	0.197	0.3134	0.138	
WPMT05H315ZPR-DML	0.059	0.060				●		0.197	0.3130	0.138	
WPMW06X415ZPR	0.059	0.060	●	●	●	●	●	0.236	0.3750	0.165	
WPMT06X415ZPR-ML	0.059	0.060	●	●	●	●	●	0.236	0.3750	0.165	
WPMT06X415ZPR-MH	0.059	0.060	●	●	●	●	●	0.236	0.3755	0.165	
WPMT06X415ZPR-DML	0.059	0.060				●		0.236	0.3750	0.165	
WPMT080615ZSR	0.059	0.060	●	●	●	●	●	0.315	0.507	0.250	
WPMT080615ZPR-ML	0.059	0.060	●	●	●	●	●	0.315	0.507	0.250	
WPMT080615ZSR-MH	0.059	0.060	●	●	●	●	●	0.315	0.507	0.250	
WPMT080615ZPR-DML	0.059	0.060				●		0.315	0.507	0.250	
WPMT090725ZSR	0.098	0.118	●	●	●	●	●	0.354	0.591	0.276	
WPMT090725ZPR-ML	0.098	0.118	●	●	●	●	●	0.354	0.591	0.276	
WPMT090725ZSR-MH	0.098	0.118	●	●	●	●	●	0.354	0.591	0.276	
WPMT090725ZPR-DML	0.098	0.118				●		0.354	0.591	0.276	

● : Line up

STANDARD CUTTING CONDITIONS

05-06 type

ISO	Workpiece material	Grade	Cutting speed Vc (sfm)	Feed per tooth fz (ipt)	ø0.787", 0.827" (CICT = 2)	ø0.984", 1.024" (CICT = 2)	ø1.260", 1.299" (CICT = 2, 3)	ø1.575" (CICT = 3)	ø1.969" (CICT = 4)	ø2.480" (CICT = 5, 6)
P	Carbon Steels 1055, etc. < 300HB	AH3135	330 ~ 820	0.020 ~ 0.078	Vc = 500 sfm, fz = 0.031 ipt ap = 0.039", ae = 0.039DCX"	Vc = 500 sfm, fz = 0.039 ipt ap = 0.039", ae = 0.039DCX"				
	When plunging in small depth: fz = 0.008"									
	Alloy steels 4140, etc. < 300 HB	AH3135	330 ~ 650	0.020 ~ 0.078	Vc = 425 sfm, fz = 0.031 ipt ap = 0.039", ae = 0.039 DCX"	Vc = 425 sfm, fz = 0.039 ipt ap = 0.039", ae = 0.039 DCX"				
When plunging in small depth: fz = 0.008"										
M	Prehardened steels P20, H13, etc. 30 ~ 40HRC	AH3135	260 ~ 500	0.020 ~ 0.039	Vc = 330 sfm, fz = 0.020 ipt ap = 0.039", ae = 0.039 DCX"	Vc = 330 sfm, fz = 0.020 ipt ap = 0.039", ae = 0.039 DCX"				
	When plunging in small depth: fz = 0.004 ipt									
K	Stainless steels S30400, etc.	AH130 (AH3135)	330 ~ 650	0.020 ~ 0.078	Vc = 425 sfm, fz = 0.031 ipt ap = 0.039", ae = 0.039 DCX"	Vc = 425 sfm, fz = 0.039 ipt ap = 0.039", ae = 0.039 DCX"				
When plunging in small depth: fz = 0.008 ipt										
K	Cast irons 250, etc.	AH120	330 ~ 820	0.032 ~ 0.098	Vc = 500 sfm, fz = 0.039 ipt ap = 0.039", ae = 0.039 DCX"	Vc = 590 sfm, fz = 0.059 ipt ap = 0.039", ae = 0.039 DCX"				
When plunging in small depth: fz = 0.008 ipt										
S	Titanium alloys Ti-6Al-4V, etc.	AH130	98 ~ 197	0.012 ~ 0.028	Vc = 164 sfm, fz = 0.020 ipt, ap = 0.028", ae = 0.020 DCX"					
	When plunging in small depth: fz = 0.004 ipt									
S	Heat-resistant alloys Inconel 718, etc.	AH120	33 ~ 131	0.004 ~ 0.012	Vc = 98 sfm, fz = 0.008 ipt, ap = 0.028", ae = 0.020 DCX"					
	When plunging in small depth: fz = 0.004 ipt									
H	Hard materials D2, etc. 40 ~ 50HRC	AH730	200 ~ 330	0.020 ~ 0.078	Vc = 230 sfm, fz = 0.028 ipt, ap = 0.028", ae = 0.039 DCX"					
When plunging in small depth: fz = 0.004 ipt										

08 type

ISO	Workpiece material	Grade	Cutting speed Vc (sfm)	Feed per tooth fz (ipt)	ø1.575" (CICT = 2)	ø1.969" (CICT = 3)	ø2.480" (CICT = 4)	ø3.150" (CICT = 5)	ø3.937" (CICT = 6)	ø4.921" (CICT = 7)	ø6.299" (CICT = 8)
P	Carbon Steels 1055, etc. < 300HB	AH3135	330 ~ 820	0.020 ~ 0.078	Vc = 591 sfm, fz = 0.039 ipt ap = 0.039", ae = 1.575"	Vc = 656 sfm, fz = 0.059 ipt ap = 0.039", ae = 0.039 DCX"					
	When plunging in small depth: fz = 0.008 ipt										
	Alloy steels 4140, etc. < 300 HB	AH3135	330 ~ 650	0.020 ~ 0.078	Vc = 427 sfm, fz = 0.039 ipt ap = 0.039", ae = 1.575"	Vc = 492 sfm, fz = 0.059 ipt ap = 0.039", ae = 0.039 DCX"					
When plunging in small depth: fz = 0.008 ipt											
M	Prehardened steels P20, H13, etc. 30 ~ 40HRC	AH3135	260 ~ 500	0.020 ~ 0.039	Vc = 328 sfm, fz = 0.020 ipt ap = 0.039", ae = 1.575"	Vc = 394 sfm, fz = 0.031 ipt ap = 0.039", ae = 0.039 DCX"					
	When plunging in small depth: fz = 0.004 ipt										
M	Stainless steels S30400, etc.	AH130 (AH3135)	330 ~ 650	0.020 ~ 0.078	Vc = 427 sfm, fz = 0.039 ipt ap = 0.039", ae = 1.575"	Vc = 492 sfm, fz = 0.059 ipt ap = 0.039", ae = 0.039 DCX"					
When plunging in small depth: fz = 0.008 ipt											
K	Cast irons 250, etc.	AH120	500 ~ 820	0.032 ~ 0.098	Vc = 591 sfm, fz = 0.059 ipt ap = 0.039", ae = 1.575"	Vc = 656 sfm, fz = 0.079 ipt ap = 0.039", ae = 0.039 DCX"					
When plunging in small depth: fz = 0.008 ipt											
S	Titanium alloys Ti-6Al-4V, etc.	AH130	98 ~ 197	0.012 ~ 0.028	Vc = 164 sfm, fz = 0.020 ipt, ap = 0.028", ae = 0.020 DCX"						
	When plunging in small depth: fz = 0.004 ipt										
S	Heat-resistant alloys Inconel 718, etc.	AH120	33 ~ 131	0.004 ~ 0.012	Vc = 98 sfm, fz = 0.008 ipt, ap = 0.028", ae = 0.020 DCX"						
	When plunging in small depth: fz = 0.004 ipt										
H	Hard materials D2, etc. 40 ~ 50HRC	AH730	170 ~ 260	0.020 ~ 0.039	Vc = 230 sfm, fz = 0.028 ipt, ap = 0.028", ae = 0.039 DCX"						
When plunging in small depth: fz = 0.004 ipt											

The above values of cutting speed show the standard speed when overhang length of tool is below 3D.
The cutting speed and the feed rate should be set at the lower limit values when overhang length of tool exceeds 3D.
Thick and heavy chips are discharged by these TAC mills. Use internal air supply or air-blowing in order to prevent tool failure.

STANDARD CUTTING CONDITIONS

09 type

ISO	Workpiece material	Grade	Cutting speed Vc (sfm)	Feed per tooth fz (ipt)	ø2.000" (CICT = 2)	ø2.500" (CICT = 3)	ø3.000" (CICT = 4)	ø4.000" (CICT = 5)	ø5.000" (CICT = 6)	ø6.000" (CICT = 7)
P	Carbon Steels 1055, etc. < 300HB	AH3135	330 ~ 820	0.020 ~ 0.078	Vc = 650 sfm, fz = 0.059 ipt, ap = 0.079", ae = 0.039 DCX"					
					When plunging in small depth: fz = 0.008 ipt					
	Alloy steels 4140, etc. < 300 HB	AH3135	330 ~ 650	0.020 ~ 0.078	Vc = 500 sfm, fz = 0.059 ipt, ap = 0.079", ae = 0.039 DCX"					
When plunging in small depth: fz = 0.008 ipt										
M	Prehardened steels P20, H13, etc. 30 ~ 40HRC	AH3135	260 ~ 500	0.020 ~ 0.039	Vc = 3.94, fz = 0.031 ipt, ap = 0.079", ae = 0.039 DCX"					
					When plunging in small depth: fz = 0.004 ipt					
K	Stainless steels S30400, etc.	AH130 (AH3135)	330 ~ 650	0.020 ~ 0.078	Vc = 500 sfm, fz = 0.059 ipt, ap = 0.079", ae = 0.039 DCX"					
					When plunging in small depth: fz = 0.008 ipt					
S	Cast irons 250, etc.	AH120	500 ~ 820	0.032 ~ 0.098	Vc = 650 sfm, fz = 0.078 ipt, ap = 0.079", ae = 0.039 DCX"					
					When plunging in small depth: fz = 0.008 ipt					
H	Titanium alloys Ti-6Al-4V, etc.	AH130	98 ~ 197	0.012 ~ 0.028	Vc = 164 sfm, fz = 0.020 ipt, ap = 0.059", ae = 0.020 DCX"					
					When plunging in small depth: fz = 0.039 ipt					
H	Heat-resistant alloys Inconel 718, etc.	AH120	33 ~ 131	0.004 ~ 0.012	Vc = 98 sfm, fz = 0.008 ipt, ap = 0.039", ae = 0.020 DCX"					
					When plunging in small depth: fz = 0.039 ipt					
H	Hard materials D2, etc. 40 ~ 50HRC	AH730	200 ~ 330	0.020 ~ 0.039	Vc = 230 sfm, fz = 0.028 ipt, ap = 0.027", ae = 0.039 DCX"					
					When plunging in small depth: fz = 0.004 ipt					

The cutting speed and feed should be set to 70 to 80 % of the value shown in the above table when overhang length of tool exceeds 3D.

Grade
Insert
Toolholder
Ext. Toolholder
Int. Toolholder
Threading
Grooving
Miniature Tool
Milling Cutter
Endmill
Drilling Tool
Tooling System
Index



APPLICATION RANGE

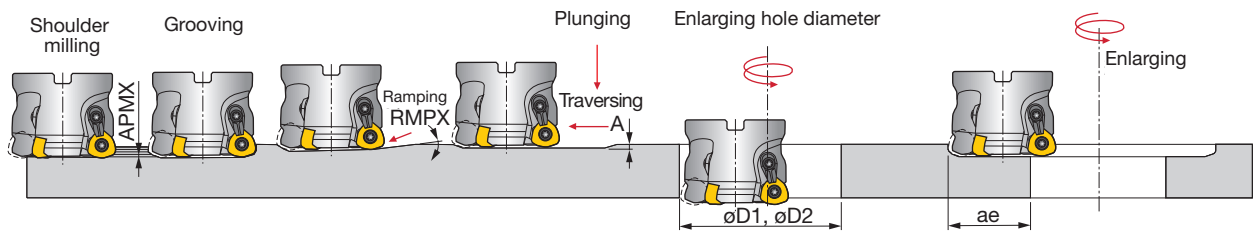

		Max. depth of cut	Max. ramping angle	Max. plunging depth	Min. machining hole dia.	Max. machining hole dia.	Max. cutting width in enlarging hole
Inch	DCX	APMX	RMPX	A	øD1	øD2	ae
TXP05250RBU	2.500	0.060	2° 30'	0.020	3.860	4.840	2.240
TXP05300RBU	3.000	0.060	1° 30'	0.020	5.200	6.180	2.910
TXP06250RBU	2.500	0.060	2°	0.040	3.860	4.840	2.240
TXP06200RBU	2.000	0.060	1° 30'	0.040	3.270	3.820	1.770
TXP06300RBU	3.000	0.060	1° 30'	0.040	5.200	6.180	2.910
TXP08050RU	2.000	0.060	4°	0.040	2.830	3.820	1.730
TXP08300RU-A	3.000	0.060	1° 30'	0.040	5.200	6.180	2.910
TXP08400RU-A	4.000	0.060	1°	0.040	6.770	7.760	3.700
TXP09250RU	2.500	0.118	2°	0.060	3.860	4.840	2.200
TXP09300RU	3.000	0.118	1° 30'	0.060	5.200	6.180	2.870
TXP09400RU	4.000	0.118	1°	0.060	6.770	7.760	3.660
TXP09500RU	5.000	0.118	0° 45'	0.060	8.740	9.720	4.650
TXP09600RU	6.000	0.118	0° 30'	0.060	11.500	12.480	6.020
EXP05075...	0.750	0.060	3°	0.020	1.181	1.457	0.630
EXP06100...	1.000	0.060	5°	0.039	1.299	1.850	0.787
EXP06125...	1.250	0.060	3° 30'	0.039	1.850	2.402	1.063
EXP06150...	1.500	0.060	2°	0.039	2.480	2.874	1.299

TOOL GEOMETRY FOR PROGRAMMING

When programming for CAD/CAM, the tool should be assumed to be a radius cutter shown in the table below. In this case, the amount left as uncut (t) is shown below.

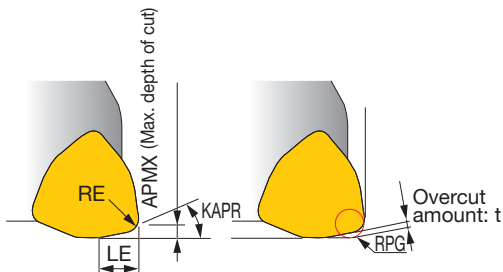

TXP	Max. depth of cut APMX	Corner of insert RE	Cutting edge angle KAPR	Corner R when programming LE	t	RPG
05	0.060	0.059	20°	0.150	0.020	R.078
06	0.060	0.059	20°	0.169	0.028	R.078
08	0.060	0.059	20°	0.224	0.028	R.078
09	0.118	0.098	20°	0.268	0.055	R.118
09	0.118	0.098	20°	0.268	0.047	R.157

Approach angle

10-20°

45°

70°

85°

88°

90°

Others

MEMO

Grade	A
Insert	B
Ext. Toolholder	C
Int. Toolholder	D
Threading	E
Grooving	F
Miniature Tool	G
Milling Cutter	H
Endmill	I
Drilling Tool	J
Tooling System	K
User's Guide	L
Index	M



Brings a top performance in every operation: from high feed milling, scale removing, finish milling ... to stainless steel milling

Versatility

3 types of double sided inserts fit in the same pocket

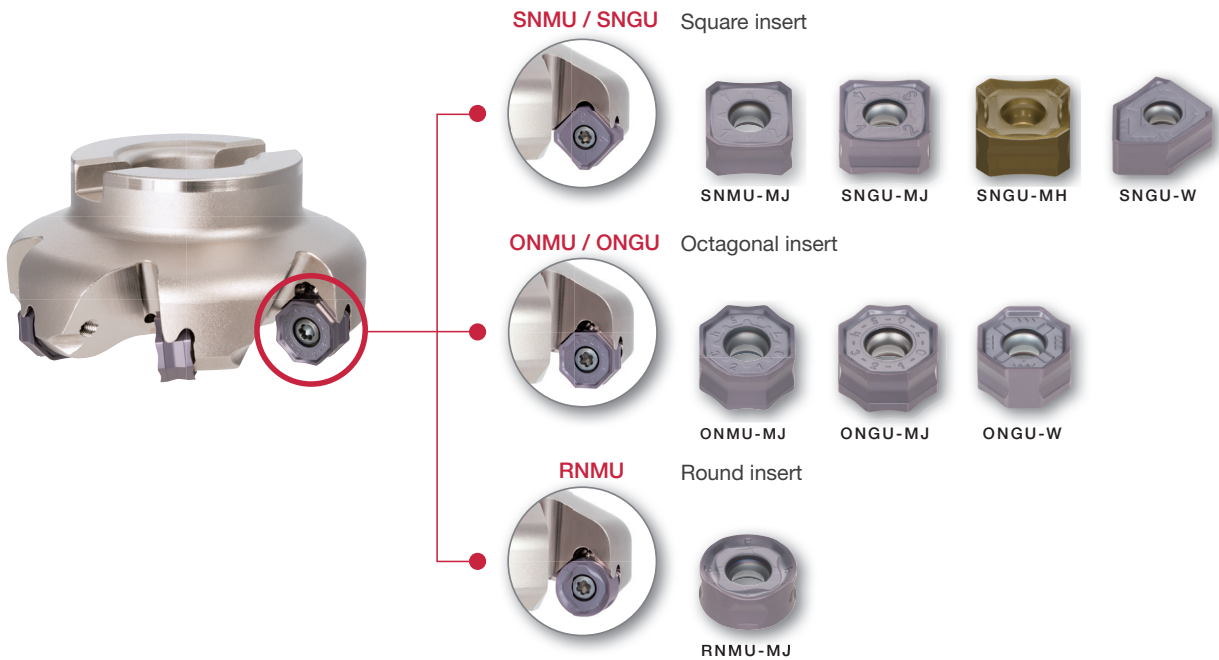

High efficiency with close pitch cutter
Extra-close pitch type available in addition to regular close pitch type
Tool line-up includes extra close pitch cutter maximizing efficiency in cast iron machining.



Standard pitch



Close pitch

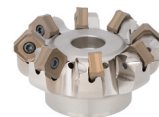

Extra-close pitch

Reference pages: **H060 - H062**



Super high density PCD cutter for efficient finishing of aluminum

Super high density cutter



Super high density design
High speed cutting more than $V_c = 9843$ sfm is possible.

CamAdjust - super simple adjusting mechanism

Clamping insert

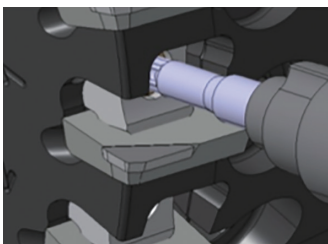

Adjusting axial runout

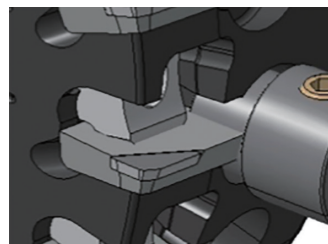

The same key is used for mounting and adjusting the inserts.
The key wrench is operated in a single direction making insert adjustment easy on the pre-setter.

Reference pages: **H079 - H080**

Cutter diameter (in)	Max num. of teeth	Max. rotation number (rpm)	Cutter weight (lb)
2	8	20,000	1.92
2.5	10	19,000	1.34
3	16	17,000	2.56
4	22	15,000	4.30
5	26	14,000	8.03
6	34	12,000	10.76

Special key wrench with adjusting cam

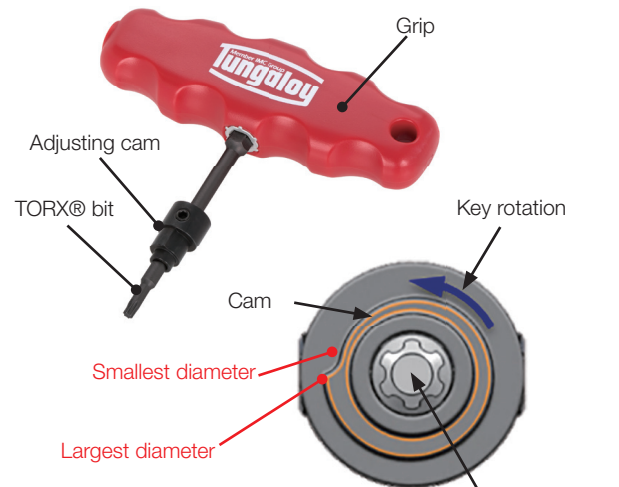

Insert's axial runout is adjusted with the eccentric cam profile.



45° face mill, with screw clamp system, for double sided square, octagonal and round inserts

GAMP=+6.0°, GAMF=-6.8°~-6.3°

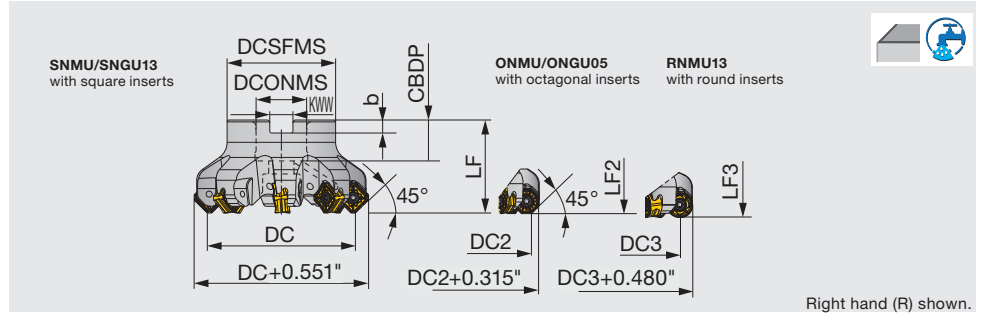

Inch	DC	DC2	DC3	CICT	DCSFMS	LF	LF2	LF3	DCONMS	CDBP	KWW	b	WT (lb)	Air hole	Arbor type
TASN13U2.00B0.75R05	2.000	2.118	1.982	5	1.850	1.575	1.516	1.517	0.750	0.750	0.315	0.197	0.900	With	A
TASN13U2.50B0.75R06	2.500	2.618	2.482	6	1.850	1.575	1.516	1.517	0.750	0.750	0.315	0.197	1.320	With	A
TASN13U2.50B0.75R08	2.500	2.618	2.482	8	1.850	1.575	1.516	1.517	0.750	0.750	0.315	0.197	1.540	With	A
TASN13U3.00B1.00R08	3.000	3.118	2.982	8	1.969	1.969	1.909	1.911	1.000	1.024	0.374	0.236	1.980	With	A
TASN13U3.00B1.00R10	3.000	3.118	2.982	10	1.969	1.969	1.909	1.911	1.000	1.024	0.374	0.236	2.200	With	A
TASN13U4.00B1.50R08	4.000	4.118	3.982	8	3.150	1.969	1.909	1.911	1.500	1.276	0.626	0.394	3.750	Without	B
TASN13U4.00B1.50R12	4.000	4.118	3.982	12	3.150	1.969	1.909	1.911	1.500	1.276	0.626	0.394	3.750	Without	B
TASN13U5.00B1.50R10	5.000	5.118	4.982	10	3.150	2.480	2.421	2.422	1.500	1.378	0.626	0.394	5.950	Without	B
TASN13U5.00B1.50R14	5.000	5.118	4.982	14	3.150	2.480	2.421	2.422	1.500	1.378	0.626	0.394	6.720	Without	B
TASN13U6.00B2.00R12	6.000	6.118	5.982	12	3.937	2.480	2.421	2.422	2.000	1.496	0.748	0.433	8.600	Without	B

SPARE PARTS

Designation	Clamping screw	Grip	Lubricant	Shell locking bolt (Optional parts)	Torx bit
TASN13... (DC ≤ 3.000")	CSPB-4	H-TB2W	M-1000	(C0.375X1.125H)	BLDIP15/S7
TASN13... (DC = 3.000")	CSPB-4	H-TB2W	M-1000	(C0.500X1.375H)	BLDIP15/S7
TASN13... (DC = 4.000")	CSPB-4	H-TB2W	M-1000	(TMBA-0.750H)	BLDIP15/S7
TASN13... (DC = 5.000")	CSPB-4	H-TB2W	M-1000	(TMBA-0.750H)	BLDIP15/M7
TASN13... (DC = 6.000")	CSPB-4	H-TB2W	M-1000	-	BLDIP15/M7

*Recommended clamping torque : CSPB-4 = 2.58 lbs·ft

Arbor type

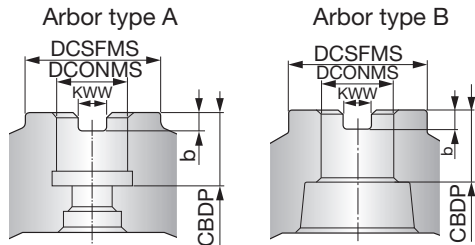

Reference pages: Inserts → **H061**, Standard cutting conditions → **H062**

INSERT

SNMU-MJ

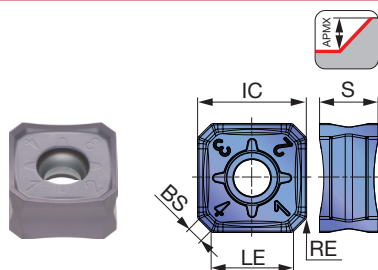

SNGU-MJ

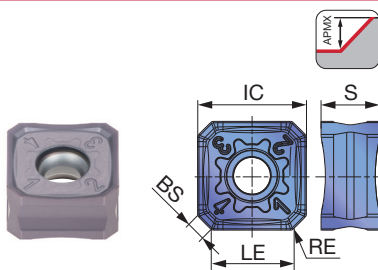

SNGU-MH

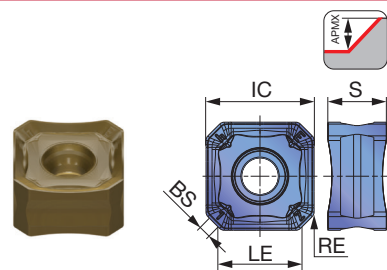

SNGU-W

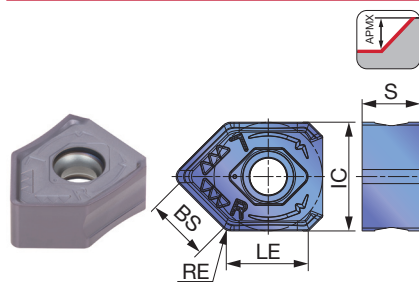

ONMU-MJ

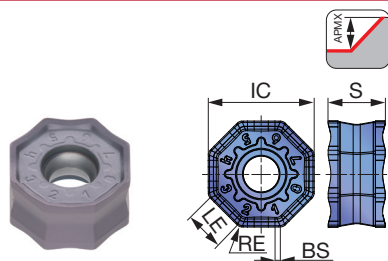

ONGU-MJ

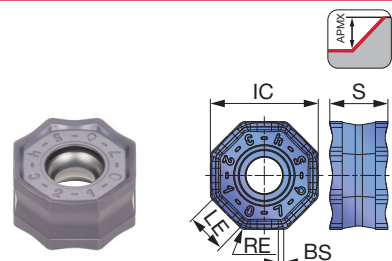

ONGU-W

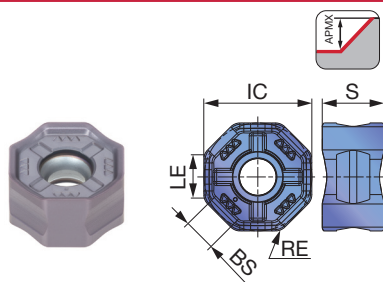

RNMU-MJ

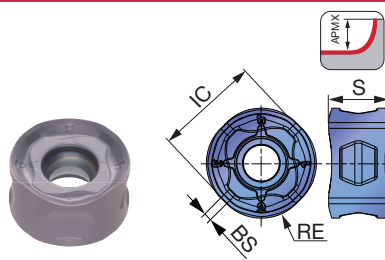

P	Steel	☆	★	★					
M	Stainless		★	★					
K	Cast iron	★			★				
N	Non-ferrous								
S	Superalloys	★	☆						
H	Hard materials	☆	☆						

★ : First choice
☆ : Second choice

Designation	RE	APMX	Coated				LE	IC	S	BS
			AH120	AH3135	T3225	T1215				
SNMU1307ANEN-MJ	0.020	0.236	●	●	●	●	0.370	0.512	0.276	0.079
SNGU1307ANEN-MJ	0.020	0.236	●	●	●	●	0.370	0.512	0.276	0.079
SNGU1307ANEN-MH	0.031	0.236			●		0.354	0.512	0.276	0.079
SNGU1307ANEN-W	0.047	0.236	●	●			0.378	0.512	0.276	0.295
ONMU0507ANEN-MJ	0.031	0.134	●	●	●	●	0.193	0.512	0.276	0.028
ONGU0507ANEN-MJ	0.031	0.134	●	●	●	●	0.193	0.512	0.276	0.028
ONGU0507ANEN-W	0.063	0.134	●	●			0.197	0.512	0.293	0.154
RNMU1307ZNER-MJ	0.236	0.236	●	●	●	●	-	0.512	0.280	0.039

● : Line up

Grade
Insert
Toolholder
Ext. Toolholder
Int. Toolholder
Threading
Grooving
Miniature Tool
Milling Cutter
Endmill
Drilling Tool
Tooling System
User's Guide
Index



STANDARD CUTTING CONDITIONS

SNMU / SNGU / ONMU / ONGU

ISO	Workpiece materials	Hardness	Priority	Grades	Chip-breaker	Cutting speed Vc (sfm)	Feed per tooth fz (ipt)	
P	Low carbon steel 1015, 1020, etc.	200 - 300HB	First choice	AH3135	MJ	330 - 820	0.004 - 0.020	
			Wear resistance	T3225	MJ	660 - 1150	0.004 - 0.016	
	High carbon and alloy steel 1055, 4140, etc.	150 - 300HB	First choice	AH3135	MJ	330 - 820	0.004 - 0.016	
			Wear resistance	T3225	MJ	590 - 980	0.004 - 0.016	
M	Prehardened steel NAK80, PX5, etc.	30 - 40HRC	First choice	AH3135	MJ	330 - 660	0.004 - 0.016	
			Wear resistance	T3225	MJ	490 - 820	0.004 - 0.016	
M	Stainless steel 304SS, 316SS, etc.	- 200HB	First choice	AH3135	MJ	330 - 660	0.004 - 0.014	
			Wear resistance	T3225	MJ	330 - 820	0.004 - 0.012	
	Stainless cast steel 1.4849, etc.	-	First choice	T3225	MH	200 - 390	0.004 - 0.012	
Low cutting force			AH3135	MJ	200 - 390	0.004 - 0.012		
K	Gray cast iron Class 25, Class 30, etc.	150 - 250 HB	First choice	T1215	MJ	330 - 980	0.004 - 0.016	
				AH120	MJ	330 - 820	0.004 - 0.020	
	Ductile cast iron 60-40-18, 80-55-06, etc.	150 - 250 HB	First choice	T1215	MJ	330 - 980	0.004 - 0.016	
				AH120	MJ	260 - 660	0.004 - 0.020	
S	Titanium alloys Ti-6Al-4V, etc.	- 40HRC	First choice	AH3135	MJ	100 - 200	0.004 - 0.012	
	Heat-resistant alloys Inconel718, etc.	- 40HRC	First choice	AH120	MJ	30 - 130	0.002 - 0.006	
H	Hardened steel	H13, etc.	40 - 50 HRC	First choice	AH3135	MJ	260 - 430	0.004 - 0.008
		D2, etc.	50 - 60 HRC	First choice	AH120	MJ	160 - 230	0.001 - 0.004

RNMU

ISO	Workpiece materials	Hardness	Priority	Grades	Chip-breaker	Cutting speed Vc (sfm)	Feed per tooth fz (ipt)	
P	Low carbon steel 1015, 1020, etc.	200 - 300 HB	First choice	AH3135	MJ	330 - 820	*ap = 0.236": 0.004 - 0.012 *ap = 0.078": 0.016 - 0.031 *ap = 0.039": 0.031 - 0.059	
			Wear resistance	T3225	MJ	660 - 1150		
	High carbon and alloy steel 1055, 4140, etc.	150 - 300 HB	First choice	AH3135	MJ	330 - 820		
			Wear resistance	T3225	MJ	590 - 980		
M	Prehardened steel NAK80, PX5, etc.	30 - 40 HRC	First choice	AH3135	MJ	330 - 660	*ap = 0.236": 0.004 - 0.010 *ap = 0.078": 0.012 - 0.027 *ap = 0.039": 0.024 - 0.051	
			Wear resistance	T3225	MJ	490 - 820		
M	Stainless steel 304SS, 316SS, etc.	- 200 HB	First choice	AH3135	MJ	330 - 660		
			Wear resistance	T3225	MJ	330 - 820		
M	Stainless cast steel 1.4849, etc.	-	First choice	T3225	MJ	200 - 390	*ap = 0.078": 0.008 - 0.016 *ap = 0.039": 0.012 - 0.031	
			Fracture resistance	AH3135	MJ	200 - 390		
K	Gray cast iron Class 25, Class 30, etc.	150 - 250 HB	First choice	AH120	MJ	330 - 980	*ap = 0.236": 0.004 - 0.012 *ap = 0.078": 0.016 - 0.031 *ap = 0.039": 0.031 - 0.059	
				T1215	MJ	330 - 820		
	Ductile cast iron 60-40-18, 80-55-06, etc.	150 - 250 HB	First choice	AH120	MJ	330 - 980		
T1215				MJ	260 - 660			
S	Titanium alloys Ti-6Al-4V, etc.	- 40 HRC	First choice	AH3135	MJ	100 - 200	ap = 0.039": 0.006 - 0.031	
	Heat-resistant alloys Inconel718, etc.	- 40 HRC	First choice	AH120	MJ	30 - 130	ap = 0.039": 0.002 - 0.012	
H	Hardened steel	H13, etc.	40 - 50 HRC	First choice	AH3135	MJ	260 - 430	ap = 0.039": 0.004 - 0.010
		D2, etc.	50 - 60 HRC	First choice	AH120	MJ	160 - 230	ap = 0.020": 0.001 - 0.004

*When using T3225 or T1215, decrease the feed per tooth (fz) to 80% of the abovementioned value.

TAN07

45° face mill, with screw clamp system, for double sided square and octagonal inserts, or single sided octagonal inserts

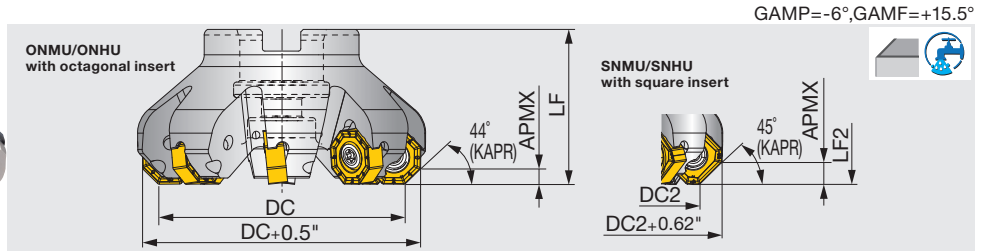

Inch	DC	DC2	CICT	DCSFMS	LF	LF2	DCONMS	CBDP	KWW	b	WT (lb)	Air hole	Insert	Arbor type
TAN07R250U0075A05	2.500	2.394	5	1.750	1.750	1.805	0.750	0.750	0.313	0.188	1.000	With	SN*U/ON*U/OWMT...	A
TAN07R250U0075A06	2.500	2.394	6	1.750	1.750	1.805	0.750	0.750	0.313	0.188	1.000	With	SN*U/ON*U/OWMT...	A
TAN07R300U0100A06	3.000	2.894	6	2.000	2.000	2.055	1.000	0.750	0.375	0.219	2.000	With	SN*U/ON*U/OWMT...	A
TAN07R300U0100A08	3.000	2.894	8	2.000	2.000	2.055	1.000	0.750	0.375	0.219	2.000	With	SN*U/ON*U/OWMT...	A
TAN07R400U0150A07	4.000	3.894	7	2.400	2.000	2.055	1.500	1.000	0.625	0.375	3.000	With	SN*U/ON*U/OWMT...	B
TAN07R400U0150A10	4.000	3.894	10	2.400	2.000	2.055	1.500	1.000	0.625	0.375	3.000	With	SN*U/ON*U/OWMT...	B
TAN07R500U0150A08	5.000	4.894	8	2.400	2.500	2.555	1.500	1.000	0.625	0.375	5.000	With	SN*U/ON*U/OWMT...	B
TAN07R500U0150A12	5.000	4.894	12	2.400	2.500	2.555	1.500	1.000	0.625	0.375	5.000	With	SN*U/ON*U/OWMT...	B
TAN07R600U0200A10	6.000	5.894	10	4.000	2.500	2.555	2.000	1.000	0.750	0.438	7.000	Without	SN*U/ON*U/OWMT...	B
TAN07R600U0200A15	6.000	5.894	15	4.000	2.500	2.555	2.000	1.000	0.750	0.438	7.000	Without	SN*U/ON*U/OWMT...	B
TAN07R800U0250A12	8.000	7.894	12	5.300	2.500	2.555	2.500	1.400	1.000	0.531	13.000	Without	SN*U/ON*U/OWMT...	C
TAN07R800U0250A18	8.000	7.894	18	5.300	2.500	2.555	2.500	1.400	1.000	0.531	13.000	Without	SN*U/ON*U/OWMT...	C

Dimension when using positive type inserts (OWMT)

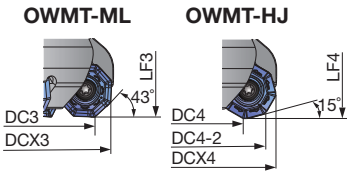

Inch	OWMT-ML			OWMT-HJ			
	DC3	DCX3	LF3	DC4	DC4-2	DCX4	LF4
TAN07R250U0075A...	2.520	2.213	1.789	3.000	2.665	3.028	1.805
TAN07R300U0100A...	3.020	2.713	2.039	3.500	3.165	3.528	2.055
TAN07R400U0150A...	4.020	3.713	2.039	4.500	4.165	4.528	2.055
TAN07R500U0150A...	5.020	4.713	2.539	5.500	5.165	5.528	2.555
TAN07R600U0200A...	6.020	5.713	2.539	6.500	6.165	6.528	2.555
TAN07R800U0250A...	8.020	7.713	2.539	8.500	8.165	8.528	2.555

OWMT08 inserts can be only used with screw on type cutters.

Arbor type

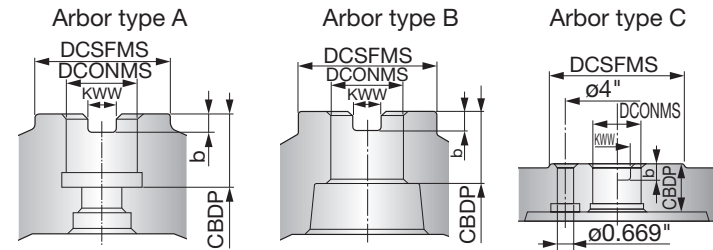

SPARE PARTS

Designation	Clamping screw	Grip	Torx bit	Shell locking bolt (Optional parts)
TAN07R250...	SRM5X0.8IP20X+ACROLYTE	H-TB	BLDIP20/S7	(C0.375X1.125H)
TAN07R300...	SRM5X0.8IP20X+ACROLYTE	H-TB	BLDIP20/S7	(C0.500X1.375H)
TAN07R400, 500...	SRM5X0.8IP20X+ACROLYTE	H-TB	BLDIP20/S7	(TMBA-0.750H)
TAN07R600, 800...	SRM5X0.8IP20X+ACROLYTE	H-TB	BLDIP20/S7	-

*Recommended clamping torque : SRM5X0.8IP20X+ACROLYTE = 5.53 lbs·ft

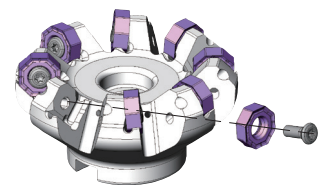

High density 45° face mill, with wedge clamp system, for double sided square and octagonal inserts

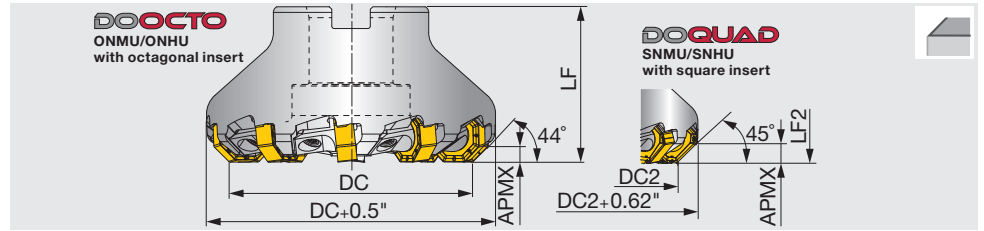

Inch	DC	DC2	CICT	DCSFMS	LF	LF2	DCONMS	CBDP	KWW	b	WT (lb)	Air hole	Insert	Arbor type
TAN07R250U0075A08W	2.500	2.394	8	1.750	1.750	1.805	0.750	0.750	0.313	0.188	1.60	Without	SN*U/ON*U/OWMT...	B
TAN07R300U0100A10W	3.000	2.894	10	2.000	2.000	2.055	1.000	0.750	0.375	0.219	2.00	With	SN*U/ON*U/OWMT...	B
TAN07R400U0150A14W	4.000	3.894	14	2.400	2.000	2.055	1.500	1.000	0.625	0.375	2.80	Without	SN*U/ON*U/OWMT...	B
TAN07R500U0150A18W	5.000	4.894	18	2.400	2.500	2.555	1.500	1.000	0.625	0.375	4.30	With	SN*U/ON*U/OWMT...	B
TAN07R600U0200A22W	6.000	5.894	22	4.000	2.500	2.555	2.000	1.000	0.750	0.438	6.80	Without	SN*U/ON*U/OWMT...	B
TAN07R800U0250A28W	8.000	7.894	28	5.300	2.500	2.555	2.500	1.400	1.000	0.531	13.50	With	SN*U/ON*U/OWMT...	C

Note: OWMT insert cannot be used with a wedge clamp type cutter.

Arbor type

Arbor type B

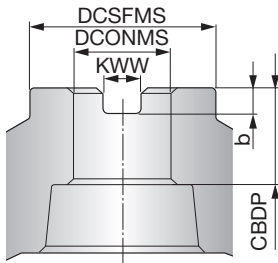

Arbor type C

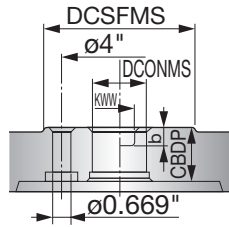

SPARE PARTS

Designation	Grip	Torx bit	Wedge	Clamping screw	Shell locking bolt (Optional parts)
TAN07R250U**W	H-TBS	BLDIP15/S7	CL ARM-10-TUNG1	DS-6P	(C0.375X1.125H)
TAN07R300U**W	H-TBS	BLDIP15/S7	CL ARM-10-TUNG1	DS-6P	(C0.500X1.375H)
TAN07R400U**W, TAN07R500U**W	H-TBS	BLDIP15/S7	CL ARM-10-TUNG1	DS-6P	(TMBA-0.750H)
TAN07R600U**W, TAN07R800U**W	H-TBS	BLDIP15/S7	CL ARM-10-TUNG1	DS-6P	-

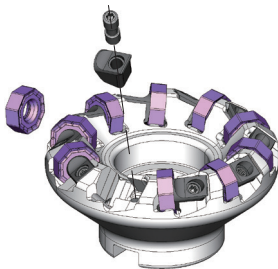

Reference pages: Inserts → **H065**, Standard cutting conditions → **H066**

INSERT

ONMU/ONHU0705-MJ / -ML

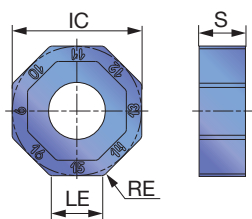

ONHU0705-W

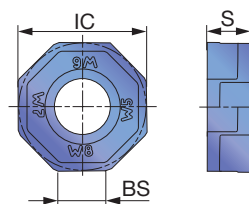

SNMU/SNHU1706 -MJ / -ML

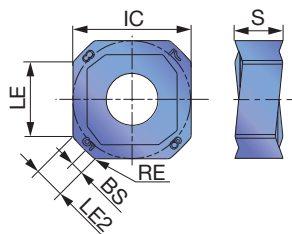

SNHU1706-W

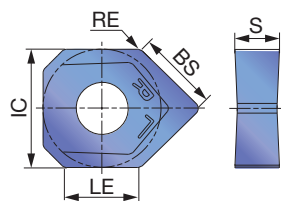

OWMT0807-ML

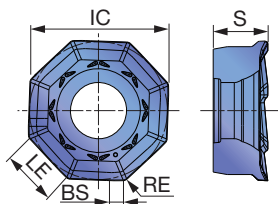

OWMT0807-HJ

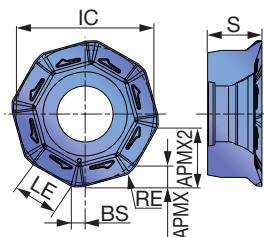

P Steel			☆	★	★			★
M Stainless		☆		★				★
K Cast iron	★		☆				★	
N Non-ferrous								
S Superalloys		☆		☆				
H Hard materials				☆				

★ : First choice
☆ : Second choice

Designation	RE	APMX	Coated							LE	S	LE2	IC	BS	APMX2			
			AH120	AH130	AH140	AH725	AH3135	T1115	T1215							T3225		
ONMU0705ANPN-MJ	0.031	0.187			●	●	●	●	●				0.283	0.244	-	0.681	-	-
ONHU0705ANPN-MJ	0.031	0.187			●	●							0.283	0.244	-	0.681	-	-
ONMU0705ANPN-ML	0.031	0.187	●				●						0.283	0.244	-	0.681	-	-
ONHU0705ANTN-ML	0.031	0.187	●		●	●							0.283	0.244	-	0.681	-	-
ONHU0705ANPR-W *	-	0.187	●										0.283	0.228	-	0.689	0.252	-
OWMT0807ZNER-HJ	0.031	0.059					●						-	0.291	-	0.748	0.039	0.295
OWMT0807AAER-ML	0.047	0.138		●			●						0.205	0.291	-	-	0.047	-
SNMU1706ANPR-MJ	0.031	0.295			●	●	●			●	●		0.433	0.275	0.173	0.681	0.709	-
SNHU1706ANPR-MJ	0.031	0.295			●	●							0.433	0.275	0.173	0.681	0.709	-
SNMU1706ANTR-ML	0.031	0.295	●				●						0.433	0.275	0.173	0.681	0.709	-
SNHU1706ANTR-ML	0.031	0.295	●										0.433	0.275	0.173	0.681	0.709	-
SNHU1706ANFN-W *	0.016	0.295	●										0.681	0.256	-	0.681	0.433	-

* Pay attention to the wiper insert installation procedure below.

● : Line up

Attention for wiper inserts

ONHU0705ANPR-W

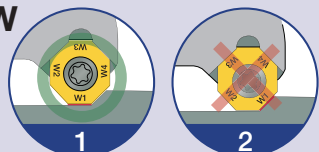

Attach only one wiper insert on the cutter and make sure the wiper edge faces the machining surface.
Feed rate: $f < 0.217$ ipr

SNHU1706ANFN-W

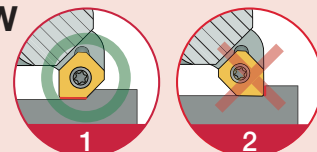

Attach only one wiper insert on the cutter and make sure the wiper edge faces the machining surface.
Feed rate: $f < 0.374$ ipr

STANDARD CUTTING CONDITIONS

Negative type

ISO	Workpiece material	Hardness	Priority	Recommendation		Cutting speed Vc (sfm)	Feed per tooth fz (ipt)
				Grade	Chipbreaker		
P	Low carbon steel 1015, etc.	- 200 HB	First choice	AH3135	MJ	330 - 820	0.008 - 0.020
		- 200 HB	Wear resistance	T3225	MJ	660 - 1150	0.008 - 0.016
		- 200 HB	Low cutting force	AH3135	ML	330 - 820	0.008 - 0.016
	High carbon steel 1045, 1055, etc.	200 - 300 HB	First choice	AH3135	MJ	330 - 750	0.008 - 0.016
		200 - 300 HB	Wear resistance	T3225	MJ	590 - 660	0.008 - 0.016
		200 - 300 HB	Low cutting force	AH3135	ML	330 - 750	0.008 - 0.016
	Alloy steel 4140, etc.	150 - 330 HB	First choice	AH3135	MJ	330 - 660	0.008 - 0.016
		150 - 330 HB	Wear resistance	T3225	MJ	490 - 820	0.008 - 0.016
		150 - 330 HB	Low cutting force	AH3135	ML	330 - 660	0.008 - 0.016
M	Stainless steel S30400, etc.	- 200 HB	First choice	AH3135	MJ	330 - 660	0.004 - 0.012
		- 200 HB	Wear resistance	T3225	MJ	330 - 820	0.004 - 0.012
K	Gray cast iron No.35B, No.45B, etc.	150 - 250 HB	First choice	T1215	MJ	490 - 660	0.008 - 0.020
		150 - 250 HB	Fracture resistance	AH725	MJ	330 - 820	0.008 - 0.020
		150 - 250 HB	Low cutting force	AH120	ML	330 - 820	0.008 - 0.020
	Ductile cast iron 60-40-18, etc.	150 - 300 HB	First choice	T1215	MJ	330 - 660	0.008 - 0.020
		150 - 300 HB	Fracture resistance	AH725	MJ	260 - 660	0.008 - 0.020
		150 - 300 HB	Low cutting force	AH120	ML	260 - 660	0.008 - 0.020
H	Hardened steel	40 - 50 HRC	First choice	AH725	MJ	260 - 430	0.004 - 0.008
		50 - 60 HRC	First choice	AH725	MJ	160 - 230	0.002 - 0.004

Positive type

ISO	Workpiece material	Hardness	Priority	Grade	Cutting speed Vc (sfm)	Feed per tooth : fz (ipt)	
						ML	HJ*
P	Low carbon steel 1015, etc.	- 200 HB	First choice	AH3135	330 - 980	0.004 - 0.016	0.02 - 0.059
		- 200 HB	Fracture resistance	AH130	330 - 980	0.004 - 0.016	-
	High carbon steel 1045, 1055, etc.	200 - 300 HB	First choice	AH3135	330 - 750	0.004 - 0.010	0.02 - 0.059
		200 - 300 HB	Fracture resistance	AH130	330 - 750	0.004 - 0.010	-
	Alloy steel 4140, etc.	150 - 330 HB	First choice	AH3135	330 - 660	0.004 - 0.010	0.02 - 0.059
		150 - 330 HB	Fracture resistance	AH130	330 - 660	0.004 - 0.010	-
M	Stainless steel S30400, etc.	- 200 HB	First choice	AH3135	330 - 500	0.004 - 0.010	0.012 - 0.02
		- 200 HB	Fracture resistance	AH130	330 - 500	0.004 - 0.010	-
K	Gray cast iron No.35B, No.45B, etc.	150 - 250 HB	First choice	AH3135	330 - 830	0.004 - 0.016	0.02 - 0.059
		150 - 250 HB	Fracture resistance	AH130	330 - 830	0.004 - 0.016	-
	Ductile cast iron 60-40-18, etc.	150 - 250 HB	First choice	AH3135	260 - 660	0.004 - 0.010	0.02 - 0.059
		150 - 250 HB	Fracture resistance	AH130	260 - 660	0.004 - 0.010	-
S	Titanium alloy Ti-6Al-4V, etc.	- HRC 40	First choice	AH3135	100 - 200	0.004 - 0.010	0.012 - 0.02
		- HRC 40	Fracture resistance	AH130	100 - 200	0.004 - 0.010	-
	Heat resistant alloy Inconel718, etc.	- HRC 40	First choice	AH3135	30 - 130	0.002 - 0.006	0.004 - 0.012
		- HRC 40	Fracture resistance	AH130	30 - 130	0.002 - 0.006	-
H	Hardened steel	40 - 50 HRC	First choice	AH3135	260 - 420	-	0.004 - 0.012
		50 - 60 HRC	First choice	AH3135	160 - 230	-	0.001 - 0.003

* Apply 20% of recommended feed when using HJ insert with ap over 0.059".

88° face mill, with screw clamp system, for double sided square inserts

GAMP = +3°, GAMF = -11°

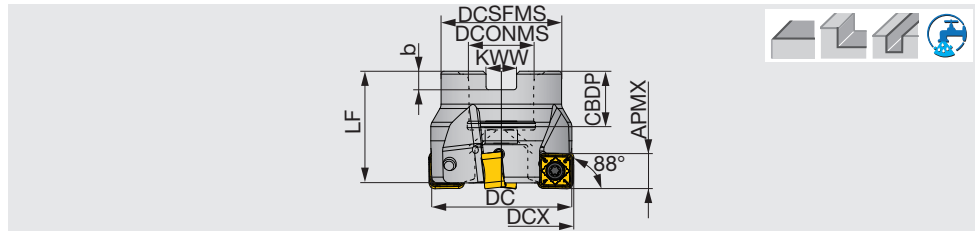

Inch	APMX	DC	DCX	CICT	DCSFMS	LF	DCONMS	CBDP	KWW	b	WT (lb)	Air hole	Insert	Arbor type
THSN12U2.00B0.75R04	0.374	2.000	2.024	4	1.850	1.575	0.750	0.750	0.315	0.197	0.920	With	SNMU1206...	A
THSN12U2.00B0.75R05	0.374	2.000	2.024	5	1.850	1.575	0.750	0.750	0.315	0.197	0.910	With	SNMU1206...	A
THSN12U2.50B0.75R04	0.374	2.500	2.524	4	1.850	1.575	0.750	0.750	0.315	0.197	1.220	With	SNMU1206...	A
THSN12U2.50B0.75R06	0.374	2.500	2.524	6	1.850	1.575	0.750	0.750	0.315	0.197	1.220	With	SNMU1206...	A
THSN12U3.00B1.00R05	0.374	3.000	3.024	5	1.969	1.969	1.000	1.024	0.374	0.236	2.120	With	SNMU1206...	A
THSN12U3.00B1.00R08	0.374	3.000	3.024	8	1.969	1.969	1.000	1.024	0.374	0.236	2.090	With	SNMU1206...	A
THSN12U4.00B1.50R06	0.374	4.000	4.024	6	3.150	1.969	1.500	1.299	0.626	0.394	3.640	Without	SNMU1206...	B
THSN12U4.00B1.50R08	0.374	4.000	4.024	8	3.150	1.969	1.500	1.299	0.626	0.394	3.550	Without	SNMU1206...	B

SPARE PARTS



Designation	Clamping screw	Torx bit	Grip	Shell locking bolt (Optional parts)
THSN12U2.00... THSN12U2.50...	CSPB-4	BLDIP15/S7	H-TB2W	(C0.375X1.125H)
THSN12U3.00...	CSPB-4	BLDIP15/S7	H-TB2W	(C0.500X1.375H)
THSN12U4.00...	CSPB-4	BLDIP15/S7	H-TB2W	(TMBA-0.750H)

*Recommended clamping torque : CSPB-4 = 2.58 lbs·ft

Arbor type

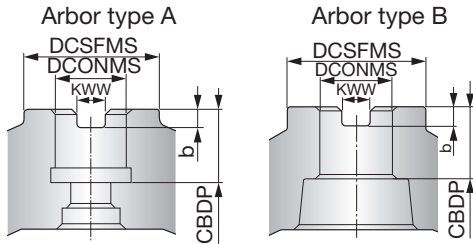

INSERT

SNMU120608HNEN-MM

SNMU120612/20EN-MM

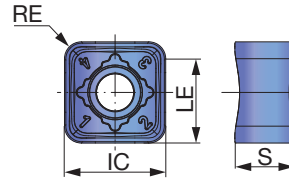
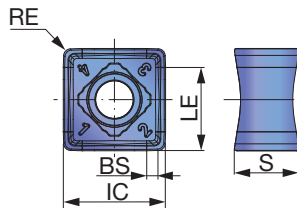

P Steel	☆	★	★	★									
M Stainless		★	★	★									
K Cast iron	★		★										
N Non-ferrous													
S Superalloys	★	☆											
H Hard materials													

★ : First choice
☆ : Second choice

Designation	RE	APMX	Coated				LE	S	IC	BS
			AH120	AH3135	T1215	T3225				
SNMU120608HNEN-MM	0.031	0.374	●	●	●	●	0.386	0.295	0.472	0.055
SNMU120612EN-MM	0.047	0.374	●	●	●	●	0.425	0.285	0.472	-
SNMU120620EN-MM	0.079	0.374	●	●	●	●	0.394	0.276	0.472	-

● : Line up

Reference pages: Standard cutting conditions → **H068**



STANDARD CUTTING CONDITIONS

ISO	Workpiece materials	Hardness HB	Selection criteria	Recommended grade	Chip-breaker	Cutting speed Vc (sfm)	Feed per tooth fz (ipt)
P	Low carbon steels 1015, etc.	- 200 HB	First choice	AH3135	MJ	328 - 820	0.002 - 0.012
		- 200 HB	Wear resistance	T3225	MJ	656 - 1148	0.002 - 0.010
	High carbon steels, alloyed steels 1055, 4140(H), etc.	- 300 HB	First choice	AH3135	MJ	328 - 820	0.002 - 0.012
		- 300 HB	Wear resistance	T3225	MJ	591 - 984	0.002 - 0.010
	Prehardened steel NAK80, PX5, etc.	30 - 40 HRC	First choice	AH3135	MJ	328 - 656	0.002 - 0.010
		30 - 40 HRC	Wear resistance	T3225	MJ	492 - 820	0.002 - 0.008
M	Austenitic stainless steel 304,316, etc.	- 200 HB	First choice	AH3135	MJ	328 - 656	0.002 - 0.010
		- 200 HB	Wear resistance	T3225	MJ	328 - 820	0.002 - 0.008
	Stainless cast steel Hu etc.	-	First choice	T3225	MJ	197 - 394	0.002 - 0.008
		-	Fracture resistance	AH3135	MJ	197 - 394	0.002 - 0.008
K	Grey cast iron No.250, etc.	150 - 250 HB	First choice	T1215	MJ	328 - 1148	0.002 - 0.012
		150 - 250 HB	Fracture resistance	AH120	MJ	328 - 820	0.002 - 0.012
	Ductile cast iron 65-45-12, etc.	150 - 250 HB	First choice	T1215	MJ	328 - 1148	0.002 - 0.010
		150 - 250 HB	Fracture resistance	AH120	MJ	262 - 656	0.002 - 0.012
S	Titanium alloy Ti-6Al-4V, etc.	- 40 HRC	First choice	AH3135	MJ	98 - 197	0.002 - 0.008
	Heat resistant alloy Inconel718, etc.	- 40 HRC	First choice	AH120	MJ	33 - 131	0.002 - 0.006
H	Hardened steel H13, etc.	40 - 50 HRC	First choice	AH3135	MJ	262 - 427	0.002 - 0.006
	Hardened steel D2, etc.	50 - 60 HRC	First choice	AH120	MJ	164 - 230	0.001 - 0.003

Tool offset

To eliminate uncut amount in face milling operation, adjust the programming according to the offset (L) listed below.

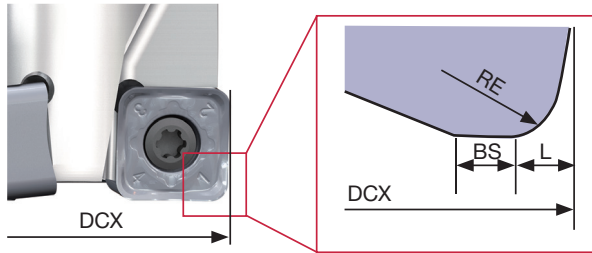

Inch	RE	BS	L
SNMU120608HNEN-MM	0.031	0.055	0.051
SNMU120612EN-MM	0.047	-	0.067
SNMU120620EN-MM	0.079	-	0.098

The following table shows the amount left over cut (t) when the cutter is considered as a shoulder milling cutter.

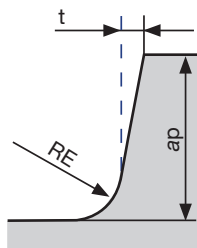

Inch	ap (in)									
	0.039	0.079	0.118	0.157	0.197	0.236	0.276	0.315	0.354	0.374
SNMU120608HNEN-MM	0.0004	0.0016	0.0020	0.0020	0.0028	0.0035	0.0055	0.0079	0.0106	0.0106
SNMU120612EN-MM	-	0	0	0.0004	0.0008	0.0020	0.0035	0.0059	0.0087	0.0098
SNMU120620EN-MM	-	0	0	0	0.0008	0.0020	0.0035	0.0059	0.0087	0.0098

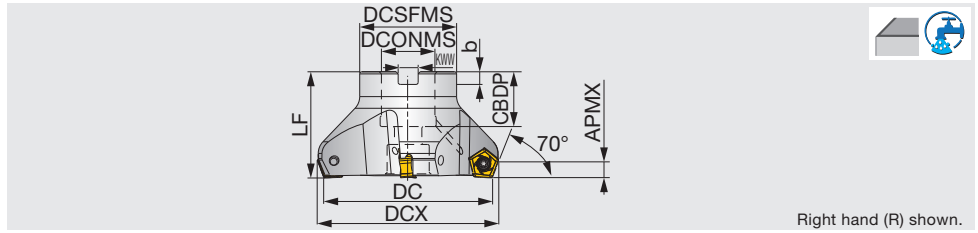

Inch	APMX	DC	DCX	CICT	DCSFMS	LF	DCONMS	CBDP	KWW	b	WT (lb)	Air hole	Insert	Arbor type
TEN09R200U0075A03	0.252	2.000	2.240	3	1.690	1.570	0.750	0.750	0.310	0.200	0.300	With	PN*U0905...	A
TEN09R200U0075A04	0.252	2.000	2.240	4	1.690	1.570	0.750	0.750	0.310	0.200	0.300	With	PN*U0905...	A
TEN09R200U0075A06	0.252	2.000	2.240	6	1.690	1.570	0.750	0.750	0.310	0.200	0.300	With	PN*U0905...	A
TEN09R250U0075A04	0.252	2.500	2.740	4	1.690	1.570	0.750	0.750	0.310	0.200	0.500	With	PN*U0905...	A
TEN09R250U0075A06	0.252	2.500	2.740	6	1.690	1.570	0.750	0.750	0.310	0.200	0.500	With	PN*U0905...	A
TEN09R250U0075A08	0.252	2.500	2.740	8	1.690	1.570	0.750	0.750	0.310	0.200	0.500	With	PN*U0905...	A
TEN09R300U0100A04	0.252	3.000	3.240	4	1.970	1.970	1.000	1.020	0.370	0.240	0.900	With	PN*U0905...	A
TEN09R300U0100A07	0.252	3.000	3.240	7	1.970	1.970	1.000	1.020	0.370	0.240	0.900	With	PN*U0905...	A
TEN09R300U0100A10	0.252	3.000	3.240	10	1.970	1.970	1.000	1.020	0.370	0.240	0.900	With	PN*U0905...	A
TEN09R400U0150A05	0.252	4.000	4.240	5	3.150	1.970	1.500	1.380	0.630	0.390	1.300	With	PN*U0905...	B
TEN09R400U0150A08	0.252	4.000	4.240	8	3.150	1.970	1.500	1.380	0.630	0.390	1.300	With	PN*U0905...	B
TEN09R400U0150A12	0.252	4.000	4.240	12	3.150	1.970	1.500	1.380	0.630	0.390	1.400	With	PN*U0905...	B
TEN09R500U0150A06	0.252	5.000	5.240	6	3.150	2.480	1.500	1.460	0.630	0.390	2.600	With	PN*U0905...	B
TEN09R500U0150A10	0.252	5.000	5.240	10	3.150	2.480	1.500	1.460	0.630	0.390	2.700	With	PN*U0905...	B
TEN09R500U0150A16	0.252	5.000	5.240	16	3.150	2.480	1.500	1.460	0.630	0.390	2.900	With	PN*U0905...	B
TEN09R600U0200A07	0.252	6.000	6.240	7	3.940	2.480	2.000	1.500	0.750	0.430	4.400	Without	PN*U0905...	B
TEN09R600U0200A12	0.252	6.000	6.240	12	3.940	2.480	2.000	1.500	0.750	0.430	4.600	Without	PN*U0905...	B
TEN09R600U0200A20	0.252	6.000	6.240	20	3.940	2.480	2.000	1.500	0.750	0.430	4.900	Without	PN*U0905...	B

SPARE PARTS

Designation	Clamping screw	Grip	Lubricant	Shell locking bolt (Optional parts)	Torx bit
TEN09R200..., 250...	CSTR-4L100	H-TBS	M-1000	(C0.375X1.125H)	BT15S
TEN09R300...	CSTR-4L100	H-TBS	M-1000	(C0.500X1.375H)	BT15S
TEN09R400..., 500...	CSTR-4L100	H-TBS	M-1000	(TMBA-0.750H)	BT15S
TEN09R600...	CSTR-4L100	H-TBS	M-1000	-	BT15M

*Recommended clamping torque : CSTR-4L100 = 2.58 lbs·ft

Arbor type

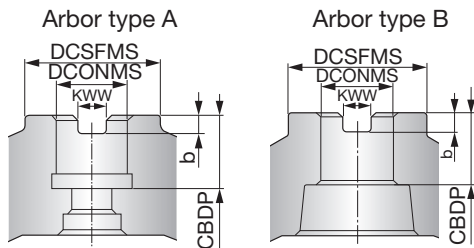

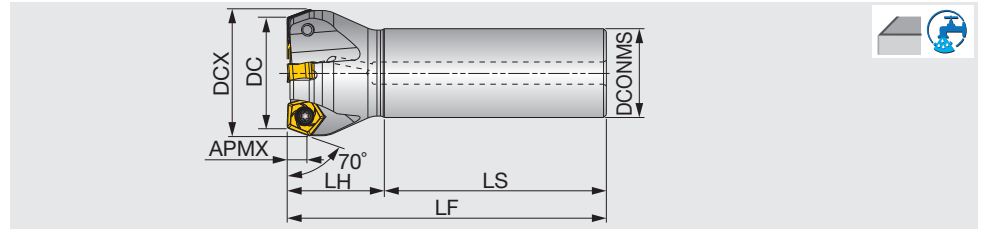

Inch	APMX	DC	DCX	CICT	DCONMS	LS	LH	LF	WT (lb)	Air hole	Insert
EEN09R125U0125W03	0.252	1.250	3	1.250	1.250	2.280	1.500	3.780	0.700	With	PN*U0905...
EEN09R150U0125W04	0.252	1.500	4	1.500	1.250	2.280	2.000	4.280	0.700	With	PN*U0905...

SPARE PARTS

Designation	Clamping screw	Lubricant	Wrench
EEN09	CSTR-4L100	M-1000	T-15D

*Recommended clamping torque : CSTR-4L100 = 2.58 lbs·ft

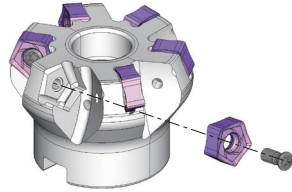

INSERT

PN*U0905GNEN-MJ (Neutral)

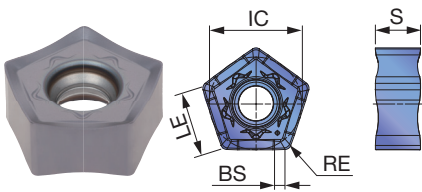

PNCU0905GNER-MJ (Right hand)

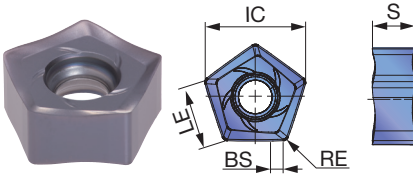

PNCU0905-ML (Neutral)

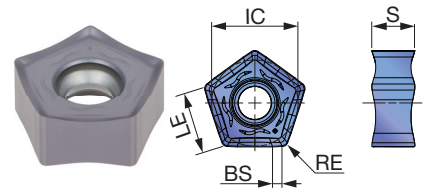

PNCU0905-AJ (Right hand)

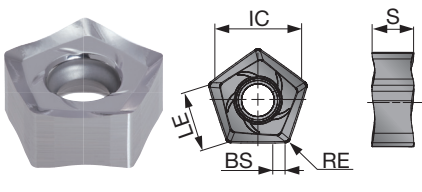

PNCU0905-W (Right hand)

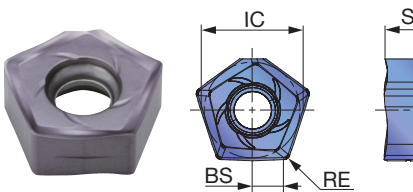

P	Steel	☆	☆	★	★	☆	☆	★					
M	Stainless		☆	☆	★		☆						
K	Cast iron	★		☆	★	★							
N	Non-ferrous									★			
S	Superalloys	☆		★	☆								
H	Hard materials												

★ : First choice
☆ : Second choice

Designation	RE	APMX	Coated							Cermet	Uncoated	LE	S	IC	BS
			AH120	AH140	AH725	AH3135	T1115	T1215	T3130	T3225	NS740				
PNMU0905GNEN-MJ	0.031	0.252	●			●	●					0.350	0.236	0.480	0.055
PNCU0905GNEN-MJ	0.031	0.252	●			●	●					0.350	0.236	0.480	0.055
PNCU0905GNER-MJ	0.031	0.252	●	●	●		●	●		●		0.350	0.233	0.480	0.055
PNCU0905GNEN-ML	0.031	0.252				●						0.350	0.235	0.480	0.055
PNCU0905GNFR-AJ	0.031	0.252								●		0.350	0.246	0.480	0.055
PNCU0905GNER-W	0.031	0.079			●							-	0.233	0.480	0.150

● : Line up

Reference pages: Standard cutting conditions → **H071**

STANDARD CUTTING CONDITIONS

ISO	Workpiece materials	Hardness HB	Selection criteria	Recommended grade	Chip-breaker	Cutting speed Vc (sfm)	Feed per tooth fz (ipt)
P	Low carbon steels 1015, etc.	200 - 300 HB	First choice	AH3135	MJ	330 - 820	0.004 - 0.024
		200 - 300 HB	Low cutting force	AH3135	ML	330 - 820	0.004 - 0.012
		200 - 300 HB	Wear resistance	T3225	MJ	660 - 1150	0.004 - 0.012
		200 - 300 HB	Surface quality	NS740	MJ	330 - 820	0.004 - 0.012
	High carbon steels, alloyed steels 1045, etc.	150 - 300 HB	First choice	AH3135	MJ	330 - 820	0.004 - 0.014
		150 - 300 HB	Low cutting force	AH3135	ML	330 - 820	0.004 - 0.012
		150 - 300 HB	Wear resistance	T3225	MJ	590 - 990	0.004 - 0.012
		150 - 300 HB	Surface quality	NS740	MJ	330 - 820	0.004 - 0.012
	Prehardened steel NAK80, PX5, etc.	30 - 40 HRC	First choice	AH3135	MJ	330 - 660	0.004 - 0.012
30 - 40 HRC		Low cutting force	AH3135	ML	330 - 660	0.004 - 0.010	
30 - 40 HRC		Wear resistance	T3225	MJ	490 - 820	0.004 - 0.010	
M	Stainless steel S30400, etc.	- 200 HB	First choice	AH3135	ML	330 - 660	0.004 - 0.012
		- 200 HB	Fracture resistance	AH3135	MJ	330 - 660	0.004 - 0.014
		- 200 HB	Wear resistance	T3225	MJ	330 - 820	0.004 - 0.012
K	Gray cast irons No.250B, No.300B, etc.	150 - 250 HB	First choice	T1215	MJ	460 - 820	0.004 - 0.024
		150 - 250 HB	Fracture resistance	AH120	MJ	490 - 280	0.004 - 0.024
	Ductile cast iron 60-40-18, etc.	150 - 250 HB	First choice	T1215	MJ	330 - 660	0.004 - 0.024
		150 - 250 HB	Fracture resistance	AH120	MJ	390 - 720	0.004 - 0.024
N	Aluminum alloys Si < 13%	-	First choice	TH10	AJ	1640 - 4921	0.004 - 0.020
	Aluminum alloys Si ≥ 13%	-	First choice	TH10	AJ	490 - 1640	0.004 - 0.020
S	Titanium alloys Ti-6Al-4V, etc.	- 40 HRC	First choice	AH3135	ML	98 - 197	0.004 - 0.016
		- 40 HRC	Fracture resistance	AH3135	MJ	98 - 197	0.004 - 0.016
	Heat-resistant alloys Inconel 718, etc.	- 40 HRC	First choice	AH725	MJ	66 - 164	0.002 - 0.004

- Remove excessive chip with an air blast to prevent chip jamming.
- Use water-soluble coolant to avoid built-up edge in case extreme welding occurs on cutting edges. (ex. aluminum machining).
- For the operation with depth of cut which varies (ex. casting skin) and machining of workpiece materials with interrupted surface, the feed (fz) should be set to the lower recommended value shown in the above table.

- Cutting conditions may be limited depending on machine power, workpiece rigidity, and spindle output. When the cutting width, depth or overhang length is large, set Vc and fz to the lower recommended values and check the machine power and vibration.

Installation of inserts on an extra close-pitch cutter

- On an extra close-pitch cutter, the screw hole of an insert pocket is placed at an angle.
- Leave a gap between the insert and pocket when starting to fasten the screw on the cutter body as shown in Fig. A.
- After fastening the screw, please ensure that there is no gap between the cutter body and insert. (Fig. B)

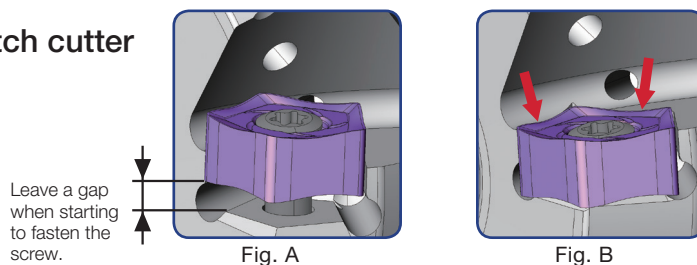

Notes for using wiper inserts

- When fine surface finish is required, wiper insert PNCU0905GNER-W is recommended.
- Attach the insert with its notch on the top, as shown in Fig. C.
- Also, make sure that the mark of the insert is located at the bottom of the cutter body, as shown in Fig. D.
- The wiper insert has two corners available (Fig. D). Do not use the other corners as the cutter body may be broken.

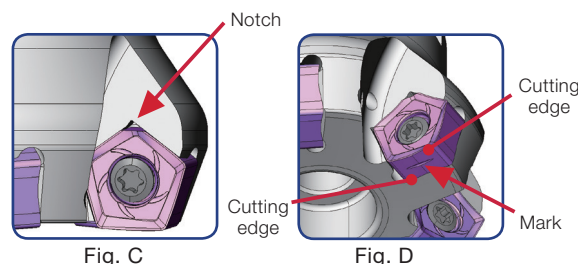

Face milling cutter for high temperature alloy applications, Tool dia. $\phi 2.000''$ - $\phi 3.000''$

GAMP = -7°, GAMF = +15°

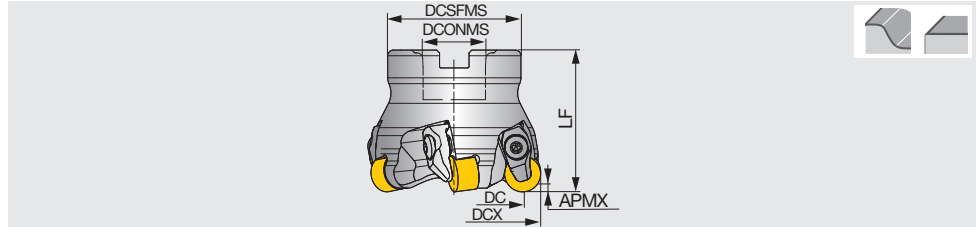

Inch	APMX	DC	DCX	CICT	DCONMS	LF	DCSFMS	WT(lb)	Insert	Arbor type
TFMRND2.00-12-4Z-FL	0.080	1.528	2.000	4	0.750	2.000	1.770	0.88	RNGN120700...	A
TFMRND2.50-12-5Z-FL	0.080	2.000	2.500	5	1.570	1.969	0.750	0.99	RNGN120700...	A
TFMRND3.00-12-5Z-FL	0.080	2.500	3.000	5	1.750	1.969	1.000	2.07	RNGN120700...	A

Metric	APMX	DC	DCX	CICT	DCONMS	LF	DCSFMS	WT(kg)	Insert	Arbor type
TFMRN563-22R-12FL	2	50.35	63	5	22	50	47	0.6	RNGN120700...	A
TFMRN580-27R-12FL	2	67.37	80	5	27	50	58	0.9	RNGN120700...	A

SPARE PARTS

Designation	Clamp	Screw	Snap ring
TFMRND..., TFMRN...	CCL-5S-F	CLS3C	CSR2

Arbor type

Arbor type A

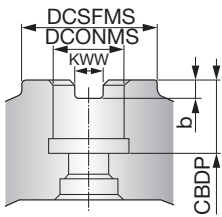

Approach angle

10°-20°

45°

70°

85°

88°

90°

Others

Reference pages: Inserts, Standard cutting conditions → **H073**

INSERT

RNGN-E/T1

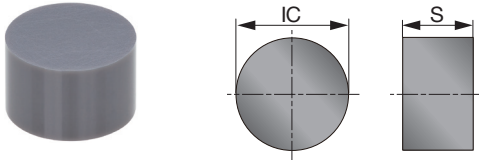

P	Steel																			
M	Stainless																			
K	Cast iron																			
N	Non-ferrous																			
S	Superalloys			★	★															
H	Hard materials																			

★ : First choice

Designation	APMX (in)	Edge prep.*	Ceramic										IC (in)	S (in)			
			TS200	TS300													
RNGN120700-E	0.080	E	●													0.500	0.3125
RNGN120700-T1	0.080	T1	●													0.500	0.3125
RNGN120700-E	0.080	E		●												0.500	0.3125
RNGN120700-T1	0.080	T1		●												0.500	0.3125

* Types of cutting edge preparations

●: Line up

E: Low cutting force

T1: Strong cutting edge

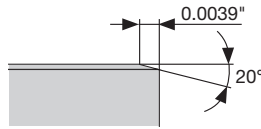
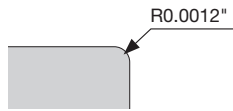

STANDARD CUTTING CONDITIONS

ISO	Workpiece materials	Grades	Cutting speed Vc (sfm)	Feed per tooth fz (ipt)	Depth of cut ap (in)
S	Ni-based super alloys	TS200	1804 - 4265	0.002 - 0.008	0.004 - 0.079
		TS300	886 - 1804	0.002 - 0.008	0.004 - 0.079
	Co-based super alloys	TS200	1804 - 4921	0.002 - 0.008	0.004 - 0.079
		TS300	886 - 1804	0.002 - 0.008	0.004 - 0.079

Grade
Insert
Ext. Toolholder
Int. Toolholder
Threading
Grooving
Miniature Tool
Milling Cutter
Endmill
Drilling Tool
Tooling System
User's Guide
Index



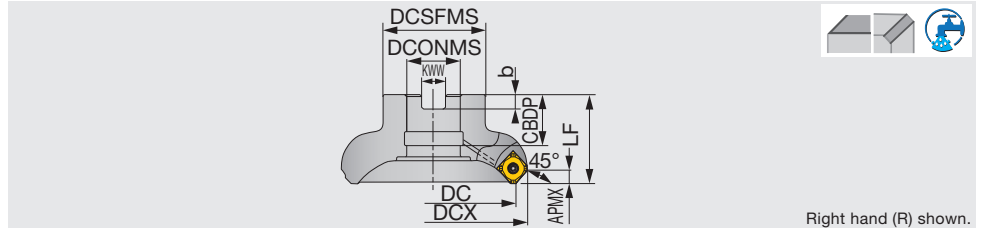

Inch	DC	DCX	CICT	DCSFMS	LF	DCONMS	CBDP	KWW	b	WT (lb)	Air hole	Insert	Arbor type
TAW13R200U0075A03	2.000	3	2.510	1.693	1.575	0.750	0.750	0.315	0.197	0.880	With	SW*T13...	A
TAW13R200U0075A04	2.000	4	2.510	1.693	1.575	0.750	0.750	0.315	0.197	0.880	With	SW*T13...	A
TAW13R200U0075A05	2.000	5	2.510	1.693	1.575	0.750	0.750	0.315	0.197	0.880	With	SW*T13...	A
TAW13R300U0100A04	3.000	4	3.510	1.969	1.969	1.000	1.020	0.374	0.236	1.980	With	SW*T13...	A
TAW13R300U0100A06	3.000	6	3.510	1.969	1.969	1.000	1.020	0.374	0.236	1.980	With	SW*T13...	A
TAW13R300U0100A08	3.000	8	3.510	1.969	1.969	1.000	1.020	0.374	0.236	1.980	With	SW*T13...	A
TAW13R400U0150A05	4.000	5	4.520	3.150	1.969	1.500	1.378	0.626	0.394	3.750	With	SW*T13...	B
TAW13R400U0150A07	4.000	7	4.520	3.150	1.969	1.500	1.378	0.626	0.394	3.530	With	SW*T13...	B
TAW13R400U0150A10	4.000	10	4.520	3.150	1.969	1.500	1.378	0.626	0.394	3.750	With	SW*T13...	B
TAW13R500U0150A06	5.000	6	5.510	3.150	2.480	1.500	1.457	0.626	0.394	6.170	With	SW*T13...	B
TAW13R500U0150A08	5.000	8	5.510	3.150	2.480	1.500	1.457	0.626	0.394	5.950	With	SW*T13...	B
TAW13R500U0150A12	5.000	12	5.510	3.150	2.480	1.500	1.457	0.626	0.394	6.170	With	SW*T13...	B
TAW13R600U0200A07	6.000	7	6.510	3.937	2.480	2.000	1.500	0.748	0.433	9.040	Without	SW*T13...	B
TAW13R600U0200A10	6.000	10	6.510	3.937	2.480	2.000	1.500	0.748	0.433	8.600	Without	SW*T13...	B
TAW13R600U0200A16	6.000	16	6.510	3.937	2.480	2.000	1.500	0.748	0.433	9.040	Without	SW*T13...	B

*Recommended clamping torque : CSPB-3.5 = 2.58 lbs·ft

SPARE PARTS

Designation	③Clamping screw	Lubricant	①Shim screw	Shell locking bolt	②Shim	Wrench	Wrench 1
TAW13R200...	CSPB-3.5	M-1000	DTS5-3.5SS	0.375X1.125H	FSSA1102	IP-15D	P-3.5
TAW13R300...	CSPB-3.5	M-1000	DTS5-3.5SS	C0.500X1.375H	FSSA1102	IP-15D	P-3.5
TAW13R400..., 500...	CSPB-3.5	M-1000	DTS5-3.5SS	TMBA-0.750H	FSSA1102	IP-15D	P-3.5
TAW13R600...	CSPB-3.5	M-1000	DTS5-3.5SS	-	FSSA1102	IP-15D	P-3.5

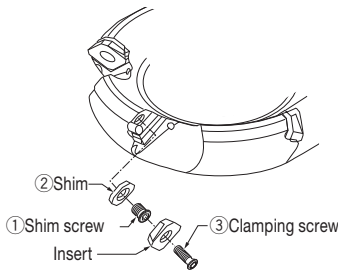

Arbor type

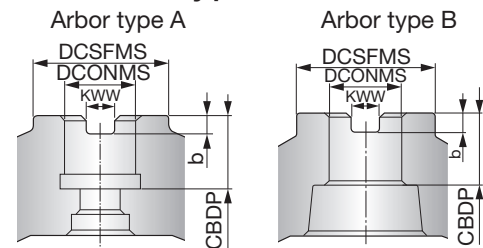

Reference pages: Inserts → **H076**, Standard cutting conditions → **H077 - H078**

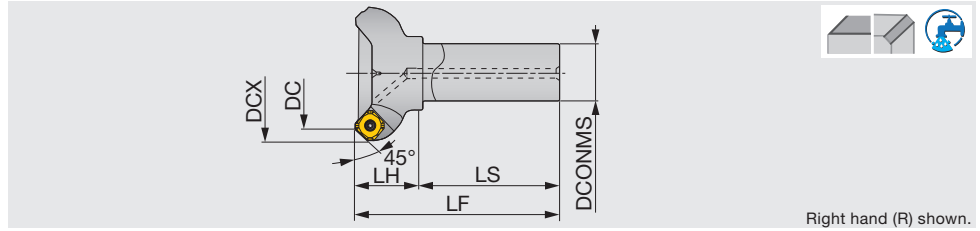

Right hand (R) shown.

Metric	DC	DCX	CICT	DCONMS	LS	LH	LF	WT(kg)	Air hole	Insert
EAW13R025M25.0-02	25	39	2	25	80	35	115	0.4	With	SW*T13...
EAW13R032M32.0-02	32	46	2	32	80	35	115	0.7	With	SW*T13...
EAW13R040M32.0-03	40	54	3	32	80	35	115	0.8	With	SW*T13...
EAW13R050M32.0-03	50	63	3	32	80	40	120	1	With	SW*T13...
EAW13R050M32.0-04	50	63	4	32	80	40	120	0.9	With	SW*T13...
EAW13R063M32.0-04	63	76	4	32	80	40	120	1.1	With	SW*T13...
EAW13R063M32.0-05	63	76	5	32	80	40	120	1.1	With	SW*T13...
EAW13R080M32.0-04	80	94	4	32	80	40	120	1.5	With	SW*T13...
EAW13R080M32.0-06	80	94	6	32	80	40	120	1.4	With	SW*T13...

SPARE PARTS

Designation	③ Clamping screw	Lubricant	① Shim screw	② Shim	Wrench	Wrench 1
EAW13R025**-040**	CSPB-3.5	M-1000	-	-	IP-15D	-
EAW13R050**-080**	CSPB-3.5	M-1000	DTS5-3.5SS	FSSA1102	IP-15D	P-3.5

*Recommended clamping torque : CSPB-3.5 = 3.5 N·m

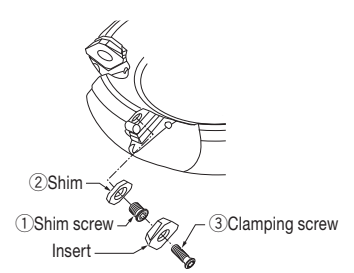

INSERT

SWMT13T3-MJ

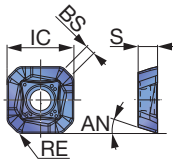

SWMT13T3-ML

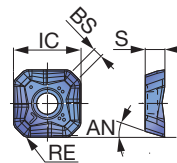

SWMW13T3 (Flat)

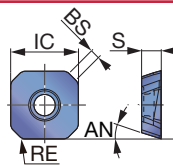

SWMT13T3-HJ

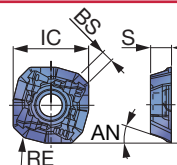

SWMT13T3-MS

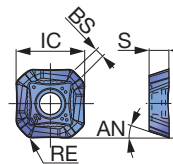

SWG13T3-MJ

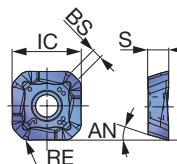

SWG13T3-AJ

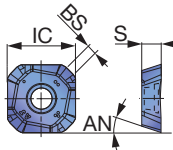

WWCW13T3AFER-WS

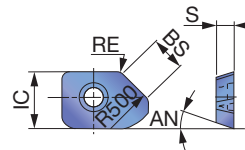

WWCW13T3AFFR-WS

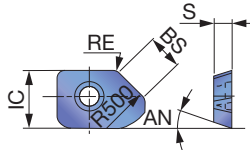

WWCW13T3AFFR-WD

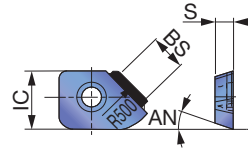

Approach angle

10-20°

45°

70°

85°

88°

90°

Others

P Steel	☆			★					★							
M Stainless		★	☆	★						☆						
K Cast iron	★				★	★	★									
N Non-ferrous												★		★		
S Superalloys	★	☆		☆												
H Hard materials																

★ : First choice
☆ : Second choice

Designation	RE	APMX	Coated							Cermet NS740	Uncoated KS05F	PCD DX140	IC	S	AN	BS	
			AH120	AH130	AH140	AH3135	GH110	T1115	T1215								T3130
SWMT13T3AFPR-MJ	0.059	0.157	●	●	●	●		●	●	●	●			0.547	0.157	18.5	0.079
SWMT13T3AFER-ML	0.059	0.098	●	●	●	●								0.547	0.157	18.5	0.079
SWMW13T3AFTR	0.059	0.197	●			●		●	●	●	●			0.547	0.157	18.5	0.079
SWMT13T3AFPR-HJ	0.059	0.079	●	●	●	●		●	●	●	●			0.579	0.157	18.5	0.091
SWMT13T3AFPR-MS	0.039	0.157		●	●	●								0.555	0.157	18.5	0.079
SWG13T3AFPR-MJ	0.059	0.157	●			●					●			0.547	0.157	18.5	0.079
SWG13T3AFFR-AJ	-	0.157										●		0.555	0.157	18.5	0.079
WWCW13T3AFER-WS	0.059	-						●			●			0.504	0.157	18.5	0.307
WWCW13T3AFFR-WS	0.059	-									●			0.504	0.157	18.5	0.307
WWCW13T3AFFR-WD	-	-										●		0.504	0.157	18.5	0.307

● : Line up

DX140 : 1 piece per package

STANDARD CUTTING CONDITIONS

ISO	Workpiece materials	Priority	Grade	Cutting speed vc (sfm)	Roughing (Depth of cut: > 0.039")					
					Feed per tooth: fz (ipt)					
					MJ	ML	HJ	MS	Flat	AJ
P	Mild and low carbon steels 1010, 1015, etc. < 180 HB	First choice	AH3135	330 - 890	0.002 - 0.012	0.002 - 0.010	0.008 - 0.024	0.004 - 0.010	0.002 - 0.012	-
		Wear resistance	T3225	490 - 300	0.002 - 0.012	-	0.008 - 0.024	-	0.002 - 0.012	-
		Surface quality	NS740	330 - 980	0.002 - 0.009	-	-	-	0.002 - 0.009	-
	Carbon and alloy steels 1045, 4140, etc. < 300 HB	First choice	AH3135	330 - 760	0.002 - 0.010	0.002 - 0.008	0.008 - 0.020	-	0.002 - 0.010	-
		Wear resistance	T3225	490 - 910	0.002 - 0.010	-	0.008 - 0.020	-	0.002 - 0.010	-
		Surface quality	NS740	330 - 760	0.002 - 0.008	-	-	-	0.002 - 0.008	-
	Die steels H13, D2, etc. < 30 HRC	First choice	AH3135	330 - 590	0.002 - 0.008	0.002 - 0.008	0.008 - 0.016	-	0.002 - 0.008	-
		Wear resistance	T3225	330 - 590	0.002 - 0.008	-	0.008 - 0.016	-	0.002 - 0.008	-
	M	Stainless steels S30400, S31600, etc. < 250 HB	First choice	AH3135	260 - 660	0.004 - 0.010	-	0.008 - 0.020	0.004 - 0.008	-
Wear resistance			T3225	490 - 820	0.004 - 0.010	0.004 - 0.008	0.008 - 0.020	-	0.004 - 0.010	-
K	Gray cast irons No.250B, No.300B, etc.	First choice	T1215	590 - 980	0.002 - 0.010	-	0.008 - 0.024	-	0.002 - 0.010	-
		Fracture resistance	AH120	490 - 820	0.002 - 0.010	0.002 - 0.008	0.008 - 0.024	-	0.002 - 0.010	-
	Ductile cast irons 60-40-18, 80-55-06, etc.	First choice	T1215	390 - 660	0.002 - 0.010	-	0.008 - 0.024	-	0.002 - 0.010	-
		Fracture resistance	AH120	330 - 590	0.002 - 0.010	0.002 - 0.008	0.008 - 0.024	-	0.002 - 0.010	-
S	Titanium alloys Ti-6Al-4V, etc.	First choice	AH130	98 - 197	-	-	-	0.004 - 0.008	-	-
	Heat-resistant alloys Inconel 718, etc.	First choice	AH120	33 - 131	0.002 - 0.006	-	-	-	-	-
N	Aluminum alloys Si < 13 %	-	DS1100 KS05F	300 - 3281	-	-	-	-	-	0.002 - 0.008
	Aluminum alloys Si ≥ 13%	-	DS1100 KS05F	260 - 980	-	-	-	-	-	0.002 - 0.008
	Copper alloys	-	DS1100 KS05F	660 - 1640	-	-	-	-	-	0.002 - 0.008

Notes for use of HJ-type inserts

HJ-type inserts can be used for high feed machining.

When using the insert, care should be taken with the following:

- The maximum depth of cut is $ap = 0.079"$. Select feeds within the above value.
- Do not use the HJ-type inserts with other types (such as MJ- and MS-types) in the same body.
- The outer shape of the HJ-type insert is different from those of other types (such as MJ- and MS-types), but the insert can be held in the same insert pocket.

Notes on use of wiper insert

- When requiring good surface finishes, use of a wiper insert (WWCW13T3AF_ R-W_) is recommended. In general, installing one wiper insert delivers superior surface finishes.
- When using the wiper insert, install the insert as shown in Fig. A. If the insert is installed as shown in Fig. B, breakage of the insert is inevitable and normal surface finish can not be obtained.
- The wiper insert must not be used together with HJ-type inserts

- The wiper insert has one wiping corner.
- The peripheral cutting edge of the wiper insert is retracted from the edge of the normal inserts. Therefore, the feed per tooth (ipt) of the normal insert following the wiper insert is double that of other inserts.
- When using the wiper insert, depth of cut (ap) less than 0.039" is recommended.

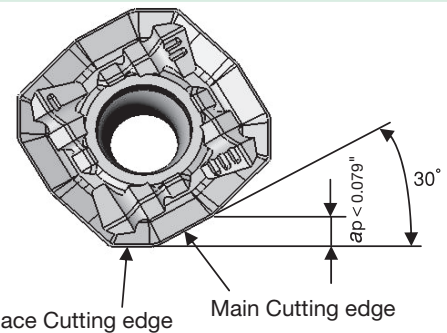

Fig. A

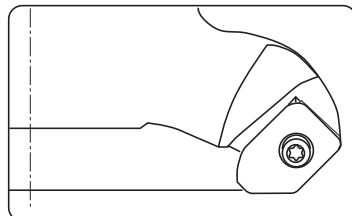
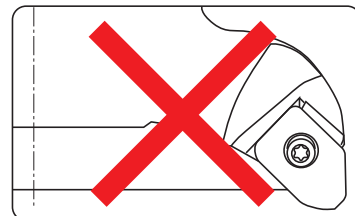

Fig. B



Grade
Insert
Ext. Toolholder
Int. Toolholder
Threading
Grooving
Miniature Tool
Milling Cutter
Endmill
Drilling Tool
Tooling System
User's Guide
Index





ISO	Workpiece materials	Priority	Grade	Cutting speed vc (sfm)	Light cutting to finishing (Depth of cut: ≤ 0.039")					
					Feed per tooth: fz (ipt)					
					MJ	ML	HJ	MS	Flat	AJ
P	Mild and low carbon steels 1010, 1015, etc. < 180 HB	First choice	AH3135	330 - 890	0.002 - 0.010	0.002 - 0.008	0.008 - 0.024	0.004 - 0.008	0.002 - 0.010	-
		Wear resistance	T3225	490 - 980	0.002 - 0.010	-	0.008 - 0.024	-	0.002 - 0.010	-
		Surface quality	NS740	330 - 980	0.002 - 0.008	-	-	-	0.002 - 0.008	-
	Carbon and alloy steels 1045, 4140, etc. < 300 HB	First choice	AH3135	330 - 760	0.002 - 0.008	0.002 - 0.006	0.008 - 0.020	-	0.002 - 0.008	-
		Wear resistance	T3225	490 - 920	0.002 - 0.008	-	0.008 - 0.020	-	0.002 - 0.008	-
		Surface quality	NS740	330 - 760	0.002 - 0.007	-	-	-	0.002 - 0.007	-
	Die steels H13, D2, etc. < 30 HRC	First choice	AH3135	330 - 1590	0.002 - 0.007	0.002 - 0.005	0.008 - 0.016	-	0.002 - 0.007	-
		Wear resistance	T3225	330 - 590	0.002 - 0.007	-	0.008 - 0.016	-	0.002 - 0.007	-
	M	Stainless steels S30400, S31600, etc. < 250 HB	First choice	AH3135	260 - 660	0.004 - 0.008	-	0.008 - 0.020	0.004 - 0.007	-
Wear resistance			T3225	590 - 820	0.004 - 0.008	0.004 - 0.007	0.008 - 0.020	-	0.004 - 0.008	-
K	Gray cast irons No.250B, No.300B, etc.	First choice	T1215	590 - 980	0.004 - 0.008	-	0.008 - 0.024	-	0.004 - 0.008	-
		Fracture resistance	AH120	490 - 820	0.004 - 0.008	0.002 - 0.007	0.008 - 0.024	-	0.004 - 0.008	-
	Ductile cast irons 60-40-18, 80-55-06, etc.	First choice	T1215	390 - 660	0.004 - 0.008	-	0.008 - 0.024	-	0.004 - 0.008	-
		Fracture resistance	AH120	330 - 590	0.004 - 0.008	0.002 - 0.007	0.008 - 0.024	-	0.004 - 0.008	-
S	Titanium alloys Ti-6Al-4V, etc.	-	AH130	98 - 197	-	-	-	0.004 - 0.008	-	-
	Heat-resistant alloys Inconel 718, etc.	-	AH120	33 - 131	0.002 - 0.006	-	-	-	-	-
N	Aluminum alloys Si < 13 %	-	DS1100 KS05F	990 - 3281	-	-	-	-	-	0.002 - 0.008
	Aluminum alloys Si ≥ 13%	-	DS1100 KS05F	260 - 980	-	-	-	-	-	0.002 - 0.008
	Copper alloys	-	DS1100 KS05F	660 - 1640	-	-	-	-	-	0.002 - 0.008

Notes:

- When cutting at a large depth of cut or a large cutting width, the cutting speed (vc) and feed (fz) should be set to the lower side of the values shown in the above table.
- Dry cutting (or air-blowing) is generally recommended. However, when chips tend to excessively adhere to the cutting edges when machining

- stainless steel, use a water soluble cutting fluid. In this case, use the AH130 grade at speeds lower than vc = 330 sfm.
- When wet machining mild steels, carbon steels and alloy steels, use T3130 at lower cutting conditions.
- TAW13 type TAC mills cannot be used for axial-feed cutting such as ramping, plunging and drilling.

Face mill for aluminum machining, for PCD inserts

GAMP = +9°, GAMF = +4°

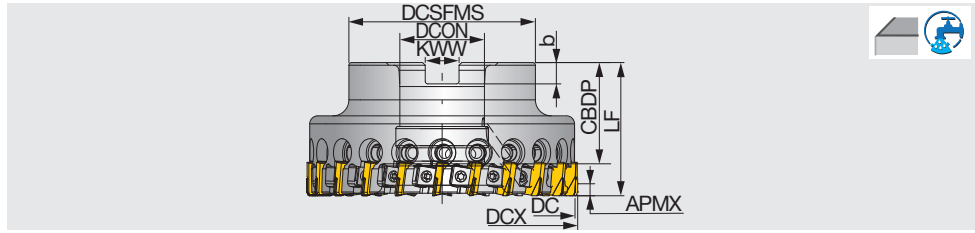

Inch	APMX	DC	DCX	CICT	DCSFMS	LF	DCON	CBDP	KWW	b	WT (lb)	Air hole	RPMX	Insert
TPYD06U2.50B0.75R10	0.177	2.500	2.579	10	1.772	1.575	0.750	0.750	0.315	0.197	1.340	With	19,000	YDEN0603...
TPYD06U3.00B1.00R16	0.177	3.000	3.079	16	2.362	1.969	1.000	1.024	0.374	0.236	2.560	With	17,000	YDEN0603...
TPYD06U4.00B1.25R22	0.177	4.000	4.079	22	2.756	1.969	1.250	0.827	0.500	0.315	4.300	With	15,000	YDEN0603...
TPYD06U5.00B1.50R26	0.177	5.000	5.079	26	3.543	2.362	1.500	1.299	0.626	0.394	8.030	With	14,000	YDEN0603...
TPYD06U6.00B1.50R34	0.177	6.000	6.079	34	3.543	2.362	1.500	1.299	0.626	0.394	10.760	With	12,000	YDEN0603...
Metric	APMX	DC	DCX	CICT	DCSFMS	LF	DCON	CBDP	KWW	b	WT(kg)	Air hole	RPMX	Insert
TPYD06M063B22.0R10	4.5	63	65	10	45	40	22	20	10.4	6.3	0.57	With	19,000	YDEN0603...
TPYD06M080B27.0R16	4.5	80	82	16	60	50	27	22	12.4	7	1.24	With	17,000	YDEN0603...
TPYD06J080B25.4R16	4.5	80	82	16	60	50	25.4	26	9.5	6	1.26	With	15,000	YDEN0603...
TPYD06M100B32.0R22	4.5	100	102	22	70	50	32	25	14.4	8	1.78	With	14,000	YDEN0603...
TPYD06J100B31.7R22	4.5	100	102	22	70	50	31.7	32	12.7	8	1.76	With	12,000	YDEN0603...
TPYD06M125B40.0R26	4.5	125	127	26	90	60	40	32	16.4	9	3.48	With	17,000	YDEN0603...
TPYD06J125B38.1R26	4.5	125	127	26	90	60	38.1	38	15.9	10	3.56	With	15,000	YDEN0603...
TPYD06M160B40.0R34	4.5	160	162	34	90	60	40	32	16.4	9	5.2	With	14,000	YDEN0603...
TPYD06J160B38.1R34	4.5	160	162	34	90	60	38.1	38	15.9	10	5.29	With	12,000	YDEN0603...

SPARE PARTS

Designation	Insert locking wedge	Wedge fixing screw	Adjusting cam	Torx bit	Cam tightening screw	Wrench	Grip	Shell locking bolt	Shell locking bolt (Optional parts)
TPYD06U2.50B0.75R10	WF875N	DS-5T	AJC08	BLDT10/S7-A	SSHM4-4	P-2	H-TB2W	-	(C0.375X1.125H)
TPYD06U3.00B1.00R16	WF875N	DS-5T	AJC08	BLDT10/S7-A	SSHM4-4	P-2	H-TB2W	-	(C0.500X1.375H)
TPYD06U4.00B1.25R22	WF875N	DS-5T	AJC08	BLDT10/S7-A	SSHM4-4	P-2	H-TB2W	-	-
TPYD06U5.00..., 6.00...	WF875N	DS-5T	AJC08	BLDT10/S7-A	SSHM4-4	P-2	H-TB2W	-	(TMBA-0.750H)
TPYD06M063B22.0R10	WF875N	DS-5T	AJC08	BLDT10/S7-A	SSHM4-4	P-2	H-TB2W	CM10X30H	-
TPYD06*080B2**R16	WF875N	DS-5T	AJC08	BLDT10/S7-A	SSHM4-4	P-2	H-TB2W	CM12X30H	-
TPYD06*100B32.0R22	WF875N	DS-5T	AJC08	BLDT10/S7-A	SSHM4-4	P-2	H-TB2W	CM16X40H	-
TPYD06*100B31.7R22	WF875N	DS-5T	AJC08	BLDT10/S7-A	SSHM4-4	P-2	H-TB2W	TMBA-M16H	-
TPYD06*125B**R26	WF875N	DS-5T	AJC08	BLDT10/S7-A	SSHM4-4	P-2	H-TB2W	TMBA-M20H	-
TPYD06*160B**R34	WF875N	DS-5T	AJC08	BLDT10/S7-A	SSHM4-4	P-2	H-TB2W	TMBA-M20H	-

Face endmill for aluminum machining, shank type, for PCD inserts

GAMP = +9°, GAMF = +4°

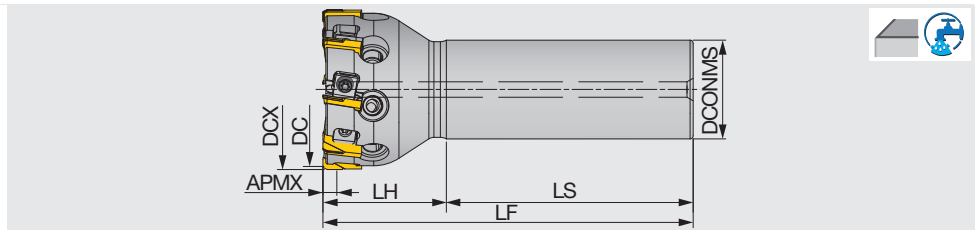

Inch	APMX	DC	DCX	CICT	DCONMS	LF	LH	LS	WT (lb)	Air hole	RPMX	Insert
EPYD06U2.00C1.25R08	0.177	2.000	2.079	8	1.250	4.500	1.575	2.925	1.920	With	22,000	YDEN0603...
Metric	APMX	DC	DCX	CICT	DCONMS	LF	LH	LS	WT(kg)	Air hole	RPMX	Insert
EPYD06M050C32.0R08	4.5	50	52	8	32	120	40	80	0.57	With	22,000	YDEN0603...

SPARE PARTS

Designation	Clamping screw	Wedge fixing screw	Adjusting cam	Torx bit	Cam tightening screw	Wrench	Grip
EPYD06...	WF875N	DS-5T	AJC08	BLDT10/S7-A	SSHM4-4	P-2	H-TB2W

Reference pages: Inserts, Standard cutting conditions → H080





INSERT

YDEN0603PD(F/S)R-D

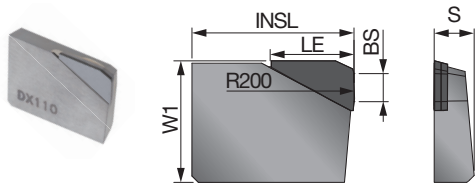

YDEN0603PDFR-WD

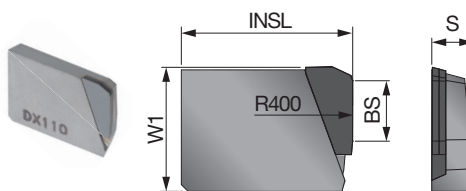

YDEN0603PDFR-BD

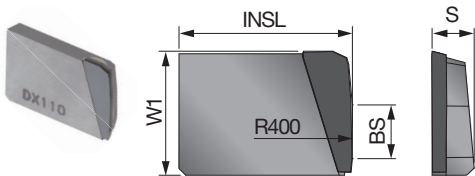

P	Steel									
M	Stainless									
K	Cast iron									
N	Non-ferrous	★								
S	Superalloys									
H	Hard materials									

★ : First choice
☆ : Second choice

Designation	APMX	Edge prep.	PCD								W1	INSL	S	BS	LE
			DX110												
YDEN0603PDFR-D	0.177	Without	●								0.375	0.500	0.122	0.087	0.256
YDEN0603PDSR-D	0.177	With	●								0.375	0.500	0.122	0.087	0.256
YDEN0603PDFR-WD	-	Without	●								0.364	0.504	0.122	0.177	-
YDEN0603PDFR-BD	-	With	●								0.364	0.508	0.122	0.157	-

Tungaloy provides refurbishing service for these inserts upon request.

● : Line up

1 piece per package

STANDARD CUTTING CONDITIONS

ISO	Workpiece material	Grade	Designation	Cutting speed Vc (sfm)	Feed per tooth fz (ipt)
N	Cast aluminum alloy / Die-cast Si < 13%	DX110	YDEN0603PDFR-D	1640 - 13123	0.002 - 0.008
	Cast aluminum alloy / Die-cast Si > 13%	DX110	YDEN0603PDFR-D	656 - 2625	0.002 - 0.008
	Aluminum alloy	DX110	YDEN0603PDFR-D	1640 - 13123	0.002 - 0.008
	Copper alloy	DX110	YDEN0603PDFR-D	656 - 1640	0.002 - 0.008

- The values in the above list are of standard recommendations and may require adjustments in consideration with cutting depths and/or workpiece/machine rigidity.

- Use wiper inserts (-WD) for better surface requirements and deburring inserts (-BD) to remove burrs.

- Always use wet cutting (emulsion coolant) for machining aluminum or copper alloys.

86° face mill for aluminum machining, with screw clamp system, for positive square inserts

GAMP = +13°, GAMF = +7°

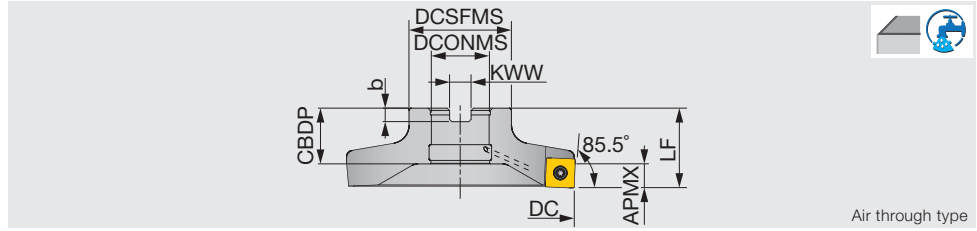
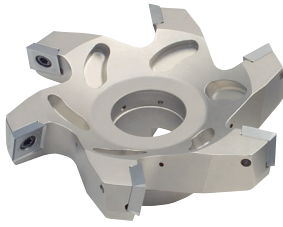

Inch	APMX	DC	CICT	DCSFMS	LF	DCONMS	CDBDP	KWW	b	WT (lb)	Air hole	Insert
TFE12300RU	0.315	3.000	4	1.970	1.380	1.000	0.964	0.375	0.236	0.880	With	SEG*12X4...
TFE12400RU	0.315	4.000	6	1.970	1.380	1.000	0.964	0.375	0.236	1.340	With	SEG*12X4...
Metric	APMX	DC	CICT	DCSFMS	LF	DCONMS	CDBDP	KWW	b	WT(kg)	Air hole	Insert
TFE12063R	8	63	3	45	35	22	19	10	6	0.34	With	SEG*12X4...
TFE12080R	8	80	4	50	35	25.4	24.5	9.5	6	0.45	With	SEG*12X4...
TFE12100R	8	100	6	50	35	25.4	24.5	9.5	6	0.59	With	SEG*12X4...
TFE12125R	8	125	6	50	35	25.4	24.5	9.5	6	0.9	With	SEG*12X4...

SPARE PARTS

Designation	Clamping screw	Lubricant	Shell locking bolt	Wrench
TFE12300RU, TFE12400RU	CSPB-4S	M-1000	TMBA-0.500H	IP-15D
TFE12063R	CSPB-4S	M-1000	CM10X30H	IP-15D
TFE12080R, TFE12100R, TFE12125R	CSPB-4S	M-1000	TMBA-M12H TMBA-0.500H	IP-15D

*Recommended clamping torque : CSPB-4S = 2.58 lbs·ft, 3.5 N·m

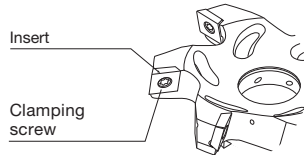

86° face endmill for aluminum machining, shank type, with screw clamp system, for positive square inserts

GAMP = +13°, GAMF = +7°

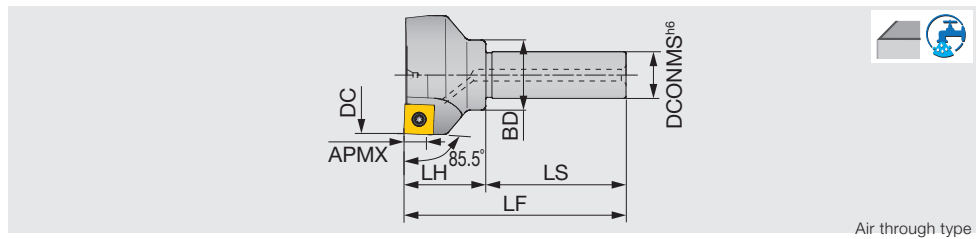

Inch	APMX	DC	CICT	DCONMS	BD	LS	LH	LF	WT (lb)	Air hole	Insert
EFE12200RU	0.315	2.000	3	0.750	1.180	2.362	1.375	3.406	0.77	With	SEG*12X4...

SPARE PARTS

Designation	Clamping screw	Lubricant	Wrench
EFE12000RU	CSPB-4S	M-1000	IP-15D

*Recommended clamping torque : CSPB-4S = 2.58 lbs·ft

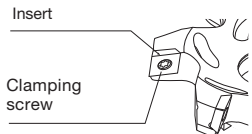

Reference pages: Inserts → **H083**, Standard cutting conditions → **H084**

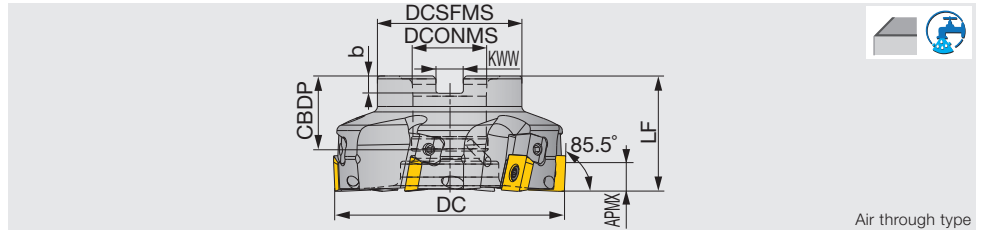

Metric	APMX	DC	CICT	DCSFMS	LF	DCONMS	CBDDP	KWW	b	WT(kg)	Air hole	Insert
TFE12R080M25.4-06A	8	80	6	50	40	25.4	26	9.5	6	0.70	With	SEG*12X4...
TFE12R080M27.0E06A	8	80	6	55	40	27	22	12.4	7	0.69	With	SEG*12X4...
TFE12R100M25.4-08A	8	100	8	50	40	25.4	26	9.5	6	1.15	With	SEG*12X4...
TFE12R100M27.0E08A	8	100	8	55	40	27	22	12.4	7	1.11	With	SEG*12X4...
TFE12R125M31.7-10A	8	125	10	70	50	31.7	32	12.7	8	2.24	With	SEG*12X4...
TFE12R125M32.0E10A	8	125	10	70	50	32	28.5	14.4	8	2.14	With	SEG*12X4...

SPARE PARTS

Designation	Clamping screw	Adjustable Wedge	Lubricant	Shell locking bolt	Right-left screw	Wrench	Wrench 1
TFE12R**A	CSTB-4	FW-701R	M-1000	TMBA-M12H TMBA-0.500H	MCS520-2.5	P-2.5T	T-15LB

*Recommended clamping torque : CSTB-4 = 3.5 N·m

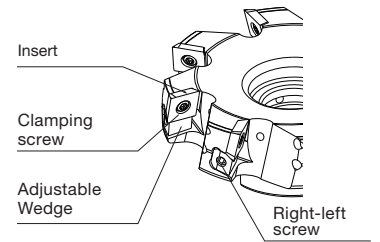

Insert setting procedure – adjustable-type TFE face milling cutter

1 Cleaning insert pockets

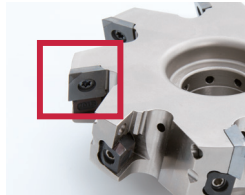

Remove all the inserts. Use air pressure to thoroughly clean the pockets of dust and chips.

2 Loosening wedges



Use the included key for wedge adjustment to loosen all the wedges so that they do not exceed the cutter's outer diameter.

3 Clamping inserts for adjustments

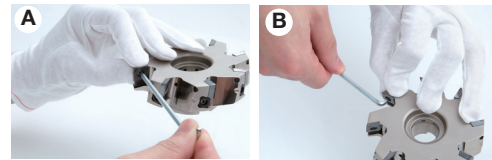

Place the insert in the pocket and lightly tighten the clamping screw with the included key. Suggested method: Tighten the screw first with the straight end of the key (Fig A) until finger tight, then use the angled end to further tighten the screw for insert steadiness (Fig B). Do NOT fully tighten the screw at this moment as this procedure is prior to insert adjustment. Repeat the procedure for all inserts.

4 Axial height adjustment of inserts



Mount the cutter in Step ③ on the setting fixture of the pre-setter. Determine the highest insert, and, while carefully monitoring each insert's axial position, rotate the wedge screw in the CW direction to raise the insert in the axial direction, as close as possible to that of the highest insert. Repeat this procedure for all inserts.

Note:
Since the insert is clamped, loosening the wedge screw will not bring down the insert. To lower insert height, both the insert and wedge screws need to be loosened. Start the adjusting procedure for this insert again from Step 1.

5 Tighten insert screws



Tighten the insert clamping screw at 3.5 Nm, using the key as shown to the left. Repeat the procedure for all inserts.

6 Final adjustments

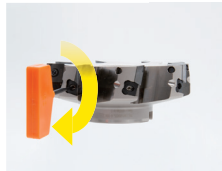

After final tightening of all insert screws, measure to ensure all inserts are at the desired axial heights. If necessary, further tighten any wedge screws in the CW direction for the final few microns. For inserts exceeding the required runout, re-start the adjustment procedure from Step ①.

Note:
Do not re-tighten the insert screw after insert adjustment is completed. Additional tightening may weaken wedge clamping torque.

Cautions:

- Always clean all the insert pockets thoroughly of dust and chips. Any objects present in the pocket may shift the insert's position during machining and cause poor surface finishing quality.
- Always loosen the wedge screw before installing the insert as described in Step ②. If the wedge is left tightened in the cutter, the adjustment range of the wedge will be limited, and insert height may not be as freely adjustable as possible.
- With a finger, firmly press and hold the insert into the wedge while tightening the insert screw. If the insert is not in contact, the wedge has to be driven until the gap in between is closed, with no actual insert movement.
- Loosening the wedge will not lower the insert. When the insert height exceeds the desired setting during adjustment, loosen both the insert and wedge screws and re-start the adjustment procedure from Step ①. If the insert slides downward when the wedge screw is loosened, the clamping torque of the insert screw is too low. Tighten the insert screw with a slightly higher torque. Suggested clamping method: First use the straight end of the key to tighten the screw until finger tight, then switch the key to the angled side and turn an additional 45°.
- Do not exceed the recommended clamping torque when fixing the insert. This may damage or fracture the insert screw.

INSERT

SEGW12X4ZEPR / ZEFR

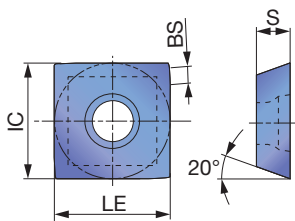

SEGT12X4-AJ

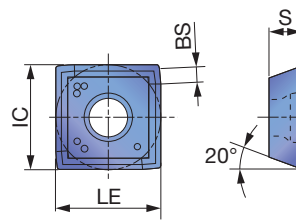

SEGW12X4ZEFR-D

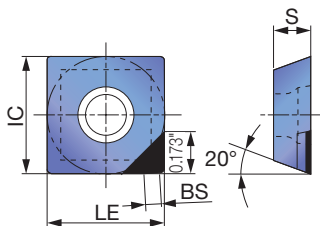

SEGW12X4ZEFR-WD

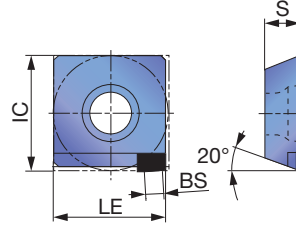

SEGW12X4ZEFR-BD

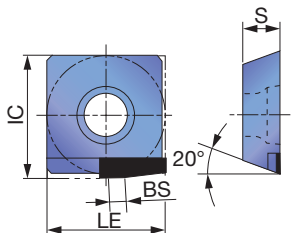

2QP-SECW12X412ZETR

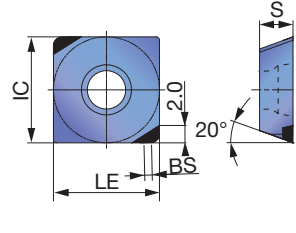

1QP-SECW12X4ZETR-W

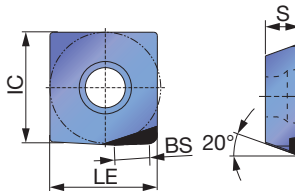

1QP-SECW12X4ZETR-B

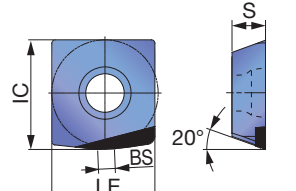

P Steel	★			★								
M Stainless		★										
K Cast iron	★						★					
N Non-ferrous			★		★	★						
S Superalloys												
H Hard materials												

★ : First choice

Designation	APMX	Coated		Cermet	Uncoated	PCD	CBN	IC	LE	S	BS
		AH120	AH140	DS1100	NS740	KS05F	DX140				
SEGW12X4ZEPR	0.315				●			0.500	0.500	0.157	0.071
SEGW12X4ZEPR	0.315	●	●	●				0.500	0.500	0.157	0.055
SEGT12X4ZEFR-AJ	0.315		●		●			0.500	0.500	0.157	0.071
SEGW12X4ZEFR-D	0.138					●		0.500	0.500	0.157	0.071
SEGW12X4ZEFR-WD	-					●		0.504	0.488	0.157	0.079
SEGW12X4ZEFR-BD	-					●		0.516	0.488	0.157	0.071
2QP-SECW12X412ZETR	0.059						●	0.500	0.500	0.157	0.035
1QP-SECW12X4ZETR-W	-						●	0.508	0.484	0.157	0.157
1QP-SECW12X4ZETR-B	-						●	0.516	0.484	0.157	0.079

● : Line up

DX140: 2 pieces per package
BX480: 1 piece per package



How to put each insert together

		For general	Accuracy of machining surface priority	Burr reduction priority
Applicable insert	General insert	SEGW12X4ZEFR-D DX140	◎	◎
		2QP-SECW12X412ZETR BX480	◎	◎
	Wiper insert	SEGW12X4ZEFR-WD DX140	—	◎
		1QP-SECW12X4ZETR-W BX480	—	—
	Wiper insert for burr reduction	SEGW12X4ZEFR-BD DX140	—	—
1QP-SECW12X4ZETR-B BX480		—	◎	
Number of Inserts by type		All general	1 or 2 wiper inserts in cutter body	General insert : Burr wiper insert = 1 : 1
Accuracy of machining surface (roughness and undulation)		△	◎	○
Burr of machining surface		△	○	◎

STANDARD CUTTING CONDITIONS

ISO	Workpiece material	Grade	Designation	Cutting speed Vc (sfm)	Feed per tooth fz (ipt)
P	Carbon steels and alloy steels < 300HB	AH120	SEGW12X4ZEPR	330 - 590	0.001 - 0.006
		NS740	SEGW12X4ZEPR	330 - 590	0.001 - 0.006
M	Stainless steels < 250HB	AH140	SEGW12X4ZEPR	260 - 590	0.001 - 0.006
K	Grey and ductile cast irons	AH120	SEGW12X4ZEPR	330 - 650	0.001 - 0.006
	Grey cast iron	BX480	2QP-SECW12X412ZETR	2625 - 4921	0.002 - 0.012
	Ductile cast irons	BX480	2QP-SECW12X412ZETR	1640 - 2625	0.002 - 0.008
N	Cast aluminum alloy / Die-cast Si < 13%	KS05F	SEGT12X4ZEFR-AJ	650 - 4900	0.001 - 0.008
		DX140	SEGW12X4ZEFR-D	650 - 4900	0.001 - 0.008
	Cast aluminum alloy / Die-cast Si ≥ 13%	KS05F	SEGT12X4ZEFR-AJ	260 - 650	0.001 - 0.008
		DX140	SEGW12X4ZEFR-D	650 - 1650	0.001 - 0.008
	Aluminum alloy (JIS 1000, 3000, 5000 and 6000 types) Tensile strength < 350 N/mm ²	KS05F	SEGT12X4ZEFR-AJ	650 - 4900	0.001 - 0.008
		DX140	SEGW12X4ZEFR-D	650 - 4900	0.001 - 0.008
	Aluminum alloy (JIS 2000, 4000, and 7000 types) Tensile strength > 350 N/mm ²	KS05F	SEGW12X4ZEFR	650 - 4900	0.001 - 0.008
		DX140	SEGW12X4ZEFR-D	650 - 4900	0.001 - 0.008
Copper alloy	KS05F	SEGT12X4ZEFR-AJ	650 - 1640	0.001 - 0.008	
	DX140	SEGW12X4ZEFR-D	650 - 1640	0.001 - 0.008	

Notes:

- In milling aluminum and copper alloys:
 - For improved surface finish, use together with wiper insert SEGW12X4ZEFR-WD
 - For reducing burr occurrence, use together with deburring inserts SEGW12X4ZEFR-BD

- When milling aluminum and copper alloys, use of a water soluble cutting fluid is recommended. When milling steels, cast irons, and stainless steels, dry cutting is recommended.
- When the length-to-diameter overhang ratio of the tool (L/D) exceeds 3, reduce cutting speed and feed to 70 to 80% of the values given in the table.

Light weight mill for aluminum machining, for PCD inserts

GAMP = +8.5°, GAMF = +3° ~ +5°

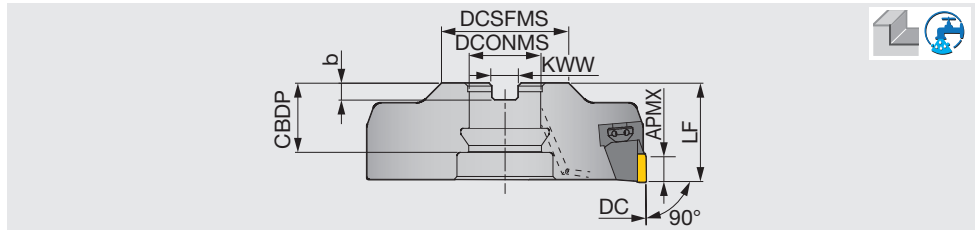

Metric	APMX	DC	CICT	DCSFMS	LF	DCONMS	CBBDP	KWW	b	WT(kg)	Air hole	Insert
DPD09080R	7	80	4	50	41	25.4	23	9.5	6	0.8	With	YDEN0905...
DPD09080RB	7	80	6	50	41	25.4	28.5	9.5	6	0.82	With	YDEN0905...
DPD09100R	7	100	6	50	35	25.4	24.5	9.5	6	1.13	With	YDEN0905...
DPD09100RB	7	100	8	50	35	25.4	24.5	9.5	6	1.17	With	YDEN0905...
DPD09125R	7	125	6	50	35	25.4	24.5	9.5	6	1.7	With	YDEN0905...
DPD09125RB	7	125	10	50	35	25.4	24.5	9.5	6	1.77	With	YDEN0905...
DPD09160R	7	160	8	60	52	31.75	40	12.7	8	3.28	With	YDEN0905...
DPD09160RB	7	160	12	60	52	31.75	40	12.7	8	3.25	With	YDEN0905...

SPARE PARTS

Designation	① Clamping screw	② Wedge fixing screw	③ Adjusting screw	④ Helisert	Shell locking bolt 1	Shell locking bolt 2	Wrench1	Wrench 2
DPD09080R*	FW-304R-T	FDS-8ST-18	AJM5	LM5-0.8X1DNS	-	CM12X30H	T-27T	T-7F
DPD09100R*	FW-304R-T	FDS-8ST-18	AJM5	LM5-0.8X1DNS	TMBA-0.500H	-	T-27T	T-7F
DPD09125R*	FW-304R-T	FDS-8ST-18	AJM5	LM5-0.8X1DNS	TMBA-0.500H	-	T-27T	T-7F
DPD09160R*	FW-304R-T	FDS-8ST-18	AJM5	LM5-0.8X1DNS	TMBA-M16H	-	T-27T	T-7F

*Recommended clamping torque : FDS-8ST-18 = 10 N·m

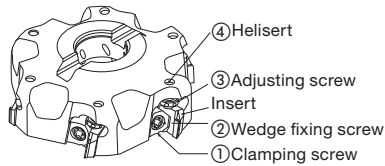

Light weight endmill for aluminum machining, shank type, for PCD inserts

GAMP = +8.5°, GAMF = +3°

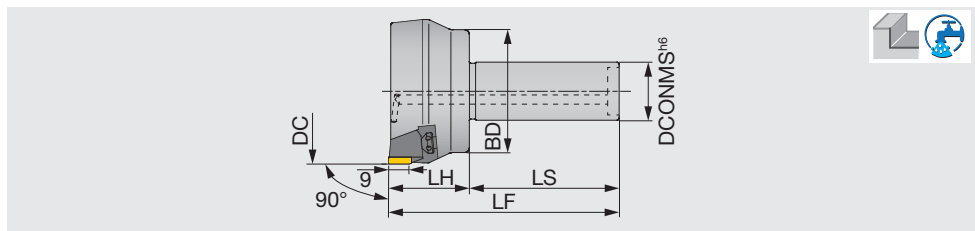

Metric	APMX	DC	CICT	DCONMS	BD	LS	LH	LF	WT(kg)	Air hole	Insert
EDPD09063R	7	63	3	25	37	60	40	100	0.75	With	YDEN0905...

SPARE PARTS

Designation	① Clamping screw	② Wedge fixing screw	③ Adjusting screw	④ Helisert	Wrench1	Wrench 2
EDPD09063R	FW-304R-T	FDS-8SST	AJM5	LM5-0.8X1DNS	T-27T	T-7F

*Recommended clamping torque : FDS-8SST = 10 N·m

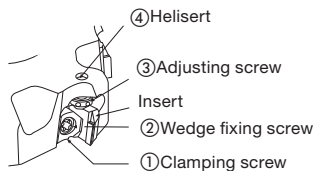

Reference pages: Inserts, Standard cutting conditions → **H086**

INSERT

YDEN0905PDFR-D

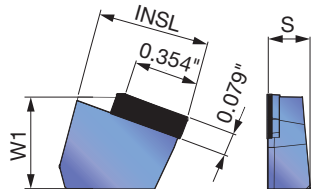

YDEN0905PDFR-WD

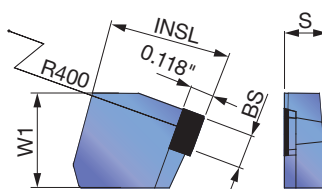

YDEN0905PDFR-BD

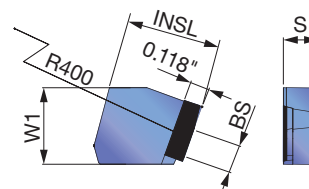

P	Steel								
M	Stainless								
K	Cast iron								
N	Non-ferrous	★							
S	Superalloys								
H	Hard materials								

★ : First choice
☆ : Second choice

Designation	APMX	PCD								W1	INSL	S	BS
		DX140											
YDEN0905PDFR-D	0.276	●								0.488	0.594	0.224	-
YDEN0905PDFR-WD	-	●								0.488	0.598	0.224	0.177
YDEN0905PDFR-BD	-	●								0.488	0.598	0.224	0.177

Tungaloy provides refurbishing service for these inserts upon request.

● : Line up
1 piece per package

STANDARD CUTTING CONDITIONS

ISO	Workpiece material	Grade	Designation	Cutting speed Vc (sfm)	Feed per tooth fz (ipt)
N	Aluminum alloy castings & die castings Si < 13%	DX140	YDEN0905PDFR-D	500 ~ 4000	0.001 ~ 0.008
	Aluminum alloy castings & die castings Si ≥ 13%	DX140	YDEN0905PDFR-D	650 ~ 1650	0.001 ~ 0.008
	Rolled aluminum alloys	DX140	YDEN0905PDFR-D	1650 ~ 13000	0.001 ~ 0.008
	Copper alloys	DX140	YDEN0905PDFR-D	300 ~ 1650	0.001 ~ 0.008

Notes:

- When requiring improved surface finish, use the wiper insert together with regular inserts YDEN0905PDFR-WD.
- When requiring reduced burr occurrence, use the deburring inserts together with regular inserts YDEN0905PDFR-BD.
- When using the cutter at speeds over 1500m/min, use an arbor or tool-holder balanced to within G16.
- Wet cutting, using a water soluble cutting fluid, is recommended.
- When the length-to-diameter overhang ratio of the tool (L/D) exceeds 3, reduce cutting speed and feed to 70 to 80% of the values given in the table.

How to put each insert together

		For general	Accuracy of machining surface priority	Burr reduction priority
Applicable insert	General insert YDEN0905PDFR-D	◎	◎	◎
	Wiper insert YDEN0905PDFR-WD	-	◎	-
	Wiper insert for burr reduction YDEN0905PDFR-BD	-	-	◎
Number of Inserts by type		All general	1 or 2 wiper inserts in cutter body	General insert : Burr wiper insert = 1 : 1
Specification of insert setting				
Accuracy of machining surface (roughness and undulation)		△	◎	○
Burr of machining surface		△	○	◎

TMD4400RI-U

45° face mill, with wedge clamp system, for positive square inserts

GAMP = +15°, GAMF = -3°

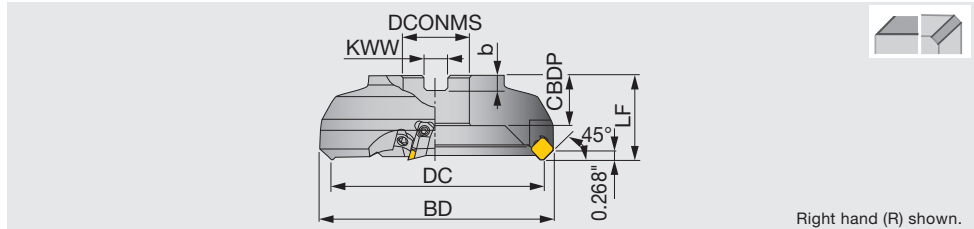

Inch	APMX	DC	CICT	BD	LF	DCONMS	CBDP	KWW	b	WT (lb)	Insert
TMD4403RI-U	0.157	3.150	4	3.780	1.970	1.000	1.020	0.375	0.236	3.100	SD*N42.../SD*R1203...
TMD4404RI-U	0.157	3.940	5	4.530	2.480	1.500	1.260	0.500	0.315	5.500	SD*N42.../SD*R1203...
TMD4405RI-U	0.157	4.920	6	5.470	2.480	1.500	1.500	0.625	0.394	7.900	SD*N42.../SD*R1203...
TMD4406RI-U	0.157	6.300	8	6.510	2.480	2.000	1.500	0.750	0.433	12.300	SD*N42.../SD*R1203...
TMD4408RI-U	0.157	7.870	10	8.390	2.480	2.500	1.500	1.000	0.551	19.100	SD*N42.../SD*R1203...
TMD4410RI-U	0.157	9.840	12	10.350	2.480	2.500	1.500	1.000	0.551	35.900	SD*N42.../SD*R1203...
TMD4412RI-U	0.157	12.400	14	12.870	2.480	2.500	1.500	1.000	0.551	55.400	SD*N42.../SD*R1203...

Arbor type

TMD4408/10RI-U

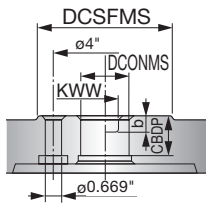

TMD4412RI-U

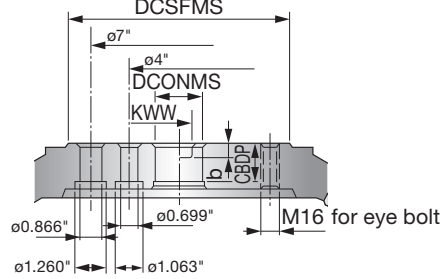

SPARE PARTS

Designation	① Locator	④ Wedge fixing screw	② Locator fixing screw	③ Wedge	Wrench	Shell locking bolt (Optional parts)
TMD4403RI-U	LD440R	FDS-8S	CM4X0.7X14	WP440R	TP-4	(TMBA-0.500H)
TMD4404..., TMD4405...	LD440R	FDS-8S	CM4X0.7X14	WP440R	TP-4	(TMBA-0.750H)
TMD4406..., TMD4408... TMD4410..., TMD4412...	LD440R	FDS-8S	CM4X0.7X14	WP440R	TP-4	-

*Recommended clamping torque : FDS-8S = 5.9 lbs·ft

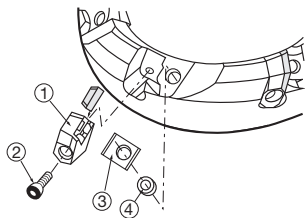

INSERT

SDCN/SDEN/SDKN 42Z

Regular edge
SD*N42Z*N

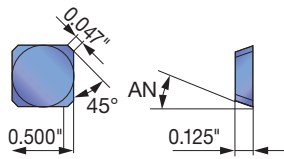

Details of edge
SDKN42ZTN16

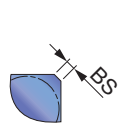

SD*N42ZTN20

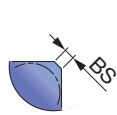

SDKN42ZTNCR
SDEN42ZTNCR



SDCN42ZFN-DIA

SDCN42ZFN-DIA

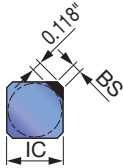

SDKR42Z-MJ

SDKR42ZSR-MJ
with 3-dimensional chipbreaker

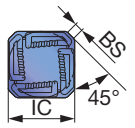

Details of edge

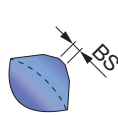

SDMR/SDKR 1203-MJ

SD*R1203AETN-MJ
with 3-dimensional chipbreaker

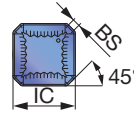

Details of edge

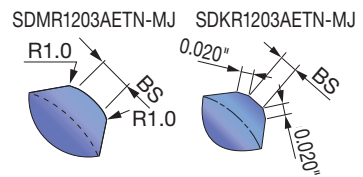

SDKR42Z-MS

SDKR42ZPN-MS

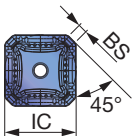

Details of edge

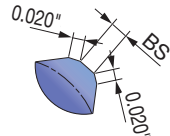

WDCN42ZFR-DIA

Wiper edge
WDCN42ZFR-DIA

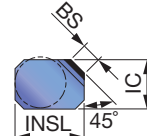

	P	M	K	N	S	H															
Steel	★	★								☆	☆				☆	☆	★	☆	☆		
Stainless	★		★	☆											☆						
Cast iron			★							☆	★										
Non-ferrous																			★		★
Superalloys		★	☆																		
Hard materials																					

★ : First choice
☆ : Second choice

Designation	APMX	Coated											Cermet		Uncoated		PCD	IC	INSL	S	AN	BS				
		AH3135	AH120	AH130	AH140	AH330	GH330	T1115	T1215	T3130	T3225	NS740	N308	UX30	TH10	DX140										
SDCN42ZFN	0.157																					0.500	-	0.125	15°	0.047
SDCN42ZTN	0.157																					0.500	-	0.125	15°	0.047
SDCN42ZTN20	0.157																					0.500	-	0.125	15°	0.079
SDEN42ZFN	0.157																					0.500	-	0.125	15°	0.047
SDEN42ZTN	0.157	●	●		●		●	●	●						●	●					●	0.500	-	0.125	15°	0.047
SDEN42ZTNCR	0.157	●	●		●		●								●							0.500	-	0.125	15°	0.063
SDEN42ZTN20	0.157																					0.500	-	0.125	15°	0.079
SDKN42ZFN	0.157																					0.500	-	0.125	15°	0.047
SDKN42ZTN	0.157	●	●	●	●	●	●	●	●						●	●					●	0.500	-	0.125	15°	0.047
SDKN42ZTNCR	0.157																					0.500	-	0.125	15°	0.063
SDKN42ZTN16	0.157																					0.500	-	0.125	15°	0.063
SDCN42ZFN-DIA	0.079																					0.500	-	0.125	15°	0.047
SDKR42ZSR-MJ	0.157	●	●			●	●															0.500	-	0.125	15°	0.063
SDMR1203AETN-MJ	0.157																					0.500	-	0.125	15°	0.063
SDKR1203AETN-MJ	0.157																					0.500	-	0.125	15°	0.063
SDKR42ZPN-MS	0.157	●		●	●																	0.500	-	0.125	15°	0.063
WDCN42ZFR-DIA	0.020																				●	0.480	0.616	0.125	15°	0.193

● : Line up

DX140: 1 piece per package

STANDARD CUTTING CONDITIONS

ISO	Workpiece material	Grade	Roughing (Depth of cut: APMX 0.059" ~ 0.157")		Finishing (Depth of cut: APMX 0.012 ~ 0.028")	
			Cutting speed Vc (sfm)	Feed per tooth fz (ipt)	Cutting speed Vc (sfm)	Feed per tooth fz (ipt)
P	Mild steels Unhardened steels < 180 HB	NS740	492 ~ 820	0.004 ~ 0.008	492 ~ 820	0.004 ~ 0.010
		T3225	492 ~ 1148	0.004 ~ 0.010	492 ~ 1148	0.004 ~ 0.011
		AH3135	492 ~ 984	0.004 ~ 0.007	591 ~ 984	0.004 ~ 0.012
	Carbon steels Alloy steels < 300 HB	NS740	328 ~ 591	0.004 ~ 0.007	492 ~ 656	0.004 ~ 0.009
		T3225	328 ~ 1050	0.004 ~ 0.009	492 ~ 1050	0.004 ~ 0.010
		AH3135	328 ~ 656	0.004 ~ 0.010	492 ~ 656	0.004 ~ 0.012
	Die steels < 30 HRC	AH3135	328 ~ 492	0.004 ~ 0.006	328 ~ 492	0.004 ~ 0.008
		T3225	328 ~ 820	0.004 ~ 0.006	328 ~ 820	0.004 ~ 0.008
M	Stainless steels < 250 HB	AH3135	262 ~ 591	0.006 ~ 0.010	328 ~ 656	0.006 ~ 0.011
		T3225	492 ~ 230	0.006 ~ 0.009	656 ~ 820	0.006 ~ 0.010
K	Cast irons Ductile cast irons	T1215	328 ~ 820	0.004 ~ 0.008	328 ~ 820	0.004 ~ 0.010
		AH120	328 ~ 656	0.004 ~ 0.010	328 ~ 656	0.004 ~ 0.012
S	Titanium alloys Ti-6Al-4V, etc.	AH130	98 ~ 197	0.004 ~ 0.008	98 ~ 197	0.004 ~ 0.008
	Superalloys Inconel718, etc.	AH120	33 ~ 131	0.002 ~ 0.006	33 ~ 131	0.002 ~ 0.004
N	Aluminum alloys Si < 13%	TH10	656 ~ 3280	0.002 ~ 0.008	1148 ~ 3280	0.004 ~ 0.012
		DX140	656 ~ 3280	0.002 ~ 0.007	1148 ~ 3280	0.004 ~ 0.008
	Copper alloy	TH10	656 ~ 1640	0.004 ~ 0.008	656 ~ 1640	0.004 ~ 0.010

The above are the values for dry cutting of all materials except aluminum alloy.
Maximum depth of cut for DX140 SDCN42ZFN-DIA is 0.079".

Grade
Insert
Ext. Toolholder
Int. Toolholder
Threading
Grooving
Miniature Tool
Milling Cutter
Endmill
Drilling Tool
Tooling System
User's Guide
Index



- High Feed Milling
- Face Milling
- Shoulder Milling
- Slot Milling
- Profile Milling
- Thread Milling
- Other
- Approach angle
- 10-20°
- 45°
- 70°
- 85°
- 88°
- 90°
- Others

TMD5400RI

45° face mill, with wedge clamp system, for positive square inserts

GAMP = +15°, GAMF = -3°

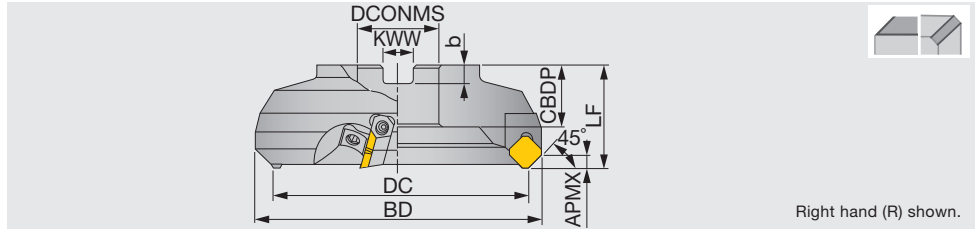
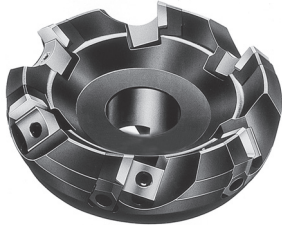

Right hand (R) shown.

Inch	APMX	DC	CICT	BD	LF	DCONMS	CBDP	KWW	b	WT(lb)	Insert
TMD5404RI-U	0.236	3.940	4	4.650	2.480	1.500	1.260	0.625	0.394	5.510	SD*N53Z...
TMD5405RI-U	0.236	4.920	5	5.590	2.480	1.500	1.500	0.625	0.394	8.160	SD*N53Z...
TMD5406RI-U	0.236	6.300	5	6.930	2.480	2.000	1.500	0.750	0.433	12.790	SD*N53Z...
TMD5408RI-U	0.236	7.870	8	8.500	2.480	2.500	1.500	1.000	0.551	19.840	SD*N53Z...
TMD5410RI-U	0.236	9.840	10	10.430	2.480	2.500	1.500	1.000	0.551	35.930	SD*N53Z...
TMD5412RI-U	0.236	12.400	12	12.990	2.480	2.500	1.500	1.000	0.551	55.560	SD*N53Z...

Arbor type

TMD5408RI-U...,
TMD5410RI-U...

TMD5412RI-U

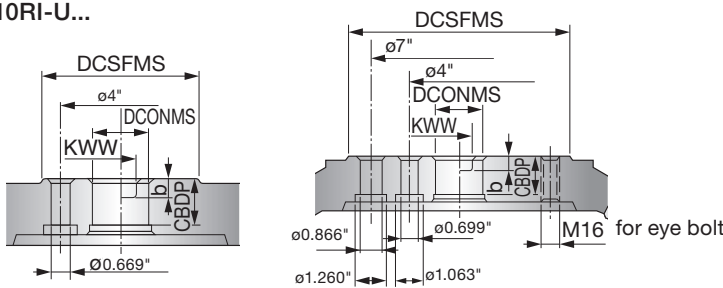

SPARE PARTS

Designation	① Locator	④ Wedge fixing screw	② Locator fixing screw	③ Wedge	Wrench	Shell locking bolt (Optional parts)
TMD5404..., TMD5405...	LD540R	FDS-8S	CM4X0.7X20	WF500R	TP-4	(TMBA-0.750H)
TMD5406..., TMD5408..., TMD5410..., TMD5412...	LD540R	FDS-8S	CM4X0.7X20	WF500R	TP-4	-

*Recommended clamping torque : FDS-8S = 5.9 lbs·ft

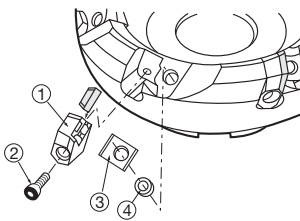

Reference pages: Inserts, Standard cutting conditions → **H091**

INSERT

SDCN/SDEN 53Z

SD*N53Z*N

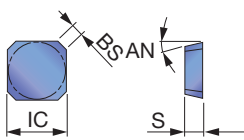

SDEN53ZTN20
Details of edge

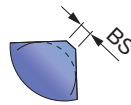

SDKN53ZTN16
Details of edge

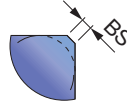

SDEN53ZTNCR
Details of edge

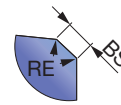

SDKN53ZTNCR
Details of edge

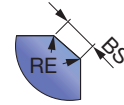

SDKR53-MJ

SDKR53ZSR-MJ
with 3-dimensional chipbreaker

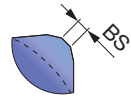
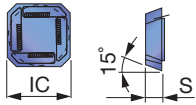

Designation	APMX	Coated					Cermet		Uncoated		IC	S	AN	BS
		AH120	AH130	AH140	GH330	T3130	NS740	N308	UX30	TH10				
SDCN53ZTN	0.236						★	★	☆	☆				
SDEN53ZFN	0.236		★	☆	☆									
SDEN53ZTN	0.236				●		●	●						
SDEN53ZTNCR	0.236						●							
SDEN53ZTN20	0.236					●								
SDKN53ZFN	0.236							●						
SDKN53ZTN	0.236	●	●	●	●		●	●	●					
SDKN53ZTNCR	0.236						●							
SDKN53ZTN16	0.236					●								
SDKR53ZSR-MJ	0.236				●	●								

★ : First choice
☆ : Second choice

● : Line up

STANDARD CUTTING CONDITIONS

Roughing (Depth of cut: APMX 0.059" ~ 0.236") Finishing (Depth of cut: APMX 0.012" ~ 0.028")

ISO	Workpiece material	Grade	Cutting speed Vc (sfm)	Feed per tooth fz (ipt)	Cutting speed Vc (sfm)	Feed per tooth fz (ipt)
P	Mild steels Unhardened steels < 180 HB	NS740	492 ~ 820	0.004 ~ 0.010	492 ~ 820	0.004 ~ 0.012
		AH120	492 ~ 820	0.004 ~ 0.014	492 ~ 820	0.004 ~ 0.014
		T3130	492 ~ 984	0.004 ~ 0.014	591 ~ 984	0.004 ~ 0.014
		AH130	328 ~ 591	0.004 ~ 0.014	427 ~ 656	0.004 ~ 0.014
	Carbon steels Alloy steels < 300 HB	T3130	492 ~ 919	0.004 ~ 0.014	591 ~ 919	0.004 ~ 0.014
		NS740	328 ~ 591	0.004 ~ 0.010	492 ~ 656	0.004 ~ 0.012
		AH120	328 ~ 656	0.004 ~ 0.012	492 ~ 656	0.004 ~ 0.014
Die steels < 30 HRC	T3130 · AH120	328 ~ 492	0.004 ~ 0.008	328 ~ 492	0.004 ~ 0.008	
M	Stainless steels < 250 HB	AH130 · AH140	262 ~ 591	0.006 ~ 0.012	328 ~ 656	0.006 ~ 0.013
		GH330	492 ~ 755	0.006 ~ 0.012	656 ~ 820	0.006 ~ 0.012
K	Cast irons Ductile cast irons	AH120	328 ~ 656	0.004 ~ 0.012	328 ~ 656	0.004 ~ 0.012
N	Aluminum alloys Si < 13%	TH10	656 ~ 3281	0.002 ~ 0.012	1148 ~ 3281	0.004 ~ 0.012
	Copper alloy	TH10	656 ~ 1640	0.004 ~ 0.008	656 ~ 1640	0.004 ~ 0.010

The above are the values for dry cutting of all materials except aluminum alloy.

Grade
Insert
Toolholder
Ext. Toolholder
Int. Toolholder
Threading
Grooving
Miniature Tool
Milling Cutter
Endmill
Drilling Tool
Tooling System
User's Guide
Index





High precision shoulder mill series with economical double-sided triangular inserts

Innovative insert

- Highly economical 6-corner double sided inserts.
- Long effective cutting edge allows shoulder milling with large depth of cut.
- Low cutting force at low depth of cut, and high machining stability at large depth of cut.
 - Concave cutting edge and large rake angle produce barrel-shape chips, resulting in excellent chip evacuation.
 - The design with wiper edge (front cutting edge) is also suitable for face milling.

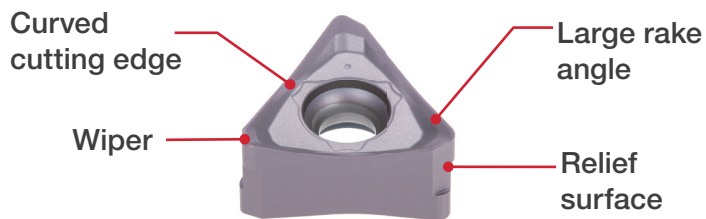

Comparison of surface roughness

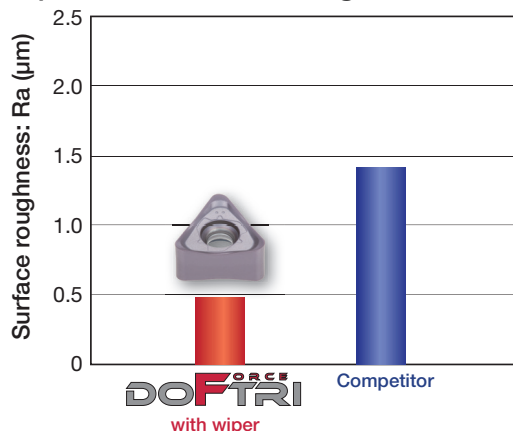

Reference pages: [H094](#) - [H096](#)



Excellent cutting performance with improved profitability

- Economical 3 cutting-edge inserts
- Drastically reduced cutting force

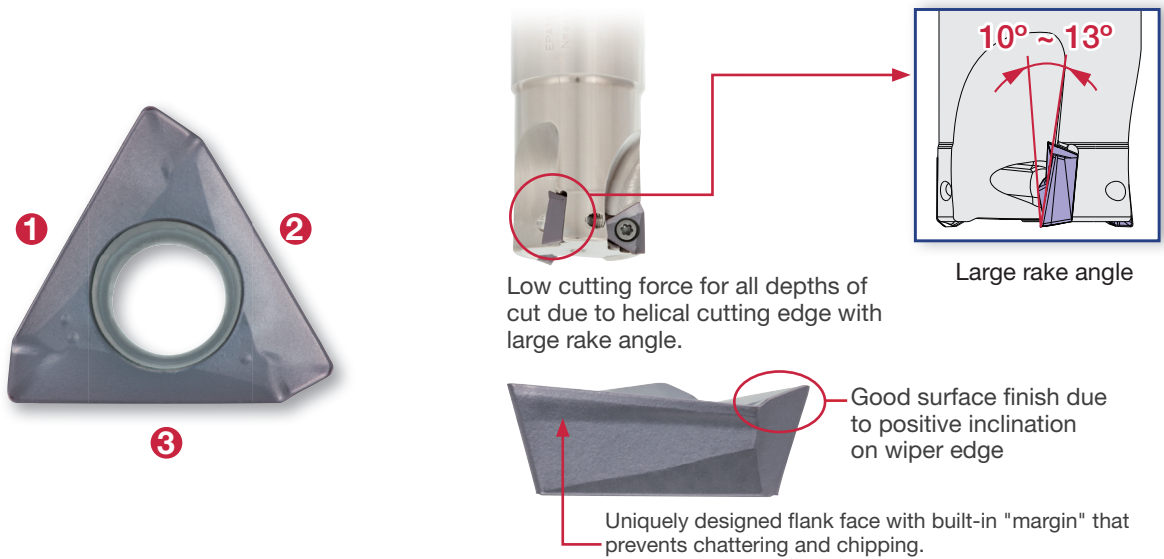

Applicable for a wide range of cutting conditions

Insert positioning in irregular pitch, combined with uniquely designed flank face of inserts, prevents chattering during machining.

■ Cutting performance

ap (in)	0.400	OK	0.002	0.004	0.006	0.008	0.010
	0.360						
	0.320						
	0.280						
	0.240						
	0.200						
	0.160						
	0.120						
	0.080						
	0.040						
Applicable area	fz (ipt)						

ap (in)	0.400	OK	0.002	0.004	0.006	0.008	0.010
	0.360						
	0.320						
	0.280						
	0.240						
	0.200						
	0.160						
	0.120						
	0.080						
	0.040						
Applicable area	fz (ipt)						

Competitor

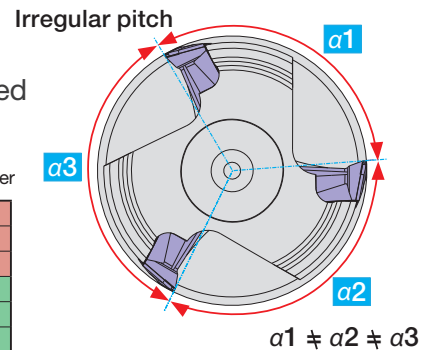

Cutter : EPA10R125U0125W03N (DC = 1.250", CICT = 3)

Insert : TOMT100404PDER-MJ

Grade : AH3135

Workpiece : 1055 (200 HB)

Cutting speed : Vc = 500 sfm

Width of cut : ae = 1.250"

Machine : Vertical M/C, BT50

Square shoulder milling cutter with double-sided triangular inserts

GAMP = +4.2°~ +4.7°, GAMF = -15.4°~ -11.2°

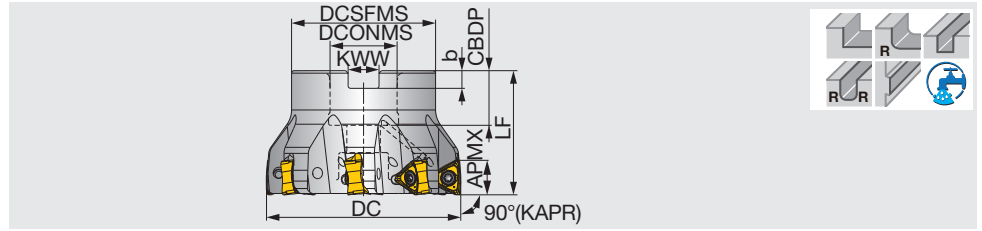

Inch	APMX	DC	CICT	DCSFMS	LF ⁽¹⁾	DCONMS	CBDP	KWW	b	WT(kg)	Air hole	Insert
TPTN07U2.00B0.75R08	0.256	2.000	8	1.850	1.575	0.750	0.750	0.315	0.197	0.930	With	TNNU0703...

(1) The value is true with R0.8 insert. For R0.4, please refer to page H094

SPARE PARTS

Designation	Clamping screw	Wrench	Lubricant	Shell locking bolt (Optional parts)
TPTN07U2.00B0.75R0	CSPB-2.5SH	IP-7D	M-1000	(C0.375X1.125H)

* Torque (lb-ft): CSPB-2.5SH = 0.81 lb-ft

Square shoulder mill, with screw clamp system, for double sided triangular inserts

GAMP = +4.2°~ +4.7°, GAMF = -15.4°~ -11.2°

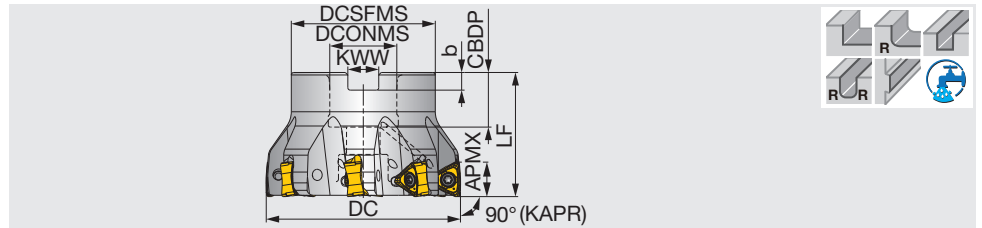

Inch	APMX	DC	CICT	DCSFMS	LF	DCONMS	CBDP	KWW	b	WT(lb)	Air hole	Shell locking bolt	Insert	Arbor type
TPTN12U2.00B0.75R05	0.433	2.000	5	1.850	1.575	0.750	0.750	0.315	0.197	0.89	With	C0.375X1.125H	TN*U12...	A
TPTN12U2.50B0.75R06	0.433	2.500	6	1.850	1.575	0.750	0.750	0.315	0.197	1.33	With	C0.375X1.125H	TN*U12...	A
TPTN12U3.00B1.00R08	0.433	3.000	8	2.835	1.969	1.000	1.024	0.374	0.236	2.44	With	C0.500X1.375H	TN*U12...	A
TPTN12U4.00B1.50R10	0.433	4.000	10	3.150	1.969	1.500	1.181	0.626	0.394	3.11	With	TMBA-0.750H	TN*U12...	B
TPTN12U5.00B1.50R12	0.433	5.000	12	3.150	2.480	1.500	1.181	0.626	0.394	5.33	With	TMBA-0.750H	TN*U12...	B
TPTN12U6.00B2.00R12N	0.433	6.000	12	3.858	2.48	2.000	1.496	0.748	0.433	8.82	Without	-	TN*U12...	B

SPARE PARTS

Designation	Clamping screw	Grip	Torx bit	Lubricant	Shell locking bolt (Optional parts)
TPTN12U2.00R..., TPTN12U2.50R...	CSPB-3.5	H-TB2W	BLDIP15/S7	M-1000	(C0.375X1.125H)
TPTN12U3.00R...	CSPB-3.5	H-TB2W	BLDIP15/S7	M-1000	(C0.500X1.375H)
TPTN12U4.00R..., TPTN12U5.00R...	CSPB-3.5	H-TB2W	BLDIP15/S7	M-1000	(TMBA-0.750H)
TPTN12U6.00R...	CSPB-3.5	H-TB2W	BLDIP15/S7	M-1000	-

*Recommended clamping torque : CSPB-3.5 = 2.58 lbs·ft

Arbor type

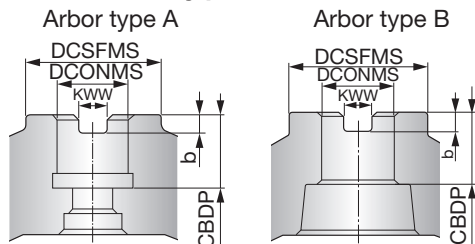

Reference pages: Inserts, Standard cutting conditions → H096

Square shoulder end mill with double-sided triangular inserts

GAMP = +4.2°~ +4.7°, GAMF = -15.4°~ -11.2°

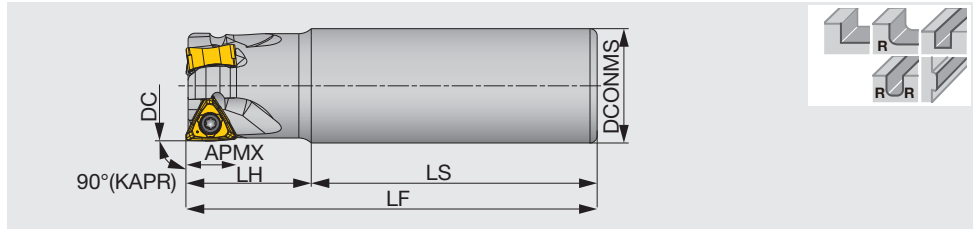

Inch	APMX	DC	CICT	DCONMS	LS	LH	LF ⁽¹⁾	WT(kg)	Air hole	Insert
EPTN07U0.75C0.75R02	0.256	0.750	2	0.750	2.500	1.000	3.500	0.370	With	TNNU0703..
EPTN07U0.75C0.75R02L	0.256	0.750	2	0.750	4.750	1.670	6.420	0.710	With	TNNU0703..
EPTN07U1.00C1.00R03	0.256	1.000	3	1.000	3.000	1.500	4.500	0.880	With	TNNU0703..
EPTN07U1.00C1.00R03L	0.256	1.000	3	1.000	5.700	3.000	8.700	1.720	With	TNNU0703..
EPTN07U1.00C1.00R04	0.256	1.000	4	1.000	3.000	1.500	4.500	0.880	With	TNNU0703..
EPTN07U1.25C1.25R04	0.256	1.250	4	1.250	3.000	1.500	4.500	1.390	With	TNNU0703..
EPTN07U1.25C1.25R05	0.256	1.250	5	1.250	3.000	1.500	4.500	1.390	With	TNNU0703..

(1) The value is true with R0.8 insert. For R0.4, please refer to page H094

SPARE PARTS



Designation	Clamping screw	Wrench
EPTN07...	CSPB-2.5SH	IP-7D

*Recommended clamping torque : CSPB-2.5SH = 0.81 lbs·ft

Square shoulder endmill, shank type, with screw clamp system, for double sided triangular inserts

GAMP = +4.2°~ +4.7°, GAMF = -15.4°~ -11.2°

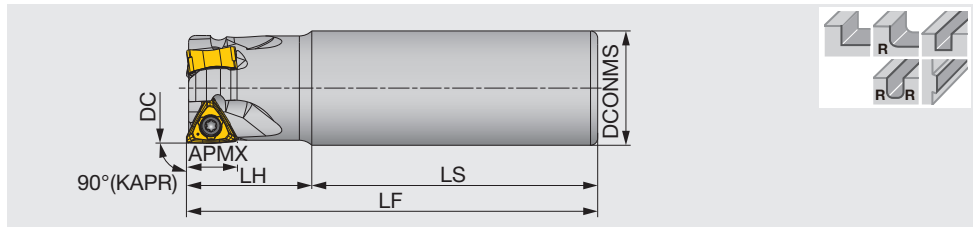

Inch	APMX	DC	CICT	DCONMS	LS	LH	LF	WT(lb)	Air hole	Insert
EPTN12U1.25C1.25R03N	0.433	1.250	3	1.250	3.000	1.500	4.500	1.560	Without	TN*U12...
EPTN12U1.50C1.25R04N	0.433	1.500	4	1.250	3.000	1.500	4.500	1.780	Without	TN*U12...

SPARE PARTS



Designation	Clamping screw	Grip	Torx bit	Lubricant
EPTN12...	CSPB-3.5	H-TB2W	BLDIP15/S7	M-1000

*Recommended clamping torque : CSPB-3.5 = 2.58 lbs·ft



INSERT

TNMU07-MJ

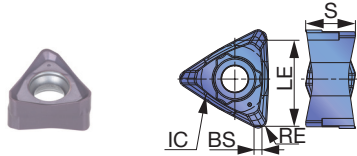

TNGU12-MJ/TNMU12-MJ

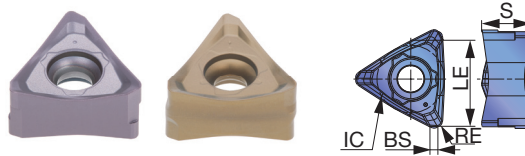

TNMU12-NMJ

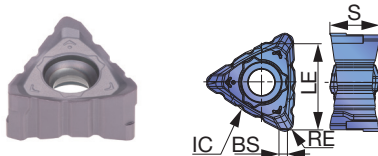

TNMU12**R-MJ

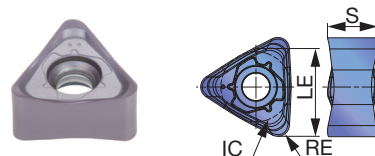

P Steel	☆	★		☆
M Stainless		★		☆
K Cast iron	★		☆	
N Non-ferrous				
S Superalloys	★	☆		
H Hard materials				

★: First choice
☆: Second choice

Designation	RE	APMX	Coated				LE	IC	S	BS
			AH120	AH3135	T1215	T3225				
TNMU070304PER-MJ	0.016	0.256	●	●			0.256	0.224	0.161	0.024
TNMU070308PER-MJ	0.032	0.256	●	●			0.256	0.224	0.161	0.024
TNGU120708PER-MJ	0.032	0.433	●	●	●		0.472	0.375	0.277	0.046
TNMU120708PER-MJ	0.032	0.433	●	●	●	●	0.472	0.375	0.280	0.046
TNMU120708PER-NMJ	0.032	0.433	●	●			0.472	0.375	0.280	0.046
TNMU1207R16PER-MJ	0.063	0.433	●	●			0.472	0.375	0.271	-

● : Line up

STANDARD CUTTING CONDITIONS

ISO	Workpiece materials	Hardness	Priority	Grades	Chip-breaker	Cutting speed Vc (sfm)	Feed per tooth fz (ipt)
P	Low carbon steel 1018, 1026, etc.	- 300 HB	First choice	AH3135	MJ	328 - 820	0.003 - 0.012
		- 300 HB	Wear resistance	T3225	MJ	328 - 984	0.003 - 0.012
	Carbon steel and alloy steel 1055, 4140, etc.	- 300 HB	Low cutting force	AH3135	NMJ	328 - 820	0.003 - 0.006
		- 300 HB	First choice	AH3135	MJ	328 - 755	0.003 - 0.012
		- 300 HB	Wear resistance	T3225	MJ	328 - 919	0.003 - 0.012
		- 300 HB	Low cutting force	AH3135	NMJ	328 - 919	0.003 - 0.006
Prehardened steel H-13, P-20, etc.	30 - 40 HRC	First choice	AH3135	MJ	328 - 591	0.003 - 0.010	
	30 - 40 HRC	Wear resistance	T3225	MJ	328 - 656	0.003 - 0.010	
	30 - 40 HRC	Low cutting force	AH3135	NMJ	328 - 591	0.003 - 0.006	
M	Stainless steel 304, 316, etc.	-	First choice	AH3135	MJ	295 - 656	0.003 - 0.010
		-	Wear resistance	T3225	MJ	295 - 820	0.003 - 0.010
		-	Low cutting force	AH3135	NMJ	295 - 656	0.003 - 0.006
K	Gray cast iron Class 25, Class 30, etc.	150 - 250 HB	First choice	AH120	MJ	459 - 820	0.003 - 0.012
		150 - 250 HB	Wear resistance	T1215	MJ	459 - 984	0.003 - 0.012
		150 - 250 HB	Low cutting force	AH120	NMJ	459 - 820	0.003 - 0.006
	Ductile cast iron 60-40-18, 80-55-06, etc.	150 - 250 HB	First choice	AH120	MJ	361 - 656	0.003 - 0.010
		150 - 250 HB	Wear resistance	T1215	MJ	361 - 820	0.003 - 0.010
		150 - 250 HB	Low cutting force	AH120	NMJ	361 - 656	0.003 - 0.006
S	Titanium alloys Ti-6Al-4V, etc.	-	First choice	AH120	MJ	70 - 200	0.003 - 0.008
		-	Low cutting force	AH120	NMJ	70 - 200	0.003 - 0.006
	Heat-resistant alloys Inconel718, etc.	-	First choice	AH120	MJ	70 - 130	0.003 - 0.007
-		Low cutting force	AH120	NMJ	70 - 130	0.003 - 0.006	

When using NMJ chipbreaker, please set up the feed not to exceed the value below.

Designation	Chip thickness (in)
TNMU120708PER-NMJ	< 0.008

High precision square shoulder mill, with screw clamp system, for triangular inserts

GAMP = +8.5°~ +11.5°, GAMF = -5.5°~ -12.5°

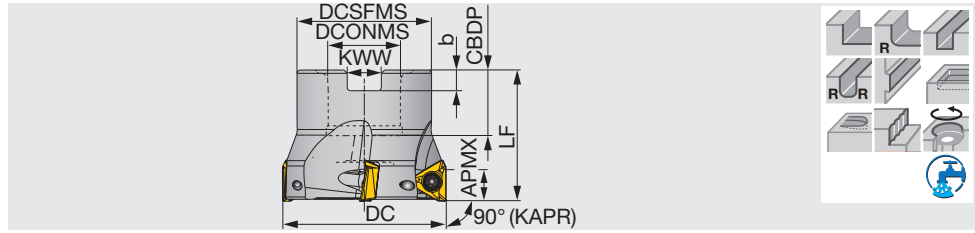

Inch	APMX	DC	CICT	DCSFMS	DCONMS	CBDP	LF	b	KWW	WT(lb)	Air hole	Insert
TPA06R200U0075A08	0.236	2.000	8	1.693	0.750	0.750	1.575	0.197	0.315	0.310	With	TOMT06...

SPARE PARTS

Designation	Clamping screw	Lubricant	Wrench	Shell locking bolt (Optional parts)
TPA06R200U0075A08	CSTB-2.5	M-1000	T-8D	(C0.375X1.125H)

*Recommended clamping torque : CSTB-2.5 = 0.96 lb·ft

High precision square shoulder endmill, shank type, with screw clamp system, for triangular inserts

GAMP = +8.5°~ +11.5°, GAMF = -5.5°~ -12.5°

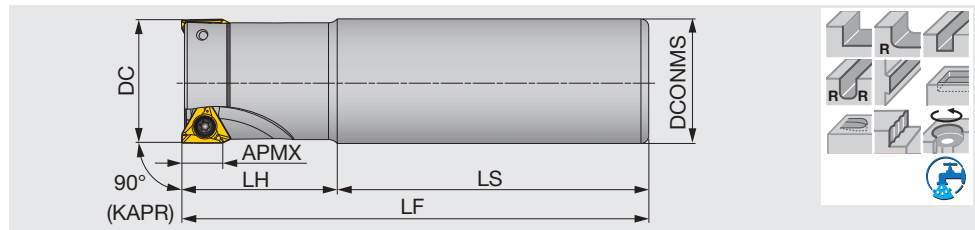

Inch	APMX	DC	CICT	DCONMS	LS	LH	LF	WT(lb)	Air hole	Insert
EPA06R050U0050-01N	0.236	0.500	1	0.500	2.250	0.750	3.000	0.15	Without	TOMT06...
EPA06R063U0063-02N	0.236	0.625	2	0.625	2.563	0.937	3.500	0.29	Without	TOMT06...
EPA06R075U0075-03N	0.236	0.750	3	0.750	2.858	1.142	4.000	0.46	With	TOMT06...
EPA06R100U0100W04N	0.236	1.000	4	1.000	2.280	1.500	3.780	0.76	Without	TOMT06...

SPARE PARTS

Designation	Clamping screw	Lubricant	Wrench
EPA06...	$\phi Dc \leq 0.625"$	CSTB-2.5S	M-1000
	$\phi Dc \geq 0.750"$	CSTB-2.5	M-1000

*Recommended clamping torque : CSTB-2.5S/CSTB-2.5 = 0.96 lbs·ft



TUNG-TRI

HPA06-M

High precision square shoulder endmill, modular type, for triangular inserts (TungFlex)

GAMP = +8.5°~ +11.5°, GAMF = -12.5°~ -5.5°

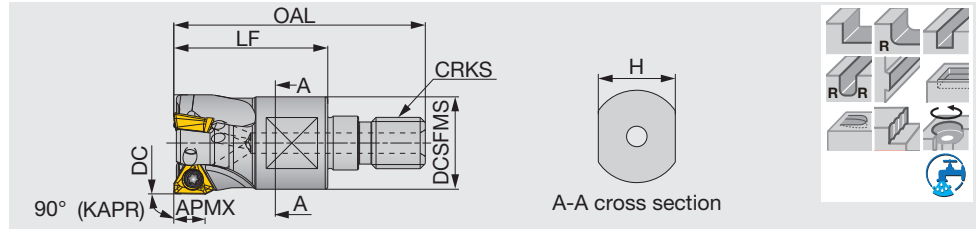

Metric	APMX	DC	CICT	OAL	LF	H	DCSFMS	CRKS	WT(kg)	Air hole	Insert
HPA06R016MM08-02	6	16	2	42	25	10	13	M8	0.03	With	TOMT06...
HPA06R020MM10-03	6	20	3	49	30	15	18	M10	0.06	With	TOMT06...
HPA06R025MM12-04	6	25	4	57	35	17	21	M12	0.1	With	TOMT06...
HPA06R032MM16-05	6	32	5	63	40	22	29	M16	0.2	With	TOMT06...

See page H167 for TungFlex modular shank.

SPARE PARTS

Designation	Clamping screw	Lubricant	Wrench
HPA06R016MM08-02	CSTB-2.5S	M-1000	T-8D
HPA06R020 - 032MM...	CSTB-2.5	M-1000	T-8D

*Recommended clamping torque : CSTB-2.5S/CSTB-2.5 = 1.3 N·m

TUNG-TRI

TPA10

High precision square shoulder mill, with screw clamp system, for triangular inserts

GAMP = +9.5°~ +11°, GAMF = -4.5°~ -0.5°

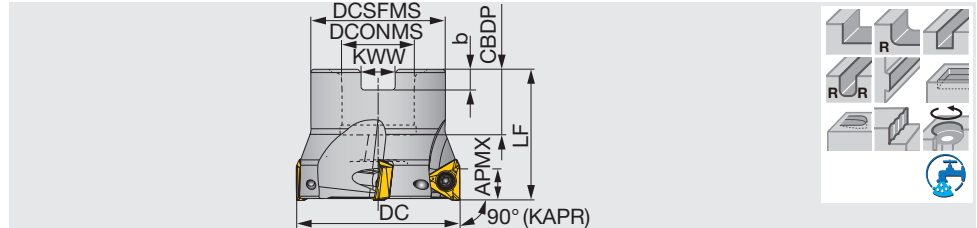

Inch	APMX	DC	CICT	DCSFMS	DCONMS	CBDP	LF	b	KWW	WT(kg)	Air hole	Insert	Arbor type
TPA10R200U0075A04	0.394	2.000	4	1.693	0.750	0.750	1.575	0.197	0.315	0.440	With	TO*T10...	A
TPA10R250U0075A06	0.394	2.500	6	1.693	0.750	0.750	1.575	0.197	0.315	0.680	With	TO*T10...	A
TPA10R300U0100A07	0.394	3.000	7	2.283	1.000	1.024	1.969	0.236	0.374	1.120	With	TO*T10...	A
TPA10R400U0150A08	0.394	4.000	8	3.150	1.500	1.413	2.480	0.394	0.626	2.290	With	TO*T10...	B

SPARE PARTS

Designation	Clamping screw	Grip	Torx bit	Lubricant	Shell locking bolt (Optional parts)
TPA10R200U... - 250U...	SR14-562/S	SW6-SD	BLDT10/S7	M-1000	(C0.375X1.125H)
TPA10R300U0100A07	SR14-562/S	SW6-SD	BLDT10/S7	M-1000	(C0.500X1.375H)
TPA10R400U0150A08	SR14-562/S	SW6-SD	BLDT10/S7	M-1000	(TMBA-0.750H)

*Recommended clamping torque : SR14-562/S = 2.58 lbs·ft

Arbor type

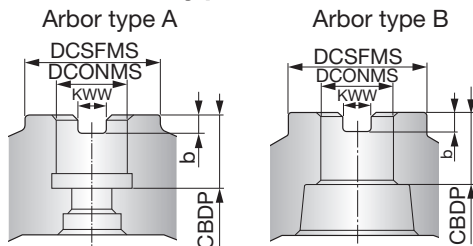

Reference pages: Inserts → H104, Standard cutting conditions → H106, TungFlex → H167

Square shoulder mill for roughing, with screw clamp system, for triangular inserts

GAMP = +9.5°~ +11°, GAMF = -4.5°~ -0.5°

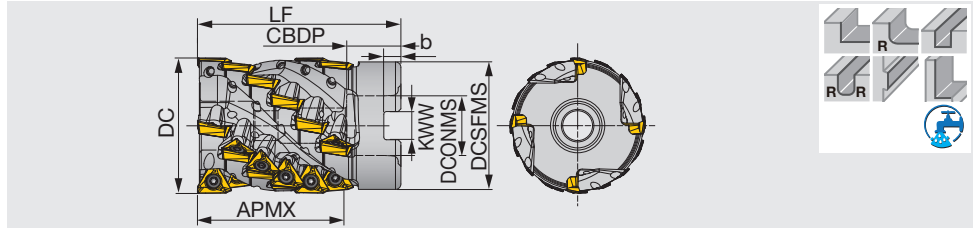

Inch	APMX	DC	ZEPF	CICT	DCSFMS	DCONMS	CBDP	LF	b	KWW	WT(lb)	Air hole	Insert
TLA10R200L213U0075A04	2.126	2.000	4	24	1.875	0.750	0.750	3.250	0.197	0.315	1.760	With	TO*T10...
TLA10R250L213U0100A04	2.126	2.500	4	24	2.375	1.000	1.024	3.250	0.236	0.374	2.960	With	TO*T10...

Coolant needs to be supplied from the end of the arbor inlay. Coolant cannot be supplied from the set bolt.

SPARE PARTS

Designation	Clamping screw	Lubricant	Wrench	Shell locking bolt
TLA10R200L213U0075A04	SR14-562	M-1000	T-10D	SD06-102
TLA10R250L213U0100A04	SR14-562	M-1000	T-10D	SD-08-C8

*Recommended clamping torque : SR14-562 = 1.84 lbs·ft

High precision square shoulder endmill, shank type, with screw clamp system, for triangular inserts

GAMP = +9.5°~ +11°, GAMF = -4.5°~ -0.5°

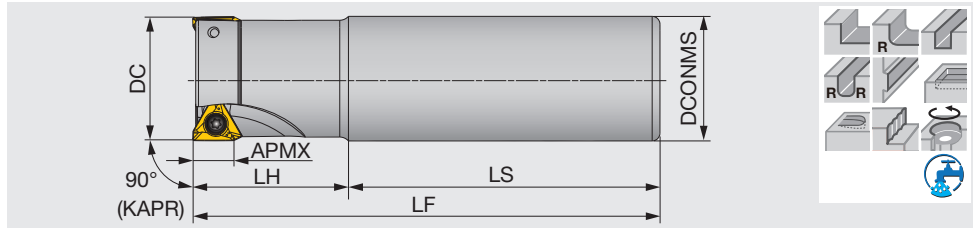

Inch	APMX	DC	CICT	DCONMS	LS	LH	LF	WT(lb)	Air hole	Insert
EPA10R100U0075W02N	0.394	1.000	2	0.750	2.362	1.378	3.740	0.440	Without	TO*T10...
EPA10R100U0100W02N	0.394	1.000	2	1.000	2.362	1.378	3.740	0.710	Without	TO*T10...
EPA10R100U0100W02L	0.394	1.000	2	1.000	5.748	2.752	8.500	1.680	With	TO*T10...
EPA10R125U0125W02L	0.394	1.250	2	1.250	7.000	3.000	10.000	3.150	With	TO*T10...
EPA10R125U0125W03N	0.394	1.250	3	1.250	2.362	1.378	3.740	1.120	Without	TO*T10...
EPA10R125U0125W03ML	0.394	1.250	3	1.250	4.250	2.250	6.500	2.070	With	TO*T10...
EPA10R150U0125W02L	0.394	1.500	2	1.250	8.000	2.000	10.000	3.330	With	TO*T10...
EPA10R150U0125W03ML	0.394	1.500	3	1.250	4.250	2.250	6.500	2.430	With	TO*T10...
EPA10R150U0125W04N	0.394	1.500	4	1.250	3.157	1.969	5.126	1.680	Without	TO*T10...

SPARE PARTS

Designation	Clamping screw	Grip	Lubricant	Torx bit
EPA10...	SR14-562/S	SW6-SD	M-1000	BLDT10/S7

*Recommended clamping torque : SR14-562 = 1.84 lbs·ft



TUNG-TRI

HPA10-M

High precision square shoulder endmill, modular type, for triangular inserts (TungFlex)

GAMP = +9.5°~+11°, GAMF = -4.5°~ -0.5°

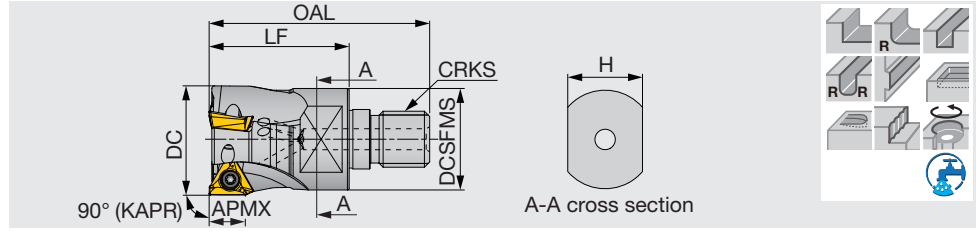

Metric	APMX	DC	CICT	OAL	LF	H	DCSFMS	CRKS	WT(kg)	Air hole	Insert
HPA10R025MM12-02	10	25	2	57	35	17	21	M12	0.08	With	TO*T10...
HPA10R032MM16-03	10	32	3	63	40	22	29	M16	0.18	With	TO*T10...

See page **H167** for TungFlex modular shank.

SPARE PARTS

Designation	Clamping screw	Grip	Lubricant	Torx bit
HPA10...	SR14-562/S	SW6-SD	M-1000	BLDT10/S7

*Recommended clamping torque : SR14-562/S = 2.5 N·m

TUNG-TRI

TPA15

High precision square shoulder mill, with screw clamp system, for triangular inserts

GAMP = +12°~+13.5°, GAMF = -6°~ -3.5°

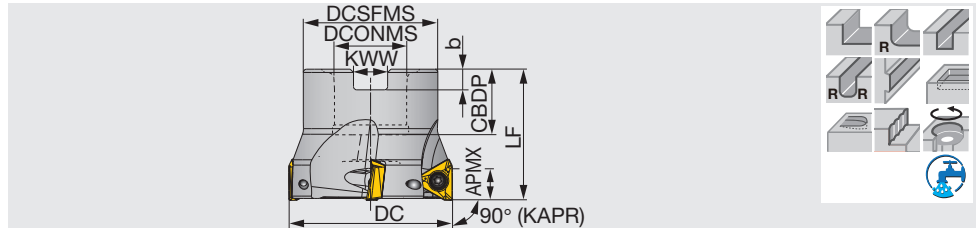

Inch	APMX	DC	CICT	DCSFMS	DCONMS	CBDP	LF	b	KWW	WT(lb)	Air hole	Insert	Arbor type
TPA15R200U0075A04	0.590	2.000	4	1.625	0.750	0.750	1.570	0.197	0.315	0.600	With	TO*T15...	A
TPA15R250U0075A05	0.590	2.500	5	2.125	0.750	0.750	1.570	0.197	0.315	0.900	With	TO*T15...	A
TPA15R300U0100A06	0.590	3.000	6	2.250	1.000	1.024	1.750	0.236	0.374	1.900	With	TO*T15...	A
TPA15R400U0150A07N	0.590	4.000	7	3.000	1.500	1.181	2.000	0.394	0.626	1.270	Without	TO*T15...	B
TPA15R500U0150A08N	0.590	5.000	8	4.000	1.500	1.175	2.000	0.394	0.626	2.800	Without	TO*T15...	B
TPA15R600U0200A10N	0.590	6.000	10	4.750	2.000	1.220	2.000	0.433	0.748	10.520	Without	TO*T15...	B

SPARE PARTS

Designation	Clamping screw	Grip	Lubricant	Torx bit	Shell locking bolt (Optional parts)
TPA15R200U..., TPA15R250U...	TS45120I	H-TB2W	M-1000	BT20S	(C0.375X1.125H)
TPA15R300U0100A06	TS45120I	H-TB2W	M-1000	BT20S	(C0.500X1.375H)
TPA15R400U0150A07N	TS45120I	H-TB2W	M-1000	BT20S	(TMBA-0.750H)
TPA15R500U0150A08N	TS45120I	H-TB2W	M-1000	BT20M	(TMBA-0.750H)
TPA15R600U0200A10N	TS45120I	H-TB2W	M-1000	BT20M	-

*Recommended clamping torque : TS45120I = 3.69 lbs·ft

Arbor type

Arbor type A

Arbor type B

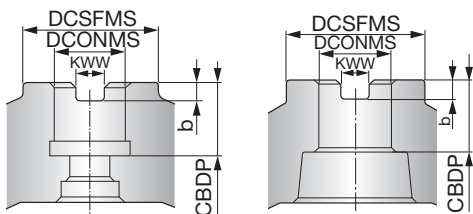

Reference pages: Inserts → **H104**, Standard cutting conditions → **H106**, TungFlex → **H167**

Square shoulder mill for roughing, with screw clamp system, for triangular inserts

GAMP = +12°~ +13.5°, GAMF = -6°~ -3.5°

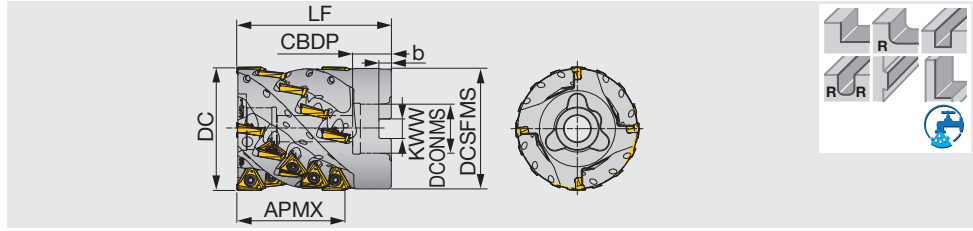

Inch	APMX	DC	ZEFP	CICT	DCSFMS	DCONMS	CBDP	LF	b	KWW	WT(lb)	Air hole	Insert
TLA15R300L275U0125A04M	2.756	3.000	4	20	2.937	1.250	1.260	3.940	0.315	0.500	4.560	With	TO*T15...
TLA15R400L326U0150A05M	3.268	4.000	5	20	3.875	1.500	1.260	4.375	0.394	0.626	10.00	With	TO*T15...

Coolant needs to be supplied from the end of the arbor inlay. Coolant cannot be supplied from the set bolt.

SPARE PARTS

Designation	Clamping screw	Grip	Torx bit	Lubricant	Shell locking bolt
TLA15R300L275U0125A04M	TS45120I	H-TB2W	BT20S	M-1000	SD-10-54
TLA15R400L326U0150A05M	TS45120I	H-TB2W	BT20S	M-1000	SD12-B9

*Recommended clamping torque : TS45120I = 3.69 lbs·ft

Subunit for TLA15-M, square shoulder mill for roughing, with screw clamp system, for triangular inserts

GAMP = +12°~ +13.5°, GAMF = -6°~ -3.5°

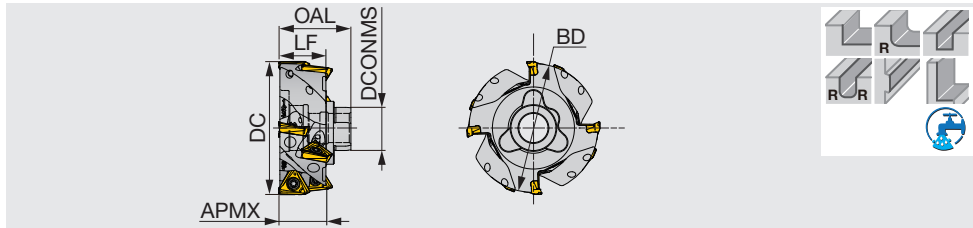

Inch	APMX	DC	ZEFP	CICT	BD	DCONMS	OAL	LF	WT(lb)	Air hole	Insert
TLA15R300L110A04S	1.102	3.000	4	8	2.898	1.024	1.703	1.102	1.240	With	TO*T15...
TLA15R400L110A05S	1.102	4.000	5	10	3.882	1.299	1.814	1.102	2.440	With	TO*T15...

Coolant needs to be supplied from the end of the arbor inlay. Coolant cannot be supplied from the set bolt.

SPARE PARTS

Designation	Clamping screw	Grip	Lubricant	Torx bit
TLA15...	TS45120I	H-TB2W	M-1000	BT20S

*Recommended clamping torque : TS45120I = 3.69 lbs·ft

CENTER BOLT

(Optional parts)

No. of subunits	1 pc	2 pcs
TLA15R300..	SD10-04	SD10-B3
TLA15R400..	SD12-C1	SD12-B8

Square shoulder milling

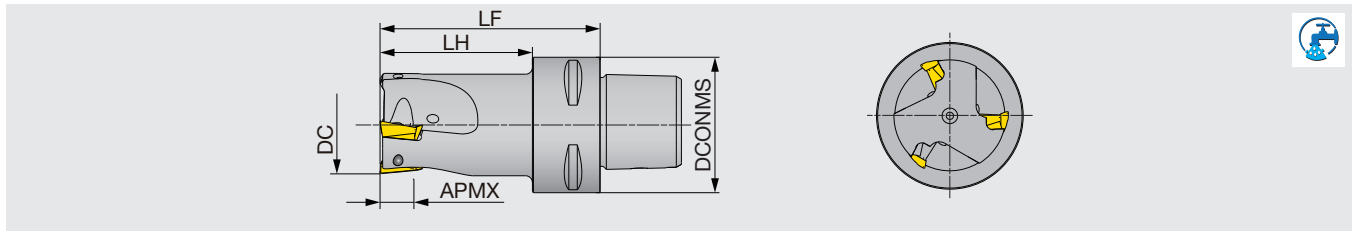

Metric	DC	APMX	DCONMS	CICT	LF	LH	Air hole	Insert
C4EPA10M032R03L065	32	10	40	3	65	45	With	TOMT1004...
C4EPA10M035R03L065	35	10	40	3	65	45	With	TOMT1004...
C6EPA15M040R03L080	40	15	63	3	80	58	With	TOMT1506...
C6EPA15M050R04L080	50	15	63	4	80	58	With	TOMT1506...

Applicable for 14 MPa coolant

SPARE PARTS



Designation	Clamping screw	Torx bit	Grip
C4EPA10M0**R03L065	SR14-562/S	BLDT10/S7	SW6-SD
C6EPA15M0**R0*L080	TS45120I	BT20S	H-TB2W

Square shoulder milling (for large depth of cut)

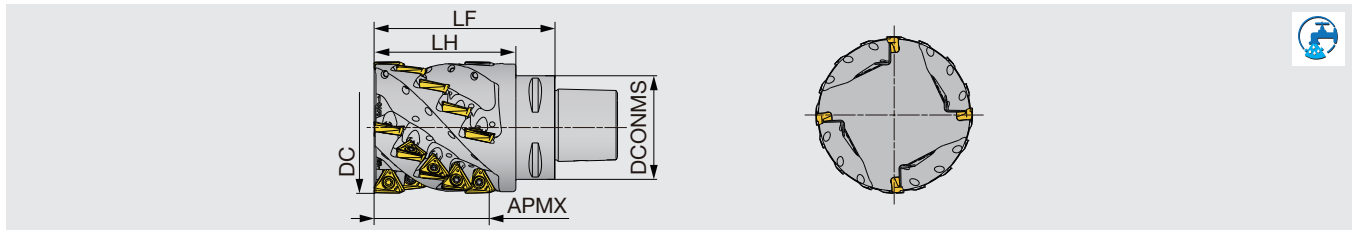

Metric	DC	APMX	DCONMS	CICT	ZEFP	LF	LH	Air hole	Insert
C6TLA15M063R03L100	63	55	63	12	3	100	78	With	TOMT1506...
C6TLA15M080R04L110	80	70	63	20	4	110	86.2	With	TOMT1506...

Applicable for 14 MPa coolant

SPARE PARTS



Designation	Clamping screw	Torx bit	Grip
C6TLA15M0**R0*L1**	TS45120I	BT20S	H-TB2W

Reference pages: C-EPA, C-TLA: Inserts → **H104**

High precision square shoulder endmill, shank type, with screw clamp system, for triangular inserts

GAMP = +12°~ +13.5°, GAMF = -6°~ -3.5°

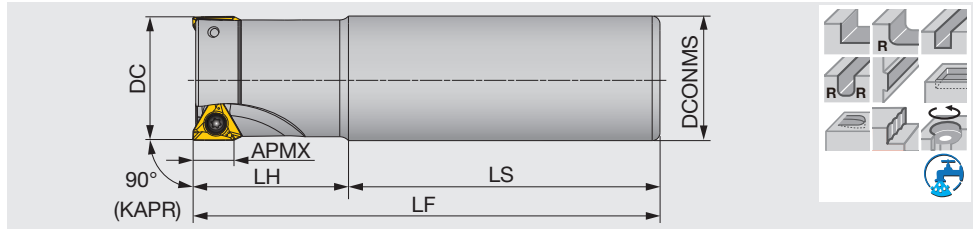

Inch	APMX	DC	CICT	DCONMS	LS	LH	LF	WT(lb)	Air hole	Insert
EPA15R150U0125W03N	0.590	1.500	3	1.250	2.250	2.250	4.500	1.480	With	TO*T15...
EPA15R150U0125W02L	0.590	1.500	2	1.250	2.250	4.250	6.500	2.070	With	TO*T15...
EPA15R200U0125W04N	0.590	2.000	4	1.250	2.250	2.250	4.500	1.740	Without	TO*T15...

SPARE PARTS

Designation	Clamping screw	Grip	Lubricant	Torx bit
EPA15...	TS45120I	H-TB2W	M-1000	BT20S

*Recommended clamping torque : TS45120I = 3.69 lbs·ft

INSERT

TOMT-MJ

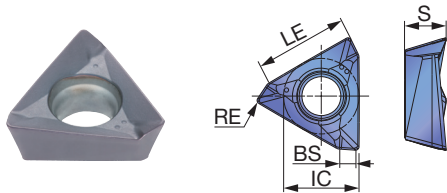

TOMT-NMJ

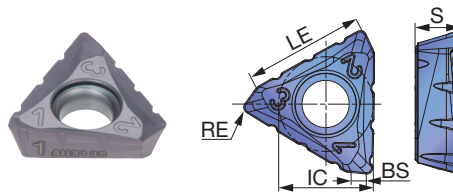

TOGT-AJ

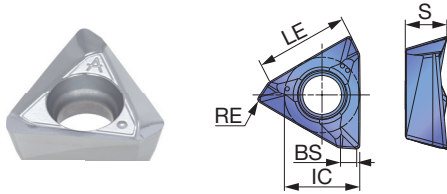

P	Steel	☆	★	☆					
M	Stainless		★	☆					
K	Cast iron	★		★					
N	Non-ferrous					★			
S	Superalloys	★	☆						
H	Hard materials								

★ : First choice
☆ : Second choice

Designation	RE	APMX	Coated					Uncoated						
			AH120	AH3135	T1215	T3225	KS05F							
TOMT060302PDER-MJ	0.008	0.236	●	●							0.244	0.220	0.126	0.055
TOMT060304PDER-MJ	0.016	0.236	●	●		●					0.244	0.220	0.126	0.047
TOMT060308PDER-MJ	0.031	0.236	●	●	●	●					0.244	0.220	0.126	0.031
TOMT100404PDER-MJ	0.016	0.394	●	●	●	●					0.413	0.339	0.185	0.059
TOMT100408PDER-MJ	0.031	0.394	●	●	●	●					0.413	0.339	0.185	0.043
TOMT100416PDER-MJ	0.063	0.394	●	●							0.413	0.339	0.185	0.008
TOMT150604PDER-MJ	0.016	0.590	●	●		●					0.618	0.500	0.236	0.087
TOMT150608PDER-MJ	0.031	0.590	●	●	●	●					0.618	0.500	0.236	0.075
TOMT150616PDER-MJ	0.063	0.590	●	●							0.618	0.500	0.236	0.043
TOMT150620PDER-MJ	0.079	0.590	●	●							0.618	0.500	0.236	0.028
TOMT150608PDER-NMJ	0.031	0.590	●	●		●					0.618	0.500	0.236	0.075
TOGT100404PDFR-AJ	0.016	0.394					●				0.413	0.339	0.205	0.059
TOGT100408PDFR-AJ	0.031	0.394					●				0.413	0.339	0.201	0.043
TOGT150604PDFR-AJ	0.016	0.590					●				0.618	0.493	0.220	0.087
TOGT150608PDFR-AJ	0.031	0.590					●				0.618	0.493	0.218	0.075

● : Line up

Caution for using NMJ chipbreaker

! Insert with NMJ chipbreaker has a number marked on each corner.
DO NOT place the corners with the same number in adjacent flute as the cutter may be damaged.

For example, if you place the corner #1 in one flute, be sure to use #2 or #3 (and avoid #1) in the next one.

Item: TOMT150608PDER-NMJ

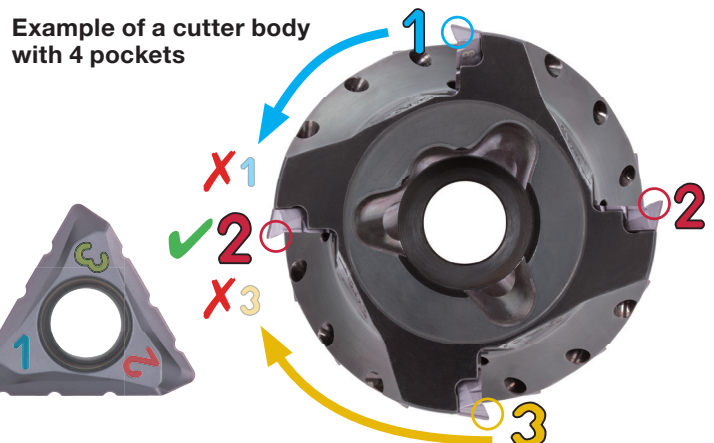

How to set a sub-unit

When setting a sub-unit on the main unit or another sub-unit, be sure to match the markings on the units. Sub-unit has a projection for error-proofing (Poka-yoke) to avoid setting error.

Projection for error-proofing (Poka-yoke)

Marking

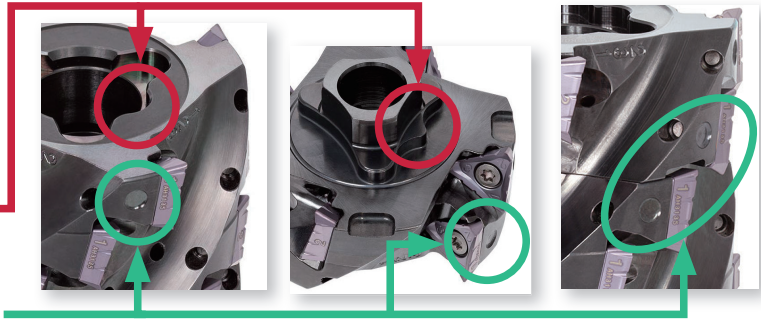

Directions for setting NMJ inserts on roughing type bodies

- 1 Attach the insert on the cutter body so that the number on the working cutting edge matches the first number marked on the cutter body. (See the image on the right.)
- 2 Attach the remaining inserts on the same flute with the same number marked on the working cutting edge.
- 3 Repeat steps 1 and 2 for the other flutes.
- 4 Make sure the number on the working cutting edge is different from the number used on the adjacent flutes.

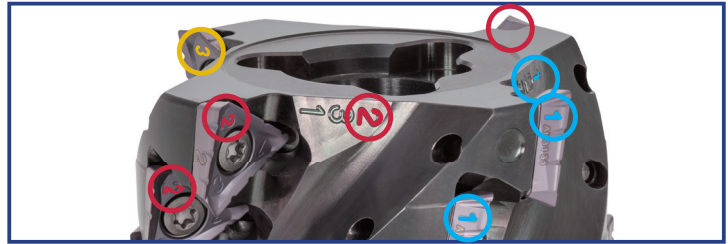

Directions for changing corners for inserts on roughing type bodies

- 1
 - a First time to change the corner rotate the insert clock-wise to match the number on the working cutting edge with the second number marked on the cutter body. (See the image on the right.)
Ex: 1 → 2
2 → 3
3 → 1
 - b Second time to change the corner rotate the insert clock-wise to match the number on the working cutting edge with the last number marked on the cutter body. (See the image on the right.)
Ex: 2 → 3
3 → 1
1 → 2
- 2 Repeat step 1 for all inserts.
- 3 Make sure the number on the working cutting edge is different from the number used on the adjacent flutes.

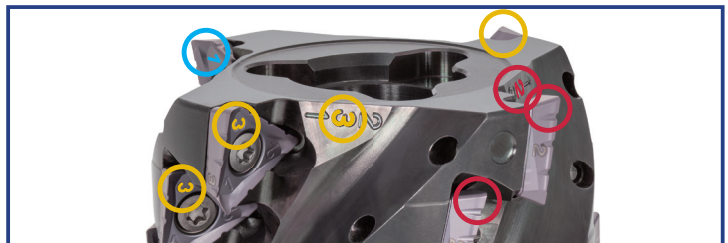
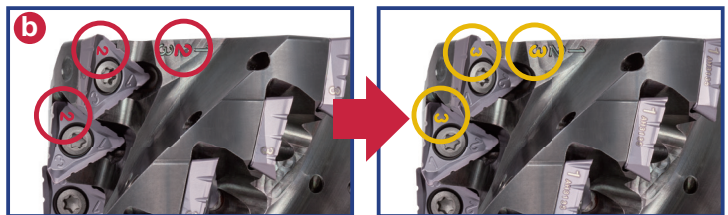
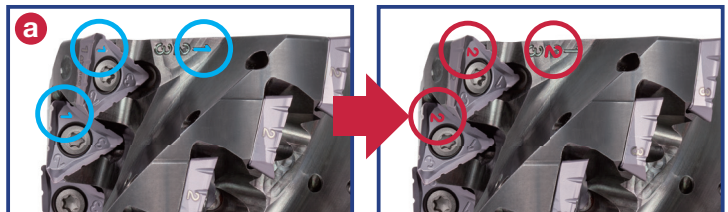

STANDARD CUTTING CONDITIONS

TPA/EPA/HPA

Workpiece materials	Hardness HB	Grades	Cutting speed Vc (sfm)			Feed per tooth: fz (ipt)					
						MJ		NMJ		AJ	
			T/E/HPA06	T/E/HPA10	T/EPA15	T/E/HPA06	T/E/HPA10	T/EPA15	T/EPA15	T/E/HPA10	
P	Low carbon steel 1015, etc.	- 200	AH3135	330 - 2360	330 - 820	330 - 820	0.002 - 0.006	0.003 - 0.008	0.003 - 0.010	0.003 - 0.006	-
	High carbon steel 1045, etc.	200 - 300	AH3135	330 - 560	330 - 660	330 - 755	0.002 - 0.005	0.003 - 0.006	0.003 - 0.008	0.003 - 0.006	-
	Alloy steel 4140, etc.	150 - 300	AH3135	330 - 560	330 - 660	330 - 755	0.002 - 0.005	0.003 - 0.006	0.003 - 0.008	0.003 - 0.006	-
	Tool steel H13, etc	30 - 40 HRC	AH3135	330 - 390	330 - 490	330 - 590	0.002 - 0.005	0.003 - 0.006	0.003 - 0.008	0.003 - 0.006	-
M	Stainless steel 304, etc.	-	AH3135	260 - 490	260 - 660	295 - 660	0.002 - 0.006	0.003 - 0.008	0.003 - 0.008	0.003 - 0.006	-
K	Grey cast iron No.250B, etc.	150 - 250	AH120	330 - 660	330 - 820	460 - 820	0.002 - 0.006	0.003 - 0.008	0.003 - 0.010	0.003 - 0.006	-
			T1215	150 - 250	490 - 300	660 - 984	0.002 - 0.005	0.003 - 0.006	0.003 - 0.007	-	-
	Ductile cast iron 65-45-12, etc.	150 - 250	AH120	260 - 490	260 - 660	360 - 660	0.002 - 0.006	0.003 - 0.008	0.003 - 0.010	0.003 - 0.006	-
			T1215	330 - 660	430 - 820	490 - 820	0.002 - 0.005	0.003 - 0.006	0.003 - 0.007	-	-
N	Aluminum Si < 13%	-	KS05F	-	984 - 3280	-	-	-	-	-	0.003 - 0.009
	Aluminum Si ≥ 13%	-	KS05F	-	330 - 660	-	-	-	-	-	0.003 - 0.009
S	Titanium alloys Ti-6Al-4V, etc.	-	AH120	66 - 164	66 - 200	66 - 200	0.002 - 0.004	0.003 - 0.006	0.003 - 0.007	0.003 - 0.006	-
	Heat-resistant alloys Inconel 718, etc.	-	AH120	66 - 115	66 - 130	66 - 130	0.001 - 0.003	0.002 - 0.005	0.003 - 0.006	0.003 - 0.006	-

- When you use the NMJ chipbreaker, please set up the feed less than 0.006 ipt.
- Remove excessive chip accumulation with an air blast.
- For the operation with depth of cut which varies (ex.casting skin) and machining of workpiece materials with interrupted surface, the feed per tooth (fz) should be set to the lower recommended value shown in the above table.

• Cutting conditions maybe limited depending on machine power, workpiece rigidity, and spindle output. When the cutting width, depth, or overhang length is large, set Vc and fz to the lower recommended values and check the machine power and vibration.

TLA (Roughing type)

ISO	Workpiece materials	Hardness HB	Grades	Cutting speed Vc (sfm)		Feed per tooth: fz (ipt)				
						MJ		NMJ		AJ
				TLA10	TLA15	TLA10	TLA15	TLA15	TLA10	
P	Low carbon steel 1015, etc.	- 200	AH3135	330 - 820	330 - 820	0.003 - 0.007	0.003 - 0.009	0.003 - 0.006	-	
	High carbon steel 1045, etc.	200 - 300	AH3135	330 - 660	330 - 270	0.003 - 0.006	0.003 - 0.007	0.003 - 0.006	-	
	Alloy steel 4140, etc.	30 - 40 HRC	AH3135	330 - 490	330 - 590	0.003 - 0.006	0.003 - 0.007	0.003 - 0.006	-	
M	Stainless steel 304, etc.	-	AH3135	260 - 660	295 - 660	0.003 - 0.006	0.003 - 0.007	0.003 - 0.006	-	
K	Grey cast iron No.250B, etc.	150 - 250	AH120	330 - 820	460 - 820	0.003 - 0.007	0.003 - 0.010	0.003 - 0.006	-	
			T1215	490 - 820	490 - 820	0.003 - 0.006	0.003 - 0.007	-	-	
	Ductile cast iron 65-45-12, etc.	150 - 250	AH120	260 - 660	360 - 660	0.003 - 0.007	0.003 - 0.010	0.003 - 0.006	-	
			T1215	490 - 820	490 - 820	0.003 - 0.006	0.003 - 0.007	-	-	
N	Aluminum Si < 13%	-	KS05F	990 - 3280	-	-	-	-	0.003 - 0.009	
	Aluminum Si ≥ 13%	-	KS05F	330 - 660	-	-	-	-	0.003 - 0.009	
S	Titanium alloys Ti-6Al-4V, etc.	-	AH120	66 - 217	66 - 217	0.003 - 0.006	0.003 - 0.007	0.003 - 0.006	-	
	Heat-resistant alloys Inconel 718, etc.	-	AH120	66 - 130	66 - 130	0.002 - 0.005	0.003 - 0.006	0.003 - 0.006	-	

- When using NMJ chipbreaker, please set up the feed not to exceed 0.006 ipt.

APPLICATION RANGE

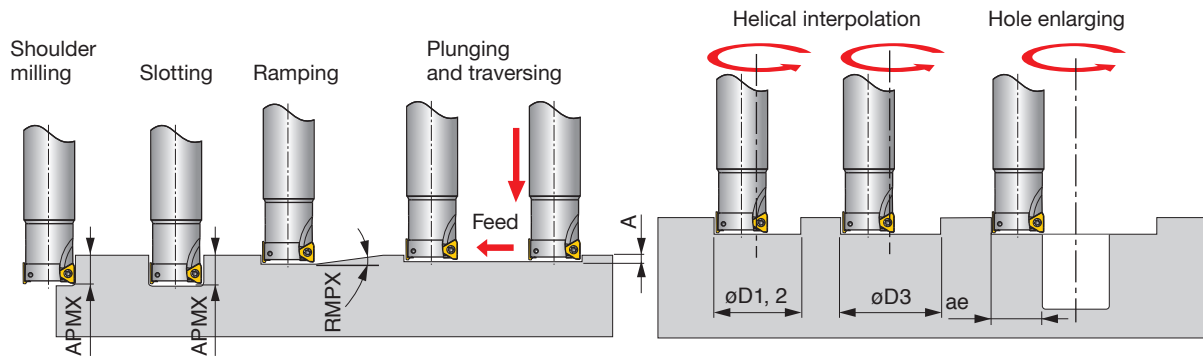

Inch	DC	Max. depth of cut APMX	Max. ramping angle RMPX	Max. plunging depth A	Min. machining depth øD1	Max. machining diameter		Max. cutting width in enlarging ae
						øD2	øD3*	
EPA06R050U...	0.500	0.236	5°	0.024	0.748	0.984	0.882	0.480
EPA06R063U...	0.625	0.236	4°	0.024	0.984	1.234	1.132	0.605
EPA06R075U...	0.750	0.236	3°	0.024	1.240	1.484	1.382	0.730
EPA06R100U...	1.000	0.236	2°	0.024	1.752	1.984	1.882	0.980
TPA06R200U...	2.000	0.236	0.7°	0.024	3.740	3.984	3.882	1.980
EPA10R100U...	1.000	0.394	2°	0.024	1.689	1.984	1.882	0.980
EPA10R125U...	1.250	0.394	2°	0.024	2.189	2.484	2.382	1.230
EPA10R150U...	1.500	0.394	1.4°	0.024	2.689	2.984	2.882	1.480
TPA10R200U...	2.000	0.394	0.8°	0.024	3.689	3.984	3.882	1.980
TPA10R250U...	2.500	0.394	0.7°	0.024	4.689	4.984	4.882	2.480
TPA10R300U...	3.000	0.394	0.6°	0.024	5.689	5.984	5.882	2.980
TPA10R400U...	4.000	0.394	0.5°	0.024	7.689	7.984	7.882	3.980
EPA15R150U...	1.500	0.590	2.3°	0.031	2.547	2.969	2.823	1.461
E/TPA15R200U...	2.000	0.590	1.7°	0.031	3.547	3.969	3.823	1.961
TPA15R250U...	2.500	0.590	1.4°	0.031	4.547	4.969	4.823	2.461
TPA15R300U...	3.000	0.590	1°	0.031	5.547	5.969	5.823	2.961
TPA15R400U...	4.000	0.590	0.8°	0.031	7.547	7.969	7.823	3.961
TPA15R500U...	5.000	0.590	0.6°	0.031	9.547	9.969	9.823	4.961
TPA15R600U...	6.000	0.590	0.5°	0.031	11.547	11.969	11.823	5.961

* Flat bottom hole

Corner RE for dimensions of øD1, øD2 and øD3: RE = 0.016" for E/TPA06, E/TPA10 and RE = 0.031" for E/TPA15.

Grade
Insert
Toolholder
Ext. Toolholder
Int. Toolholder
Threading
Grooving
Miniature Tool
Milling Cutter
Endmill
Drilling Tool
System
User's Guide
Index



TUNG^{TS}SHRED

LPTC16

Square shoulder mill for roughing, with screw clamp system, for shred inserts

GAMP = +5.5°~ +6.5°, GAMF = -11.5°~ -11.3°

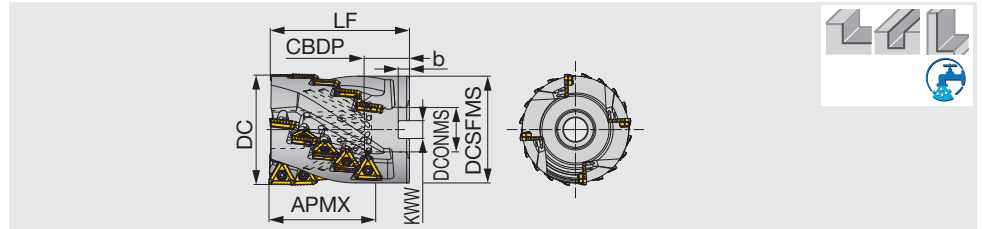

Inch	APMX	DC	ZEFP	CICT	DCSFMS	LF	DCONMS	CBDP	KWW	b	WT(lb)	Air hole	Insert
LPTC16U2.50B1.00L2.4R03	2.402	2.500	3	12	2.350	3.350	1.000	1.024	0.374	0.236	2.820	With	TC*T16...
LPTC16U3.00B1.25L3.0R04	2.992	3.000	4	20	2.839	4.000	1.250	1.260	0.500	0.315	4.670	With	TC*T16...

Coolant needs to be supplied from the end of the arbor inlay. Coolant cannot be supplied from the set bolt.

SPARE PARTS

Designation	Clamping screw	Grip	Lubricant	Shell locking bolt	Torx bit
LPTC16U2.50B1.00L2.4R03	TS 40B100I	H-TB2W	M-1000	SD-08-C8	BT15S
LPTC16U3.00B1.25L3.0R04	TS 40B100I	H-TB2W	M-1000	SD-10-54	BT15S

*Recommended clamping torque : TS 40B100I = 2.58 lbs·ft

TUNG^{TS}SHRED

TPTC16

Square shoulder mill, with screw clamp system, for shred inserts

GAMP = +5.5°~ +6.5°, GAMF = -11.5°~ -11.3°

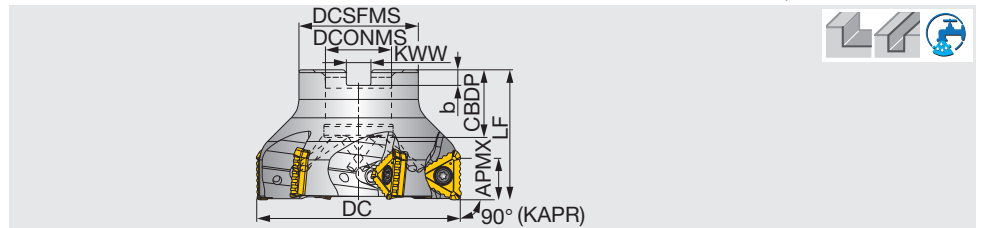

Inch	APMX	DC	CICT	DCSFMS	LF	DCONMS	CBDP	KWW	b	WT(lb)	Air hole	Insert	Arbor type
TPTC16U2.00B0.75R04	0.630	2.000	4	1.625	1.570	0.750	0.750	0.315	0.197	0.710	With	TC*T16...	A
TPTC16U2.50B0.75R05	0.630	2.500	5	2.125	1.570	0.750	0.750	0.315	0.197	1.260	With	TC*T16...	A
TPTC16U3.00B1.00R06	0.630	3.000	6	2.250	1.752	1.000	1.024	0.374	0.236	1.810	With	TC*T16...	A
TPTC16U4.00B1.50R07	0.630	4.000	7	3.000	2.000	1.500	1.193	0.626	0.394	3.170	With	TC*T16...	B

SPARE PARTS

Designation	Clamping screw	Grip	Lubricant	Torx bit	Shell locking bolt (Optional parts)
TPTC16U2.00B0.75R04	TS 40B100I	H-TB2W	M-1000	BT15S	TCS9.525-35-I
TPTC16U2.50B0.75R05	TS 40B100I	H-TB2W	M-1000	BT15S	(C0.375X1.125H)
TPTC16U3.00B1.00R06	TS 40B100I	H-TB2W	M-1000	BT15S	(C0.500X1.375H)
TPTC16U4.00B1.50R07	TS 40B100I	H-TB2W	M-1000	BT15S	(TMBA-0.750H)

*Recommended clamping torque : TS 40B100I = 2.58 lbs·ft

Arbor type

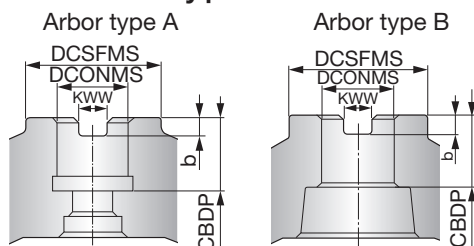

Reference pages: Inserts → **H109**, Standard cutting conditions → **H110**

Square shoulder endmill, shank type, with screw clamp system, for shred inserts

GAMP = +5.5°~ +6.5°, GAMF = -11.5°~ -11.3°

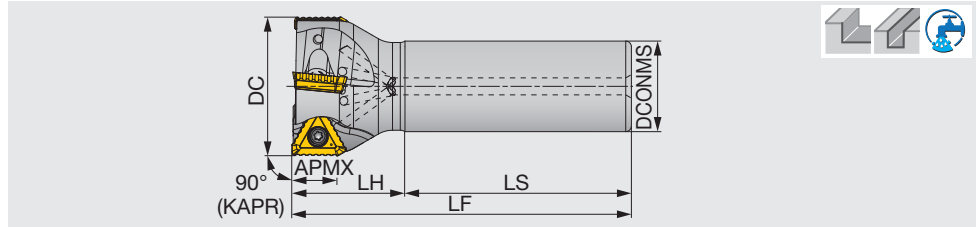

Inch	APMX	DC	CICT	DCONMS	LS	LH	LF	WT(lb)	Air hole	Insert
EPTC16U2.00W1.25R04	0.630	2.000	4	1.250	2.250	2.250	4.500	1.700	With	TC*T16...

SPARE PARTS

Designation	Clamping screw	Grip	Lubricant	Torx bit
EPTC16...	TS 40B100I	H-TB2W	M-1000	BT15S

*Recommended clamping torque : TS 40B100I = 2.58 lb·ft

INSERT

TCGT-MJ

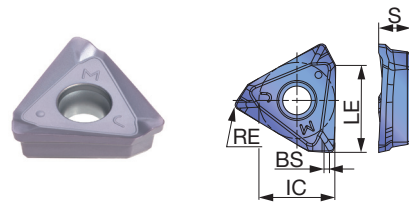

TCMT-NMJ

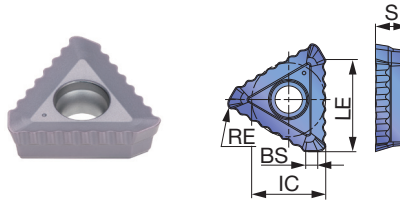

P Steel	☆	★	☆							
M Stainless		★								
K Cast iron	★		☆							
N Non-ferrous										
S Superalloys	★	☆								
H Hard materials										

★ : First choice
☆ : Second choice

Designation	RE	APMX	Coated				LE	IC	S	BS
			AH120	AH3135	T1215	T3225				
TCGT160608PDER-MJ	0.031	0.630	●	●			0.630	0.539	0.228	0.039
TCMT160620PDER-NMJ	0.079	0.630	●	●	●	●	0.630	0.524	0.228	0.079

● : Line up

STANDARD CUTTING CONDITIONS



ISO	Workpiece materials	Hardness	Priority	Grade	Chip-breaker	Cutting speed Vc (sfm)	Feed per tooth fz (ipt)
P	Low carbon steels 1015, 1020, etc.	- 300 HB	First choice	AH3135	NMJ*	330 - 820	0.003 - 0.006
		- 300 HB	Wear resistance	T3225	NMJ*	330 - 990	0.003 - 0.006
		- 300 HB	For finishing	AH3135	MJ	330 - 820	0.003 - 0.008
	Carbon steels, Alloy steels 1055, 4140, etc.	- 300 HB	First choice	AH3135	NMJ*	330 - 760	0.003 - 0.006
		- 300 HB	Wear resistance	T3225	NMJ*	330 - 920	0.003 - 0.006
		- 300 HB	For finishing	AH3135	MJ	330 - 760	0.003 - 0.008
	Prehardened steel NAK80, PX5, etc.	30 - 40 HRC	First choice	AH3135	NMJ*	330 - 590	0.003 - 0.006
		30 - 40 HRC	Wear resistance	T3225	NMJ*	330 - 200	0.003 - 0.006
		30 - 40 HRC	For finishing	AH3135	MJ	330 - 590	0.003 - 0.008
M	Stainless steels 304, 316, etc.	-	First choice	AH3135	NMJ*	300 - 660	0.003 - 0.006
		-	Wear resistance	T3225	NMJ*	300 - 820	0.003 - 0.006
		-	For finishing	AH3135	MJ	300 - 660	0.003 - 0.008
K	Gray cast irons No.25, No.30, etc.	150 - 250 HB	First choice	AH120	NMJ*	460 - 820	0.003 - 0.006
		150 - 250 HB	Wear resistance	T1215	NMJ*	490 - 980	0.003 - 0.006
		150 - 250 HB	For finishing	AH120	MJ	460 - 820	0.003 - 0.010
	Ductile cast irons 60-40-18, 80-55-06, etc.	150 - 250 HB	First choice	AH120	NMJ*	460 - 820	0.003 - 0.006
		150 - 250 HB	Wear resistance	T1215	NMJ*	490 - 980	0.003 - 0.006
		150 - 250 HB	For finishing	AH120	MJ	460 - 820	0.003 - 0.010
S	Titanium alloys Ti-6Al-4V, etc.	-	First choice	AH120	NMJ*	70 - 200	0.003 - 0.006
		-	For finishing	AH120	MJ	70 - 200	0.003 - 0.007
	Heat-resistant alloys Inconel718, etc.	-	First choice	AH120	NMJ*	70 - 130	0.003 - 0.005
		-	For finishing	AH120	MJ	70 - 130	0.003 - 0.006

* When using the -NMJ chipbreaker, do not feed higher than 0.006 ipt.



Mini square shoulder endmill, shank type, with screw clamp system

GAMP = +6.0°~ +7.6°, GAMF = -37.1°~ -32.4°

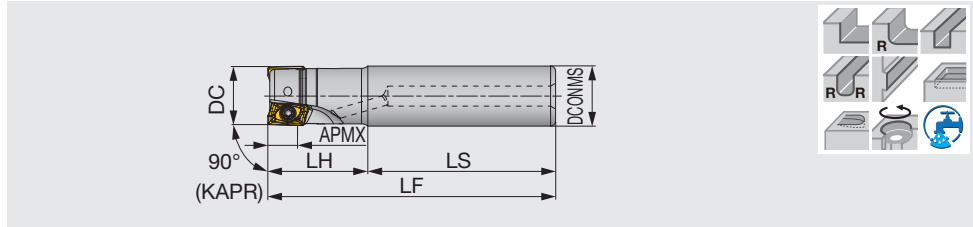

Inch	APMX	DC	CICT	DCONMS	LS	LH	LF	WT(lb)	Air hole	Insert
EPAV06U0.31C0.37R01	0.236	0.313	1	0.375	2.463	0.787	3.250	0.090	With	AVGT06...
EPAV06U0.37C0.37R01	0.236	0.375	1	0.375	2.463	0.787	3.250	0.090	With	AVGT06...
EPAV06U0.37C0.37R01L	0.236	0.375	1	0.375	2.622	1.378	4.000	0.110	With	AVGT06...
EPAV06U0.50C0.50R02	0.236	0.500	2	0.500	2.463	0.787	3.250	0.150	With	AVGT06...
EPAV06U0.50C0.50R03	0.236	0.500	3	0.500	2.463	0.787	3.250	0.150	With	AVGT06...
EPAV06U0.50C0.50R02L	0.236	0.500	2	0.500	3.388	1.362	4.750	0.220	With	AVGT06...
EPAV06U0.62C0.62R03	0.236	0.625	3	0.625	2.713	0.787	3.500	0.260	With	AVGT06...
EPAV06U0.62C0.62R04	0.236	0.625	4	0.625	2.713	0.787	3.500	0.260	With	AVGT06...
EPAV06U0.62C0.62R03L	0.236	0.625	3	0.625	4.122	1.378	5.500	0.420	With	AVGT06...
EPAV06U0.75C0.62R04	0.236	0.750	4	0.625	2.815	1.185	4.000	0.330	With	AVGT06...
EPAV06U0.75C0.75R04	0.236	0.750	4	0.750	2.815	1.185	4.000	0.440	With	AVGT06...
EPAV06U0.75C0.75R05	0.236	0.750	5	0.750	2.815	1.185	4.000	0.440	With	AVGT06...
EPAV06U0.75C0.75R04L	0.236	0.750	4	0.750	6.500	1.375	7.875	0.900	With	AVGT06...
EPAV06U1.00C0.75R06	0.236	1.000	6	0.750	3.125	1.375	4.500	0.550	With	AVGT06...
EPAV06U1.00C1.00R05	0.236	1.000	5	1.000	3.125	1.375	4.500	0.930	With	AVGT06...
EPAV06U1.00C1.00R06	0.236	1.000	6	1.000	3.125	1.375	4.500	0.930	With	AVGT06...
EPAV06U1.00C1.00R04L	0.236	1.000	4	1.000	6.425	1.575	8.000	1.680	With	AVGT06...

SPARE PARTS



Designation	Clamping screw	Lubricant	Wrench
EPAV06U...	CSPB-2H	M-1000	IP-6DB

*Recommended clamping torque : CSPB-2H = 0.52 lbs·ft

TUNG F REC

HPAV06-M

Mini square shoulder endmill, modular type (TungFlex)

GAMP = +6.0°~ +7.6°, GAMF = -37.1°~ -32.4°

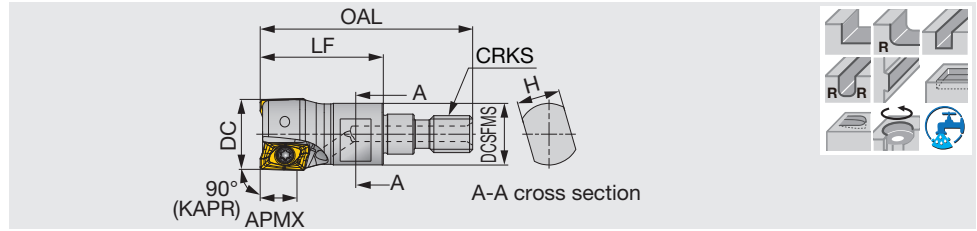

Metric	APMX	DC	CICT	OAL	LF	H	DCSFMS	CRKS	WT(kg)	Air hole	Insert
HPAV06M010M06R02	6	10	2	34.5	20	7	9.5	M6	0.01	With	AVGT06...
HPAV06M012M06R02	6	12	2	34.5	20	7	10	M6	0.01	With	AVGT06...
HPAV06M012M06R03	6	12	3	34.5	20	7	10	M6	0.01	With	AVGT06...
HPAV06M016M08R03	6	16	3	42	25	10	13	M8	0.03	With	AVGT06...
HPAV06M016M08R04	6	16	4	42	25	10	13	M8	0.03	With	AVGT06...

See page **H167** for TungFlex modular shank.

SPARE PARTS

Designation	Clamping screw	Lubricant	Wrench
HPAV06M...	CSPB-2H	M-1000	IP-6DB

*Recommended clamping torque : CSPB-2H = 0.7 N·m

- High Feed Milling
- Face Milling
- Shoulder Milling
- Slot Milling
- Profile Milling
- Thread Milling
- Other

Approach angle

- 10°-20°
- 45°
- 70°
- 85°
- 88°
- 90°
- Others

Reference pages: Inserts, Standard cutting conditions → **H114**, TungFlex → **H167**

Mini square shoulder endmill, modular type (TungMeister)

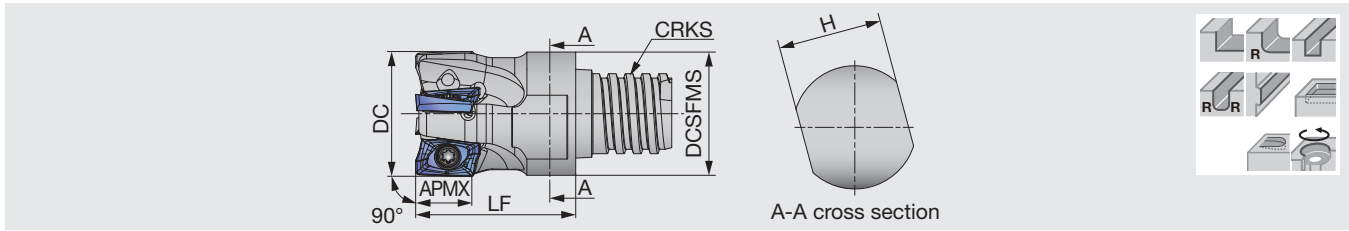

Metric	APMX	DC	CICT	LF	H	DCSFMS	CRKS	WT (kg)	Air hole	Insert
HPAV06M010S05R02	6 (0.236)	10 (0.394)	2	10 (0.394)	8	8 (0.315)	S05	0.01	Without	AVGT06...
HPAV06M010S06R02	6 (0.236)	10 (0.394)	2	16 (0.630)	8	9.8 (0.386)	S06	0.01	Without	AVGT06...
HPAV06M012S08R02	6 (0.236)	12 (0.472)	2	18 (0.709)	10	11.7 (0.461)	S08	0.02	Without	AVGT06...
HPAV06M012S08R03	6 (0.236)	12 (0.472)	3	18 (0.709)	10	11.7 (0.461)	S08	0.02	Without	AVGT06...
HPAV06M016S10R03	6 (0.236)	16 (0.630)	3	20 (0.787)	13	15.4 (0.606)	S10	0.03	Without	AVGT06...
HPAV06M016S10R04	6 (0.236)	16 (0.630)	4	20 (0.787)	13	15.4 (0.606)	S10	0.03	Without	AVGT06...

- Applicable shank: VSSD, VTSD, VSC, VSTD, VER
 Please see page **1032 - 1035** for the types and the selection of TungMeister shank.
 Please use VAD-M adapter to connect TungMeister with a metric thread shank.

Unit: mm (inch)

Spanner*	Designation	Connection screw size
	KEYV-S05	S05
	KEYV-S06	S06
	KEYV-S08	S08
	KEYV-S10	S10

*sold separately

SPARE PARTS

Designation	Clamping screw	Lubricant	Wrench
HPAV06M...	CSPB-2H	M-1000	IP-6DB

*Recommended clamping torque : CSPB-2H = 0.7 N·m

INSERT

AVGT-MJ

AVGT-AJ

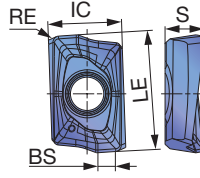

P Steel	★	★							
M Stainless		☆	★						
K Cast iron	★								
N Non-ferrous				★					
S Superalloys	★	★	☆						
H Hard materials	★								

★ : First choice
☆ : Second choice

Designation	RE	APMX	Coated				Uncoated				LE	IC	S	BS			
			AH120	AH130	AH3135	KS05F											
AVGT060300PBER-MJ	-	0.236			●												
AVGT060302PBER-MJ	0.008	0.236	●	●	●												
AVGT060304PBER-MJ	0.016	0.236	●	●	●												
AVGT060308PBER-MJ	0.031	0.236	●	●	●												
AVGT060300PBFR-AJ	-	0.236				●											
AVGT060302PBFR-AJ	0.008	0.236				●											
AVGT060304PBFR-AJ	0.016	0.236				●											
AVGT060308PBFR-AJ	0.031	0.236				●											

● : Line up

STANDARD CUTTING CONDITIONS

ISO	Workpiece materials	Hardness	Priority	Grades	Cutting speed Vc (sfm)	Feed per tooth fz (ipt)	
P	Low carbon steels 1018, 1026, etc.	- 200 HB	First choice	AH3135	755 - 1410	0.003 - 0.005	
	Carbon steel and alloy steel 1055, 4140, etc.	- 300 HB	First choice	AH3135	490 - 1150	0.003 - 0.005	
	Prehardened steel H-13, P-20, etc.	30 - 40 HRC	First choice	AH3135	325 - 750	0.003 - 0.005	
M	Stainless steel 304, 316, etc.	-	First choice	AH3135	490 - 720	0.003 - 0.004	
K	Gray cast iron Class 25, Class 30, etc.	150 - 250 HB	First choice	AH120	655 - 1080	0.003 - 0.005	
	Ductile cast iron 60-40-12, 80-55-06, etc.	150 - 250 HB	First choice	AH120	490 - 785	0.003 - 0.005	
N	Aluminum alloys Si < 13%	-	First choice	KS05F	2130 - 3280	0.003 - 0.005	
	Aluminum alloys Si ≥ 13%	-	First choice	KS05F	325 - 750	0.003 - 0.005	
S	Titanium alloys Ti-6Al-4V, etc.	-	First choice	AH130	130 - 295	0.0016 - 0.004	
	Superalloys Inconel718, etc.	-	First choice	AH130	145 - 210	0.0016 - 0.004	
H	Hardened steel	H13, etc.	40 - 50 HRC	First choice	AH120	145 - 225	0.002 - 0.004
		D2, etc.	50 - 60 HRC	First choice	AH120	130 - 210	0.0016 - 0.003

MACHINING APPLICATIONS

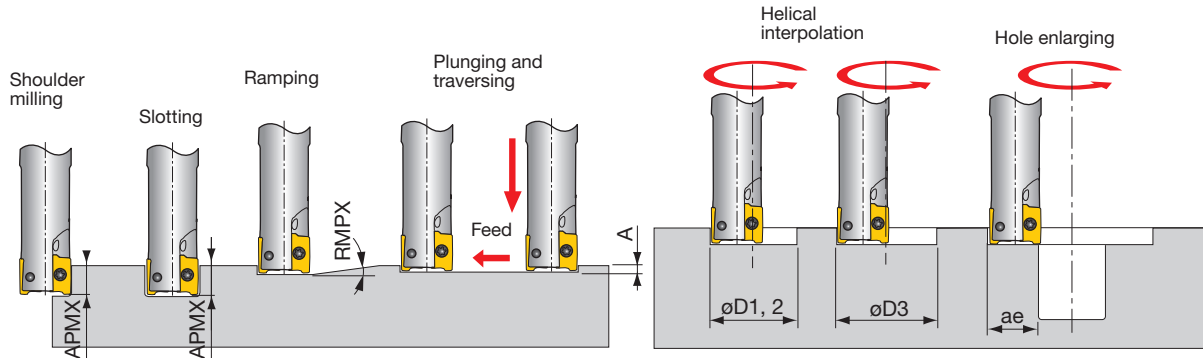

Inch	DC	Max. depth of cut APMX	Max. ramping angle RMPX	Max. plunging A	Min. machining øD1	Max. machining øD2 øD3*		Max. cutting width in enlarging ae
EPAV06U0.31...	0.313	0.236	-	-	-	-	-	-
EPAV06U0.37...	0.375	0.236	3°	0.012	0.591	0.748	0.709	0.374
EPAV06U0.50...	0.500	0.236	3°	0.012	0.709	0.906	0.866	0.453
EPAV06U0.62...	0.625	0.236	2°	0.012	1.026	1.220	1.181	0.610
EPAV06U0.75...	0.750	0.236	1.5°	0.012	1.276	1.460	1.421	0.730
EPAV06U1.00...	1.000	0.236	1°	0.012	1.775	1.960	1.921	0.980

*Flat bottom hole

When clamping the insert, please confirm that there is no gap between the cutter body and the insert as shown in the picture.

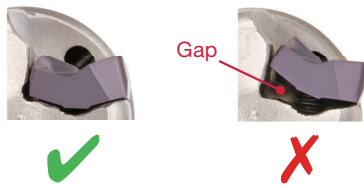

Grade
Insert
Ext. Toolholder
Int. Toolholder
Threading
Grooving
Miniature Tool
Milling Cutter
Endmill
Drilling Tool
Tooling System
User's Guide
Index

A
B
C
D
E
F
G
H
I
J
K
L
M

High precision square shoulder mill, with screw clamp system, for AOMT/AOGT07 inserts

GAMP = +7°, GAMF = +13°~ +18°

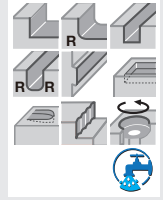
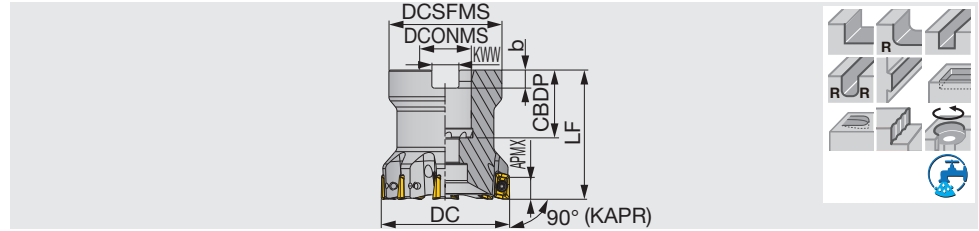

Inch	DC	CICT	DCSFMS	LF	DCONMS	CBDP	KWW	b	WT(lb)	Air hole	Insert
TPO07R200U0075A12	2.000	12	1.693	1.575	0.750	0.789	0.315	0.197	0.660	With	AO*T0702...

SPARE PARTS

Designation	Clamping screw	Shell locking bolt (Optional parts)	Wrench
TPO07R200U0075A12	CSTB-2.5L046	(C0.375X1.125H)	T-7DB

*Recommended clamping torque : CSTB-2.5L046 = 0.96 lb·ft

High precision square shoulder endmill, shank type, with screw clamp system, for AOMT/AOGT07 inserts

GAMP = +7°, GAMF = +13°~ +18°

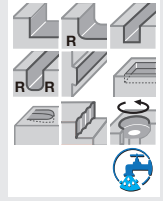
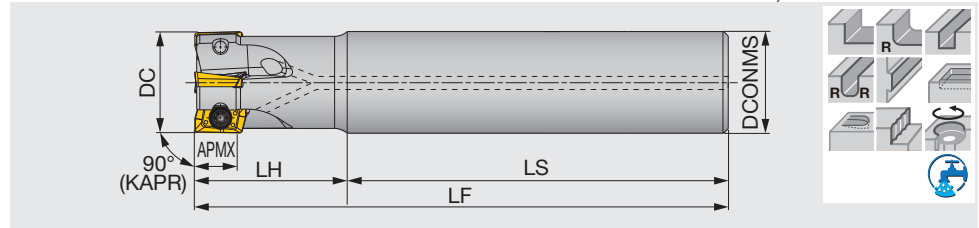

Inch	DC	CICT	DCONMS	LS	LH	LF	WT(lb)	Air hole	Insert
EPO07R050U0050-02	0.500	2	0.500	2.250	0.750	3.000	0.140	With	AO*T0702...
EPO07R063U0063-04	0.625	4	0.625	2.563	0.937	3.500	0.250	With	AO*T0702...
EPO07R075U0075-05	0.750	5	0.750	2.875	1.125	4.000	0.410	With	AO*T0702...
EPO07R100U0075-03	1.000	3	0.750	2.000	1.500	3.500	0.400	With	AO*T0702...
EPO07R100U0100W07	1.000	7	1.000	2.281	1.500	3.781	0.680	With	AO*T0702...

*The DC above is the diameter when using MJ or AJ chipbreaker.

With HJ chipbreaker, the tool diameter is (DC above + 0.0024").

**The LF and LH above are the lengths when using MJ chipbreaker.

With AJ chipbreaker, the length is (LF, L + 0.004"). With HJ chipbreaker, the length is (LF, L + 0.02").

SPARE PARTS

Designation	Clamping screw	Wrench
EPO07R...	CSTB-2.5L046	T-7DB

*Recommended clamping torque : CSTB-2.5L046 = 0.96 lbs·ft

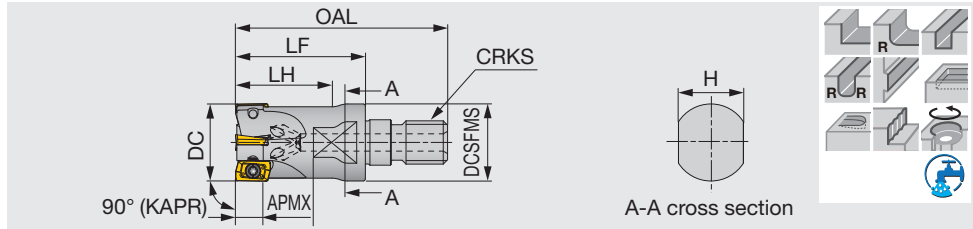

Metric	DC	CICT	OAL	LF	LH	H	DCSFMS	CRKS	WT(kg)	Air hole	Insert
HPO07R012MM06-02	12	2	39.5	25	-	7	9.8	M6	0.01	With	AO*T0702...
HPO07R012MM08-02	12	2	42	25	20	10	12.8	M8	0.02	With	AO*T0702...
HPO07R016MM08-04	16	4	42	25	-	10	12.8	M8	0.03	With	AO*T0702...
HPO07R016MM10-04	16	4	49	30	20	15	17.8	M10	0.05	With	AO*T0702...
HPO07R020MM10-05	20	5	49	30	-	15	17.8	M10	0.06	With	AO*T0702...
HPO07R025MM12-07	25	7	57	35	-	17	20.8	M12	0.1	With	AO*T0702...

SPARE PARTS

Designation	① Clamping screw	Lubricant	Wrench
HPO07R012MM0*-02	SR-10503833-S	M-1000	T-7DB
HPO07R016 - 025...	CSTB-2.5L046	M-1000	T-7DB

*Recommended clamping torque : SR-10503833-S = 0.9 N·m, CSTB-2.5L046 = 1.3 N·m

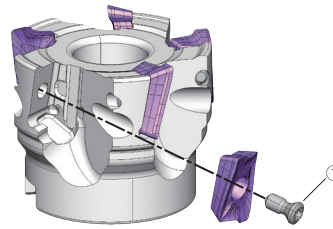

INSERT

AOMT07-MJ

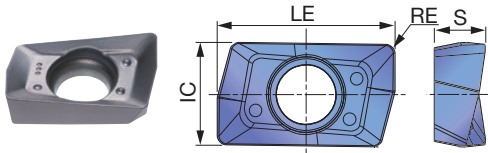

AOMT07-HJ (High feed insert geometry)

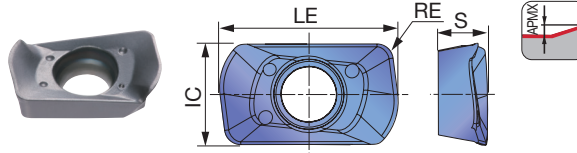

AOGT07-AJ

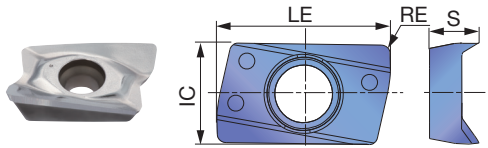

	P	M	K	N	S	H
Steel	★					
Stainless		★ ☆				
Cast iron			★			
Non-ferrous				★		
Superalloys					★	
Hard materials						

★ : First choice
☆ : Second choice

Designation	RE	APMX	Coated		Uncoated	LE	IC	S
			AH140	AH725				
AOMT070202PDPR-MJ	0.008	0.276	●	●		0.315	0.185	0.091
AOMT070204PDPR-MJ	0.016	0.276	●	●		0.315	0.185	0.091
AOMT070208PDPR-MJ	0.031	0.276	●	●		0.315	0.185	0.091
AOMT070216PDPR-MJ	0.063	0.276	●	●		0.315	0.185	0.091
AOMT070208PDPR-HJ	0.031	0.031	●	●		0.346	0.185	0.094
AOGT070204PDFR-AJ	0.016	0.252			●	0.319	0.185	0.091

● : Line up

STANDARD CUTTING CONDITIONS

ISO	Workpiece materials	Hardness HB	Grades	Cutting speed Vc (sfm)	Feed per tooth: fz (ipt)		
					MJ	HJ	AJ
P	Low carbon steel 1018, 1020, 1026, etc.	< 200	AH725	300 - 660	0.002 - 0.004	0.015 - 0.035	-
	High carbon steel and alloy steel 1045, 4140, etc.	200 - 300	AH725	300 - 500	0.002 - 0.004	0.015 - 0.035	-
	Tool steel H13, etc.	150 - 300	AH725	260 - 400	0.002 - 0.004	0.015 - 0.035	-
M	Stainless steel 304SS, 316SS, 17-4 PH, etc.	-	AH140	300 - 500	0.002 - 0.004	0.015 - 0.035	-
K	Gray cast iron Class 25, Class 30, etc.	150 - 250	AH725	330 - 600	0.002 - 0.004	0.015 - 0.035	-
	Ductile cast iron 60-40-18, 60-55-06, etc.	150 - 250	AH725	260 - 500	0.002 - 0.004	0.015 - 0.035	-
N	Aluminum alloys Si < 13%	-	KS15F	1000 - 3300	-	-	0.003 - 0.008
	Aluminum alloys Si ≥ 13%	-	KS15F	330 - 660	-	-	0.003 - 0.008
S	Titanium alloys Ti-6Al-4V, etc.	-	AH725	60 - 160	0.002 - 0.004	0.008 - 0.035	-
	Superalloys Inconel 718, etc.	-	AH725	60 - 115	0.002 - 0.003	0.008 - 0.024	-

- To remove excessive chip accumulation use an air blast.
- To avoid built up edge on the cutting edges (Aluminum machining), use a water soluble coolant.
- When cutting an interrupted surface or a casted skin, the feed per tooth (fz) should be reduced to the lower recommended value shown in the above table.
- Cutting conditions are limited by machine power, workpiece rigidity, and spindle output. When the cutting width, depth, or overhang length is large, set Vc and fz to the lower recommended values and check the machine power and vibration.

CAUTIONARY POINTS WHEN USING HJ INSERTS

HJ type inserts are designed for high feed machining.

Please note the following when using HJ inserts:

1. The shape of HJ insert differs from that of other inserts (MJ, AJ). However the same insert pocket can be used.
2. When using HJ inserts, all the inserts on the cutter body must be HJ type. Do not use other types of inserts (MJ and AJ types) with HJ inserts on the same cutter body.
3. When using CAD/CAM, please program it as a radius cutter. The table below shows the corner R when programming and the uncut area (t).
4. With HJ inserts, the tool diameter increases by 0.024" over the diameter DC shown in the table.

TungRec 07 type HJ inserts Standard conditions

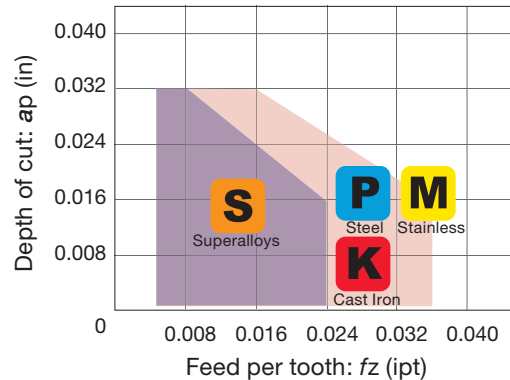

Max. depth of cut APMX (in)	Main cutting edge length LE (in)	Corner R when programming	Amount left uncut t (in)
0.031"	0.118"	R 0.020"	0.016"
		R 0.039"	0.012"

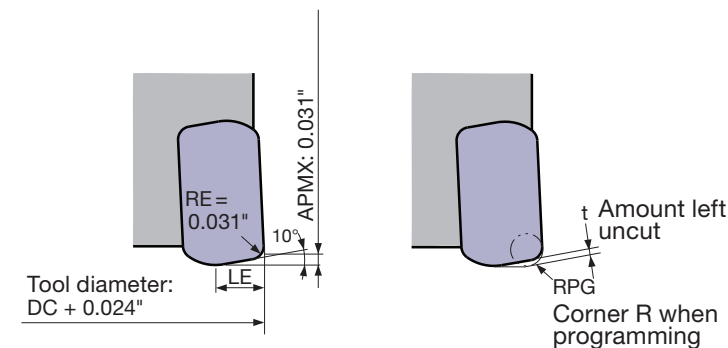

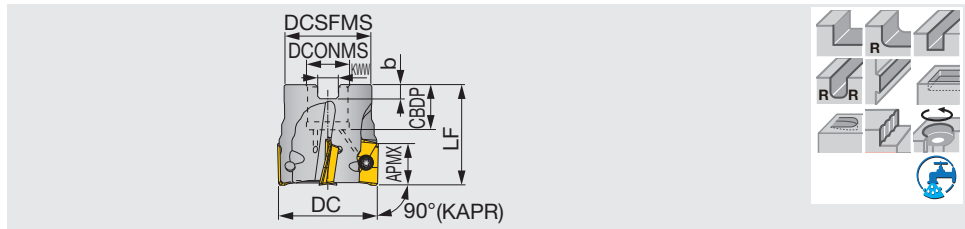

Inch	APMX	DC	CICT	DCSFMS	DCONMS	CBDP	LF	b	KWW	WT(lb)	Air hole	Insert
TPS11200RBU	0.417	2.000	7	1.693	0.750	0.750	1.575	0.197	0.315	0.88	With	AS*T11T3...
TPS11300RBU	0.417	3.000	10	2.283	1.000	1.024	1.969	0.236	0.374	2.64	With	AS*T11T3...
TPS11400RBU	0.417	4.000	11	3.150	1.500	1.457	2.480	0.394	0.626	5.29	With	AS*T11T3...

SPARE PARTS



Designation	Clamping screw	Lubricant	Wrench	Shell locking bolts (Optional parts)
TPS11200RBU	CSPB-2.5	M-1000	IP-8D	(C0.375x1.125H)
TPS11300RBU	CSPB-2.5	M-1000	IP-8D	(C0.500x1.375H)
TPS11400RBU	CSPB-2.5	M-1000	IP-8D	(TMBA-0.750H)

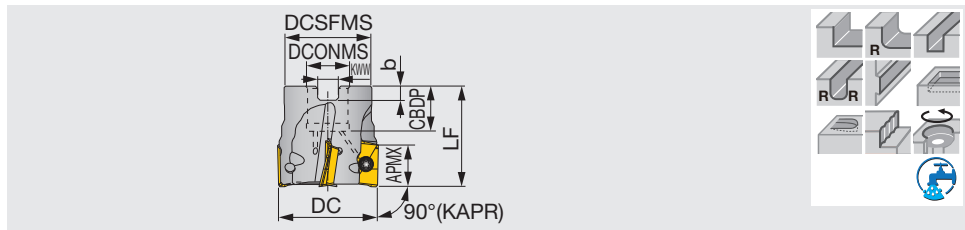

Metric	APMX	DC	CICT	DCSFMS	DCONMS	CBDP	LF	b	KWW	WT(kg)	Air hole	Insert
TPO11R040M16.0E06	10.6	40	6	35	16	18	40	5.6	8.4	0.21	With	AS*T11T3...
TPO11R050M22.0E07	10.6	50	7	45	22	20	40	6.3	10.4	0.35	With	AS*T11T3...
TPO11R063M22.0E08	10.6	63	8	47	22	20	45	6.3	10.4	0.59	With	AS*T11T3...
TPO11R080M25.4-10	10.6	80	10	58	25.4	26	50	6	9.5	1.07	With	AS*T11T3...
TPO11R100M31.75-11	10.6	100	11	70	31.75	32	63	8	12.7	1.95	With	AS*T11T3...
TPO11R080M27.0E10	10.6	80	10	58	27	22	50	7	12.4	1.05	With	AS*T11T3...
TPO11R100M32.0E11	10.6	100	11	70	32	25	63	8	14.4	2.01	With	AS*T11T3...

SPARE PARTS



Designation	Clamping screw	Lubricant	Shell locking bolt	Wrench
TPO11R040M16.0E06	CSPB-2.5	M-1000	CM8X30H	IP-8D
TPO11R050, 063...	CSPB-2.5	M-1000	CM10X30H	IP-8D
TPO11R080M25.4-10	CSPB-2.5	M-1000	CM12X30H	IP-8D
TPO11R100M31.75-11	CSPB-2.5	M-1000	CM16X40H	IP-8D
TPO11R080M27.0E10	CSPB-2.5	M-1000	CM12X30H	IP-8D
TPO11R100M32.0E11	CSPB-2.5	M-1000	CM16X40H	IP-8D

*Recommended clamping torque : CSPB-2.5 = 1.3 N·m



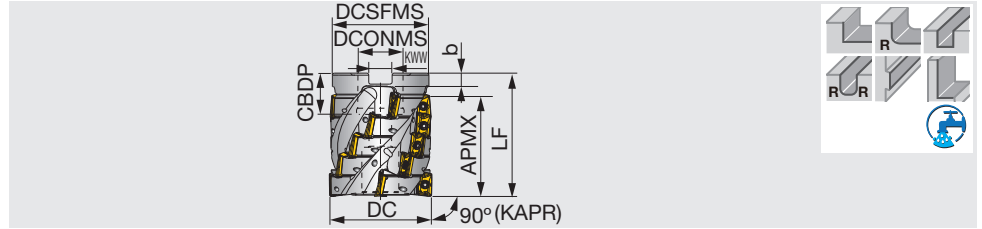

Inch	APMX	DC	ZEFP	CICT	DCSFMS	LF	DCONMS	CBDP	KWW	b	WT(lb)	Air hole	Insert
TLS11R200U0075A04	1.921	2.000	4	20	1.875	2.356	0.750	0.750	0.315	0.197	1.330	With	AS*T11T3...

Coolant needs to be supplied from the end of the arbor inlay. Coolant cannot be supplied from the set bolt.

SPARE PARTS

Designation	Clamping screw	Lubricant	Shell locking bolt	Wrench
TLS11R200U0075A04	CSPB-2.5	M-1000	C0.375X1.125H	IP-8D

*Recommended clamping torque : CSPB-2.5 = 1.3 lb·ft

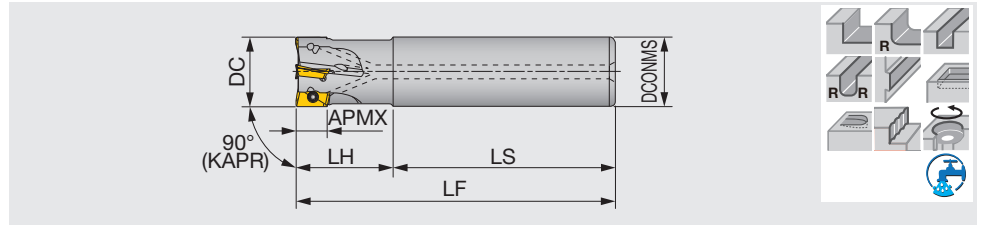

Inch	APMX	DC	CICT	DCONMS	LS	LH	LF	WT(lb)	Air hole	Insert
EPS11050RLU	0.417	0.500	1	0.625	3.750	1.250	5.000	0.350	With	AS*T11T3...
EPS11050RSU	0.417	0.500	1	0.625	2.362	0.984	3.346	0.240	With	AS*T11T3...
EPS11062RLU	0.417	0.625	2	0.625	4.250	1.500	5.750	0.440	With	AS*T11T3...
EPS11062RSU	0.417	0.625	2	0.625	2.362	0.984	3.346	0.240	With	AS*T11T3...
EPS11075RLU	0.417	0.750	2	0.750	5.250	2.000	7.250	0.790	With	AS*T11T3...
EPS11075RSBU	0.417	0.750	3	0.750	2.362	1.181	3.543	0.370	With	AS*T11T3...
EPS11100RLU	0.417	1.000	2	1.000	5.750	2.750	8.500	1.700	With	AS*T11T3...
EPS11100RSBU	0.417	1.000	4	1.000	2.362	1.378	3.740	0.700	With	AS*T11T3...
EPS11100RSBU-3/4	0.417	1.000	4	0.750	2.360	1.378	3.738	0.480	With	AS*T11T3...
EPS11125RLU	0.417	1.250	2	1.250	7.000	3.000	10.000	3.190	With	AS*T11T3...
EPS11125RSBU	0.417	1.250	5	1.250	2.362	1.378	3.740	1.120	With	AS*T11T3...

SPARE PARTS

Designation	Clamping screw	Lubricant	Wrench
EPS11050RLU	CSPB-2.5	M-1000	IP-8D
EPS11050RSU	CSPB-2.5S	M-1000	IP-8D
EPS11062RLU	CSPB-2.5	M-1000	IP-8D
EPS11062RSU	CSPB-2.5S	M-1000	IP-8D
EPS11075RLU	CSPB-2.5	M-1000	IP-8D
EPS11075RSBU	CSPB-2.5S	M-1000	IP-8D
EPS11100RLU	CSPB-2.5	M-1000	IP-8D
EPS11100RSBU	CSPB-2.5	M-1000	IP-8D
EPS11100RSBU-3/4	CSPB-2.5	M-1000	IP-8D
EPS11125RLU	CSPB-2.5	M-1000	IP-8D
EPS11125RSBU	CSPB-2.5	M-1000	IP-8D

High precision square shoulder endmill, shank type, with screw clamp system, for ASMT/ASGT11 inserts

GAMP = +8.7°~+18°, GAMF = -5.3°~-19.4°

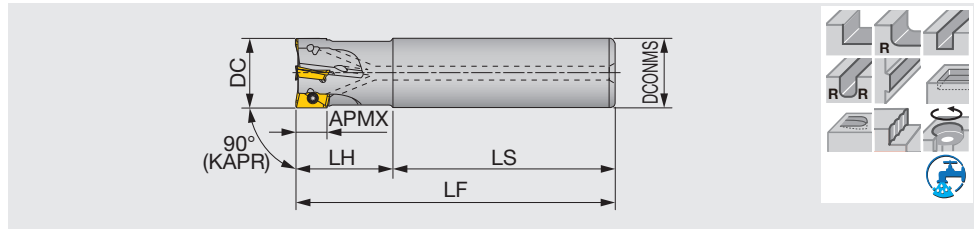

Metric	APMX	DC	CICT	DCONMS	LS	LH	LF	WT(kg)	Air hole	Insert
EPO11R012M16.0-01	10.6	12	1	16	60	25	85	0.11	With	AS*T11T3...
EPO11R012M16.0-01L	10.6	12	1	16	95	30	125	0.16	With	AS*T11T3...
EPO11R016M16.0-02	10.6	16	2	16	60	25	85	0.12	With	AS*T11T3...
EPO11R016M16.0-02L	10.6	16	2	16	105	40	145	0.2	With	AS*T11T3...
EPO11R018M16.0-02	10.6	18	2	16	60	25	85	0.12	With	AS*T11T3...
EPO11R018M16.0-02L	10.6	18	2	16	105	40	145	0.21	With	AS*T11T3...
EPO11R020M20.0-02	10.6	20	2	20	70	30	100	0.22	With	AS*T11T3...
EPO11R020M20.0-02L	10.6	20	2	20	135	50	185	0.41	With	AS*T11T3...
EPO11R020M20.0-03	10.6	20	3	20	70	30	100	0.21	With	AS*T11T3...
EPO11R022M20.0-02	10.6	22	2	20	70	30	100	0.22	With	AS*T11T3...
EPO11R022M20.0-02L	10.6	22	2	20	155	30	185	0.42	With	AS*T11T3...
EPO11R022M20.0-03	10.6	22	3	20	70	30	100	0.22	With	AS*T11T3...
EPO11R025M25.0-02L	10.6	25	2	25	150	70	220	0.76	With	AS*T11T3...
EPO11R025M25.0-03	10.6	25	3	25	80	35	115	0.39	With	AS*T11T3...
EPO11R025M25.0-04	10.6	25	4	25	80	35	115	0.38	With	AS*T11T3...
EPO11R028M25.0-02L	10.6	28	2	25	185	35	220	0.8	With	AS*T11T3...
EPO11R028M25.0-03	10.6	28	3	25	80	35	115	0.4	With	AS*T11T3...
EPO11R028M25.0-04	10.6	28	4	25	80	35	115	0.39	With	AS*T11T3...
EPO11R030M25.0-02L	10.6	30	2	25	180	40	220	0.8	With	AS*T11T3...
EPO11R030M25.0-03	10.6	30	3	25	80	40	120	0.43	With	AS*T11T3...
EPO11R030M25.0-04	10.6	30	4	25	80	40	120	0.42	With	AS*T11T3...
EPO11R032M32.0-02L	10.6	32	2	32	175	80	255	1.48	With	AS*T11T3...
EPO11R032M32.0-03	10.6	32	3	32	80	40	120	0.68	With	AS*T11T3...
EPO11R032M32.0-05	10.6	32	5	32	80	40	120	0.67	With	AS*T11T3...
EPO11R035M32.0-02L	10.6	35	2	32	215	40	255	1.49	With	AS*T11T3...
EPO11R035M32.0-03	10.6	35	3	32	80	40	120	0.69	With	AS*T11T3...
EPO11R035M32.0-05	10.6	35	5	32	80	40	120	0.67	With	AS*T11T3...
EPO11R040M32.0-02L	10.6	40	2	32	205	50	255	1.53	With	AS*T11T3...
EPO11R040M32.0-04	10.6	40	4	32	80	40	120	0.72	With	AS*T11T3...
EPO11R040M32.0-06	10.6	40	6	32	80	40	120	0.71	With	AS*T11T3...
EPO11R050M32.0-05	10.6	50	5	32	80	40	120	0.83	With	AS*T11T3...
EPO11R050M32.0-07	10.6	50	7	32	80	40	120	0.82	With	AS*T11T3...
EPO11R050M42.0-03L	10.6	50	3	42	310	50	360	3.78	With	AS*T11T3...

SPARE PARTS

Designation	Clamping screw	Lubricant	Wrench
EPO11R012 - 022...	CSPB-2.5S	M-1000	IP-8D
EPO11R025 - 050...	CSPB-2.5	M-1000	IP-8D

*Recommended clamping torque : CSPB-2.5/CSPB-2.5S = 1.3 N·m

TUNGREC

HPO11-M

High precision square shoulder endmill, modular type, for ASMT/ASGT11 inserts (TungFlex)

GAMP = +8.7° ~ +18°, GAMF = -5.3° ~ -19.4°

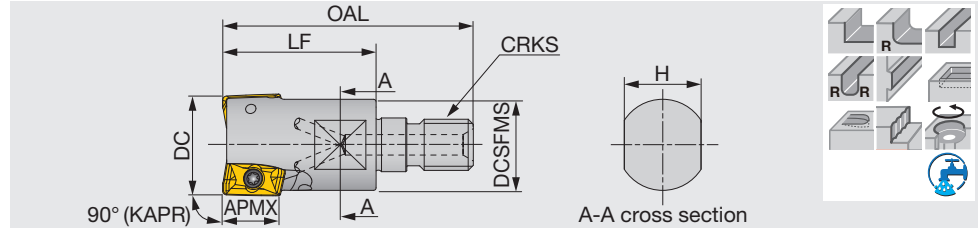

Metric	APMX	DC	CICT	OAL	LF	H	DCSFMS	CRKS	WT(kg)	Air hole	Insert
HPO11R020MM10-02	10.6	20	2	49	30	15	17.8	M10	0.06	With	AS*T11T3...
HPO11R025MM12-03	10.6	25	3	57	35	17	20.8	M12	0.1	With	AS*T11T3...
HPO11R032MM16-03	10.6	32	3	63	40	22	28.8	M16	0.2	With	AS*T11T3...

SPARE PARTS

Designation	Clamping screw	Lubricant	Wrench
HPO11R020MM10-02	CSPB-2.5S	M-1000	IP-8D
HPO11R025, 032...	CSPB-2.5	M-1000	IP-8D

*Recommended clamping torque : CSPB-2.5/CSPB-2.5S = 1.3 N·m

TUNGREC

ELS11

High efficiency roughing endmill, shank type, for ASMT/ASGT11 inserts

GAMP = +8.7° ~ +18°, GAMF = -5.3° ~ -19.4°

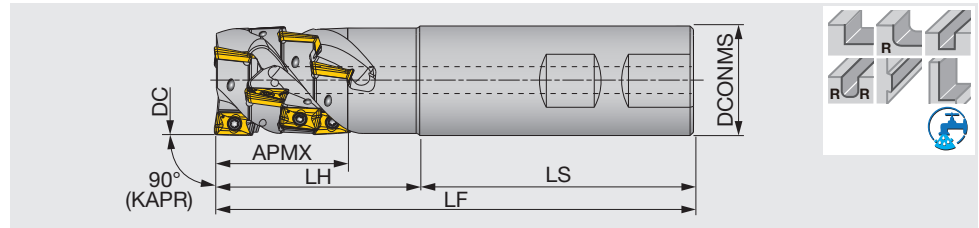

Inch	APMX	DC	ZEFP	CICT	DCONMS	LS	LH	LF	WT(lb)	Air hole	Insert
ELS11R100U0100W02	1.197	1.000	2	6	1.000	2.250	1.500	3.750	0.670	With	AS*T11T3...
ELS11R125U0125W03	1.535	1.250	3	12	1.250	2.250	2.250	4.500	1.330	With	AS*T11T3...
ELS11R150U0125W03	1.575	1.500	3	12	1.250	2.329	2.171	4.500	1.330	With	AS*T11T3...

SPARE PARTS

Designation	Clamping screw	Lubricant	Wrench
ELS11...	CSPB-2.5	M-1000	IP-8D

*Recommended clamping torque : CSPB-2.5 = 1.3 lbs·ft

Reference pages: Inserts → **H123**, Standard cutting conditions → **H124 - H125**, Tung Flex → **H167**

INSERT

ASMT11-MJ

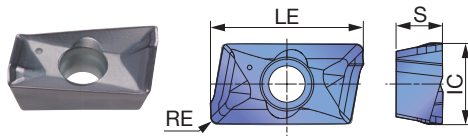

ASMT11-MS

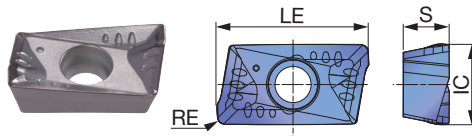

ASGT11-AJ

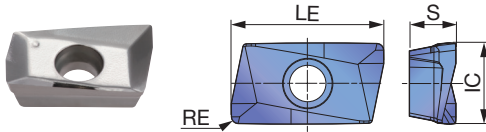

P Steel	☆			★			★							
M Stainless		★	★	☆										
K Cast iron	★			☆	☆	★								
N Non-ferrous								★		★				
S Superalloys	★	★		★										
H Hard materials														

★ : First choice
☆ : Second choice

Designation	RE	APMX	Coated							Cermet	Uncoated	LE	IC	S			
			AH120	AH130	AH140	AH725	T1115	T1215	T3130	DS1100	NS740				KS05F		
ASMT11T304PDPR-MJ	0.016	0.417	●	●		●	●			●					0.457	0.264	0.146
ASMT11T308PDPR-MJ	0.031	0.417	●	●	●	●	●	●		●					0.457	0.264	0.146
ASMT11T312PDPR-MJ	0.047	0.417	●			●				●					0.457	0.264	0.146
ASMT11T316PDPR-MJ	0.063	0.417	●			●				●					0.457	0.264	0.146
ASMT11T320PDPR-MJ	0.079	0.417	●							●					0.457	0.264	0.146
ASMT11T330PDPR-MJ	0.118	0.417	●	●											0.457	0.264	0.146
ASMT11T304PDPR-MS	0.016	0.417		●	●										0.457	0.264	0.146
ASGT11T304PDRF-AJ	0.016	0.417								●		●			0.457	0.264	0.146
ASGT11T308PDRF-AJ	0.031	0.417								●		●			0.457	0.264	0.146

● : Line up

Grade
Insert
Ext. Toolholder
Int. Toolholder
Threading
Grooving
Miniature Tool
Endmill
Drilling Tool
User's Guide Tooling System
Index



STANDARD CUTTING CONDITIONS

TPO11/EPO11/HPO11 type

ISO	Workpiece material	Brinell hardness HB	Priority	Grade	Cutting speed: Vc (sfm)	Feed per tooth: fz (ipt)			
						MJ	MS	AJ	
P	Low carbon steel 1018, 1020, 1026, etc.	~ 200	First choice	AH725	330 - 820	0.004 - 0.008	-	-	
		~ 200	Wear resistance	T3130	330 - 820	0.004 - 0.008	-	-	
		~ 200	Surface quality	NS740	330 - 820	0.002 - 0.006	-	-	
	High carbon steel and alloy steel 1045, 4140, etc.	200 ~ 300	First choice	AH725	330 - 660	0.004 - 0.008	-	-	
		200 ~ 300	Wear resistance	T3130	330 - 660	0.004 - 0.008	-	-	
		200 ~ 300	Surface quality	NS740	330 - 660	0.002 - 0.005	-	-	
	Tool steel H13, etc.	150 ~ 300	First choice	AH725	330 - 500	0.003 - 0.006	-	-	
		150 ~ 300	Wear resistance	T3130	330 - 500	0.003 - 0.006	-	-	
	M	Stainless steel 304SS, 316SS, 17-4 PH, etc.	-	-	AH130	260 - 660	-	0.003 - 0.008	-
	K	Gray cast iron Class 25, Class 30, etc.	150 ~ 250	First choice	AH120	330 - 820	0.005 - 0.01	-	-
			150 ~ 250	Wear resistance	T1215 T1115	330 - 820	0.005 - 0.01	-	-
		Ductile cast iron 60-40-18, 60-55-06, etc.	150 ~ 250	First choice	AH120	260 - 660	0.005 - 0.01	-	-
150 ~ 250			Wear resistance	T1215 T1115	260 - 660	0.005 - 0.01	-	-	
N	Aluminum alloys Si < 13%	-	-	DS1100	1000 - 3300	-	-	0.002 - 0.008	
	Aluminum alloys Si ≥ 13%	-	-	DS1100	330 - 660	-	-	0.002 - 0.008	
	Copper alloys	-	-	KS05F	660 - 1650	-	-	0.002 - 0.008	
S	Titanium alloys Ti-6Al-4V, etc.	-	-	AH130	60 - 200	-	0.003 - 0.006	-	
	Superalloys Inconel 718, etc.	-	-	AH725	60 - 130	0.003 - 0.005	-	-	

CAUTIONARY POINT IN MODIFYING CUTTER BODIES

When using inserts with corner radius $RE \geq 0.079$ " (2 mm), standard cutter bodies have to be modified "R". (Only for TPO11, EPO11, TLS11, ELS11, HPO11)

About roughing type TLS11, ELS11
From 2nd row onwards, please use insert with $RE = 0.016$ " or 0.031 "

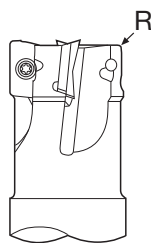

Corner radius RE (in)	The dimension of modifying (in)
0.016 - 0.063	Unnecessary
0.079 - 0.118	0.080

STANDARD CUTTING CONDITIONS

Roughing type TLS11 / ELS11

ISO	Workpiece material	Brinell hardness HB	Priority	Grade	Cutting speed: Vc (sfm)	Feed per tooth: fz (ipt)		
						MJ	MS	AJ
P	Low carbon steel 1018, 1020, 1026, etc.	~ 200	First choice	AH725	330 - 820	0.002 - 0.007	-	-
		~ 200	Wear resistance	T3130	330 - 820	0.002 - 0.007	-	-
	High carbon steel and alloy steel 1045, 4140, etc.	200 ~ 300	First choice	AH725	330 - 660	0.003 - 0.006	-	-
		200 ~ 300	Wear resistance	T3130	330 - 660	0.003 - 0.006	-	-
	Tool steel H13, etc.	150 ~ 300	First choice	AH725	330 - 500	0.003 - 0.006	-	-
		150 ~ 300	Wear resistance	T3130	330 - 500	0.003 - 0.006	-	-
M	Stainless steel 304SS, 316SS, 17-4 PH, etc.	-	-	AH130	330 - 500	-	0.003 - 0.006	-
K	Gray cast iron Class 25, Class 30, etc.	150 ~ 250	First choice	AH120	330 - 800	0.004 - 0.007	-	-
		150 ~ 250	Wear resistance	T1215 T1115	330 - 800	0.004 - 0.007	-	-
	Ductile cast iron 60-40-18, 60-55-06, etc.	150 ~ 250	First choice	AH120	260 - 650	0.004 - 0.007	-	-
		150 ~ 250	Wear resistance	T1215 T1115	260 - 650	0.004 - 0.007	-	-
N	Aluminum alloys Si < 13%	-	-	DS1100	650 - 1650	-	-	0.002 - 0.007
	Aluminum alloys Si ≥ 13%	-	-	DS1100	330 - 650	-	-	0.002 - 0.007
S	Titanium alloys Ti-6Al-4V, etc.	-	-	AH130	60 - 200	0.003 - 0.006	-	-
	Superalloys Inconel718, etc.	-	-	AH725	60 - 130	0.003 - 0.005	-	-

- To remove excessive chip accumulation use an air blast.
- To avoid built up edge on the cutting edges (Aluminum machining), use a water soluble coolant.
- When cutting an interrupted surface or a casted skin, the feed per tooth (fz) should be reduced to the lower recommended value shown in the above table.

· Cutting conditions are limited by machine power, workpiece rigidity, and spindle output. When the cutting width, depth, or overhang length is large, set Vc and fz to the lower recommended values and check the machine power and vibration.

Grade
Insert
Ext. Toolholder
Int. Toolholder
Threading
Grooving
Miniature Tool
Milling Cutter
Endmill
Drilling Tool
Tooling System
User's Guide
Index



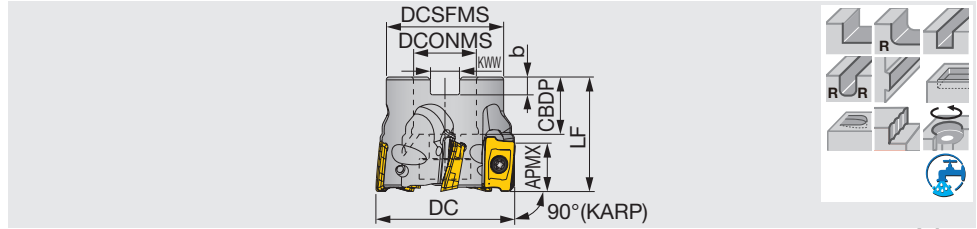

Inch	APMX	DC	CICT	DCSFMS	LF	DCONMS	CBDP	KWW	b	WT(lb)	Air hole	Insert	Arbor type
TPO18R200U0075A05	0.657	2.000	5	1.625	1.570	0.750	0.750	0.315	0.197	0.780	With	AO*T1805...	A
TPO18R250U0075A06	0.657	2.500	6	2.125	1.570	0.750	0.750	0.315	0.197	1.320	With	AO*T1805...	A
TPO18R300U0100A07	0.657	3.000	7	2.250	1.750	1.000	1.000	0.374	0.236	1.890	With	AO*T1805...	A
TPO18R400U0150A08	0.657	4.000	8	3.000	2.000	1.500	1.060	0.630	0.354	3.140	Without	AO*T1805...	B
TPO18R500U0150A09	0.657	5.000	9	4.000	2.000	1.500	1.060	0.630	0.354	6.270	Without	AO*T1805...	B
TPO18R600U0200A10	0.657	6.000	10	4.750	2.000	2.000	1.060	0.748	0.394	8.370	Without	AO*T1805...	B

SPARE PARTS

Designation	Clamping screw	Grip	Torx bit	Shell locking bolt (Optional parts)
TPO18R200..., 250...	CSTB-4L093	H-TBS	BT15M	(C0.375X1.125H)
TPO18R300...	CSTB-4L120	H-TBS	BT15M	(C0.500X1.375H)
TPO18R400..., 500...	CSTB-4L120	H-TBS	BT15M	(TMBA-0.750H)
TPO18R600...	CSTB-4L120	H-TBS	BT15M	-

*Recommended clamping torque :
CSTB-4L093 = 2.58 lbs·ft, CSTB-4L120 = 2.58 lbs·ft

Arbor type

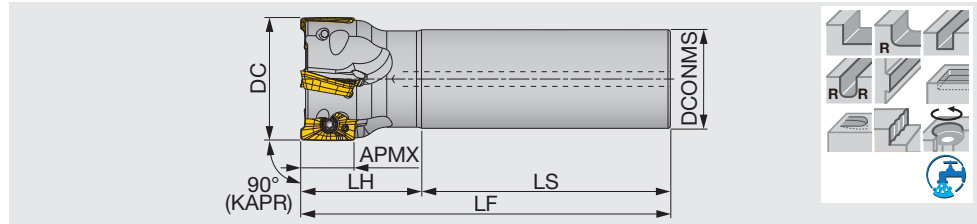
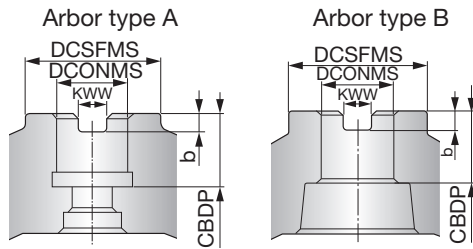

Inch	APMX	DC	CICT	DCONMS	LS	LH	LF	WT(lb)	Air hole	Insert
EPO18R100U0100W02	0.657	1.000	2	1.000	2.250	1.750	4.000	0.730	With	AO*T1805...
EPO18R100U0100W02L	0.657	1.000	2	1.000	2.250	2.750	5.000	0.910	With	AO*T1805...
EPO18R125U0125W03	0.657	1.250	3	1.250	2.250	2.250	4.500	1.320	With	AO*T1805...
EPO18R125U0125W03L	0.657	1.250	3	1.250	2.250	4.250	6.500	1.880	With	AO*T1805...
EPO18R150U0125W03L	0.657	1.500	3	1.250	2.250	4.250	6.500	2.420	With	AO*T1805...
EPO18R150U0125W04	0.657	1.500	4	1.250	2.250	2.250	4.500	1.460	With	AO*T1805...
EPO18R200U0125W05	0.657	2.000	5	1.250	2.250	2.250	4.500	1.680	With	AO*T1805...

*The DC above is the diameter when using MJ chipbreaker. With AJ chipbreaker, the tool diameter is (DC above + 0.008").

SPARE PARTS

Designation	Clamping screw	Wrench
EPO18R100U...	CSTB-4L085	T-15DB
EPO18R125U..., -200U	CSTB-4L093	T-15DB

*Recommended clamping torque : CSTB-4L093 = 2.58 lbs·ft, CSTB-4L120 = 2.58 lbs·ft

Reference pages: Inserts, Standard cutting conditions → **H127**

INSERT

AOMT18-MJ

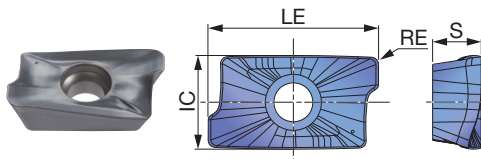

AOGT18-AJ

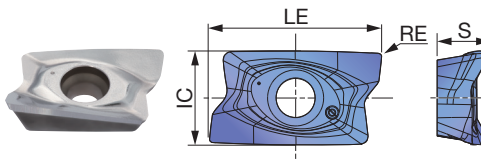

P	Steel		★						
M	Stainless	★	☆						
K	Cast iron		★						
N	Non-ferrous			★					
S	Superalloys		★						
H	Hard materials								

★ : First choice
☆ : Second choice

Designation	RE	APMX	Coated		Uncoated		LE	IC	S
			AH140	AH725	KS15F				
AOMT180508PDPR-MJ	0.031	0.657	●	●			0.768	0.421	0.220
AOMT180516PDPR-MJ	0.063	0.657	●	●			0.768	0.421	0.220
AOMT180524PDPR-MJ	0.094	0.657	●	●			0.768	0.421	0.220
AOMT180532PDPR-MJ	0.126	0.657	●	●			0.768	0.421	0.220
AOGT180504PDRF-AJ	0.016	0.657			●		0.780	0.425	0.240
AOGT180508PDRF-AJ	0.031	0.657			●		0.780	0.425	0.240

● : Line up

STANDARD CUTTING CONDITIONS

TPO18/EPO18 type

ISO	Workpiece material	Brinell hardness HB	Priority	Cutting speed: Vc (sfm)	Feed per tooth: fz (ipt)	
					MJ	AJ
P	Low carbon steel 1018, 1020, 1026, etc.	~ 200	AH725	330 - 820	0.003 - 0.010	-
	High carbon steel and alloy steel 1045, 4140, etc.	200 ~ 300	AH725	330 - 750	0.003 - 0.008	-
	Tool steel H13, etc.	150 ~ 300	AH725	330 - 600	0.003 - 0.008	-
M	Stainless steel 304SS, 316SS, 17-4 PH, etc.	-	AH140	330 - 660	0.003 - 0.008	-
K	Gray cast iron Class 25, Class 30, etc.	150 ~ 250	AH725	330 - 820	0.003 - 0.010	-
	Ductile cast iron 60-40-18, 60-55-06, etc.	150 ~ 250	AH725	260 - 660	0.003 - 0.010	-
N	Aluminum alloys Si < 13%	-	KS15F	1000 - 3300	-	0.002 - 0.010
	Aluminum alloys Si ≥ 13%	-	KS15F	330 - 660	-	0.002 - 0.010
S	Titanium alloys Ti-6Al-4V, etc.	-	AH725	60 - 200	0.003 - 0.007	-
	Superalloys Inconel718, etc.	-	AH725	60 - 130	0.003 - 0.006	-

- To remove excessive chip accumulation use an air blast.
- To avoid built up edge on the cutting edges (Aluminum machining), use a water soluble coolant.
- When cutting an interrupted surface or a casted skin, the feed per tooth (fz) should be reduced to the lower recommended value shown in the above table.

- Cutting conditions are limited by machine power, workpiece rigidity, and spindle output. When the cutting width, depth, or overhang length is large, set Vc and fz to the lower recommended values and check the machine power and vibration.



APPLICATION RANGE

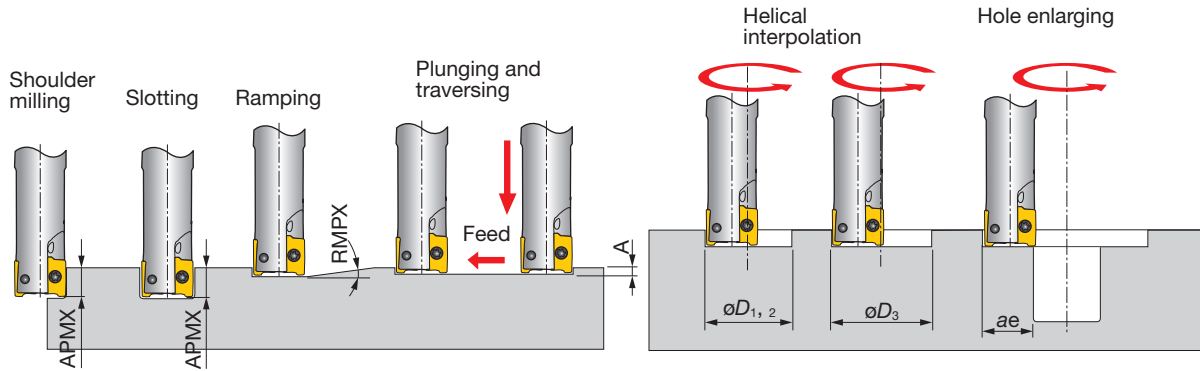

	Tool dia.	Chipbreaker	Max. depth of cut	Max. ramping angle	Max. plunging depth	Min. machining	Max. machining		Max. cutting width in enlarging
Inch	DC		APMX	RMPX	A	øD1	øD2	øD3*	ae
EPO07R050U0050-02	0.500	MJ, AJ	0.276	7.5	0.020	0.750	0.862	0.862	0.480
	0.524	HJ	0.031	4.5	0.030	0.786	-	-	0.406
EPO07R063U0063-04	0.625	MJ, AJ	0.276	5	0.020	0.938	1.112	1.112	0.610
	0.649	HJ	0.031	4	0.030	0.974	-	-	0.531
EPO07R075U0075-05	0.750	MJ, AJ	0.276	3.5	0.020	1.125	1.362	1.362	0.730
	0.774	HJ	0.031	2.5	0.030	1.161	-	-	0.656
EPO07R100U...	1.000	MJ, AJ	0.276	2.4	0.020	1.500	1.862	1.862	0.980
	1.024	HJ	0.031	2	0.030	1.536	-	-	0.906
EPS11050...	0.500	MJ, MS, AJ	0.417	6	0.020	0.590	0.882	0.882	0.480
EPS11062...	0.625	MJ, MS, AJ	0.417	5	0.020	0.790	1.332	1.332	0.610
EPS11075...	0.750	MJ, MS, AJ	0.417	3	0.020	1.100	1.382	1.382	0.730
EPS11100...	1.000	MJ, MS, AJ	0.417	2	0.020	1.500	1.882	1.882	0.980
EPS11125...	1.250	MJ, MS, AJ	0.417	1.5	0.020	2.050	2.382	2.382	1.230
EPO18R100U...	1.000	MJ, AJ	0.657	5.5	0.039	1.272	1.764	1.764	0.961
EPO18R125U...	1.250	MJ, AJ	0.657	3.5	0.039	1.772	2.264	2.264	1.211
EPO18R150U...	1.500	MJ, AJ	0.657	2.7	0.039	2.272	2.764	2.764	1.461
T/EPO18R200U...	2.000	MJ, AJ	0.657	1.9	0.039	3.272	3.764	3.764	1.961

	Tool dia.	Chipbreaker	Max. depth of cut	Max. ramping angle	Max. plunging depth	Min. machining	Max. machining		Max. cutting width in enlarging
Inch	DC		APMX	RMPX	A	øD1	øD2	øD3*	ae
TPO07R200U0075A12	2.000	MJ, AJ	0.276	0.9	0.020	3.000	3.960	3.862	1.980
	2.024	HJ	0.031	0.6	0.030	3.036	4.008	-	1.906
TPS11200RBU	2.000	MJ, MS, AJ	0.417	0.7	0.020	3.460	3.900	3.882	1.950
TPS11300RBU	3.000	MJ, MS, AJ	0.417	0.4	0.020	5.830	6.260	5.882	3.130
TPS11400RBU	4.000	MJ, MS, AJ	0.417	0.3	0.020	7.400	7.830	7.882	3.920
TPO18R250U0075A06	2.500	MJ, AJ	0.657	1.4	0.039	4.272	4.921	4.764	2.461
TPO18R300U0100A07	3.000	MJ, AJ	0.657	1.1	0.039	5.272	5.921	5.764	2.961
TPO18R400U0150A08	4.000	MJ, AJ	0.657	0.8	0.039	7.272	7.921	7.764	3.961
TPO18R500U0150A09	5.000	MJ, AJ	0.657	0.6	0.039	9.272	9.921	9.764	4.961
TPO18R600U0200A10	6.000	MJ, AJ	0.657	0.5	0.039	11.272	11.921	11.764	5.961

*Flat bottom hole
 Corner RE for dimensions of øD1, øD2, and øD3: RE = 0.016" for EPO07 / EPO11 and RE = 0.031" for EPO18.

High density square shoulder mill, with screw clamp system, for SDMT/SDHT05 inserts

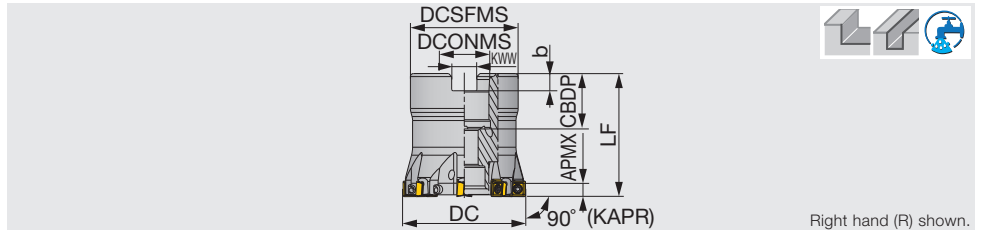

GAMP = +5°, GAMF = -7° ~ +12°

Inch	APMX	DC	CICT	DCSFMS	LF	DCONMS	CBDP	KWW	b	WT(lb)	Air hole	Insert
TPD05R150U0075A08	0.157	1.500	8	1.461	1.570	0.750	0.750	0.313	0.170	0.220	With	SD*T0502...
TPD05R200U0075A10	0.157	2.000	10	1.750	1.570	0.750	0.750	0.313	0.170	0.440	With	SD*T0502...

SPARE PARTS



Designation	Clamping screw	Wrench	Shell locking bolt (Optional parts)
TPD05...	CSPB-2L043	IP-6DB	(C0.375X1.125H)

*Recommended clamping torque : CSPB-2L043 = 0.52 lbs·ft

High density square shoulder endmill, shank type, with screw clamp system, for SDMT/SDHT05 inserts

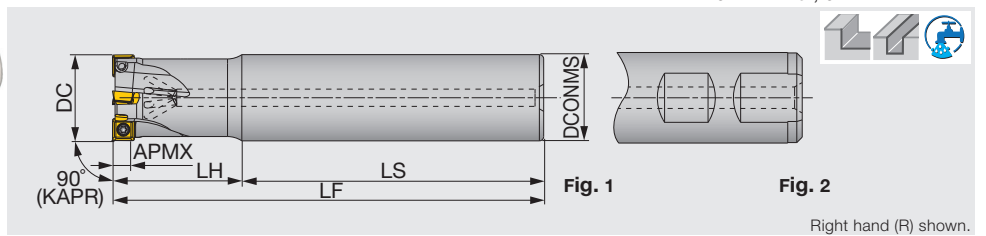

GAMP = +5°, GAMF = -7° ~ +12°

Inch	APMX	DC	CICT	DCONMS	LS	LH	LF	WT(lb)	Air hole	Shank	Insert	Shank type
EPD05R050U0050-02	0.157	0.500	2	0.500	1.780	1.220	3.000	0.220	With	Straight	SD*T0502...	Fig .1
EPD05R063U0063-03	0.157	0.625	3	0.625	2.000	1.500	3.500	0.440	With	Straight	SD*T0502...	Fig .1
EPD05R075U0075W04	0.157	0.750	4	0.750	2.030	1.720	3.750	0.440	With	Weldon	SD*T0502...	Fig .2
EPD05R100U0100W05	0.157	1.000	5	1.000	2.280	1.720	4.000	0.660	With	Weldon	SD*T0502...	Fig .2
EPD05R125U0100W06	0.157	1.000	6	1.250	2.280	1.720	4.000	1.100	With	Weldon	SD*T0502...	Fig .2

SPARE PARTS



Designation	Clamping screw	Wrench
EPD05...	CSPB-2L043	IP-6DB

*Recommended clamping torque : CSPB-2L043 = 0.52 lbs·ft



High density square shoulder endmill for roughing, shank type, with screw clamp system, for SDMT/SDHT05 inserts

GAMP = +5°, GAMF = -3°

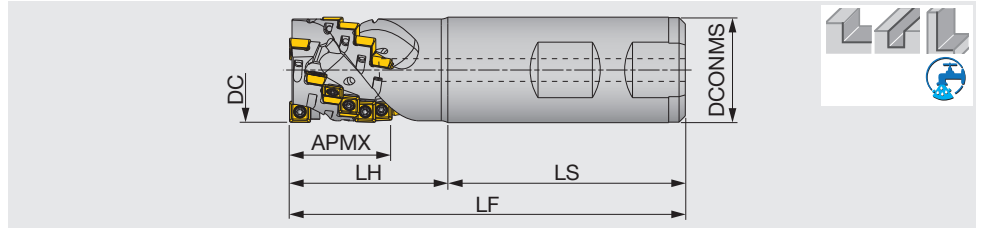
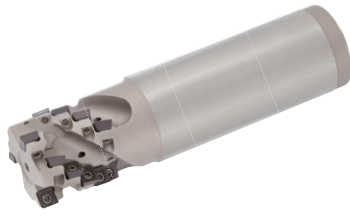

Inch	APMX	DC	ZEFP	CICT	DCONMS	LS	LH	LF	WT(lb)	Air hole	Insert
ELD05R075U0075W02	0.799	0.750	2	10	0.750	2.031	1.219	3.250	0.440	With	SD*T0502...
ELD05R100U0100W03	0.953	1.000	3	18	1.000	2.250	1.500	3.750	0.670	With	SD*T0502...

SPARE PARTS

Designation	Clamping screw	Wrench
ELD05...	CSPB-2L043	IP-6DB

*Recommended clamping torque : CSPB-2L043 = 0.52 lbs·ft

INSERT

SDMT05-MJ

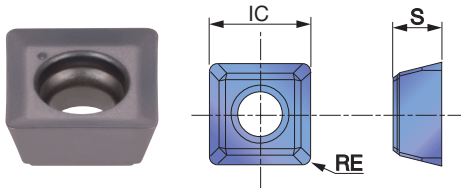

SDHT05-AJ

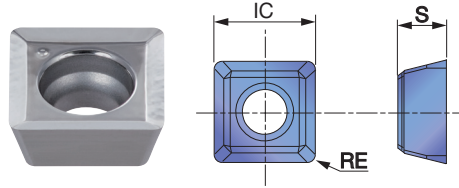

	P	M	K	N	S	H
Steel	★					
Stainless	★	☆				
Cast iron	★					
Non-ferrous				★		
Superalloys		★				
Hard materials						

★ : First choice
☆ : Second choice

Designation	RE	APMX	Coated		Uncoated		S	IC
			AH140	AH725	TH10			
SDMT050204PN-MJ	0.016	0.157	●	●			0.094	0.200
SDHT050204FN-AJ	0.016	0.157			●		0.094	0.200

● : Line up

Reference pages: Inserts → **H130**, Standard cutting conditions → **H131**

STANDARD CUTTING CONDITIONS

■ Bore, shank type TPD05/EPD05

ISO	Workpiece material	Brinell hardness HB	Grade	Cutting speed Vc (sfm)	Feed per tooth fz (ipt)
P	Low carbon steel 1018, 1020, 1026, etc.	~ 200	AH725	750 - 1050	0.0015 - 0.004
	High carbon steel 1045, 1055, etc.	200 ~ 300	AH725	500 - 750	0.0015 - 0.004
	Alloyed steel 4140, 8620, etc.	150 ~ 300	AH725	500 - 750	0.0015 - 0.004
	Tool steel W1-8, etc.	~ 300	AH725	350 - 440	0.001 - 0.0035
M	Stainless steel 304SS, 316SS, 17-4 PH, etc.	-	AH140	330 - 650	0.001 - 0.0035
K	Gray cast iron Class 25, Class 30, etc.	150 ~ 250	AH725	500 - 820	0.002 - 0.005
	Ductile cast iron 60-40-18, 60-55-06, etc.	150 ~ 250	AH725	330 - 590	0.002 - 0.005
N	Aluminum alloys Si < 13%	-	TH10	1150 - 1600	0.002 - 0.006
	Aluminum alloys Si ≥ 13%	-	TH10	330 - 650	0.002 - 0.006

* For deep and wide cutting, set the Vc and fz to the lower recommended limits and check the vibration and spindle load of the machine.

■ Roughing type ELD05

ISO	Workpiece material	Brinell hardness HB	Grade	Cutting speed Vc (sfm)	Feed per tooth fz (ipt)
P	Low carbon steel 1018, 1020, 1026, etc.	~ 200	AH725	330 - 820	0.0015 - 0.004
	High carbon steel 1045, 1055, etc.	200 ~ 300	AH725	330 - 660	0.0015 - 0.004
	Alloyed steel 4140, 8620, etc.	150 ~ 300	AH725	330 - 660	0.0015 - 0.004
	Tool steel W1-8, etc.	~ 300	AH725	330 - 400	0.0012 - 0.0035
M	Stainless steel 304SS, 316SS, 17-4 PH, etc.	-	AH140	300 - 500	0.0012 - 0.0035
K	Gray cast iron Class 25, Class 30, etc.	150 ~ 250	AH725	330 - 820	0.002 - 0.005
	Ductile cast iron 60-40-18, 60-55-06, etc.	150 ~ 250	AH725	260 - 660	0.002 - 0.005
N	Aluminum alloys Si < 13%	-	TH10	660 - 1650	0.002 - 0.006
	Aluminum alloys Si ≥ 13%	-	TH10	330 - 650	0.002 - 0.006

Grade
Insert
Ext. Toolholder
Int. Toolholder
Threading
Grooving
Milling Cutter
Endmill
Drilling Tool
User's Guide Tooling System
Index



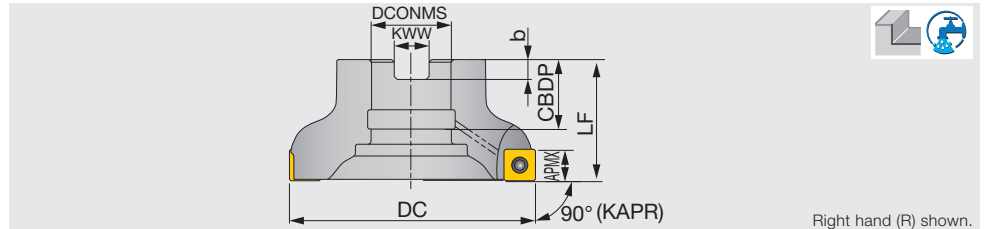
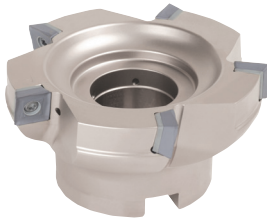

Right hand (R) shown.

Inch	APMX	DC	CICT	LF	DCONMS	CBDP	KWW	b	WT(lb)	Air hole	Insert	Arbor type
TPW13R200U0075A03	0.394	2.000	3	1.575	0.750	0.750	0.315	0.197	0.660	With	SW*T1304...	A
TPW13R200U0075A04	0.394	2.000	4	1.575	0.750	0.750	0.315	0.197	0.660	With	SW*T1304...	A
TPW13R200U0075A05	0.394	2.000	5	1.575	0.750	0.750	0.315	0.197	0.660	With	SW*T1304...	A
TPW13R300U0100A04	0.394	3.000	4	1.969	1.000	1.024	0.374	0.236	1.760	With	SW*T1304...	A
TPW13R300U0100A06	0.394	3.000	6	1.969	1.000	1.024	0.374	0.236	1.540	With	SW*T1304...	A
TPW13R300U0100A08	0.394	3.000	8	1.969	1.000	1.024	0.374	0.236	1.760	With	SW*T1304...	A
TPW13R400U0150A05	0.394	4.000	5	1.969	1.500	1.378	0.626	0.394	3.530	With	SW*T1304...	B
TPW13R400U0150A07	0.394	4.000	7	1.969	1.500	1.378	0.626	0.394	3.310	With	SW*T1304...	B
TPW13R400U0150A10	0.394	4.000	10	1.969	1.500	1.378	0.626	0.394	3.310	With	SW*T1304...	B
TPW13R500U0150A06	0.394	5.000	6	2.480	1.500	1.457	0.626	0.394	5.510	With	SW*T1304...	B
TPW13R500U0150A08	0.394	5.000	8	2.480	1.500	1.457	0.626	0.394	5.290	With	SW*T1304...	B
TPW13R500U0150A12	0.394	5.000	12	2.480	1.500	1.457	0.626	0.394	5.510	With	SW*T1304...	B
TPW13R600U0200A08	0.394	6.000	8	2.480	2.000	1.496	0.748	0.433	7.940	With	SW*T1304...	B
TPW13R600U0200A12	0.394	6.000	12	2.480	2.000	1.496	0.748	0.433	8.160	With	SW*T1304...	B
TPW13R600U0200A15	0.394	6.000	15	2.480	2.000	1.496	0.748	0.433	8.160	Without	SW*T1304...	B

SPARE PARTS



Designation	① Clamping screw	Lubricant	② Shim screw	Shell locking bolt	③ Shim	Wrench for ①	Wrench for ②
TPW13R200...	CSPB-3.5	M-1000	DTS5-3.5SS	C0.375X1.125H	FSSP1102	IP-15D	P-3.5
TPW13R300...	CSPB-3.5	M-1000	DTS5-3.5SS	C0.500X1.375H	FSSP1102	IP-15D	P-3.5
TPW13R400..., 500...	CSPB-3.5	M-1000	DTS5-3.5SS	TMBA-0.750H	FSSP1102	IP-15D	P-3.5
TPW13R600...	CSPB-3.5	M-1000	DTS5-3.5SS	-	FSSP1102	IP-15D	P-3.5

*Recommended clamping torque : CSPB-3.5 = 2.58 lbs·ft

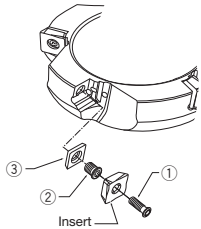

Arbor type

Arbor type A

Arbor type B

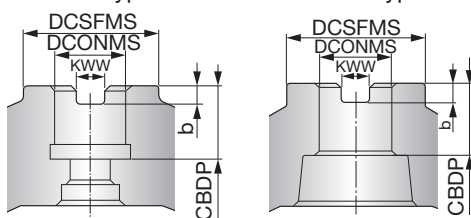

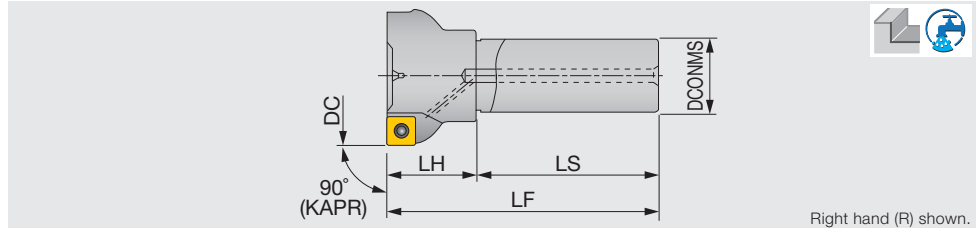

Right hand (R) shown.

Metric	APMX	DC	CICT	DCONMS	LS	LH	LF	WT(kg)	Air hole	Insert
EPW13R032M32.0-02	10	32	2	32	80	35	115	0.6	With	SW*T1304...
EPW13R040M32.0-03	10	40	3	32	80	35	115	0.7	With	SW*T1304...
EPW13R050M32.0-03	10	50	3	32	80	40	120	0.9	With	SW*T1304...
EPW13R050M32.0-04	10	50	4	32	80	40	120	0.9	With	SW*T1304...
EPW13R063M32.0-04	10	63	4	32	80	40	120	1	With	SW*T1304...
EPW13R063M32.0-05	10	63	5	32	80	40	120	1	With	SW*T1304...
EPW13R080M32.0-04	10	80	4	32	80	40	120	1.3	With	SW*T1304...
EPW13R080M32.0-06	10	80	6	32	80	40	120	0.8	With	SW*T1304...

SPARE PARTS

Designation	① Clamping screw	Lubricant	② Shim screw	③ Shim	Wrench for ①	Wrench for ②
EPW13R032_040...	CSPB-3.5	M-1000	-	-	IP-15D	-
EPW13R050 - 080...	CSPB-3.5	M-1000	DTS5-3.5SS	FSSP1102	IP-15D	P-3.5

*Recommended clamping torque : CSPB-3.5 = 3.5 N.m

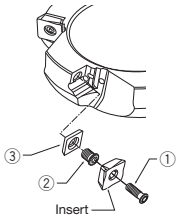

INSERT

SWG1304-MJ

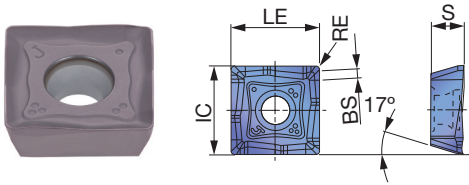

SWMT1304-MJ

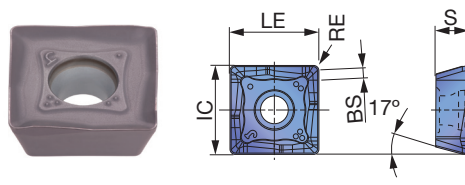

SWMT1304-ML

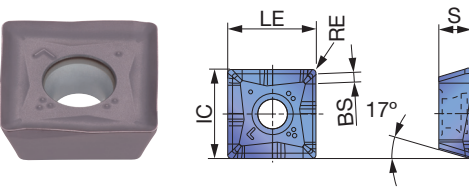

SWMT1304-MS

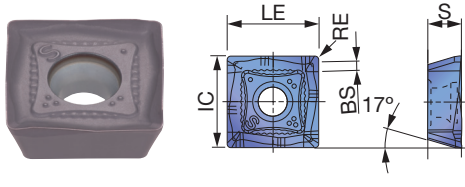

SWG1304-AJ

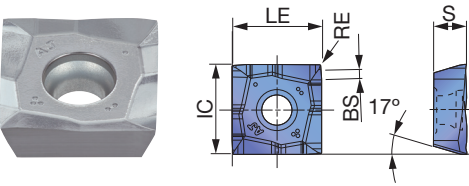

P	Steel	☆		★		☆	☆	★					
M	Stainless		★	☆	★				☆				
K	Cast iron	★				☆	★						
N	Non-ferrous								★		★		
S	Superalloys	★	☆										
H	Hard materials												

★ : First choice
☆ : Second choice

Designation	RE	APMX	Coated							Cermet	Uncoated	LE	IC	S	BS			
			AH120	AH130	AH140	AH3135	T1115	T1215	T3130	T3225	DS1100					NS740	KS05F	
SWG1304PDPR-MJ	0.031	0.394	●	●							●				0.535	0.535	0.197	0.055
SWMT1304PDPR-MJ	0.031	0.394	●	●	●	●	●	●	●		●				0.535	0.535	0.197	0.055
SWMT1304PDER-ML	0.031	0.394	●			●									0.535	0.535	0.197	0.055
SWMT1304PDPR-MS	0.031	0.394		●	●										0.535	0.535	0.197	0.055
SWG1304PDFR-AJ	-	0.394	●	●								●			0.535	0.535	0.197	0.063

● : Line up

Approach angle

10°-20°

45°

70°

85°

88°

90°

Others

STANDARD CUTTING CONDITIONS TPW / EPW13 type

ISO	Workpiece material	Grade	Cutting speed Vc (sfm)	Roughing (Depth of cut: APMX ≥ 0.040")				Light cutting to finishing (Depth of cut: APMX ≥ 0.040")			
				Feed per tooth: fz (ip)				Feed per tooth: fz (ip)			
				MJ	ML	MS	AJ	MJ	ML	MS	AJ
P	Mild steels Low carbon steels < 180HB	AH3135 (First choice)	330 - 890	0.002 - 0.010	0.002 - 0.008	-	-	0.002 - 0.008	0.002 - 0.007	-	-
		T3225 (Wear resistance)	500 - 980	0.002 - 0.010	-	-	-	0.002 - 0.008	-	-	-
		AH130 (Fracture resistance)	260 - 590	0.002 - 0.010	-	0.002 - 0.008	-	0.002 - 0.008	-	0.002 - 0.007	-
		NS740 (Surface finish)	330 - 980	0.002 - 0.006	-	-	-	0.002 - 0.005	-	-	-
	Carbon steels Alloy steels < 300HB	AH3135 (First choice)	330 - 760	0.002 - 0.008	0.002 - 0.006	-	-	0.002 - 0.007	0.002 - 0.005	-	-
		T3225 (Wear resistance)	490 - 920	0.002 - 0.008	-	-	-	0.002 - 0.007	-	-	-
		AH130 (Fracture resistance)	260 - 490	0.002 - 0.008	-	-	-	0.002 - 0.007	-	-	-
		NS740 (Surface finish)	330 - 760	0.002 - 0.006	-	-	-	0.002 - 0.005	-	-	-
	Die steels < 30HRC	AH3135 (First choice)	330 - 590	0.002 - 0.006	0.002 - 0.005	-	-	0.002 - 0.005	0.002 - 0.004	-	-
		T3225 (Wear resistance)	330 - 590	0.002 - 0.006	-	-	-	0.002 - 0.005	-	-	-
M	Stainless steels < 50HB	AH130 / AH3135 (First choice)	260 - 650	0.002 - 0.008	-	0.002 - 0.007	-	0.002 - 0.007	-	0.002 - 0.006	-
		AH120 (Wear resistance)	490 - 820	0.002 - 0.008	0.002 - 0.006	-	-	0.002 - 0.007	0.002 - 0.005	-	-
K	Gray cast irons Ductile cast irons	T1215 (First choice)	330 - 820	0.002 - 0.008	-	-	-	0.002 - 0.007	-	-	-
		AH120 (Fracture resistance)	330 - 820	0.002 - 0.008	0.002 - 0.006	-	-	0.002 - 0.007	0.002 - 0.005	-	-
N	Aluminum alloys Si < 13 %	DS1100 / KS05F (First choice)	980 - 3300	-	-	-	0.002 - 0.008	-	-	-	0.002 - 0.008
	Aluminum alloys Si ≥ 13 %	DS1100 / KS05F (First choice)	260 - 980	-	-	-	0.002 - 0.008	-	-	-	0.002 - 0.008
	Copper alloys	DS1100 / KS05F (First choice)	660 - 1650	-	-	-	0.002 - 0.008	-	-	-	0.002 - 0.008

- When machining at large depth of cut or large cutting width, Vc and fz should be reduced.
 - As a rule, dry machining (including air blow) is recommended. But, for excessive chip welding, such as when machining stainless steels, use a water soluble cutting fluid. In this case, use AH140 and set the cutting speed to Vc ≤ 328 sfm.

- When machining mild steel, carbon steel or alloy steel in wet conditions the T3130 is recommended. In this case, Vc and fz should be reduced.
 - TPW13 type can not be used for ramping, plunging and drilling.

Cautionary notes in use

- In slotting or pocketing, when chips are likely to remain in the cutting zone, internal air supplying or air blow is recommended to prevent chip recutting.
 - Use of inserts other than those specified, can result in poor cutting and cause damage to the cutter body. Therefore, specified inserts from the Tungaloy catalog must be used.
 - Before changing or indexing the inserts, remove chips or other foreign matter from the insert, insert pocket and cutter body by using an air blast or cloth.

- The inserts should be clamped by using the wrench supplied with the TAC Mill.
 - After a long period of use, the clamping screws and wrench may become deformed or damaged. These elements must be replaced as soon as possible.

Grade
Insert
Toolholder
Ext. Toolholder
Int. Toolholder
Threading
Grooving
Miniature Tool
Milling Cutter
Endmill
Drilling Tool
System
User's Guide Tooling System
Index



Square shoulder mill, with screw clamp system, for LQMU inserts

GAMP = +4° ~ +5°, GAMF = +13° ~ +15°

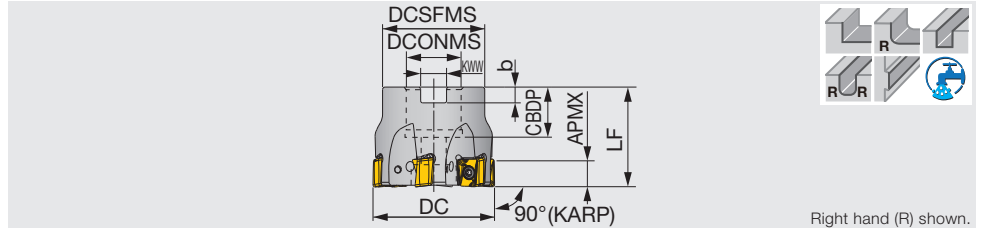

Inch	APMX	DC	CICT	DCSFMS	LF	DCONMS	CBDP	KWW	b	WT(lb)	Air hole	Insert	Arbor type
TPQ11R200U0075A06	0.354	2.000	6	1.693	1.575	0.750	0.787	0.320	0.187	0.880	With	LQMU1107...	A
TPQ11R250U0075A07	0.354	2.500	7	1.693	1.575	0.750	0.787	0.320	0.187	1.320	With	LQMU1107...	A
TPQ11R300U0100A10	0.354	3.000	10	2.165	1.969	1.000	1.024	0.383	0.219	2.310	With	LQMU1107...	A
TPQ11R400U0150A12	0.354	4.000	12	3.150	1.969	1.500	1.496	0.633	0.375	4.410	With	LQMU1107...	B
TPQ18R200U0075A03	0.630	2.000	3	1.772	1.575	0.750	0.750	0.320	0.187	0.880	With	LQMU1808...	A
TPQ18R250U0100A04	0.630	2.500	4	2.165	1.969	1.000	1.024	0.383	0.219	1.760	With	LQMU1808...	A
TPQ18R300U0100A05	0.630	3.000	5	2.165	1.969	1.000	1.024	0.383	0.219	2.430	With	LQMU1808...	A
TPQ18R400U0150A06	0.630	4.000	6	3.150	1.969	1.500	1.496	0.633	0.375	3.750	With	LQMU1808...	B
TPQ18R500U0150A08	0.630	5.000	8	3.150	2.480	1.500	1.693	0.626	0.394	6.170	With	LQMU1808...	B
TPQ18R600U0200A09	0.630	6.000	9	3.937	2.480	2.000	1.811	0.758	0.437	9.040	Without	LQMU1808...	B

SPARE PARTS



Designation	Clamping screw	Grip	Torx bit	Shell locking bolt (Optional parts)
TPQ11R200..., TPQ11R250..., TPQ18R200..., TPQ18R250...	CSTB-3.5L115	SW6-SD	BLDT10/S7	(C0.375X1.125H)
TPQ11R300..., TPQ18R300...	CSTB-3.5L115	SW6-SD	BLDT10/S7	(C0.500X1.375H)
TPQ11R400..., TPQ18R400..., TPQ18R500...	CSTB-3.5L115	SW6-SD	BLDT10/S7	(TMBA-0.750H)
TPQ18R600U0200A09	CSTB-3.5L115	SW6-SD	BLDT10/S7	-

*Recommended clamping torque : CSTB-3.5L115 = 1.84 lbs·ft, SR14-591 = 3.69 lbs·ft

Arbor type

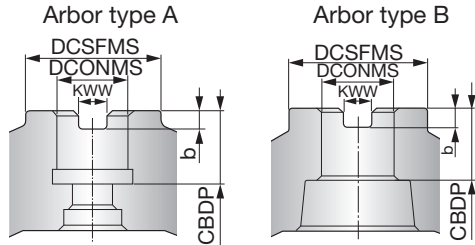

Approach angle

10-20°

45°

70°

85°

88°

90°

Others

Reference pages: Inserts → **H137**, Standard cutting conditions → **H138**

Square shoulder endmill, shank type, with screw clamp system, for LQMU inserts

GAMP = +4° ~ +5°, GAMF = +13° ~ +15°

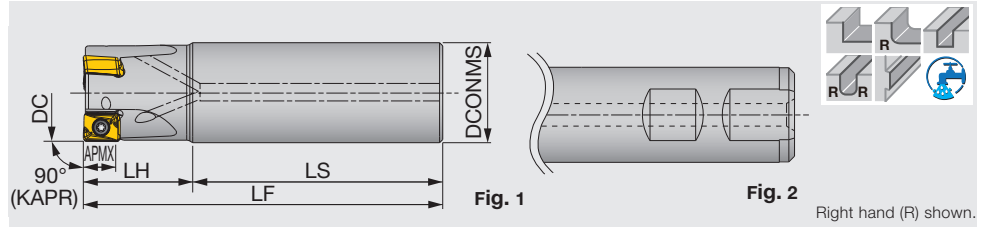

Inch	APMX	DC	CICT	DCONMS	LS	LH	LF	WT(lb)	Air hole	Insert	Shank type
EPQ11R100U0100W02	0.354	1.000	2	1.000	2.280	1.220	3.500	0.750	With	LQMU1107...	Fig.2
EPQ11R125U0125W03	0.354	1.250	3	1.250	2.500	1.500	4.000	1.540	With	LQMU1107...	Fig.2
EPQ11R150U0125W04	0.354	1.500	4	1.250	2.250	1.750	4.000	1.650	With	LQMU1107...	Fig.2

SPARE PARTS

Designation	Clamping screw	Grip 1	Grip 2	Torx bit	Wrench
EPQ11...	CSTB-3.5L115	SW6-SD	-	BLDT10/S7	T-10D

*Recommended clamping torque : CSTB-3.5L115 = 1.84 lbs·ft

INSERT

LQMU11-PXER-MJ (Suitable for ramping)

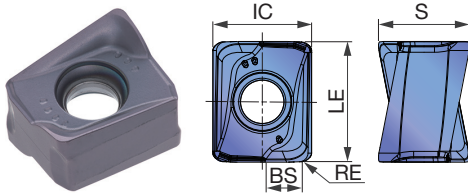

LQMU11/18-PNER-MJ

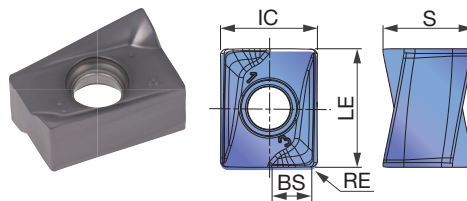

P	Steel	☆	★	★	
M	Stainless		★	☆	★
K	Cast iron	★		☆	
N	Non-ferrous				
S	Superalloys	★		★	☆
H	Hard materials				

★ : First choice
☆ : Second choice

Designation	RE	APMX	Coated				LE	S	IC	BS
			AH120	AH140	AH725	AH3135				
LQMU110704PNER-MJ	0.016	0.354	●	●	●	●	0.433	0.327	0.354	0.059
LQMU110708PNER-MJ	0.031	0.354	●	●	●	●	0.433	0.327	0.354	0.043
LQMU110708PXER-MJ	0.031	0.354	●			●	0.433	0.327	0.354	0.043
LQMU110716PNER-MJ	0.063	0.354	●	●	●		0.433	0.327	0.354	0.012
LQMU110720PNER-MJ	0.079	0.354	●				0.433	0.327	0.354	-
LQMU180804PNER-MJ	0.016	0.630	●	●	●		0.689	0.429	0.453	0.079
LQMU180808PNER-MJ	0.031	0.630	●	●	●		0.689	0.429	0.453	0.063
LQMU180816PNER-MJ	0.630	0.630	●	●	●		0.689	0.429	0.453	0.031
LQMU180824PNER-MJ	0.094	0.630	●	●	●		0.689	0.429	0.453	-

● : Line up

Reference pages: Standard cutting conditions → **H138**

STANDARD CUTTING CONDITIONS

LQMU11-PXER-MJ

ISO	Workpiece material	Hardness	Grade	Cutting speed Vc (sfm)	Feed per tooth fz (ipt)
P	Low carbon steel 1015, etc.	- 200HB	AH3135	330 - 820	0.004 - 0.010*
	Alloy steel 1055, etc.	- 300HB	AH3135	325 - 755	0.004 - 0.008*
	Prehardened steel NAK80, PX5, etc.	30 - 40HRC	AH3135	325 - 750	0.004 - 0.008*
M	Stainless steel 304SS, etc.	-	AH3135	295 - 590	0.004 - 0.010*
K	Gray cast iron Class 25, etc.	150 - 250HB	AH120	455 - 820	0.004 - 0.010*
	Ductile cast iron 60-40-18, etc.	150 - 250HB	AH120	360 - 655	0.004 - 0.010*
S	Titanium alloys Ti-6Al-4V, etc.	-	AH120	95 - 195	0.0032 - 0.008*
	Superalloys Inconel 718, etc.	-	AH120	65 - 160	0.0024 - 0.004*
H	Hardened steel	SKD61, etc. X40CrMoV5-1, etc.	AH120	145 - 225	0.004 - 0.006*
		SKD11, etc. X153CrMoV12, etc.	AH120	130 - 210	0.0024 - 0.004*

LQMU11/18-PNER-MJ

ISO	Workpiece material	Hardness HB	Grade	Cutting speed Vc (sfm)	Feed per tooth fz (ipt)
P	Low carbon steel 1018, 1020, 1026, etc.	- 200	AH725	330 - 800	0.004 - 0.010*
	High carbon steel 1045, 1055, etc.	200 - 300	AH725	330 - 750	0.004 - 0.008*
	Alloyed steel 4140, 8620, etc.	150 - 300	AH725	330 - 750	0.004 - 0.008*
	Tool steel H13, D2, etc.	- 300	AH725	330 - 600	0.004 - 0.008*
M	Stainless steel 304SS, 316SS, 17-4 PH, etc.	-	AH140	300 - 600	0.004 - 0.010*
K	Gray cast iron Class 25, Class 30, etc.	150 - 250	AH120	450 - 800	0.004 - 0.010*
	Ductile cast iron 60-40-18, 60-55-06, etc.	150 - 250	AH120	450 - 800	0.004 - 0.010*
S	Heat-resistant alloy Inconel 718, etc.	-	AH725	65 - 160	0.003 - 0.008*

* When using LQMU11 inserts, see page **H139** for proper feed per tooth setting.

· For applications with poor chip evacuation, use air gun to remove chips from the machining area to avoid chip re-cutting and part damage.

· To machine cast surface with unstable cutting depths or interruptions, it is recommended to lower the feed rate (fz) to the lowest parameter in the recommended range.

· Rigidity of the machine and/or workpiece and the spindle power capability greatly influence the cutting conditions. For applications with large cutting width/depth and/or long tool overhang, start with a Vc and fz in the lower range of the recommended cutting parameters and monitor the machine stability.

APPLICATION RANGE

LQMU11-PXER-MJ

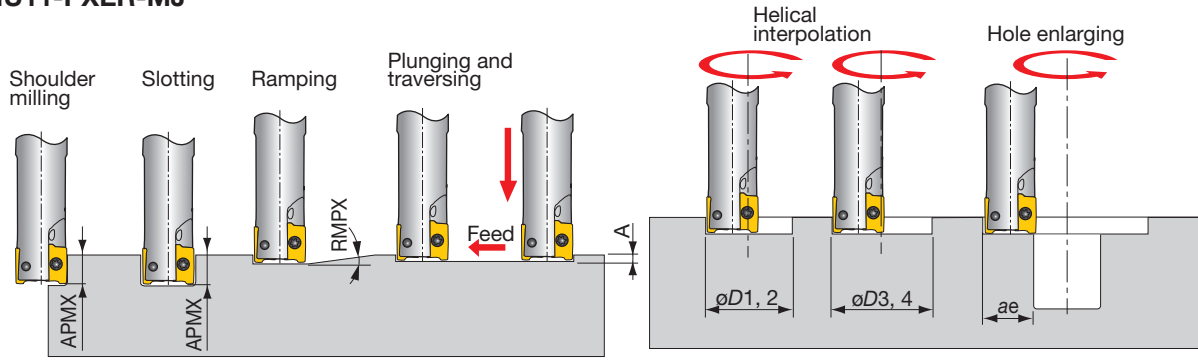

Inch	DC	Max. depth of cut APMX	Max. ramping angle RMPX	Max. plunging A	Min. machining øD1	Max. machining				Max. cutting width in enlarging ae
						øD2*	øD3	øD4*	RE	
EPQ11R100...	1.00	0.354	1.8°	0.023	1.41	1.87	1.96	1.94	0.031	0.96
EPQ11R125...	1.25	0.354	1.3°	0.023	1.91	2.37	2.46	2.44	0.031	1.21
TPQ11R150...	1.50	0.354	0.9°	0.023	2.41	2.87	2.96	2.94	0.031	1.46
TPQ11R200...	2.00	0.354	0.7°	0.023	3.41	3.87	3.96	3.94	0.031	1.96
TPQ11R250...	2.50	0.354	0.5°	0.023	4.41	4.87	4.96	4.94	0.031	2.46
TPQ11R300...	3.00	0.354	0.4°	0.023	5.41	5.87	5.96	5.94	0.031	2.96
TPQ11R400...	4.00	0.354	0.3°	0.023	7.41	7.87	7.96	7.94	0.031	3.96

*For a flat bottom

NOTE WHEN USING LQMU11 INSERTS

Maximum feed rate per tooth varies depending on the cutting depth and width.
Use proper feed rate as described below.
Use caution. Tool may damage if the parameters are not properly set.

Applicable feed rate (for $ae < 10\%$ of tool diameter)

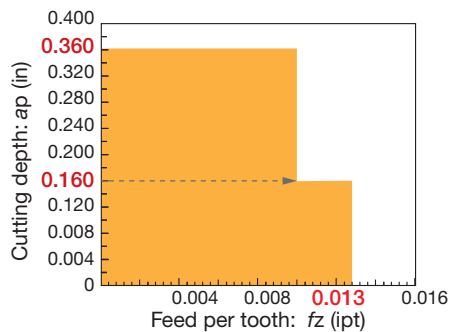

Cutter : TPQ11R200U0075A06 (DC = 2.000", z = 6)
 Insert : LQMU110708PXER-MJ
 Grade : AH3135
 Workpiece material : 1055 (200HB)
 Cutting Speed : $V_c = 660$ sfm
 Cutting width : $ae = 0.200$ "
 Coolant : Dry
 Machine : Vertical M/C, 22 HP

Applicable feed rate (for $ae > 10\%$ of tool diameter)

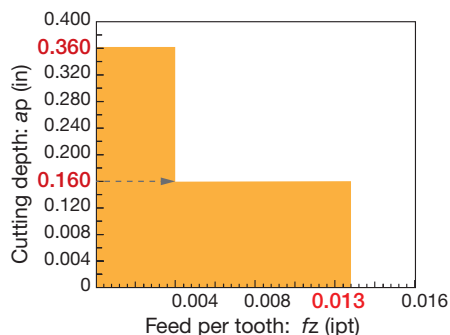

Cutter : TPQ11R200U0075A06 (DC = 2.000", z = 6)
 Insert : LQMU110708PXER-MJ
 Grade : AH3125
 Workpiece material : 1055 (200HB)
 Cutting Speed : $V_c = 660$ sfm
 Cutting width : $ae = 1.673$ "
 Coolant : Dry
 Machine : Vertical M/C, 22 HP

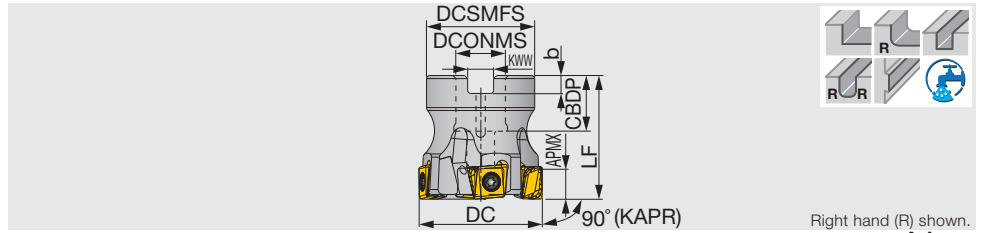

Inch	APMX	DC	CICT	DCSMFS	LF	DCONMS	CBDP	KWW	b	WT(lb)	Air hole	Insert	Arbor type
TPM11R200U0075A05	0.381	2.000	5	1.770	1.570	0.750	0.750	0.320	0.240	0.660	With	LMMU1107...	A
TPM11R250U0075A06	0.381	2.500	6	1.770	1.570	0.750	0.750	0.320	0.240	1.100	With	LMMU1107...	A
TPM11R300U0100A06	0.381	3.000	6	2.170	1.970	1.000	0.750	0.390	0.240	1.980	With	LMMU1107...	A
TPM11R300U0100A08	0.381	3.000	8	2.170	1.970	1.000	0.750	0.390	0.240	2.200	With	LMMU1107...	A
TPM11R400U0150A08	0.381	4.000	8	3.070	1.970	1.500	1.060	0.630	0.310	3.090	With	LMMU1107...	B
TPM11R400U0150A11	0.381	4.000	11	3.070	1.970	1.500	1.060	0.630	0.310	3.310	With	LMMU1107...	B
TPM16R300U0100A05	0.594	3.000	5	2.170	1.970	1.000	0.750	0.390	0.240	2.200	With	LMMU1107...	A
TPM16R400U0150A06	0.594	4.000	6	3.070	1.970	1.500	1.060	0.630	0.310	3.530	With	LMMU1107...	B
TPM16R500U0150A07	0.594	5.000	7	3.070	2.480	1.500	1.060	0.630	0.390	6.610	With	LMMU1107...	B

SPARE PARTS

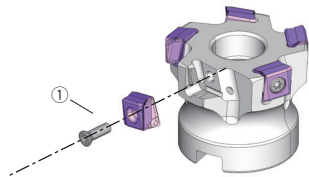

Designation	Clamping screw	Wrench	Torx bit	Shell locking bolt (Optional parts)
TPM11R200..., 250...	SM35-114-H0	T-15DF	-	(C0.375X1.125H)
TPM11R300...	SM35-114-H0	T-15DF	-	(C0.500X1.375H)
TPM11R400...	SM35-114-H0	T-15DF	-	(TMBA-0.750H)
TPM16R300...	CSTB-5L159	-	BT20S	(C0.500X1.375H)
TPM16R400..., 500...	CSTB-5L159	-	BT20S	(TMBA-0.750H)

*Recommended clamping torque : CSTB-3.5L110 = 2.58 lbs·ft, CSTB-5L159 = 3.69 lbs·ft, SM35-114-H0 = 2.58 lbs·ft

Arbor type

Arbor type A

Arbor type B

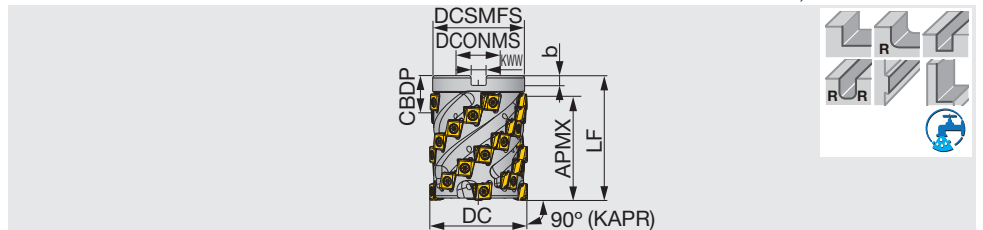
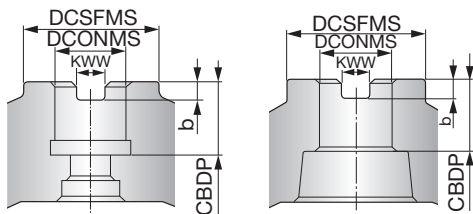

Inch	APMX	DC	ZEFP	CICT	DCSMFS	LF	DCONMS	CBDP	KWW	b	WT(lb)	Air hole	Insert
TLM11R200U0075A03	2.303	2.000	3	21	1.850	2.750	0.750	0.750	0.315	0.157	1.780	With	LMMU1107...
TLM11R250U0100A04	2.634	2.500	4	32	2.323	3.250	1.000	0.750	0.374	0.197	3.330	With	LMMU1107...

SPARE PARTS

Designation	Clamping screw	Wrench	Torx bit	Shell locking bolt
TLM11R200...	SM35-114-H0	T-15DF	BT15S	SD06-A2
TLM11R250...	SM35-114-H0	T-15DF	BT15S	SD08-52

Coolant needs to be supplied from the end of the arbor inlet. Coolant cannot be supplied from the set bolt.

*Recommended clamping torque : SM35-114-H0 = 2.58 lbs·ft

Reference pages: Inserts → [H141](#), Standard cutting conditions → [H142](#)

Square shoulder endmill, shank type, with screw clamp system, for LMMU tangential clamp inserts

GAMP = +5° ~ +6°, GAMF = +9° ~ +13°

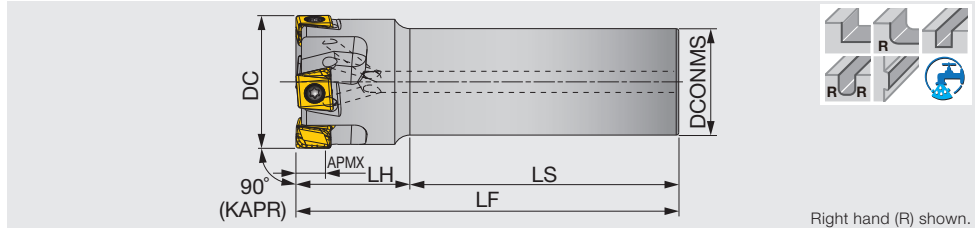

Inch	APMX	DC	CICT	DCONMS	LS	LH	LF	WT(lb)	Air hole	Insert
EPM11R125U0125W03	0.381	1.250	3	1.250	2.250	1.750	4.000	0.66	With	LMMU1107...
EPM11R150U0125W04	0.381	1.500	4	1.250	2.250	1.750	4.000	1.10	With	LMMU1107...

SPARE PARTS

Designation	Clamping screw	Wrench
EPM11...	SM35-114-H0	T-15DF

*Recommended clamping torque : SM35-114-H0 = 2.58 lbs·ft

INSERT

LMMU11/16-MJ

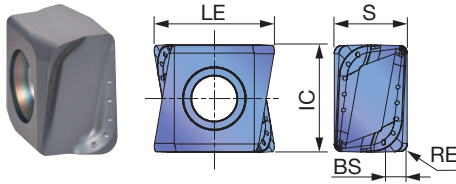

	P	M	K	N	S	H
Steel	★ ☆	★	★	★	★	★
Stainless	★	★	★	★	★	★
Cast iron	★	★	★	★	★	★
Non-ferrous	★	★	★	★	★	★
Superalloys	★	★	★	★	★	★
Hard materials	★	★	★	★	★	★

★ : First choice
☆ : Second choice

Designation	RE	APMX	Coated						LE	IC	S	BS
			AH3135	AH725	AH120	AH140	T1215	T3225				
LMMU110708PNER-MJ	0.031	0.381	●	●	●	●	●	●	0.460	0.413	0.280	0.079
LMMU110716PNER-MJ	0.063	0.381	●	●	●	●	●	●	0.453	0.413	0.280	0.047
LMMU110724PNER-MJ	0.094	0.381	●	●	●	●	●	●	0.445	0.413	0.280	0.014
LMMU110732PNER-MJ	0.126	0.381	●	●	●	●	●	●	0.437	0.413	0.280	-
LMMU160908PNER-MJ	0.031	0.594	●	●	●	●	●	●	0.681	0.630	0.375	0.094
LMMU160916PNER-MJ	0.063	0.594	●	●	●	●	●	●	0.673	0.630	0.375	0.063
LMMU160924PNER-MJ	0.094	0.594	●	●	●	●	●	●	0.665	0.630	0.375	0.031
LMMU160932PNER-MJ	0.126	0.594	●	●	●	●	●	●	0.661	0.630	0.375	-

● : Line up

STANDARD CUTTING CONDITIONS

Bore, shank type EPM / TPM

ISO	Workpiece materials	Hardness	Priority	Grades	Cutting speed Vc (sfm)	Feed per tooth fz (ipt)	
P	Low carbon steel 1015, etc.	- 200 HB	First choice	AH3135	328 - 820	0.005 - 0.012	
		- 200 HB	Wear resistance	T3225	492 - 1148	0.003 - 0.008	
	Carbon steel and alloy steel 1055, 4140 etc.	- 300 HB	First choice	AH3135	328 - 755	0.004 - 0.010	
		- 300 HB	Wear resistance	T3225	492 - 1148	0.003 - 0.008	
	Prehardend steel NAK80, PX5, etc.	30 - 40 HRC	First choice	AH3135	328 - 755	0.004 - 0.010	
		30 - 40 HRC	Wear resistance	T3225	394 - 1148	0.003 - 0.008	
M	Stainless steel S30400, etc.	-	First choice	AH3135	295 - 591	0.004 - 0.010	
K	Gray cast iron No.250B, etc.	150 - 250 HB	First choice	AH120	459 - 820	0.005 - 0.012	
		150 - 250 HB	Wear resistance	T1215	394 - 1148	0.003 - 0.008	
	Ductile cast iron 60-40-18, 80-55-06, etc.	150 - 250 HB	First choice	AH120	361 - 656	0.005 - 0.012	
		150 - 250 HB	Wear resistance	T1215	394 - 1148	0.003 - 0.008	
S	Titanium alloys Ti-6Al-4V, etc.	-	First choice	AH725	98 - 197	0.003 - 0.008	
	Superalloys Inconel718, etc.	-	First choice	AH725	66 - 164	0.002 - 0.004	
H	Hardened steel	H13, etc.	40 - 50 HRC	First choice	AH725	148 - 230	0.003 - 0.006
		D2, etc.	50 - 60 HRC	First choice	AH725	131 - 213	0.002 - 0.004

Roughing type TLM

ISO	Workpiece materials	Hardness	Priority	Grades	Cutting speed Vc (sfm)	Feed per tooth fz (ipt)	
P	Low carbon steel 1015, etc.	- 200 HB	First choice	AH3135	328 - 820	0.004 - 0.010	
		- 300 HB	Wear resistance	T3225	492 - 1148	0.004 - 0.008	
	Carbon steel and alloy steel 1055, 4140 etc.	- 300 HB	First choice	AH3135	328 - 656	0.004 - 0.008	
		- 300 HB	Wear resistance	T3225	492 - 984	0.004 - 0.008	
	Prehardend steel NAK80, PX5, etc.	30 - 40 HRC	First choice	AH3135	328 - 656	0.004 - 0.008	
		30 - 40 HRC	Wear resistance	T3225	394 - 984	0.004 - 0.008	
M	Stainless steel S30400, etc.	-	First choice	AH3135	295 - 492	0.004 - 0.010	
K	Gray cast iron No.250B, etc.	150 - 250 HB	First choice	AH120	328 - 820	0.004 - 0.010	
		150 - 250 HB	Wear resistance	T1215	394 - 1148	0.004 - 0.010	
	Ductile cast iron 60-40-18, 80-55-06, etc.	150 - 250 HB	First choice	AH120	328 - 656	0.004 - 0.010	
		150 - 250 HB	Wear resistance	T1215	394 - 1148	0.004 - 0.010	
S	Titanium alloys Ti-6Al-4V, etc.	-	First choice	AH725	66 - 164	0.002 - 0.006	
	Superalloys Inconel718, etc.	-	First choice	AH725	66 - 131	0.002 - 0.004	
H	Hardened steel	H13, etc.	40 - 50 HRC	First choice	AH725	98 - 197	0.003 - 0.006
		D2, etc.	50 - 60 HRC	First choice	AH725	82 - 180	0.002 - 0.004

TUNG-ALUMILL

TPV16

90° shoulder mill for Aluminum machining, with screw clamp system, for XVCT16 inserts

GAMP = +10° ~ +11°, GAMF = -9° ~ -5.5°

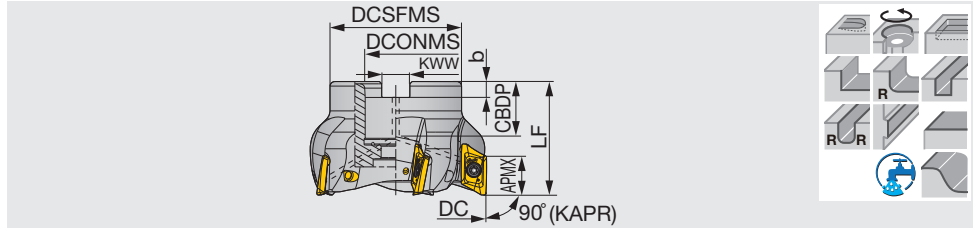

Inch	DC	CICT	DCSFMS	DCONMS	CDBP	LF	b	KWW	WT(lb)	Air hole	Max. RPM (min ⁻¹)	Insert
TPV16R150U0075A03	1.500	3	1.421	0.750	0.750	2.000	0.315	0.170	0.440	With	30,000	XVCT1605...
TPV16R200U0075A04	2.000	4	1.890	0.750	0.750	2.000	0.315	0.170	0.890	With	27,000	XVCT1605...
TPV16R250U0100A05	2.500	5	2.165	1.000	0.750	2.000	0.375	0.197	1.340	With	24,000	XVCT1605...
TPV16R300U0100A05	3.000	5	2.362	1.000	0.750	2.000	0.375	0.197	1.920	With	21,000	XVCT1605...
TPV16R400U0150A06	4.000	6	3.150	1.500	1.059	2.500	0.625	0.319	4.280	With	19,000	XVCT1605...
TPV16R500U0150A07	5.000	7	3.740	1.500	1.059	2.500	0.625	0.319	6.700	With	17,000	XVCT1605...

SPARE PARTS



Designation	Clamping screw	Grip	Torx bit	Shell locking bolt
TPV16R150U0075A03	TS40093I/HG	H-TBS	BT15S	TCS 9.525-35-I
TPV16R200U0075A04	TS40093I/HG	H-TBS	BT15S	SD06-46
TPV16R250..., 300...	TS40093I/HG	H-TBS	BT15S	SD08-47
TPV16R400..., 500...	TS40093I/HG	H-TBS	BT15S	SD12-82

*Recommended clamping torque : TS40093I/HG = 3.32 lbs·ft

TUNG-ALUMILL

EPV16

90° shoulder endmill for Aluminum machining, shank type, with screw clamp system, for XVCT16 inserts

GAMP = +6° ~ +10°, GAMF = -12° ~ -9°

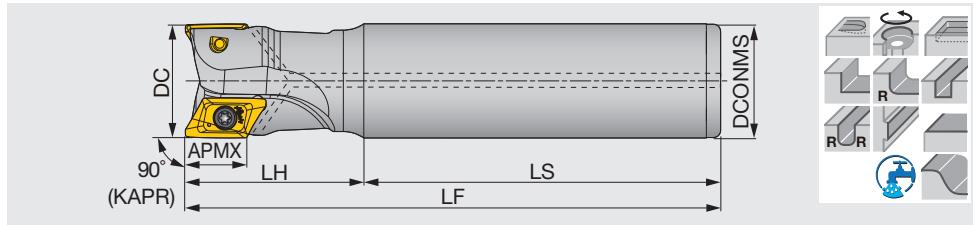

Inch	DC	CICT	DCONMS	LS	LH	LF	WT(lb)	Air hole	Max. RPM (min ⁻¹)	Insert
EPV16R100U0100W02	1.000	2	1.000	3.000	2.000	5.000	0.820	With	38,000	XVCT1605...
EPV16R100U0100W02L	1.000	2	1.000	4.000	3.000	7.000	1.170	With	38,000	XVCT1605...
EPV16R125U0125W02	1.250	2	1.250	4.000	2.000	6.000	1.690	With	34,000	XVCT1605...
EPV16R125U0125W02L	1.250	2	1.250	5.000	3.000	8.000	2.280	With	34,000	XVCT1605...
EPV16R125U0125W03	1.250	3	1.250	4.000	2.000	6.000	1.680	With	34,000	XVCT1605...
EPV16R125U0125W03L	1.250	3	1.250	5.000	3.000	8.000	2.270	With	34,000	XVCT1605...
EPV16R150U0125W03	1.500	3	1.250	5.000	2.000	7.000	2.080	With	30,000	XVCT1605...
EPV16R150U0125W03L	1.500	3	1.250	8.000	2.000	10.000	3.140	With	30,000	XVCT1605...

SPARE PARTS



Designation	Clamping screw	Grip	Torx bit
EPV16R100...	TS40085I/HG	H-TBS	BT15S
EPV16R125,150...	TS40093I/HG	H-TBS	BT15S

*Recommended clamping torque : TS40085I/HG = 3.32 lbs·ft, TS40093I/HG = 3.3 lbs·ft

Reference pages: Inserts, Standard cutting conditions → [H44](#)



INSERT

XVCT16-AJ

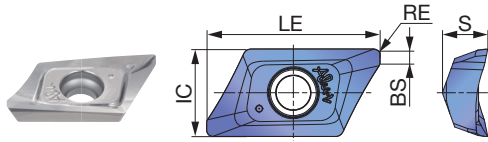

P	Steel											
M	Stainless											
K	Cast iron											
N	Non-ferrous	★										
S	Superalloys											
H	Hard materials											

★ : First choice
☆ : Second choice

Designation	RE	APMX	Uncoated										LE	IC	S	BS	
			TH10														
XVCT160504R-AJ	0.016	0.630	●											0.874	0.442	0.232	0.051
XVCT160508R-AJ	0.031	0.630	●											0.874	0.442	0.232	0.039
XVCT160512R-AJ	0.047	0.610	●											0.854	0.442	0.228	0.039
XVCT160516R-AJ	0.063	0.591	●											0.835	0.442	0.226	0.039
XVCT160520R-AJ	0.079	0.571	●											0.819	0.442	0.226	0.039
XVCT160524R-AJ	0.094	0.551	●											0.800	0.442	0.224	0.039
XVCT160525R-AJ	0.098	0.551	●											0.800	0.442	0.224	0.039
XVCT160530R-AJ	0.118	0.551	●											0.768	0.442	0.220	0.039
XVCT160532R-AJ	0.126	0.551	●											0.756	0.442	0.220	0.039
XVCT160540R-AJ	0.157	0.512	●											0.724	0.442	0.217	0.047
XVCT160550R-AJ	0.197	0.512	●											0.724	0.442	0.213	0.016

* When using inserts with corner radius RE ≥ 0.126", standard cutter body has to be modified with "R". "R" = RE - 0.012". ● : Line up



STANDARD CUTTING CONDITIONS

ISO	Workpiece material	Hardness HB	Grade	Chip-breaker	Cutting speed Vc (sfm)	Feed per tooth fz (ipt)
N	Aluminum alloy	60	TH10	AJ	984 - 16404	0.006 - 0.014
		100	TH10	AJ	656 - 6562	0.004 - 0.010
	Cast Aluminum alloy Si ≤ 12%	75	TH10	AJ	656 - 6562	0.006 - 0.012
		90	TH10	AJ	656 - 4921	0.004 - 0.010
	Cast Aluminum alloy Si > 12%	130	TH10	AJ	656 - 3281	0.003 - 0.006
	Copper alloys Pb > 1%	110	TH10	AJ	656 - 2625	0.003 - 0.006
	Copper alloys	90	TH10	AJ	984 - 3281	0.004 - 0.006
		100	TH10	AJ	984 - 2625	0.004 - 0.006
	Duroplastics, fiber plastics	-	TH10	AJ	328 - 1640	0.004 - 0.006
	Hard rubber	-	TH10	AJ	328 - 984	0.004 - 0.006

Safety guidelines

1. Use only the original inserts, cutters and spare parts.
2. Insert pocket must be cleaned before clamping the insert.
3. Clamp torque of screw should be 3.32 lbf-ft.
4. For safety reasons, use a new screw when changing the insert.
5. Maximum RPM values are determined based on the burst test. Using RPM beyond maximum values may cause insert breakage, machine damage or personal injury.
6. XVCT insert has sharp cutting edges. Always wear gloves for protection from injury when handling.

APPLICATION RANGE

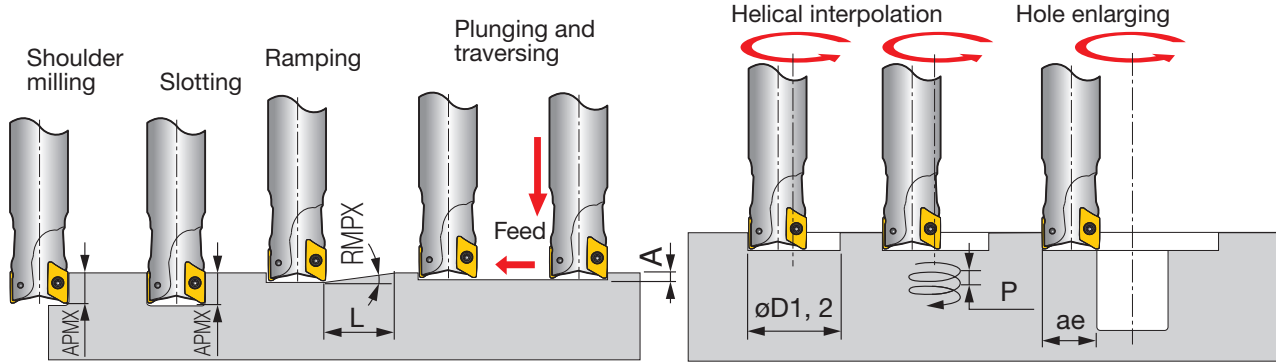

Inch	Tool DC	Straight ramp down					Step down		Helical ramp down			Hole enlarging
		Corner radius RE	Max. depth of cut APMX	Max. ramping angle RMPX	Min. length L	Max. plunging depth A	Min. machining $\phi D1$	Min. pitch/rev P	Max. machining $\phi D2$	Max. pitch/rev P	Max. width ae	
EPV16R100...	1.000	0.016, 0.031	0.630	22°	1.570	0.166	1.150	0.173	1.970	0.535	0.886	
EPV16R100...	1.000	0.047	0.610	22°	1.570	0.166	1.150	0.173	1.970	0.535	0.886	
EPV16R100...	1.000	0.063	0.591	22°	1.500	0.146	1.150	0.173	1.970	0.520	0.886	
EPV16R100...	1.000	0.079	0.571	22°	1.500	0.146	1.150	0.173	1.970	0.520	0.886	
EPV16R100...	1.000	0.118, 0.126	0.551	21°	1.500	0.098	1.150	0.165	1.970	0.484	0.886	
EPV16R100...	1.000	0.157, 0.197	0.512	18.5°	1.570	0.090	1.150	0.146	1.970	0.484	0.886	
EPV16R125...	1.250	0.016, 0.031	0.630	16.5°	2.130	0.158	1.690	0.346	2.520	0.535	1.134	
EPV16R125...	1.250	0.047	0.610	16.5°	2.130	0.158	1.690	0.346	2.520	0.535	1.134	
EPV16R125...	1.250	0.063	0.591	16°	2.130	0.138	1.690	0.335	2.520	0.520	1.134	
EPV16R125...	1.250	0.079	0.571	16°	2.130	0.138	1.690	0.335	2.520	0.520	1.134	
EPV16R125...	1.250	0.118, 0.126	0.551	15°	2.130	0.118	1.700	0.311	2.520	0.484	1.134	
EPV16R125...	1.250	0.157, 0.197	0.512	13.5°	2.200	0.098	1.700	0.280	2.520	0.484	1.134	
T/EPV16R150...	1.500	0.016, 0.031	0.630	11.5°	3.110	0.158	2.330	0.409	3.150	0.535	1.417	
T/EPV16R150...	1.500	0.047	0.610	11.5°	3.110	0.158	2.330	0.409	3.150	0.535	1.417	
T/EPV16R150...	1.500	0.063	0.591	11°	3.150	0.138	2.330	0.390	3.150	0.520	1.417	
T/EPV16R150...	1.500	0.079	0.571	11°	3.150	0.138	2.330	0.390	3.150	0.520	1.417	
T/EPV16R150...	1.500	0.118, 0.126	0.551	10°	3.230	0.118	2.330	0.354	3.150	0.484	1.417	
T/EPV16R150...	1.500	0.157, 0.197	0.512	8.5°	3.540	0.098	2.330	0.299	3.150	0.484	1.417	
TPV16R200...	2.000	0.016, 0.031	0.630	9.5°	3.780	0.158	3.110	0.512	3.940	0.535	1.772	
TPV16R200...	2.000	0.047	0.610	9.5°	3.780	0.158	3.110	0.512	3.940	0.535	1.772	
TPV16R200...	2.000	0.063	0.591	9°	3.860	0.138	3.110	0.484	3.940	0.520	1.772	
TPV16R200...	2.000	0.079	0.571	9°	3.860	0.138	3.110	0.484	3.940	0.520	1.772	
TPV16R200...	2.000	0.118, 0.126	0.551	8°	4.060	0.118	3.110	0.429	3.940	0.484	1.772	
TPV16R200...	2.000	0.157, 0.197	0.512	7°	4.330	0.098	3.110	0.374	3.940	0.484	1.772	
TPV16R250...	2.500	0.016, 0.031	0.630	7°	5.120	0.158	4.130	0.535	4.960	0.535	2.232	
TPV16R250...	2.500	0.047	0.610	7°	5.120	0.158	4.130	0.535	4.960	0.535	2.232	
TPV16R250...	2.500	0.063	0.591	6.5°	5.350	0.138	4.130	0.504	4.960	0.520	2.232	
TPV16R250...	2.500	0.079	0.571	6.5°	5.350	0.138	4.130	0.504	4.960	0.520	2.232	
TPV16R250...	2.500	0.118, 0.126	0.551	6°	5.350	0.118	4.140	0.465	4.960	0.484	2.232	
TPV16R250...	2.500	0.157, 0.197	0.512	5.5°	5.510	0.098	4.140	0.425	4.960	0.484	2.232	
TPV16R300...	3.000	0.016, 0.031	0.630	5°	7.200	0.158	5.470	0.535	6.300	0.535	2.835	
TPV16R300...	3.000	0.047	0.610	5°	7.200	0.158	5.470	0.535	6.300	0.535	2.835	
TPV16R300...	3.000	0.063	0.591	4.5°	7.760	0.138	5.470	0.488	6.300	0.520	2.835	
TPV16R300...	3.000	0.079	0.571	4.5°	7.760	0.138	5.470	0.488	6.300	0.520	2.835	
TPV16R300...	3.000	0.118, 0.126	0.551	4°	8.150	0.118	5.480	0.433	6.300	0.484	2.835	
TPV16R300...	3.000	0.157, 0.197	0.512	3.5°	8.700	0.098	5.480	0.378	6.300	0.484	2.835	
TPV16R400...	4.000	0.016, 0.031	0.630	3.5°	10.310	0.158	7.040	0.508	7.870	0.535	3.543	
TPV16R400...	4.000	0.047	0.610	3.5°	10.310	0.158	7.040	0.508	7.870	0.535	3.543	
TPV16R400...	4.000	0.063	0.591	3°	11.650	0.138	7.040	0.437	7.870	0.520	3.543	
TPV16R400...	4.000	0.079	0.571	3°	11.650	0.138	7.040	0.437	7.870	0.520	3.543	
TPV16R400...	4.000	0.118, 0.126	0.551	2.5°	13.070	0.118	7.050	0.362	7.870	0.484	3.543	
TPV16R400...	4.000	0.157, 0.197	0.512	2.5°	12.170	0.098	7.050	0.362	7.870	0.457	3.543	
TPV16R500...	5.000	0.016, 0.031	0.630	2.5°	14.450	0.158	9.020	0.476	9.840	0.535	4.429	
TPV16R500...	5.000	0.047	0.610	2.5°	14.450	0.158	9.020	0.476	9.840	0.535	4.429	
TPV16R500...	5.000	0.063	0.591	2°	17.480	0.138	9.020	0.382	9.840	0.520	4.429	
TPV16R500...	5.000	0.079	0.571	2°	17.480	0.138	9.020	0.382	9.840	0.520	4.429	
TPV16R500...	5.000	0.118, 0.126	0.551	1.5°	21.810	0.118	9.020	0.287	9.840	0.343	4.429	
TPV16R500...	5.000	0.157, 0.197	0.512	1.5°	20.310	0.098	9.020	0.287	9.840	0.343	4.429	

Grade
Insert
Toolholder
Ext. Toolholder
Int. Toolholder
Threading
Grooving
Miniature Tool
Milling Cutter
Endmill
Drilling Tool
User's Guide Tooling System
Index



High Feed Milling

Face Milling

Shoulder Milling

Slot Milling

Profile Milling

Thread Milling

Other

Approach angle

10°-20°

45°

70°

85°

88°

90°

Others

TSE4000RIAU

Square shoulder mill, with wedge clamp system, for positive triangular inserts

GAMP = +17°, GAMF = +5°

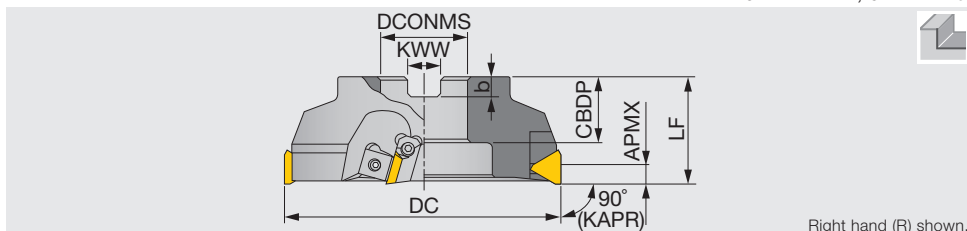
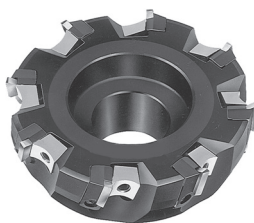

Right hand (R) shown.

Inch	APMX	DC	CICT	LF	DCONMS	CBDP	KWW	b	WT(lb)
TSE4003RIAU	0.394	3.150	4	1.970	1.000	1.020	0.375	0.236	2.20
TSE4004RIAU	0.394	4.000	6	2.480	1.500	1.260	0.500	0.394	4.19
TSE4005RIAU	0.394	4.920	6	2.480	1.500	1.500	0.625	0.394	6.39
TSE4006RIAU	0.394	6.300	8	2.480	2.000	1.500	0.750	0.433	10.80
TSE4008RIA	0.394	7.870	10	2.480	2.500	1.500	1.000	0.551	16.31
TSE4010RIA	0.394	9.840	12	2.480	2.500	1.500	1.000	0.551	30.42
TSE4012RIA	0.394	12.400	14	2.480	2.500	1.500	1.000	0.551	48.72

SPARE PARTS



Designation	①Locator	②Wedge	③Wedge fixing screw	④Locator fixing screw	Wrench	Shell locking bolt (optional parts)
TSE4003RIAU	LE403R	WF330N	FDS-8S	CM4X0.7X14	TP-4	(C0.500X1.375H)
TSE4004RIAU	LE403R	WF330N	FDS-8S	CM4X0.7X14	TP-4	(TMBA-0.750H)
TSE4005RIAU	LE405R	WF500R	FDS-8S	CM4X0.7X14	TP-4	(TMBA-0.750H)
TSE4006... - 4012...	LE405R	WF500R	FDS-8S	CM4X0.7X14	TP-4	-

*Recommended clamping torque : FDS-8SS/FDS-8S = 5.9 lbs · ft

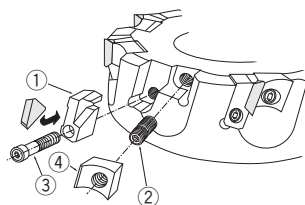

Reference pages: Inserts, Standard cutting conditions → **H147**

INSERT

TECN/TEEN 43Z

TECN43ZFR-DIA

TEKR22-MS

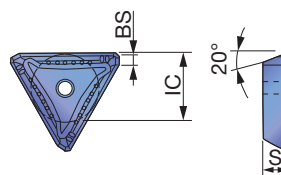
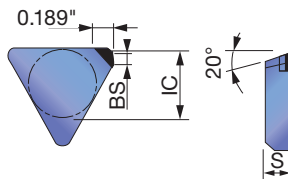
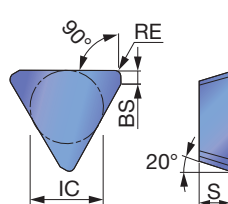

P Steel	☆	☆	☆	☆	☆	☆	☆	☆	☆	☆	☆	☆	☆	☆	☆	☆	☆	☆	☆	☆	☆
M Stainless	☆	★	☆						★	☆											
K Cast iron	★					☆			★					☆							
N Non-ferrous																			★	★	
S Superalloys	☆	☆																			
H Hard materials																					

★ : First choice
☆ : Second choice

Designation	RE	APMX	Coated										Cermet		Uncoated		PCD	IC	S	BS					
			AH120	AH130	AH140	AH330	GH330	T1115	T3130	AH3135	T1215	T3225	NS740	N308	UX30	TH10	DX140								
TECN43ZFR	C0.020	0.394															●				0.500	0.187	0.079		
TECN43ZTR	0.039	0.394														●	●		●			0.500	0.187	0.052	
TEEN43ZFR	C0.020	0.394																●				0.500	0.187	0.079	
TEEN43ZTR	0.039	0.394	●	●	●	●	●	●	●	●	●	●	●	●	●	●	●	●	●	●	●		0.500	0.187	0.052
TECN43ZFR-DIA	-	0.138																		●			0.500	0.187	0.079
TEKR2204PEPR-MS	-	0.394			●																		0.500	0.187	0.071

T-DIA is a diamond-based ultra high pressure sintered body. Available in 1-corner type.

● : Line up
DX140: 1 piece per package

STANDARD CUTTING CONDITIONS

ISO	Workpiece material	Grades	Roughing (Depth of cut: > 0.059")		Finishing (Depth of cut: 0.012 ~ 0.028")	
			Cutting speed Vc (sfm)	Feed per tooth fz (ipt)	Cutting speed Vc (sfm)	Feed per tooth fz (ipt)
			P	Mild steels Unhardened steels < 180 HB	AH3135	98 ~ 230
T3225	98 ~ 984	0.004 ~ 0.009			180 ~ 984	0.004 ~ 0.010
NS740	98 ~ 660	0.004 ~ 0.007			490 ~ 820	0.004 ~ 0.008
Carbon steels Alloy steels < 300 HB	AH3135	330 ~ 660		0.004 ~ 0.007	98 ~ 755	0.004 ~ 0.008
	T3225	98 ~ 919		0.004 ~ 0.008	591 ~ 919	0.004 ~ 0.009
	NS740	330 ~ 490		0.004 ~ 0.006	490 ~ 660	0.004 ~ 0.007
Die steels < 30 HRC	T3225	330 ~ 820	0.004 ~ 0.006	330 ~ 820	0.004 ~ 0.008	
	AH3135	330 ~ 490	0.004 ~ 0.006	330 ~ 490	0.004 ~ 0.008	
M	Stainless steels < 250 HB	AH3135	260 ~ 590	0.004 ~ 0.008	330 ~ 660	0.004 ~ 0.010
		T3225	490 ~ 660	0.004 ~ 0.007	660 ~ 820	0.004 ~ 0.010
K	Cast irons Ductile cast iron	T1215	330 ~ 820	0.004 ~ 0.008	330 ~ 820	0.004 ~ 0.010
		AH120	330 ~ 660	0.004 ~ 0.008	330 ~ 660	0.004 ~ 0.010
N	Aluminum alloys Si < 13%	TH10	660 ~ 3281	0.002 ~ 0.010	1150 ~ 3281	0.004 ~ 0.010
		DX140	660 ~ 3281	0.002 ~ 0.006	1150 ~ 3281	0.004 ~ 0.008
	Copper alloys	TH10	660 ~ 1640	0.004 ~ 0.006	660 ~ 1640	0.004 ~ 0.008
S	Titanium alloys Ti-6Al-4V, etc.	AH130	66 ~ 217	0.002 ~ 0.006	131 ~ 217	0.002 ~ 0.006
	Heat-resistant alloys Inconel 718, etc.	AH120	66 ~ 131	0.002 ~ 0.004	66 ~ 131	0.002 ~ 0.004

Dry cutting is recommended except for Aluminum alloys
Maximum depth of cut for DX140 TECN43ZFR-DIA is 0.138".

Grade
 Insert
 Ext. Toolholder
 Int. Toolholder
 Threading
 Grooving
 Miniature Tool
 Endmill
 Drilling Tool
 User's Guide Tooling System
 Index



TSP400RIA-U

Square shoulder mill, with wedge clamp system, for positive triangular inserts

GAMP = +5°, GAMF = 0°

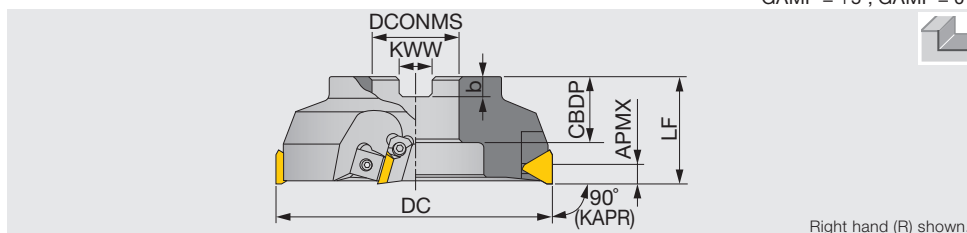

Right hand (R) shown.

Inch	APMX	DC	CICT	LF	DCONMS	CBDP	KWW	b	WT(lb)	Insert
TSP4003RIA-U	0.394	3.150	4	1.970	1.000	1.020	0.375	0.236	2.43	TP*N43 / TP*R...
TSP4004RIA-U	0.394	4.000	6	2.480	1.500	1.260	0.625	0.394	4.41	TP*N43 / TP*R...
TSP4005RIA-U	0.394	4.920	6	2.480	1.500	1.500	0.625	0.394	6.83	TP*N43 / TP*R...
TSP4006RIA-U	0.394	6.300	8	2.480	2.000	1.500	0.750	0.433	11.24	TP*N43 / TP*R...
TSP4008RIA-U	0.394	7.870	10	2.480	2.500	1.500	1.000	0.551	16.98	TP*N43 / TP*R...
TSP4010RIA	0.394	9.840	12	2.480	2.500	1.500	1.000	0.551	31.08	TP*N43 / TP*R...
TSP4012RIA	0.394	12.400	14	2.480	2.500	1.500	1.000	0.551	49.82	TP*N43 / TP*R...

SPARE PARTS



Designation	①Locator	②Wedge	③Wedge fixing screw	④Locator fixing screw	Wrench	Shell locking bolt (Optional parts)
TSP4003RIA-U	LP403R	WF330N	FDS-8S	CM4X0.7X14	TP-4	(C0.500X1.375H)
TSP4004RIA-U	LP403R	WF330N	FDS-8S	CM4X0.7X14	TP-4	(TMBA-0.750H)
TSP4005RIA-U	LP405R	WF500R	FDS-8S	CM4X0.7X14	TP-4	(TMBA-0.750H)
TSP4006... - 4012...	LP405R	WF500R	FDS-8S	CM4X0.7X14	TP-4	-

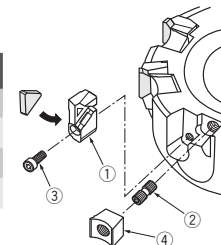

*Recommended clamping torque : FDS-8S = 5.9 lbs·ft

INSERT

TPCN/TPEN/TPKN 43Z

TPKR/TPMR-MJ

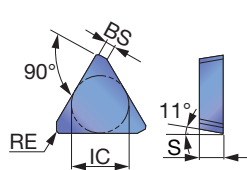

Right hand (R) shown.

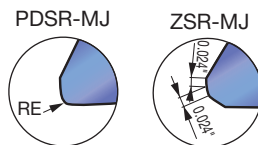
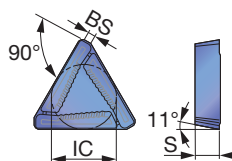

	P	M	K	N	S	H
Steel	★			☆		
Stainless		★	★			
Cast iron	★			★		
Non-ferrous						★
Superalloys	★	☆				
Hard materials						

★ : First choice
☆ : Second choice

Designation	RE	APMX	Coated						Cermet		Uncoated		IC	LE	S	BS
			AH120	AH130	AH140	GH330	T1115	T3130	NS740	N308	UX30	TH10				
TPCN43ZFR	C0.020	0.394									●		0.500	-	0.187	0.079
TPCN43ZTR	C0.020	0.394						●	●		●		0.500	-	0.187	0.079
TPEN43ZTR	C0.020	0.394						●					0.500	-	0.187	0.079
TPEN43ZTRCR	0.039	0.394											0.500	-	0.187	0.079
TPKN43ZFR	C0.020	0.394									●		0.500	-	0.187	0.079
TPKN43ZFL	C0.020	0.394									●		0.500	-	0.187	0.079
TPKN43ZTR	C0.020	0.394	●	●	●	●	●	●	●		●		0.500	-	0.187	0.079
TPKR43ZSR-MJ	-	0.394				●	●						0.500	-	0.187	0.059
TPMR2204PDSR-MJ	0.031	0.394				●	●						0.500	-	0.187	0.047

● : Line up

Reference pages: Standard cutting conditions → H149

STANDARD CUTTING CONDITIONS

TSP4000RIA-U (When finishing insert is not in use)

ISO	Workpiece material	Grades	Roughing (Depth of cut: > 0.059")		Finishing (Depth of cut: 0.012" ~ 0.028")	
			Cutting speed Vc (sfm)	Feed per tooth fz (ipt)	Cutting speed Vc (sfm)	Feed per tooth fz (ipt)
P	Mild steels Unhardened steels < 180 HB	AH120 · GH330	330 ~ 755	0.004 ~ 0.010	430 ~ 820	0.004 ~ 0.012
		T3130	430 ~ 990	0.004 ~ 0.011	590 ~ 990	0.004 ~ 0.012
		UX30	330 ~ 590	0.004 ~ 0.010	430 ~ 660	0.004 ~ 0.012
		NS740 · N308	430 ~ 660	0.004 ~ 0.008	490 ~ 820	0.004 ~ 0.010
	Carbon steels Alloy steels < 300 HB	AH120 · GH330	330 ~ 590	0.004 ~ 0.008	490 ~ 660	0.004 ~ 0.011
		T3130	430 ~ 590	0.004 ~ 0.010	590 ~ 919	0.004 ~ 0.011
		UX30	260 ~ 430	0.004 ~ 0.008	330 ~ 490	0.004 ~ 0.011
		NS740 · N308	330 ~ 490	0.004 ~ 0.007	490 ~ 660	0.004 ~ 0.009
	Die steels < 30 HRC	T3130 · AH120 · GH330	330 ~ 490	0.004 ~ 0.007	330 ~ 490	0.004 ~ 0.008
UX30		260 ~ 430	0.004 ~ 0.007	260 ~ 430	0.004 ~ 0.008	
M	Stainless steels < 250 HB	AH130 · AH140	490 ~ 660	0.006 ~ 0.009	660 ~ 755	0.15 ~ 0.010
		AH120	490 ~ 755	0.006 ~ 0.008	660 ~ 820	0.15 ~ 0.009
K	Cast irons Ductile cast iron	T1115	330 ~ 660	0.004 ~ 0.008	330 ~ 660	0.004 ~ 0.010
		TH10 · UX30	260 ~ 430	0.004 ~ 0.008	260 ~ 430	0.004 ~ 0.010
S	Titanium alloys	AH130	66 ~ 217	0.002 ~ 0.006	66 ~ 217	0.002 ~ 0.006
	Heat-resistant alloys	AH120	66 ~ 131	0.002 ~ 0.004	66 ~ 131	0.002 ~ 0.004

MJ INSERT TPM/KR

ISO	Workpiece material	Roughing (Depth of cut: > 0.059")	
		Feed per tooth fz (ipt)	
		TPKR43ZSR-MJ	TPMR2204PDSR-MJ
P	Mild steels · Unhardened steels < 180 HB	0.004 ~ 0.009	0.004 ~ 0.016
	Carbon steels · Alloy steels < 300 HB	0.004 ~ 0.008	0.004 ~ 0.014
	Die steels < 30 HRC	0.004 ~ 0.007	0.004 ~ 0.010

Please refer to the above table for cutting speeds and finishing conditions.

Grade
Insert
Ext. Toolholder
Int. Toolholder
Threading
Grooving
Miniature Tool
Milling Cutter
Endmill
Drilling Tool
Tooling System
User's Guide
Index



TUNGUSLOT NIVERSAL

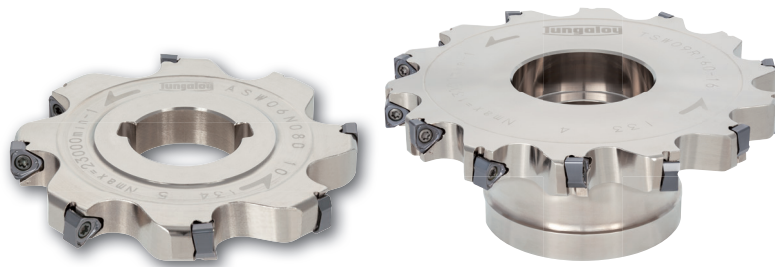

High economy with 6-corner wiper insert
Machining stability with the cutter design for optimum chip evacuation

High economy with 6-corner insert

6-corner insert provides economical advantage. Self-wiper edge delivers good surface quality.

TUNGUSLOT NIVERSAL
6 corners with wiper

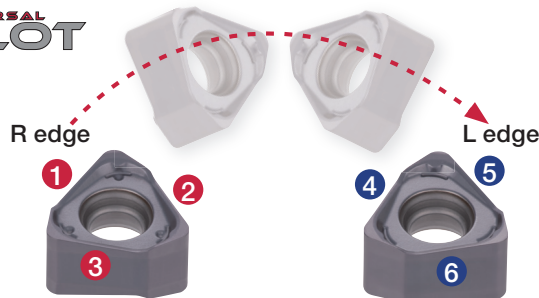

ASW / TSW
CW = 0.394", 0.472", 0.551", 0.630"

Excellent chip evacuation even in deep slot milling - optimum pocket design

TUNGUSLOT NIVERSAL

Competitor

OK



Optimum chipbreaker and big gullets create compact chip formation and smooth evacuation!

X

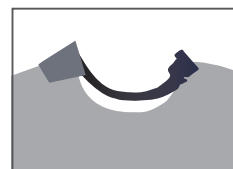

Unformed chip and narrow gullet cause chip packing.

TUNGUSLOT NIVERSAL ASW / TSW type

P Steel 1055 (200HB)
Edge width: CW = 0.394", Dry
Corner radius: RE = 0.031"

Chips at ae = 1.181" depth

TUNGUSLOT NIVERSAL

Competitor A

Cutter	Depth of slot: ae (in)		
	0.394"	0.787"	1.181"
TUNGUSLOT NIVERSAL	○	○	○
Competitor A	○	○	✗

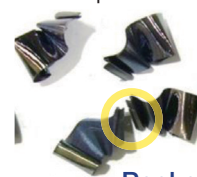

Packed chips

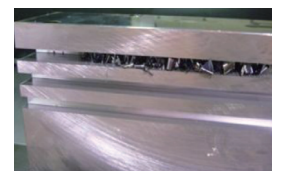

Chips are packed because of bad chip control and flow.

Reference pages: **H157 - H158**

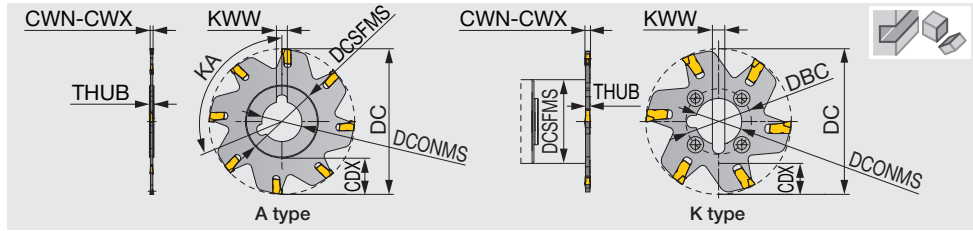

Metric	CWN	CWX	DC	CICT	Seat size	CDX	DCONMS	THUB	DCSFMS	DBC	KA	KWW	SS	SS	Drive flange	Key	Insert
SSG01R063-E1.6	1.5	1.79	63	6	1	14	10	2.4	32	22	-	3	SW25-32	SW1.00-32	-	K	SSM1*N/ SSS1*N
ASG01N076-1.6	1.5	1.79	76.2	8	1	14	25.4	2.4	39	-	112.5	6.35	-	-	-	A	SSM1*N/ SSS1*N
ASG01N080-E1.6	1.5	1.79	80	8	1	16	22	2.4	39	-	112.5	6	-	-	-	A	SSM1*N/ SSS1*N
ASG01N100-1.6	1.5	1.79	100	10	1	30	25.4	2.4	39	-	90	6.35	-	-	-	A	SSM1*N/ SSS1*N
ASG01N100-E1.6	1.5	1.79	100	10	1	30	22	2.4	39	-	90	6	-	-	-	A	SSM1*N/ SSS1*N
ASG01N125-1.6 ⁽⁴⁾	1.5	1.79	125	12	1	30	31.75	2.4	64	-	75	7.92	-	-	-	A	SSM1*N/ SSS1*N
ASG01N125-E1.6 ⁽⁴⁾	1.5	1.79	125	12	1	30	27	2.4	64	-	75	7	-	-	-	A	SSM1*N/ SSS1*N
SSG02R063-E2	1.8	2.69	63	6	2	15	10	2.4	32	22	-	3	SW25-32	SW1.00-32	-	K	SSM2*N/ SSS2*N
ASG02N076-2	1.8	2.69	76.2	8	2	17	25.4	2.4	39	-	112.5	6.35	-	-	-	A	SSM2*N/ SSS2*N
ASG02N080-E2	1.8	2.69	80	8	2	20	22	2.4	39	-	112.5	6	-	-	-	A	SSM2*N/ SSS2*N
ASG02N100-2	1.8	2.69	100	10	2	30	25.4	2.4	39	-	90	6.35	-	-	-	A	SSM2*N/ SSS2*N
ASG02N100-E2	1.8	2.69	100	10	2	30	22	2.4	39	-	90	6	-	-	-	A	SSM2*N/ SSS2*N
ASG02N125-2 ⁽⁴⁾	1.8	2.69	125	12	2	32	31.75	2.4	60	-	75	7.92	-	-	-	A	SSM2*N/ SSS2*N
ASG02N125-E2 ⁽⁴⁾	1.8	2.69	125	12	2	32	27	2.4	60	-	75	7	-	-	-	A	SSM2*N/ SSS2*N
SSG03R063-E3	1.8	2.69	63	5	3	15	10	2.4	32	22	-	3	SW25-32	SW1.00-32	-	K	SSM3*N/ SSS3*N
SSG03R080-3	2.7	3.53	80	6	3	16	25.4	2.4	46	36	-	6.35	SW32-25.4-46-J	SW1.25-46	R1.00-46	K	SSM3*N/ SSS3*N
SSG03R080-E3	2.7	3.53	80	6	3	19 ⁽²⁾	22	2.4	40 ⁽¹⁾	32	-	6	SW32-40	-	R22-46	K	SSM3*N/ SSS3*N
SSG03R100-3	2.7	3.53	100	6	3	26	25.4	2.4	46	36	-	6.35	SW32-25.4-46-J	SW1.25-46	R1.00-46	K	SSM3*N/ SSS3*N
SSG03R100-E3	2.7	3.53	100	6	3	29 ⁽³⁾	22	2.4	40 ⁽¹⁾	32	-	6	SW32-40	-	R22-46	K	SSM3*N/ SSS3*N
SSG03R125-3 ⁽⁴⁾	2.7	3.53	125	8	3	34	31.75	2.4	55	45	-	7.92	-	-	R1.25-55	K	SSM3*N/ SSS3*N
SSG03R125-E3 ⁽⁴⁾	2.7	3.53	125	8	3	34	32	2.4	55	45	-	8	S32-55	-	R32-55	K	SSM3*N/ SSS3*N
SSG04R063-E4	3.54	4.52	63	5	4	15	10	3.2	32	22	-	3	SW25-32	SW1.00-32	-	K	SSM4*N/ SSS4*N
SSG04R080-4	3.54	4.52	80	6	4	16	25.4	3.2	46	36	-	6.35	SW32-25.4-46-J	SW1.25-46	R1.00-46	K	SSM4*N/ SSS4*N
SSG04R080-E4	3.54	4.52	80	6	4	19 ⁽²⁾	22	3.2	40 ⁽¹⁾	32	-	6	SW32-40	-	R22-46	K	SSM4*N/ SSS4*N
SSG04R100-4	3.54	4.52	100	6	4	26	25.4	3.2	46	36	-	6.35	SW32-25.4-46-J	SW1.25-46	R1.00-46	K	SSM4*N/ SSS4*N
SSG04R100-E4	3.54	4.52	100	6	4	29 ⁽³⁾	22	3.2	40 ⁽¹⁾	32	-	6	SW32-40	-	R22-46	K	SSM4*N/ SSS4*N
SSG04R125-4 ⁽⁴⁾	3.54	4.52	125	8	4	34	31.75	3.2	55	45	-	7.92	-	-	R1.25-55	K	SSM4*N/ SSS4*N
SSG04R125-E4 ⁽⁴⁾	3.54	4.52	125	8	4	34	32	3.2	55	45	-	8	S32-55	-	R32-55	K	SSM4*N/ SSS4*N

Tolerance of slot width*
±0.1

*Just for reference

SPARE PARTS

Designation	Grip	Extractor
SSG01/02...	ESG0.5	-
ASG01/02...	ESG0.5	-
SSG03/04...	-	ESG1

- (1) When using a drive flange, DCSFMS = 46 mm
- (2) When using a drive flange, CDX = 16 mm
- (3) When using a drive flange, CDX = 26 mm

- (4) Cutters ø125, only one keyway.
- Note: Since a single insert cuts the full groove width, use an insert with a width that is equal to the groove width in the application.
The CWN and the CWX are the min and max width of the groove respectively possible using the exact width of the insert. the cutter body is not adjustable.





INSERT

SSM

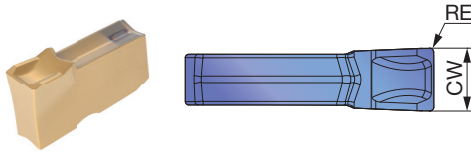

SSS

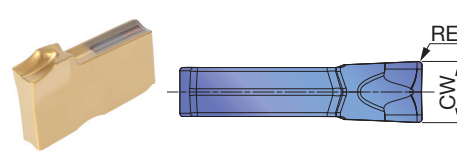

P Steel	★	
M Stainless	★	
K Cast iron	★	
N Non-ferrous		
S Superalloys		
H Hard materials		

★ : First choice
☆ : Second choice

Designation	RE	Coated								CW±0.04	
		GH130									
SSM22N	0.008	●									0.087
SSM31N	0.008	●									0.122
SSM41N	0.010	●									0.161
SSS16N	0.006	●									0.063
SSS22N	0.008	●									0.087
SSS31N	0.008	●									0.122
SSS41N	0.010	●									0.161

● : Line up

STANDARD CUTTING CONDITIONS

ISO	Workpiece material	Hardness (HB)	Insert	Cutting speed Vc (sfm)	Chip thickness t (in)
P	Low carbon steel 1015, etc.	- 200	SSM...	490 - 760	0.0020 - 0.006
	High carbon steel 1045, etc.	200 - 300	SSM...	330 - 560	0.0016 - 0.005
	Alloy steels 4140, etc.	150 - 300	SSM...	300 - 530	0.0016 - 0.005
	Tool steel D2, etc.	- 300	SSM...	230 - 390	0.0016 - 0.005
M	Stainless steel 304, etc.	-	SSS...	300 - 660	0.0016 - 0.005
K	Gray cast iron No250B, etc.	150 - 250	SSM...	330 - 660	0.0020 - 0.006
	Ductile cast iron 65-45-12, etc.	150 - 250	SSM...	260 - 430	0.0020 - 0.006

R (drive flange set)

Drive flange set for side cutters

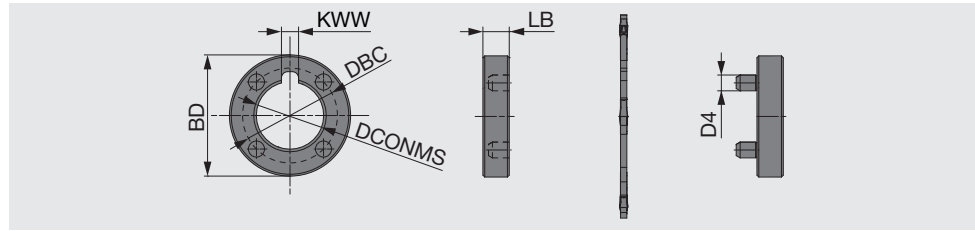

Inch	DCONMS	BD	D4	DBC	LB	KWW
R1.00-46	1.000	1.811	0.197	1.417	0.394	0.250
R1.25-55	1.250	2.165	0.236	1.772	0.394	0.236
Metric	DCONMS	BD	D4	DBC	LB	KWW
R1.00-46	25.4	46	5	36	10	6.35
R22-46	22	46	6	32	10	6

TUNGMSLIT

SW

Drive shank for side cutters

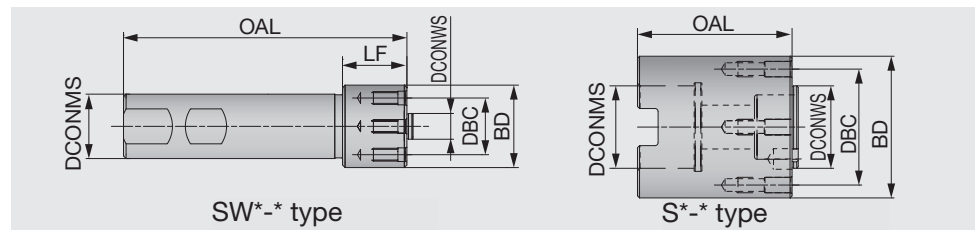

Inch	DCONMS	DCONMS	DCONWS	BD	DBC	LF	OAL
SW1.00-32	1.000	-	0.394	1.260	0.866	1.000	4.331
SW1.25-46	1.250	-	1.000	1.811	1.417	1.181	4.724
S1.25-55	-	1.250	1.250	2.165	1.772	-	2.362
Metric	DCONMS	DCONMS	DCONWS	BD	DBC	LF	OAL
SW25-32	25	-	10	32	22	25	110
SW32-40	32	-	22	40	32	30	120
SW32-25.4-46-J	32	-	25.4	46	36	30	120
S32-55	-	32	32	55	45	-	60

SPARE PARTS



Designation	Screw	Wrench		
		Mono block type	Torx bit	Handle
SW25-32	SR76-961	SETT-15/5	-	-
SW32-40	SR76-963	SETT-15/5	-	-
SW32-25.4-46-J	SR76-963	SETT-15/5	-	-
SW1.00-32	SR76-961	SETT-15/5	-	-
SW1.25-46	SR76-963	SETT-15/5	-	-
S1.25-55	SR76-943	-	BT20M	H-TB
S32-55	SR76-943	-	BT20M	H-TB

*Recommended clamping torque: SR76-961, SR76-963 = 2.58 lbs·ft, 3.5 N·m, SR76-943 = 3.69 lbs·ft, 5 N·m

Grade
Insert
Toolholder
Ext. Toolholder
Int. Toolholder
Threading
Grooving
Miniature Tool
Milling Cutter
Endmill
Drilling Tool
Tooling System
User's Guide
Index



- High Feed Milling
- Face Milling
- Shoulder Milling
- Slot Milling
- Profile Milling
- Thread Milling
- Other
- Approach angle
- 10-20°
- 45°
- 70°
- 85°
- 88°
- 90°
- Others

COMBINATION OF ARBORS / ATTACHMENTS

Cutter bodies : "A" type

A-type disk cutters are without clamping holes on the hub and can be mounted only by using axial drive arbors.

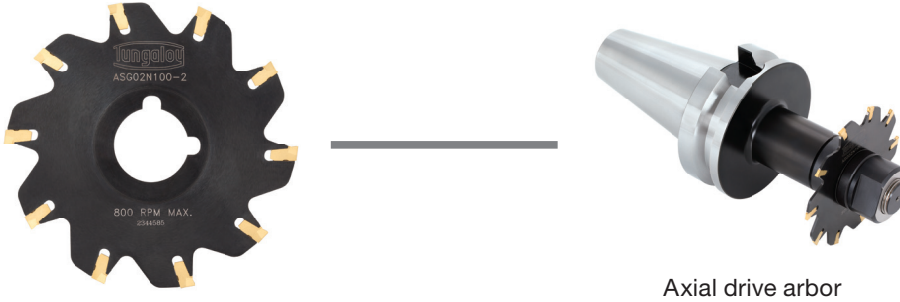

Axial drive arbor

Cutter bodies : "K" type

K-type disk cutters are with clamping holes on the hub and can be mounted by using intermediate shanks or shell adaptors, making it possible to use endmills / shell mill arbors.

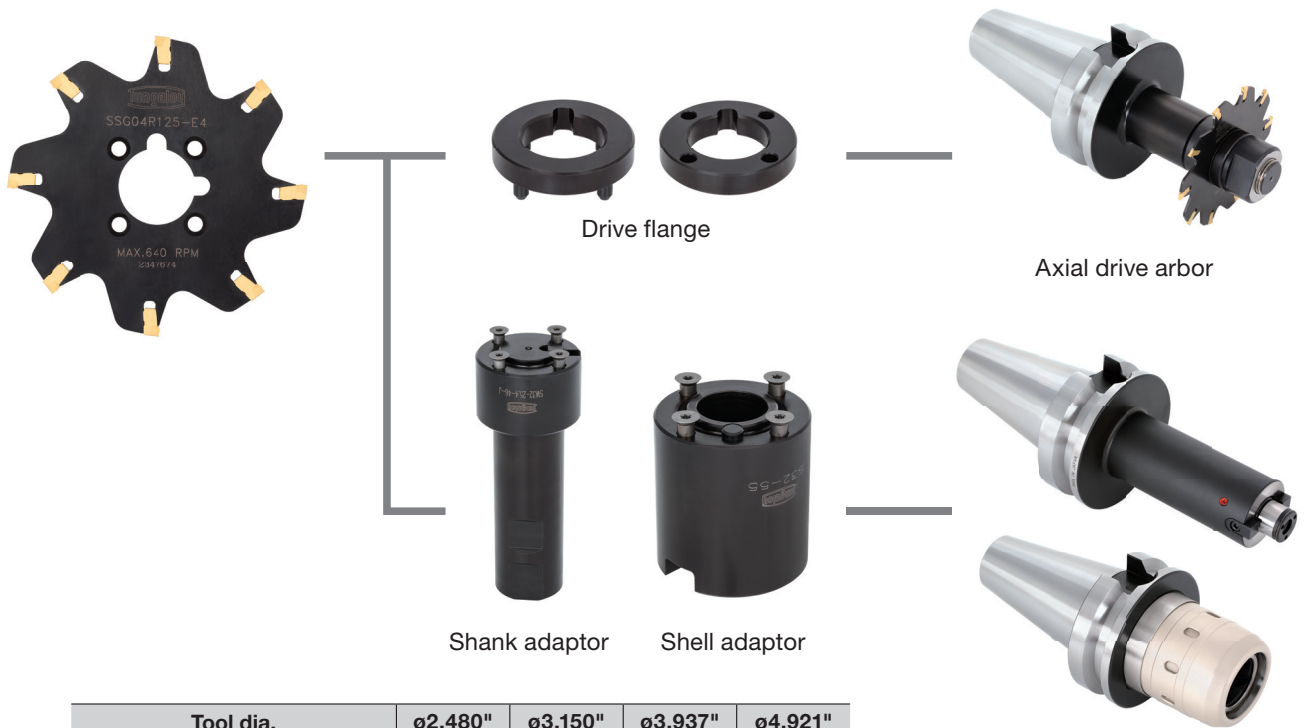

Drive flange

Axial drive arbor

Shank adaptor

Shell adaptor

Shell mill / Endmill arbor

Tool dia.	ø2.480"	ø3.150"	ø3.937"	ø4.921"
Drive flange	-	✓	✓	✓
Shank / Shell adaptor	✓	✓	✓	✓

Axial drive slot mill, for tangentially mounted inserts

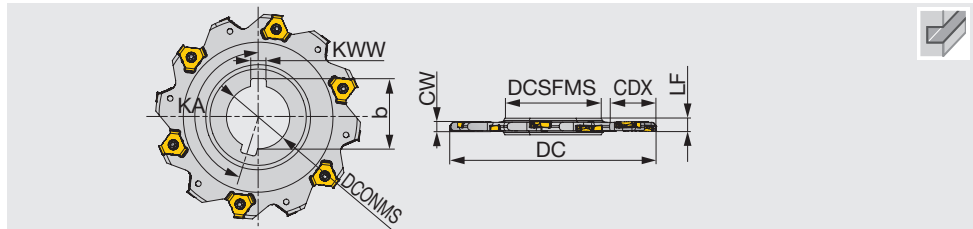

Inch	CW	DC	ZEPF/CICT	DCSFMS	DCONMS	LF	b	KWW	CDX	KA	Insert
ASV04N300-U025	0.250	3.000	4/8	1.614	1.000	0.394	1.102	0.250	0.595	157.5	TVKX04H3**
ASV04N400-U025	0.250	4.000	5/10	1.890	1.250	0.394	1.386	0.312	0.957	162	TVKX04H3**
ASV04N500-U025	0.250	5.000	6/12	2.283	1.500	0.394	1.665	0.375	1.260	165	TVKX04H3**
ASV04N600-U025	0.250	6.000	8/16	2.283	1.500	0.394	1.665	0.375	1.760	168.75	TVKX04H3**
ASV04N800-U025	0.250	8.000	10/20	2.717	2.000	0.394	2.197	0.500	2.543	171	TVKX04H3**
ASV05N300-U031	0.313	3.000	4/8	1.614	1.000	0.472	1.102	0.250	0.595	157.5	TVKX0504**
ASV05N400-U031	0.313	4.000	5/10	1.890	1.250	0.472	1.386	0.312	0.957	162	TVKX0504**
ASV05N500-U031	0.313	5.000	6/12	2.283	1.500	0.472	1.665	0.375	1.260	165	TVKX0504**
ASV05N600-U031	0.313	6.000	8/16	2.283	1.500	0.472	1.665	0.375	1.760	168.75	TVKX0504**
ASV05N800-U031	0.313	8.000	10/20	2.717	2.000	0.472	2.197	0.500	2.543	171	TVKX0504**

Metric	CW	DC	ZEPF/CICT	DCSFMS	DCONMS	LF	b	KWW	CDX	KA	Insert
ASV02N080-4	4	80	5/10	41	25.4	6	28	6.35	15	162	TVKX0202...
ASV02N080-E4	4	80	5/10	41	27	6	29.8	7	15	162	TVKX0202...
ASV02N100-4	4	100	6/12	48	31.75	6	35.2	7.92	20	165	TVKX0202...
ASV02N100-E4	4	100	6/12	47	32	6	34.8	8	20	165	TVKX0202...
ASV02N125-4	4	125	8/16	58	38.1	6	42.3	9.52	30	168.75	TVKX0202...
ASV02N125-E4	4	125	8/16	55	40	6	43.5	10	30	168.75	TVKX0202...
ASV02N160-4	4	160	10/20	58	38.1	6	42.3	9.52	45	171	TVKX0202...
ASV02N160-E4	4	160	10/20	55	40	6	43.5	10	45	171	TVKX0202...
ASV03N080-5	5	80	5/10	41	25.4	6.5	28	6.35	15	162	TVKX03X3...
ASV03N080-E5	5	80	5/10	41	27	6.5	29.8	7	15	162	TVKX03X3...
ASV03N100-5	5	100	6/12	48	31.75	6.5	35.2	7.92	20	165	TVKX03X3...
ASV03N100-E5	5	100	6/12	47	32	6.5	34.8	8	20	165	TVKX03X3...
ASV03N125-5	5	125	8/16	58	38.1	6.5	42.3	9.52	30	168.75	TVKX03X3...
ASV03N125-E5	5	125	8/16	55	40	6.5	43.5	10	30	168.75	TVKX03X3...
ASV03N160-5	5	160	10/20	58	38.1	6.5	42.3	9.52	45	171	TVKX03X3...
ASV03N160-E5	5	160	10/20	55	40	6.5	43.5	10	45	171	TVKX03X3...
ASV04N080-6	6	80	4/8	41	25.4	8	28	6.35	17	157.5	TVKX04H3...
ASV04N080-E6	6	80	4/8	41	27	8	29.8	7	17	157.5	TVKX04H3...
ASV04N100-6	6	100	5/10	48	31.75	8	35.2	7.92	23.5	162	TVKX04H3...
ASV04N100-E6	6	100	5/10	47	32	8	34.8	8	23.5	162	TVKX04H3...
ASV04N125-6	6	125	6/12	58	38.1	8	42.3	9.52	31	165	TVKX04H3...
ASV04N125-E6	6	125	6/12	55	40	8	43.5	10	32.5	165	TVKX04H3...
ASV04N160-6	6	160	8/16	58	38.1	8	42.3	9.52	48.5	168.75	TVKX04H3...
ASV04N160-E6	6	160	8/16	55	40	8	43.5	10	50	168.75	TVKX04H3...
ASV04N200-6	6	200	10/20	69	50.8	8	55.8	12.7	63	171	TVKX04H3...
ASV04N200-E6	6	200	10/20	69	50	8	53.5	12	63	171	TVKX04H3...
ASV05N080-8	8	80	4/8	41	25.4	10	28	6.35	17	157.5	TVKX0504...
ASV05N080-E8	8	80	4/8	41	27	10	29.8	7	17	157.5	TVKX0504...
ASV05N100-8	8	100	5/10	48	31.75	10	35.2	7.92	23.5	162	TVKX0504...
ASV05N100-E8	8	100	5/10	47	32	10	34.8	8	23.5	162	TVKX0504...
ASV05N125-8	8	125	6/12	58	38.1	10	42.3	9.52	31	165	TVKX0504...
ASV05N125-E8	8	125	6/12	55	40	10	43.5	10	32.5	165	TVKX0504...
ASV05N160-8	8	160	8/16	58	38.1	10	42.3	9.52	48.5	168.75	TVKX0504...
ASV05N160-E8	8	160	8/16	55	40	10	43.5	10	50	168.75	TVKX0504...
ASV05N200-8	8	200	10/20	69	50.8	10	55.8	12.7	63	171	TVKX0504...
ASV05N200-E8	8	200	10/20	69	50	10	53.5	12	63	171	TVKX0504...

SPARE PARTS

Designation	Clamping screw	Grip	Lubricant
ASV04N...	SR14-500/L5.1	BT15S	H-TBS
ASV05N...	SR14-500-L7.0	BT15S	H-TBS
ASV05N...	SR14-500-L7.0	H-TB2W	M-1000

*Recommended clamping torque : SR14-500/L5.1 = 3.32 lbs·ft, 3.5 N·m, SR14-500-L7.0 = 2.58 lbs·ft, 3.5 N·m

Grade
Insert
Toolholder
Ext. Toolholder
Int. Toolholder
Threading
Grooving
Miniature Tool
Milling Cutter
Endmill
Drilling Tool
Tooling System
User's Guide
Index



INSERT

TVKX-MJ

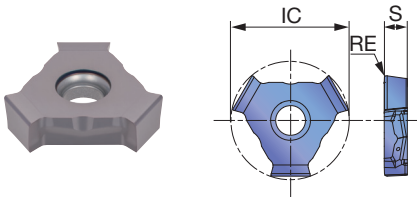

P	Steel	☆	★	★
M	Stainless		★	☆
K	Cast iron	★		☆
N	Non-ferrous			
S	Superalloys	★	☆	★
H	Hard materials			

★ : First choice
☆ : Second choice

Designation	RE	Coated			S	IC
		AH120	AH130	AH725		
TVKX020202TN-MJ	0.008	●	●		0.094	0.370
TVKX020204TN-MJ	0.016	●	●		0.094	0.370
TVKX03X302TN-MJ	0.008	●	●		0.126	0.370
TVKX03X304TN-MJ	0.016	●	●		0.126	0.370
TVKX04H304TN-MJ	0.016	●	●	●	0.138	0.665
TVKX04H308TN-MJ	0.031	●	●	●	0.138	0.665
TVKX050404TN-MJ	0.016	●	●	●	0.177	0.665
TVKX050408TN-MJ	0.031	●	●	●	0.177	0.665

● : Line up

STANDARD CUTTING CONDITIONS

ISO	Workpiece material	Hardness (HB)	Priority	Grade	Cutting speed Vc (sfm)	Feed per edge line: fz (ipt)			
						ASV		ASV	
						ae / DC (in)		ae / DC (in)	
						10%	20%	30%	≤ 50%
P	Low carbon steels 1015, etc.	- 200	First choice	AH725	300 - 590	0.0031 - 0.0098	0.0024 - 0.0075	0.0020 - 0.0063	0.0020 - 0.0059
		- 200	Fracture resistance	AH130	300 - 590	0.0031 - 0.0098	0.0024 - 0.0075	0.0020 - 0.0063	0.0020 - 0.0059
	High carbon steels 1045, etc.	200 - 300	First choice	AH725	300 - 590	0.0028 - 0.0087	0.0020 - 0.0063	0.0016 - 0.0055	0.0016 - 0.0051
		200 - 300	Fracture resistance	AH130	300 - 590	0.0028 - 0.0087	0.0020 - 0.0063	0.0016 - 0.0055	0.0016 - 0.0051
	Alloy steels 4140, etc.	150 - 300	First choice	AH725	300 - 590	0.0028 - 0.0087	0.0020 - 0.0063	0.0016 - 0.0055	0.0016 - 0.0051
		150 - 300	Fracture resistance	AH130	300 - 590	0.0028 - 0.0087	0.0020 - 0.0063	0.0016 - 0.0055	0.0016 - 0.0051
	Tool steels D2, etc.	- 300	First choice	AH725	300 - 590	0.0028 - 0.0087	0.0020 - 0.0063	0.0016 - 0.0055	0.0016 - 0.0051
		- 300	Fracture resistance	AH130	300 - 590	0.0028 - 0.0087	0.0020 - 0.0063	0.0016 - 0.0055	0.0016 - 0.0051
M	Stainless steel 304, etc.	-	-	AH130	300 - 660	0.0028 - 0.0087	0.0020 - 0.0063	0.0016 - 0.0055	0.0016 - 0.0051
K	Gray cast irons No250B, etc.	150 - 250	-	AH120	390 - 760	0.0031 - 0.0098	0.0024 - 0.0075	0.0020 - 0.0063	0.0020 - 0.0059
	Ductile cast irons 65-45-12, etc.	150 - 250	-	AH120	300 - 490	0.0031 - 0.0098	0.0024 - 0.0075	0.0020 - 0.0063	0.0020 - 0.0059
S	Titanium alloys Ti-6Al-4V, etc.	-	First choice	AH725	100 - 130	0.0028 - 0.0047	0.0020 - 0.0035	0.0016 - 0.0028	0.0016 - 0.0028
		-	Fracture resistance	AH130	100 - 130	0.0028 - 0.0047	0.0020 - 0.0035	0.0016 - 0.0028	0.0016 - 0.0028
	Nickel-based alloys Inconel 718, etc.	-	First choice	AH725	70 - 120	0.0028 - 0.0047	0.0020 - 0.0035	0.0016 - 0.0028	0.0016 - 0.0028
		-	Fracture resistance	AH130	70 - 120	0.0028 - 0.0047	0.0020 - 0.0035	0.0016 - 0.0028	0.0016 - 0.0028

Axial drive slot mill, for 6-corner double sided inserts

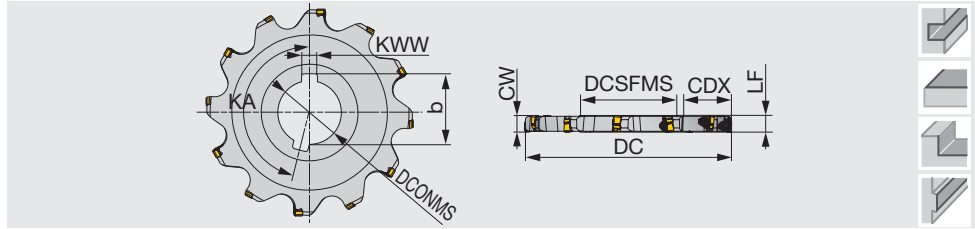
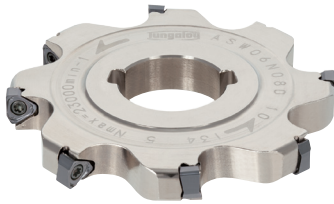

Inch	CW	DC	ZEFP/CICT	DCSFMS	DCONMS	LF	b	KWW	CDX	KA	Insert
ASW06N300-U037	0.375	3.000	4/8	1.614	1.000	0.375	1.102	0.250	0.654	157.5°	WNGU0603**
ASW06N400-U037	0.375	4.000	5/10	1.890	1.250	0.375	1.386	0.312	1.016	162°	WNGU0603**
ASW06N500-U037	0.375	5.000	6/12	2.283	1.500	0.375	1.665	0.375	1.319	165°	WNGU0603**
ASW06N600-U037	0.375	6.000	7/14	2.283	1.500	0.375	1.665	0.375	1.819	167.14°	WNGU0603**
ASW07N400-U050	0.500	4.000	5/10	1.890	1.250	0.500	1.386	0.312	1.016	162°	WNGU07T3**
ASW07N500-U050	0.500	5.000	6/12	2.283	1.500	0.500	1.665	0.375	1.319	165°	WNGU07T3**
ASW07N600-U050	0.500	6.000	7/14	2.283	1.500	0.500	1.665	0.375	1.819	167.14°	WNGU07T3**
ASW09N600-U062	0.625	6.000	7/14	2.283	1.500	0.625	1.665	0.375	1.819	167.14°	WNGU0904**

SPARE PARTS

Designation	Clamping screw	Clamping screw 1	Grip	Grip 1	Torx bit	Wrench	Lubricant
ASW06N...	-	CSPB-2.5	-	-	-	IP-8D	M-1000
ASW07N400...	-	CSPD-3	-	SW6-SD	BLD IP10/S7	-	M-1000
ASW07N500...	-	CSPD-3	-	SW6-SD	BLD IP10/S7	-	M-1000
ASW07N600...	-	CSPD-3	-	-	-	IP-10D	M-1000
ASW09N400...	CSPB-3.5	-	H-TBS	-	BLD IP15/S7	-	M-1000
ASW09N600...	CSPB-3.5	-	-	-	-	IP-15D	M-1000

*Recommended clamping torque : CSPB-2.5 = 0.96 lbs·ft, CSPB-3.5 = 2.58 lbs·ft, CSPD-3 = 1.84 lbs·ft

Radial drive slot mill, for 6-corner double sided inserts

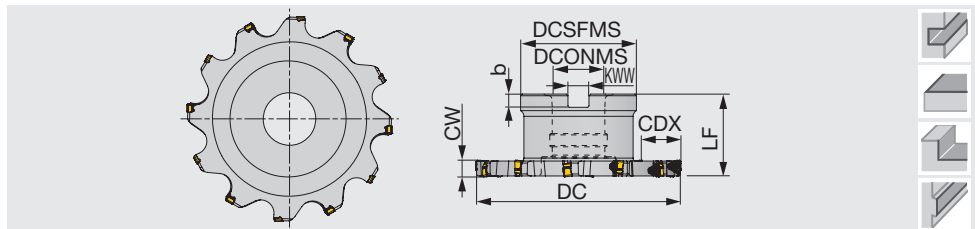

Inch	CW	DC	ZEFP/CICT	DCSFMS	DCONMS	LF	b	KWW	CDX	Insert
TSW06R400-U037	0.375	4.000	5/10	1.969	1.000	1.969	0.236	0.374	0.976	WNGU0603...
TSW06R500-U037	0.375	5.000	6/12	2.756	1.250	1.969	0.315	0.500	1.083	WNGU0603...
TSW06R600-U037	0.375	6.000	7/14	3.937	1.500	2.480	0.394	0.626	0.992	WNGU0603...
TSW07R400-U050	0.500	4.000	5/10	1.969	1.000	1.969	0.236	0.374	0.976	WNGU07T3...
TSW07R500-U050	0.500	5.000	6/12	2.756	1.250	1.969	0.315	0.500	1.083	WNGU07T3...
TSW07R600-U050	0.500	6.000	7/14	3.937	1.500	2.480	0.394	0.626	0.992	WNGU07T3...
TSW09R600-U062	0.625	6.000	7/14	3.937	1.500	2.480	0.394	0.626	0.992	WNGU0904...

SPARE PARTS

Designation	Clamping screw1	Clamping screw2	Grip	Lubricant	Torx bit	Mono block type Torx bit	Shell locking bolt (Optional parts)
TSW06R400-U037	-	CSPB-2.5	-	M-1000	-	IP-8D	(C0.500X1.375H)
TSW06R500-U037	-	CSPD-3	-	M-1000	-	IP-8D	-
TSW06R600-U037	-	CSPD-3	-	M-1000	-	IP-8D	(TMBA-0.750H)
TSW07R400-U050	-	CSPD-3	SW6-SD	M-1000	BLD IP10/S7	-	(C0.500X1.375H)
TSW07R500-U050	-	CSPD-3	SW6-SD	M-1000	BLD IP10/S7	-	-
TSW07R600-U050	-	CSPD-3	-	M-1000	-	IP-10D	(TMBA-0.750H)
TSW09R600-U062	CSPB-3.5	-	-	M-1000	-	IP-15D	(TMBA-0.750H)

*Recommended clamping torque : CSPB-2.5 = 0.96 lbs·ft, CSPB-3.5 = 2.58 lbs·ft, CSPD-3 = 1.84 lbs·ft



INSERT

WNGU-MJ

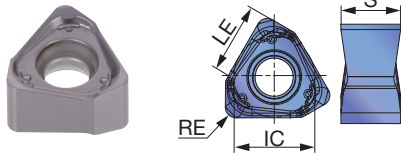

P	Steel	☆	★	★
M	Stainless		★	☆
K	Cast iron	★	☆	
N	Non-ferrous			
S	Superalloys	★	☆	★
H	Hard materials			

★ : First choice
☆ : Second choice

Designation	RE	Coated				LE	IC	S
		AH120	AH130	AH725	AH3135			
WNGU060304TN-MJ	0.016	●			●	0.220	0.240	0.173
WNGU060308TN-MJ	0.031	●	●	●	●	0.220	0.240	0.173
WNGU060310TN-MJ	0.039	●			●	0.220	0.240	0.173
WNGU060316TN-MJ	0.063	●	●	●		0.220	0.240	0.173
WNGU060320TN-MJ	0.079	●			●	0.220	0.240	0.173
WNGU07T304TN-MJ	0.016	●			●	0.268	0.291	0.217
WNGU07T308TN-MJ	0.031	●	●	●		0.268	0.291	0.217
WNGU07T310TN-MJ	0.039	●			●	0.268	0.291	0.217
WNGU07T316TN-MJ	0.063	●	●	●		0.268	0.291	0.217
WNGU07T320TN-MJ	0.079	●			●	0.268	0.291	0.217
WNGU090404TN-MJ	0.016	●			●	0.335	0.339	0.256
WNGU090408TN-MJ	0.031	●	●	●		0.335	0.339	0.256
WNGU090410TN-MJ	0.039	●			●	0.335	0.339	0.256
WNGU090416TN-MJ	0.063	●	●	●		0.335	0.339	0.256
WNGU090420TN-MJ	0.079	●			●	0.335	0.339	0.256

● : Line up

STANDARD CUTTING CONDITIONS

ISO	Workpiece material	Hardness (HB)	Priority	Grade	Cutting speed Vc (sfm)	Feed per edge line: fz (ipt)			
						TSW / ASW			
						ae / DC (in)			
						10%	20%	30%	≤ 50%
P	Low carbon steels 1015, etc.	- 200	First choice	AH725	300 - 590	0.0047 - 0.0130	0.0035 - 0.0098	0.0028 - 0.0083	0.0028 - 0.0079
		- 200	Fracture resistance	AH130	300 - 590	0.0047 - 0.0130	0.0035 - 0.0098	0.0028 - 0.0083	0.0028 - 0.0079
	High carbon steels 1045, etc.	200 - 300	First choice	AH725	300 - 590	0.0047 - 0.0130	0.0035 - 0.0098	0.0028 - 0.0083	0.0028 - 0.0079
		200 - 300	Fracture resistance	AH130	300 - 590	0.0047 - 0.0130	0.0035 - 0.0098	0.0028 - 0.0083	0.0028 - 0.0079
	Alloy steels 4140, etc.	150 - 300	First choice	AH725	300 - 590	0.0047 - 0.0130	0.0035 - 0.0098	0.0028 - 0.0083	0.0028 - 0.0079
		150 - 300	Fracture resistance	AH130	300 - 590	0.0047 - 0.0130	0.0035 - 0.0098	0.0028 - 0.0083	0.0028 - 0.0079
Tool steels D2, etc.	- 300	First choice	AH725	300 - 590	0.0047 - 0.0130	0.0035 - 0.0098	0.0028 - 0.0083	0.0028 - 0.0079	
	- 300	Fracture resistance	AH130	300 - 590	0.0047 - 0.0130	0.0035 - 0.0098	0.0028 - 0.0083	0.0028 - 0.0079	
M	Stainless steel 304, etc.	-	-	AH130	300 - 660	0.0047 - 0.0130	0.0035 - 0.0098	0.0028 - 0.0083	0.0028 - 0.0079
K	Gray cast irons No250B, etc.	150 - 250	-	AH120	390 - 760	0.0047 - 0.0165	0.0035 - 0.0122	0.0028 - 0.0106	0.0028 - 0.0098
	Ductile cast irons 65-45-12, etc.	150 - 250	-	AH120	300 - 490	0.0047 - 0.0165	0.0035 - 0.0122	0.0028 - 0.0106	0.0028 - 0.0098
S	Titanium alloys Ti-6Al-4V, etc.	-	First choice	AH725	100 - 130	0.0039 - 0.0067	0.0031 - 0.0051	0.0024 - 0.0043	0.0024 - 0.0039
		-	Fracture resistance	AH130	100 - 130	0.0039 - 0.0067	0.0031 - 0.0051	0.0024 - 0.0043	0.0024 - 0.0039
	Nickel-based alloys Inconel 718, etc.	-	First choice	AH725	70 - 120	0.0039 - 0.0067	0.0031 - 0.0051	0.0024 - 0.0043	0.0024 - 0.0039
		-	Fracture resistance	AH130	70 - 120	0.0039 - 0.0067	0.0031 - 0.0051	0.0024 - 0.0043	0.0024 - 0.0039

Axial drive slot mill, for tangentially mounted inserts

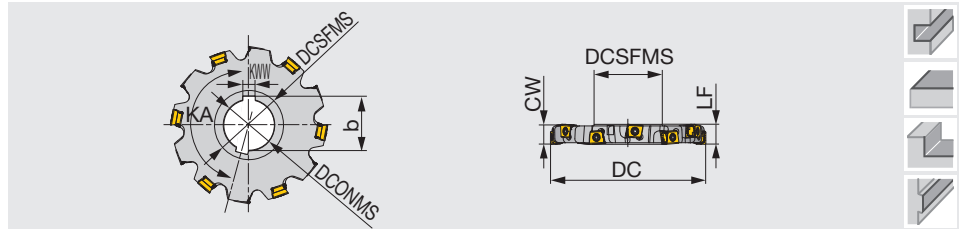

Inch	CW	DC	ZEFP	CICT	DCSFMS	DCONMS	LF	b	KWW	CDX	KA	Insert
ASN10R100M31.7-16-05	0.630	3.937	5	10	1.890	1.250	0.630	1.386	0.312	0.984	162°	LMEU1008**ZNEN-MJ
ASN10R125M38.1-16-06	0.630	4.921	6	12	2.283	1.500	0.630	1.665	0.375	1.280	165°	LMEU1008**ZNEN-MJ
ASN10R160M38.1-16-07	0.630	6.299	7	14	2.283	1.500	0.630	1.665	0.375	1.969	167.14°	LMEU1008**ZNEN-MJ
ASN12R100M31.7-19-05	0.748	3.937	5	10	1.890	1.250	0.748	1.386	0.312	0.984	162°	LMEU1208**ZNEN-MJ
ASN12R125M38.1-19-06	0.748	4.921	6	12	2.283	1.500	0.748	1.665	0.375	1.280	165°	LMEU1208**ZNEN-MJ
ASN12R160M38.1-19-07	0.748	6.299	7	14	2.283	1.500	0.748	1.665	0.375	1.969	167.14°	LMEU1208**ZNEN-MJ
ASN15R125M38.1-25-05	0.984	4.921	5	10	2.283	1.500	0.984	1.665	0.375	1.280	162°	LMEU1509**ZNEN-MJ
ASN15R160M38.1-25-06	0.984	6.299	6	12	2.283	1.500	0.984	1.665	0.375	1.969	165°	LMEU1206**ZNEN-MJ

SPARE PARTS

Designation	Clamping screw	Grip	Torx bit
ASN10/12R...	SM40-143-H0	H-TB	BT15S
ASN15R...	CSTB-5L159	H-TB	BT20S

*Recommended clamping torque : SM40-143-H0 = 0.96 lbs·ft, CSTB-5L159 = 3.69 lbs·ft

Radial drive slot mill, for tangentially mounted inserts

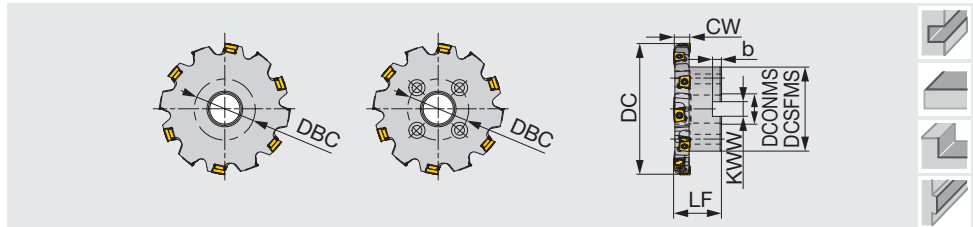

Inch	CW	DC	ZEFP	CICT	DCSFMS	DCONMS	LF	b	KWW	CDX	DBC	Insert
TSN10R100M25.4-16-05	0.630	3.937	5	10	1.969	1.000	1.969	0.236	0.374	0.945	-	LMEU1008**ZNEN-MJ
TSN10R125M31.7-16-06	0.630	4.921	6	12	2.756	1.250	1.969	0.315	0.500	1.043	-	LMEU1008**ZNEN-MJ
TSN10R160M38.1-16-07	0.630	6.299	7	14	3.937	1.500	2.480	0.394	0.626	1.142	-	LMEU1008**ZNEN-MJ
TSN10R200M47.6-16-08	0.630	7.874	8	16	5.315	1.875	2.480	0.551	1.000	1.240	4.000	LMEU1008**ZNEN-MJ
TSN12R100M25.4-19-05	0.748	3.937	5	10	1.969	1.000	1.969	0.236	0.374	0.945	-	LMEU1208**ZNEN-MJ
TSN12R125M31.7-19-06	0.748	4.921	6	12	2.756	1.250	1.969	0.315	0.500	1.043	-	LMEU1208**ZNEN-MJ
TSN12R160M38.1-19-07	0.748	6.299	7	14	3.937	1.500	2.480	0.394	0.626	1.142	-	LMEU1208**ZNEN-MJ
TSN12R200M47.6-19-08	0.748	7.874	8	16	5.315	1.875	2.480	0.551	1.000	1.240	4.000	LMEU1208**ZNEN-MJ
TSN12R250M47.6-19-09	0.748	9.843	9	18	5.512	1.875	2.480	0.551	1.000	2.126	4.000	LMEU1208**ZNEN-MJ
TSN15R125M31.7-25-05	0.984	4.921	5	10	2.756	1.250	1.969	0.315	0.500	1.043	-	LMEU1509**ZNEN-MJ
TSN15R160M38.1-25-06	0.984	6.299	6	12	3.937	1.500	2.480	0.394	0.626	1.142	-	LMEU1509**ZNEN-MJ
TSN15R200M50.8-25-07	0.984	7.874	7	14	5.315	2.000	2.480	0.551	1.000	1.240	4.000	LMEU1509**ZNEN-MJ
TSN15R250M63.5-25-08	0.984	9.843	8	16	5.512	2.500	2.480	0.551	1.000	2.126	4.000	LMEU1509**ZNEN-MJ

SPARE PARTS

Designation	Clamping screw	Grip	Torx bit	Shell locking bolts (Optional parts)
TSN10R100M25.4-16-05	SM40-143-H0	H-TB	B_T15S	(C0.500X1.375H)
TSN10/12R125M..., TSN10/12R200M..., TSN12R125M..., TSN12R250M...	SM40-143-H0	H-TB	B_T15S	-
TSN10/12R160M...	SM40-143-H0	H-TB	B_T15S	(TMBA-0.750H)
TSN15R125M..., TSN15R200M..., TSN15R250M...	CSTB-5L159	H-TB	BT-20S	-
TSN15R160M38.1-25-06	CSTB-5L159	H-TB	BT-20S	(TMBA-0.750H)

*Recommended clamping torque : SM40-143-H0 = 0.96 lbs·ft, CSTB-5L159 = 3.69 lbs·ft

Reference pages: Inserts, Standard cutting conditions → **H160**



INSERT

LMEU-MJ

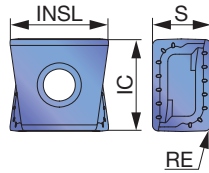

P Steel	☆	☆	☆	★
M Stainless		☆	☆	★
K Cast iron	★		☆	
N Non-ferrous				
S Superalloys	★		★	
H Hard materials				

★ : First choice
☆ : Second choice

Designation	RE	Coated				INSL	IC	S
		AH120	AH140	AH725	AH3135			
LMEU100808ZNEN-MJ	0.031	●	●	●	●	0.500	0.413	0.315
LMEU100810ZNEN-MJ	0.039	●			●	0.500	0.413	0.315
LMEU100816ZNEN-MJ	0.063	●	●	●	●	0.492	0.413	0.315
LMEU100820ZNEN-MJ	0.079	●			●	0.488	0.413	0.315
LMEU100824ZNEN-MJ	0.094	●	●	●	●	0.488	0.413	0.315
LMEU100830ZNEN-MJ	0.118	●			●	0.480	0.413	0.315
LMEU100832ZNEN-MJ	0.126	●	●	●	●	0.480	0.413	0.315
LMEU120808ZNEN-MJ	0.031	●	●	●	●	0.535	0.500	0.315
LMEU120816ZNEN-MJ	0.063	●	●	●	●	0.528	0.500	0.315
LMEU120820ZNEN-MJ	0.079	●			●	0.524	0.500	0.315
LMEU120824ZNEN-MJ	0.094	●	●	●	●	0.520	0.500	0.315
LMEU120830ZNEN-MJ	0.118	●			●	0.516	0.500	0.315
LMEU120832ZNEN-MJ	0.126	●	●	●	●	0.516	0.500	0.315
LMEU150908ZNEN-MJ	0.031	●	●	●	●	0.614	0.591	0.374
LMEU150916ZNEN-MJ	0.063	●	●	●	●	0.606	0.591	0.374
LMEU150920ZNEN-MJ	0.079	●			●	0.606	0.591	0.374
LMEU150924ZNEN-MJ	0.094	●	●	●	●	0.602	0.591	0.374
LMEU150930ZNEN-MJ	0.118	●			●	0.598	0.591	0.374
LMEU150932ZNEN-MJ	0.126	●	●	●	●	0.594	0.591	0.374
LMEU150940ZNEN-MJ*	0.157	●			●	0.587	0.591	0.374
LMEU150950ZNEN-MJ*	0.197	●			●	0.579	0.591	0.374

* Please note that LMEU150940 and LMEU150950 inserts are for special cutter bodies only and do not fit standard versions.

● : Line up

STANDARD CUTTING CONDITIONS

ISO	Workpiece material	Hardness (HB)	Priority	Grade	Cutting speed Vc (sfm)	Feed per edge line: fz (ipt)			
						TSN / ASN			
						ae / DC (in)			
						10%	20%	30%	≤ 50%
P	Low carbon steels 1015, etc.	- 200	First choice	AH3135	300 - 590	0.0087 - 0.0165	0.0063 - 0.0122	0.0055 - 0.0106	0.0051 - 0.0098
		- 200	Fracture resistance	AH725	300 - 590	0.0087 - 0.0165	0.0063 - 0.0122	0.0055 - 0.0106	0.0051 - 0.0098
	High carbon steels 1045, etc.	200 - 300	First choice	AH3135	300 - 590	0.0087 - 0.0165	0.0063 - 0.0122	0.0055 - 0.0106	0.0051 - 0.0098
		200 - 300	Fracture resistance	AH725	300 - 590	0.0087 - 0.0165	0.0063 - 0.0122	0.0055 - 0.0106	0.0051 - 0.0098
	Alloy steels 4140, etc.	150 - 300	First choice	AH3135	300 - 590	0.0087 - 0.0165	0.0063 - 0.0122	0.0055 - 0.0106	0.0051 - 0.0098
		150 - 300	Fracture resistance	AH725	300 - 590	0.0087 - 0.0165	0.0063 - 0.0122	0.0055 - 0.0106	0.0051 - 0.0098
Tool steels D2, etc.	- 300	First choice	AH3135	300 - 590	0.0087 - 0.0165	0.0063 - 0.0122	0.0055 - 0.0106	0.0051 - 0.0098	
	- 300	Fracture resistance	AH725	300 - 590	0.0087 - 0.0165	0.0063 - 0.0122	0.0055 - 0.0106	0.0051 - 0.0098	
M	Stainless steel 304, etc.	-	-	AH3135	300 - 660	0.0087 - 0.0165	0.0063 - 0.0122	0.0055 - 0.0106	0.0051 - 0.0098
K	Gray cast irons No250B, etc.	150 - 250	-	AH120	390 - 760	0.0087 - 0.0200	0.0063 - 0.0150	0.0055 - 0.0126	0.0051 - 0.0118
	Ductile cast irons 65-45-12, etc.	150 - 250	-	AH120	300 - 490	0.0087 - 0.0130	0.0063 - 0.0098	0.0055 - 0.0083	0.0051 - 0.0079
S	Titanium alloys Ti-6Al-4V, etc.	-	First choice	AH725	100 - 130	0.0047 - 0.0087	0.0035 - 0.0063	0.0028 - 0.0055	0.0028 - 0.0051
	Nickel-based alloys Inconel 718, etc.	-	First choice	AH725	70 - 120	0.0047 - 0.0087	0.0035 - 0.0063	0.0028 - 0.0055	0.0028 - 0.0051

MEMO

A large grid of 20 columns and 30 rows for writing notes. The grid is composed of small squares, with a slightly larger square in the top-left corner. The grid is intended for taking notes or recording information.

Grade

A

Insert

B

Ext. Toolholder

C

Int. Toolholder

D

Threading

E

Grooving

F

Miniature Tool

G

Milling Cutter

H

Endmill

I

Drilling Tool

J

Tooling System

K

User's Guide

L

Index

M

PROFILEMILL SERIES



Lineups and Application Ranges

- All inserts are precision ground, making them suitable for various applications ranging from roughing to finishing
- Increased reliability thanks to the innovative insert clamping design

Finishing

Ball type



BALL^{FINISH}NOSE
Tool diameter $\varnothing 0.375'' - \varnothing 1.250''$
(R4 - R16)

Radius type



BALL^{FINISH}NOSE
Tool diameter $\varnothing 0.375'' - \varnothing 1.250''$
(R0.5 - R1.5)

Semi-Finishing



BALL^{ROUGH}NOSE
Tool diameter $\varnothing 0.625'' - \varnothing 1.000''$
(R8 - R12.5)



DOM^{INI}MILL
Tool diameter $\varnothing 16 \text{ mm} - 25 \text{ mm}$
(R0.5, R1.0)

Roughing

Reference pages: BallFinishNose → **H166 - H170**, BallRoughNose → **H164 - H165**, DoMini-Mill → **H171**



Indexable endmill for high precision finishing!

Secure clamping mechanism



- Clamping force gathers on the flat part of the insert hole as the screw is tightened.
- The force pushes the insert towards the cutter body, providing high repeatability and rigidity as well as minimum run-out.

Unique coolant delivery system

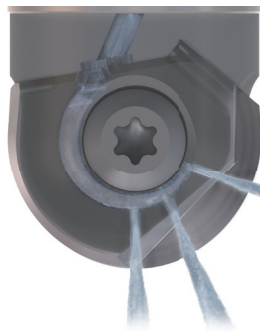

- The coolant channel on insert surface, delivers coolant to the cutting edge from three directions.
- Excellent chip evacuation and cooling effect provides good surface finish and long tool life in machining of hardened steel.

Two insert varieties

MJ chipbreaker

Ball nose type: ZFBM

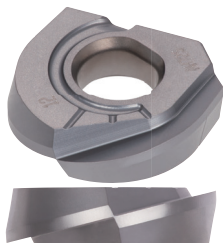

- Suitable for finishing and three-dimensional milling of die & mold
- Applicable for a wide range of operations

Radius type: ZFRM

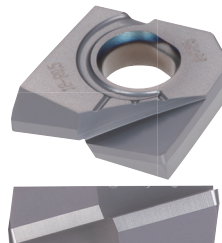

- Suitable for finishing of die & mold
- Designed for milling with high productivity

Reference pages: **H166 - H170**



BALL^{ROUGH}NOSE EBRU...

Ball nose endmill for semi-roughing, shank type, with screw clamp system

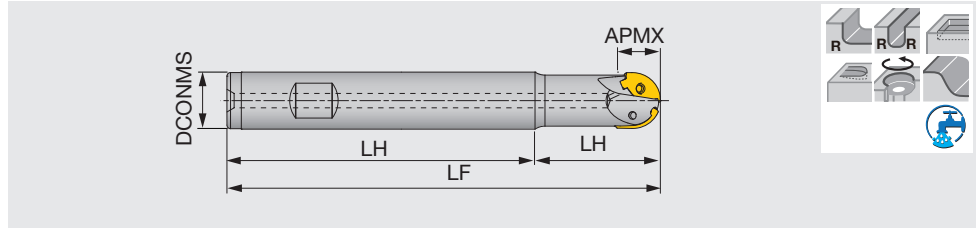

Inch	APMX	DC	CICT	DCONMS	LS	LF	LH	LB	BHTA	WT(lb)	Air hole	Insert
EBRU062SW062S0475	0.470	0.625	2	0.625	3.375	4.748	1.373	0.331	3.000	0.330	With	ZRBU062-MM
EBRU075SW075S0600	0.510	0.750	2	0.750	4.000	6.000	2.000	0.606	3.000	0.610	With	ZRBU075-MM
EBRU100SW100S0600	0.690	1.000	2	1.000	3.250	6.000	2.750	1.080	3.000	1.080	With	ZRBU100-MM

SPARE PARTS

Designation	Clamping screw	Wrench
EBRU062...	TS25064I	T-8D
EBRU075...	TS30C72I	T-9D
EBRU100...	TS35085I/HG	T-15D

*Recommended clamping torque : TS25064I = 0.96 lbs·ft, TS35085I/HG = 2.58 lbs·ft

BALL^{ROUGH}NOSE HBRM...

Ball nose endmill for semi-roughing, modular type, with screw clamp system (TungFlex)

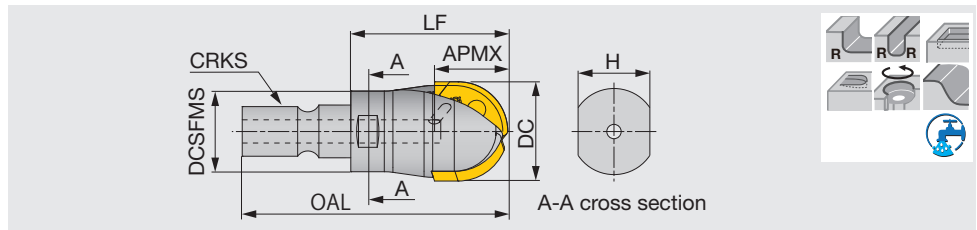

Metric	APMX	DC	CICT	OAL	LF	H	DCSFMS	CRKS	WT(kg)	Air hole	Insert
HBRM16M08	11.8	16	2	42.5	25	10	13	M8	0.025	With	ZRBM160...
HBRM20M10	13.6	20	2	50	30	15	18	M10	0.05	With	ZRBM200...
HBRM25M12	17.7	25	2	57	35	17	21	M12	0.08	With	ZRBM250...

SPARE PARTS

Designation	Clamping screw	Wrench
HBRM16...	TS25064I	T-8D
HBRM20...	TS30085I/HG	T-9D
HBRM25...	TS35085I/HG	T-15D

*Recommended clamping torque : TS25064I = 1.3 N·m, TS30085I/HG = 2.3 N·m, TS35085I/HG = 3.5 N·m

Reference pages: Inserts, Standard cutting conditions → **H165**

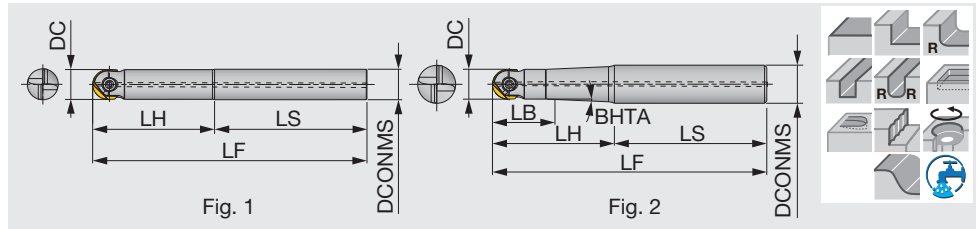

Inch	DC	DCONMS	LS	LH	LF	LB	BHTA	Air hole	Fig.	Shank material	Insert
EBFU037T050S0400	0.375	0.500	3.000	1.000	4.000	0.625	9.0°	With	2	Steel	ZF*U037
EBFU037S037C0550	0.375	0.375	2.500	3.000	5.500	-	-	Without	1	Carbide	ZF*U037
EBFU037T062S0600	0.375	0.625	3.500	2.500	6.000	0.625	3.5°	With	2	Steel	ZF*U037
EBFU037S037C0875	0.375	0.375	3.250	5.500	8.750	-	-	Without	1	Carbide	ZF*U037
EBFU050S050S0437	0.500	0.500	3.187	1.188	4.375	-	-	With	1	Steel	ZF*U050
EBFU050S050C0637	0.500	0.500	2.750	3.625	6.375	-	-	Without	1	Carbide	ZF*U050
EBFU050T062S0637	0.500	0.625	4.000	2.375	6.375	1.000	2.5°	With	2	Steel	ZF*U050
EBFU050S050C0875	0.500	0.500	2.750	6.000	8.750	-	-	Without	1	Carbide	ZF*U050
EBFU062T075S0500	0.625	0.750	3.000	2.000	5.000	0.563	2.0°	With	2	Steel	ZF*U062
EBFU062S062C0637	0.625	0.625	3.375	3.000	6.375	-	-	Without	1	Carbide	ZF*U062
EBFU062T075S0637	0.625	0.750	3.625	2.750	6.375	0.563	1.5°	With	2	Steel	ZF*U062
EBFU062S062C0875	0.625	0.625	2.750	6.000	8.750	-	-	Without	1	Carbide	ZF*U062
EBFU075T100S0700	0.750	1.000	4.000	3.000	7.000	1.563	4.5°	With	2	Steel	ZF*U075
EBFU075S075C0875	0.750	0.750	4.000	4.750	8.750	-	-	Without	1	Carbide	ZF*U075
EBFU075T100S0875	0.750	1.000	4.000	4.750	8.750	1.000	1.5°	With	2	Steel	ZF*U075
EBFU075S075C1200	0.750	0.750	3.250	8.750	12.000	-	-	Without	1	Carbide	ZF*U075
EBFU100T125S0800	1.000	1.250	4.000	4.000	8.000	1.250	2.5°	With	2	Steel	ZF*U100
EBFU100S100C0875	1.000	1.000	4.000	4.750	8.750	-	-	Without	1	Carbide	ZF*U100
EBFU100T125S1000	1.000	1.250	4.000	6.000	10.000	1.188	1.4°	With	2	Steel	ZF*U100
EBFU100S100C1200	1.000	1.000	3.250	8.750	12.000	-	-	Without	1	Carbide	ZF*U100
EBFU125S125S1000	1.250	1.250	6.000	4.000	10.000	-	-	With	1	Steel	ZF*U125
EBFU125S125C1200	1.250	1.250	3.250	8.750	12.000	-	-	Without	1	Carbide	ZF*U125

SPARE PARTS

Designation	Clamping screw	Torx bit	Grip	Wrench
EBFU037...	TS30F100A	-	-	T10D
EBFU050...	TS40F120A	-	-	T15D
EBFU062...	TS50F160A	-	-	T-T20
EBFU075...	TS60F200A	BLDT25/M7	SW6-T	-
EBFU100...	TS70F250A	BLDT25/M7	SW6-T	-
EBFU125...	TS70F300A	-	-	T-T30

*Recommended clamping torque : TS 30F100A = 1.84 lbs·ft, TS 40F120A = 2.58 lbs·ft, TS 50F160A = 3.69 lbs·ft, TS 60F200A = 5.16 lbs·ft, TS 70F250A = 5.16 lbs·ft

High precision finishing endmill, modular type, with screw clamp system (TungFlex)

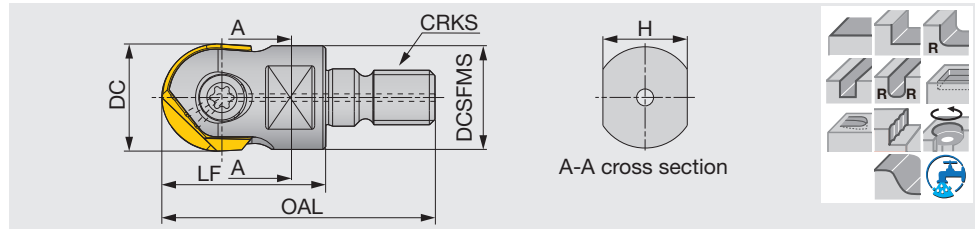

Metric	DC	OAL	LF	H	DCSFMS	CRKS	Air hole	Insert
HBFM10M06	10	34.5	20	7	9.7	M6	With	ZFBM100...
HBFM12M06	12	37.5	23	7	11.5	M6	With	ZF*M120...
HBFM12M08	12	40	23	10	13	M8	With	ZF*M120...
HBFM16M08	16	47	30	10	13	M8	With	ZF*M160...
HBFM20M10	20	49	30	15	19	M10	With	ZF*M200...
HBFM25M12	25	57	35	17	24	M12	With	ZFBM250...
HBFM30M16	30	66	43	22	29	M16	With	ZFBM300...
HBFM32M16	32	66	43	22	29.5	M16	With	ZFBM320...

SPARE PARTS



Designation	Clamping screw	Torx bit	Grip	Wrench
HBFM10...	TS 30F100A	-	-	T-10D
HBFM12...	TS 40F120A	-	-	T-15D
HBFM16...	TS 50F160A	BT20S	H-TB2W	-
HBFM20...	TS 60F200A	BLDT25/M7	H-TB2W	-
HBFM25...	TS 70F250A	BLDT25/M7	H-TB2W	-
HBFM30...	TS 80F300A	-	-	T-T30
HBFM32...	TS 80F300A	-	-	T-T30

*Recommended clamping torque : TS 25F080A = 1.3 N-m, TS 30F100A = 2.5 N-m, TS 40F120A = 3.5 N-m, TS 50F160A = 5 N-m, TS 60F200A = 7 N-m, TS 70F250A = 7 N-m, TS 80F300A = 10 N-m

TungFlex

TungFlex modular shank

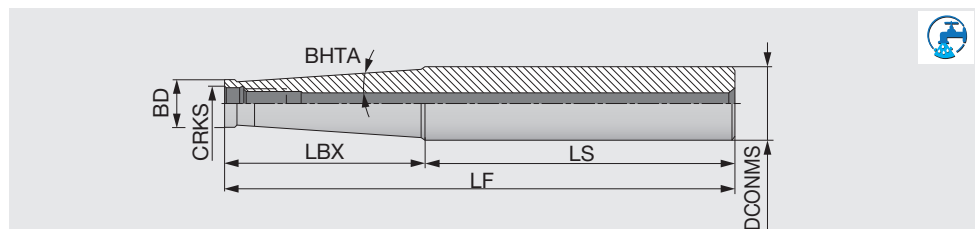

Metric	DCONMS	LF	LS	LBX	BD	CRKS	BHTA	Shank type
SM06-L60C10	10	60	40	20	9.7	M6	0°	Cylindrical
SM06-L105-C12	12	105	45	60	9.7	M6	1.2°	Cylindrical
SM06-L125-C16	16	125	65	60	9.7	M6	3.3°	Cylindrical
SM08-L73C16	16	73	48	25	13	M8	0°	Cylindrical
SM08-L128-C16	16	128	48	80	13	M8	0.9°	Cylindrical
SM08-L170-C20	20	170	103.2	66.8	13	M8	3.3°	Cylindrical
SM10-L80-C20	20	80	50	30	18	M10	0°	Cylindrical
SM10-L130-C20	20	130	50	80	18	M10	0.6°	Cylindrical
SM10-L200-C25	25	200	142.8	57.2	19	M10	3.3°	Cylindrical
SM12-L86-C25	25	86	56	30	21	M12	5.1°	Cylindrical
SM12-L200-C32	32	200	122	78	21	M12	4.4°	Cylindrical
SM16-L95-C32	32	95	60	35	29	M16	1.7°	Cylindrical
SM16-L230-C32	32	230	180	50	29	M16	1.8°	Cylindrical

Reference pages: Inserts → [H168 - H169](#), Standard cutting conditions → [H170](#)



INSERT

ZFBU-MJ / ZFBM-MJ

ZFBU-ML

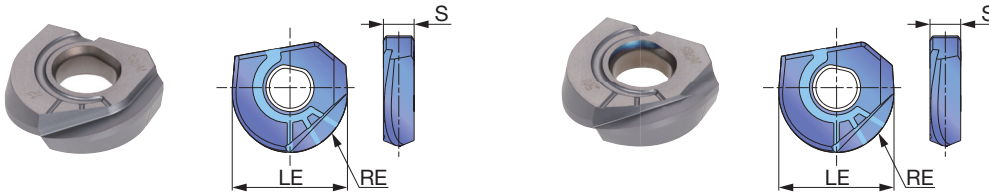

P	Steel	★																		
M	Stainless	☆																		
K	Cast iron	☆																		
N	Non-ferrous	☆																		
S	Superalloys	★																		
H	Hard materials	☆																		

★ : First choice
☆ : Second choice

Inch

Designation	RE	Coated										LE	S	
		AH725												
ZFBU037R00-MJ	0.188	●											0.375	0.114
ZFBU050R00-MJ	0.250	●											0.500	0.134
ZFBU062R00-MJ	0.313	●											0.625	0.173
ZFBU075R00-MJ	0.375	●											0.750	0.213
ZFBU062R00-MJ	0.313	●											0.625	0.173
ZFBU100R00-MJ	0.500	●											1.000	0.252
ZFBU075R00-MJ	0.375	●											0.750	0.213
ZFBU125R00-MJ	0.625	●											1.250	0.291
ZFBU037R00-ML	0.188	●											0.375	0.114
ZFBU050R00-ML	0.250	●											0.500	0.134
ZFBU062R00-ML	0.313	●											0.625	0.173
ZFBU075R00-ML	0.375	●											0.750	0.213
ZFBU100R00-ML	0.500	●											1.000	0.252
ZFBU125R00-ML	0.625	●											1.250	0.291

● : Line up

ZFBU037 / 050 / 062... : 5 piece per package
ZFBU075 / 100 / 125... : 1 piece per package

P	Steel	☆	★																	
M	Stainless		☆																	
K	Cast iron	★	☆																	
N	Non-ferrous		☆																	
S	Superalloys		★																	
H	Hard materials	★	☆																	

★ : First choice
☆ : Second choice

Metric

Designation	RE	Coated										LE	S	
		AH710	AH725											
ZFBM080R00-MJ	4	●	●										8	2.4
ZFBM100R00-MJ	5	●	●										10	2.9
ZFBM120R00-MJ	6	●	●										12	3.4
ZFBM160R00-MJ	8	●	●										16	4.4
ZFBM200R00-MJ	10	●	●										20	5.4
ZFBM250R00-MJ	12.5	●	●										25	6.4
ZFBM300R00-MJ	15	●	●										30	7.4
ZFBM320R00-MJ	16	●	●										32	7.4

● : Line up

ZFBM080 / 100 / 120 / 160... : 5 piece per package
ZFBM200 / 250 / 300 / 320... : 1 piece per package

Reference pages: Standard cutting conditions → **H170**, TungFlex → **H167**

INSERT

ZFRU-MJ / ZFRM-MJ (Corner radius type)

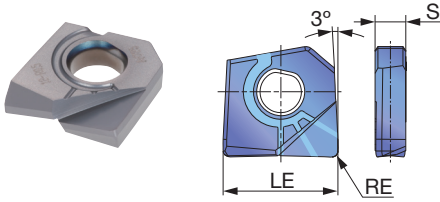

Inch	Material		★	☆	Coated	LE	S
	P	M					
	P	Steel	★				
	M	Stainless	☆				
	K	Cast iron	☆				
	N	Non-ferrous	☆				
	S	Superalloys	★				
	H	Hard materials	☆				

Designation	RE	Coated		LE	S
		AH725			
ZFRU037R003-MJ	0.031	●		0.375	0.114
ZFRU050R003-MJ	0.031	●		0.500	0.134
ZFRU050R006-MJ	0.062	●		0.500	0.134
ZFRU050R012-MJ	0.125	●		0.500	0.134
ZFRU062R003-MJ	0.031	●		0.625	0.173
ZFRU062R006-MJ	0.062	●		0.625	0.173
ZFRU062R012-MJ	0.125	●		0.625	0.173
ZFRU075R003-MJ	0.031	●		0.750	0.213
ZFRU075R006-MJ	0.062	●		0.750	0.213
ZFRU075R012-MJ	0.125	●		0.750	0.213
ZFRU100R003-MJ	0.031	●		1.000	0.252
ZFRU100R006-MJ	0.062	●		1.000	0.252
ZFRU100R012-MJ	0.125	●		1.000	0.252
ZFRU125R003-MJ	0.031	●		1.250	0.291
ZFRU125R006-MJ	0.062	●		1.250	0.291
ZFRU125R012-MJ	0.125	●		1.250	0.291

★ : First choice
☆ : Second choice

● : Line up

ZFRU037 / 050 / 062... : 5 piece per package
ZFRU075 / 100 / 125... : 1 piece per package

Metric	Material		★	☆	Coated	LE	S
	P	M					
	P	Steel	☆	★			
	M	Stainless		☆			
	K	Cast iron	★	☆			
	N	Non-ferrous		☆			
	S	Superalloys		★			
	H	Hard materials	★	☆			

Designation	RE	Coated		LE	S
		AH710	AH725		
ZFRM120R05-MJ	0.5	●	●	12	3.4
ZFRM120R10-MJ	1	●	●	12	3.4
ZFRM160R05-MJ	0.5	●	●	16	4.4
ZFRM160R10-MJ	1	●	●	16	4.4
ZFRM160R15-MJ	1.5	●	●	16	4.4
ZFRM200R10-MJ	1	●	●	20	5.4
ZFRM200R15-MJ	1.5	●	●	20	5.4

● : Line up

ZFRM120 / 160... : 5 piece per package
ZFRM200... : 1 piece per package

Reference pages: Standard cutting conditions → H170, TungFlex → H167

STANDARD CUTTING CONDITIONS

ISO	Workpiece materials	Hardness	Priority	Grades	Max. depth of cut (in)	Cutting speed Vc (sfm)	Feed per tooth: fz (ipt)							
							D0.315	D0.394	D0.490	D0.653	D0.816	D0.984	D1.181	D1.260
P	Low carbon steel, alloy steel	85 - 180 HB	First choice	AH725	≤0.04D	590 - 850	0.006	0.008	0.008	0.010	0.010	0.012	0.014	0.014
		85 - 180 HB	Wear resistance	AH710	≤0.04D	590 - 850	0.006	0.008	0.008	0.010	0.010	0.012	0.014	0.014
	High carbon steel, alloy steel	180 - 280 HB	First choice	AH725	≤0.03D	490 - 750	0.006	0.008	0.008	0.010	0.010	0.012	0.014	0.014
		180 - 280 HB	Wear resistance	AH710	≤0.03D	490 - 750	0.006	0.008	0.008	0.010	0.010	0.012	0.014	0.014
	Prehardened steel Die & mold tool steel	40 - 48 HRC	First choice	AH710	≤0.03D	590 - 980	0.006	0.006	0.008	0.008	0.010	0.010	0.012	0.012
		40 - 48 HRC	Fracture resistance	AH725	≤0.03D	590 - 980	0.006	0.006	0.008	0.008	0.010	0.010	0.012	0.012
M	Stainless steel	135 - 200 HB	First choice	AH725	≤0.03D	330 - 820	0.004	0.006	0.008	0.008	0.010	0.010	0.012	0.012
K	Cast iron	150 - 240 HB	First choice	AH710	≤0.04D	300 - 1150	0.008	0.008	0.010	0.012	0.012	0.014	0.016	0.016
		150 - 240 HB	Fracture resistance	AH725	≤0.04D	300 - 1150	0.008	0.008	0.010	0.012	0.012	0.014	0.016	0.016
N	Aluminum	-	First choice	AH725	≤0.03D	660 - 1310	0.010	0.010	0.014	0.014	0.014	0.016	0.016	0.018
S	Titanium alloy	-	First choice	AH725	≤ 0.03D	98 - 262	0.003	0.003	0.004	0.005	0.006	0.007	0.008	0.008
	Heat-resistant alloys	-	First choice	AH725	≤ 0.03D	98 - 328	0.003	0.003	0.004	0.005	0.006	0.007	0.008	0.008
H	High hardened steel	48 - 65 HRC	First choice	AH710	≤0.02D	330 - 720	0.003	0.003	0.004	0.005	0.006	0.008	0.008	0.010

· Remove excessive chip accumulation with an air blast.
 · For the operation with depth of cut which varies (ex.casting skin) and machining of workpiece materials with interrupted surface, the feed per tooth (fz) should be set to the lower recommended value shown in the above table.

· Cutting conditions may be limited depending on machine power, workpiece rigidity, and spindle output. When the cutting width, depth, or overhang length is large, set Vc and fz to the lower recommended values and check the machine power and vibration.

How to clamp the insert

1. Clear chips and dust from the pocket.
2. Place the insert in the pocket. The insert can be placed only in one direction.
3. Tighten the screw while pressing the insert into the pocket.

How to check the run-out

1. Clamp the insert on the shank.
2. Clamp the shank on a high-precision arbor.
3. Measure the run-out on tool presetter or by dial gauge.

Notes:

1. Due to the helical cutting edge, it is important that the run-out is inspected with the insert clamped on the shank.
2. Do not use micrometer or caliper to inspect the insert diameter as inaccurate dimensions may be provided.

Small-radius finishing endmill, modular type (TungFlex)

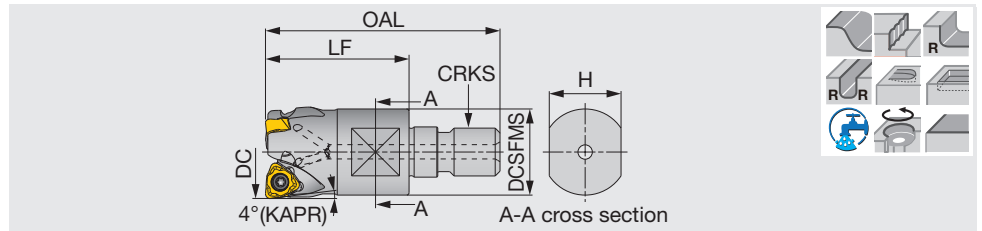

Metric	DC	CICT	OAL	LF	H	DCSFMS	CRKS	WT(kg)	Air hole	Insert
HFWX04M016M08R02	16	2	42	25	10	13	M8	0.03	With	WXHU04...
HFWX04M020M10R03	20	3	49	30	15	18	M10	0.05	With	WXHU04...
HFWX04M025M12R04	25	4	52	30	17	21	M12	0.09	With	WXHU04...

See page **H167** for TungFlex modular shank.

SPARE PARTS

Designation	Clamping screw	Lubricant	Wrench
HFWX04M...	SR34-514	M-1000	T-7F

*Recommended clamping torque : SR34-514 = 0.9 N·m

INSERT

WXHU-MJ

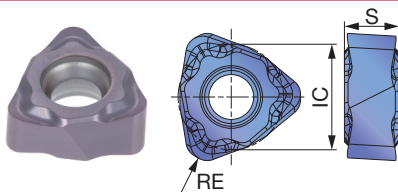

P Steel	★	
M Stainless		
K Cast iron		
N Non-ferrous		
S Superalloys		
H Hard materials	★	

★ : First choice
☆ : Second choice

Designation	RE	APMX	Coated		IC	S
			AH110			
WXHU040305R-MJ	0.020	0.020	●		0.250	0.125
WXHU040310R-MJ	0.039	0.039	●		0.250	0.125

* For plunging, the maximum cutting width is 0.079".

● : Line up

STANDARD CUTTING CONDITIONS

ISO	Workpiece material	Hardness	Grade	Cutting speed Vc (sfm)	Feed per tooth fz (ipt)
P	High carbon steel 1045, 1055, etc.	200 - 300 HB	AH110	328 - 984	0.004 - 0.012
	Alloy steel 4140, etc.	150 - 300 HB	AH110	328 - 984	0.004 - 0.012
	Prehardened steel NAK80, PX5, etc.	30 - 40 HRC	AH110	328 - 984	0.002 - 0.012
H	Hardened steel	H13, etc.	AH110	262 - 427	0.004 - 0.012
		D2, etc.	AH110	164 - 328	0.002 - 0.006

Reference pages: TungFlex → **H167**



FIXRMILL

TRP12/16

Radius mill with anti-rotation system

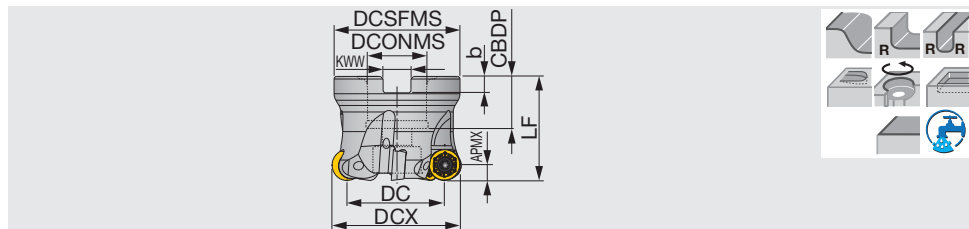

Inch	APMX	DCX	DC	CICT	DCSFMS	DCONMS	CBDP	LF	b	KWW	WT(lb)	Air hole	Insert
TRP12R200U0075A05	0.236	2.000	1.528	5	1.850	0.750	0.750	1.575	0.197	0.315	0.66	With	RPMT1204EN-M*
TRP12R250U0100A06	0.236	2.500	2.028	6	2.323	1.000	1.024	1.969	0.236	0.374	1.32	With	RPMT1204EN-M*
TRP16R250U0100A05	0.315	2.500	1.869	5	2.323	1.000	1.024	1.969	0.236	0.374	1.32	With	RPMT1606EN-M*

SPARE PARTS

Designation	Clamping screw	Grip	Lubricant	Shell locking bolt (Optional parts)	Torx bit
TRP12R200U0075A05	CSTR-4L100	H-TBS	M-1000	(C0.375X1.125H)	BT15S
TRP12R250U0100A06	CSTR-4L100	H-TBS	M-1000	(C0.500X1.375H)	BT15S
TRP16R250U0100A05	CSPB-5	H-TBS	M-1000	(C0.500X1.375H)	BLDIP20/S7

*Recommended clamping torque : CSTR-4L100 = 2.58 lbs·ft, CSPB-5 = 3.69 lbs·ft

FIXRMILL

ERP10/12/16

Radius endmill with anti-rotation system, shank type

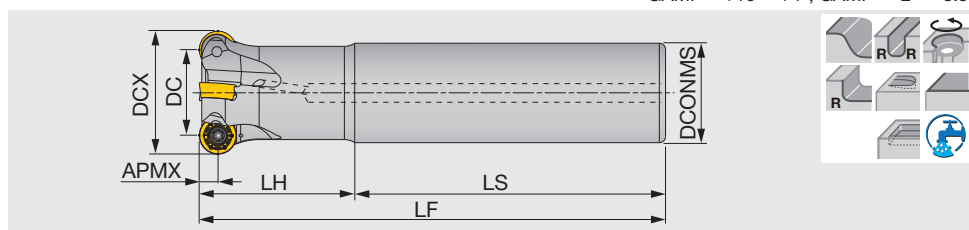

Inch	APMX	DCX	DC	CICT	DCONMS	LS	LH	LF	Air hole	Insert
ERP10R100U0100-02	0.197	1.000	0.606	2	1.000	4.000	2.000	6.000	With	RPMT10T3EN-M*
ERP10R125U0125-04	0.197	1.250	0.856	4	1.250	4.000	2.000	6.000	With	RPMT10T3EN-M*
ERP10R150U0125-04	0.197	1.500	1.106	4	1.250	4.000	2.000	6.000	With	RPMT10T3EN-M*
ERP12R125U0125-03	0.236	1.250	0.776	3	1.250	4.000	2.000	6.000	With	RPMT1204EN-M*
ERP12R150U0125-04	0.236	1.500	1.034	4	1.250	4.000	2.000	6.000	With	RPMT1204EN-M*
ERP16R150U0125-02	0.315	1.500	0.866	2	1.250	4.000	2.000	6.000	With	RPMT1606EN-M*

SPARE PARTS

Designation	Clamping screw	Lubricant	Wrench
ERP10R...	CSPB-3.5S	M-1000	IP-15D
ERP12R...	CSTR-4L100	M-1000	T-15DB
ERP16R...	CSPB-5	M-1000	IP-20D

*Recommended clamping torque : CSPB-3.5S/CSTR-4L100 = 2.58 lbs·ft, CSPB-5 = 3.69 lbf·ft

Reference pages: Inserts → [H173](#), Standard cutting conditions → [H174 - H175](#)

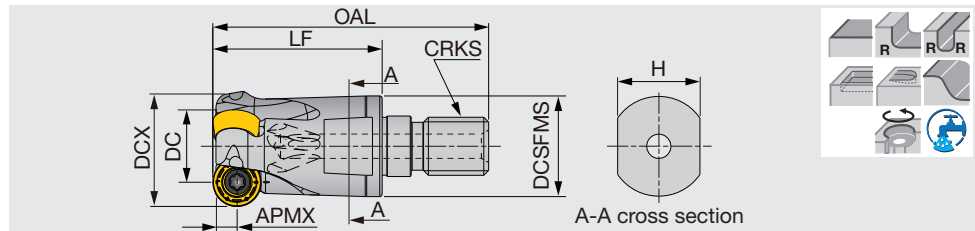

Metric	APMX	DCX	DC	CICT	OAL	LF	H	DCSFMS	CRKS	WT(kg)	Air hole	Insert
HRP10R020MM10-02	5	20	10	2	49	30	15	17.8	M10	0.1	With	RPMT10T3...
HRP10R025MM12-02	5	25	15	2	57	35	17	20.8	M12	0.1	With	RPMT10T3...
HRP10R032MM16-04	5	32	22	4	63	40	22	28.8	M16	0.2	With	RPMT10T3...
HRP12R032MM16-03	6	32	20	3	63	40	22	28.8	M16	0.2	With	RPMT1204...

See page H167 for TungFlex modular shank.

SPARE PARTS

Designation	Clamping screw	Lubricant	Wrench	
			Bit	Grip
HRP10R**	CSPB-3.5S	M-1000	BLD IP15/S7	H-TBS
HRP12R**	CSTR-4L100	M-1000	BT15S	H-TBS

*Recommended clamping torque : CSPB-3.5S/CSTR-4L100 = 3.5 N·m

INSERT

RPMT-MJ

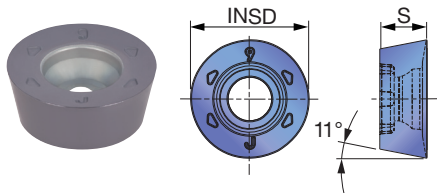

RPMT-ML

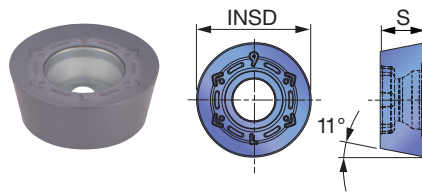

	P	M	K	N	S	H
Steel	●					
Stainless		★	☆	★		
Cast iron			☆			
Non-ferrous				●		
Superalloys		☆	★			
Hard materials						

★ : First choice
☆ : Second choice

Designation	APMX	Coated			INSD	S
		AH130	AH725	AH4035		
RPMT10T3EN-MJ	0.197	●	●	●	0.394	0.156
RPMT10T3EN-ML	0.197	●	●	●	0.394	0.156
RPMT1204EN-MJ	0.236	●	●	●	0.472	0.187
RPMT1204EN-ML	0.236	●	●	●	0.472	0.187
RPMT1606EN-MJ	0.315	●	●	●	0.630	0.250
RPMT1606EN-ML	0.315	●	●	●	0.630	0.250

● : Line up



STANDARD CUTTING CONDITIONS



ISO	Workpiece material	Hardness	Priority	Grade	Chip-breaker	Cutting speed Vc (sfm)	Feed per tooth fz (ipt)	
P	Carbon steels 1045, 1055, etc.	< 300 HB	First choice	AH725	MJ	400 - 830	0.012 - 0.028	
		< 300 HB	Fracture resistance	AH130	MJ	400 - 830	0.012 - 0.028	
	Alloy steels 4140 (H), etc.	150 - 300 HB	First choice	AH725	MJ	330 - 830	0.008 - 0.024	
		150 - 300 HB	Fracture resistance	AH130	MJ	330 - 830	0.008 - 0.024	
	Tool steels W1-10, M2, etc.	< 300 HB	-	AH725	ML	260 - 590	0.008 - 0.016	
	M	Stainless steels 304, 316, etc.	< 200 HB	First choice	AH130	ML	330 - 830	0.008 - 0.024
< 200 HB			Fracture resistance	AH130	MJ	330 - 830	0.008 - 0.024	
Stainless steels 420, 430, etc.		< 200 HB	First choice	AH4035	ML	330 - 1000	0.008 - 0.024	
		< 200 HB	Fracture resistance	AH4035	MJ	330 - 1000	0.008 - 0.024	
K		Gray cast irons No25, No30, etc.	150 - 250 HB	-	AH725	ML	400 - 830	0.012 - 0.028
		Ductile cast irons 60-40-18, etc.	150 - 250 HB	-	AH725	ML	330 - 660	0.012 - 0.028
H	Hardened steels H3, etc.	40 - 50 HRC	-	AH725	MJ	200 - 460	0.004 - 0.012	
	Hardened steels D2, etc.	50 - 60 HRC	-	AH725	MJ	70 - 200	0.002 - 0.008	

- Use air blast to remove chips from the work area in slot milling or pocketing operation.
- When machining at high cutting speeds of more than $V_c = 3281$ sfm, the dynamic balance of the tools must be adjusted.

- Cutting conditions are limited by machine power, workpiece rigidity and spindle output. When the cutting width or depth is large, set V_c and f_z to the lower recommended values and check the machine power and vibration.

Tool dia.: DCX (in), Number of revolutions: n (rpm), Feed speed: V_f (ipm), Depth of cut: $a_p = 0.078''$

ø1.000		ø1.250			ø1.500			ø2.000		ø2.500		
n	V_f	n	V_f		n	V_f		n	V_f	n	V_f	
			ERP10	ERP12		ERP10/12	ERP16				TRP12	TRP16
2250	90	1790	143	110	1430	120	60	1150	110	910	110	90
$V_c = 590 \text{ sfm}, f_z = 0.020 \text{ ipt}$												
2250	90	1790	143	110	1430	120	60	1150	110	910	110	90
$V_c = 590 \text{ sfm}, f_z = 0.020 \text{ ipt}$												
2140	68	1690	108	80	1350	90	45	1080	85	860	80	70
$V_c = 560 \text{ sfm}, f_z = 0.016 \text{ ipt}$												
2140	51	1690	81	60	1350	90	45	1080	85	860	80	470
$V_c = 560 \text{ sfm}, f_z = 0.012 \text{ ipt}$												
1600	38	1290	62	45	1030	50	25	830	50	660	45	40
$V_c = 420 \text{ sfm}, f_z = 0.016 \text{ ipt}$												
2140	68	1690	108	80	1350	90	45	1080	52	860	80	70
$V_c = 560 \text{ sfm}, f_z = 0.016 \text{ ipt}$												
2140	68	1690	108	80	1350	90	45	1080	52	860	80	70
$V_c = 560 \text{ sfm}, f_z = 0.016 \text{ ipt}$												
2520	81	1990	127	95	1590	110	55	1270	100	1010	95	80
$V_c = 660 \text{ sfm}, f_z = 0.016 \text{ ipt}$												
2520	81	1990	127	95	1590	110	55	1270	100	1010	95	80
$V_c = 660 \text{ sfm}, f_z = 0.016 \text{ ipt}$												
2250	90	1790	143	110	1430	120	60	1150	110	910	110	90
$V_c = 590 \text{ sfm}, f_z = 0.020 \text{ ipt}$												
1910	76	1490	119	90	1190	100	50	950	90	760	90	75
$V_c = 500 \text{ sfm}, f_z = 0.020 \text{ ipt}$												
1260	20	990	32	25	800	25	15	640	25	510	25	20
$V_c = 330 \text{ sfm}, f_z = 0.008 \text{ ipt}$												
530	5	400	8	6	320	10	5	250	10	200	10	8
$V_c = 140 \text{ sfm}, f_z = 0.005 \text{ ipt}$												

■ Caution for insert clamping

When clamping an insert, please carefully locate it in the seat, fasten the screw, and make sure there is no gap between it and the body.

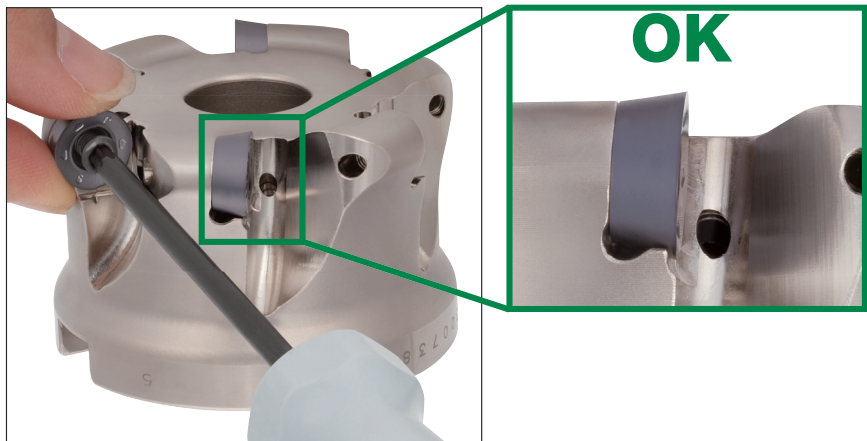
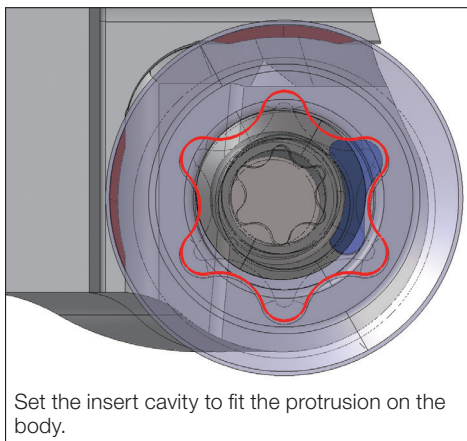

Grade
Insert
Ext. Toolholder
Int. Toolholder
Threading
Grooving
Miniature Tool
Milling Cutter
Endmill
Drilling Tool
User's Guide Tooling System
Index

A
B
C
D
E
F
G
H
I
J
K
L
M

APPLICATION RANGE

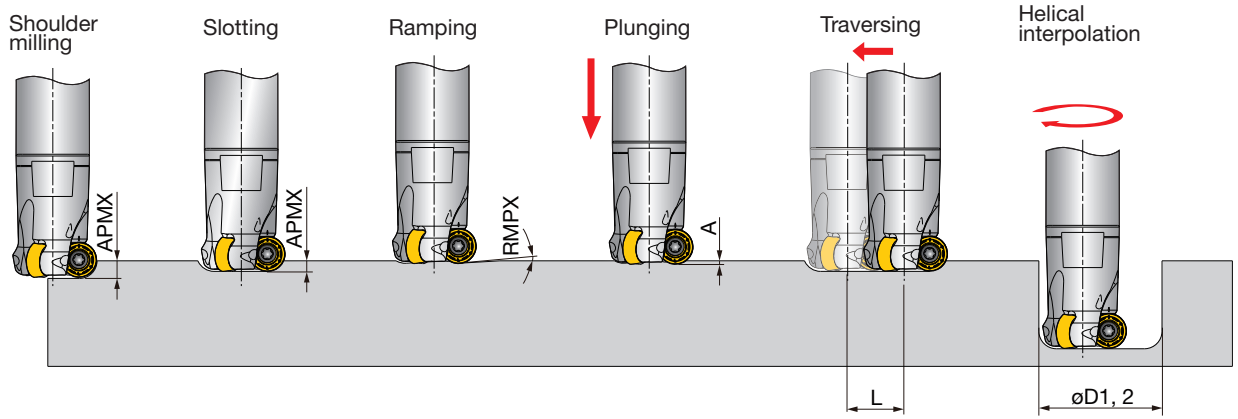

	Inch	Tool-ø DCX	Max. depth of cut APMX	Max. ramping angle RMPX	Max. plunging depth A	Machining length for removing uncut portion L	Min.machining øD1	*Max. machining øD2
High Feed Milling								
Face Milling								
Shoulder Milling								
Slot Milling								
Profile Milling								
Thread Milling								
Other								
	ERP10R100U0100-02	1.000	0.197	3	0.0276	0.630	1.457	1.969
	ERP10R125U0125-04	1.250	0.197	8	0.0984	0.866	1.811	2.441
	ERP10R150U0125-04	1.500	0.197	6	0.0984	1.142	2.283	2.953
	ERP12R125U0125-03	1.250	0.236	8.3	0.0906	0.787	1.693	2.441
	ERP12R150U0125-04	1.500	0.236	4	0.0630	1.063	2.244	2.953
	ERP16R150U0125-02	1.500	0.315	6	0.0709	0.906	2.008	2.953
	TRP12R200U0075A05	2.000	0.236	4	0.0984	1.575	3.189	3.937
	TRP12R250U0100A06	2.500	0.236	2.7	0.0906	2.047	4.213	4.921
	TRP16R250U0100A05	2.500	0.315	3	0.0906	1.890	3.976	4.921

*For flat bottom hole

ROUNDSPPLIT

TRC12/16

Face mill, for round inserts with 0.236" (6 mm) or 0.315" (8 mm) radius

GAMP = +0°, GAMF = -1° ~ -5°

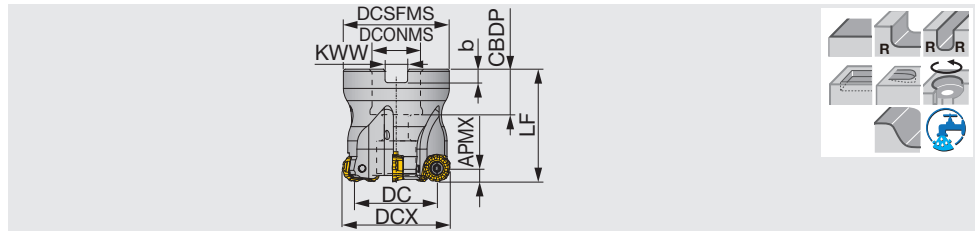

Inch	APMX	DCX	DC	CICT	DCSFMS	LF	DCONMS	CBDP	KWW	b	WT(lb)	Air hole	Insert	Arbor type
TRC12R200U0075A05	0.236	2.000	1.528	5	1.850	2.000	0.750	0.750	0.320	0.200	0.880	With	RCMT1204...	A
TRC12R250U0075A06	0.236	2.500	2.028	6	2.320	2.000	0.750	0.750	0.320	0.200	1.540	With	RCMT1204...	A
TRC12R300U0100A07	0.315	3.000	2.528	7	2.830	2.500	1.000	1.020	0.370	0.240	2.860	With	RCMT1204...	A
TRC16R200U0075A04	0.315	2.000	1.370	4	1.850	2.000	0.750	0.750	0.320	0.200	0.880	With	RCMT1204...	A
TRC16R250U0075A05	0.315	2.500	1.870	5	2.320	2.000	0.750	0.750	0.320	0.200	1.540	With	RCMT1204...	A
TRC16R300U0100A06	0.315	3.000	2.370	6	2.830	2.500	1.000	1.020	0.370	0.240	2.860	With	RCMT1204...	A
TRC16R400U0150A07	0.315	4.000	3.370	7	3.820	2.500	1.500	1.460	0.620	0.390	3.520	With	RCMT1204...	B
TRC16R500U0150A08	0.315	5.000	4.370	8	3.780	2.500	1.500	1.460	0.620	0.390	7.930	With	RCMT1204...	B

SPARE PARTS



Designation	Clamping screw	Grip	Shell locking bolt (Optional parts)	Torx bit
TRC12R...	CSTB-4L090	H-TBS	(C0.375X1.125H)	BT15S
TRC16R200..., 250...	CSTB-5L120	H-TB	(C0.375X1.125H)	BT20S
TRC16R300...	CSTB-5L120	H-TB	(C0.500X1.375H)	BT20M
TRC16R400..., 500...	CSTB-5L120	H-TB	(TMBA-0.750H)	BT20M

*Recommended clamping torque: CSTB-4L090 = 2.58 lbs·ft, CSTB-5L120 = 3.69 lbs·ft

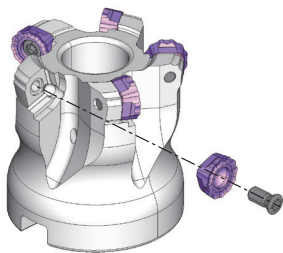

Arbor type

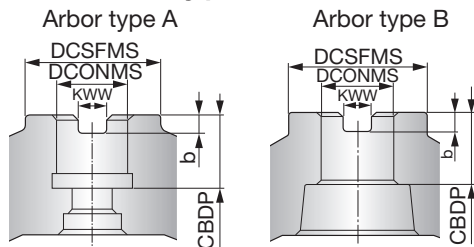

Reference pages: Inserts → **H179**, Standard cutting conditions → **H180**

Grade
Insert
Toolholder
Ext. Toolholder
Int. Toolholder
Threading
Grooving
Miniature Tool
Endmill
Drilling Tool
Tooling System
User's Guide
Index



ROUNDSPPLIT ERC12/16

Endmill, shank type, for round inserts with 0.236" (6 mm) or 0.315" (8 mm) radius

GAMP = +0°, GAMF = -1° ~ -5°

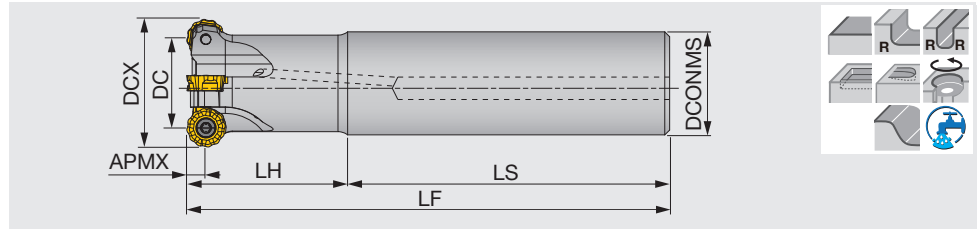

Inch	APMX	DCX	DC	CICT	DCONMS	LF	LH	LS	WT(lb)	Air hole	Insert
ERC12R125U0125-03L	0.236	1.250	0.778	3	1.250	6.000	2.250	3.750	2.050	With	RCMT1204*N-***
ERC12R125U0125-03LL	0.236	1.250	0.778	3	1.250	12.000	7.000	5.000	3.370	With	RCMT1204*N-***
ERC12R125U0125-03LM	0.236	1.250	0.778	3	1.250	8.000	4.000	4.000	2.250	With	RCMT1204*N-***
ERC12R125U0125W03	0.236	1.250	0.778	3	1.250	5.000	2.750	2.250	1.320	With	RCMT1204*N-***
ERC12R125U150-03LL	0.236	1.250	0.778	3	1.500	12.000	7.000	5.000	4.190	With	RCMT1204*N-***
ERC12R150U0125-04LM	0.236	1.500	1.028	4	1.250	8.000	4.000	4.000	2.360	With	RCMT1204*N-***
ERC12R150U0125-04LX	0.236	1.500	1.028	4	1.250	12.000	7.000	5.000	3.550	With	RCMT1204*N-***
ERC12R150U0125W04	0.236	1.500	1.028	4	1.250	5.000	2.340	2.660	1.430	With	RCMT1204*N-***
ERC12R150U0150-04L	0.236	1.500	1.028	4	1.500	6.000	2.000	3.750	2.420	With	RCMT1204*N-***
ERC12R150U0150-04LM	0.236	1.500	1.028	4	1.500	8.000	4.000	4.000	3.080	With	RCMT1204*N-***
ERC12R150U0150-04LX	0.236	1.500	1.028	4	1.500	12.000	7.000	5.000	4.410	With	RCMT1204*N-***
ERC12R150U0150W04	0.236	1.500	1.028	4	1.500	5.000	2.340	2.660	1.830	With	RCMT1204*N-***
ERC12R150U150-04LL	0.236	1.500	1.028	4	1.500	12.000	2.000	10.000	5.290	With	RCMT1204*N-***
ERC16R150U0125-02LL	0.315	1.500	0.870	2	1.250	12.000	2.000	10.000	3.810	Without	RCMT1606*N-***
ERC16R150U0125-02LM	0.315	1.500	0.870	2	1.250	8.000	2.000	6.000	2.470	With	RCMT1606*N-***
ERC16R150U0125W02	0.315	1.500	0.870	2	1.250	5.000	2.340	2.660	1.430	With	RCMT1606*N-***
ERC16R150U0150-02L	0.315	1.500	0.870	2	1.500	6.000	2.000	4.000	2.380	With	RCMT1606*N-***
ERC16R150U0150-02LM	0.315	1.500	0.870	2	1.500	8.000	4.000	4.000	3.080	With	RCMT1606*N-***
ERC16R150U0150-02LX	0.315	1.500	0.870	2	1.500	12.000	7.000	5.000	4.620	Without	RCMT1606*N-***
ERC16R150U0150W02	0.315	1.500	0.870	2	1.500	5.000	2.340	2.660	1.830	With	RCMT1606*N-***
ERC16R150U150-02LL	0.315	1.500	0.870	2	1.500	12.000	2.000	10.000	5.290	Without	RCMT1606*N-***

SPARE PARTS



Designation	Clamping screw	Wewnch
ERC12R...	CSTB-4L090	T-15DB
ERC16R040...	CSTB-5L105	T-20DB
ERC16R050...	CSTB-5L120	T-20DB

*Recommended clamping torque : CSTB-4L090 = 2.58 lbs·ft, CSTB-5L105 = 3.69 lbs·ft, CSTB-5L120 = 3.69 lbs·ft

Reference pages: Inserts → [H179](#), Standard cutting conditions → [H180](#)

INSERT

RCMT-MJ

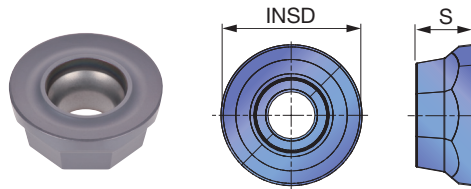

RCMT-NMJ

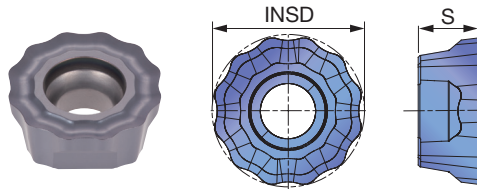

RCMT-NAJ

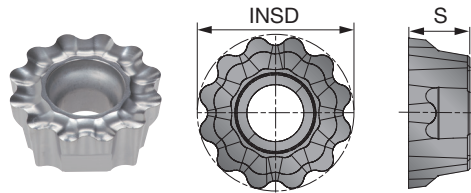

P Steel	☆	★							
M Stainless		★	☆						
K Cast iron	★		☆						
N Non-ferrous				★					
S Superalloys	★		★						
H Hard materials									

★ : First choice
☆ : Second choice

Designation	APMX	Coated			Uncoated	INSD	S
		AH120	AH140	AH725	KS15F		
RCMT1204EN-MJ	0.236	●	●	●		0.472	0.189
RCMT1204EN-NMJ	0.236	●	●	●		0.472	0.189
RCMT1204FN-NAJ	0.236				●	0.472	0.189
RCMT1606EN-MJ	0.315	●	●	●		0.630	0.256
RCMT1606EN-NMJ	0.315	●	●	●		0.630	0.256
RCMT1606FN-NAJ	0.315				●	0.630	0.256

● : Line up

Grade
Insert
Ext. Toolholder
Int. Toolholder
Threading
Grooving
Miniature Tool
Milling Cutter
Endmill
Drilling Tool
User's Guide Tooling System
Index



STANDARD CUTTING CONDITIONS



ISO	Workpiece material	Hardness HB	Grade	Cutting speed Vc (sfm)	Feed per tooth: fz (ipt) each chipbreaker		
					MJ	NMJ	NAJ
P	Low carbon steels 1010, 1015, etc.	~ 200	AH725	330 - 720	0.008 - 0.028	0.007 - 0.012	-
	High carbon steels 1045, 1055, etc.	200 ~ 300	AH725	330 - 660	0.008 - 0.028	0.007 - 0.010	-
	Alloyed steels 4140, 5120, etc.	150 ~ 300	AH725	330 - 660	0.008 - 0.028	0.007 - 0.010	-
	Tool steels D3, etc.	~ 300	AH725	330 - 590	0.008 - 0.028	0.007 - 0.010	-
M	Stainless steels 304, 316, etc.	-	AH140	300 - 590	0.008 - 0.024	0.006 - 0.010	-
K	Gray cast irons No.250B, etc.	150 ~ 250	AH120	460 - 820	0.008 - 0.028	0.007 - 0.012	-
	Ductile cast irons 60-40-18, etc.	150 ~ 250	AH120	460 - 820	0.008 - 0.028	0.007 - 0.012	-
N	Aluminum alloys Si < 13%	-	KS15F	1640 - 3940	-	-	0.004 - 0.012
	Aluminum alloys Si ≥ 13%	-	KS15F	330 - 980	-	-	0.004 - 0.012
S	Heat-resistant alloy Inconel 718, Ti-6Al-4V, etc.	-	AH725	70 - 160	0.008 - 0.024	0.006 - 0.010	-

- To remove excessive chip accumulation use an air blast.
 - When chips stick to the cutting edges (aluminum machining), use a water soluble cutting fluid.
 - Cutting conditions are limited by machine power and material rigidity.
- When the cutting width or depth is large, set Vc and fz below the recommended values and check the machine vibration and spindle load.

Holemaking with helical feed

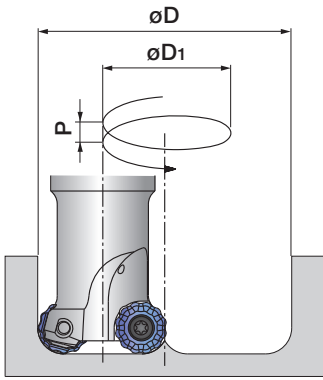

Inch	Tool ø DCX (in)	Min. machining diameter (in)		Max. machining diameter (in)		Pitch P (in)
		øD	øD1	øD	øD1	
ERC12R125U...	1.250	2.028	0.778	2.421	1.171	< 0.236
ERC12R150U...	1.500	2.528	1.028	2.921	1.421	< 0.236
TRC12R200U...	2.000	3.528	1.528	3.921	1.921	< 0.236
TRC12R250U...	2.500	4.528	2.028	4.921	2.421	< 0.236
TRC12R300U...	3.000	5.528	2.528	5.921	2.921	< 0.236
ERC16R150U...	1.500	2.370	0.870	2.921	1.421	< 0.315
TRC16R200U...	2.000	3.370	1.370	3.921	1.921	< 0.315
TRC16R250U...	2.500	4.370	1.870	4.921	2.421	< 0.315
TRC16R300U...	3.000	5.370	2.370	5.921	2.921	< 0.315
TRC16R400U...	4.000	7.370	3.370	7.921	3.921	< 0.315
TRC16R500U...	5.000	9.370	4.370	9.921	4.921	< 0.315

When holemaking with a helical feed, the pitch (P) needs to be set at lower values than that shown above.

Ramping

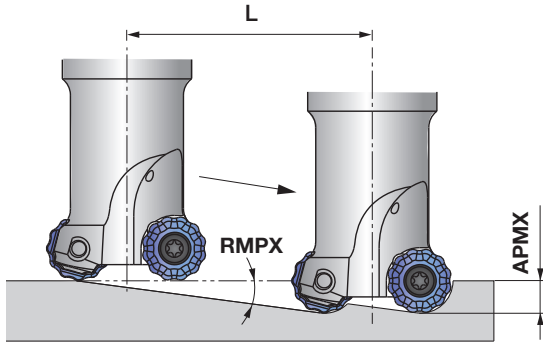

Inch	Tool ø DCX (in)	Max. ramping angle RMPX	L: tool pass length when ramping angle is 2° APMX (in)				
			0.079	0.118	0.158	0.236	0.315
ERC12R125U...	1.250	10°	2.244	3.346	4.488	6.732	-
ERC12R150U...	1.500	7°	2.244	3.346	4.488	6.732	-
TRC12R200U...	2.000	5.5°	2.244	3.346	4.488	6.732	-
TRC12R250U...	2.500	3.5°	2.244	3.346	4.488	6.732	-
TRC12R300U...	3.000	2.5°	2.244	3.346	4.488	6.732	-
ERC16R150U...	1.500	16°	2.244	3.346	4.488	6.732	-
TRC16R200U...	2.000	9.5°	2.244	3.346	4.488	6.732	9.016
TRC16R250U...	2.500	6.5°	2.244	3.346	4.488	6.732	9.016
TRC16R300U...	3.000	4.5°	2.244	3.346	4.488	6.732	9.016
TRC16R400U...	4.000	3°	2.244	3.346	4.488	6.732	9.016
TRC16R500U...	5.000	2.5°	2.244	3.346	4.488	6.732	9.016

Tool pass length: $L = ap / \tan RMPX$, Ramping angle needs to be set at smaller than 2 degrees in order to prevent chips from getting tangled.

EWD05/07/10

Endmill, shank type, for round inserts with 0.098", 0.138", and 0.196" (2.5, 3.5, and 5 mm) radius

GAMP = 0°, GAMF = -3° ~ +0.5°

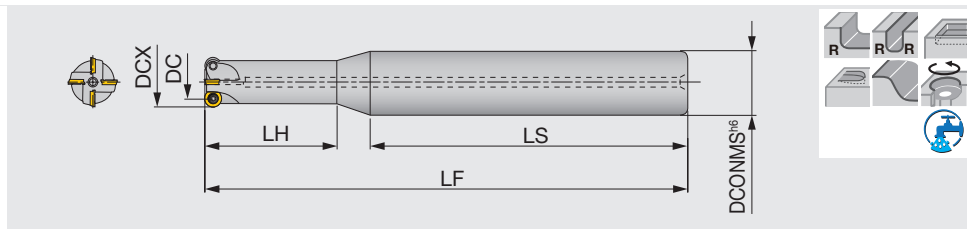

Inch	APMX	DCX	DC	CICT	DCONMS	LS	LH	LF	Air hole	Insert
EWD05050RU	0.098	0.500	0.304	2	0.750	3.250	0.750	5.000	With	RDMW0501M0
EWD05075RU	0.098	0.750	0.554	3	1.000	5.000	1.500	7.000	With	RDMW0501M0
EWD07075RU	0.138	0.750	0.475	4	1.000	5.000	1.500	7.000	With	RDMW0702M0
EWD07100RU	0.138	1.000	0.725	5	1.250	5.250	1.750	8.000	With	RDMW0702M0
EWD07125RU	0.138	1.250	0.975	3	1.500	5.500	1.750	9.000	With	RDMW0702M0
EWD10100RU	0.196	1.000	0.606	3	1.250	5.250	1.750	8.000	With	RDMW1003M0
EWD10125RU	0.196	1.250	0.856	5	1.500	5.500	1.750	9.000	With	RDMW1003M0

SPARE PARTS

Designation	Clamping screw	Wrench
EWD05050RU	CSTD-1.8	T-6D
EWD05075RU	CSTD-1.8	T-6D
EWD07075RU	CSTB-2.5S	T-8D
EWD07100RU	CSTB-2.5S	T-8D
EWD07125RU	CSTB-2.5S	T-8D
EWD10100RU	CSTB-3.5H	T-15D
EWD10125RU	CSTB-3.5H	T-15D

*Recommended clamping torque : CSTD-1.8 = 0.52 lbs·ft, CSTB-2.5S = 0.74 lbs·ft, CSTB-3.5H = 2.58 lbs·ft

HWD07-M

Endmill, modular type, for round inserts with 3.5 mm radius (TungFlex)

GAMP = 0°, GAMF = -3° ~ +0.5°

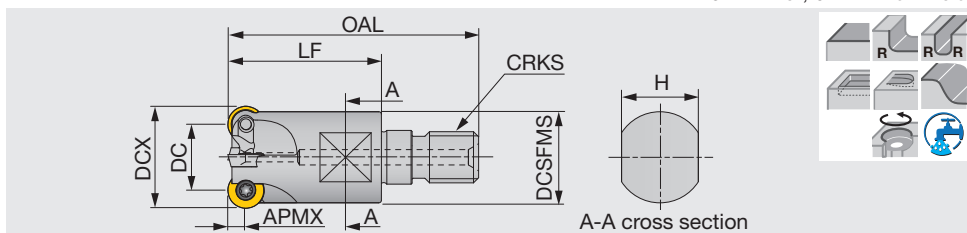

Metric	APMX	DCX	DC	CICT	OAL	LF	H	DCSFMS	CRKS	WT(kg)	Air hole
HWD07R015MM08-03	3.5	15	8	3	42	25	10	12.8	M8	0.03	With
HWD07R020MM10-04	3.5	20	13	4	49	30	15	17.8	M10	0.06	With
HWD07R025MM12-05	3.5	25	18	5	57	35	17	20.8	M12	0.1	With
HWD07R030MM16-05	3.5	30	23	5	63	40	22	28.8	M16	0.2	With

See page **H167** for TungFlex modular shank.

SPARE PARTS

Designation	Clamping screw	Lubricant	Wrench
HWD07**M...	CSTB-2.5S	M-1000	T-8D

*Recommended clamping torque : CSTB-2.5S = 1 N·m

Reference pages: Inserts, Standard cutting conditions → **H183**, TungFlex → **H167**

INSERT

RDMW05/07/10

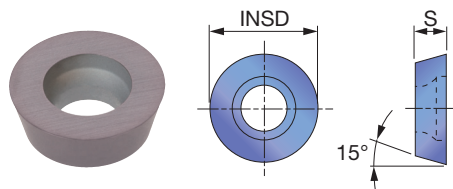

P Steel	★	
M Stainless		
K Cast iron	★	
N Non-ferrous		
S Superalloys	★	
H Hard materials		

★ : First choice
☆ : Second choice

Designation	APMX	Coated						INSD	S
		AH120							
RDMW0501M0	0.098	●						0.197	0.055
RDMW0702M0	0.138	●						0.276	0.094
RDMW1003M0	0.196	●						0.394	3.180

● : Line up

STANDARD CUTTING CONDITIONS

ISO	Workpiece material	Grade	Cutting speed Vc (sfm)	Feed per tooth fz (ipt)	Depth of cut: APMX (in)		
					Cutter dia. ø0.500"	Cutter dia. ø0.625", ø0.750"	Cutter dia. ø1.000"
P	Carbon steels 1018, 1055, etc. < 300 HB	AH120	650 - 1640	0.006 - 0.018	- 0.020	- 0.028	- 0.039
	Alloy steels 4140, 4340, etc. < 300 HB	AH120	390 - 1150	0.006 - 0.014	- 0.020	- 0.028	- 0.039
	Die steels H13, P20, etc. < 300 HB	AH120	330 - 980	0.004 - 0.012	- 0.020	- 0.028	- 0.039
K	Cast irons Class25-40, etc.	AH120	660 - 1640	0.008 - 0.020	- 0.020	- 0.028	- 0.039
H	Hardened steels, Prehardened steels < 40HRC	AH120	230 - 660	0.004 - 0.010	- 0.020	- 0.028	- 0.039

APPLICATION RANGE

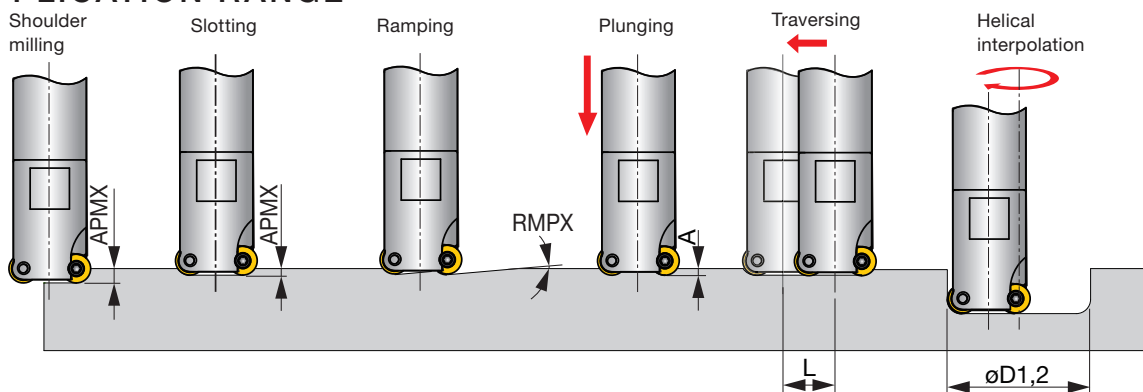

Inch	Tool-ø DCX	Max. depth of cut APMX	Max. ramping RMPX	Max. plunging depth A	Machining length for removing uncut portion L	Max. machining øD1	*Max. machining øD2
EWD05050RU	0.500	0.098	12.5°	0.060	0.342	0.804	0.921
EWD05075RU	0.750	0.098	4°	0.040	0.592	1.304	1.421
EWD07075RU	0.750	0.137	12°	0.080	0.513	1.225	1.421
EWD07100RU	1.000	0.137	7.5°	0.090	0.763	1.725	1.921
EWD07125RU	1.250	0.137	5°	0.080	1.013	2.225	2.421
EWD10100RU	1.000	0.196	15°	0.120	0.645	1.607	1.921
EWD10125RU	1.250	0.196	9.5°	0.120	0.895	2.107	2.421

*For flat bottom hole



EBP

Ball nose endmill for semi-finishing

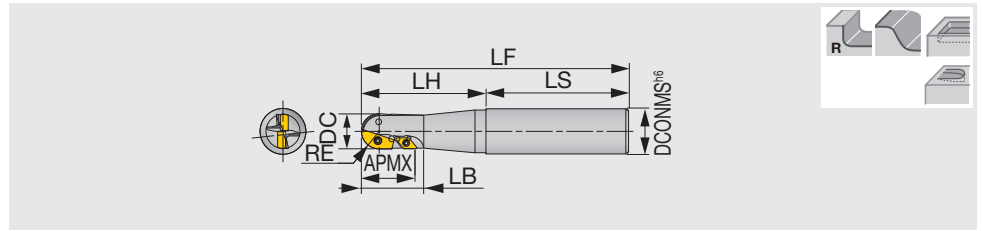

Inch	APMX	DC	CICT	DCONMS	LS	LH	LF	LB	RE	MK	Insert 1	Insert 2
EBP075MWU	0.625	0.750	2	1.000	2.280	2.750	5.030	1.250	0.375	-	ZPET075U-MJ	-
EBP100MWU	0.827	1.000	2	1.000	2.280	3.250	5.530	-	0.500	-	ZPET100U-MJ	-
EBP125MWU	1.000	1.250	2	1.250	2.280	3.750	6.030	-	0.625	-	ZPET125U-MJ	-
EBP075LWEU	1.140	0.750	2+2	1.000	2.280	3.750	6.030	1.250	0.375	MK2	ZPET075U-MJ	DCMW070204TN
EBP100LWEU	1.610	1.000	2+2	1.000	2.280	4.250	6.530	-	0.500	-	ZPET100U-MJ	DCMW11T304TN
EBP125LWEU	1.810	1.250	2+2	1.250	2.280	4.750	7.030	-	0.625	-	ZPET125U-MJ	DCMW11T304TN

SPARE PARTS

Designation	Clamping screw for Insert 1	Clamping screw for Insert 2	Lubricant	Wrench 1 for Insert 1	Wrench 2 for Insert 2
EBP075MWU	CSTD-3T	-	T-10D	-	-
EBP100MWU	CSTB-4S	-	T-15D	-	-
EBP125MWU	CSTB-5S	-	T-20D	-	-
EBP075LWEU	CSTD-3T	CSTB-2.5S	T-10D	T-8D	T-8D
EBP100LWEU	CSTB-4S	CSTB-4S	T-15D	T-15D	-
EBP125LWEU	CSTB-5S	CSTB-4S	T-20D	T-15D	T-20D

*Recommended clamping torque: CSTB-2.5S = 0.96 lbs·ft, CSTD-3T = 1.84 lbs·ft, CSTB-4S = 2.58 lbs·ft, CSTB-5S = 3.69 lbs·ft

INSERT

ZPET-MJ (For R edge)

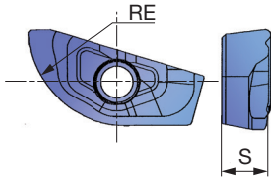

DCMW-TN (For P edge)

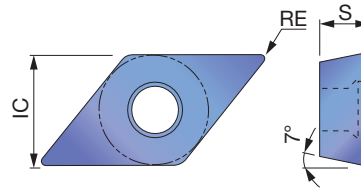

	P	M	K	N	S	H
Steel	☆	★				
Stainless						
Cast iron		★				
Non-ferrous						
Superalloys						
Hard materials	☆					

★ : First choice
☆ : Second choice

Designation	RE	Coated		IC	S
		AH120	AH330		
ZPET2004-MJ	0.375	●	●	-	0.169
ZPET2505-MJ	0.500	●	●	-	0.228
ZPET3006-MJ	0.625	●	●	-	0.276
ZPET3206-MJ	0.625	●	●	-	0.276
DCMW070204TN	0.016	●	●	0.252	0.266
DCMW11T304TN	0.016	●	●	0.375	0.094

ZPET30... : 5 piece per package
● : Line up

Reference pages: Standard cutting conditions → **H185**

STANDARD CUTTING CONDITIONS

ISO	Workpiece material	Grade	Machining type	Cutting speed Vc (sfm)	Table feed: Vf (in/min)		
					Tool dia. ϕ 0.787"	Tool dia. ϕ 0.984"	Tool dia. ϕ 1.181"
P	Carbon steels 1055, etc. < 300 HB	AH120	(1)	550 - 750	24 - 30	18 - 30	14 - 26
		AH120	(2)	650 - 850	35 - 51	27 - 43	21 - 37
		AH120	(3)	500 - 650	14 - 23	12 - 24	9 - 21
	Alloy steels 4140, 4340, etc. < 300 HB	AH120	(1)	500 - 690	21 - 33	16 - 28	12 - 24
		AH120	(2)	590 - 780	32 - 47	16 - 32	19 - 34
		AH120	(3)	425 - 590	14 - 26	10 - 22	8 - 19
	Die steels JIS SKD11, etc. < 300 HB	AH330	(1)	400 - 590	17 - 28	12 - 24	9 - 21
		AH330	(2)	500 - 690	26 - 42	19 - 35	15 - 30
		AH330	(3)	330 - 500	10 - 22	7 - 19	5 - 17
K	Cast irons JIS Class 25-40, etc.	AH120	(1)	550 - 750	32 - 43	24 - 36	19 - 31
		AH120	(2)	650 - 850	35 - 55	28 - 47	21 - 41
		AH120	(3)	500 - 650	17 - 28	12 - 24	9 - 21
H	Hardened steels Prehardened steels < 45 HRC	AH120	(1)	200 - 330	6 - 14	4 - 12	4 - 10
		AH120	(2)	230 - 425	6 - 18	4 - 16	4 - 14
		AH120	(3)	130 - 260	6 - 10	4 - 8	3 - 7

- Cutting speeds shown in the above table are of the most outer diameter of the tool.
- When the depth of cut is the upper limit shown in the above figures, set the cutting conditions to the lowest values shown left.
- When using long edge types, set the cutting speed and feed to 60 to 80 % of values shown in the table.
- When using long shank types, set the cutting speed and feed to 20 to 50 % of values shown in the table, bearing in mind the overhang length.

Machining types

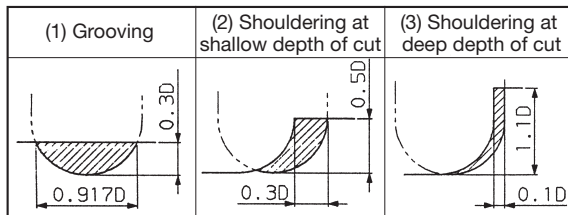

Grade
Insert
Ext. Toolholder
Int. Toolholder
Threading
Grooving
Miniature Tool
Milling Cutter
Endmill
Drilling Tool
Tooling System
User's Guide
Index



EBD

Ball nose endmill for roughing

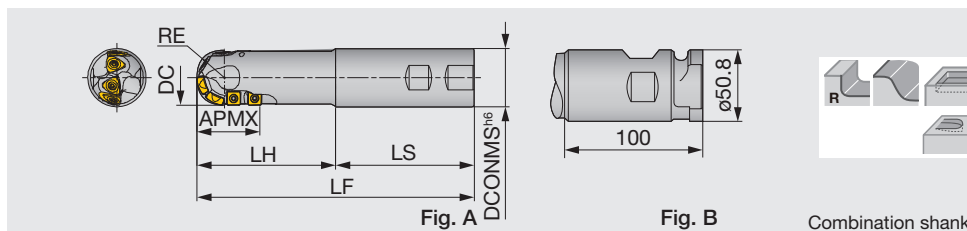

Metric	APMX	DC	CICT	DCONMS	LS	LH	LF	RE	Fig.	Insert R	Insert P
EBD040SSE	45	40	4 (7)	42	100	100	200	20	A	ZDMT4005-MJ	SCMT09T308-23
EBD040MSE	45	40	4 (7)	42	100	150	250	20	A	ZDMT4005-MJ	SCMT09T308-23
EBD050SSE	59	50	4 (7)	42	100	100	200	25	A	ZDMT5006-MJ	SCMT120408-23
EBD050MSE	59	50	4 (7)	42	100	150	250	25	A	ZDMT5006-MJ	SCMT120408-23
EBD050SCE	59	50	4 (7)	50.8	100	100	200	25	B	ZDMT5006-MJ	SCMT120408-23
EBD050MCE	59	50	4 (7)	50.8	100	150	250	25	B	ZDMT5006-MJ	SCMT120408-23

SPARE PARTS

Designation	Clamping screw	Lubricant	Wrench
EBD040*SE	CSTB-4M	M-1000	T-15T
EBD050**E	CSTB-5	M-1000	T-20T

*Recommended clamping torque : CSTB-4M = 3.5 N·m, CSTB-5 = 5 N·m

INSERT

ZDMT-MJ (For R edge)

SCMT-23 (For P edge)

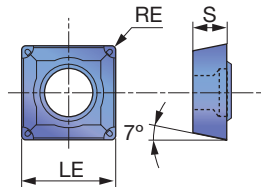
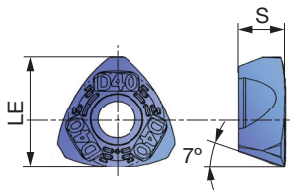

P Steel	☆	
M Stainless		
K Cast iron	★	
N Non-ferrous		
S Superalloys		
H Hard materials	☆	

★ : First choice
☆ : Second choice

Designation	RE	Coated										LE	S
		AH120											
ZDMT4005-MJ	-	●										0.512	0.217
ZDMT5006-MJ	-	●										0.638	0.256
SCMT09T308-23	0.031	●										0.375	0.156
SCMT120408-23	0.031	●										0.500	0.187

● : Line up

Reference pages: Standard cutting conditions → **H187**

STANDARD CUTTING CONDITIONS

ISO	Workpiece material	Grade	Machining type	Cutting speed Vc (sfm)	Table feed: Vf (in/min)	
					Tool dia. ϕ 1.570"	Tool dia. ϕ 2.000"
P	Carbon steels 1055, etc. < 300 HB	AH120	(1)	500 - 690	16 - 22	3 - 18
		AH120	(2)	550 - 750	16 - 22	13 - 17
		AH120	(3)	425 - 625	8 - 12	6 - 10
	Alloy steels 4140, 4340, etc. < 300 HB	AH120	(1)	425 - 625	14 - 20	11 - 16
		AH120	(2)	500 - 690	14 - 20	11 - 16
		AH120	(3)	360 - 560	7 - 11	5 - 9
	Die steels JIS SKD11, etc. < 300 HB	AH120	(1)	360 - 560	12 - 18	10 - 15
		AH120	(2)	425 - 625	12 - 18	10 - 14
		AH120	(3)	295 - 500	6 - 10	5 - 8
K	Cast irons JIS Class 25-40, etc.	AH120	(1)	550 - 750	20 - 27	16 - 21
		AH120	(2)	625 - 820	20 - 27	16 - 21
		AH120	(3)	500 - 690	12 - 20	9 - 13
H	Hardened steels Prehardened steels < 45 HRC	AH120	(1)	230 - 360	6 - 10	5 - 8
		AH120	(2)	260 - 400	6 - 10	5 - 8
		AH120	(3)	160 - 300	3 - 6	2 - 5

- Cutting speeds shown in the above table are of the most outer diameter of the tool.
- The values of the cutting speeds and feeds shown in the table are of under general cutting conditions. The values should be modified depending on the power and rigidity of the machine to be used, and work holding conditions.
- When using the long shank type, the depth of cut, pick feed, cutting speed, and table feed should be reduced to 70 %-90 % of the values shown in the tables.

Machining types

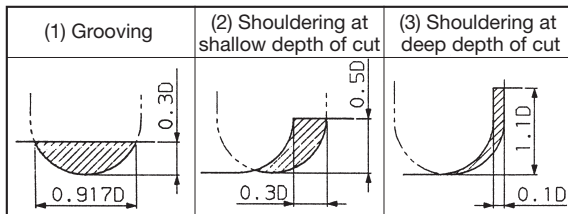

Grade
Insert
Toolholder
Ext. Toolholder
Int. Toolholder
Threading
Grooving
Tool
Miniature Tool
Milling Cutter
Endmill
Drilling Tool
Tooling System
User's Guide
Index



BBB2000

T-CBN ball nose endmill for dies and molds

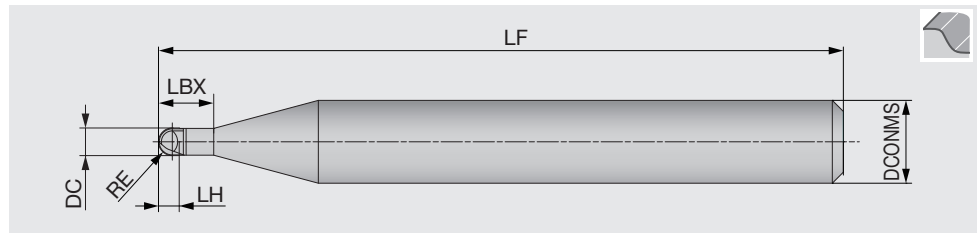

Metric	BX850	NOF	RE	DC	LH	LBX	LF	DCONMS
BBB2006	●	2	0.3	0.6	0.5	1.2	50	6
BBB2008	●	2	0.4	0.8	0.6	1.6	50	6
BBB2010	●	2	0.5	1	0.7	2	50	6
BBB2020	●	2	1	2	1.5	4	50	6

● : Line up

Tolerance (BBB2000)

R	R Tolerance	Tolerance on shank
0.3 ~ 1	±0.005	h6

STANDARD CUTTING CONDITIONS

ISO	Workpiece material	Hardness	No. of revolutions n (min ⁻¹)	Ball radius (RE)							
				0.3		0.4		0.5		1	
				Depth of cut APMX × pf (mm)	Feed rate (mm/min)	Depth of cut APMX × pf (mm)	Feed rate (mm/min)	Depth of cut APMX × pf (mm)	Feed rate (mm/min)	Depth of cut APMX × pf (mm)	Feed rate (mm/min)
H	Prehardened steel (NAK80, etc.) Die steel (JIS SKD61, etc.)	~ 52 HRC	50,000	0.02 × 0.03	2,000	0.03 × 0.05	2,000	0.05 × 0.05	3,000	0.10 × 0.10	5,000
	Die steel (JIS SKD11, DRM1 & 2, etc.)	~ 62 HRC	50,000	0.01 × 0.02	2,000	0.02 × 0.03	2,000	0.03 × 0.05	3,000	0.05 × 0.05	5,000
	High speed steel, Die steel (JIS SKH, DRM3, etc.)	~ 70 HRC	50,000	0.01 × 0.02	1,500	0.01 × 0.03	1,500	0.02 × 0.03	2,000	0.03 × 0.05	3,000

- Depths of cut (APMX) shown in the table are the allowable maximum values.
- Mist cooling or air blow is recommended.
- The maximum number of revolutions of the machine to be used is lower than 50,000 min⁻¹, the revolutions and feed rate should be modified at same rate.
- Use smallest possible overhang.

Ball radius (RE)	Inclined angle of workpiece (θ_1) / Effective neck length (Z)			
0.3	0°30'/1.25	1°/1.30	2°/1.35	3°/1.45
0.4	0°30'/1.65	1°/1.70	2°/1.80	3°/1.90
0.5	0°30'/2.05	1°/2.10	2°/2.25	3°/2.40
1	0°30'/4.15	1°/4.25	2°/4.50	3°/4.80

MEMO

Grade	A
Insert	B
Ext. Toolholder	C
Int. Toolholder	D
Threading	E
Grooving	F
Miniature Tool	G
Milling Cutter	H
Endmill	I
Drilling Tool	J
Tooling System	K
User's Guide	L
Index	M

THREADMILLING

- High Feed Milling
- Face Milling
- Shoulder Milling
- Slot Milling
- Profile Milling
- Thread Milling
- Other



Highly economical tool design

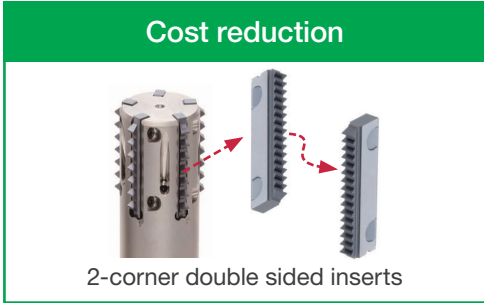

SOLIDTHREAD Selection Guide (for ISO metric)

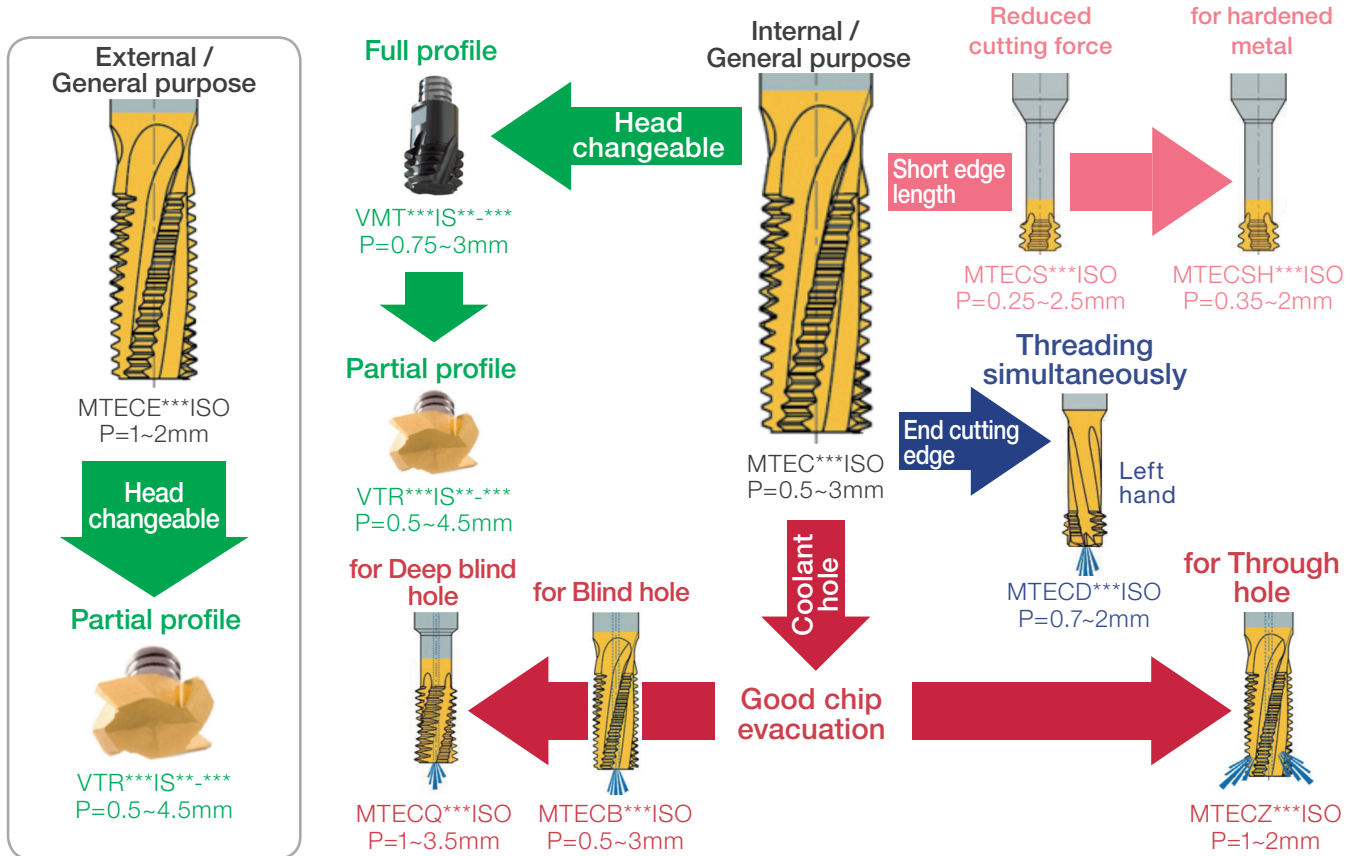

Reference pages: **H191 - H203, L060**

Designation System for Solid Carbide Endmills

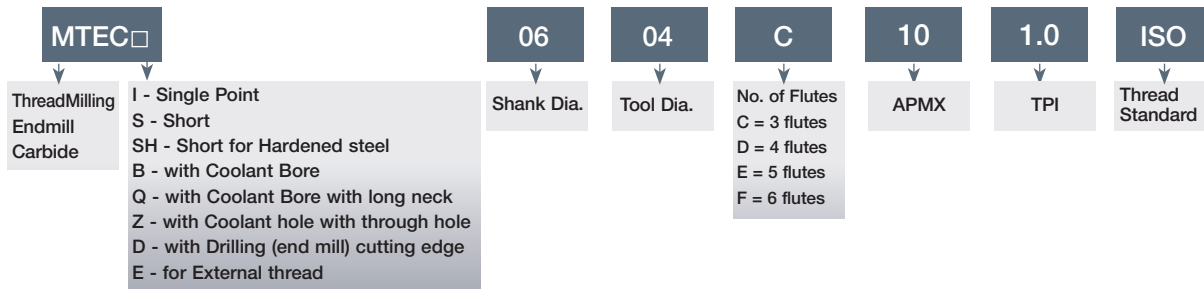

ISO metric

MTEC-ISO

Solid carbide internal threading endmill, for ISO metric profile

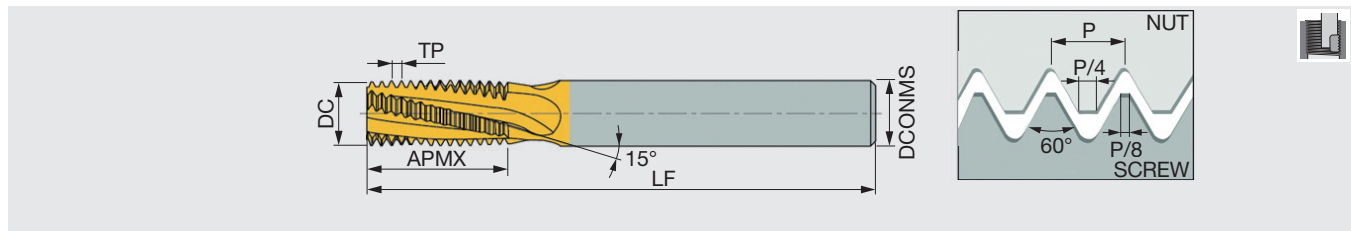

Metric	TPI	Application range		DCONMS	DC (in)	DC (mm)	NOF	APMX (in)	APMX (mm)	LF (in)	LF (mm)	Coolant hole	Grade
		Fine	Coarse										
MTEC06038C100.5ISO	0.5	-	≥M5	6	0.150	3.8	3	0.406	10.3	2.283	58	Without	AH725
MTEC06022C50.5ISO	0.5	M3	≥M4	6	0.087	2.2	3	0.209	5.3	2.283	58	Without	AH725
MTEC06031C70.7ISO	0.7	M4	≥M5	6	0.122	3.1	3	0.291	7.4	2.283	58	Without	AH725
MTEC06045C100.75ISO	0.75	-	≥M6	6	0.177	4.5	3	0.394	10	2.283	58	Without	AH725
MTEC06036C90.8ISO	0.8	M5	≥M6	6	0.142	3.6	3	0.362	9.2	2.283	58	Without	AH725
MTEC0606C121.0ISO	1	-	≥M9	6	0.236	6	3	0.492	12.5	2.283	58	Without	AH725
MTEC0808D161.0ISO	1	-	≥M10	8	0.315	8	4	0.650	16.5	2.520	64	Without	AH725
MTEC0604C101.0ISO	1	M6	≥M7	6	0.157	4	3	0.413	10.5	2.283	58	Without	AH725
MTEC0604C141.0ISO	1	M6	≥M7	6	0.157	4	3	0.571	14.5	2.283	58	Without	AH725
MTEC0605C141.25ISO	1.25	M8	≥M10	6	0.197	5	3	0.567	14.4	2.283	58	Without	AH725
MTEC0605C191.25ISO	1.25	M8	≥M10	6	0.197	5	3	0.764	19.4	2.283	58	Without	AH725
MTEC1010D211.5ISO	1.5	-	≥M14	10	0.394	10	4	0.858	21.8	2.874	73	Without	AH725
MTEC1616F331.5ISO	1.5	-	≥M20	16	0.630	16	6	1.331	33.8	4.134	105	Without	AH725
MTEC0807C171.5ISO	1.5	M10	≥M12	8	0.276	7	3	0.681	17.3	2.520	64	Without	AH725
MTEC0807C241.5ISO	1.5	M10	≥M12	8	0.276	7	3	0.976	24.8	2.992	76	Without	AH725
MTEC0808C201.75ISO	1.75	M12	≥M14	8	0.315	8	3	0.791	20.1	2.520	64	Without	AH725
MTEC0808C281.75ISO	1.75	M12	≥M14	8	0.315	8	3	1.138	28.9	2.992	76	Without	AH725
MTEC1212D272.0ISO	2	-	≥M18	12	0.472	12	4	1.063	27	3.307	84	Without	AH725
MTEC2020F412.0ISO	2	-	≥M26	20	0.787	20	6	1.614	41	4.134	105	Without	AH725
MTEC1010C272.0ISO	2	M16	≥M17	10	0.394	10	3	1.063	27	2.874	73	Without	AH725
MTEC1010C392.0ISO	2	M16	≥M17	10	0.394	10	3	1.535	39	4.134	105	Without	AH725
MTEC1414D332.5ISO	2.5	M20	≥M22	14	0.551	14	4	1.331	33.8	3.307	84	Without	AH725
MTEC1414D482.5ISO	2.5	M20	≥M22	14	0.551	14	4	1.921	48.8	4.134	105	Without	AH725
MTEC1616C403.0ISO	3	M24	≥M25	16	0.630	16	3	1.594	40.5	4.134	105	Without	AH725
MTEC1616C583.0ISO	3	M24	≥M25	16	0.630	16	3	2.303	58.5	4.724	120	Without	AH725

Reference pages: Standard cutting conditions → **H206 - H207**

Grade
Insert
Ext. Toolholder
Int. Toolholder
Threading
Grooving
Miniature Tool
Milling Cutter
Endmill
Drilling Tool
User's Guide Tooling System
Index



ISO metric

MTECB-ISO

Solid carbide internal threading endmill, with coolant hole, for ISO metric profile

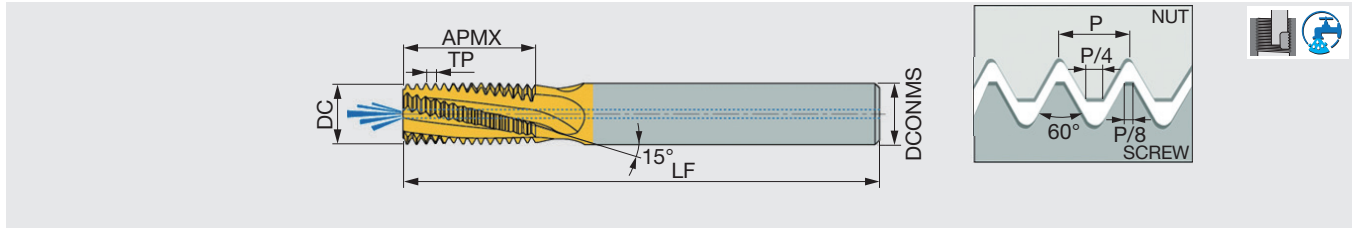

Metric	TP	Application range		DCONMS	DC	NOF	APMX	LF	Coolant hole	Grade
		Fine	Coarse							
MTECB06038C100.5ISO	0.5	-	≥M5	6	3.8	3	10.3	58	With	AH725
MTECB06031C70.7ISO	0.7	M4	≥M5	6	3.1	3	7.4	58	With	AH725
MTECB06045C100.75ISO	0.75	-	≥M6	6	4.5	3	10.1	58	With	AH725
MTECB1010D240.75ISO	0.75	-	≥M12	10	10	4	24.4	73	With	AH725
MTECB06038C90.8ISO	0.8	M5	≥M6	6	3.8	3	9.2	58	With	AH725
MTECB0606C121.0ISO	1	-	≥M9	6	6	3	12.5	58	With	AH725
MTECB0808D161.0ISO	1	-	≥M10	8	8	4	16.5	64	With	AH725
MTECB1010D241.0ISO	1	-	≥M12	10	10	4	24.5	73	With	AH725
MTECB06046C101.0ISO	1	M6	≥M7	6	4.6	3	10.5	58	With	AH725
MTECB06046C141.0ISO	1	M6	≥M6	6	4.6	3	14.5	58	With	AH725
MTECB0606C141.25ISO	1.25	M8	≥M10	6	6	3	14.4	58	With	AH725
MTECB0606C191.25ISO	1.25	M8	≥M10	6	6	3	19.4	58	With	AH725
MTECB1010D211.5ISO	1.5	-	≥M14	10	10	4	21.8	73	With	AH725
MTECB1616F331.5ISO	1.5	-	≥M20	16	16	6	33.8	105	With	AH725
MTECB1212D261.5ISO	1.5	-	≥M16	12	12	4	26.3	84	With	AH725
MTECB08078C171.5ISO	1.5	M10	≥M12	8	7.8	3	17	64	With	AH725
MTECB08078C241.5ISO	1.5	M10	≥M12	8	7.8	3	24.8	76	With	AH725
MTECB1009C201.75ISO	1.75	M12	≥M12	10	9	3	20.1	73	With	AH725
MTECB1009C281.75ISO	1.75	M12	≥M12	10	9	3	28.9	73	With	AH725
MTECB1010C272.0ISO	2	M14	≥M15	10	10	3	27	73	With	AH725
MTECB12118D272.0ISO	2	M16	≥M17	12	11.8	4	27	84	With	AH725
MTECB12118D392.0ISO	2	M16	≥M17	12	11.8	4	39	105	With	AH725
MTECB1615E332.5ISO	2.5	M20	≥M22	16	15	5	33.8	105	With	AH725
MTECB1615E482.5ISO	2.5	M20	≥M22	16	15	5	48.8	105	With	AH725
MTECB2018D583.0ISO	3	M24	≥M25	20	18	4	58.5	120	With	AH725

Reference pages: Standard cutting conditions → **H206 - H207**

MTECQ-ISO

Solid carbide deep internal threading endmill, with internal coolant hole, for ISO metric profile

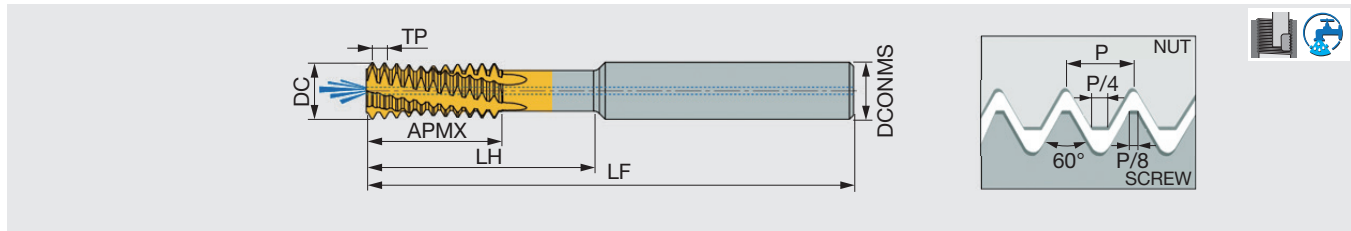

Metric	TP	Application range	DCONMS	DC	NOF	APMX	LH	LF	Coolant hole	Grade
MTECQ1212D381.0ISO	1	≥M14	12	12	4	21	38	84	With	AH725
MTECQ1010D301.5ISO	1.5	≥M13	10	10	4	18	30	73	With	AH725
MTECQ2020F562.0ISO	2	≥M24	20	20	6	34	56	105	With	AH725
MTECQ2020D453.5ISO	3.5	≥M26	20	20	4	28	45.5	105	With	AH725

MTECZ-ISO

Solid carbide internal threading endmill, with coolant hole in the flute, for ISO metric profile

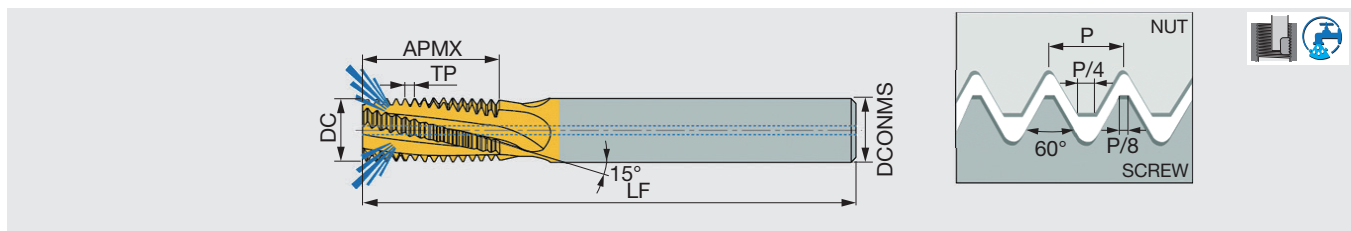

Metric	TP	Application range		DCONMS	DC	NOF	APMX	LF	Coolant hole	Grade
		Fine	Coarse							
MTECZ0808D161.0ISO	1	-	≥M10	8	8	4	16.5	64	With	AH725
MTECZ06048C101.0ISO	1	M6	≥M7	6	4.8	3	10.5	58	With	AH725
MTECZ0606C141.25ISO	1.25	M8	≥M10	6	6	3	14.4	58	With	AH725
MTECZ0606C191.25ISO	1.25	M8	≥M10	6	6	3	19.4	58	With	AH725
MTECZ1010D211.5ISO	1.5	-	≥M14	10	10	4	21.8	73	With	AH725
MTECZ1212D261.5ISO	1.5	-	≥M16	12	12	4	26.3	84	With	AH725
MTECZ1616E331.5ISO	1.5	-	≥M20	16	16	5	33.8	101	With	AH725
MTECZ08078C171.5ISO	1.5	M10	≥M12	8	7.8	3	17	64	With	AH725
MTECZ1009C281.75ISO	1.75	M12	≥M12	10	9	3	28.9	73	With	AH725
MTECZ1010C272.0ISO	2	M14	≥M15	10	10	3	27	73	With	AH725
MTECZ12118D272.0ISO	2	M16	≥M17	12	11.8	4	27	84	With	AH725

Reference pages: Standard cutting conditions → [H206](#) - [H207](#)



ISO metric

MTECS-ISO

Small diameter solid carbide internal threading endmill, short edge type, for ISO metric profile

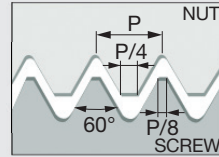
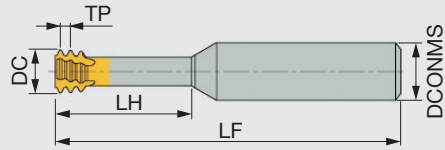

Metric	TP	Application range	DCONMS	DC	NOF	LH	LF	Coolant hole	Grade
MTECS03007C20.25ISO	0.25	≥M1	3	0.72	3	2.5	39	Without	AH725
MTECS03009C30.25ISO	0.25	≥M1.2	3	0.9	3	3	39	Without	AH725
MTECS03011C40.3ISO	0.3	≥M1.4	3	1.05	3	4	39	Without	AH725
MTECS03012C50.35ISO	0.35	≥M1.6	3	1.2	3	4.8	39	Without	AH725
MTECS03016C60.4ISO	0.4	≥M2	3	1.53	3	6	39	Without	AH725
MTECS06016C40.4ISO	0.4	≥M2	6	1.53	3	4.5	58	Without	AH725
MTECS03017C70.45ISO	0.45	≥M2.2	3	1.65	3	7	39	Without	AH725
MTECS06017C50.45ISO	0.45	≥M2.2	6	1.65	3	5	58	Without	AH725
MTECS0602C50.45ISO	0.45	≥M2.5	6	1.95	3	5.5	58	Without	AH725
MTECS0602C70.45ISO	0.45	≥M2.5	6	1.95	3	7.5	58	Without	AH725
MTECS06024C60.5ISO	0.5	≥M3	6	2.37	3	6.5	58	Without	AH725
MTECS06024C90.5ISO	0.5	≥M3	6	2.37	3	9.5	58	Without	AH725
MTECS06024C90.5ISOL	0.5	≥M3	6	2.37	3	9.5	105	Without	AH725
MTECS03024C120.5ISO	0.5	≥M3	3	2.4	3	12.5	39	Without	AH725
MTECS03024C150.5ISO	0.5	≥M3	3	2.4	3	15.5	39	Without	AH725
MTECS06054D200.5ISO	0.5	≥M6	6	5.35	4	20	58	Without	AH725
MTECS06028C100.6ISO	0.6	≥M3.5	6	2.75	3	10.5	58	Without	AH725
MTECS06028C70.6ISO	0.6	≥M3.5	6	2.75	3	7.5	58	Without	AH725
MTECS06031C120.7ISO	0.7	≥M4	6	3.1	3	12.5	58	Without	AH725
MTECS06031C120.7ISOL	0.7	≥M4	6	3.1	3	12.5	105	Without	AH725
MTECS06031C160.7ISO	0.7	≥M4	6	3.1	3	16.7	58	Without	AH725
MTECS06031C90.7ISO	0.7	≥M4	6	3.1	3	9	58	Without	AH725
MTECS0808D250.75ISO	0.75	≥M10	8	8	4	25	64	Without	AH725
MTECS06038C120.8ISO	0.8	≥M5	6	3.8	3	12.5	58	Without	AH725
MTECS06038C160.8ISO	0.8	≥M5	6	3.8	3	16	58	Without	AH725
MTECS06038C160.8ISOL	0.8	≥M5	6	3.8	3	16	105	Without	AH725
MTECS06047C141.0ISO	1	≥M6	6	4.65	3	14	58	Without	AH725
MTECS06047C201.0ISO	1	≥M6	6	4.65	3	20	58	Without	AH725
MTECS06047C201.0ISOL	1	≥M6	6	4.65	3	20	105	Without	AH725
MTECS0606C181.25ISO	1.25	≥M8	6	6	3	18	58	Without	AH725
MTECS0606C241.25ISO	1.25	≥M8	6	6	3	24	58	Without	AH725
MTECS08078C231.5ISO	1.5	≥M10	8	7.8	3	23	64	Without	AH725
MTECS08078C311.5ISO	1.5	≥M10	8	7.8	3	31.5	64	Without	AH725
MTECS1009C261.75ISO	1.75	≥M12	10	9	3	26	73	Without	AH725
MTECS12118D352.0ISO	2	≥M16	12	11.8	4	35	84	Without	AH725
MTECS12118D502.0ISO	2	≥M16	12	11.8	4	50	105	Without	AH725
MTECS1615E432.5ISO	2.5	≥M20	16	15	5	43	100	Without	AH725

Reference pages: Standard cutting conditions → [H206](#) - [H207](#)

MTECSH-ISO

Small diameter solid carbide internal threading endmill, short edge type, left hand cutting, for ISO metric profile



Metric	TP	Application range	DCONMS	DC	NOF	LH	LF	Coolant hole	Grade
MTECSH03012C50.35ISO	0.35	≥M1.6	3	1.2	3	4.8	39	Without	AH750
MTECSH03016C60.4ISO	0.4	≥M2	3	1.55	3	6	39	Without	AH750
MTECSH06016C40.4ISO	0.4	≥M2	6	1.55	3	4.5	58	Without	AH750
MTECSH06017C50.45ISO	0.45	≥M2.2	6	1.65	3	5	58	Without	AH750
MTECSH0602C50.45ISO	0.45	≥M2.5	6	1.95	3	5.5	58	Without	AH750
MTECSH0602C70.45ISO	0.45	≥M2.5	6	1.95	3	7.5	58	Without	AH750
MTECSH06024C60.5ISO	0.5	≥M3	6	2.35	3	6.5	58	Without	AH750
MTECSH06024C90.5ISO	0.5	≥M3	6	2.35	3	9.5	58	Without	AH750
MTECSH06028C70.6ISO	0.6	≥M3.5	6	2.75	3	7.5	58	Without	AH750
MTECSH06031C120.7ISO	0.7	≥M4	6	3.1	3	12.5	58	Without	AH750
MTECSH06038C120.8ISO	0.8	≥M5	6	3.8	3	12.5	58	Without	AH750
MTECSH06047C141.0ISO	1	≥M6	6	4.65	3	14	58	Without	AH750
MTECSH06047C201.0ISO	1	≥M6	6	4.65	3	20	58	Without	AH750
MTECSH0606C181.25ISO	1.25	≥M8	6	5.95	3	18	58	Without	AH750
MTECSH0606C241.25ISO	1.25	≥M8	6	5.95	3	24	58	Without	AH750
MTECSH08078C231.5ISO	1.5	≥M10	8	7.8	3	23	64	Without	AH750
MTECSH1009C261.75ISO	1.75	≥M12	10	9	3	26	73	Without	AH750
MTECSH12118D352.0ISO	2	≥M16	12	11.8	4	35	84	Without	AH750

Reference pages: Standard cutting conditions → [H206](#) - [H207](#)



ISO metric

MTECD-ISO

Small diameter solid carbide endmill for internal threading, drilling, and chamfering, short edge type, left hand cutting, for ISO metric profile

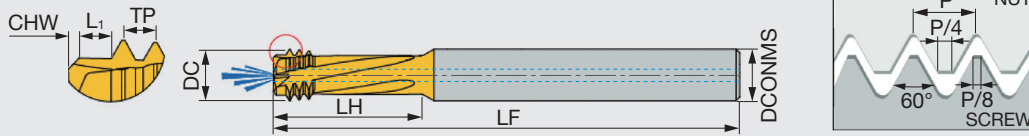

Metric	TP	Application range	DCONMS	DC	NOF	LH	LF	CHW	L1	Coolant hole	Grade
MTECD06032C110.7ISO	0.7	M4	6	3.15	3	11.6	58	0.2	0.7	Without	AH725
MTECD0604C140.8ISO	0.8	M5	6	4	3	14.4	58	0.3	0.8	Without	AH725
MTECD08047C141.0ISO	1	M6-M9	8	4.7	3	14	64	0.4	1	With	AH725
MTECD08061D181.25ISO	1.25	M8-M12	8	6.1	4	18	64	0.5	1.3	With	AH725
MTECD08078D231.5ISO	1.5	M10-M15	8	7.8	4	23	64	0.6	1.5	With	AH725
MTECD1009D261.75ISO	1.75	M12	10	9	4	26	73	0.6	1.8	With	AH725
MTECD12118D352.0ISO	2	M16-M23	12	11.8	4	35	84	0.6	2	With	AH725

MTEC E-ISO

Solid carbide external threading endmill, for ISO metric profile



Metric	TP	DCONMS	DC	NOF	APMX	LF	Coolant hole	Grade
MTECE1010D161.0ISO	1	10	10	4	16.5	73	Without	AH725
MTECE1010D161.25ISO	1.25	10	10	4	16.9	73	Without	AH725
MTECE1010D151.5ISO	1.5	10	10	4	15.8	73	Without	AH725
MTECE1212D201.5ISO	1.5	12	12	4	20.3	84	Without	AH725
MTECE1212D201.75ISO	1.75	12	12	4	20.1	84	Without	AH725
MTECE1212D212.0ISO	2	12	12	4	21	84	Without	AH725

Unified

MTEC-UN

Solid carbide internal threading endmill, for UN profile

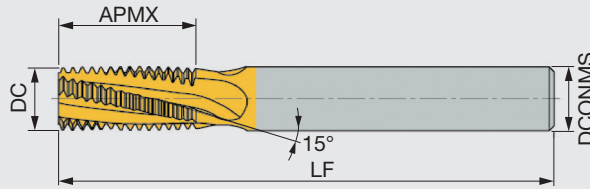

Metric	TPI	Application range			DCONMS	DC	NOF	APMX	LF	Coolant hole	Grade
		UNC	UNF	UNEF							
MTEC06032C632UN	32	#8	#10	#12	6	3.2	3	6.8	58	Without	AH725
MTEC0604C1128UN	28	-	7/16-1/2	-	6	4	3	11.3	58	Without	AH725
MTEC0606C1428UN	28	-	-	7/16-1/2	6	6	3	14.5	58	Without	AH725
MTEC0605C1424UN	24	-	5/16	-	6	5	3	14.3	58	Without	AH725
MTEC0807C2124UN	24	-	3/8	9/16-5/8	8	7	3	20	64	Without	AH725
MTEC06045C1220UN	20	1/4	-	-	6	4.5	3	12.1	58	Without	AH725
MTEC0807C2120UN	20	-	7/16-1/2	-	8	7	3	20	64	Without	AH725
MTEC1212E2720UN	20	-	-	3/4-1	12	12	5	27.3	84	Without	AH725
MTEC0605C1418UN	18	5/16	-	-	6	5	3	14.8	58	Without	AH725
MTEC1010D2618UN	18	-	9/16-5/8	1 1/8-1 5/8	10	10	4	26.1	73	Without	AH725
MTEC0606C1616UN	16	3/8	-	-	6	6	3	16.7	58	Without	AH725
MTEC1212D3116UN	16	-	3/4	-	12	12	4	30	84	Without	AH725
MTEC1615E3714UN	14	-	7/8	-	16	15	5	37.2	105	Without	AH725
MTEC0808C2213UN	13	1/2	-	-	8	8	3	22.5	64	Without	AH725
MTEC1010C2612UN	12	9/16	-	-	10	10	3	26.5	73	Without	AH725
MTEC1616E4112UN	12	-	1-1 1/2	-	16	16	5	41.3	105	Without	AH725
MTEC1010C2811UN	11	5/8	-	-	10	10	3	28.9	73	Without	AH725
MTEC1212C3410UN	10	3/4	-	-	12	12	3	34.3	84	Without	AH725
MTEC1615C389UN	9	7/8	-	-	16	15	3	38.1	105	Without	AH725
MTEC1616C428UN	8	1	-	-	16	16	3	42.9	105	Without	AH725



Unified

MTECB-UN

Solid carbide internal threading endmill, with coolant hole, for UN profile

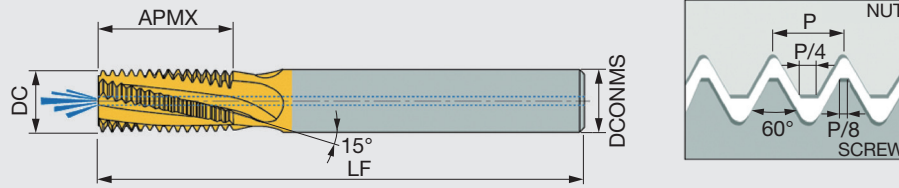

Metric	TPI	Application range			DCONMS	DC	NOF	APMX	LF	Coolant hole	Grade
		UNC	UNF	UNEF							
MTECB06032C632UN	32	#8	#10	#12	6	3.2	3	6.8	58	With	AH725
MTECB0606C1432UN	32	-	-	7/16-1/2	6	6	3	16	58	With	AH725
MTECB0605C1128UN	28	-	1/4	-	6	5	3	11.3	58	With	AH725
MTECB08066C1424UN	24	-	5/16	-	8	6.6	3	14.3	64	With	AH725
MTECB0808D2124UN	24	-	-	9/16-5/8	8	8	4	20.6	64	With	AH725
MTECB0808C2120UN	20	-	7/16	-	8	8	3	21	64	With	AH725
MTECB1010D2220UN	20	-	1/2	-	10	10	4	22.3	73	With	AH725
MTECB06056C1418UN	18	5/16	-	-	6	5.6	3	14.8	58	With	AH725
MTECB12113D2618UN	18	-	9/16-5/8	1 1/8-1 5/8	12	11.3	4	26.1	84	With	AH725
MTECB08067C1616UN	16	3/8	-	-	8	6.7	3	16.7	64	With	AH725
MTECB1212D3116UN	16	-	3/4	-	12	12	4	31	84	With	AH725
MTECB1616E3714UN	14	-	7/8	-	16	16	5	37.2	105	With	AH725
MTECB10092C2213UN	13	1/2	-	-	10	9.2	3	22.5	73	With	AH725
MTECB12114C2811UN	11	5/8	-	-	12	11.4	3	28.9	84	With	AH725
MTECB16144D3410UN	10	3/4	-	-	16	14.4	4	34.3	105	With	AH725
MTECB20195D428UN	8	1	-	-	20	19.5	4	42.9	105	With	AH725

MTECZ-UN

Solid carbide internal threading endmill, with coolant hole in the flute, for UN profile

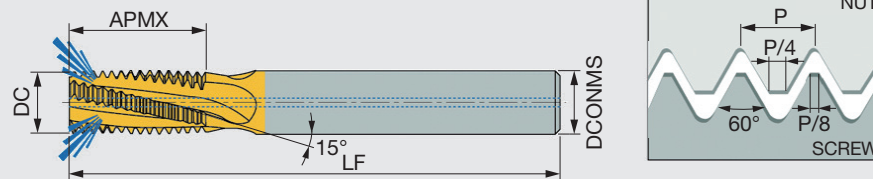

Metric	TPI	Application range			DCONMS	DC	NOF	APMX	LF	Coolant hole	Grade
		UNC	UNF	UNEF							
MTECZ1010D2220UN	20	-	1/2	-	10	10	4	22.3	73	With	AH725
MTECZ12113D2618UN	18	-	9/16-5/8	1 1/8-1 5/8	12	11.3	4	26.1	84	With	AH725
MTECZ08067C1616UN	16	3/8	-	-	8	6.7	3	16.7	64	With	AH725
MTECZ16144D3410UN	10	3/4	-	-	16	14.4	4	34.3	101	With	AH725

MTECS-UN

Small diameter solid carbide internal threading endmill, short edge type, for UN profile

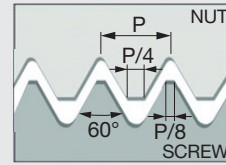
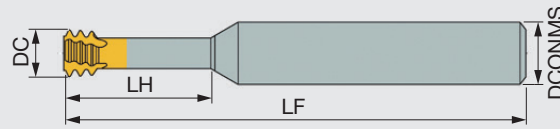

Metric	TPI	Application range		DCONMS	DC	NOF	LH	LF	Coolant hole	Grade
		UNC	UNF							
MTECS03012C880UN	80	-	#0	3	1.15	3	8	39	Without	AH725
MTECS03015C672UN	72	-	#1	3	1.45	3	6	39	Without	AH725
MTECS06016C656UN	56	#2	#3	6	1.65	3	6.6	58	Without	AH725
MTECS06016C456UN	56	#2	#3	6	1.65	3	4.4	58	Without	AH725
MTECS06019C548UN	48	#3	#4	6	1.9	3	5.2	58	Without	AH725
MTECS03021C1240UN	40	#4	-	3	2.1	3	12	39	Without	AH725
MTECS06021C840UN	40	#4	-	6	2.1	3	8	58	Without	AH725
MTECS06024C940UN	40	#5	#6	6	2.45	3	9.6	58	Without	AH725
MTECS06021C640UN	40	#4	-	6	2.1	3	6.3	58	Without	AH725
MTECS06033C936UN	36	-	#8	6	3.3	3	9	58	Without	AH725
MTECS06025C732UN	32	#6	-	6	2.55	3	7.1	58	Without	AH725
MTECS06025C1032UN	32	#6	-	6	2.55	3	10.5	58	Without	AH725
MTECS06032C932UN	32	#8	#10	6	3.2	3	9.5	58	Without	AH725
MTECS06032C1232UN	32	#8	#10	6	3.2	3	12.5	58	Without	AH725
MTECS06037C1032UN	32	-	#10	6	3.7	3	10.5	58	Without	AH725
MTECS06037C1532UN	32	-	#10	6	3.7	3	15	58	Without	AH725
MTECS0605C1428UN	28	-	1/4	6	5	3	14.5	58	Without	AH725
MTECS0605C1928UN	28	-	1/4	6	5	3	19	58	Without	AH725
MTECS08066C1724UN	24	-	5/16	8	6.6	3	17	64	Without	AH725
MTECS08066C2424UN	24	-	5/16	8	6.6	3	24	64	Without	AH725
MTECS06047C1420UN	20	1/4	-	6	4.75	3	14	58	Without	AH725
MTECS06047C1920UN	20	1/4	-	6	4.75	3	19	58	Without	AH725
MTECS06047C1920UN-L	20	1/4	-	6	4.75	3	19	105	Without	AH725
MTECS0808C2520UN	20	-	7/16	8	8	3	25	64	Without	AH725
MTECS0606C1718UN	18	5/16	-	6	6	3	17	58	Without	AH725
MTECS0606C2318UN	18	5/16	-	6	6	3	23	58	Without	AH725
MTECS1212D3518UN	18	-	5/8	12	12	4	35	84	Without	AH725
MTECS08067C2216UN	16	3/8	-	8	6.7	3	22	64	Without	AH725
MTECS08067C3016UN	16	3/8	-	8	6.7	3	30.2	64	Without	AH725
MTECS08077C2514UN	14	7/16	-	8	7.7	3	25	64	Without	AH725
MTECS10092C2713UN	13	1/2	-	10	9.2	3	27.5	73	Without	AH725
MTECS12114C3411UN	11	5/8	-	12	11.4	3	34.5	84	Without	AH725
MTECS12114C5011UN	11	5/8	-	12	11.4	3	50	105	Without	AH725

Reference pages: Standard cutting conditions → **H206 - H207**



Unified MTECSH-UN

Small diameter solid carbide internal threading endmill, short edge type, left hand cutting, for UN profile

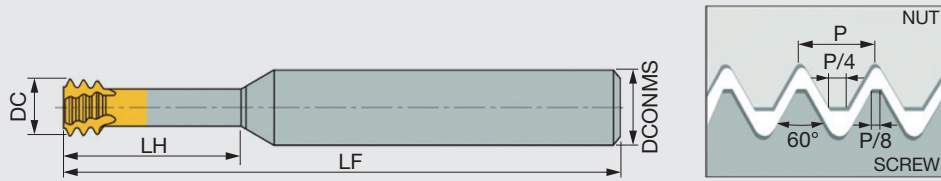

Metric	TPI	Application range		DCONMS	DC	NOF	LH	LF	Coolant hole	Grade
		UNC	UNF							
MTECSH06012C480UN	80	-	#0	6	1.15	3	4	58	Without	AH725
MTECSH06016C656UN	56	#2	#3	6	1.65	3	6.6	58	Without	AH725
MTECSH06019C548UN	48	#3	#4	6	1.9	3	5.2	58	Without	AH725
MTECSH06021C640UN	40	#4	-	6	2.1	3	6.3	58	Without	AH725
MTECSH06024C740UN	40	#5	#6	6	2.45	3	7	58	Without	AH725
MTECSH06021C840UN	40	#4	-	6	2.1	3	8	58	Without	AH725
MTECSH06024C940UN	40	#5	#6	6	2.45	3	9.6	58	Without	AH725
MTECSH06025C1032UN	32	#6	-	6	2.55	3	10.5	58	Without	AH725
MTECSH06032C932UN	32	#8	-	6	3.2	3	9.5	58	Without	AH725
MTECSH06037C1032UN	32	-	#10	6	3.7	3	10.5	58	Without	AH725
MTECSH06037C1532UN	32	-	#10	6	3.7	3	15	58	Without	AH725
MTECSH06042C1128UN	28	-	#12	6	4.2	3	11	58	Without	AH725
MTECSH0605C1428UN	28	-	1/4	6	5	3	14.5	58	Without	AH725
MTECSH06035C1024UN	24	#10-#12	-	6	3.5	3	10.6	58	Without	AH725
MTECSH08066C1724UN	24	-	5/16	8	6.6	3	17	64	Without	AH725
MTECSH08066C2424UN	24	-	5/16	8	6.6	3	24	64	Without	AH725
MTECSH06047C1920UN	20	1/4	-	6	4.75	3	19	58	Without	AH725
MTECSH0808C2520UN	20	-	7/16	8	8	3	25	64	Without	AH725
MTECSH0606C1718UN	18	5/16	-	6	6	3	17	58	Without	AH725
MTECSH0606C2318UN	18	5/16	-	6	6	3	23	58	Without	AH725
MTECSH08067C2216UN	16	3/8	-	8	6.7	3	22	64	Without	AH725
MTECSH08077C2514UN	14	7/16	-	8	7.7	3	25	64	Without	AH725
MTECSH10092C2713UN	13	1/2	-	10	9.2	3	27.5	73	Without	AH725
MTECSH12114C3411UN	11	5/8	-	12	11.4	3	34.5	84	Without	AH725

MTEC E-UN

Solid carbide external threading endmill, for UN profile



Metric	TPI	DCONMS	DC	NOF	APMX	LF	Coolant hole	Grade
MTECE1010D1624UN	24	10	10	4	16.4	73	Without	AH725
MTECE1212E2120UN	20	12	12	5	21	84	Without	AH725

Reference pages: Standard cutting conditions → **H206 - H207**

Whitworth

MTEC-W

Solid carbide internal and external threading endmill, for BSP profile

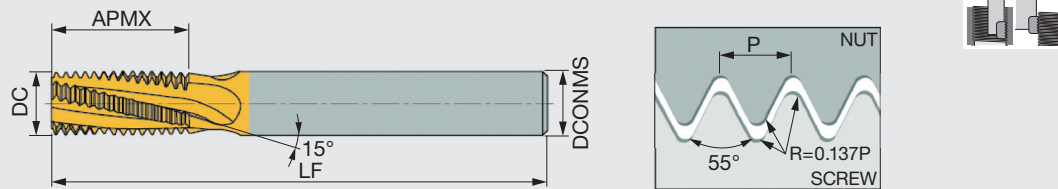

Metric	TPI	Application range	DCONMS	DC	NOF	APMX	LF	Coolant hole	Grade
MTEC0606C928W	28	1/8	6	6	3	9.5	58	Without	AH725
MTEC0808C1419W	19	1/4-3/8	8	8	3	14	64	Without	AH725
MTEC1212D1914W	14	1/2-7/8	12	12	4	19.3	84	Without	AH725
MTEC1212D2614W	14	1/2-7/8	12	12	4	26.3	84	Without	AH725
MTEC1212C2411W	11	1-1 1/2	12	12	3	24.2	84	Without	AH725
MTEC1616D3811W	11	1-3	16	16	4	38.1	105	Without	AH725

MTECB-W

Solid carbide internal and external threading endmill, with coolant hole, for BSP profile

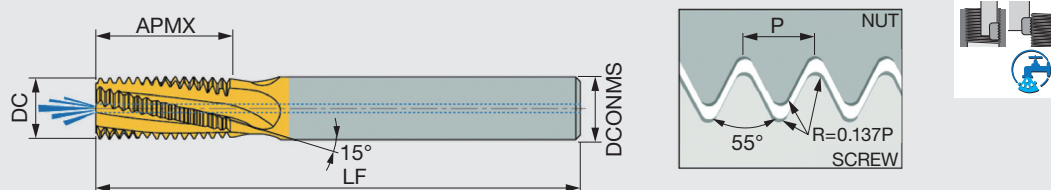

Metric	TPI	Application range	DCONMS	DC	NOF	APMX	LF	Coolant hole	Grade
MTECB08078C1428W	28	1/8	8	7.8	3	14.1	64	Without	AH725
MTECB1010D1619W	19	1/4-3/8	10	10	4	16.7	73	Without	AH725
MTECB1616E2614W	14	1/2-7/8	16	16	5	26.3	105	Without	AH725
MTECB1616D3811W	11	≥1	16	16	4	38.1	105	Without	AH725
MTECB2020E4711W	11	≥1	20	20	5	47.3	105	Without	AH725

MTECZ-W

Solid carbide internal and external threading endmill, with coolant hole, for BSP profile

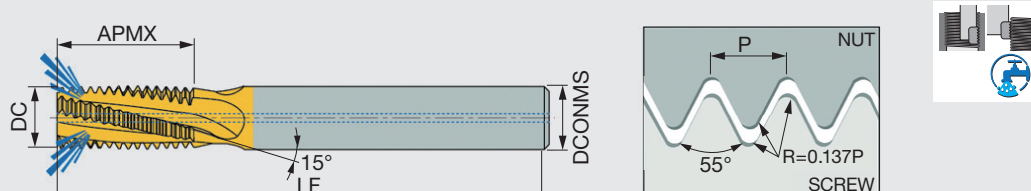

Metric	TPI	Application range	DCONMS	DC	NOF	APMX	LF	Coolant hole	Grade
MTECZ08078C1428W	28	1/8	8	7.8	3	14.1	64	With	AH725
MTECZ1010D1619W	19	1/4-3/8	10	10	4	16.7	73	With	AH725
MTECZ1616E2614W	14	1/2-7/8	16	16	5	26.3	101	With	AH725

Reference pages: Standard cutting conditions → [H206](#) - [H207](#)



Solid carbide internal and external threading endmill, short edge type, for BSP/BSF profile

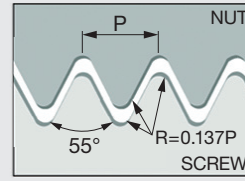
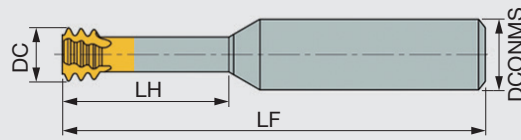

Metric	TPI	Application range	DCONMS	DC	NOF	LH	LF	Coolant hole	Grade
MTECS08078C1928W	28	1/8	8	7.8	3	19.5	64	Without	AH725
MTECS1010D3019W	19	1/4-3/8	10	10	4	30	73	Without	AH725
MTECS1212D3714W	14	1/2-7/8	12	12	4	37	84	Without	AH725

BSPT MTEC-BSPT

Solid carbide internal and external threading endmill. for BSPT profile

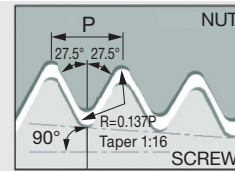
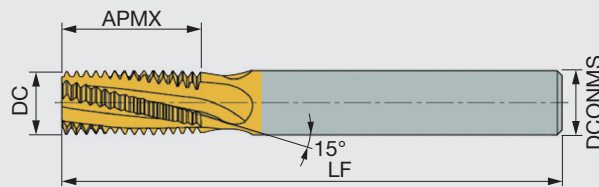

Metric	TPI	Application range	DCONMS	DC	NOF	APMX	LF	Coolant hole	Grade
MTEC0606C928BSPT	28	1/8	6	6	3	9.5	58	Without	AH725
MTEC0808C1419BSPT	19	1/4-3/8	8	8	3	14	64	Without	AH725
MTEC1212D1914BSPT	14	1/2-7/8	12	12	4	19.1	84	Without	AH725
MTEC1616D2811BSPT	11	1-2	16	16	4	28.9	105	Without	AH725

NPT MTEC-NPT

Solid carbide internal and external threading endmill. for NPT profile

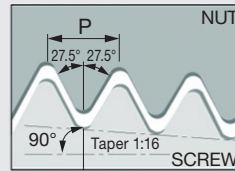
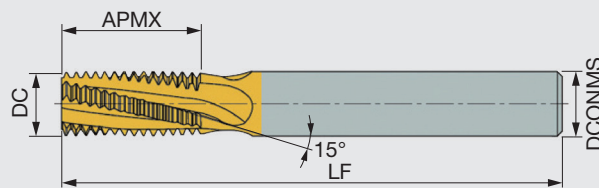

Metric	TPI	Application range	DCONMS	DC	NOF	APMX	LF	Coolant hole	Grade
MTEC0606C927NPT	27	1/16-1/8	6	6	3	9.9	58	Without	AH725
MTEC0808C1418NPT	18	1/4-3/8	8	8	3	14.8	64	Without	AH725
MTEC1212D2014NPT	14	1/2-3/4	12	12	4	20.9	84	Without	AH725
MTEC1616D2711.5NPT	11.5	1-2	16	16	4	27.6	105	Without	AH725
MTEC2020D398NPT	8	≥ 2 1/2	20	20	4	39.7	105	Without	AH725

MTECB-NPT

Solid carbide internal and external threading endmill, with coolant hole, for NPT profile

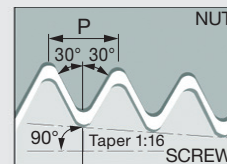
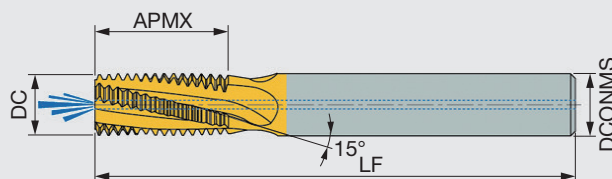

Metric	TPI	Application range	DCONMS	DC	NOF	APMX	LF	Coolant hole	Grade
MTECB08076C1027NPT	27	1/8	8	7.6	3	10.8	64	With	AH725
MTECB1010D1618NPT	18	1/4-3/8	10	10	4	16.2	73	With	AH725
MTECB16155D2214NPT	14	1/2-3/4	16	15.5	4	22.7	105	With	AH725

NPTF

MTECZ-NPTF

Solid carbide internal and external threading endmill, with coolant hole in the flute, for NPTF profile

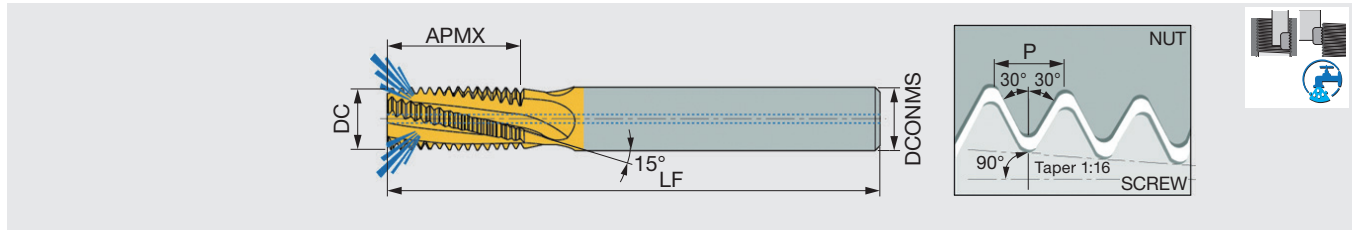

Metric	TPI	Application range	DCONMS	DC	NOF	APMX	LF	Coolant hole	Grade
MTECZ08076C1027NPTF	27	1/8	8	7.6	3	10.8	64	With	AH725
MTECZ1010D1618NPTF	18	1/4-3/8	10	10	4	16.2	73	With	AH725

MJ

MTECS-MJ

Small diameter solid carbide internal threading endmill, short edge type, with coolant hole, for MJ profile

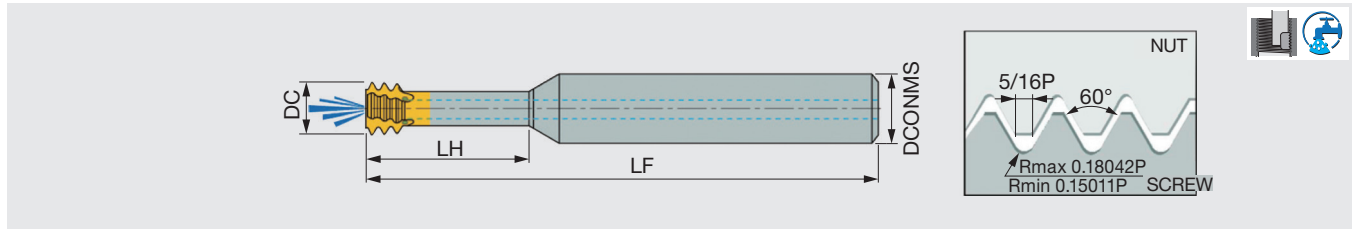

Metric	TP	Application range	DCONMS	DC	NOF	LH	LF	Coolant hole	Grade
MTECS06039C120.8MJ	0.8	5	6	3.9	3	12.5	58	With	AH725
MTECS08061C201.25MJ	1.25	8	8	6.1	3	20	64	With	AH725
MTECS10092C301.75MJ	1.75	12	10	9.2	3	30	73	With	AH725

UNJ

MTECS-UNJ

Small diameter solid carbide internal threading endmill, short edge type, with coolant hole, for UNJ profile

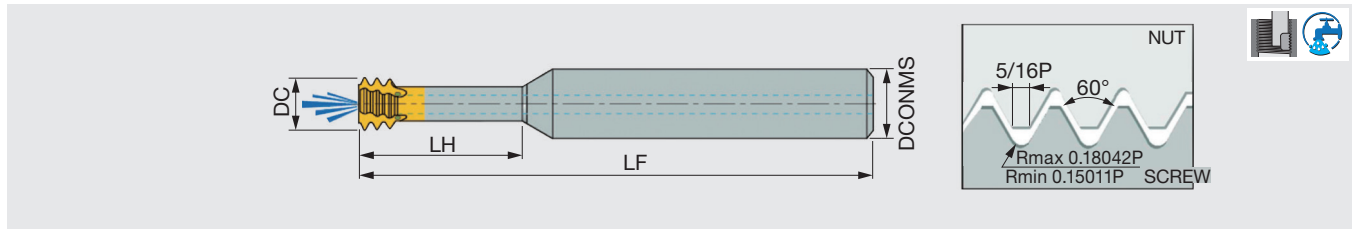

Metric	TPI	Application range		DCONMS	DC	NOF	LH	LF	Coolant hole	Grade
		UNJC	UNJF							
MTECS08051C1628UNJ	28	-	1/4	8	5.1	3	16	64	With	AH725
MTECS08067C2024UNJ	24	-	5/16-3/8	8	6.7	3	20	64	With	AH725
MTECS06049C1620UNJ	20	1/4	-	6	4.9	3	16	58	Without	AH725
MTECS0808C2820UNJ	20	-	7/16	8	8	3	28	64	With	AH725
MTECS08061C2018UNJ	18	5/16	-	8	6.15	3	20	64	With	AH725



Designation System for TungMeister

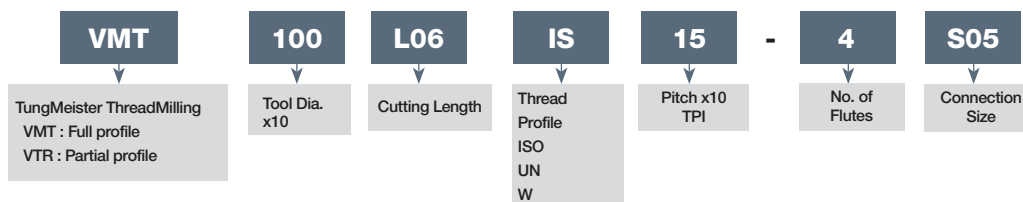

ISO metric

VMT***IS

Internal threading head, for ISO metric profile (TungMeister)

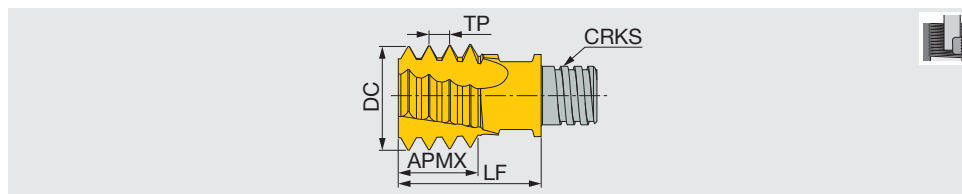

Metric	TP	Application range		DC	NOF	APMX	LF	CRKS	Grade	Wrench
		Fine	Coarse							
VMT100L06IS07-4S05	0.75	-	≥M12	10	4	6	12.8	S05	AH725	KEYV-S05
VMT100L06IS10-4S05	1	-	≥M12	10	4	6	12.8	S05	AH725	KEYV-S05
VMT100L06IS15-4S05	1.5	-	≥M14	10	4	6	12.8	S05	AH725	KEYV-S05
VMT120L09IS15-4S06	1.5	-	≥M16	12	4	9	14.3	S06	AH725	KEYV-T25
VMT120L10IS20-4S06	2	M16	≥M17	12	4	10	14.3	S06	AH725	KEYV-T25
VMT160L12IS15-6S08	1.5	-	≥M20	16	6	12	19	S08	AH725	KEYV-T30L
VMT160L12IS20-5S08	2	-	≥M19	16	5	12	19	S08	AH725	KEYV-T30L
VMT150L13IS25-5S08	2.5	M20	≥M22	15.4	5	12.5	19	S08	AH725	KEYV-T30L
VMT160L12IS30-3S08	3	M24	≥M25	16	3	12	19	S08	AH725	KEYV-T30L

Unified

VMT***UN

Internal threading head, for UN profile (TungMeister)

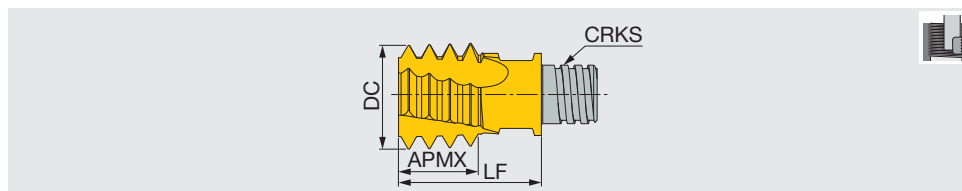

Metric	TPI	Application range			DC	NOF	APMX	LF	CRKS	Grade	Wrench
		UNC	UNF	UNEF							
VMT100L06UN24-4S05	24	-	-	9/16-5/8	10	4	5.3	12.8	S05	AH725	KEYV-S05
VMT100L06UN20-4S05	20	-	1/2	-	10	4	5.1	12.8	S05	AH725	KEYV-S05
VMT100L06UN18-4S05	18	-	9/16-5/8	1 1/8-1 5/8	10	4	5.6	12.8	S05	AH725	KEYV-S05
VMT120L10UN16-4S06	16	-	3/4	-	12	4	9	14.3	S06	AH725	KEYV-T25
VMT120L10UN14-4S06	14	-	7/8	-	12	4	9	14.3	S06	AH725	KEYV-T25
VMT160L13UN12-5S08	12	-	1-1 1/2	-	16	5	12.7	19	S08	AH725	KEYV-T30L
VMT150L13UN10-4S08	10	3/4	-	-	15.4	4	12.7	19	S08	AH725	KEYV-T30L
VMT160L11UN09-3S08	9	7/8	-	-	16	3	11.3	19	S08	AH725	KEYV-T30L
VMT160L12UN08-3S08	8	1	-	-	16	3	12.7	19	S08	AH725	KEYV-T30L

Reference pages: ThreadMilling → **H191 - H203**

Whitworth

VMT***W

Internal and external threading head, for 55° BSP profile (TungMeister)

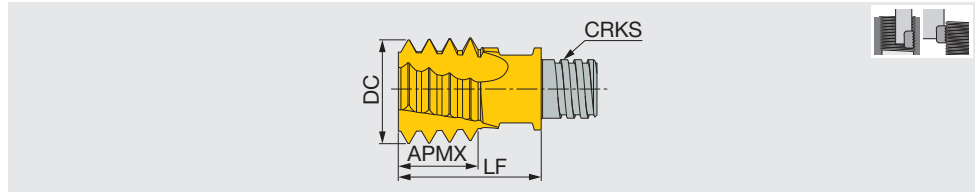

Metric	TPI	Application range	DC	NOF	APMX	LF	CRKS	Grade	Wrench
VMT100L06W19-4S05	19	1/4-3/8	10	4	5.3	12.8	S05	AH725	KEYV-S05
VMT160L12W14-4S08	14	1/2-7/8	16	4	12.7	19	S08	AH725	KEYV-T30L
VMT160L11W11-4S08	11	≥1	16	4	11.6	19	S08	AH725	KEYV-T30L

60° partial profile

VTR***IS

Internal and external threading head, for 60° partial profile (TungMeister)

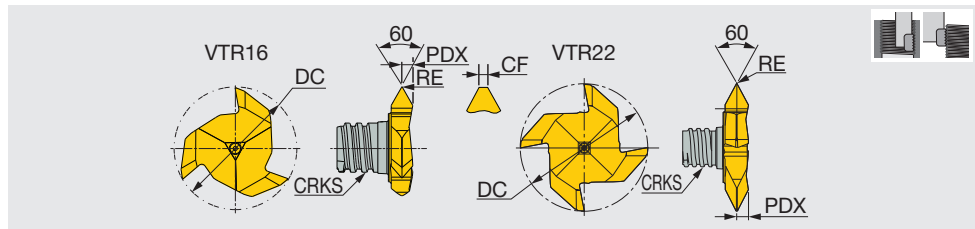

Metric	TP		Smallest Possible thread	DC	NOF	RE	CF	PDX	CRKS	Grade	Wrench
	TPN	TPX									
VTR160L12IS05-3S06	0.5	2	M20	15.7	3	-	0.05	1.4	S06	GH130	KEYV-177
VTR160L12IS15-3S06	1.5	2	M22	15.7	3	0.05	-	1.4	S06	GH130	KEYV-177
VTR220L28IS30-4S08	3	4.5	M36	21.7	4	0.2	-	2.8	S08	GH130	KEYV-217

55° partial profile

VTR***W

Internal and external threading head, for 55° partial profile

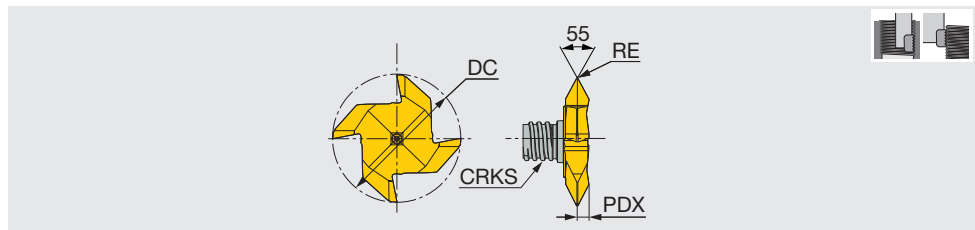

Metric	TPI		Smallest Possible thread	DC	NOF	RE	PDX	CRKS	Grade	Wrench
	TPIN	TPIX								
VTR220L24W14-4S08	14	11	3/4	21.7	4	0.2	2.4	S08	GH130	KEYV-217

Reference pages: ThreadMilling → [H191](#) - [H203](#)



STANDARD CUTTING CONDITIONS

ISO	Material	Condition	Tensile strength [N/mm ²]	Hardness HB	Cutting speed (sfm)	
					AH725	
P	Non-alloy steel and cast steel, free cutting steel	< 0.25 %C	Annealed	420	125	328 - 820
		≥ 0.25 %C	Annealed	650	190	262 - 689
		< 0.55 %C	Quenched and tempered	850	250	213 - 558
		≥ 0.55 %C	Annealed	750	220	361 - 591
	Low alloy steel and cast steel (less than 5% of alloying elements)	Quenched and tempered	1000	300	312 - 525	
		Annealed	600	200	295 - 525	
		Quenched and tempered	930	275	213 - 656	
			1000	300	230 - 689	
			1200	350	312 - 525	
		High alloyed steel, cast steel, and tool steel	Annealed	680	200	427 - 558
	Quenched and tempered		1100	325	246 - 328	
	Stainless steel and cast steel	Ferritic/martensitic	680	200	361 - 558	
Martensitic		820	240	230 - 509		
M	Stainless steel	Annealed	600	180	279 - 328	
K	Cast iron nodular (GGG)	Ferritic/martensitic	180	394 - 525		
		Pearlitic	260	246 - 525		
	Gray cast iron (GG)	Ferritic	160	230 - 492		
		Pearlitic	250	361 - 459		
		Ferritic	130	394 - 525		
Malleable cast iron	Pearlitic	230	361 - 459			
N	Aluminum- wrought alloy	Not cureable	60	525 - 984		
		Cured	100			
	Aluminum-cast, alloyed	≤12% Si	Not cureable	75	492 - 1148	
		Cured	90			
		>12% Si	High temperature	130	328 - 820	
	Copper alloys	>1% Pb	Free cutting	110		
		Brass	90			
Non-metallic	Electrolitic copper	100				
	Duroplastics, fiber plastics		328 - 1312			
S	High temp. alloys	Fe based	Annealed	200		
		Cured	280			
	Ni or Co based	Annealed	250	66 - 262		
		Cured	350			
		Cast	320			
	Titanium Ti alloys		RM 400			
Alpha+beta alloys cured		RM 1050	66 - 262			
H	Hardened steel	Hardened	55 HRC	180 - 213		
		Hardened	60 HRC	148 - 180		
	Chilled cast iron	Cast	400	295 - 344		
	Cast iron	Hardened	55 HRC	180 - 213		

Tool dia. : mm (in)

Feed (ipr)											
ø2 (0.079")	ø3 (0.118")	ø4 (0.157")	ø6 (0.236")	ø8 (0.315")	ø10 (0.394")	ø12 (0.472")	ø14 (0.551")	ø16 (0.630")	ø20 (0.787")	ø25 (0.984")	ø30 (1.181")
0.0012	0.0016	0.0016	0.0024	0.0028	0.0031	0.0035	0.0043	0.0047	0.0059	0.0071	0.0083
0.0012	0.0016	0.0016	0.0024	0.0028	0.0031	0.0035	0.0043	0.0047	0.0059	0.0071	0.0083
0.0008	0.0012	0.0012	0.002	0.0024	0.0028	0.0031	0.0035	0.0039	0.0047	0.0059	0.0071
0.0008	0.0012	0.0012	0.002	0.0024	0.0028	0.0031	0.0035	0.0039	0.0047	0.0059	0.0071
0.0008	0.0008	0.0012	0.0012	0.0016	0.002	0.002	0.0024	0.0028	0.0031	0.0039	0.0043
0.0008	0.0008	0.0012	0.0012	0.0016	0.002	0.002	0.0024	0.0028	0.0031	0.0039	0.0043
0.0008	0.0008	0.0012	0.0012	0.0016	0.002	0.002	0.0024	0.0028	0.0031	0.0039	0.0043
0.0008	0.0008	0.0012	0.0012	0.0016	0.002	0.002	0.0024	0.0028	0.0031	0.0039	0.0043
0.0008	0.0008	0.0012	0.0012	0.0016	0.002	0.002	0.0024	0.0028	0.0031	0.0039	0.0043
0.0008	0.0008	0.0012	0.0012	0.0016	0.002	0.002	0.0024	0.0028	0.0031	0.0039	0.0043
0.0008	0.0008	0.0012	0.0012	0.0016	0.002	0.002	0.0024	0.0028	0.0031	0.0039	0.0043
0.0008	0.0008	0.0012	0.0012	0.0016	0.002	0.002	0.0024	0.0028	0.0031	0.0039	0.0043
0.0008	0.0008	0.0012	0.0012	0.0016	0.002	0.002	0.0024	0.0028	0.0031	0.0039	0.0043
0.0012	0.0016	0.0016	0.0024	0.0028	0.0031	0.0035	0.0043	0.0047	0.0059	0.0071	0.0083
0.0012	0.0016	0.0016	0.0024	0.0028	0.0031	0.0035	0.0043	0.0047	0.0059	0.0071	0.0083
0.0012	0.0016	0.0016	0.0024	0.0028	0.0031	0.0035	0.0043	0.0047	0.0059	0.0071	0.0083
0.0012	0.0016	0.0016	0.0024	0.0028	0.0031	0.0035	0.0043	0.0047	0.0059	0.0071	0.0083
0.0012	0.0016	0.0016	0.0024	0.0028	0.0031	0.0035	0.0043	0.0047	0.0059	0.0071	0.0083
0.0012	0.0016	0.0016	0.0024	0.0028	0.0031	0.0035	0.0043	0.0047	0.0059	0.0071	0.0083
0.0012	0.0016	0.0016	0.0024	0.0028	0.0031	0.0035	0.0043	0.0047	0.0059	0.0071	0.0083
0.0012	0.0016	0.0016	0.0024	0.0028	0.0031	0.0035	0.0043	0.0047	0.0059	0.0071	0.0083
0.0012	0.0016	0.0016	0.0024	0.0028	0.0031	0.0035	0.0043	0.0047	0.0059	0.0071	0.0083
0.0008	0.0008	0.0012	0.0012	0.0016	0.002	0.002	0.0024	0.0028	0.0031	0.0039	0.0047
0.0008	0.0008	0.0012	0.0012	0.0016	0.002	0.002	0.0024	0.0028	0.0031	0.0039	0.0047
0.002	0.0024	0.0028	0.0035	0.0039	0.0043	0.0047	0.0051	0.0059	0.0071	0.0087	0.0098
0.0008	0.0008	0.0008	0.0012	0.0012	0.0012	0.0012	0.0016	0.0016	0.0016	0.002	0.002
0.0008	0.0008	0.0008	0.0012	0.0012	0.0012	0.0012	0.0016	0.0016	0.0016	0.002	0.002
0.0008	0.0008	0.0008	0.0012	0.0012	0.0012	0.0012	0.0016	0.0016	0.0016	0.002	0.002

With long edge, reduce feed rate to 40%.

Grade
Insert
Ext. Toolholder
Int. Toolholder
Threading
Grooving
Miniature Tool
Milling Cutter
Endmill
Drilling Tool
Tooling System
User's Guide
Index





MTECS Small Diameter, Short type

Thread Milling - Recommended Procedure

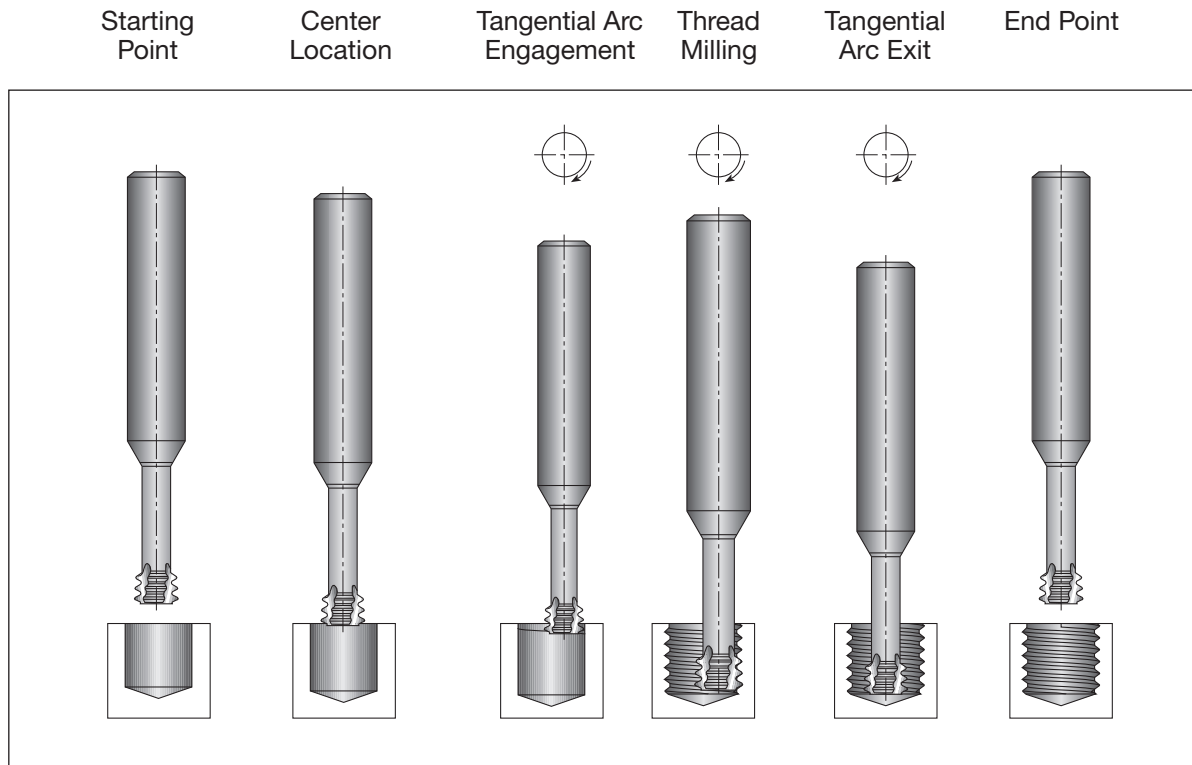

STANDARD CUTTING CONDITIONS

ISO	Material	Cutting speed (sfm)	Feed (ipr)												
			ø0.059" (ø1.5 mm)	ø0.079" (ø2 mm)	ø0.118" (ø3 mm)	ø0.157" (ø4 mm)	ø0.197" (ø5 mm)	ø0.236" (ø6 mm)	ø0.276" (ø7 mm)	ø0.315" (ø8 mm)	ø0.354" (ø9 mm)	ø0.394" (ø10 mm)	ø0.472" (ø12 mm)	ø0.551" (ø14 mm)	ø0.591" (ø15 mm)
P	Low & medium carbon steels	197 - 394	0.002	0.002	0.0028	0.0035	0.0043	0.0051	0.0055	0.0059	0.0063	0.0063	0.0067	0.0071	0.0071
	High carbon steels	197 - 295	0.0016	0.002	0.0024	0.0031	0.0035	0.0039	0.0047	0.0051	0.0055	0.0055	0.0063	0.0067	0.0071
	Alloy steels, treated steels	164 - 262	0.0016	0.0016	0.002	0.002	0.0024	0.0028	0.0028	0.0031	0.0035	0.0039	0.0047	0.0051	0.0055
	Cast steels	230 - 295	0.0016	0.0016	0.002	0.002	0.0024	0.0028	0.0028	0.0031	0.0035	0.0039	0.0047	0.0051	0.0055
M	Stainless steels	197 - 295	0.0012	0.0012	0.0016	0.002	0.0024	0.0024	0.0028	0.0031	0.0035	0.0039	0.0043	0.0047	0.0051
S	Nickel alloys, titanium alloys	66 - 131	0.0012	0.0012	0.0016	0.0016	0.002	0.0024	0.0024	0.0024	0.0028	0.0028	0.0028	0.0031	0.0031
K	Cast iron	131 - 262	0.002	0.002	0.0028	0.0035	0.0043	0.0051	0.0055	0.0059	0.0063	0.0063	0.0067	0.0071	0.0071
N	Aluminum	262 - 492	0.002	0.002	0.0028	0.0035	0.0043	0.0051	0.0055	0.0059	0.0063	0.0063	0.0067	0.0071	0.0071
	Synthetics, duroplastics, thermoplastics	164 - 656	0.0039	0.0043	0.0047	0.0055	0.0063	0.0071	0.0075	0.0075	0.0075	0.0075	0.0075	0.0079	0.0079

MTECS Small Diameter, Short type

SolidThread MTECS is used for the production of small internal threads. These thread mills feature a short 3-tooth cutting zone with 3 flutes and a released neck between the cutting zone and the shank.

This unique tool design offers very precise profiles and a high performance AH725 submicron carbide grade with PVD titanium aluminum nitride coating. The very short profile exerts a low force which minimizes tool bending. This facilitates parallel and high thread precision for the entire length.



Compared to taps, the **SOLIDTHREAD** is more accurate, thread machining is substantially faster and there is no danger of a broken tap being stuck in the hole.

SolidThread vs. Tap

Criteria	Thread mill	Taps
Thread surface quality	High	Medium
Thread geometry	Very accurate	Medium
Thread tolerance	4H, 5H, 6H with std. cutter	6H with standard tap, 4H with special tap
Machining time	Shorter or same as tap	Short
Machining load	Very low	High
Range of thread diameters	Wide range of diameters	Specific tap for each thread size
Right-/Left-hand threading	Same cutter	Specific tap for right- and left-hand
Geometric shape	Full profile	Partial profile

Features

- Minimum thread size of MTECS: **M1x0.25** (0.75 mm pre hole diameter) up to M20x2.50
- 2xD and 3xD threading lengths
- High cutting speeds
- Short cycle time
- Low cutting forces due to the short contact profile resulting in accurate and parallel thread
- Prevents oval threads near thin walls
- No more dealing with broken taps
- Reliable threading in blind holes
- Excellent performance on hardened steel, high temperature alloys and titanium



THREADMILLING

Thread milling cutter

Indexable thread milling cutter, long edge

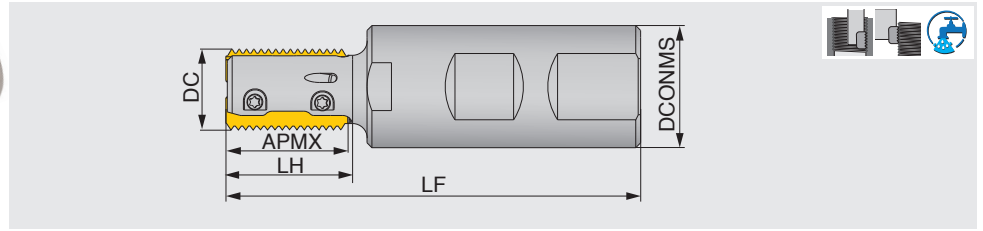

Metric	DC	APMX	CICT	DCONMS	LH	LF	Oil hole	Insert
ETTL25M017W25.0F026R02 ⁽¹⁾	17	25	2	25	26	85	With	TL25D...
ETTL25M017W25.0F036R02 ⁽¹⁾	17	25	2	25	36	95	With	TL25D...
ETTL25M019W25.0F032R02	19	25	2	25	32	92	With	TL25D...
ETTL25M019W25.0F044R02	19	25	2	25	44	104	With	TL25D...
ETTL25M021W25.0F037R03	20.5	25	3	25	37	96	With	TL25D...
ETTL25M021W25.0F044R03	20.5	25	3	25	44	103	With	TL25D...
ETTL25M022W25.0F043R03	22	25	3	25	43	102	With	TL25D...
ETTL25M022W25.0F055R03	22	25	3	25	55	114	With	TL25D...
ETTL25M030W25.0F055R05	30	25	5	25	55	115	With	TL25D...

(1) Inserts with a thread pitch of ≥ 3 mm or ≥ 8 TPI are not mountable.

SPARE PARTS

Designation	Clamping screw	Wrench
ETTL25...	SSTM4-3.6P	T-8D

INSERT

TL25D...

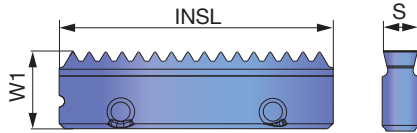

P	Steel	★
M	Stainless	☆
K	Cast iron	☆
N	Non-ferrous	☆
S	Superalloys	★
H	Hard materials	★

★ : First choice
☆ : Second choice

Thread type	Application	Designation	Pitch	Threads per inch	Number of threads per edge	Coated			INSL	W1	S
						AH725					
ISO Metric	Internal	TL25DIR1.5ISO	1.5	-	16	●			0.984	0.276	0.122
		TL25DIR2.0ISO	2	-	12	●			0.984	0.276	0.122
		TL25DIR3.0ISO ⁽²⁾	3	-	8	●			0.984	0.276	0.122
Unified	Internal	TL25DIR20UN	-	20	19	●			0.984	0.276	0.122
		TL25DIR12UN	-	12	11	●			0.984	0.276	0.122
		TL25DIR9UN	-	9	8	●			0.984	0.276	0.122
		TL25DIR8UN ⁽²⁾	-	8	7	●			0.984	0.276	0.122
Whitworth	Internal and external	TL25DEIR14W	-	14	13	●			0.984	0.276	0.122
		TL25DEIR11W	-	11	10	●			0.984	0.276	0.122

(2) Does not fit the DC 17 holder

● : Line up

Reference pages: Standard cutting conditions → **H213**

THREADMILLING

Thread milling cutter

Indexable thread milling cutter, long edge for Taper threads

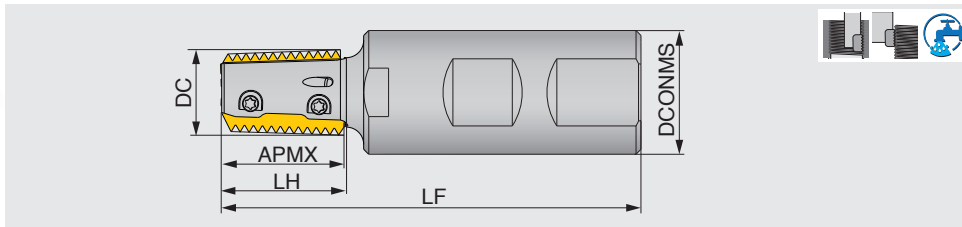

Metric	DC	APMX	CICT	DCONMS	LH	LF	Oil hole	Insert
ETTL25M017W25.0F026R02-PT	17.47	25	2	25	25.5	85	With	TL25SEIR...
ETTL25M022W25.0F043R03-PT	22.2	25	3	25	43	102	With	TL25SEIR...

SPARE PARTS

Designation	Clamping screw	Wrench
ETTL...-PT	SSTM4-3.6P	T-8D

INSERT

TL25SEIR...

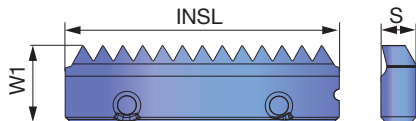

P	Steel	★
M	Stainless	☆
K	Cast iron	☆
N	Non-ferrous	☆
S	Superalloys	★
H	Hard materials	★

★ : First choice
☆ : Second choice

Thread type	Application	Designation	Pitch	Threads per inch	Number of threads per edge	Coated			INSL	W1	S
						AH725					
BSPT	Internal and external	TL25SEIR14BSPT	-	14	13	●			0.984	0.276	0.122
		TL25SEIR11BSPT	-	11	10	●			0.984	0.276	0.122
NPT	Internal and external	TL25SEIR14NPT	-	14	13	●			0.984	0.276	0.122
		TL25SEIR11.5NPT	-	11.5	11	●			0.984	0.276	0.122
NPTF	Internal and external	TL25SEIR14NPTF	-	14	13	●			0.984	0.276	0.122

● : Line up

Reference pages: Standard cutting conditions → H213



THREADMILLING

Thread milling cutter

Indexable thread milling cutter, long edge type

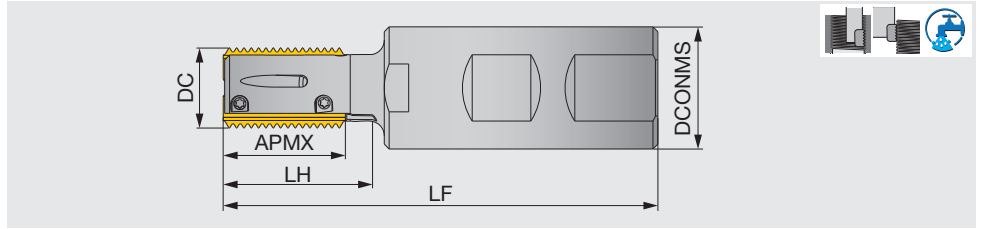

Metric	DC	APMX	CICT	DCONMS	LH	LF	Coolant hole	Insert
ETLN25M017W25.0F026R02 ⁽¹⁾	17	25	2	25	26	85	With	LN25....
ETLN25M017W25.0F036R02 ⁽¹⁾	17	25	2	25	36	95	With	LN25....
ETLN25M019W25.0F032R02	19	25	2	25	32	92	With	LN25....
ETLN25M019W25.0F044R02	19	25	2	25	44	104	With	LN25....
ETLN25M021W25.0F037R03	20.5	25	3	25	37	96	With	LN25....
ETLN25M021W25.0F044R03	20.5	25	3	25	44	103	With	LN25....
ETLN25M022W25.0F043R03	22	25	3	25	43	102	With	LN25....
ETLN25M022W25.0F055R03	22	25	3	25	55	114	With	LN25....
ETLN25M030W25.0F055R05	30	25	5	25	55	115	With	LN25....

SPARE PARTS

Designation	Clamping screw	Wrench
ETLN25...	SSTM3-3	T-6F

* Recommended clamping torque: SSTM3-3 = 1 N·m

(1) Inserts with a thread pitch of ≥ 3 mm or ≥ 8 TPI do not fit.

INSERT

LN25...

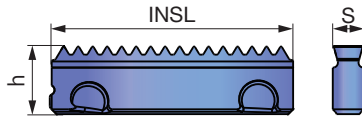

P Steel	★	
M Stainless	☆	
K Cast iron	☆	
N Non-ferrous	☆	
S Superalloys	★	
H Hard materials	★	

★ : First choice
☆ : Second choice

Thread type	Application	Designation	Pitch	Threads per inch	Coated			INSL	h	S
					AH725					
ISO Metric	Internal	LN25DIR1.5ISO	1.5	-	●			0.984	0.276	0.122
		LN25DIR2.0ISO	2	-	●			0.984	0.276	0.122
		LN25DIR3.0ISO ⁽²⁾	3	-	●			0.984	0.276	0.122
Unified	Internal	LN25DIR20UN	-	20	●			0.984	0.276	0.122
		LN25DIR12UN	-	12	●			0.984	0.276	0.122
		LN25DIR8UN ⁽²⁾	-	8	●			0.984	0.276	0.122
Whitworth	Internal and external	LN25DEIR14W	-	14	●			0.984	0.276	0.122
		LN25DEIR11W	-	11	●			0.984	0.276	0.122

(2) Does not fit the DC 17 holder

● : Line up

Reference pages: Standard cutting conditions → **H213**

STANDARD CUTTING CONDITIONS

ISO	Workpiece material	Grades	Cutting speed V_c (sfm)	Feed per tooth f_z (ipt)
P	Low carbon steel	AH725	328 - 656	0.004 - 0.012
	High carbon steel	AH725	230 - 492	0.004 - 0.012
	High carbon steels	AH725	230 - 558	0.004 - 0.012
	Cast steel	AH725	230 - 558	0.004 - 0.012
M	Stainless steel	AH725	295 - 459	0.004 - 0.012
K	Cast iron	AH725	197 - 427	0.002 - 0.012
N	Aluminum alloys	AH725	262 - 1312	0.004 - 0.016
S	Heat-resistant alloys	AH725	33 - 98	0.001 - 0.004
	Titanium alloy	AH725	66 - 295	0.001 - 0.004

Climb milling is recommended.

Insert installation

1. Use airgun or rag to thoroughly clean all the insert pockets free from dust or chips.
2. Lightly tighten Screw "A" first, then Screw "B" until the insert becomes stationary.
3. Lightly tighten the screws for other insert(s) in the same matter as mentioned in #2 above.
4. Firmly tighten Screw "A", then Screw "B".
Use the recommended torque strengths when tightening the screws.
5. Firmly tighten the screws for other insert(s) in the same manner as mentioned in #4 above.
6. Inspect to make sure there is no gap between the insert and the insert seat. Measure the radial runout before use.

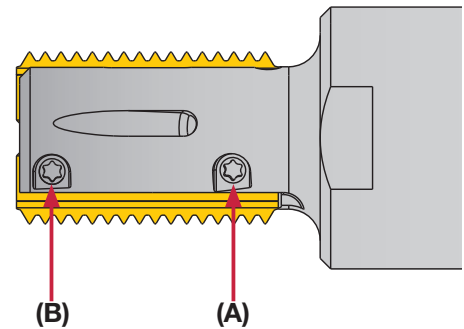

THREADMILLING

Thread milling cutter

Indexable thread milling cutter, single tooth

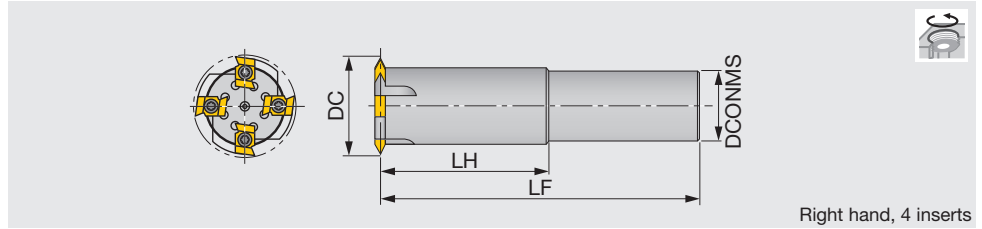

Right hand, 4 inserts

Metric	DC	CICT	DCONMS	LH	LF	Range of internal thread	Insert
D23-D25-45R	23	1	25	45	115	M28 - M30	T1-R...
D25-D25-45R	25	1	25	45	115	M32 - M42	T1-R...
D38-D32-85R	38	2	32	85	165	M45 - M56	T1-R...
D50-D42-100R	50	4	42	100	190	M58 - M68	T1-R...
D55-D42-100R	55	4	42	100	190	M64 - M85	T2-R...
D60-D42-100R	60	4	42	100	190	M70 - M85	T2-R...
D80-D42-100R	80	6	42	100	190	M90 -	T2-R...

SPARE PARTS

Designation	Clamping screw	Wrench
D23-D25... - D50-D42...	CSTB-4	T-15F
D55-D42... - D80-D42...	CSTB-5	T-20F

* Recommended clamping torque : CSTB-4 = 3.5 N-m, CSTB-5 = 5 N-m

INSERT

T*-R...

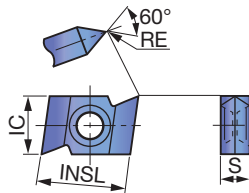

	P Steel	M Stainless	K Cast iron	N Non-ferrous	S Superalloys	H Hard materials
★	★					
☆						

★ : First choice
☆ : Second choice

Designation	RE	Coated						INSL	IC	S
		GH330								
T1-R14	0.14	●						0.567	0.375	0.187
T1-R28	0.28	●						0.567	0.375	0.187
T2-R14	0.14	●						0.701	0.500	0.250
T2-R28	0.28	●						0.701	0.500	0.250

● : Line up

Reference pages: Standard cutting conditions → H215

STANDARD CUTTING CONDITIONS

ISO	Workpiece material	Grades	Cutting speed Vc (sfm)	Feed per tooth fz (ipt)
P	Mild steels / Unhardened steels < 200HB	GH330	490 - 660	0.012 - 0.016
	Carbon steels / Alloy steels < 300HB	GH330	490 - 660	0.007 - 0.010
	Die steels < 50HRC	GH330	100 - 160	0.006 - 0.008
M	Stainless steels < 300HB	GH330	270 - 400	0.002 - 0.005

Climb milling is recommended.

When threading a blind hole, use the right hand cutter in right-hand rotation. Cut up from the bottom to prevent chip recutting.

THREADING MILLS AND APPLICABLE THREADS

Cutter dia.	Applicable Thread						Minor diameter of max. pitch thread	
	Thread type	Coarse screw thread	Fine screw thread				Coarse screw thread	Fine screw thread
D23 X 1 tooth T1-type of inserts	M28				2	1.5		25.835
	M30	3.5			3	2	26.211	
D25 X 1 tooth T1-type of inserts	M32				2	1.5		29.835
	M33	3.5			3	2	29.211	
	M35					1.5		33.376
	M36	4			3	2	31.670	
	M38					1.5		36.376
	M39	4			3	2	34.670	
	M40				3	2	1.5	36.752
D38 X 2 teeth T1-type of inserts	M42	4.5	4	3	2	1.5	37.129	
	M45			3	2	1.5		40.152
	M48		4	3	2	1.5		43.670
	M50			3	2	1.5		46.752
	M52		4	3	2	1.5		47.670
	M55		4	3	2	1.5		50.670
D50 X 4 teeth T1-type of inserts	M56		4	3	2	1.5		51.670
	M58		4	3	2	1.5		53.670
	M60		4	3	2	1.5		55.670
	M62		4	3	2	1.5		57.670
	M64		4	3	2	1.5		59.670
	M65		4	3	2	1.5		60.670
D55 X 4 teeth T2-type of inserts	M68	6	4	3	2	1.5	61.505	
	M70		4	3	2	1.5		63.505
	M72	6	4	3	2	1.5		65.505
D60 X 4 teeth T2-type of inserts	M75		4	3	2	1.5		70.670
	M76	6	4	3	2	1.5		69.505
	M78				2			75.835
	M80	6	4	3	2	1.5		73.505
	M82				2			79.835
	M85	6	4	3	2			78.505
	D80 X 6 teeth T2-type of inserts	M90		6	4	3	2	
M95			6	4	3	2		88.505

(Unit: mm)





E VX

Multi purpose endmill, shank type, with center cutting edge

Standard type GAMP = +2°~ +5°, GAMF = -10°~ -3.5°
 Long type GAMP = +5°, GAMF = -4°~ -2°

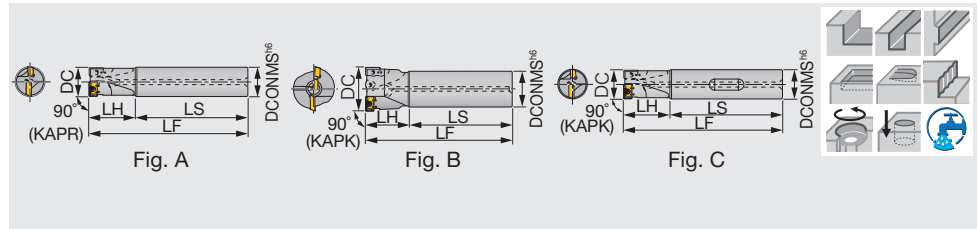

Inch	APMX	DC	CICT	DCONMS	LS	LH	LF	Coolant hole	Fig.	Insert
E VX08062RSU	0.276	0.625	2	0.625	1.906	1.250	3.156	With	C	XXMU08...
E VX10020RSU	0.276	0.787	2	0.750	2.031	1.250	3.281	With	C	XXMU10...
E VX12100RSU	0.276	1.000	2	1.000	2.281	1.625	3.906	With	C	XXMU12...
E VX16125RSU	0.276	1.250	2	1.250	2.281	2.000	4.281	Without	C	XXMU16...
E VX08062RLHU	0.276	0.625	2	0.625	5.375	1.625	7.000	With	A	XXMU08...
E VX10020RLHU	0.276	0.787	2	0.750	5.500	2.000	7.500	Without	A	XXMU10...
E VX12100RLHU	0.354	1.000	2	1.000	6.000	2.750	8.750	With	A	XXMU12...
E VX16125RLHU	0.354	1.250	2	1.250	6.750	3.250	10.000	With	A	XXMU16...

Metric	APMX	DC	CICT	DCONMS	LS	LH	LF	Coolant hole	Fig.	Insert
E VX08016RSA	7	16	2	16	90	30	120	With	A	XXMU08...
E VX08016RS	7	16	2	16	90	30	120	Without	A	XXMU08...
E VX08016RLA	7	16	2	16	135	40	175	With	A	XXMU08...
E VX08016RL	7	16	2	16	135	40	175	Without	A	XXMU08...
E VX10020RSA	9	20	2	20	90	30	120	With	A	XXMU10...
E VX10020RS	9	20	2	20	90	30	120	Without	A	XXMU10...
E VX10020RLA	9	20	2	20	135	50	185	With	A	XXMU10...
E VX10020RL	9	20	2	20	135	50	185	Without	A	XXMU10...
E VX12025RSA	11.5	25	2	25	100	40	140	With	A	XXMU12...
E VX12025RS	11.5	25	2	25	100	40	140	Without	A	XXMU12...
E VX12025RLA	11.5	25	2	25	150	70	220	With	A	XXMU12...
E VX12025RL	11.5	25	2	25	150	70	220	Without	A	XXMU12...
E VX16032RSA	15	32	2	32	110	50	160	With	A	XXMU16...
E VX16032RS	15	32	2	32	110	50	160	Without	A	XXMU16...
E VX16032RLA	15	32	2	32	175	80	255	With	A	XXMU16...
E VX16032RL	15	32	2	32	175	80	255	Without	A	XXMU16...
E VX12040RSA	11.5	40	2	42	120	60	180	With	B	XXMU12, WCMT05...
E VX12040RS	11.5	40	2	42	120	60	180	Without	B	XXMU12, WCMT05...
E VX12040RLA	11.5	40	2	42	210	100	310	With	B	XXMU12, WCMT05...
E VX12040RL	11.5	40	2	42	210	100	310	Without	B	XXMU12, WCMT05...
E VX16050RSA	15	50	2	42	160	50	210	With	B	XXMU16, WCMT06...
E VX16050RS	15	50	2	42	160	50	210	Without	B	XXMU16, WCMT06...
E VX16050RLA	15	50	2	42	310	50	360	With	B	XXMU16, WCMT06...
E VX16050RL	15	50	2	42	310	50	360	Without	B	XXMU16, WCMT06...
E VX16063RSA	15	63	2	42	190	50	240	With	B	XXMU16, WCMT06...
E VX16063RS	15	63	2	42	190	50	240	Without	B	XXMU16, WCMT06...
E VX16063RLA	15	63	2	42	310	50	360	With	B	XXMU16, WCMT06...
E VX16063RL	15	63	2	42	310	50	360	Without	B	XXMU16, WCMT06...

SPARE PARTS



Designation	Clamping screw 1	Clamping screw 2	Lubricant	Wrench
E VX08...	-	CSPB-2.2	M-1000	IP-7D
E VX10...	-	CSPB-2.5	M-1000	IP-8D
E VX12...	-	CSPD-3	M-1000	IP-10D
E VX16...	CSPB-3.5	-	M-1000	IP-15D

* Recommended clamping torque : CSPB-2.2 = 0.74 lbs-ft, 1 N-m, CSPB-2.5 = 0.96 lbs-ft, 1.3 N-m, CSPB-3.5 = 2.58 lbs-ft, 3.5 N-m, CSPD-3 = 1.84 lbs-ft, 2.5 N-m, CSTB-3.5D = 1.7 lbs-ft, 2.3 N-m

Reference pages: Insert, Standard cutting conditions → **H217**

INSERT

XXMU-MJ

WCMT-D4

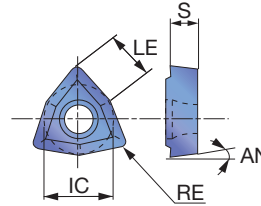
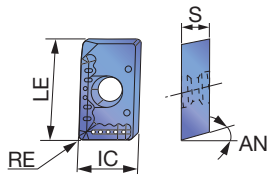

P	Steel	★	★				
M	Stainless	★		★			
K	Cast iron		★				
N	Non-ferrous						
S	Superalloys						
H	Hard materials	★					

★ : First choice
☆ : Second choice

Designation	RE	Coated			LE	IC	S	AN
		AH3135	AH120	AH140				
XXMU08T204PR-MJ	0.016	●	●	●	0.323	0.220	0.109	10°
XXMU10H308PR-MJ	0.031	●	●	●	0.417	0.268	0.138	11°
XXMU12X408PR-MJ	0.031	●	●	●	0.520	0.311	0.165	11°
XXMU16X508PR-MJ	0.031	●	●	●	0.661	0.437	0.197	11°
WCMT050308-D4	0.031		●	●	0.213	0.313	0.125	7°
WCMT06T308-D4	0.031		●	●	0.256	0.375	0.156	7°

● : Line up

STANDARD CUTTING CONDITIONS

ISO	Workpiece material	Grade	Tool diameter: $\phi 0.625'' - \phi 0.787''$			Tool diameter: $\phi 1.000'' - \phi 1.250''$		
			Cutting speed Vc (sfm)	Feed per tooth: fz (ipt)		Cutting speed Vc (sfm)	Feed per tooth: fz (ipt)	
				Slotting	Drilling		Slotting	Drilling
P	Carbon steels 1018, 1055, etc. < 300 HBt	AH3135	330 - 590	0.002 - 0.008	0.001 - 0.003	400 - 650	0.003 - 0.010	0.002 - 0.004
	Alloy steels 4140, 4340, etc. < 300 HB	AH3135	260 - 525	0.002 - 0.006	0.001 - 0.003	330 - 590	0.003 - 0.008	0.002 - 0.004
	Die steels H-13, etc. < 300 HB	AH3135	200 - 400	0.002 - 0.005	0.001 - 0.002	260 - 500	0.003 - 0.006	0.001 - 0.003
M	Stainless steels 304SS, etc.	AH3135	230 - 460	0.002 - 0.006	0.001 - 0.003	300 - 525	0.003 - 0.008	0.001 - 0.003
K	Cast irons Class 25, etc.	AH120	330 - 590	0.002 - 0.010	0.001 - 0.004	400 - 650	0.003 - 0.010	0.002 - 0.004

APPLICATION RANGE

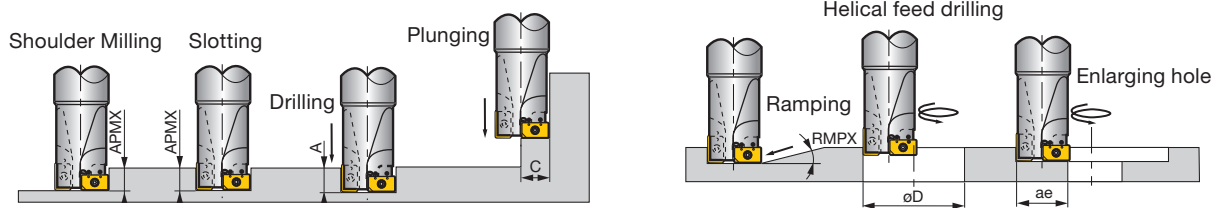

Inch	Tool dia. DC	Max. depth of cut APMX	Max. drilling depth A	Max. cutting width in plunging C	Max. ramping angle RMPX	Min. machining hole dia. ϕD_{min}	Max. machining hole dia. ϕD_{max}	Max. cutting width in enlarging hole ae
	0.625	0.276	0.315	0.315	3°	0.756	1.250	0.551
	0.750	0.354	0.394	0.394	3°	0.945	1.500	0.709
	1.000	0.453	0.492	0.492	3°	1.250	1.890	0.906
	1.250	0.591	0.630	0.630	3°	1.510	2.440	1.250

Grade
Insert
Toolholder
Ext. Toolholder
Int. Toolholder
Threading
Grooving
Miniature Tool
Milling Cutter
Endmill
Drilling Tool
Tooling System
User's Guide



ECC31

Chamfering endmill, screw clamp system, for large parallelogram inserts

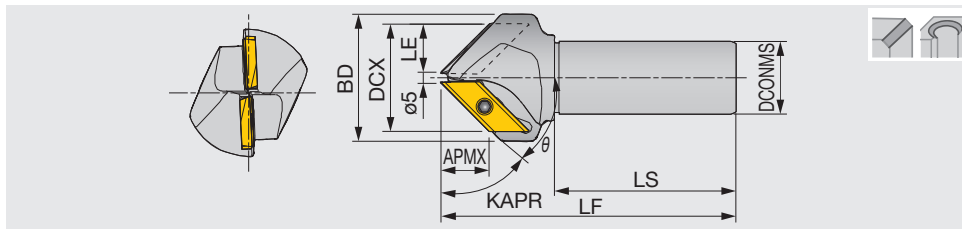

Inch	DCX	CICT	KAPR	θ	BD	LE	APMX	DCONMS	LS	LF	Insert
ECC31005RU-45	1.846	2	45°	45°	2.205	0.197	0.827	1.000	2.281	4.250	XCET3104...
ECC31005RU-30	1.338	1	60°	30°	1.575	0.197	1.004	1.000	2.281	4.250	XCET3104...
ECC31005RU-60	2.204	2	30°	60°	2.834	0.197	0.571	1.000	2.281	4.250	XCET3104...
ECC31005RU-41	1.698	2	49°	41°	2.205	0.197	0.866	1.000	2.281	4.250	XCET3104...

Metric	DCX	CICT	KAPR	θ	BD	LE	APMX	DCONMS	LS	LF	Insert
ECC31005R-30	34	1	60°	30°	40	14.5	25.5	32	80	130.2	XCET3104...
ECC31005R-45	46	2	45°	45°	56	20.5	20.5	32	80	130.1	XCET3104...
ECC31005R-60	55	2	30°	60°	72	25.5	14.5	32	80	130.1	XCET3104...

SPARE PARTS

Designation	Clamping screw	Lubricant	Wrench
ECC31...	CSTB-5S	M-1000	T-20D

* Recommended clamping torque: CSTB-5S = 3.69 lbs-ft, 5 N-m

INSERT

XCET31

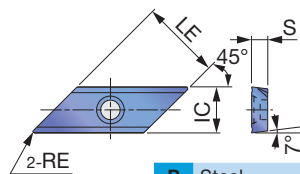

	P	M	K	N	S	H
Steel	★☆☆★	★☆☆	★☆☆	★☆☆	★☆☆	★☆☆
Stainless	★☆☆	★☆☆	★☆☆	★☆☆	★☆☆	★☆☆
Cast iron	★☆☆	★☆☆	★☆☆	★☆☆	★☆☆	★☆☆
Non-ferrous	★☆☆	★☆☆	★☆☆	★☆☆	★☆☆	★☆☆
Superalloys	★☆☆	★☆☆	★☆☆	★☆☆	★☆☆	★☆☆
Hard materials	★☆☆	★☆☆	★☆☆	★☆☆	★☆☆	★☆☆

★ : First choice
☆ : Second choice

Designation	RE	Coated					Cermet	Un-coated	LE	IC	S
		AH3135	AH330	AH120	NS740	UX30					
XCET310404ER	0.016	●	●	●	●	●		0.866	0.500	0.177	

● : Line up

STANDARD CUTTING CONDITIONS

ISO	Workpiece material	Grade	No. of revolutions: n (min-1)	Feed per tooth: fz (ipt)
P	Carbon steels 1055, etc. Alloy steels 4140, etc. < 300 HB	NS740	1000 - 3000 - 7000	0.004 - 0.010
		UX30	700 - 2000 - 4900	0.004 - 0.010
	Die steels H13, etc. < 300 HB	AH3135	1000 - 3000 - 7000	0.004 - 0.008
M	Stainless steels S30400, etc. < 250 HB	AH3135	1000 - 3000 - 7000	0.004 - 0.010
K	Cast irons No.250B, etc.	AH330	1000 - 3000 - 7000	0.004 - 0.010

- When the hole diameter to be chamfered is small or the cutting edges near the front end of tool are used, use at higher side of the revolution range shown in the Table.
In contrast, when the hole diameter to be chamfered is large or the cutting edges far from the tool's front end are used, use the lower side of the revolution range shown in the Table.

- When chamfering a small diameter hole (smaller than ø0.400") in a plungemilling mode, peck-feeding should not be used.
- When the hole diameter to be chamfered is smaller than ø0.400" or the cutting edges near the tool's front end are used, the feed should be set within 0.006 ipt.



Guidelines for programming

Z-axis plunging depth Z_d (in) in 45° chamfering of hole

Hole dia. ϕd (in)	Size of chamfering C (in)						
0.197	0.020	0.039	0.059	0.079	0.118	0.157	0.197
0.236	0.028	0.047	0.067	0.087	0.126	-	-
0.268	0.047	0.067	0.087	0.106	0.146	-	-
0.315	0.063	0.083	0.102	0.122	0.161	-	-
0.335	0.087	0.106	0.126	0.146	0.185	-	-
0.394	0.094	0.114	0.134	0.154	0.193	-	-
0.402	0.126	0.146	0.165	0.185	0.224	0.264	0.303
0.472	0.130	0.150	0.169	0.189	0.228	0.268	0.307
0.551	0.165	0.185	0.205	0.224	0.264	0.303	0.343
0.630	0.205	0.224	0.244	0.264	0.303	0.343	0.382
0.689	0.244	0.264	0.283	0.303	0.343	0.382	0.421
0.787	0.272	0.291	0.311	0.331	0.370	0.408	0.449
0.827	0.323	0.343	0.362	0.382	0.421	0.461	0.500
0.945	0.343	0.362	0.382	0.402	0.441	0.480	0.520
1.181	0.402	0.421	0.441	0.461	0.500	0.539	0.579
1.299	0.472	0.491	0.511	0.531	0.570	0.609	0.649
1.417	0.520	0.539	0.559	0.579	0.618	0.657	0.697
1.654	0.579	0.598	0.618	0.638	0.677	0.717	0.756
	0.638	0.657	0.677	0.697	0.736	0.776	-
	0.756	0.776	0.795	-	-	-	-

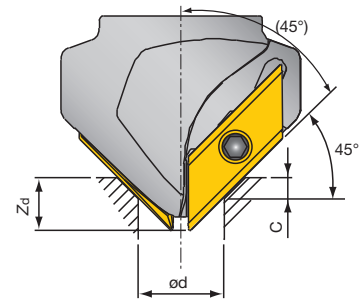

Tool: ECC31005R-45

When the hole depth is smaller than the Z-axis plunging depth (Z_d), special care should be taken to avoid an interference between the tool's front end and the bottom of the hole.

Z-axis plunging depth Z_d (in) in 30° chamfering of hole

Hole dia. ϕd (in)	Size of chamfering C (in)						
0.197	0.020	0.039	0.059	0.079	0.098	0.118	0.138
0.236	0.024	0.043	0.063	0.083	-	-	-
0.268	0.035	0.055	0.075	0.094	-	-	-
0.315	0.043	0.063	0.083	0.102	-	-	-
0.335	0.055	0.075	0.094	0.114	-	-	-
0.394	0.063	0.083	0.102	0.122	-	-	-
0.402	0.079	0.098	0.118	0.138	0.157	0.177	0.197
0.472	0.083	0.102	0.122	0.142	0.161	0.181	0.201
0.551	0.102	0.122	0.142	0.161	0.181	0.201	0.220
0.630	0.146	0.165	0.185	0.205	0.224	0.244	0.264
0.689	0.165	0.185	0.205	0.224	0.244	0.264	0.283
0.787	0.193	0.213	0.232	0.252	0.272	0.291	0.311
0.827	0.205	0.224	0.244	0.264	0.283	0.303	0.323
0.945	0.240	0.260	0.280	0.299	0.319	0.339	0.358
1.181	0.307	0.327	0.346	0.366	0.386	0.406	0.45
1.299	0.343	0.362	0.382	0.402	0.421	0.441	0.461
1.417	0.374	0.394	0.413	0.433	0.453	0.472	0.492
1.654	0.398	0.417	0.437	0.457	0.476	0.496	0.516
1.811	0.441	0.461	0.480	0.500	0.520	0.539	0.559
1.890	0.488	0.508	0.528	0.547	0.567	-	-
2.047	0.512	0.531	0.551	0.571	-	-	-
	0.555	-	-	-	-	-	-

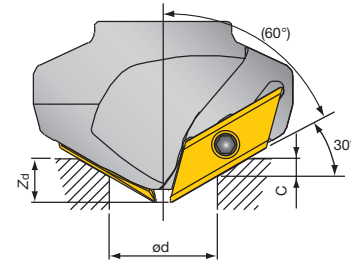

Tool: ECC31005R-60

When the hole depth is smaller than the Z-axis plunging depth (Z_d), special care should be taken to avoid an interference between the tool's front end and the bottom of the hole.

Z-axis plunging depth Z_d (in) in 60° chamfering of hole

Hole dia. ϕd (in)	Size of chamfering C (in)							
0.197	0.020	0.039	0.059	0.079	0.098	0.118	0.138	0.157
0.236	0.031	0.051	0.071	0.091	0.110	-	-	-
0.268	0.067	0.087	0.106	0.126	0.146	-	-	-
0.315	0.094	0.114	0.134	0.154	0.173	-	-	-
0.335	0.134	0.154	0.173	0.193	0.213	-	-	-
0.394	0.150	0.169	0.189	0.209	0.228	-	-	-
0.402	0.201	0.220	0.240	0.260	0.280	0.299	0.319	0.339
0.472	0.209	0.228	0.248	0.268	0.287	0.307	0.327	0.346
0.551	0.272	0.291	0.311	0.331	0.350	0.370	0.390	0.409
0.630	0.406	0.425	0.445	0.465	0.484	0.504	0.524	0.543
0.689	0.457	0.476	0.496	0.516	0.535	0.555	0.575	0.594
0.787	0.539	0.559	0.579	0.598	0.618	0.638	0.657	0.677
0.827	0.575	0.594	0.614	0.634	0.654	0.673	0.693	0.713
0.945	0.677	0.697	0.717	0.736	0.756	0.776	0.795	0.815
1.181	0.882	0.902	0.921	0.941	0.961	0.980	1.000	-
	0.980	1.000	-	-	-	-	-	-

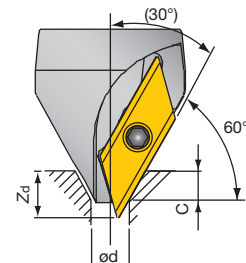

Tool: ECC31005R-30

When the hole depth is smaller than the Z-axis plunging depth (Z_d), special care should be taken to avoid an interference between the tool's front end and the bottom of the hole.



ECP4400R

Chamfering endmill, screw clamp system, for square inserts

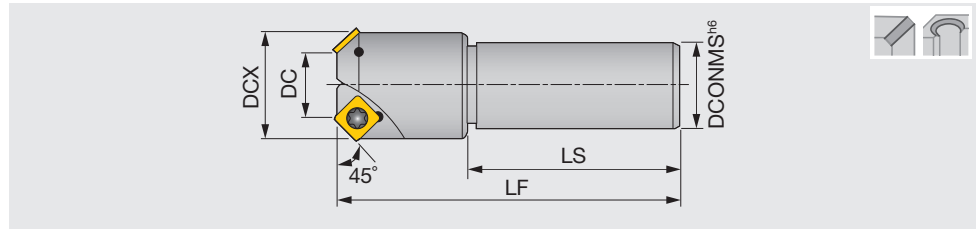

Inch	DC	CICT	DCX	DCONMS	LF	LS	Insert
ECP440AR-U	0.394	1	1.083	1.250	4.500	2.480	SPMA422*N
ECP4423R-U	0.906	2	1.587	1.250	4.500	2.480	SPMA422*N
ECP4436R-U	1.417	3	2.098	1.250	4.500	2.480	SPMA422*N
Metric	DC	CICT	DCX	DCONMS	LF	LS	Insert
ECP440AR	10	1	27.5	32	130	80	SPMA422*N
ECP4423R	23	2	40.3	32	130	80	SPMA422*N
ECP4436R	36	3	53.3	32	130	80	SPMA422*N

SPARE PARTS

Designation	Clamping screw	Wrench
ECP44...	CSTA-4	T-15D

* Recommended clamping torque: CSTA-4 = 2.58 lbs-ft, 3.5 N-m

INSERT

SPMA42

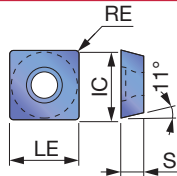

P Steel	★	☆	☆						
M Stainless									
K Cast iron				★					
N Non-ferrous									
S Superalloys									
H Hard materials									

★ : First choice
☆ : Second choice

Designation	RE	Cemet		Uncoated		LE	IC	S
		NS740	N308	UX30	TH10			
SPMA422TN	0.031	●	●	●		0.500	0.500	0.215
SPMA422FN	0.031			●		0.500	0.500	0.215

● : Line up

STANDARD CUTTING CONDITIONS

Operations	Workpiece material	Grade	Cutting speed Vc (sfm)	Maximum depth of cut ap (in)	Feed per tooth fz (ipt)
Single or double chamfering, Hole chamfering 	Carbon steels, Alloy steels < 300HB	NS740 · N308 UX30	330 - 490	-	0.008 - 0.029
	Die steels < 30HRC	NS740 · N308 UX30	164 - 230	-	0.006 - 0.016
	Cast irons	TH10	90 - 110	-	0.008 - 0.024
Facing, Grooving 	Carbon steels, Alloy steels < 300HB	NS740 · N308 UX30	330 - 490	0.118	0.004 - 0.006
	Die steels < 30HRC	UX30	164 - 230	0.079	0.004 - 0.006
	Cast irons	TH10	295 - 360	0.118	0.004 - 0.006

When chamfering stainless steel, down-milling is recommended. Conventional milling may cause edge chipping.
When chamfering above C3.0, the feed per tooth should be set at the lower side of the value shown in the above table.

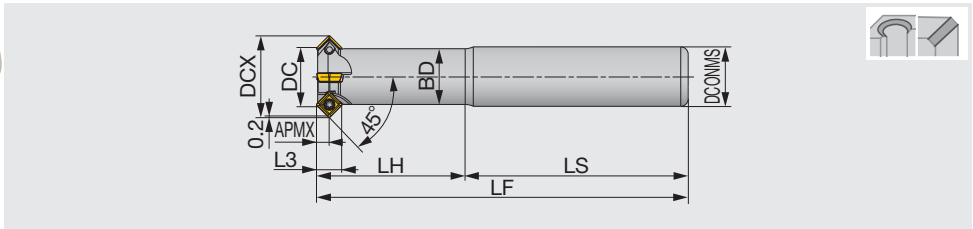

Metric	DCX	CICT	DC*	BD	APMX	DCONMS	LH	L3	LS	LF	Air hole	Insert
EASD05M006C12.0R01	12 (0.472")	1	5.7 (0.224")	7.5 (0.295")	3 (0.118")	12 (0.472")	40 (1.575")	6.8 (0.268")	60 (2.362")	100 (3.937")	Without	SD*T0502...
EASD05M008C12.0R02	14 (0.551")	2	7.8 (0.307")	9.1 (0.358")	3 (0.118")	12 (0.472")	40 (1.575")	6.8 (0.268")	60 (2.362")	100 (3.937")	Without	SD*T0502...
EASD05M016C16.0R04	22 (0.866")	4	15.7 (0.618")	15 (0.591")	3 (0.118")	16 (0.630")	40 (1.575")	6.8 (0.268")	60 (2.362")	100 (3.937")	Without	SD*T0502...

The minimum chamfering diameter (DC) measures up to the point where the insert's nose radius ends. This will offset the total tool length by shortening 0.012".

SPARE PARTS

Designation	Clamping screw	Wrench
EASD05...	CSPB-2L043	IP-6DB

*Recommended clamping torque : CSPB-2L043 = 0.7 N-m

INSERT

SDMT05-MJ

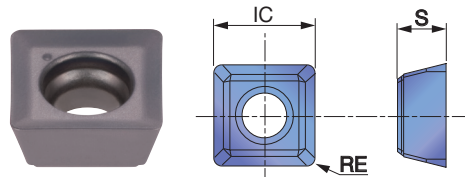

SDHT05-AJ

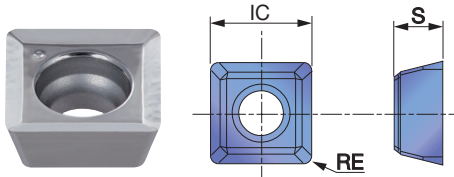

	P	M	K	N	S	H
Steel	★					
Stainless		★ ☆				
Cast iron			★			
Non-ferrous				★		
Superalloys					★	
Hard materials						

★ : First choice
☆ : Second choice

Designation	RE	APMX	Coated		TH10	S	IC
			AH140	AH725			
SDMT050204PN-MJ	0.016	0.157	●	●		0.094	0.200
SDHT050204FN-AJ	0.016	0.157			●	0.094	0.200

● : Line up

CUTTING PERFORMANCE

Chamfering & countersinking

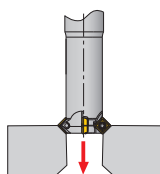

■ C2.5 (45° x 0.098")

Workpiece material: 1055

Designation	Cutting speed Vc (sfm)	Feed rate fz (in/z)
EASD05M006C12.0R01	262 - 394	0.001 - 0.003
EASD05M008C12.0R02	262 - 394	0.001 - 0.003
EASD05M016C16.0R04 (*z=2)	262 - 394	0.001 - 0.003

Interpolated chamfering

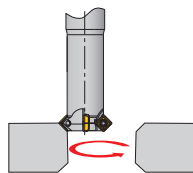

■ C2.5 (45° x 0.098")

Workpiece material: 1055

Designation	Cutting speed Vc (sfm)	Feed rate fz (in/z)
EASD05M006C12.0R01	262 - 394	0.003 - 0.005
EASD05M008C12.0R02	262 - 394	0.003 - 0.005
EASD05M016C16.0R04	262 - 394	0.003 - 0.005

Back chamfering

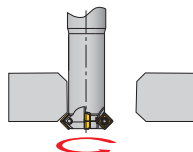

■ C1.0 (45° x 0.039")

Workpiece material: 1055

Designation	Cutting speed Vc (sfm)	Feed rate fz (in/z)
EASD05M006C12.0R01	262 - 394	0.003 - 0.005
EASD05M008C12.0R02	262 - 394	0.003 - 0.005
EASD05M016C16.0R04	262 - 394	0.003 - 0.005



Interpolated or back chamfering type

ISO	Workpiece material	Grade	Cutting speed Vc (sfm)	Feed per tooth fz (ipt)
P	Low carbon steel 1018, 1020, 1026, etc.	AH725	755 - 1050	0.002 - 0.004
	High carbon steel 1045, 1055, etc.	AH725	492 - 755	0.002 - 0.004
	Alloyed steel 4140, 8620, etc.	AH725	492 - 755	0.002 - 0.004
	Tool steel W1-8, etc.	AH725	361 - 427	0.001 - 0.004
M	Stainless steel 304SS, 316SS, 17-4 PH, etc.	AH140	328 - 656	0.001 - 0.004
K	Gray cast iron Class 25, Class 30, etc.	AH725	492 - 820	0.002 - 0.005
	Ductile cast iron 60-40-18, 60-55-06, etc.	AH725	328 - 591	0.002 - 0.005
N	Aluminum alloys Si < 13%	TH10	1148 - 1640	0.002 - 0.006
	Aluminum alloys Si ≥ 13%	TH10	328 - 656	0.002 - 0.006

Front chamfering type

ISO	Workpiece material	Grade	Cutting speed Vc (sfm)	Feed per tooth fz (ipt)
P	Low carbon steel 1018, 1020, 1026, etc.	AH725	525 - 722	0.002 - 0.004
	High carbon steel 1045, 1055, etc.	AH725	361 - 525	0.002 - 0.004
	Alloyed steel 4140, 8620, etc.	AH725	361 - 525	0.002 - 0.004
	Tool steel W1-8, etc.	AH725	262 - 295	0.001 - 0.004
M	Stainless steel 304SS, 316SS, 17-4 PH, etc.	AH140	230 - 459	0.001 - 0.004
K	Gray cast iron Class 25, Class 30, etc.	AH725	361 - 591	0.002 - 0.005
	Ductile cast iron 60-40-18, 60-55-06, etc.	AH725	230 - 427	0.002 - 0.005
N	Aluminum alloys Si < 13%	TH10	820 - 1148	0.002 - 0.006
	Aluminum alloys Si ≥ 13%	TH10	230 - 459	0.002 - 0.006

* When chamfering over C1.0 (45° x 0.039"), decrease the cutting parameters to 70% of the above parameters.

APPLICATION RANGE

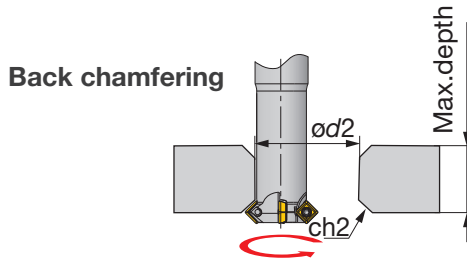
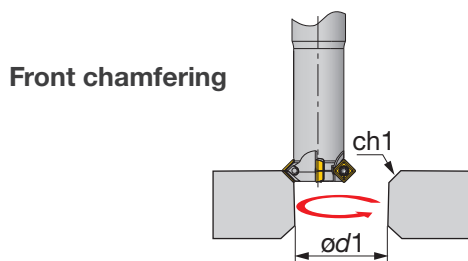

Designation	Minimum hole diameter to be chamfered (in)		Maximum chamfer dimension (at 45°) (in)		Maximum reachable hole distance when back chamfering (in)
	Front-chamfer $\phi d1$	Back-chamfer $\phi d2$	Front ch1	Back ch2	Max. depth
EASD05M006C12.0R01	0.224	0.492	0.114 x 0.114	0.079 x 0.079	0.717
EASD05M008C12.0R02	0.307	0.571	0.114 x 0.114	0.059 x 0.059	1.307
EASD05M016C16.0R04	0.622	0.886	0.114 x 0.114	0.110 x 0.110	1.701

TCB

Counterboring endmill, monoblock type

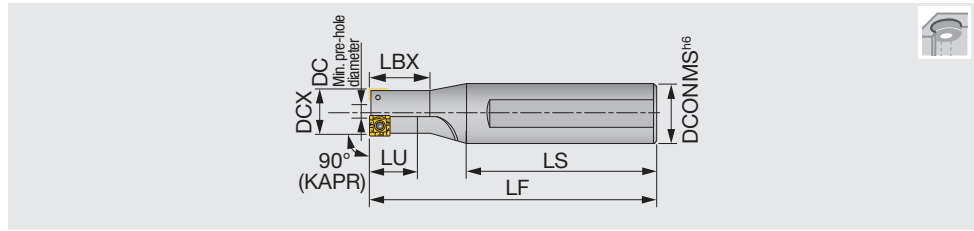

Metric	DCX	CICT	DC	LU	LBX	LF	LS	DCONMS	Insert
TCB100F16	10	1	2.8	13	17	86	60	16	SPMP771...
TCB110F16	11	1	2.8	14	18.7	87	60	16	SPMP771...
TCB120F20	12	1	3.6	15	20.5	89	60	20	SPMP771...
TCB130F20	13	2	4.5	16	22.2	91	60	20	SPMP771...
TCB-140	14	1	4	11	18	117	80	25	SPMP831...
TCB140F25	14	2	5.5	18	24	113	80	25	SPMP771...
TCB150F25	15	2	6.5	19	25.7	114	80	25	SPMP771...
TCB160F25	16	2	7.5	20	27.5	116	80	25	SPMP771...
TCB170F25	17	2	6.6	13	21	114	80	25	SPMP831...
TCB175F25	17.5	2	7.1	14	22	115	80	25	SPMP831...
TCB180F25	18	2	7.5	15	23	116	80	25	SPMP831...
TCB190F25	19	2	8.5	15	24	118	80	25	SPMP831...
TCB-200	20	2	8.2	16	25	120	80	25	SPMP042...
TCB200F25	20	2	8.2	16	25	120	80	25	SPMP042...
TCB210F25	21	2	9	17	26	122	80	25	SPMP042...
TCB220F25	22	2	10	18	28	124	80	25	SPMP042...
TCB-230	23	2	11	19	29	126	80	25	SPMP042...
TCB230F25	23	2	11	19	29	126	80	25	SPMP042...
TCB240F25	24	2	12	20	-	128	80	25	SPMP042...
TCB250F25	25	2	13	25	-	130	80	25	SPMP042...
TCB-260	26	2	14	21	33	132	80	32	SPMP042...
TCB-290	29	2	14	23	36	138	80	32	SPMM322...
TCB-320	32	2	16.9	40	-	144	80	32	SPMM322...
TCB-350	35	2	14	43	-	150	80	32	SPMM432...
TCB-390	39	2	17.9	48	-	158	80	32	SPMM432...
TCB-430	43	2	21.7	53	-	171	85	42	SPMM432...

Tool diameter tolerance	Applicable tolerance range of hole diameter
+0.2 / 0	+0.3 / 0

Countersink dimensions of bolt hole

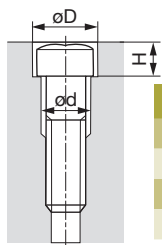

Thread size	M6	M8	M10	M12	M14	M16	M18	M20	M22	M24	M27
øD (mm)	11	14	17.5	20	23	26	29	32	35	39	43
H (mm)	6.5	8.6	10.8	13	15.2	17.5	19.5	21.5	23.5	25.5	29
ød (mm)	6	9	11	14	16	18	20	22	24	26	30
Applicable tool	TCB110	TCB140	TCB175	TCB200	TCB230	TCB260	TCB290	TCB320	TCB350	TCB390	TCB430

SPARE PARTS

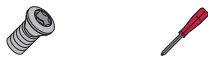

Designation	Clamping screw	Wrench
TCB100... - TCB160...	CSTB-2L040	T-6D
TCB-140...	CSTB-2.2S	T-7D
TCB170... - TCB190...	CSTB-2.2	T-7D
TCB200... - TCB260...	CSTA-NO3	T-9D
TCB-290 - TCB-320	CSTA-NO5	T-9D
TCB-350 - TCB-430	CSTA-4	T-15D

* Recommended clamping torque: CSTB-2L040 = 0.7 N·m, CSTB-2.2S, CSTB-2.2 = 1 N·m, CSTA-NO3, CSTA-NO5 = 2.3 N·m, CSTA-4 = 3.5 N·m

Reference pages: Inserts, Standard cutting conditions → [H226 - H227](#)





High Feed Milling

Face Milling

Shoulder Milling

Slot Milling

Profile Milling

Thread Milling

Other

TCB

Counterboring endmill, cartridge type

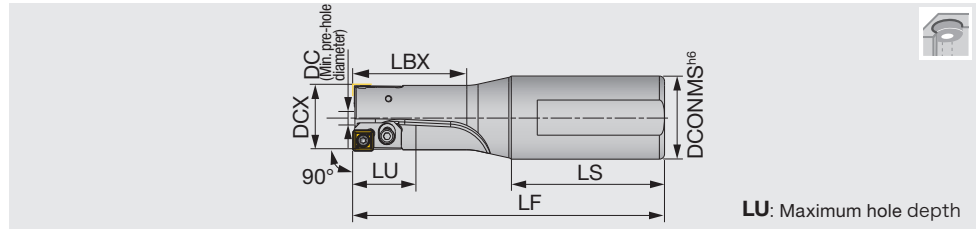

Metric	DCX	DCONMS	DC	LU	LS	LBX	LF	WT(kg)	Cartridge set Designation	Shim plate Designation	Shim plate Thickness	Insert
TCB260-290F32	26	32	13.2	40	59	43	120	0.6	TCB04CA-26-29	-	-	SPMP042...
TCB260-290F32	27	32	14.2	40	59	43	120	0.6	TCB04CA-26-29	AP16050	0.5	SPMP042...
TCB260-290F32	28	32	15.2	40	59	43	120	0.6	TCB04CA-26-29	AP16100	1	SPMP042...
TCB260-290F32	29	32	16.2	40	59	43	120	0.6	TCB04CA-26-29	AP16150	1.5	SPMP042...
TCB300-340F32	30	32	14.2	45	59	55	130	0.6	TCB32CA-30-39	-	-	SPMM322...
TCB300-340F32	31	32	15.2	45	59	55	130	0.6	TCB32CA-30-39	AP16050	0.5	SPMM322...
TCB300-340F32	32	32	16.2	45	59	55	130	0.6	TCB32CA-30-39	AP16100	1	SPMM322...
TCB300-340F32	33	32	17.2	45	59	55	130	0.6	TCB32CA-30-39	AP16150	1.5	SPMM322...
TCB300-340F32	34	32	18.2	45	59	55	130	0.6	TCB32CA-30-39	AP16200	2	SPMM322...
TCB350-390F32	35	32	19	50	59	70	140	0.7	TCB32CA-30-39	-	-	SPMM322...
TCB350-390F32	36	32	20	50	59	70	140	0.7	TCB32CA-30-39	AP16050	0.5	SPMM322...
TCB350-390F32	37	32	21	50	59	70	140	0.7	TCB32CA-30-39	AP16100	1	SPMM322...
TCB350-390F32	38	32	22	50	59	70	140	0.7	TCB32CA-30-39	AP16150	1.5	SPMM322...
TCB350-390F32	39	32	23	50	59	70	140	0.7	TCB32CA-30-39	AP16200	2	SPMM322...
TCB400-440F32	40	32	18	55	59	80	150	1	TCB43CA-40-59	-	-	SPMM432...
TCB400-440F32	41	32	19	55	59	80	150	1	TCB43CA-40-59	AP21050	0.5	SPMM432...
TCB400-440F32	42	32	20	55	59	80	150	1	TCB43CA-40-59	AP21100	1	SPMM432...
TCB400-440F32	43	32	21	55	59	80	150	1	TCB43CA-40-59	AP21150	1.5	SPMM432...
TCB400-440F32	44	32	22	55	59	80	150	1	TCB43CA-40-59	AP21200	2	SPMM432...
TCB450-490F32	45	32	23	65	59	90	160	1.2	TCB43CA-40-59	-	-	SPMM432...
TCB450-490F32	46	32	24	65	59	90	160	1.2	TCB43CA-40-59	AP21050	0.5	SPMM432...
TCB450-490F32	47	32	25	65	59	90	160	1.2	TCB43CA-40-59	AP21100	1	SPMM432...
TCB450-490F32	48	32	26	65	59	90	160	1.2	TCB43CA-40-59	AP21150	1.5	SPMM432...
TCB450-490F32	49	32	27	65	59	90	160	1.2	TCB43CA-40-59	AP21200	2	SPMM432...
TCB500-540F32	50	32	28	70	59	97	165	1.5	TCB43CA-40-59	-	-	SPMM432...
TCB500-540F32	51	32	29	70	59	97	165	1.5	TCB43CA-40-59	AP21050	0.5	SPMM432...
TCB500-540F32	52	32	30	70	59	97	165	1.5	TCB43CA-40-59	AP21100	1	SPMM432...
TCB500-540F32	53	32	31	70	59	97	165	1.5	TCB43CA-40-59	AP21150	1.5	SPMM432...
TCB500-540F32	54	32	32	70	59	97	165	1.5	TCB43CA-40-59	AP21200	2	SPMM432...
TCB550-590F32	55	32	33	75	59	105	175	1.9	TCB43CA-40-59	-	-	SPMM432...
TCB550-590F32	56	32	34	75	59	105	175	1.9	TCB43CA-40-59	AP21050	0.5	SPMM432...
TCB550-590F32	57	32	35	75	59	105	175	1.9	TCB43CA-40-59	AP21100	1	SPMM432...
TCB550-590F32	58	32	36	75	59	105	175	1.9	TCB43CA-40-59	AP21150	1.5	SPMM432...
TCB550-590F32	59	32	37	75	59	105	175	1.9	TCB43CA-40-59	AP21200	2	SPMM432...

The cartridge sets and shim plates are included.

Tool diameter tolerance	Applicable tolerance range of hole diameter
+0.2 / 0	+0.3 / 0

Countersink dimensions of bolt hole

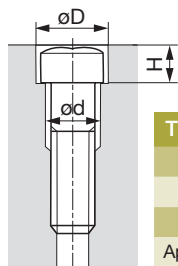

Thread size	M16	M18	M20	M22	M24	M27	M30	M33	M36
øD (mm)	26	29	32	35	39	43	48	54	58
H (mm)	17.5	19.5	21.5	23.5	25.5	29	32	35	38
ød (mm)	18	20	22	24	26	30	33	36	39
Applicable tool	TCB260	TCB290	TCB320	TCB350	TCB390	TCB430	TCB480	TCB540	TCB580

Reference pages: Inserts, Standard cutting conditions → [H226 - H227](#)

Body SPARE PARTS

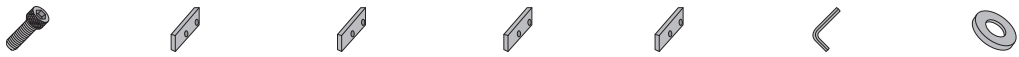

Designation	① Cartridge screw	② Shim plate	② Shim plate	② Shim plate	② Shim plate	Wrench for cartridge	③ Washer
TCB260-290F32	CM3×0.5×6	AP16050	AP16100	AP16150		P-2.5	3.2X6X0.5
TCB300-340F32	CM3×0.5×6	AP16050	AP16100	AP16150	AP16200	P-2.5	3.2X6X0.5
TCB350-390F32	CM3×0.5×6	AP16050	AP16100	AP16150	AP16200	P-2.5	3.2X6X0.5
TCB400-440F32	CM4×0.7×10	AP21050	AP21100	AP21150	AP21200	P-3	4.3X8X0.5
TCB450-490F32	CM4×0.7×10	AP21050	AP21100	AP21150	AP21200	P-3	4.3X8X0.5
TCB500-540F32	CM4×0.7×10	AP21050	AP21100	AP21150	AP21200	P-3	4.3X8X0.5
TCB550-590F32	CM4×0.7×10	AP21050	AP21100	AP21150	AP21200	P-3	4.3X8X0.5

Cartridge set SPARE PARTS



Designation	④ Insert screw	Wrench
TCB04CA-26-29	CSTA-NO3	T-9D
TCB32CA-30-39	CSTA-NO5	T-9D
TCB32CA-30-39	CSTA-NO5	T-9D
TCB43CA-40-59	CSTA-4	T-15D
TCB43CA-40-59	CSTA-4	T-15D
TCB43CA-40-59	CSTA-4	T-15D
TCB43CA-40-59	CSTA-4	T-15D

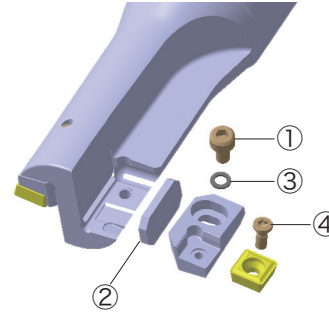

* Recommended clamping torque: CSTA-NO3 / CSTA-NO5 = 2.3 N·m, CSTA-4 = 3.5 N·m

Fine adjustment shim plates (sold separately)

SPARE PARTS

Designation	Thickness
AP16005	0.05
AP16020	0.2
AP21005	0.05
AP21020	0.2

Cautions in preparing the cartridge type cutter

- Firmly press the cartridge in the arrowed direction while tightening the screw to install the cartridge on the cutter body. (Fig.1)
- Ensure that the shim plates thickness are always the same on both sides to equalize the tool diameter.
- Ensure to locate the shim plate fit within the cartridge pocket. (Fig.2)
- Use thin shim plates (not included) for fine diameter adjustments in ± 0.1 mm increments.
- When using multiple shim plates in one pocket for a diameter adjustment, always use the thinnest shim plates at the bottom to prevent them from dislocating during machining. (Fig.3)
- Ensure that the top shim is always in contact with the rim of the cartridge pocket to prevent it from dislocation during machining. (Fig.4)



Fig.1

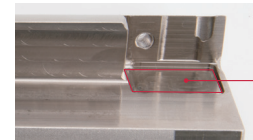

Fig.2

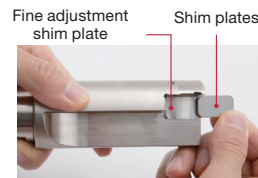

Fig.3

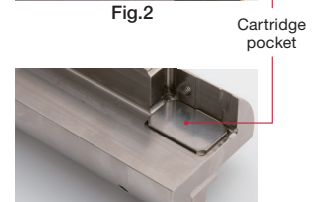

Fig.4

CUSTOM-BUILT TOOL SERVICE

Tungaloy also designs and fabricates semi-standard or tailor-made tools with the TCB inserts according to the desired tool specifications. Contact your Tungaloy representative for further details.



INSERT

SPMP/SPMM

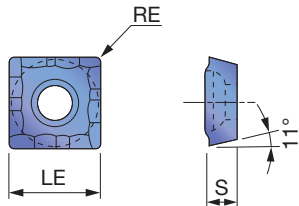

SPMP/SPMM-CG

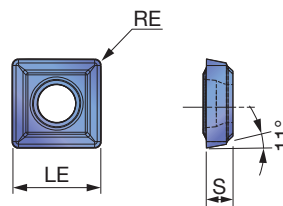

P Steel	★	★	
M Stainless	★	★	
K Cast iron	★	★	
N Non-ferrous	☆	☆	
S Superalloys	☆	☆	
H Hard materials	☆	☆	

★ : First choice
☆ : Second choice

Designation	RE	Coated		LE	S
		T313W	AH6030		
SPMP771-CG	0.157	●		2.126	0.063
SPMP831-CG	0.157	●		2.500	0.094
SPMP042ER-CG	0.315	●		3.126	0.125
SPMM322ER-CG	0.315	●		3.752	0.125
SPMM432ER-CG	0.315	●		5.000	0.187
SPMP831DS	0.157	●		2.500	0.094
SPMP042ERD	0.315	●		3.126	0.125
SPMM322ERD	0.315	●		3.752	0.125
SPMM432ERD	0.315	●		5.000	0.187

● : Line up

STANDARD CUTTING CONDITIONS

Counterboring

ISO	Workpiece material	Cutting speed Vc (sfm)	Feed : f (ipr)	
			ø10 - 12 (z = 1)	ø13 - 59 (z = 2)
P	Carbon steel	260 - 660	0.001 - 0.003	0.004 - 0.012
M	Stainless steel	260 - 490	0.001 - 0.002	0.002 - 0.006
K	Grey cast iron	260 - 660	0.002 - 0.004	0.004 - 0.016
N	Non-ferrous	330 - 980	0.002 - 0.008	0.004 - 0.016
S	Superalloys	160 - 260	0.001 - 0.002	0.002 - 0.006
H	Hard materials	160 - 260	0.001 - 0.002	0.002 - 0.006

Milling

ISO	Workpiece material	Cutting speed Vc (sfm)	Feed per tooth fz (ipt)
P	Carbon steel	260 - 660	0.002 - 0.006
M	Stainless steel	260 - 490	0.002 - 0.004
K	Grey cast iron	260 - 660	0.002 - 0.008
N	Non-ferrous	330 - 980	0.004 - 0.008
S	Superalloys	160 - 260	0.002 - 0.003
H	Hard materials	160 - 260	0.002 - 0.003

Internal boring (With one cutting edge)

ISO	Workpiece material	Cutting speed Vc (sfm)	Depth of cut ap (in)	Feed : f (ipr)
P	Carbon steel	260 - 660	0.020 -	0.002 - 0.006
M	Stainless steel	260 - 490	0.020 -	0.002 - 0.004
K	Grey cast iron	260 - 660	0.020 -	0.002 - 0.008
N	Non-ferrous	330 - 980	0.020 -	0.004 - 0.008
S	Superalloys	160 - 260	0.020 -	0.002 - 0.003
H	Hard materials	160 - 260	0.020 -	0.002 - 0.003

APPLICATION

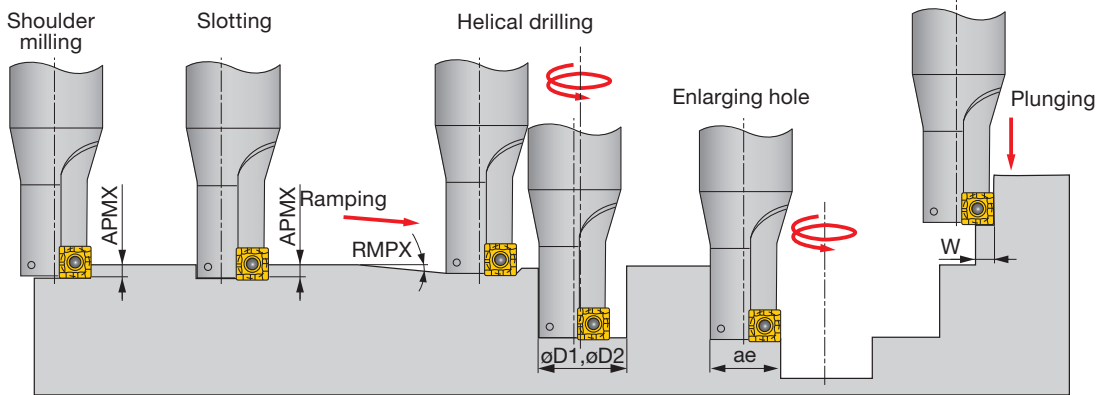

Metric	Tool dia. DCX	Max. depth of cut APMX	Max. ramping angle RMPX	Max. cutting width in plunging W	Min. machinable hole dia. øD1	Max. machinable hole dia. øD2	Max. cutting width in enlarging hole ae
TCB100F16	10	4	-	4	-	-	-
TCB110F16	11	4	2.1°	4	12	20	10
TCB120F20	12	4	2.1°	4	14	22	11
TCB130F20	13	4	2.1°	4	17	24	12
TCB-140	14	5	3°	5	20	25	13
TCB140F25	14	4	1.9°	4	19	26	13
TCB150F25	15	4	1.6°	4	21	28	14
TCB160F25	16	4	1.3°	4	23	30	15
TCB170F25	17	5	2.5°	5	25	32	16
TCB175F25	17.5	5	2.2°	5	25.5	33	16.5
TCB180F25	18	5	2°	5	26	34	17
TCB190F25	19	5	1.5°	5	27	36	18
TCB200F25	20	6	3°	6	29	38	19
TCB210F25	21	6	2.5°	6	30	40	20
TCB220F25	22	6	2°	6	31	42	21
TCB230F25	23	6	1.6°	6	32	44	22
TCB240F25	24	6	1.3°	6	33	46	23
TCB250F25	25	6	1.1°	6	34	48	24.5
TCB-260	26	6	1°	6	35	50	25
TCB-290	29	8	3°	8	37	56	28
TCB-320	32	8	2.5°	8	40	62	31
TCB-350	35	10	2.5°	10	45	68	34
TCB-390	39	10	2°	10	49	76	38
TCB-430	43	10	1.5°	10	53	84	42

The insert can be used for a maximum 2 indexings. (full 4 indexing for a plunging application.)

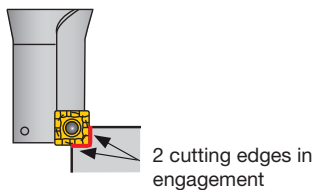

Cautions in shouldering operation

The cutter is design so that the insert provides 1° taper relief on the periphery. The wall, therefore, will be 89° when milled.

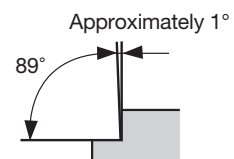

Grade
Insert
Ext. Toolholder
Int. Toolholder
Threading
Grooving
Miniature Tool
Milling Cutter
Endmill
Drilling Tool
Tooling System
User's Guide
Index



Endmill



Endmill - Content structure

- Products are listed by application.
- Endmills in the catalog are our standard stock items.

How to use the page

Method 1.

Select the tool type at the index on the right page, choose the application (1), cutting edge shape (2), and the number of cutting edges (3), and check the designation you need (6) in the dimension table (5).

1

Indexable Endmill



TUNGMEISTER
VEH...
4 flute square head, for general purpose (TungMeister)

Metric	AH725	NOF	FHA	DC	DCSfMS	APMX	RE	CRKS	LF	Wre
VEH04L06.0P10D4S05	●	4	30°	30°	8	7.7	6	0.5	508	160
VEH04L06.0P10D4S08	●	4	30°	30°	10	9.7	7	0.5	508	13
VEH12L08.0P10D4S08	●	4	30°	30°	12	11.7	9	0.5	508	16.5
VEH12L08.0P10D4S08	●	4	30°	30°	12	11.7	9	1	508	16.5
VEH12L08.0P10D4S10	●	4	30°	30°	16	15.3	12	0.5	510	20.5
VEH12L08.0P10D4S10	●	4	30°	30°	16	15.3	12	1	510	20.5
VEH20L16.0P10D4S12	●	4	30°	30°	20	18.3	15	0.5	512	25.5
VEH20L16.0P10D4S12	●	4	30°	30°	20	18.3	15	1	512	25.5

2

Application



TUNGMEISTER
VEE...-03...
3 flute square head, for general purpose (TungMeister)

Inch	AH725	NOF	FHA	DC	DCSfMS	APMX	CRKS	LF	Wre
VEE01L06F000-LC03S05	●	3	45°	0.312	0.300	0.295	505	0.590	KEYV
VEE01L27F000-LC03S08	●	3	45°	0.375	0.370	0.275	506	0.512	KEYV
VEE06L37F000-LC03S08	●	3	45°	0.500	0.488	0.374	508	0.660	KEYV

3

No. of cutting edges

4

Dimension table

Method 2.

Select the tool series name on I004 and check the details on the product page.

Main products

Indexable Endmill



TUNGMEISTER

Endmills with exchangeable heads for reduced tool change time
ø0.250" - ø1.000" (ø6 mm - ø25 mm)

I005 - I037

1004 www.tungaloy.com/us

Method 3.





























Select the application and the cutting edge shape from Quick Guide on I006 - I007, and see the details on each page.

Quick Guide **TUNGMEISTER**

Edge shape	Designation	Appearance	Application	Feature	Edge shape	No. of cutting edges	Helix angle	CRKS	Helix angle	Workpiece material	Page	
VEH**	Semi-finishing	All-around / Variable helix / Variable pitch	Corner radius	4	ø1 - ø20	305 - 870	Regular	★	★	★	★	I010
VEE**-03...	Finishing	All-around	Corner radius	3	ø1 - ø12	355 - 508	45	★	★	★	★	I010
VEE**-04... / VED**-04...	Finishing	All-around	Corner radius	4	ø1 - ø20	355 - 870	30/45	★	★	★	★	I011
VEE**-03...	Finishing	For key way / All-around	Corner radius	3	ø12 - ø18.8	355 - 870	38	★	★	★	★	I011
VEE**1...	Finishing	All-around / Variable pitch	Corner radius	4	ø1 - ø20	355 - 870	45	★	★	★	★	I012
Square VEE**R...	Roughing	All-around / Spurred / Beveled cutting edge	Chamfered	4, 5, 6	ø1 - ø20	355 - 870	45	★	★	★	★	I012
VEE**C...	Semi-finishing	All-around / Edge combination	Chamfered	4	ø1 - ø20	355 - 870	45	★	★	★	★	I013
VEE**A02...	Finishing	All-around	Corner radius	2	ø10 - ø12	358 - 508	45	★	★	★	★	I013
VEE**A03...	Finishing	All-around	Corner radius	3	ø1 - ø20	355 - 870	45	★	★	★	★	I014
VED**-06... / VEE**-06...	Finishing	All-around	Corner radius	6	ø1 - ø12	355 - 508	30/45 / 50	★	★	★	★	I014
VED**-0810... / VEE**-0810...	Finishing	All-around	Corner radius	8, 10	ø10 - ø20	510 - 870	30/50	★	★	★	★	I015
VRB**-02...	Finishing	All-around	Corner radius	2	ø10 - ø20	358 - 870	075	★	★	★	★	I015
Radius VRD**-06...	Finishing	All-around	Corner radius	6	ø1 - ø16	355 - 870	30	★	★	★	★	I016
High feed VFX**-02...	Roughing	All-around / High feed	High feed	2	ø10 - ø20	358 - 870	-	★	★	★	★	I018
High feed VFX**-04...	Roughing	All-around / High feed	High feed	4	ø12 - ø16	508 - 570	-	★	★	★	★	I018
VRB**-0M...	Roughing	All-around	Ball	3	ø1 - ø16	355 - 870	0	★	★	★	★	I019
Ball VBB**-06...	Semi-finishing	All-around	Ball	2	ø1 - ø16	355 - 870	0	★	★	★	★	I019
Ball VBD**-06... / VBE**-06...	Finishing	All-around	Ball	2	ø1 - ø16	355 - 870	30	★	★	★	★	I019
				4	ø1 - ø25	355 - 870	30/38	★	★	★	★	I020

1006 www.tungaloy.com/us

Icon

Edge shape	No. of cutting edges	Application		
 Square	 2	 Shoulder milling	 Side slotting	 Hole enlarging
 Radius	 3	 Deep shoulder milling	 Side milling	 Holemaking
 High feed	 4	 Shoulder milling (with radius)	 Pocketing	 Counterboring
 Ball	 5	 Face milling	 Ramping	 Hole chamfering
 Chamfering	 6 or more	 Slotting	 Profiling	 Chamfering
 Slotting		 Slotting (with radius)	 Plunging	 Cutting-off

4 **TUNGMEISTER**
VEH...
4 flute square head, for general purpose (TungMeister)

7

Metric	AH25	NOF	FHA	DC	DCSFMS	APMX	RE	CRKS	LF	Wrench	Torque*
VEH08L05.0R1004S05	4	35°-39°	8	7.7	5	0.5	S05	10	KEYV-S05	7	
VEH10L07.0R1004S05	4	35°-39°	10	9.7	7	0.5	S06	13	KEYV-S06	10	
VEH12L09.0R1004S05	4	35°-39°	12	11.7	9	0.5	S08	16.5	KEYV-S08	14.5	
VEH15L12.0R1004S05	4	35°-39°	15	14.7	11	0.5	S10	20.5	KEYV-S10	18	
VEH20L15.0R1004S12	4	35°-39°	20	18.3	15	0.5	S12	25.5	KEYV-S12	23	

* Torque: Recommended clamping torque Nm
2 pieces per package

6 **TUNGMEISTER**
VEE...-05...
3 flute square head, for general purpose (TungMeister)

5

Inch	AH25	NOF	FHA	DC	DCSFMS	APMX	CRKS	LF	Wrench	Torque*
VEE08L3P000-U03S05	3	45°	0.312	0.300	0.200	0.090	0.090	KEYV-S05	5.16	
VEE10L3P000-U03S06	3	45°	0.375	0.370	0.270	0.090	0.112	KEYV-S06	7.38	
VEE12L3P000-U03S08	3	45°	0.500	0.488	0.374	0.090	0.150	KEYV-S08	11.56	

* Torque: Recommended clamping torque lbs ft
2 pieces per package

10 Reference pages: Standard cutting conditions → I016 - I017
I010 www.tunggaloy.com/us

9 Slot milling (VEH, VEE: 3 flutes, VED/VEE: 4 flutes, VEE-A, VEE-I, VEE-R, VEE-C, VRB, VRC, VRD)

ISO	Workpiece material	Hardness	Cutting speed Vc (ft/min)	Feed per tooth: fz (ft)						Depth of cut ap (in)
				0.250*	0.312*	0.375*	0.500*	0.625*	0.750*	
P	Low carbon steels 1045, 1045, etc.	-	300-800	0.001-0.003	0.001-0.003	0.003-0.003	0.004-0.004	0.004-0.004	0.003-0.003	0.5 x DC
	High carbon steels 4140, 4140, etc.	-	300-460	0.001-0.003	0.001-0.003	0.003-0.003	0.004-0.004	0.004-0.004	0.003-0.003	0.5 x DC
M	Phenolic steel P45, N4085, etc.	-	30-40	0.001-0.003	0.001-0.003	0.003-0.003	0.004-0.004	0.004-0.004	0.003-0.003	0.5 x DC
	Stainless steels 30400, 021602, etc.	-	200-400	0.001-0.003	0.001-0.003	0.003-0.003	0.004-0.004	0.004-0.004	0.003-0.003	0.5 x DC
K	Gray cast iron No.2000, No.3000, etc.	-	150-250	0.001-0.003	0.001-0.003	0.003-0.003	0.004-0.004	0.004-0.004	0.003-0.003	0.5 x DC
	Ductile cast iron 60-40-18, etc.	-	150-250	0.001-0.003	0.001-0.003	0.003-0.003	0.004-0.004	0.004-0.004	0.003-0.003	0.5 x DC
N	Aluminum alloys Ti-6Al-4V, etc.	-	660-2297	0.001-0.003	0.001-0.003	0.003-0.003	0.004-0.004	0.004-0.004	0.003-0.003	0.5 x DC
	Titanium alloys Ti-6Al-4V, etc.	-	130-260	0.001-0.003	0.001-0.003	0.003-0.003	0.004-0.004	0.004-0.004	0.003-0.003	0.5 x DC
S	Heat-resistant alloys Inconel 718, etc.	-	66-130	0.001-0.003	0.001-0.003	0.003-0.003	0.004-0.004	0.004-0.004	0.003-0.003	0.5 x DC
	Hardened steel H13, etc.	-	40-50	0.001-0.003	0.001-0.003	0.003-0.003	0.004-0.004	0.004-0.004	0.003-0.003	0.2 x DC
H	Hardened steel D2, etc.	-	50-160	0.001-0.003	0.001-0.003	0.003-0.003	0.004-0.004	0.004-0.004	0.003-0.003	0.2 x DC
		-	66-200	0.001-0.003	0.001-0.003	0.003-0.003	0.004-0.004	0.004-0.004	0.003-0.003	0.2 x DC

Shoulder milling (VED / VEE: 6 flutes, VED / VEE: 8, 10 flutes)

ISO	Workpiece material	Hardness	Cutting speed Vc (ft/min)	Feed per tooth: fz (ft)						Depth of cut ap (in)	Pick feed P (in)
				0.312*	0.375*	0.500*	0.625*	0.750*	1.000*		
S	Titanium alloys Ti-6Al-4V, etc.	-	200-400	0.002-0.004	0.002-0.003	0.003-0.003	0.004-0.004	0.004-0.004	0.004-0.004	0.6 x DC	0.02 x DC
	Heat-resistant alloys Inconel 718, etc.	-	100-200	0.002-0.004	0.002-0.003	0.003-0.003	0.004-0.004	0.004-0.004	0.004-0.004	0.6 x DC	0.02 x DC
H	Hardened steel H13, H19, etc.	-	40-50	0.002-0.004	0.002-0.003	0.003-0.003	0.004-0.004	0.004-0.004	0.004-0.004	0.6 x DC	0.02 x DC
	Hardened steel D2, etc.	-	50-160	0.002-0.004	0.002-0.003	0.003-0.003	0.004-0.004	0.004-0.004	0.004-0.004	0.6 x DC	0.02 x DC

Tunggaloy I017

- 1 : Application
- 2 : Cutting edge shape
- 3 : Number of cutting edges
- 4 : Endmill series name
- 5 : Dimension table
- 6 : Endmill designation
- 7 : Dimension drawing (conforming to ISO13399)
- 8 : Spare parts
- 9 : Standard cutting conditions
- 10 : Reference page

Machining accuracy

- F Finishing
- M Medium cutting
- R Roughing



Coolant hole

Workpiece material

- P Steel
- M Stainless steel
- K Cast iron
- N Non-ferrous metal
- S Superalloy
- H Hard material

When ordering

- Please specify the designation and quantity for TungMeister heads.
e.g. **VEE08L05.0R00-3S05** ... 2 (two heads per package)
- Please specify the designation and quantity for TungMeister shanks.
e.g. **VSSD08L060805-S** ... 1 (one shank per package)

*Wrenches for TungMeister are sold separately.

Indexable Endmill



TUNGMEISTER

Endmills with exchangeable heads
for reduced tool change time
ø0.250" - ø1.000" (ø6 mm - ø25 mm)



I005 - I037



P M K N S H

Inch Metric



Choose the best head-shank combination **for more efficiency!**
Minimize setup time while **maximizing productivity!**

1 Wide range of cutting heads
23 kinds of cutting heads are available. The head exchange is easy and highly accurate with the precision thread.

Flexible combinations

TungMeister can be applied to all kinds of endmill machining applications.

2 Three kinds of shank material

Users can choose the most suitable combination according to the machining parameters, length and rigidity required.

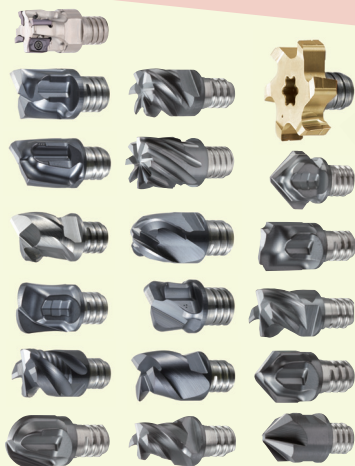

Steel: For general purpose
Carbide: For highly accurate machining due to excellent rigidity
Tungsten: Reduced chattering due to high vibration damping capacity

Reduces tool changeover times drastically!!

- Machine downtime is decreased considerably.
- Enables users to only change cutting head, simplifying set-ups.

Increases productivity by 90%



Highly accurate repeatability

- Accuracy can be maintained by touching the taper and face.
- Repeatability is guaranteed and is not a concern for machine operators.

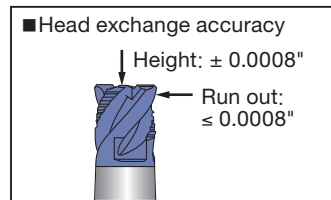
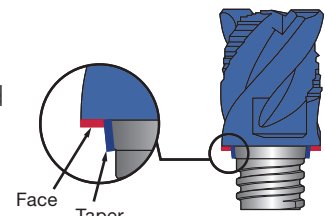

★ : First choice
☆ : Second choice

Edge shape	Designation	Appearance	Application	Feature	Edge shape	No. of cutting edges	Tool diameter	Slot width	CRKS	Helix angle	Workpiece material						Page
											P	M	K	N	S	H	
Square	VEH**		Semi-finishing	All-around / Variable helix, Variable pitch	Corner radius	4	ø8 - ø20	-	S05 - S12	Irregular	★	★	★	☆	★	☆	I010
	VEE**-03...		Finishing	All-around	Corner radius 0	3	ø8 - ø12	-	S05 - S08	45	★	★	★	☆	★	☆	I010
	VEE**-04..., VED**-04...		Finishing	All-around	Corner radius	4	ø6 - ø20	-	S05 - S12	30/45	★	★	★	☆	★	☆	I011
	VEE**-03...		Finishing	For key way / All-around	Corner radius	3	ø7.7 - ø19.7	-	S05 - S12	38	★	★	★	☆	★	☆	I011
	VEE**I...		Finishing	All-around / Variable pitch	Corner radius / Chamfered	4	ø8 - ø25	-	S05 - S15	38	★	★	★	☆	★	☆	I012
	VEE**R...		Roughing	All-around / Serrated cutting edge	Chamfered	4, 5, 6	ø8 - ø25	-	S05 - S15	45	★	★	★	☆	★	☆	I012
	VEE**C...		Semi-finishing	All-around / Edge combination	Chamfered	4	ø8 - ø25	-	S05 - S15	45	★	★	★	☆	★	☆	I013
	VEE**A02...		Finishing	All-around	Corner radius	2	ø10 - ø12	-	S06 - S08	45				☆	★		I013
	VEE**A03...		Finishing	All-around	Corner radius	3	ø8 - ø20	-	S05 - S12	45				☆	★		I014
	VED**-06..., VEE**-06...		Finishing	All-around	Corner radius / Chamfered	6	ø8 - ø12	-	S05 - S08	30/45/50	☆	☆	☆		★	★	I014
	VED**-08/10..., VEE**-08/10...		Finishing	All-around	Corner radius / Chamfered	8, 10	ø16 - ø25	-	S10 - S15	30/50	☆	☆	☆		★	★	I015
Radius	VRB**-02...		Finishing	All-around	Corner radius	2	ø10 - ø20	-	S06 - S12	0/15	★	★	★	☆	★	☆	I015
	VRD**-06...		Finishing	All-around	Corner radius	6	ø8 - ø16	-	S05 - S10	30	★	★	★	☆	★	☆	I016
High feed	VFX**-02...		Roughing	All-around/ High feed	High feed	2	ø10 - ø20	-	S06 - S12	-	★	★	★	☆	★	★	I018
	VFX**-04...		Roughing	All-around/ High feed	High feed	4	ø12, ø16	-	S08, S10	-	★	★	★	☆	★	★	I018
Ball	VBB**-BM...		Roughing	All-around	Ball	2	ø8 - ø16	-	S05 - S10	0	★	★	★	☆	★	☆	I019
	VBB**-BG...		Semi-finishing	All-around	Ball	2	ø8 - ø16	-	S05 - S10	0	★	★	★	☆	★	☆	I019
	VBD**-BG...		Finishing	All-around	Ball	2	ø8 - ø16	-	S05 - S10	30	★	★	★	☆	★	☆	I019
	VBD**-BG.../ VBE**-BG...		Finishing	All-around	Ball	4	ø6 - ø25	-	S05 - S15	30/38	★	★	★	☆	★	☆	I020

★ : First choice
☆ : Second choice

Edge shape	Designation	Appearance	Application	Feature	Edge shape	No. of cutting edges	Tool diameter	Slot width	CRKS	Helix angle	Workpiece material						Page
											P	M	K	N	S	H	
Ball	VBB** -SG...		Finishing	All-around / Sphere	Ball	2	ø10 - ø20	-	S05 - S15	0	★	★	★	☆	★	☆	I020
	VBE** -BGA...		Finishing	All-around	Ball	2	ø8 - ø20	-	S05 - S12	45				☆	★		I020
Spot drilling and chamfering	VCP** -02...		Finishing	For chamfering / 30°, 45°, 60°	Chamfered (with center cutting edge)	2	ø8 - ø16.5	-	S05 - S10	0	★	★	★	☆	★	☆	I022
Chamfering	VCA** -04/06...		Finishing	For chamfering / 45°	Chamfered (without center cutting edge)	4, 6	ø10 - ø20	-	S06 - S12	0	★	★	★	☆	★	☆	I026
	VCW** -02...		Finishing	For chamfering / with back chamfering edge	Chamfered (with center cutting edge)	2	ø11.8	-	S06	0	★	★	★	☆	★	☆	I026
	VCR** -02...		Finishing	For chamfering / R chamfering	Chamfered (without center cutting edge)	2	ø8 - ø20	-	S05 - S12	0	★	★	★	☆	★	☆	I026
Spot drilling	VDP** -02...		Finishing	For Spot drilling	Holemaking	2	ø3.28 - ø6.46	-	S05 - S10	0	★	★	★	☆	★	☆	I022
Counter-boring	VGC** -02...		Finishing	For Counterboring	Corner radius	2	ø7.8 - ø16	-	S05 - S10	10	★	★	★	☆	★	☆	I024
Threading	VST** -3...		Finishing	For slotting	Corner radius	3	ø15.7 - ø17.7	1.2-3.17	S06	0	★	★	★	☆	★	☆	I028
	VST** -4/6...		Finishing	For slotting	Corner radius	4, 6	ø21.7 - ø27.7	0.76-10	S08, S10	0	★	★	★	☆	☆	☆	I029
	VTB** -06...		Finishing	For slotting	Corner radius	6	ø13.5 - ø25	2-8	S05 - S10	0	★	★	★	☆	★	☆	I030
	VTB** C15-06...		Finishing	For slotting	Chamfered	6	ø13.5	2	S05	0	★	★	★	☆	★	☆	I029
Chamfering	VST** A45...		Finishing	For chamfering / 45°	Chamfered	3, 4	ø17.7 - ø21.7	3.4-5.5	S06, S08	0	★	★	★	☆	★	☆	I029
Threading	VMT*** IS / UN / W		Finishing	Threading	Full profile	3 - 6	ø10 - ø16	-	S05, S06 S08	-	★	★	★	☆	★	☆	H204 - H205
Threading	VTR*** IS / W		Finishing	Threading	Partial profile	3, 4	ø15.7 - ø21.7	-	S06, S08	-	★	★	★	☆	★	☆	H205

Grade
Insert
Toolholder
Ext. Toolholder
Int. Toolholder
Threading
Grooving
Miniature Tool
Milling Cutter
Endmill
Drilling Tool
Tooling System
Index



Shank

V **SS** **037** **L300** **S** **06** **U** **S**

1 2 3 4 5 6 7 8

1 Series	
V	TungMeister

3 Shank diameter (in)	
031	ø0.315
037	ø0.375
050	ø0.500
062	ø0.625
075	ø0.750
100	ø1.000

4 Length (in)	
L300	3.000

7 Additional feature	
U	Inch

2 Shank type	
SS	Straight neck
TS	Taper neck
SC	Slotting
ST	for T-Slotting
AD	TungFlex adapter

5 Shape of shank	
S	Cylindrical
W	Weldon

8 Shank material	
S	Steel
C	Carbide
W	Tungsten

6 Connection screw size	
05	S05
06	S06
08	S08
10	S10
12	S12
15	S15

Head

● Square endmill

V **E** **E** **031** **L20** **R000** **-U** **03** **S05**

1 2 3 4 5 6 7 8 9 10

● Ball nose endmill

V **B** **D** **075** **L62** **-BG** **-U** **04** **S12**

1 2 3 4 5 6 7 8 9 10

1 Series	
V	TungMeister

3 Helix angle / Rake face	
B	0°
C	15°
D	30°
E	38° ~ 50°
F	60°
T	Land
H	Variable helix

6 Corner shape / Angle	
Chamfer type	
C006	0.006 x 45°
C012	0.012 x 45°
C024	0.024 x 45°
Chamfering head	
A30	30°
A60	60°
Ball nose	
SG	Sphere / high precision
BM	Ball / general purpose
BG	Ball / high precision

8 Additional feature	
U	Inch

2 Cutting edge	
E	Square
B	Ball
R	Radius
FX	for high feed
CA	for chamfering
CP	Spot drilling
CW	for chamfering (front and back)
CR	for R chamfering
GC	for counter boring
DP	for center drilling
S	for slotting
T	for T-slot milling

4 Diameter (in)	
050	ø0.500
100	ø1.000

5 Cutting edge length (in)	
Length	
L37	0.375
L87	0.875

9 The number of flutes	
General	
02	2
06	6

10 Connection screw size	
S05	S05
S06	S06
S08	S08
S10	S10
S12	S12
S15	S15

7 Additional feature	
I	Irregular pitch
A	for aluminum
R	for roughing
C	Combined edge

DESIGNATION SYSTEM (Metric)

Shank

V	SS	D10	L070	S	06	-W-	A
1	2	3	4	5	6	7	8

1 Series	V TungMeister
-----------------	----------------------

2 Shank type	SS Straight neck	TS Taper neck	SC Slotting	ST for T-Slotting	AD TungFlex adapter
---------------------	-------------------------	----------------------	--------------------	--------------------------	----------------------------

3 Shank diameter (mm)	D08 ø8	D10 ø10	D12 ø12	D16 ø16	D20 ø20	D25 ø25	D32 ø32
VSC, VAD type		100 ø10	120 ø12	130 ø13	180 ø18	210 ø21	

4 Length (mm)	L070 70
----------------------	----------------

5 Shape of shank	S Cylindrical	W Weldon
-------------------------	----------------------	-----------------

6 Connection screw size	05 S05	06 S06	08 S08	10 S10	12 S12	15 S15
--------------------------------	---------------	---------------	---------------	---------------	---------------	---------------

7 Shank material	S Steel	C Carbide	W Tungsten
-------------------------	----------------	------------------	-------------------

8 Additional feature	A with coolant hole	M Thread size (TungFlex adapters)
-----------------------------	----------------------------	--

Head

• Square endmill

V	E	E	080	L05.0	R00	-03	S05
1	2	3	4	5	6	7	8

• Ball nose endmill

V	B	D	200	L15.0	-BG	-04	S12
1	2	3	4	5	6	7	8

1 Series	V TungMeister
-----------------	----------------------

2 Cutting edge	E Square	B Ball	R Radius	FX for high feed	CA for chamfering	CP Spot drilling	CW for chamfering (front and back)	CR for R chamfering	GC for counter boring	DP for center drilling	S for slotting	T for T-slot milling
-----------------------	-----------------	---------------	-----------------	-------------------------	--------------------------	-------------------------	---	----------------------------	------------------------------	-------------------------------	-----------------------	-----------------------------

3 Helix angle / Rake face	B 0°	C 15°	D 30°	E 38° - 50°	F 60°	T Land	H Variable helix
----------------------------------	-------------	--------------	--------------	--------------------	--------------	---------------	-------------------------

4 Diameter (mm)	060 ø6	200 ø20
------------------------	---------------	----------------

5 Cutting edge length (mm)	Length	L07.0 7	L15.0 15	
Groove width		W1.50 1.5	W1.57 1.57	W10.0 10

6 Corner shape / Angle	Nose radius	
R00	Sharp edge	
R005	R0.05	
R01	R0.1	
R05	R0.5	
R10	R1.0	
Chamfer type		
C15	0.15 x 45°	
C30	0.3 x 45°	
C60	0.6 x 45°	
Chamfering head		
A30	30°	
A60	60°	
R chamfering head		
R10	R1.0	
R16	R1.6	
Ball nose		
SG	Sphere / high precision	
BM	Ball / general purpose	
BG	Ball / high precision	

7 Additional feature	I Irregular pitch	A for aluminum	R for roughing	C Combined edge
-----------------------------	--------------------------	-----------------------	-----------------------	------------------------

8 The number of flutes	General	
02	2	
06	6	
Grooving head VST type		
3	3	
4	4	

9 Connection screw size	S05 S05	S06 S06	S08 S08	S10 S10	S12 S12	S15 S15
--------------------------------	----------------	----------------	----------------	----------------	----------------	----------------

Grade
Insert
Toolholder
Ext. Toolholder
Int. Toolholder
Threading
Grooving
Miniature Tool
Milling Cutter
Endmill
Drilling Tool
User's Guide Tooling System
Index

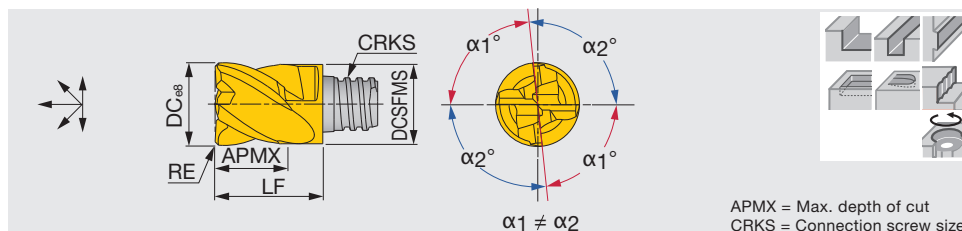

4 flute square head, for general purpose (TungMeister)

APMX = Max. depth of cut
CRKS = Connection screw size

Metric	AH725	NOF	FHA	DC	DCSFMS	APMX	RE	CRKS	LF	Wrench	Torque*
VEH080L05.0R05I04S05	●	4	35° - 39°	8	7.7	5	0.5	S05	10	KEYV-S05	7
VEH080L05.0R10I04S05	●	4	35° - 39°	8	7.7	5	1	S05	10	KEYV-S05	7
VEH100L07.0R05I04S06	●	4	35° - 39°	10	9.7	7	0.5	S06	13	KEYV-S06	10
VEH100L07.0R10I04S06	●	4	35° - 39°	10	9.7	7	1	S06	13	KEYV-S06	10
VEH120L09.0R05I04S08	●	4	35° - 39°	12	11.7	9	0.5	S08	16.5	KEYV-S08	15
VEH120L09.0R10I04S08	●	4	35° - 39°	12	11.7	9	1	S08	16.5	KEYV-S08	15
VEH160L12.0R05I04S10	●	4	35° - 39°	16	15.3	12	0.5	S10	20.5	KEYV-S10	28
VEH160L12.0R10I04S10	●	4	35° - 39°	16	15.3	12	1	S10	20.5	KEYV-S10	28
VEH200L15.0R05I04S12	●	4	35° - 39°	20	18.3	15	0.5	S12	25.5	KEYV-S12	28
VEH200L15.0R10I04S12	●	4	35° - 39°	20	18.3	15	1	S12	25.5	KEYV-S12	28

* Torque: Recommended clamping torque: N·m
2 pieces per package

●: Line up

3 flute square head, for general purpose (TungMeister)

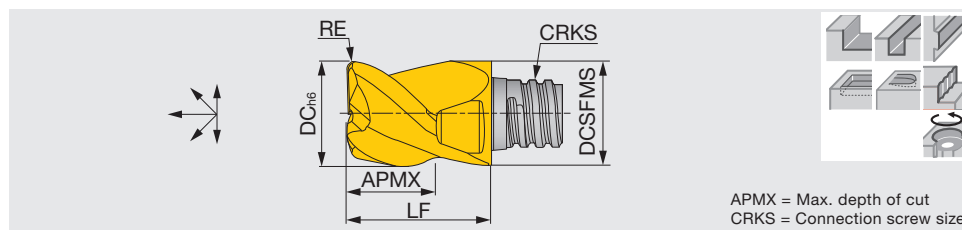
APMX = Max. depth of cut
CRKS = Connection screw size

Inch	AH725	NOF	FHA	DC	DCSFMS	APMX	CRKS	LF	Wrench	Torque*
VEE031L20R000-U03S05	●	3	45°	0.312	0.300	0.200	S05	0.390	KEYV-S05	5.16
VEE037L27R000-U03S06	●	3	45°	0.375	0.370	0.275	S06	0.512	KEYV-S06	7.38
VEE050L37R000-U03S08	●	3	45°	0.500	0.488	0.374	S08	0.650	KEYV-S08	11.06

* Torque: Recommended clamping torque: lbs·ft
2 pieces per package

●: Line up

4 flute square head, for general purpose (TungMeister)

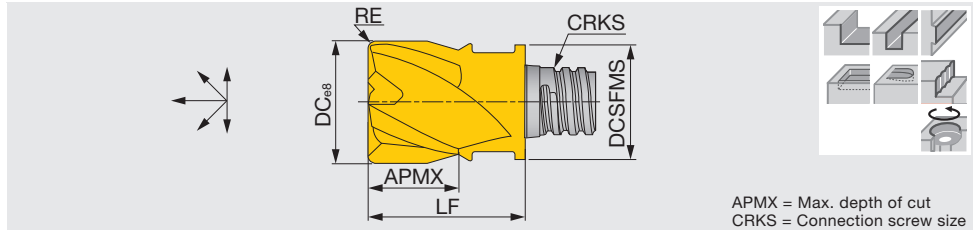

Inch	AH725	NOF	FHA	DC	DCSFMS	APMX	RE	CRKS	LF	Wrench	Torque*
VEE025L20R000-U04S05	●	4	45°	0.250	0.300	0.200	-	S05	0.390	KEYV-S05	5.16
VED031L20R015-U04S05	●	4	30°	0.312	0.300	0.200	0.015	S05	0.390	KEYV-S05	5.16
VED031L20R031-U04S05	●	4	30°	0.312	0.300	0.200	0.031	S05	0.390	KEYV-S05	5.16
VED031L20R062-U04S05	●	4	30°	0.312	0.300	0.200	0.062	S05	0.390	KEYV-S05	5.16
VEE031L20R000-U04S05	●	4	45°	0.312	0.300	0.200	-	S05	0.390	KEYV-S05	5.16
VEE031L20R015-U04S05	●	4	45°	0.312	0.300	0.200	0.015	S05	0.390	KEYV-S05	5.16
VEE031L20R031-U04S05	●	4	45°	0.312	0.300	0.200	0.031	S05	0.390	KEYV-S05	5.16
VEE031L20R062-U04S05	●	4	45°	0.312	0.300	0.200	0.062	S05	0.390	KEYV-S05	5.16
VED037L27R015-U04S06	●	4	30°	0.375	0.370	0.275	0.015	S06	0.512	KEYV-S06	7.38
VED037L27R031-U04S06	●	4	30°	0.375	0.370	0.275	0.031	S06	0.512	KEYV-S06	7.38
VEE037L27R000-U04S06	●	4	45°	0.375	0.370	0.275	-	S06	0.512	KEYV-S06	7.38
VEE037L27R015-U04S06	●	4	45°	0.375	0.370	0.275	0.015	S06	0.512	KEYV-S06	7.38
VEE037L27R030-U04S06	●	4	45°	0.375	0.370	0.275	0.031	S06	0.512	KEYV-S06	7.38
VEE037L27R062-U04S06	●	4	45°	0.375	0.370	0.275	0.062	S06	0.512	KEYV-S06	7.38
VEE037L47R000-U04S06	●	4	45°	0.375	0.370	0.470	-	S06	0.748	KEYV-S06	7.38
VED050L37R015-U04S08	●	4	30°	0.500	0.488	0.374	0.015	S08	0.650	KEYV-S08	11.06
VED050L37R031-U04S08	●	4	30°	0.500	0.488	0.374	0.031	S08	0.650	KEYV-S08	11.06
VEE050L37R000-U04S08	●	4	45°	0.500	0.488	0.374	-	S08	0.650	KEYV-S08	11.06
VEE050L37R015-U04S08	●	4	45°	0.500	0.488	0.374	0.015	S08	0.650	KEYV-S08	11.06
VEE050L37R031-U04S08	●	4	45°	0.500	0.488	0.374	0.031	S08	0.650	KEYV-S08	11.06
VEE050L37R062-U04S08	●	4	45°	0.500	0.488	0.374	0.062	S08	0.650	KEYV-S08	11.06
VED062L47R015-U04S10	●	4	30°	0.625	0.600	0.470	0.015	S10	0.810	KEYV-S10	20.65
VED062L47R031-U04S10	●	4	30°	0.625	0.600	0.470	0.031	S10	0.810	KEYV-S10	20.65
VED062L47R062-U04S10	●	4	30°	0.625	0.600	0.470	0.062	S10	0.810	KEYV-S10	20.65
VEE062L47R000-U04S10	●	4	45°	0.625	0.600	0.470	-	S10	0.810	KEYV-S10	20.65
VEE062L47R031-U04S10	●	4	45°	0.625	0.600	0.470	0.031	S10	0.810	KEYV-S10	20.65
VED075L62R015-U04S12	●	4	30°	0.750	0.720	0.620	0.015	S12	1.000	KEYV-S12	20.65
VED075L62R031-U04S12	●	4	30°	0.750	0.720	0.620	0.031	S12	1.000	KEYV-S12	20.65
VED075L62R062-U04S12	●	4	30°	0.750	0.720	0.620	0.062	S12	1.000	KEYV-S12	20.65
VEE075L62R000-U04S12	●	4	45°	0.750	0.720	0.620	-	S12	1.000	KEYV-S12	20.65
VEE075L62R031-U04S12	●	4	45°	0.750	0.720	0.620	0.031	S12	1.000	KEYV-S12	20.65

* Torque: Recommended clamping torque: lbs-ft
2 pieces per package

●: Line up

3 flute square head, for keyway (TungMeister)

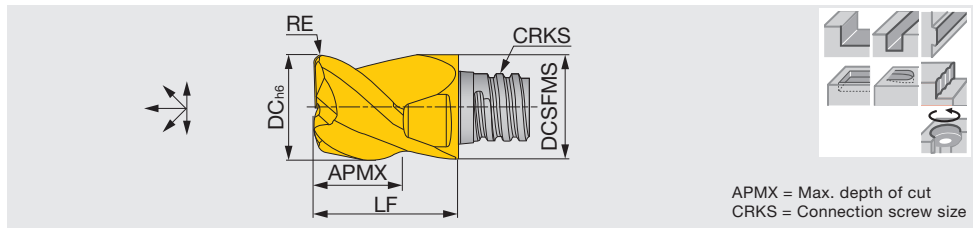

Metric	AH725	NOF	FHA	DC	DCSFMS	APMX	RE	CRKS	LF	Wrench	Torque*
VEE077L04.0R02-03S05	●	3	38°	7.7	7.7	4	0.2	S05	10	KEYV-S05	7
VEE097L05.0R03-03S06	●	3	38°	9.7	9.7	5	0.3	S06	13	KEYV-S06	10
VEE117L07.0R03-03S08	●	3	38°	11.7	11.7	7	0.3	S08	16.5	KEYV-S08	15
VEE157L08.0R03-03S10	●	3	38°	15.7	15.3	8	0.3	S10	20.5	KEYV-S10	28
VEE197L12.0R04-03S12	●	3	38°	19.7	18.3	12	0.4	S12	25.5	KEYV-S12	28

* Torque: Recommended clamping torque: N·m
2 pieces per package

●: Line up

Reference pages: Standard cutting conditions → I016 - I017

TUNGMEISTER

VEE**I...

4 flute square head, variable pitch, for chatter damping (TungMeister)

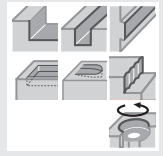
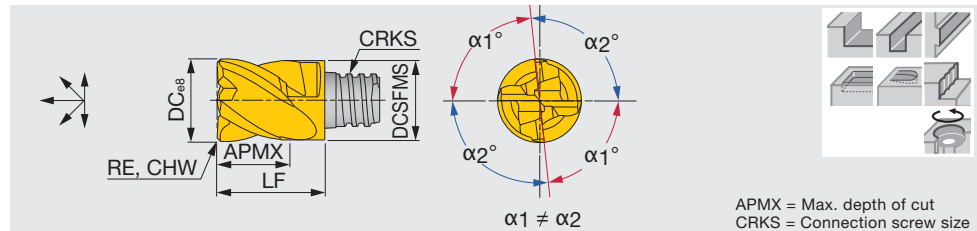

Inch	AH725	NOF	FHA	DC	DCSFMS	APMX	RE	CHW	CRKS	LF	Wrench	Torque*
VEE031L22C012IU04S05	●	4	38°	0.312	0.303	0.220	-	0.012	S05	0.393	KEYV-S05	5.16
VEE037L29C016IU04S06	●	4	38°	0.375	0.370	0.299	-	0.016	S06	0.512	KEYV-S06	7.38
VEE050L37C020IU04S08	●	4	38°	0.500	0.488	0.374	-	0.020	S08	0.650	KEYV-S08	11.06
VEE062L50C024IU04S10	●	4	38°	0.625	0.602	0.500	-	0.024	S10	0.810	KEYV-S10	20.65
VEE075L62C024IU04S12	●	4	38°	0.750	0.726	0.629	-	0.024	S12	1.004	KEYV-S12	20.65
VEE100L86C024IU04S15	●	4	38°	1.000	0.940	0.863	-	0.024	S15	1.456	KEYV-W20	29.50
VEE100L86R000IU04S15	●	4	38°	1.000	0.941	0.866	-	-	S15	1.457	KEYV-W20	29.50
VEE100L86R015IU04S15	●	4	38°	1.000	0.941	0.866	0.015	-	S15	1.457	KEYV-W20	29.50
VEE100L86R031IU04S15	●	4	38°	1.000	0.941	0.866	0.031	-	S15	1.457	KEYV-W20	29.50
VEE100L86R062IU04S15	●	4	38°	1.000	0.941	0.866	0.062	-	S15	1.457	KEYV-W20	29.50
VEE100L86R125IU04S15	●	4	38°	1.000	0.941	0.866	0.125	-	S15	1.457	KEYV-W20	29.50

* Torque: Recommended clamping torque: lbs-ft
VEE031 ~ VEE075: 2 pieces per package
VEE100: 1 piece per package

●: Line up

- Square
- Radius
- High feed
- Ball
- Chamfering
- Slotting
- Others

TUNGMEISTER

VEE**R...

4 flute square head, for chatter damping (TungMeister)

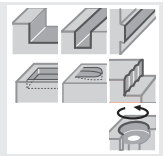
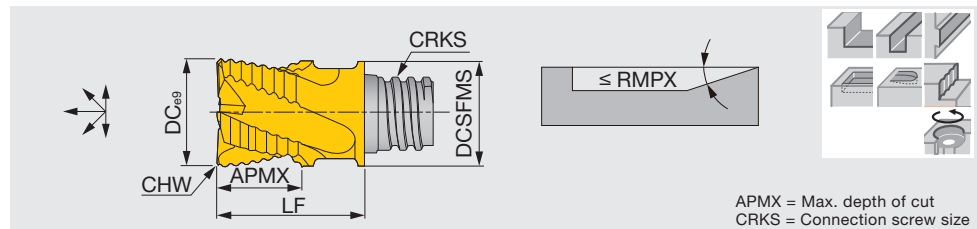

Inch	AH725	NOF	FHA	DC	DCSFMS	APMX	CHW	CRKS	LF	RMPX	Wrench	Torque*
VEE031L20C012RU04S05	●	4	45°	0.312	0.300	0.200	0.010	S05	0.390	-	KEYV-S05	5.16
VEE037L27C012RU04S06	●	4	45°	0.375	0.360	0.270	0.012	S06	0.512	-	KEYV-S06	7.38
VEE050L37C016RU04S08	●	4	45°	0.500	0.488	0.374	0.014	S08	0.650	-	KEYV-S08	11.06
VEE062L47C024RU05S10	●	5	45°	0.625	0.600	0.470	0.016	S10	0.800	-	KEYV-S10	20.65
VEE075L59C024RU06S12	●	6	45°	0.750	0.720	0.590	0.016	S12	1.000	3°	KEYV-S12	20.65
VEE100L86C020RU06S15	●	6	45°	1.000	0.941	0.866	0.020	S15	1.457	3°	KEYV-W15	29.50

* Torque: Recommended clamping torque: lbs-ft
VEE031 ~ VEE075: 2 pieces per package
VEE100: 1 piece per package

●: Line up

- 2
- 3
- 4
- 5
- 6 or more

Reference pages: Standard cutting conditions → **I016 - I017**

Square head, roughing and finishing combination type (TungMeister)

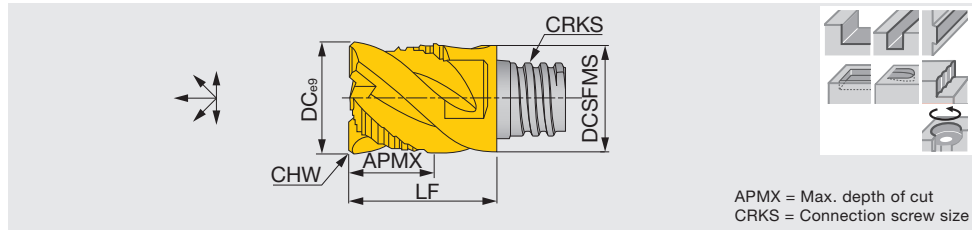

Inch	AH725	NOF	FHA	DC	DCSFMS	APMX	CHW	CRKS	LF	Wrench	Torque*
VEE031L20C012CU04S05	●	4	45°	0.312	0.300	0.200	0.012	S05	0.390	KEYV-S05	5.16
VEE037L27C012CU04S06	●	4	45°	0.375	0.360	0.275	0.012	S06	0.510	KEYV-S06	7.38
VEE050L36C016CU04S08	●	4	45°	0.500	0.488	0.369	0.016	S08	0.650	KEYV-S08	11.06
VEE062L47C024CU04S10	●	4	45°	0.625	0.600	0.470	0.024	S10	0.800	KEYV-S10	20.65
VEE075L62C024CU04S12	●	4	45°	0.750	0.720	0.620	0.024	S12	1.000	KEYV-S12	20.65
VEE100L86C024CU04S15	●	4	45°	1.000	0.941	0.866	0.024	S15	1.457	KEYV-W15	29.50

* Torque: Recommended clamping torque: lbs-ft
 VEE031 ~ VEE075: 2 pieces per package
 VEE100: 1 piece per package

●: Line up

2 flute square head, for aluminum machining (TungMeister)

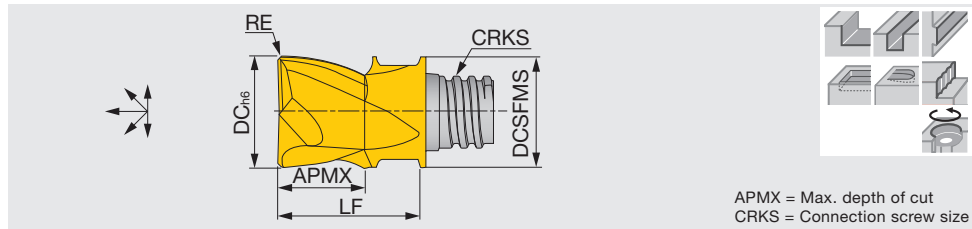

Inch	KS15F	NOF	FHA	DC	DCSFMS	APMX	RE	CRKS	LF	Wrench	Torque*
VEE037L27R000AU02S06	●	2	45°	0.375	0.360	0.270	-	S06	0.510	KEYV-S06	7.38
VEE037L27R020AU02S06	●	2	45°	0.375	0.360	0.270	0.02	S06	0.512	KEYV-S06	7.38
VEE050L37R000AU02S08	●	2	45°	0.500	0.488	0.374	-	S08	0.650	KEYV-S08	11.06
VEE050L37R020AU02S08	●	2	45°	0.500	0.488	0.374	0.02	S08	0.650	KEYV-S08	11.06

* Torque: Recommended clamping torque: lbs-ft
 2 pieces per package

●: Line up

TUNGMEISTER

VEE**A03...

3 flute square head, for aluminium machining (TungMeister)

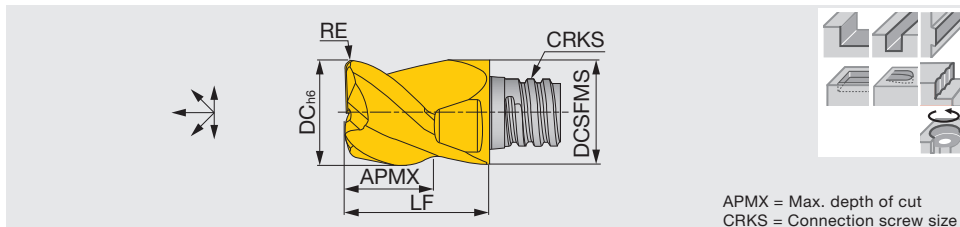

APMX = Max. depth of cut
CRKS = Connection screw size

Inch	KS15F	NOF	FHA	DC	DCSFMS	APMX	RE	CRKS	LF	Wrench	Torque*
VEE031L20R020AU03S05	●	3	45°	0.312	0.300	0.200	0.020	S05	0.390	KEYV-S05	5.16
VEE037L23R031AU03S06	●	3	45°	0.375	0.360	0.230	0.031	S06	0.510	KEYV-S06	7.38
VEE037L23R062AU03S06	●	3	45°	0.375	0.360	0.230	0.062	S06	0.510	KEYV-S06	7.38
VEE050L31R031AU03S08	●	3	45°	0.500	0.488	0.315	0.031	S08	0.650	KEYV-S08	11.06
VEE050L31R062AU03S08	●	3	45°	0.500	0.488	0.315	0.062	S08	0.650	KEYV-S08	11.06
VEE050L31R094AU03S08	●	3	45°	0.500	0.488	0.315	0.094	S08	0.650	KEYV-S08	11.06
VEE050L31R125AU03S08	●	3	45°	0.500	0.488	0.315	0.125	S08	0.650	KEYV-S08	11.06
VEE062L39R000AU03S10	●	3	45°	0.625	0.600	0.390	-	S10	0.810	KEYV-S10	20.65
VEE062L39R031AU03S10	●	3	45°	0.625	0.600	0.390	0.031	S10	0.810	KEYV-S10	20.65
VEE062L39R062AU03S10	●	3	45°	0.625	0.600	0.390	0.062	S10	0.810	KEYV-S10	20.65
VEE062L39R094AU03S10	●	3	45°	0.625	0.600	0.390	0.094	S10	0.810	KEYV-S10	20.65
VEE062L39R125AU03S10	●	3	45°	0.625	0.600	0.390	0.125	S10	0.810	KEYV-S10	20.65
VEE075L47R062AU03S12	●	3	45°	0.750	0.720	0.470	0.062	S12	1.000	KEYV-S12	20.65
VEE075L47R094AU03S12	●	3	45°	0.750	0.720	0.470	0.094	S12	1.000	KEYV-S12	20.65
VEE075L47R125AU03S12	●	3	45°	0.750	0.720	0.470	0.125	S12	1.000	KEYV-S12	20.65
VEE075L50R008AU03S12	●	3	45°	0.750	0.720	0.500	0.008	S12	1.000	KEYV-S12	20.65
VEE075L50R020AU03S12	●	3	45°	0.750	0.720	0.500	0.020	S12	1.000	KEYV-S12	20.65

* Torque: Recommended clamping torque: lbs-ft
2 pieces per package

●: Line up

TUNGMEISTER

VED**-06..., VEE**-06...

6 flute square head, for difficult-to-cut material (TungMeister)

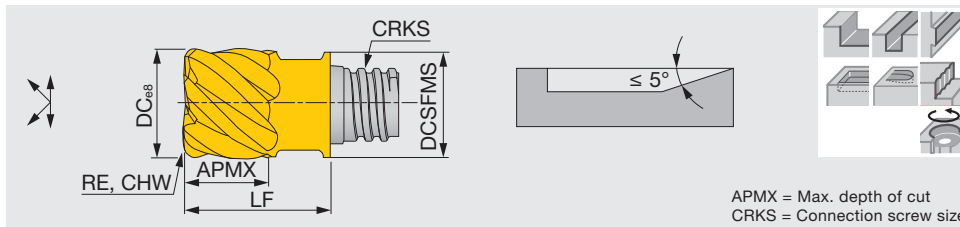

APMX = Max. depth of cut
CRKS = Connection screw size

Inch	AH725	AH750	NOF	FHA	DC	DCSFMS	APMX	RE	CHW	CRKS	LF	Wrench	Torque*
VED031L20R015-U06S05	●		6	30°	0.312	0.300	0.200	0.015	-	S05	0.390	KEYV-S05	5.16
VEE031L20R000-U06S05	●		6	45°	0.312	0.300	0.200	-	-	S05	0.390	KEYV-S05	5.16
VEE031L20R031-U06S05	●		6	45°	0.312	0.300	0.200	0.031	-	S05	0.390	KEYV-S05	5.16
VEE031L20C004-U06S05		●	6	50°	0.312	0.300	0.200	-	0.004	S05	0.390	KEYV-S05	5.16
VED037L27R015-U06S06	●		6	30°	0.375	0.370	0.275	0.015	-	S06	0.512	KEYV-S06	7.38
VED037L27R031-U06S06	●		6	30°	0.375	0.370	0.275	0.031	-	S06	0.512	KEYV-S06	7.38
VEE037L27R000-U06S06	●		6	45°	0.375	0.370	0.275	-	-	S06	0.512	KEYV-S06	7.38
VEE037L27R015-U06S06	●		6	45°	0.375	0.370	0.275	0.015	-	S06	0.512	KEYV-S06	7.38
VEE037L27R031-U06S06	●		6	45°	0.375	0.370	0.275	0.031	-	S06	0.512	KEYV-S06	7.38
VEE037L27R062-U06S06	●		6	45°	0.375	0.370	0.275	0.062	-	S06	0.512	KEYV-S06	7.38
VEE037L27C004-U06S06		●	6	50°	0.375	0.370	0.270	-	0.004	S06	0.510	KEYV-S06	7.38
VED050L37R015-U06S08	●		6	30°	0.500	0.488	0.374	0.016	-	S08	0.650	KEYV-S08	11.06
VED050L37R031-U06S08	●		6	30°	0.500	0.488	0.374	0.031	-	S08	0.650	KEYV-S08	11.06
VEE050L37R000-U06S08	●		6	45°	0.500	0.488	0.374	-	-	S08	0.650	KEYV-S08	11.06
VEE050L37R015-U06S08	●		6	45°	0.500	0.488	0.374	0.016	-	S08	0.650	KEYV-S08	11.06
VEE050L37R031-U06S08	●		6	45°	0.500	0.488	0.374	0.031	-	S08	0.650	KEYV-S08	11.06
VEE050L37R062-U06S08	●		6	45°	0.500	0.488	0.374	0.059	-	S08	0.650	KEYV-S08	11.06
VEE050L37C004-U06S08		●	6	50°	0.500	0.488	0.374	-	0.004	S08	0.650	KEYV-S08	11.06

* Torque: Recommended clamping torque: lbs-ft
2 pieces per package

●: Line up

- Square
- Radius
- High feed
- Ball
- Chamfering
- Slotting
- Others

- 2
- 3
- 4
- 5
- 6 or more

8 and 10 flute square head, for difficult-to-cut material (TungMeister)

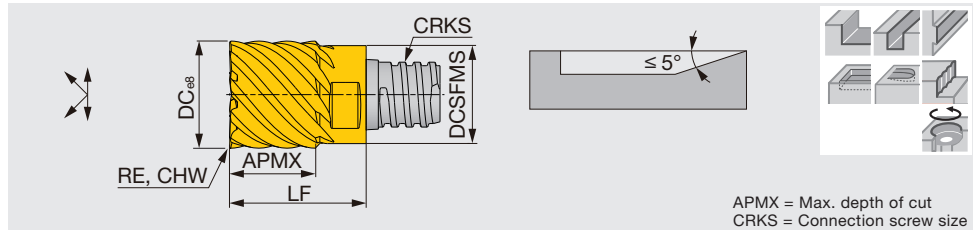

Inch	AH725	AH750	NOF	FHA	DC	DCSFMS	APMX	RE	CHW	CRKS	LF	Wrench	Torque*
VED062L47R000-U08S10	●		8	30°	0.625	0.600	0.470	-	-	S10	0.810	KEYV-S10	20.65
VED062L47R015-U08S10	●		8	30°	0.625	0.600	0.470	0.015	-	S10	0.810	KEYV-S10	20.65
VED062L47R031-U08S10	●		8	30°	0.625	0.600	0.470	0.031	-	S10	0.810	KEYV-S10	20.65
VED062L47R062-U08S10	●		8	30°	0.625	0.600	0.470	0.062	-	S10	0.810	KEYV-S10	20.65
VEE062L47C008-U08S10		●	8	50°	0.625	0.600	0.470	-	0.008	S10	0.810	KEYV-S10	20.65
VED075L62R031-U10S12	●		10	30°	0.750	0.720	0.620	0.031	-	S12	1.000	KEYV-S12	20.65
VED075L62R062-U10S12	●		10	30°	0.750	0.720	0.620	0.062	-	S12	1.000	KEYV-S12	20.65
VEE075L62C008-U10S12		●	10	50°	0.750	0.720	0.620	-	0.008	S12	1.000	KEYV-S12	20.65
VED100L86R031-U10S15	●		10	30°	1.000	0.941	0.866	0.031	-	S15	1.457	KEYV-W20	29.50
VED100L86R062-U10S15	●		10	30°	1.000	0.941	0.866	0.062	-	S15	1.457	KEYV-W20	29.50

* Torque: Recommended clamping torque: lbs-ft
VED/VEE062- VED/VEE075: 2 pieces per package
VED100: 1 piece per package

●: Line up

2 flute radius head (TungMeister)

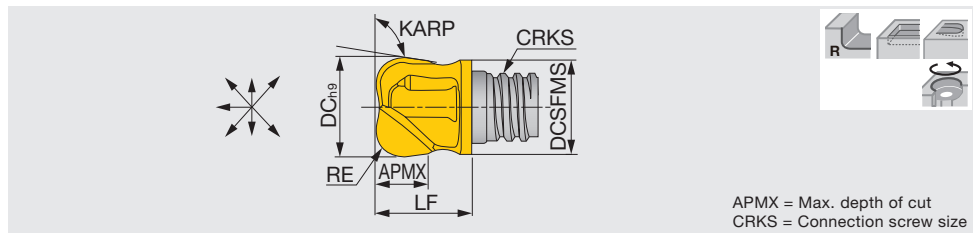

Inch	AH725	NOF	FHA	DC	DCSFMS	APMX	RE	KARP	CRKS	LF	Wrench	Torque*
VRB062L31R187-U02S10	●	2	-	0.625	0.600	0.310	0.190	97°	S10	0.580	KEYV-S10	20.65
VRB075L45R250-U02S12	●	2	-	0.750	0.720	0.450	0.250	97°	S12	0.680	KEYV-S12	20.65
VRB075L45R312-U02S12	●	2	-	0.750	0.720	0.450	0.312	97°	S12	0.680	KEYV-S12	20.65

Note: Suitable for contouring operation.

** The wrench size for these heads is different from the ones for the other head types.

* Torque: Recommended clamping torque: lbs-ft
2 pieces per package

●: Line up

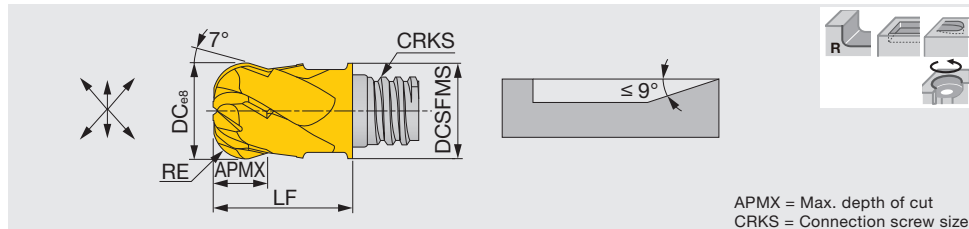

APMX = Max. depth of cut
CRKS = Connection screw size

Inch	AH725	NOF	FHA	DC	DCSFMS	APMX	RE	CRKS	LF	Wrench	Torque*
VRD031L16R078-U06S05	●	6	30°	0.312	0.300	0.160	0.078	S05	0.390	KEYV-S05	5.16
VRD037L19R031-U06S06	●	6	30°	0.375	0.360	0.190	0.031	S06	0.510	KEYV-S06	7.38
VRD037L19R062-U06S06	●	6	30°	0.375	0.360	0.190	0.062	S06	0.510	KEYV-S06	7.38
VRD037L19R125-U06S06	●	6	30°	0.375	0.360	0.190	0.125	S06	0.510	KEYV-S06	7.38
VRD050L27R062-U06S08	●	6	30°	0.500	0.480	0.270	0.062	S08	0.650	KEYV-S08	11.06
VRD050L27R125-U06S08	●	6	30°	0.500	0.480	0.270	0.125	S08	0.650	KEYV-S08	11.06
VRD050L27R156-U06S08	●	6	30°	0.500	0.480	0.270	0.156	S08	0.650	KEYV-S08	11.06
VRD062L35R200-U06S10	●	6	30°	0.625	0.600	0.350	0.200	S10	0.807	KEYV-S10	20.65

* Torque: Recommended clamping torque: lbs-ft
2 pieces per package

●: Line up

STANDARD CUTTING CONDITIONS

Shoulder milling (VEH, VEE: 3 flutes, VED/VEE: 4 flutes, VEE-A, VEE-I, VEE-R, VEE-C, VRB, VRC, VRD)

ISO	Workpiece material	Hardness	Cutting speed Vc (sfm)	Feed per tooth: fz (ipt)							Depth of cut ap (in)	Pick feed Pf (in)
				Tool diameter: DC (in)								
				0.250"	0.312"	0.375"	0.500"	0.625"	0.750"	1.000"		
P	Low carbon steels 1045, 1055, etc.	- 300 HB	260 - 590	0.001 - 0.003	0.001 - 0.004	0.003 - 0.005	0.003 - 0.005	0.004 - 0.006	0.004 - 0.007	0.004 - 0.007	0.6 x DC	0.25 x DC
	High carbon steels 4140, 5120, etc.	- 300 HB	200 - 460	0.001 - 0.003	0.001 - 0.004	0.003 - 0.005	0.003 - 0.005	0.004 - 0.006	0.004 - 0.007	0.004 - 0.007	0.6 x DC	0.25 x DC
	Prehardened steel PX5, NAK80, etc.	30 - 40 HRC	200 - 400	0.001 - 0.003	0.001 - 0.004	0.003 - 0.005	0.003 - 0.005	0.004 - 0.006	0.004 - 0.007	0.004 - 0.007	0.6 x DC	0.25 x DC
M	Stainless steels S30400, S31600, etc.	- 200 HB	130 - 330	0.001 - 0.003	0.001 - 0.004	0.003 - 0.005	0.003 - 0.005	0.004 - 0.006	0.004 - 0.007	0.004 - 0.007	0.6 x DC	0.25 x DC
K	Gray cast irons No.250B, No.300B, etc.	150 - 250 HB	260 - 660	0.001 - 0.003	0.001 - 0.004	0.003 - 0.005	0.003 - 0.005	0.004 - 0.006	0.004 - 0.007	0.004 - 0.007	0.6 x DC	0.25 x DC
	Ductile cast irons 60-40-18, etc.	150 - 250 HB	260 - 660	0.001 - 0.003	0.001 - 0.004	0.003 - 0.005	0.003 - 0.005	0.004 - 0.006	0.004 - 0.007	0.004 - 0.007	0.6 x DC	0.25 x DC
N	Aluminum alloys Si < 13%	-	660 - 2297	0.001 - 0.003	0.001 - 0.004	0.003 - 0.005	0.003 - 0.005	0.004 - 0.006	0.004 - 0.007	0.004 - 0.007	0.6 x DC	0.25 x DC
	Aluminum alloys Si ≥ 13%	-	330 - 980	0.001 - 0.003	0.001 - 0.004	0.003 - 0.005	0.003 - 0.005	0.004 - 0.006	0.004 - 0.007	0.004 - 0.007	0.6 x DC	0.25 x DC
S	Titanium alloys Ti-6Al-4V, etc.	-	130 - 260	0.001 - 0.003	0.001 - 0.004	0.003 - 0.005	0.003 - 0.005	0.004 - 0.006	0.004 - 0.007	0.004 - 0.007	0.6 x DC	0.05 x DC
	Heat-resistant alloys Inconel 718, etc.	-	66 - 130	0.001 - 0.003	0.001 - 0.004	0.003 - 0.005	0.003 - 0.005	0.004 - 0.006	0.004 - 0.007	0.004 - 0.007	0.6 x DC	0.05 x DC
H	Hardened steel H13, etc.	40 - 50 HRC	130 - 260	0.001 - 0.003	0.001 - 0.004	0.003 - 0.005	0.003 - 0.005	0.004 - 0.006	0.004 - 0.007	0.004 - 0.007	0.6 x DC	0.05 x DC
	Hardened steel D2, etc.	50 - 60 HRC	66 - 200	0.001 - 0.003	0.001 - 0.004	0.003 - 0.005	0.003 - 0.005	0.004 - 0.006	0.004 - 0.007	0.004 - 0.007	0.6 x DC	0.05 x DC

Slot milling (VEH, VEE: 3 flutes, VED/VEE: 4 flutes, VEE-A, VEE-I, VEE-R, VEE-C, VRB, VRC, VRD)

ISO	Workpiece material	Hardness	Cutting speed Vc (sfm)	Feed per tooth: fz (ipt)							Depth of cut ap (in)
				Tool diameter: DC (in)							
				0.250"	0.312"	0.375"	0.500"	0.625"	0.750"	1.000"	
P	Low carbon steels 1045, 1055, etc.	- 300 HB	260 - 590	0.001 - 0.003	0.001 - 0.004	0.003 - 0.005	0.003 - 0.005	0.004 - 0.006	0.004 - 0.007	0.003 - 0.004	0.5 x DC
	High carbon steels 4140, 5120, etc.	- 300 HB	200 - 460	0.001 - 0.003	0.001 - 0.004	0.003 - 0.005	0.003 - 0.005	0.004 - 0.006	0.004 - 0.007	0.003 - 0.004	0.5 x DC
	Prehardened steel PX5, NAK80, etc.	30 - 40 HRC	200 - 400	0.001 - 0.003	0.001 - 0.004	0.003 - 0.005	0.003 - 0.005	0.004 - 0.006	0.004 - 0.007	0.003 - 0.004	0.5 x DC
M	Stainless steels S30400, S31600, etc.	- 200 HB	130 - 330	0.001 - 0.003	0.001 - 0.004	0.003 - 0.005	0.003 - 0.005	0.004 - 0.006	0.004 - 0.007	0.003 - 0.004	0.5 x DC
K	Gray cast irons No.250B, No.300B, etc.	150 - 250 HB	260 - 660	0.001 - 0.003	0.001 - 0.004	0.003 - 0.005	0.003 - 0.005	0.004 - 0.006	0.004 - 0.007	0.003 - 0.004	0.5 x DC
	Ductile cast irons 60-40-18, etc.	150 - 250 HB	260 - 660	0.001 - 0.003	0.001 - 0.004	0.003 - 0.005	0.003 - 0.005	0.004 - 0.006	0.004 - 0.007	0.003 - 0.004	0.5 x DC
N	Aluminum alloys Si < 13%	-	660 - 2297	0.001 - 0.003	0.001 - 0.004	0.003 - 0.005	0.003 - 0.005	0.004 - 0.006	0.004 - 0.007	0.003 - 0.004	0.5 x DC
	Aluminum alloys Si ≥ 13%	-	330 - 980	0.001 - 0.003	0.001 - 0.004	0.003 - 0.005	0.003 - 0.005	0.004 - 0.006	0.004 - 0.007	0.003 - 0.004	0.5 x DC
S	Titanium alloys Ti-6Al-4V, etc.	-	130 - 260	0.001 - 0.003	0.001 - 0.004	0.003 - 0.005	0.003 - 0.005	0.004 - 0.006	0.004 - 0.007	0.003 - 0.004	0.5 x DC
	Heat-resistant alloys Inconel 718, etc.	-	66 - 130	0.001 - 0.003	0.001 - 0.004	0.003 - 0.005	0.003 - 0.005	0.004 - 0.006	0.004 - 0.007	0.003 - 0.004	0.5 x DC
H	Hardened steel H13, etc.	40 - 50 HRC	130 - 260	0.001 - 0.003	0.001 - 0.004	0.003 - 0.005	0.003 - 0.005	0.004 - 0.006	0.004 - 0.007	0.003 - 0.004	0.2 x DC
	Hardened steel D2, etc.	50 - 60 HRC	66 - 200	0.001 - 0.003	0.001 - 0.004	0.003 - 0.005	0.003 - 0.005	0.004 - 0.006	0.004 - 0.007	0.003 - 0.004	0.2 x DC

Shoulder milling (VED / VEE: 6 flutes, VED / VEE: 8, 10 flutes)

ISO	Workpiece material	Hardness	Cutting speed Vc (sfm)	Feed per tooth: fz (ipt)						Depth of cut ap (in)	Pick feed Pf (in)
				Tool diameter: DC (in)							
				0.312"	0.375"	0.500"	0.625"	0.750"	1.000"		
S	Titanium alloys Ti-6Al-4V, etc.	-	200 - 400	0.002 - 0.004	0.003 - 0.005	0.003 - 0.005	0.004 - 0.006	0.004 - 0.007	0.004 - 0.007	0.6 x DC	0.02 x DC
	Heat-resistant alloys Inconel 718, etc.	-	100 - 200	0.002 - 0.004	0.003 - 0.005	0.003 - 0.005	0.004 - 0.006	0.004 - 0.007	0.004 - 0.007	0.6 x DC	0.02 x DC
H	Hardened steel H13, H19, etc.	40 - 50 HRC	260 - 530	0.002 - 0.004	0.003 - 0.005	0.003 - 0.005	0.004 - 0.006	0.004 - 0.007	0.004 - 0.007	0.6 x DC	0.02 x DC
	Hardened steel D2, etc.	50 - 60 HRC	130 - 300	0.002 - 0.004	0.003 - 0.005	0.003 - 0.005	0.004 - 0.006	0.004 - 0.007	0.004 - 0.007	0.6 x DC	0.02 x DC

Grade
Insert
Toolholder
Ext. Toolholder
Int. Toolholder
Threading
Grooving
Miniature Tool
Milling Cutter
Endmill
Drilling Tool
Tooling System
Index



TUNGMEISTER

VFX**-02...

2 flute head for high feed milling (TungMeister)

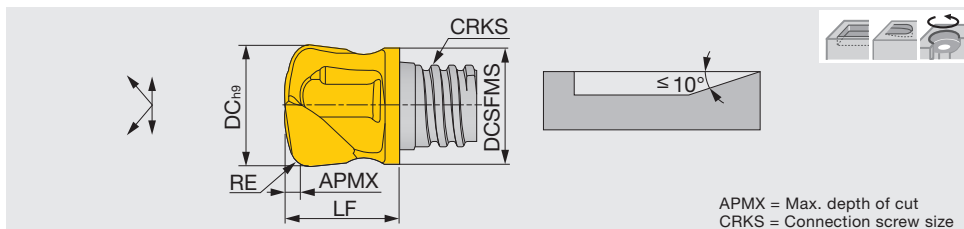

APMX = Max. depth of cut
CRKS = Connection screw size

Inch	AH725	NOF	FHA	DC	DCSFMS	APMX	RE ⁽¹⁾	CRKS	LF	Wrench Torque*	fz (ipt)	
VFX037L02R060-U02S06	●	2	0°	0.375	0.360	0.020	0.059	S06	0.490	KEYV-S06	7.38	0.012 - 0.024
VFX050L03R080-U02S08	●	2	0°	0.500	0.480	0.039	0.079	S08	0.590	KEYV-S08	11.06	0.020 - 0.039
VFX075L05R080-U02S12	●	2	0°	0.750	0.720	0.059	0.079	S12	0.685	KEYV-S12	20.65	0.022 - 0.043

(1) Corner radius for CAM programming

Note: Please use tapered neck shank or tungsten shank for VFX head.

* Torque: Recommended clamping torque: lbs-ft

2 pieces per package

●: Line up



TUNGMEISTER

VFX**-04...

4 flute head for high feed milling (TungMeister)

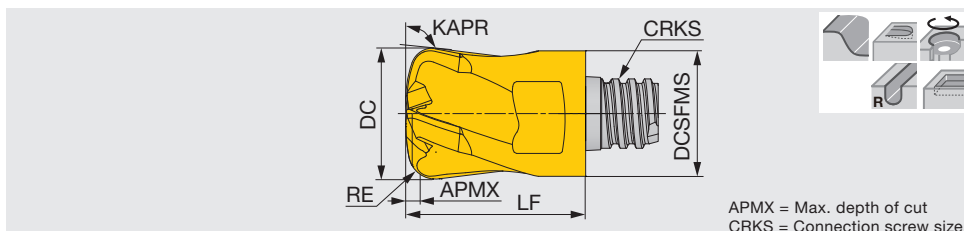

APMX = Max. depth of cut
CRKS = Connection screw size

Metric	AH725	NOF	FHA	DC	DCSFMS	APMX	RE	KAPR	CRKS	LF	Wrench Torque*	fz (mm/t)	
VFX120L0.60R18H04S08	●	4	20°	12	11.5	0.6	1.8	97°	S08	16.5	KEYV-S08	15	0.16-0.67
VFX160L0.80R22H04S10	●	4	20°	16	15.4	0.8	2.2	97°	S10	20.5	KEYV-S10	28	0.2-0.75

* Torque: Recommended clamping torque: N·m
2 pieces per package

●: Line up



STANDARD CUTTING CONDITIONS

High feed milling (VFX)

ISO	Workpiece material	Hardness	Cutting speed V _c (sfm)	Feed per tooth: fz (ipt)				Width of cut ae (in)
				ø0.375"	ø0.500"	ø0.630"	ø0.750"	
P	Low carbon steels 1045, 1055, etc.	- 300 HB	330 - 660	0.012 - 0.028	0.016 - 0.031	0.020 - 0.035	0.024 - 0.040	0.6 x DC
	High carbon steels 4140, 5120, etc.	- 300 HB	260 - 590	0.008 - 0.024	0.012 - 0.028	0.016 - 0.031	0.020 - 0.035	0.6 x DC
	Prehardened steel PX5, NAK80, etc.	30 - 40 HRC	260 - 530	0.008 - 0.020	0.008 - 0.02	0.012 - 0.024	0.012 - 0.024	0.6 x DC
M	Stainless steels S30400, S31600, etc.	- 200 HB	200 - 330	0.008 - 0.024	0.008 - 0.024	0.012 - 0.028	0.012 - 0.028	0.6 x DC
K	Gray cast irons No.250B, No.300B, etc.	150 - 250 HB	330 - 720	0.012 - 0.028	0.016 - 0.031	0.020 - 0.035	0.024 - 0.040	0.6 x DC
	Ductile cast irons 60-40-18, etc.	150 - 250 HB	330 - 720	0.008 - 0.024	0.012 - 0.028	0.016 - 0.031	0.020 - 0.035	0.6 x DC
S	Titanium alloys Ti-6Al-4V, etc.	-	130 - 260	0.008 - 0.020	0.008 - 0.020	0.008 - 0.024	0.008 - 0.024	0.25 x DC
	Heat-resistant alloys Inconel 718, etc.	-	66 - 130	0.004 - 0.012	0.004 - 0.012	0.004 - 0.012	0.004 - 0.012	0.25 x DC
H	Hardened steel H13, etc.	40 - 50 HRC	130 - 260	0.008 - 0.016	0.008 - 0.016	0.012 - 0.020	0.012 - 0.020	0.45 x DC
	Hardened steel D2, etc.	50 - 60 HRC	66 - 200	0.004 - 0.008	0.004 - 0.008	0.004 - 0.012	0.004 - 0.012	0.25 x DC

Feed per tooth should not exceed the maximum value for each product.

TUNGMEISTER

VBB**-BM...

2 flute ball nose head for roughing (TungMeister)

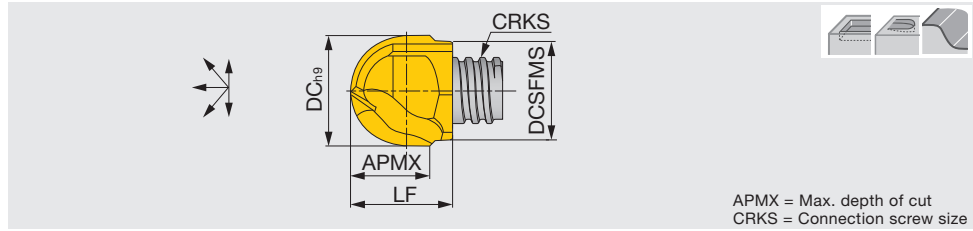

APMX = Max. depth of cut
CRKS = Connection screw size

Inch	AH725	NOF	FHA	DC	DCSFMS	APMX	CRKS	LF	Wrench	Torque*
VBB0312L31-BM-U02S05	●	2	0°	0.312	0.300	0.310	S05	0.390	KEYV-S05	5.16
VBB0375L38-BM-U02S06	●	2	0°	0.375	0.360	0.380	S06	0.478	KEYV-S06	7.38
VBB0500L50-BM-U02S08	●	2	0°	0.500	0.480	0.508	S08	0.646	KEYV-S08	11.06
VBB0625L63-BM-U02S10	●	2	0°	0.625	0.600	0.630	S10	0.750	KEYV-S10	20.65

* Torque: Recommended clamping torque: lbs-ft
2 pieces per package

●: Line up

TUNGMEISTER

VBB**-BG...

2 flute ball nose head for semi-finishing (TungMeister)

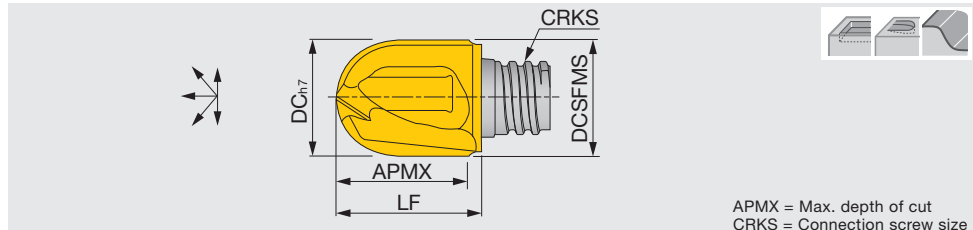

APMX = Max. depth of cut
CRKS = Connection screw size

Inch	AH750	NOF	FHA	DC	DCSFMS	APMX	CRKS	LF	Wrench	Torque*
VBB0312L31-BG-U02S05	●	2	0°	0.312	0.300	0.312	S05	0.390	KEYV-S05	5.16
VBB0375L38-BG-U02S06	●	2	0°	0.375	0.360	0.380	S06	0.480	KEYV-S06	7.38
VBB0500L50-BG-U02S08	●	2	0°	0.500	0.480	0.500	S08	0.640	KEYV-S08	11.06
VBB0625L63-BG-U02S10	●	2	0°	0.625	0.598	0.630	S10	0.752	KEYV-S10	20.65

* Torque: Recommended clamping torque: lbs-ft
2 pieces per package

●: Line up

TUNGMEISTER

VBD**-BG...

Ball nose head with 2 ground flutes for finishing (TungMeister)

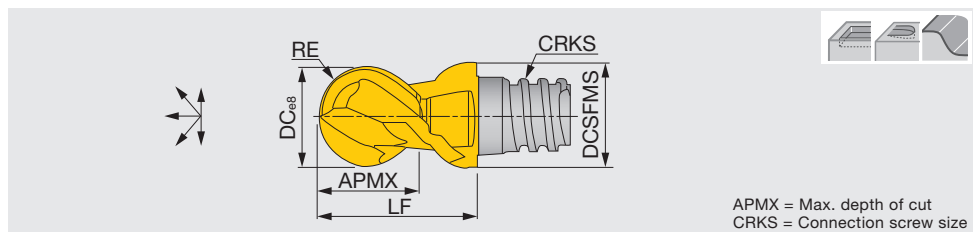

APMX = Max. depth of cut
CRKS = Connection screw size

Inch	AH725	NOF	FHA	DC	DCSFMS	APMX	RE	CRKS	LF	Wrench	Torque*
VBD0312L20-BG-U02S05	●	2	30°	0.312	0.300	0.200	0.156 ⁽¹⁾	S05	0.350	KEYV-S05	5.16
VBD0375L27-BG-U02S06	●	2	30°	0.375	0.360	0.275	0.188 ⁽¹⁾	S06	0.512	KEYV-S06	7.38
VBD0500L37-BG-U02S08	●	2	30°	0.500	0.488	0.374	0.249 ⁽²⁾	S08	0.650	KEYV-S08	11.06
VBD0625L47-BG-U02S10	●	2	30°	0.625	0.600	0.470	0.313 ⁽²⁾	S10	0.800	KEYV-S10	20.65

RE tolerance: (1) ± 0.0004" (2) ± 0.0005"

* Torque: Recommended clamping torque: lbs-ft
2 pieces per package

●: Line up

Reference pages: Standard cutting conditions → I021

Grade
Insert
Toolholder
Ext. Toolholder
Int. Toolholder
Threading
Grooving
Miniature Tool
Milling Cutter
Endmill
Drilling Tool
Tooling System
User's Guide
Index

A
B
C
D
E
F
G
H
I
J
K
L
M

TUNGMEISTER

VBD**-BG..., VBE**-BG...

Ball nose head with 4 ground flutes for finishing (TungMeister)

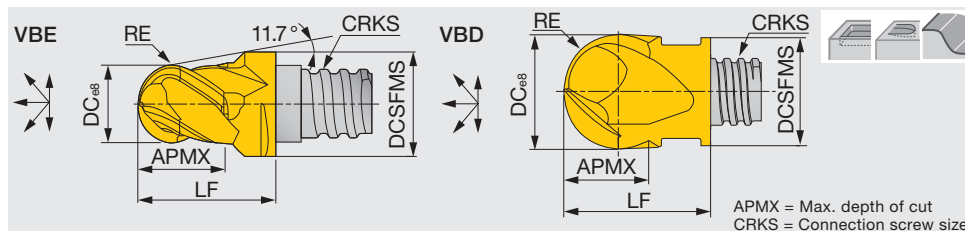
APMX = Max. depth of cut
CRKS = Connection screw size

Inch	AH725	NOF	FHA	DC	DCSFMS	APMX	RE	CRKS	LF	Wrench	Torque*
VBE0250L20-BG-U04S05	●	4	38°	0.250	0.300	0.200	0.124 ⁽¹⁾	S05	0.390	KEYV-S05	5.16
VBE0312L20-BG-U04S05	●	4	30°	0.312	0.300	0.200	0.156 ⁽¹⁾	S05	0.350	KEYV-S05	5.16
VBD0375L27-BG-U04S06	●	4	30°	0.375	0.360	0.275	0.188 ⁽¹⁾	S06	0.512	KEYV-S06	7.38
VBD0500L37-BG-U04S08	●	4	30°	0.500	0.488	0.374	0.249 ⁽²⁾	S08	0.650	KEYV-S08	11.06
VBD0625L47-BG-U04S10	●	4	30°	0.625	0.600	0.470	0.313 ⁽²⁾	S10	0.800	KEYV-S10	20.65
VBD0750L62-BG-U04S12	●	4	30°	0.750	0.720	0.620	0.374 ⁽²⁾	S12	1.000	KEYV-S12	20.65
VBD100L86-BG-U04S15	●	4	30°	1.000	0.940	0.860	0.500 ⁽³⁾	S15	1.450	KEYV-W20	29.50

RE tolerance: (1) ± 0.0004" (2) ± 0.0005" (3) ± 0.0008"

* Torque: Recommended clamping torque: lbs-ft

VBE250, 0312 / VBD0375 ~ 0750: 2 pieces per package, VBD: 1 piece per package

●: Line up

TUNGMEISTER

VBB**-SG...

2 flute ball nose head, with spherical designed edge (TungMeister)

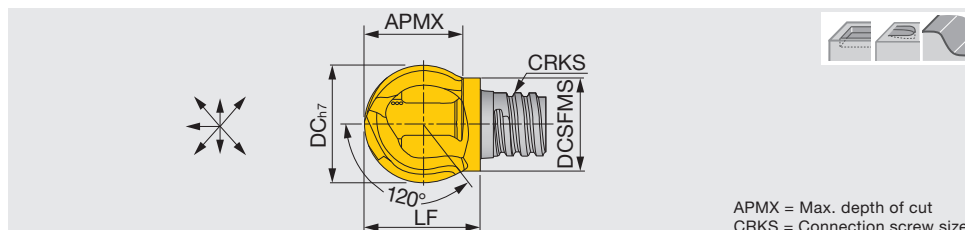
APMX = Max. depth of cut
CRKS = Connection screw size

Inch	AH725	NOF	FHA	DC	DCSFMS	APMX	CRKS	LF	Wrench	Torque*
VBB0375L31-SG-U02S05	●	2	0°	0.375	0.300	0.315	S05	0.389	KEYV-S05	5.16
VBB0500L37-SG-U02S06	●	2	0°	0.500	0.378	0.378	S06	0.482	KEYV-S06	7.38
VBB0625L50-SG-U02S08	●	2	0°	0.625	0.480	0.508	S08	0.606	KEYV-S08	11.06
VBB0750L63-SG-U02S10	●	2	0°	0.750	0.600	0.634	S10	0.710	KEYV-S10	20.65

Also capable of pull cutting on the vertical wall

** The wrench size for these heads is different from the ones for the other head types.

* Torque: Recommended clamping torque: lbs-ft. 2 pieces per package

●: Line up

TUNGMEISTER

VBE**-BGA...

Ball nose head with 2 ground flutes for aluminium machining (TungMeister)

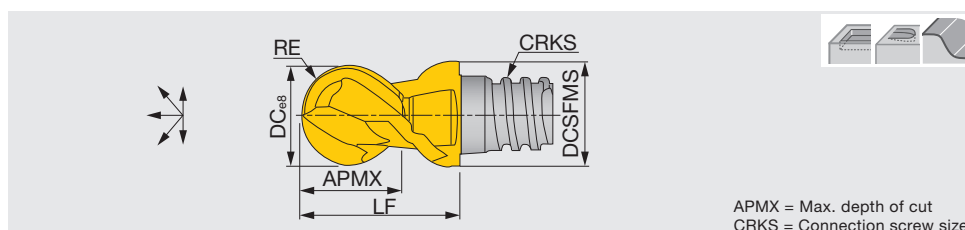
APMX = Max. depth of cut
CRKS = Connection screw size

Inch	KS15F	NOF	FHA	DC	DCSFMS	APMX	RE	CRKS	LF	Wrench	Torque*
VBE0312L20-BGAU02S05	●	2	45°	0.312	0.300	0.200	0.156 ⁽¹⁾	S05	0.390	KEYV-S05	5.16
VBE0375L27-BGAU02S06	●	2	45°	0.375	0.360	0.270	0.187 ⁽¹⁾	S06	0.510	KEYV-S06	7.38
VBE0500L37-BGAU02S08	●	2	45°	0.500	0.488	0.374	0.250 ⁽²⁾	S08	0.650	KEYV-S08	11.06
VBE0625L47-BGAU02S10	●	2	45°	0.625	0.600	0.470	0.312 ⁽²⁾	S10	0.800	KEYV-S10	20.65
VBE0750L50-BGAU02S12	●	2	45°	0.750	0.720	0.500	0.374 ⁽²⁾	S12	1.000	KEYV-S12	20.65

RE tolerance: (1) ± 0.0004" (2) ± 0.0005" * Torque: Recommended clamping torque: lbs-ft. 2 pieces per package

●: Line up

STANDARD CUTTING CONDITIONS

Standard cutting conditions: Roughing (VBB-BM / BG / SG, VBD-BG, VBE-BGA)

ISO	Workpiece material	Hardness	Cutting speed Vc (sfm)	Feed per tooth: fz (ipt)							Depth of cut ap (in)	Pick feed Pf (in)
				Tool diameter: DC (in)								
				0.250"	0.312"	0.375"	0.500"	0.625"	0.750"	1.000"		
P	Low carbon steels 1045, 1055, etc.	- 300 HB	328 - 656	0.001 - 0.003	0.002 - 0.003	0.002 - 0.004	0.002 - 0.004	0.003 - 0.005	0.003 - 0.006	0.003 - 0.006	0.3 x DC	0.4 x DC
	High carbon steels 4140, etc.	- 300 HB	262 - 591	0.001 - 0.003	0.002 - 0.003	0.002 - 0.004	0.002 - 0.004	0.003 - 0.005	0.003 - 0.006	0.003 - 0.006	0.3 x DC	0.4 x DC
	Prehardened steel PX5, NAK80, etc.	30 - 40 HRC	262 - 525	0.001 - 0.003	0.002 - 0.003	0.002 - 0.004	0.002 - 0.004	0.003 - 0.005	0.003 - 0.006	0.003 - 0.006	0.3 x DC	0.4 x DC
M	Stainless steels 304, 316, etc.	- 200 HB	197 - 328	0.001 - 0.003	0.002 - 0.003	0.002 - 0.004	0.002 - 0.004	0.003 - 0.005	0.003 - 0.006	0.003 - 0.006	0.3 x DC	0.4 x DC
K	Gray cast irons 250, 300, etc.	150 - 250 HB	328 - 722	0.001 - 0.003	0.002 - 0.003	0.002 - 0.004	0.002 - 0.004	0.003 - 0.005	0.003 - 0.006	0.003 - 0.006	0.3 x DC	0.4 x DC
	Ductile cast irons 400-15S, etc.	150 - 250 HB	328 - 722	0.001 - 0.003	0.002 - 0.003	0.002 - 0.004	0.002 - 0.004	0.003 - 0.005	0.003 - 0.006	0.003 - 0.006	0.3 x DC	0.4 x DC
N	Aluminum alloys Si < 13%	-	656 - 2297	0.001 - 0.003	0.002 - 0.003	0.002 - 0.004	0.002 - 0.004	0.003 - 0.005	0.003 - 0.006	0.003 - 0.006	0.3 x DC	0.4 x DC
	Aluminum alloys Si ≥ 13%	-	328 - 984	0.001 - 0.003	0.002 - 0.003	0.002 - 0.004	0.002 - 0.004	0.003 - 0.005	0.003 - 0.006	0.003 - 0.006	0.3 x DC	0.4 x DC
S	Titanium alloys Ti-6Al-4V, etc.	-	131 - 262	0.001 - 0.003	0.002 - 0.003	0.002 - 0.004	0.002 - 0.004	0.003 - 0.005	0.003 - 0.006	0.003 - 0.006	0.3 x DC	0.2 x DC
	Heat-resistant alloys Inconel 718, etc.	50 - 60 HRC	66 - 131	0.001 - 0.003	0.002 - 0.003	0.002 - 0.004	0.002 - 0.004	0.003 - 0.005	0.003 - 0.006	0.003 - 0.006	0.3 x DC	0.2 x DC
H	Hardened steel SKD61, SKT4, etc. H13, etc.	-	131 - 262	0.001 - 0.003	0.002 - 0.003	0.002 - 0.004	0.002 - 0.004	0.003 - 0.005	0.003 - 0.006	0.003 - 0.006	0.3 x DC	0.2 x DC
	Hardened steel SKD11, SKH, etc. D2, etc.	50 - 60 HRC	66 - 197	0.001 - 0.003	0.002 - 0.003	0.002 - 0.004	0.002 - 0.004	0.003 - 0.005	0.003 - 0.006	0.003 - 0.006	0.3 x DC	0.2 x DC

Standard cutting conditions: Profiling for semi-finishing and finishing (VBB-BM / BG / SG, VBD-BG, VBE-BGA)

ISO	Workpiece material	Hardness	Cutting speed Vc (sfm)	Feed per tooth: fz (ipt)							Depth of cut ap (in)	Pick feed Pf (in)
				Tool diameter: DC (in)								
				0.250"	0.312"	0.375"	0.500"	0.625"	0.750"	1.000"		
P	Low carbon steels 1045, 1055, etc.	- 300 HB	394 - 820	0.001 - 0.003	0.001 - 0.004	0.002 - 0.004	0.002 - 0.004	0.002 - 0.005	0.002 - 0.007	0.004 - 0.007	0.1 x DC	0.15 x DC
	High carbon steels 4140, etc.	- 300 HB	328 - 722	0.001 - 0.003	0.001 - 0.004	0.002 - 0.004	0.002 - 0.004	0.002 - 0.005	0.002 - 0.007	0.004 - 0.007	0.1 x DC	0.15 x DC
	Prehardened steel PX5, NAK80, etc.	30 - 40 HRC	328 - 656	0.001 - 0.003	0.001 - 0.004	0.002 - 0.004	0.002 - 0.004	0.002 - 0.005	0.002 - 0.007	0.004 - 0.007	0.1 x DC	0.15 x DC
M	Stainless steels 304, 316, etc.	- 200 HB	262 - 394	0.001 - 0.003	0.001 - 0.004	0.002 - 0.004	0.002 - 0.004	0.002 - 0.005	0.002 - 0.007	0.004 - 0.007	0.1 x DC	0.15 x DC
K	Gray cast irons 250, 300, etc.	150 - 250 HB	394 - 919	0.001 - 0.003	0.001 - 0.004	0.002 - 0.004	0.002 - 0.004	0.002 - 0.005	0.002 - 0.007	0.004 - 0.007	0.1 x DC	0.15 x DC
	Ductile cast irons 400-15S, etc.	150 - 250 HB	394 - 919	0.001 - 0.003	0.001 - 0.004	0.002 - 0.004	0.002 - 0.004	0.002 - 0.005	0.002 - 0.007	0.004 - 0.007	0.1 x DC	0.15 x DC
N	Aluminum alloys Si < 13%	-	984 - 3281	0.001 - 0.003	0.001 - 0.004	0.002 - 0.004	0.002 - 0.004	0.002 - 0.005	0.002 - 0.007	0.004 - 0.007	0.1 x DC	0.15 x DC
	Aluminum alloys Si ≥ 13%	-	492 - 1312	0.001 - 0.003	0.001 - 0.004	0.002 - 0.004	0.002 - 0.004	0.002 - 0.005	0.002 - 0.007	0.004 - 0.007	0.1 x DC	0.15 x DC
S	Titanium alloys Ti-6Al-4V, etc.	-	164 - 328	0.001 - 0.003	0.001 - 0.004	0.002 - 0.004	0.002 - 0.004	0.002 - 0.005	0.002 - 0.007	0.004 - 0.007	0.08 x DC	0.1 x DC
	Heat-resistant alloys Inconel 718, etc.	50 - 60 HRC	98 - 164	0.001 - 0.003	0.001 - 0.004	0.002 - 0.004	0.002 - 0.004	0.002 - 0.005	0.002 - 0.007	0.004 - 0.007	0.08 x DC	0.1 x DC
H	Hardened steel SKD61, SKT4, etc. H13, etc.	-	164 - 328	0.001 - 0.003	0.001 - 0.004	0.002 - 0.004	0.002 - 0.004	0.002 - 0.005	0.002 - 0.007	0.004 - 0.007	0.08 x DC	0.1 x DC
	Hardened steel SKD11, SKH, etc. D2, etc.	50 - 60 HRC	98 - 262	0.001 - 0.003	0.001 - 0.004	0.002 - 0.004	0.002 - 0.004	0.002 - 0.005	0.002 - 0.007	0.004 - 0.007	0.08 x DC	0.1 x DC

Grade
Insert
Toolholder
Ext. Toolholder
Int. Toolholder
Threading
Grooving
Miniature Tool
Milling Cutter
Endmill
Drilling Tool
Tooling System
User's Guide
Index

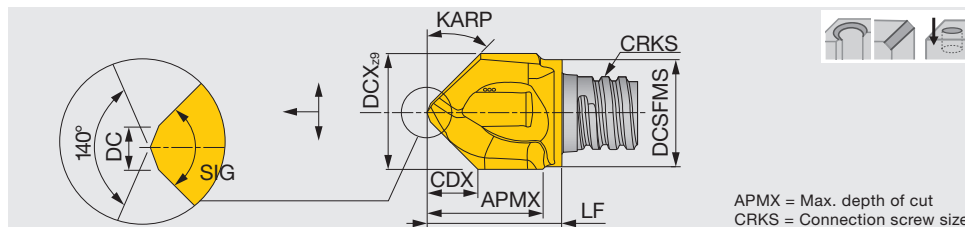

2 flute head, for spot drilling and chamfering (TungMeister)

APMX = Max. depth of cut
CRKS = Connection screw size

Metric	AH725	NOF	SIG	FHA	DCX	DCSFMS	APMX	CDX	CRKS	LF	DC	KARP	Wrench	Torque*
VCP100L09.5A30-02S06	●	2	60°	0°	10	9.5	8.5	7.5	S06	11.75	1.5	60°	KEYV-S06	10
VCP120L12.0A30-02S08	●	2	60°	0°	12	11.5	11	9.2	S08	15.4	1.5	60°	KEYV-S08	15
VCP160L15.0A30-02S10	●	2	60°	0°	16	15.2	16	12	S10	20.2	2.5	60°	KEYV-S10	28
VCP080L07.7A45-02S05	●	2	90°	0°	8	7.6	7.5	3.7	S05	9.75	1	45°	KEYV-S05	7
VCP083L07.9A45-02S05	●	2	90°	0°	8.3	7.6	7.5	3.8	S05	10	1	45°	KEYV-S05	7
VCP100L09.0A45-02S06	●	2	90°	0°	10	9.5	9.5	4.4	S06	11.75	1.5	45°	KEYV-S06	10
VCP104L09.0A45-02S06	●	2	90°	0°	10.4	9.5	9.5	4.6	S06	11.75	1.5	45°	KEYV-S06	10
VCP120L12.0A45-02S08	●	2	90°	0°	12	11.5	11.5	5.4	S08	15.4	1.5	45°	KEYV-S08	15
VCP124L12.0A45-02S08	●	2	90°	0°	12.4	11.5	11.5	5.6	S08	15.4	1.5	45°	KEYV-S08	15
VCP160L15.0A45-02S10	●	2	90°	0°	16	15.2	15	7.1	S10	18.8	1.5	45°	KEYV-S10	28
VCP165L15.0A45-02S10	●	2	90°	0°	16.5	15.2	15	7.1	S10	18.8	1.5	45°	KEYV-S10	28
VCP100L09.5A60-02S06	●	2	120°	0°	10	9.5	9.5	2.7	S06	12.7	1.5	30°	KEYV-S06	10
VCP120L12.0A60-02S08	●	2	120°	0°	12	11.5	11.5	3.3	S08	15.2	1.5	30°	KEYV-S08	15
VCP160L15.5A60-02S10	●	2	120°	0°	16	15.2	16	4.4	S10	19.9	1.5	30°	KEYV-S10	28

●: Line up

Minimum hole diameter ϕ 1.5 mm* Torque: Recommended clamping torque: N·m
2 pieces per package

Square

Radius

High feed

Ball

Chamfering

Slotting

Others

2 flute head, with chamfered edge, for spot drilling (TungMeister)

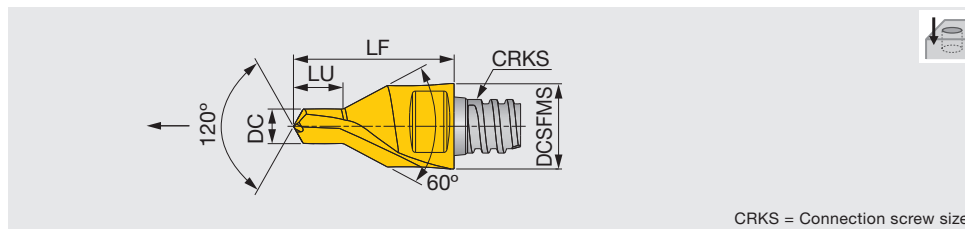

CRKS = Connection screw size

Metric	AH725	NOF	FHA	DC	DCSFMS	LU	CRKS	LF	Wrench	Torque*
VDP328L04.6A30-02S05	●	2	0°	3.28	8	4.6	S05	15	KEYV-S05	7
VDP412L05.9A30-02S06	●	2	0°	4.12	10	5.9	S06	19	KEYV-S06	10
VDP513L07.2A30-02S08	●	2	0°	5.13	12	7.2	S08	23	KEYV-S08	15
VDP646L08.9A30-02S10	●	2	0°	6.46	16	8.9	S10	28	KEYV-S10	28

●: Line up

* Torque: Recommended clamping torque: N·m
2 pieces per package

STANDARD CUTTING CONDITIONS

Drilling (VCP, VDP)

ISO	Workpiece material	Hardness	Cutting speed Vc (sfm)	Feed: f (ipr)				
				VDP328	VDP412	VDP513	VDP646	VCP
P	Low carbon steels 1045, 1055, etc.	- 300 HB	131 - 262	0.0016 - 0.0031	0.0020 - 0.0039	0.0020 - 0.0039	0.0024 - 0.0047	0.0024 - 0.0047
	High carbon steels 4140, etc.	- 300 HB	98 - 164	0.0016 - 0.0031	0.0020 - 0.0039	0.0020 - 0.0039	0.0024 - 0.0047	0.0024 - 0.0047
	Prehardened steel PX5, NAK80, etc.	30 - 40 HRC	66 - 98	0.0016 - 0.0031	0.0020 - 0.0039	0.0020 - 0.0039	0.0024 - 0.0047	0.0024 - 0.0047
M	Stainless steels 304, 316, etc.	- 200 HB	49 - 82	0.0016 - 0.0031	0.0020 - 0.0039	0.0020 - 0.0039	0.0024 - 0.0047	0.0024 - 0.0047
K	Gray cast irons 250, 300, etc.	150 - 250 HB	197 - 328	0.0020 - 0.0035	0.0028 - 0.0047	0.0028 - 0.0047	0.0047 - 0.0071	0.0047 - 0.0071
	Ductile cast irons 400-15S, etc.	150 - 250 HB	197 - 328	0.0016 - 0.0031	0.0020 - 0.0039	0.0020 - 0.0039	0.0039 - 0.0059	0.0039 - 0.0059
S	Titanium alloys Ti-6Al-4V, etc.	-	49 - 82	0.0016 - 0.0028	0.0016 - 0.0028	0.0016 - 0.0028	0.0016 - 0.0028	0.0016 - 0.0028
	Heat-resistant alloys Inconel 718, etc.	-	33 - 66	0.0012 - 0.0024	0.0012 - 0.0024	0.0012 - 0.0024	0.0012 - 0.0024	0.0012 - 0.0024
H	Hardened steel	H13, etc.	40 - 50 HRC	49 - 82	0.0016 - 0.0028	0.0016 - 0.0028	0.0016 - 0.0028	0.0016 - 0.0028
		D2, etc.	50 - 60 HRC	33 - 66	0.0012 - 0.0024	0.0012 - 0.0024	0.0012 - 0.0024	0.0012 - 0.0024

Grade
Insert
Toolholder
Ext. Toolholder
Int. Toolholder
Threading
Grooving
Miniature Tool
Endmill
Drilling Tool
Tooling System
User's Guide
Index



TUNGMEISTER

VGC** -02...

2 flute head, for counterboring (TungMeister)

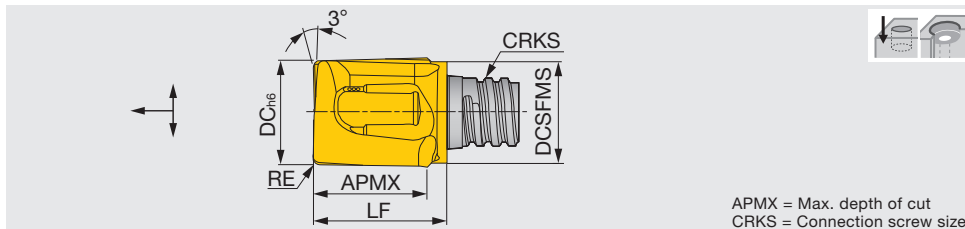

APMX = Max. depth of cut
CRKS = Connection screw size

Inch	AH725	NOF	FHA	DC	DCSFMS	APMX	RE	CRKS	LF	Wrench	Torque*
VGC031L31R016-U02S05	●	2	10°	0.312	0.297	0.310	0.016	S05	0.390	KEYV-S05	5.16
VGC037L38R016-U02S06	●	2	10°	0.375	0.360	0.380	0.016	S06	0.485	KEYV-S06	7.38
VGC050L43R016-U02S08	●	2	10°	0.500	0.453	0.433	0.016	S08	0.600	KEYV-S08	11.06
VGC056L46R016-U02S08	●	2	10°	0.562	0.450	0.460	0.016	S08	0.590	KEYV-S08	11.06
VGC062L60R016-U02S10	●	2	10°	0.625	0.600	0.600	0.016	S10	0.750	KEYV-S10	20.65
VGC062L60R032-U02S10	●	2	10°	0.625	0.600	0.600	0.032	S10	0.750	KEYV-S10	20.65

Also capable of drilling with step feed (Max. depth = ap x 0.020")

* Torque: Recommended clamping torque: lbs-ft
2 pieces per package

●: Line up



STANDARD CUTTING CONDITIONS

Counter boring (VGC)

ISO	Workpiece material	Hardness	Cutting speed Vc (sfm)	Feed per tooth fz (ipt)
P	Low carbon steels 1045, 1055, etc.	- 300 HB	131 - 262	0.002 - 0.003
	High carbon steels 4140, etc.	- 300 HB	98 - 164	0.002 - 0.003
	Prehardened steel PX5, NAK80, etc.	30 - 40 HRC	66 - 98	0.002 - 0.003
M	Stainless steels 304, 316, etc.	- 200 HB	49 - 82	0.002 - 0.003
K	Gray cast irons 250, 300, etc.	150 - 250 HB	197 - 328	0.002 - 0.004
	Ductile cast irons 400-15S, etc.	150 - 250 HB	197 - 328	0.002 - 0.003
S	Titanium alloys Ti-6Al-4V, etc.	-	49 - 82	0.002 - 0.003
	Heat-resistant alloys Inconel 718, etc.	-	33 - 66	0.001 - 0.002
H	Hardened steel	H13, etc.	49 - 82	0.002 - 0.003
		D2, etc.	33 - 66	0.001 - 0.002

- When drilling, the step feed (pecking) operation should be applied with the depth of 0.011" - 0.019" per step.
- Apply the same cutting conditions as the VEE type head when conducting shoulder milling or slotting operations.

Grade
Insert
Ext. Toolholder
Int. Toolholder
Threading
Grooving
Miniature Tool
Endmill
Drilling Tool
Tooling System
User's Guide
Index



TUNGMEISTER

VCA**-04,06...

4 or 6 flute head, without center cutting edge, for countersinking and chamfering (TungMeister)

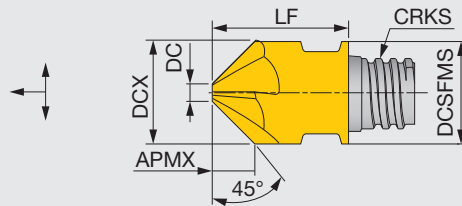
APMX = Max. depth of cut
CRKS = Connection screw size

Inch	AH725	NOF	FHA	DCX	DCSFMS	APMX	DC	CRKS	LF	Wrench	Torque
VCA0375L16A45-U04S06	●	4	0°	0.375	0.375	0.150	0.073	S06	0.512	KEYV-S06	7.38
Metric	AH725	NOF	FHA	DCX	DCSFMS	APMX	DC	CRKS	LF	Wrench	Torque*
VCA100L04.0A45-04S06	●	4	0°	10	10	4	1.95	S06	13	KEYV-S06	10
VCA120L05.0A45-04S08	●	4	0°	12	12	5	1.95	S08	16.5	KEYV-S08	15
VCA127L05.3A45-04S08	●	4	0°	12.7	12.7	5.3	1.98	S08	16.5	KEYV-S08	15
VCA160L06.5A45-06S10	●	6	0°	16	16	6.5	3	S10	20.3	KEYV-S10	28
VCA200L07.5A45-06S12	●	6	0°	20	18.3	7.5	5	S12	25.5	KEYV-S12	28

* Torque: Recommended clamping torque: lbs-ft (*N·m)
2 pieces per package

●: Line up

TUNGMEISTER

VCW**-02...

2 flute head, for front and back chamfering (TungMeister)

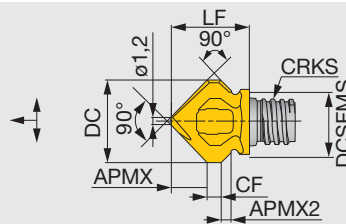
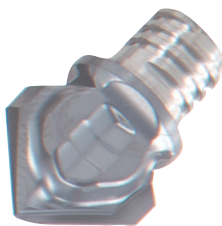
APMX = Max. depth of cut
CRKS = Connection screw size

Metric	AH725	NOF	FHA	DC	DCSFMS	APMX	APMX2	CF	CRKS	LF	Wrench	Torque*
VCW118L05.0A45-02S06	●	2	0°	11.8	9.3	5	1.2	2	S06	11.2	KEYV-S08	10

Also capable of reverse chamfering
* The wrench size for these heads is different from the ones for the other head types.
* Torque: Recommended clamping torque: N·m
2 pieces per package

●: Line up

TUNGMEISTER

VCR**-02...

2 flute head, for concave radius chamfering (TungMeister)

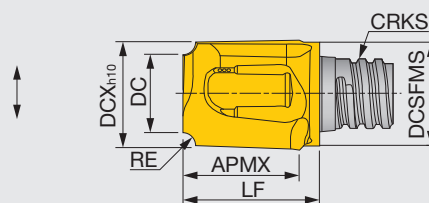
APMX = Max. depth of cut
CRKS = Connection screw size

Metric	AH725	NOF	FHA	DCX	DCSFMS	DC	APMX	RE	CRKS	LF	Wrench	Torque*
VCR080L07.5R10-02S05	●	2	0°	8	7.6	5.8	7.5	1	S05	10.5	KEYV-S05	7
VCR100L09.5R16-02S06	●	2	0°	10	9.5	6.8	9.5	1.6	S06	12.5	KEYV-S06	10
VCR100L09.5R25-02S06	●	2	0°	10	9.5	5.1	9.5	2.5	S06	12.5	KEYV-S06	10
VCR127L12.0R30-02S08	●	2	0°	12.7	12.2	6.5	12	3	S08	15.6	KEYV-S08	15
VCR127L12.0R40-02S08	●	2	0°	12.7	12.2	4.7	12	4	S08	15.6	KEYV-S08	15
VCR160L15.0R50-02S10	●	2	0°	16	15.2	6.2	15	5	S10	19.1	KEYV-S10	28
VCR200L07.0R60-02S12	●	2	0°	20	18.3	8	7	6	S12	17.4	KEYV-S12	28

* Torque: Recommended clamping torque: N·m
2 pieces per package

●: Line up

Reference pages: Standard cutting conditions → I027

STANDARD CUTTING CONDITIONS

Chamfering and countersinking (VCA, VCW, VCR)

ISO	Workpiece material	Hardness	Cutting speed Vc (sfm)	Feed f (ipr)
P	Low carbon steels 1045, 1055, etc.	- 300 HB	197 - 328	0.0024 - 0.0047
	High carbon steels 4140, etc.	- 300 HB	164 - 262	0.0024 - 0.0047
M	Prehardened steel PX5, NAK80, etc.	30 - 40 HRC	131 - 230	0.0024 - 0.0047
	Stainless steels SUS304, SUS316, etc. 304, 316, etc.	- 200 HB	98 - 164	0.0024 - 0.0047
K	Gray cast irons 250, 300, etc.	150 - 250 HB	262 - 394	0.0024 - 0.0047
	Ductile cast irons 400-15S, etc.	150 - 250 HB	262 - 394	0.0024 - 0.0047
N	Aluminum alloys	-	328 - 656	0.0031 - 0.0059
S	Titanium alloys Ti-6Al-4V, etc.	-	98 - 164	0.0020 - 0.0039
	Heat-resistant alloys Inconel 718, etc.	-	66 - 131	0.0016 - 0.0031
H	Hardened steel	H13, etc.	40 - 50 HRC	98 - 164
		D2, etc.	50 - 60 HRC	66 - 131

TOLERANCE OF TOOL DIAMETER

Basic dimensions (in)		Permissible dimensional deviations (µm)						
>	≤	e8	e9	h6	h7	h9	h10	z9
0.236	0.394	-25 -47	-25 -61	0 -9	0 -15	0 -36	0 -58	+78 +42
0.394	0.551	-32 -59	-32 -75	0 -11	0 -18	0 -43	0 -70	+93 +50
0.551	0.709	-32 -59	-32 -75	0 -11	0 -18	0 -43	0 -70	+103 +60
0.709	1.181	-40 -73	-40 -92	0 -13	0 -21	0 -52	0 -84	-

JISB0401-2: 1998 (ISO286-2: 1988) extract

Grade
Insert
Toolholder
Ext. Toolholder
Int. Toolholder
Threading
Grooving
Tool
Miniature Tool
Milling Cutter
Endmill
Drilling Tool
Tooling System
User's Guide
Index



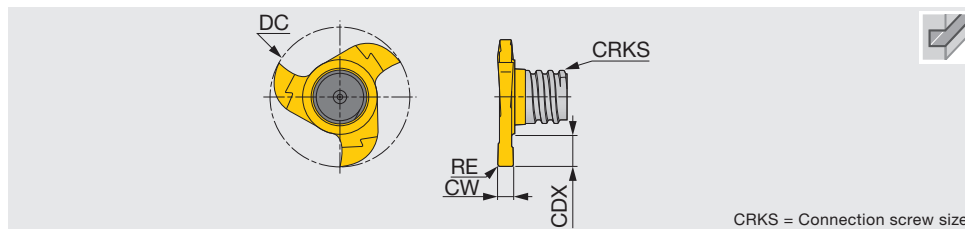

CRKS = Connection screw size

Metric	GH130	NOF	FHA	DC	CW ^{0.02}	RE	CRKS	CDX	Wrench	Torque*
VST157W1.50R010-3S06	●	3	0°	15.7	1.5	0.1	S06	2.8	KEYV-177	10
VST157W1.57R020-3S06	●	3	0°	15.7	1.57	0.2	S06	2.8	KEYV-177	10
VST157W2.00R020-3S06	●	3	0°	15.7	2	0.2	S06	2.8	KEYV-177	10
VST157W2.39R020-3S06	●	3	0°	15.7	2.39	0.2	S06	2.8	KEYV-177	10
VST157W2.50R020-3S06	●	3	0°	15.7	2.5	0.2	S06	2.8	KEYV-177	10
VST157W3.00R020-3S06	●	3	0°	15.7	3	0.2	S06	2.8	KEYV-177	10
VST157W3.17R020-3S06	●	3	0°	15.7	3.17	0.2	S06	2.8	KEYV-177	10
VST177W1.20R005-3S06	●	3	0°	17.7	1.2 ⁽¹⁾	0.05	S06	3.8	KEYV-177	10
VST177W1.40R005-3S06	●	3	0°	17.7	1.4 ⁽¹⁾	0.05	S06	3.8	KEYV-177	10
VST177W1.50R010-3S06	●	3	0°	17.7	1.5	0.1	S06	3.8	KEYV-177	10
VST177W1.57R020-3S06	●	3	0°	17.7	1.57	0.2	S06	3.8	KEYV-177	10
VST177W1.70R005-3S06	●	3	0°	17.7	1.7 ⁽¹⁾	0.05	S06	3.8	KEYV-177	10
VST177W2.00R020-3S06	●	3	0°	17.7	2	0.2	S06	3.8	KEYV-177	10
VST177W2.20R110-3S06	●	3	0°	17.7	2.2	1.1	S06	3.8	KEYV-177	10
VST177W2.39R020-3S06	●	3	0°	17.7	2.39	0.2	S06	3.8	KEYV-177	10
VST177W2.50R020-3S06	●	3	0°	17.7	2.5	0.2	S06	3.8	KEYV-177	10
VST177W3.00R020-3S06	●	3	0°	17.7	3	0.2	S06	3.8	KEYV-177	10
VST177W3.17R020-3S06	●	3	0°	17.7	3.17	0.2	S06	3.8	KEYV-177	10

(1) CW is based on DIN471/472.

* Torque: Recommended clamping torque: N·m

2 pieces per package

●: Line up



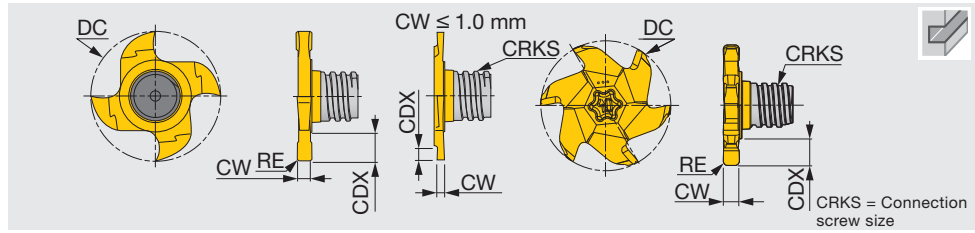

Metric	GH130	NOF	FHA	DC	CW ^{0.02}	RE	CRKS	CDX	Wrench	Torque*
VST217W0.76R000-4S08	●	4	0°	21.7	0.76 ⁽¹⁾	-	S08	1.5	KEYV-217	15
VST217W0.86R000-4S08	●	4	0°	21.7	0.86 ⁽¹⁾	-	S08	1.7	KEYV-217	15
VST217W0.96R000-4S08	●	4	0°	21.7	0.96 ⁽¹⁾	-	S08	1.9	KEYV-217	15
VST217W1.00R005-4S08	●	4	0°	21.7	1	0.05	S08	2	KEYV-217	15
VST217W1.20R005-4S08	●	4	0°	21.7	1.2 ⁽¹⁾	0.05	S08	4.5	KEYV-217	15
VST217W1.40R005-4S08	●	4	0°	21.7	1.4 ⁽¹⁾	0.05	S08	4.5	KEYV-217	15
VST217W1.57R000-4S08	●	4	0°	21.7	1.57	-	S08	4.5	KEYV-217	15
VST217W1.70R010-4S08	●	4	0°	21.7	1.7 ⁽¹⁾	0.1	S08	4.5	KEYV-217	15
VST217W1.95R020-4S08	●	4	0°	21.7	1.95 ⁽¹⁾	0.2	S08	4.5	KEYV-217	15
VST217W2.00R020-4S08	●	4	0°	21.7	2	0.2	S08	4.5	KEYV-217	15
VST217W2.25R020-4S08	●	4	0°	21.7	2.25 ⁽¹⁾	0.2	S08	4.5	KEYV-217	15
VST217W2.39R020-4S08	●	4	0°	21.7	2.39	0.2	S08	4.5	KEYV-217	15
VST217W2.50R020-4S08	●	4	0°	21.7	2.5	0.2	S08	4.5	KEYV-217	15
VST217W2.75R020-4S08	●	4	0°	21.7	2.75 ⁽¹⁾	0.2	S08	4.5	KEYV-217	15
VST217W3.00R020-4S08	●	4	0°	21.7	3	0.2	S08	4.5	KEYV-217	15
VST217W3.17R020-4S08	●	4	0°	21.7	3.17	0.2	S08	4.5	KEYV-217	15
VST217W3.25R020-4S08	●	4	0°	21.7	3.25 ⁽¹⁾	0.2	S08	4.5	KEYV-217	15
VST217W4.00R020-4S08	●	4	0°	21.7	4	0.2	S08	4.5	KEYV-217	15
VST217W4.25R020-4S08	●	4	0°	21.7	4.25 ⁽¹⁾	0.2	S08	4.5	KEYV-217	15
VST217W4.75R020-4S08	●	4	0°	21.7	4.75	0.2	S08	4.5	KEYV-217	15
VST217W5.25R020-4S08	●	4	0°	21.7	5.25 ⁽¹⁾	0.2	S08	4.5	KEYV-217	15
VST277W2.50R020-6S10	●	6	0°	27.7	2.5	0.2	S10	6	KEYV-T40L	28
VST277W5.25R020-6S10	●	6	0°	27.7	5.25	0.2	S10	6	KEYV-T40L	28
VST277W10.0R020-6S10	●	6	0°	27.7	10	0.2	S10	6	KEYV-T40L	28

(1) CW is based on DIN471/472.

* Torque: Recommended clamping torque: N·m
2 pieces per package

●: Line up

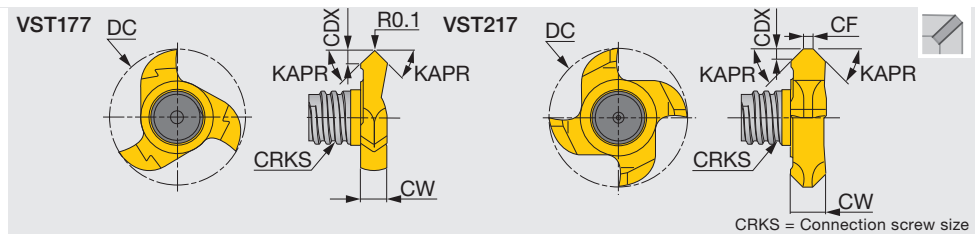

Metric	GH130	NOF	FHA	DC	CW	KAPR	CRKS	CDX	CF	Wrench	Torque*
VST177L01.40A45-3S06	●	3	0°	17.7	3.4	45°	S06	1.4	-	KEYV-177	10
VST217L01.70A45-4S08	●	4	0°	21.7	5.5	45°	S08	1.7	1.5	KEYV-217	15

* Torque: Recommended clamping torque: N·m
2 pieces per package

●: Line up



TUNGMEISTER

VTB**-06...

6 tooth T-slotting head, 0.125" - 0.312" slot width (TungMeister)

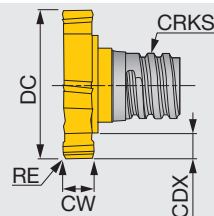

CRKS = Connection screw size

Inch	GH130	NOF	FHA	DC - 0.002"	CW ± 0.0008"	CDX	CRKS	RE	Wrench	Torque*
VTB05W125R016-U06S05	●	6	0°	0.500	0.125	0.088	S05	0.016	KEYV-T20	5.16
VTB06W056R016-U06S06	●	6	0°	0.625	0.056	0.125	S06	0.016	KEYV-T20	7.38
VTB06W063R016-U06S06	●	6	0°	0.625	0.063	0.125	S06	0.016	KEYV-T20	7.38
VTB06W068R016-U06S06	●	6	0°	0.625	0.068	0.125	S06	0.016	KEYV-T20	7.38
VTB06W078R016-U06S06	●	6	0°	0.625	0.078	0.125	S06	0.016	KEYV-T20	7.38
VTB06W086R016-U06S06	●	6	0°	0.625	0.086	0.125	S06	0.016	KEYV-T25	7.38
VTB06W105R016-U06S06	●	6	0°	0.625	0.105	0.125	S06	0.016	KEYV-T25	7.38
VTB06W125R016-U06S06	●	6	0°	0.625	0.125	0.125	S06	0.016	KEYV-T25	7.38
VTB06W156R016-U06S06	●	6	0°	0.625	0.156	0.125	S06	0.016	KEYV-T25	7.38
VTB07W156R016-U06S08	●	6	0°	0.750	0.156	0.120	S08	0.016	KEYV-T30L	11.06
VTB07W187R016-U06S08	●	6	0°	0.750	0.187	0.120	S08	0.016	KEYV-T30L	11.06
VTB07W250R016-U06S08	●	6	0°	0.750	0.250	0.120	S08	0.016	KEYV-T30L	11.06
VTB08W187R016-U06S08	●	6	0°	0.875	0.187	0.190	S08	0.015	KEYV-T40L	11.06
VTB08W250R016-U06S08	●	6	0°	0.875	0.250	0.190	S08	0.015	KEYV-T40L	11.06
VTB08W312R016-U06S08	●	6	0°	0.875	0.312	0.190	S08	0.015	KEYV-T40L	11.06
VTB10W187R016-U06S10	●	6	0°	1.000	0.187	0.177	S10	0.015	KEYV-T50L	20.65
VTB10W250R016-U06S10	●	6	0°	1.000	0.250	0.177	S10	0.015	KEYV-T50L	20.65

* Torque: Recommended clamping torque: lbs-ft
2 pieces per package

●: Line up

Square

Radius

High feed

Ball

Chamfering

Slotting

Others

2

3

4

5

6
or more**TUNGMEISTER**

VTB**C006...

6 tooth T-slotting head, with chamfered edge, 0.062" - 0.078" slot width (TungMeister)

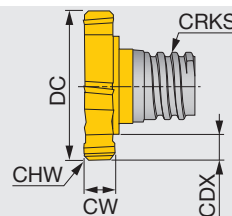

CRKS = Connection screw size

Inch	GH130	NOF	FHA	DC - 0.002"	CW ± 0.002"	CDX	CRKS	CHW	Wrench	Torque*
VTB05W062C006-U06S05	●	6	0°	0.500	0.062	0.089	S05	0.006	KEYV-T20	5.16
VTB05W078C006-U06S05	●	6	0°	0.500	0.078	0.089	S05	0.006	KEYV-T20	5.16

* Torque: Recommended clamping torque: lbs-ft
2 pieces per package

●: Line up

Reference pages: Standard cutting conditions → I031

STANDARD CUTTING CONDITIONS

Slotting (VST, VTB)

ISO	Workpiece material	Hardness HB	VST type		VTB type	
			Cutting speed Vc (sfm)	Feed per tooth fz (ipt)	Cutting speed Vc (sfm)	Feed per tooth fz (ipt)
P	Low carbon steels 1045, 1055, etc.	- 300	262 - 591	0.002 - 0.006	262 - 591	0.003 - 0.007
	High carbon steels 4140, etc.	- 300	197 - 394	0.002 - 0.005	197 - 394	0.002 - 0.006
M	Stainless steels 304, 316, etc.	- 200	164 - 394	0.002 - 0.005	164 - 394	0.002 - 0.006
K	Gray cast irons 250, 300, etc.	150 - 250	328 - 656	0.002 - 0.006	328 - 656	0.003 - 0.007
	Ductile cast irons 400-15S, etc.	150 - 250	328 - 656	0.002 - 0.005	328 - 656	0.002 - 0.006
N	Aluminum alloys Si < 13%	-	656 - 1969	0.002 - 0.006	656 - 1969	0.003 - 0.007
	Aluminium alloys Si ≥ 13%	-	328 - 984	0.001 - 0.005	328 - 984	0.002 - 0.006
S	Titanium alloys Ti-6Al-4V, etc.	-	131 - 197	0.002 - 0.003	131 - 197	0.002 - 0.006
	Heat-resistant alloys Inconel 718, etc.	-	49 - 115	0.001 - 0.004	49 - 115	0.001 - 0.004

Grade
Insert
Toolholder
Ext. Toolholder
Int. Toolholder
Threading
Grooving
Miniature Tool
Endmill
Drilling Tool
Tooling System
User's Guide
Index



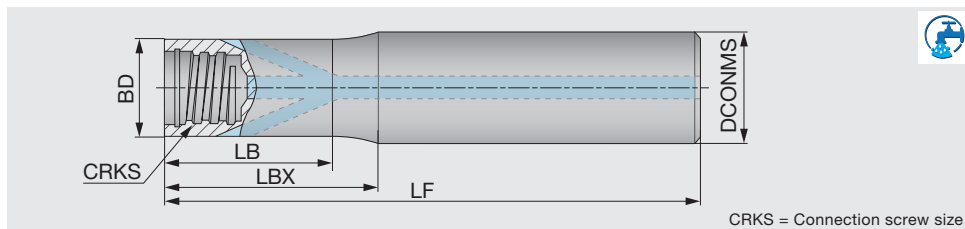

Metric	DCONMS	BD	LF	LBX	LB	CRKS	Shank shape	Shank material
VSSD10L070S06-W-A	10	9.6	70	20	19	S06	Cylindrical	Tungsten
VSSD10L090S06-W-A	10	9.6	90	40	39	S06	Cylindrical	Tungsten
VSSD10L110S06-W-A	10	9.6	110	60	59	S06	Cylindrical	Tungsten
VSSD12L070S08-W-A	12	11.5	70	20	19	S08	Cylindrical	Tungsten
VSSD12L090S08-W-A	12	11.5	90	40	39	S08	Cylindrical	Tungsten
VSSD12L110S08-W-A	12	11.5	110	60	59	S08	Cylindrical	Tungsten
VSSD12L130S08-W-A	12	11.5	130	80	79	S08	Cylindrical	Tungsten
VSSD16L070S10-W-A	16	15.2	70	20	18.5	S10	Cylindrical	Tungsten
VSSD16L090S10-W-A	16	15.2	90	40	36.5	S10	Cylindrical	Tungsten
VSSD16L110S10-W-A	16	15.2	110	60	58.5	S10	Cylindrical	Tungsten
VSSD16L130S10-W-A	16	15.2	130	80	78.5	S10	Cylindrical	Tungsten
VSSD20L090S12-W-A	20	18.3	90	40	37	S12	Cylindrical	Tungsten
VSSD20L130S12-W-A	20	18.3	130	80	77	S12	Cylindrical	Tungsten



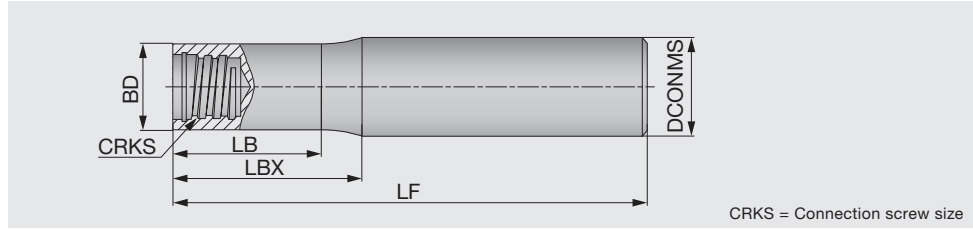

CRKS = Connection screw size

Inch	DCONMS	BD	LF	LBX	LB	CRKS	Shank shape	Shank material
VSS031L250S05US	0.312	0.300	2.500	0.590	0.510	S05	Cylindrical	Steel
VSS031L300S05UC	0.312	0.300	3.000	1.000	0.950	S05	Cylindrical	Carbide
VSS031L350S05UC	0.312	0.300	3.500	1.500	1.450	S05	Cylindrical	Carbide
VSS031L400S05UC	0.312	0.300	4.000	2.000	1.950	S05	Cylindrical	Carbide
VSS031L300S05UW	0.312	0.299	3.000	1.000	0.978	S05	Cylindrical	Tungsten
VSS031L450S05UW	0.312	0.299	4.500	2.000	1.978	S05	Cylindrical	Tungsten
VSS037L300S06US	0.375	0.364	3.000	0.787	0.768	S06	Cylindrical	Steel
VSS037L400S06UC	0.375	0.364	4.000	1.250	1.200	S06	Cylindrical	Carbide
VSS037L475S06UC	0.375	0.364	4.750	2.000	1.950	S06	Cylindrical	Carbide
VSS037L355S06UW	0.375	0.364	3.550	0.750	0.680	S06	Cylindrical	Tungsten
VSS050L350S08US	0.500	0.480	3.540	0.630	0.530	S08	Cylindrical	Steel
VSS050L400S08UC	0.500	0.480	4.000	1.500	1.400	S08	Cylindrical	Carbide
VSS050L550S08UC	0.500	0.480	5.500	2.500	2.450	S08	Cylindrical	Carbide
VSS050L425S08UW	0.500	0.480	4.250	0.630	0.530	S08	Cylindrical	Tungsten
VSS062L400S10US	0.625	0.598	4.000	0.780	0.680	S10	Cylindrical	Steel
VSS062L325S10UC	0.625	0.600	3.250	1.250	1.180	S10	Cylindrical	Carbide
VSS062L450S10UC	0.625	0.600	4.500	2.500	2.430	S10	Cylindrical	Carbide
VSS062L550S10UC	0.625	0.600	5.500	3.500	3.430	S10	Cylindrical	Carbide
VSS062L700S10UC	0.625	0.600	7.000	5.000	4.930	S10	Cylindrical	Carbide
VSS075L500S12US	0.750	0.720	5.000	1.000	0.880	S12	Cylindrical	Steel
VSS075L400S12UC	0.750	0.720	4.000	1.500	1.430	S12	Cylindrical	Carbide
VSS075L550S12UC	0.750	0.720	5.500	3.000	2.930	S12	Cylindrical	Carbide
VSS075L800S12UC	0.750	0.720	8.000	4.500	4.430	S12	Cylindrical	Carbide
VSS100L537S15US	1.000	0.957	5.375	1.375	1.313	S15	Cylindrical	Steel
VSS100L475S15UC	1.000	0.957	4.750	2.375	2.313	S15	Cylindrical	Carbide
VSS100L675S15UC	1.000	0.957	6.750	4.000	3.938	S15	Cylindrical	Carbide
VSS100L1000S15UC	1.000	0.957	10.000	6.000	5.938	S15	Cylindrical	Carbide

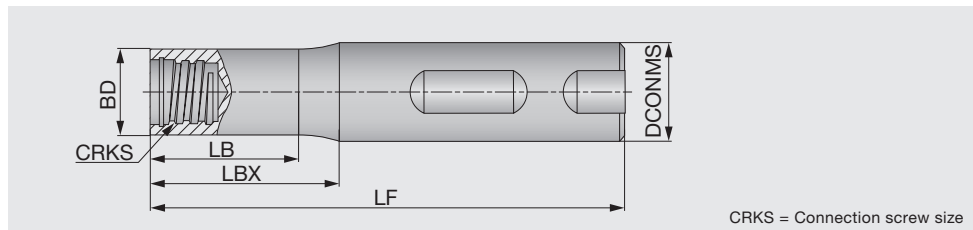

CRKS = Connection screw size

Inch	DCONMS	BD	LF	LBX	LB	CRKS	Shank shape	Shank material
VSS050L218W05US	0.500	0.299	2.185	0.150	-	S05	Weldon	Steel
VSS062L258W06US	0.625	0.366	2.580	0.236	-	S06	Weldon	Steel
VSS062L258W08US	0.625	0.480	2.580	0.157	-	S08	Weldon	Steel
VSS075L275W10US	0.750	0.598	2.750	0.157	-	S10	Weldon	Steel
VSS100L300W12US	1.000	0.720	3.000	0.283	-	S12	Weldon	Steel

Metric	DCONMS	BD	LF	LBX	LB	CRKS	Shank	Material
VSSD12L055W05-S	12	7.6	55	3.8	-	S05	Weldon	Steel
VSSD16L065W06-S	16	9.6	65	6	-	S06	Weldon	Steel
VSSD16L065W08-S	16	11.5	65	4	-	S08	Weldon	Steel
VSSD20L070W10-S	20	15.2	70	4	-	S10	Weldon	Steel
VSSD25L075W12-S	25	18.3	75	6	-	S12	Weldon	Steel



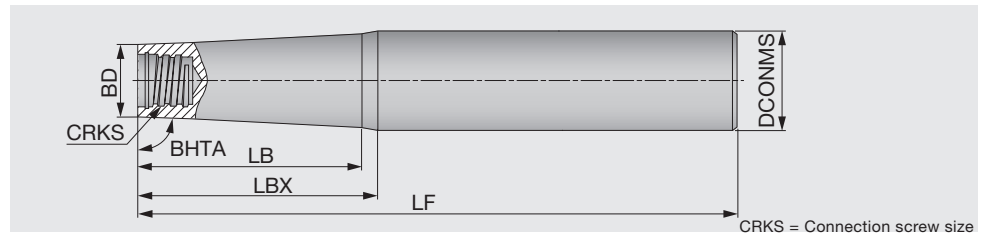

CRKS = Connection screw size

Inch	BHTA	DCONMS	BD	LF	LBX	LB	CRKS	Material
VTS050L300S05US	85°	0.500	0.300	3.000	1.000	0.930	S05	Steel
VTS050L400S05US	89°	0.500	0.300	4.000	1.500	1.300	S05	Steel
VTS062L500S06US	85°	0.625	0.370	5.000	1.380	1.283	S06	Steel
VTS062L630S06US	89°	0.625	0.364	6.300	2.170	1.750	S06	Steel
VTS062L550S08US	85°	0.625	0.480	5.500	0.870	0.770	S08	Steel
VTS075L650S08US	89°	0.750	0.480	6.500	3.150	2.770	S08	Steel
VTS075L550S10US	85°	0.750	0.598	5.500	0.880	-	S10	Steel
VTS100L670S10US	89°	1.000	0.598	6.700	2.295	-	S10	Steel
VTS075L750S10US	89°	0.750	0.600	7.500	3.150	2.950	S10	Steel
VTS100L630S12US	89°	1.000	0.720	6.300	1.600	-	S12	Steel
VTS100L800S12US	89°	1.000	0.720	8.000	3.750	3.400	S12	Steel
VTS125L600S15US	85°	1.250	0.957	6.000	1.750	1.594	S15	Steel
VTS125L750S12US	89°	1.250	0.720	7.500	3.150	-	S12	Steel
VTS037L350S05UC	89°	0.375	0.300	3.500	1.500	-	S05	Carbide
VTS050L450S05UC	89°	0.500	0.300	4.500	2.500	2.354	S05	Carbide
VTS062L600S05UC	89°	0.625	0.300	6.000	4.000	3.900	S05	Carbide
VTS050L550S06UC	89°	0.500	0.364	5.500	2.500	2.470	S06	Carbide
VTS062L650S06UC	89°	0.625	0.364	6.500	3.500	3.380	S06	Carbide
VTS062L650S08UC	89°	0.625	0.480	6.500	3.500	3.440	S08	Carbide
VTS075L700S08UC	89°	0.750	0.480	7.000	4.000	3.900	S08	Carbide
VTS075L650S10UC	89°	0.750	0.600	6.500	4.000	-	S10	Carbide
VTS075L880S10UC	89°	0.750	0.600	8.800	6.300	6.240	S10	Carbide
VTS100L1000S12UC	89°	1.000	0.720	10.000	5.500	-	S12	Carbide
VTS125L1000S15UC	89°	1.250	0.957	10.000	6.000	-	S15	Carbide
VTS125L1200S15UC	89°	1.250	0.941	12.000	8.000	-	S15	Carbide
VTS075L550S06UW	85°	0.750	0.370	5.500	2.240	-	S06	Tungsten
VTS062L670S06UW	89°	0.625	0.364	6.700	2.180	1.770	S06	Tungsten
VTS075L670S08UW	89°	0.750	0.480	6.700	3.150	2.770	S08	Tungsten

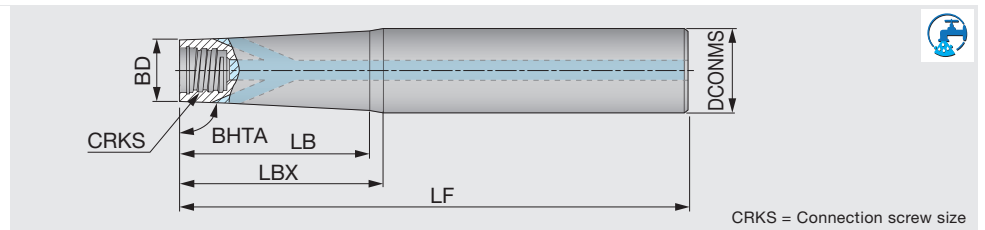

CRKS = Connection screw size

Metric	BHTA	DCONMS	BD	LF	LBX	LB	CRKS	Shank shape	Shank material
VTSD12L110S06-W-A	89°	12	9.6	110	60	59	S06	Cylindrical	Tungsten
VTSD16L170S06-W-A	89°	16	9.6	170	120	116	S06	Cylindrical	Tungsten

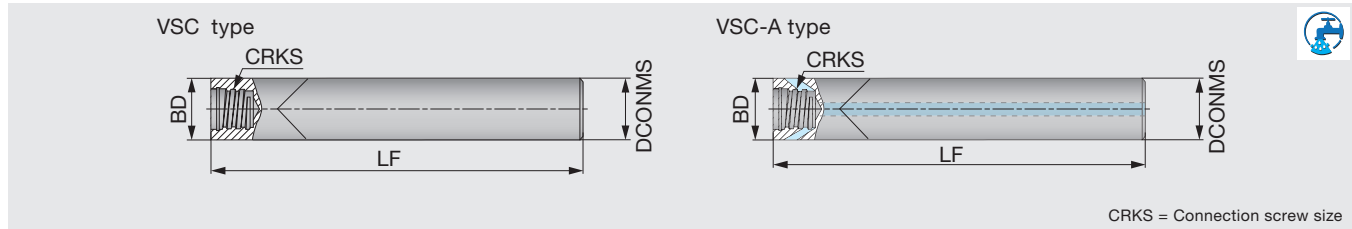

CRKS = Connection screw size

Inch	DCONMS	BD	LF	CRKS	Coolant hole	Shank shape	Shank material
VSC095L080S06-C	0.375	0.375	3.150	S06	Without	Cylindrical	Carbide
VSC127L120S08-C-A	0.500	0.500	4.724	S08	With	Cylindrical	Carbide
Metric	DCONMS	BD	LF	CRKS	Coolant hole	Shank shape	Shank material
VSC100L100S06-C	10	10	100	S06	Without	Cylindrical	Carbide
VSC120L100S08-C-A	12	12	100	S08	With	Cylindrical	Carbide

VSC shank should be used with VST slotting head.
If other types of heads are used, please be sure not to exceed the maximum depth of cut for each head (See ap for each head).
VSC shank does not have external clearance, and it may interfere with the workpiece during machining.

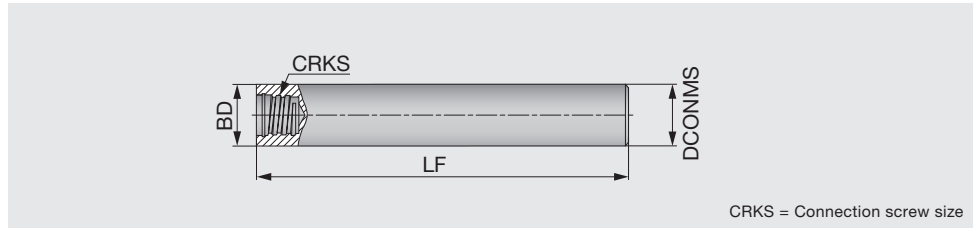

CRKS = Connection screw size

Inch	DCONMS	BD	LF	CRKS	Shank shape	Shank material
VST031L275S05US	0.312	0.312	2.750	S05	Cylindrical	Steel
VST037L325S06US	0.375	0.375	3.250	S06	Cylindrical	Steel
VST050L375S08US	0.500	0.500	3.750	S08	Cylindrical	Steel
VST062L400S10US	0.625	0.625	4.000	S10	Cylindrical	Steel
Metric	DCONMS	BD	LF	CRKS	Shank shape	Shank material
VSTD08L070S05-S	8	8	70	S05	Cylindrical	Steel
VSTD10L080S06-S	10	10	80	S06	Cylindrical	Steel
VSTD12L090S08-S	12	12	90	S08	Cylindrical	Steel
VSTD16L100S10-S	16	16	100	S10	Cylindrical	Steel

VSTD shank should be used with VTB slotting head.
If other types of heads are used, please be sure not to exceed the maximum depth of cut for each head (See ap for each head).
VSTD shank does not have external clearance, and it may interfere with the workpiece during machining.

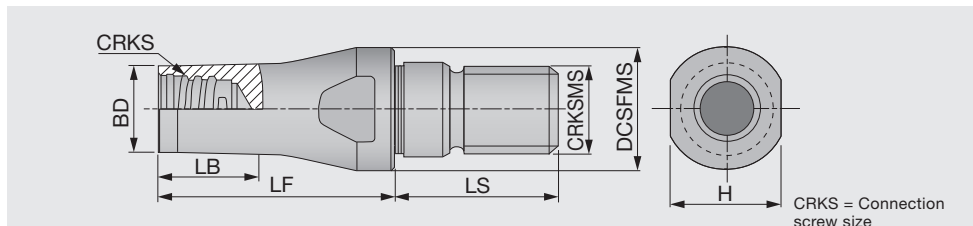

CRKS = Connection screw size

Metric	BD	DCSFMS	LF	LS	LB	CRKS	CRKSMS	H
VAD130L016S08-S-M8	11.7	13	16	17.5	6	S08	M8	11
VAD130L025S08-S-M8	11.7	13	25	17.5	20	S08	M8	11
VAD180L020S08-S-M10	11.7	18	20	20	12	S08	M10	13
VAD180L025S08-S-M10	11.7	18	25	20	15	S08	M10	11
VAD210L020S08-S-M12	11.7	21	20	22	10	S08	M12	12.75
VAD210L025S08-S-M12	11.7	21	25	22	13	S08	M12	12.75



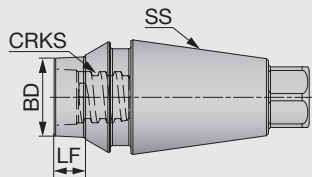

CRKS = Connection screw size



Inch	SS	BD	LF	CRKS
VER11CL006S05-S	ER11	0.312	0.236	S05
VER11CL020S05-S	ER11	0.312	0.787	S05
VER16CL012S05-S	ER16	0.312	0.472	S05
VER16CL020S05-S	ER16	0.312	0.787	S05
VER16CL010S06-S	ER16	0.391	0.394	S06
VER16CL020S06-S	ER16	0.391	0.787	S06
VER16CL006S08-S	ER16	0.457	0.236	S08
VER16CL020S08-S	ER16	0.457	0.787	S08

TORQUE WRENCHES

Appearance	Designation	Stock	Connection screw size	TM Head description	Torque (lb-ft)
Handle 	TORQUEWRENCH5-50NM9x12	●	-	-	-
Open wrenches for cylindrical heads 	TM-WRENCH-6-05	●	S05	VED, VEE VEE-I, VEE-R VEE-C, VEE-A VRD, VBD-BG VBE-BGA VDP, VCA	5.16
	TM-WRENCH-8-06	●	S06		7.38
	TM-WRENCH-10-08	●	S08		11.06
	TM-WRENCH-13-10	●	S10		20.65
	TM-WRENCH-16-12	●	S12		20.65
	TM-WRENCH-20-15	●	S15		29.50
Open wrenches for 2 flute heads 	TM-WRENCH-4E-05	●	S05	VRB, VRC VFX, VBB-BM VBB-BG VCP, VGC VCW, VCR	5.16
	TM-WRENCH-5E-06	●	S06		7.38
	TM-WRENCH-7E-08	●	S08		11.06
	TM-WRENCH-8E-10	●	S10		20.65
	TM-WRENCH-9E-12	●	S12		20.65
90° adaptor for Torx bits 	INSERT-TOOL-9X12MM	●	-	-	-
Torx bits sockets 	BIT-SOCKET-T20-DRIVE	●	S05, S06	VTB135 VTB160W2.00 VTB165W2.00	5.16, 7.38
	BIT-SOCKET-T25-DRIVE	●	S06	VTB160W3.00 VTB160W4.00	7.38
	BIT-SOCKET-T30-DRIVE	●	S08	VTB165W3.00	11.06
	BIT-SOCKET-T40-DRIVE	●	S08, S10	VTB165W4.00 VTB195	11.06, 20.65
	BIT-SOCKET-T50-DRIVE	●	S08, S10	VST277 VTB225 VTB250	11.06, 20.65

WRENCH

KEYV-..., KEYV-S..., KEYV-T..., KEYV-T**L, KEYV-W20

Appearance	Designation	Connection screw size	Torque (lbf-ft)	Applicable head	
	KEYV-S05	S05	5.16	Square Ball Radius Drilling Chamfering Counter boring	
	KEYV-S06	S06	7.38		
	KEYV-S08	S08	11.06		
	KEYV-S10	S10	20.65		
	KEYV-S12	S12	20.65		
	KEYV-W20	S15	29.50		
	KEYV-177	S06	7.38	Slotting VST type	
	KEYV-217	S08	11.06		
	KEYV-T40L	S08	11.06	Slotting VST, VTB type	
		S10	20.65		
	KEYV-T20	S05	5.16	Slotting VTB type	
		S06	7.38		
		KEYV-T25	S06		7.38
		KEYV-T30L	S08		11.06
		KEYV-T50L	S08		11.06
			S10		20.65

Note: Wrenches are sold separately.

CAUTIONARY POINTS IN USE

- The cutting heads specified by Tungaloy must be used. Avoid using alternate heads that are not Tungaloy products as this will damage the shank and can cause severe accident or injury.
- Before setting the head, clean the connection screw with an air blast or a wiping cloth to remove chips and other foreign matter that may remain.
- Do not apply the lubricant to the connection screw.
- Please use the correct "Wrench" with the correct cutting head. Tighten the head slowly until the face of the head contacts the shank. (Please refer to the picture shown on the right.) Do not re-tighten or over-tighten. SW Excessive tightening may cause the cutting head to break.
- Do not apply excessive force or a hammer when tightening or exchanging the cutting heads.

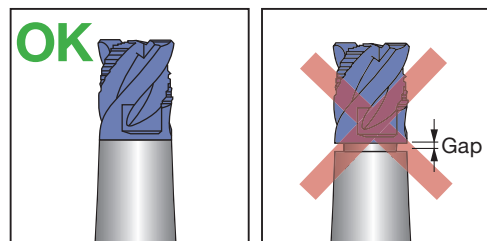

Grade
Insert
Toolholder
Ext. Toolholder
Int. Toolholder
Threading
Grooving
Miniature Tool
Milling Cutter
Endmill
Drilling Tool
Tooling System
User's Guide
Index



Milling Insert

● ACMT**PR-MJ

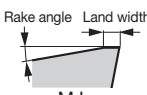
Shape	Designation	Coated				Applicable mill
		AH120	AH140	GH330	T3130	
 Rake angle Land width  -MJ	ACMT060308PR-MJ	●	●	●	●	ELP07/09/12... (old item)
	ACMT07T308PR-MJ	●	●	●	●	
	ACMT100408PR-MJ	●	●	●	●	

● ADMT**PR-MJ

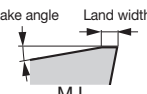
Shape	Designation	Coated			Applicable mill
		AH120	AH140	T3130	
 Rake angle Land width  -MJ	ADMT130308PR-MJ	●	●	●	ELP13/17/21... (old item)
	ADMT17T308PR-MJ	●	●	●	
	ADMT210408PR-MJ	●	●	●	

● AECW**PEFR, AECW**PESR, AEMW**PEFR, AEMW**PETR

Shape	Designation	Coated		Cermet		Uncoated		Applicable mill
		AH120	GH330	NS740	UX30	TH10		
	AECW1403PEFR					●		EPE4000/5000/ 6000... (old item)
	AECW1403PESR	●	●	●	●			
	AECW16T3PEFR					●		
	AECW16T3PESR	●	●	●	●			
	AECW1804PEFR					●		
	AECW1804PESR	●	●	●	●			
	AEMW1403PEFR					●		
	AEMW1403PETR		●	●	●			
	AEMW16T3PEFR					●		
	AEMW16T3PETR		●	●	●			
	AEMW1804PEFR					●		
AEMW1804PETR		●	●	●	●			

● ANEA542TN, ANEA642TN

Shape	Designation	Uncoated		Applicable mill
		UX30		
	ANEA542TN	●		VSN... (old item)
	ANEA642TN	●		



● : Line up

Milling Insert

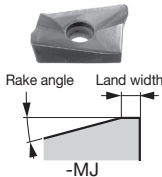
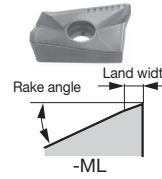

● ANMT**PPPR-MJ, ANMT**PPPR-ML

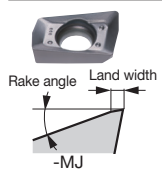
Shape	Designation	Coated			Applicable mill
		AH120	GH330	T3130	
 -MJ	ANMT09T3PPPR-MJ	●	●	●	EPN09 EPN14... TPN14... (old item)
	ANMT09T3PPPR-ML	●			
	ANMT1404PPPR-MJ	●	●	●	
	ANMT1404PPPR-ML	●			
 -ML					

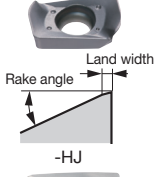
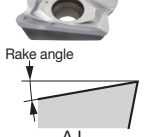
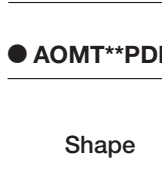
● AOMT**PDPR-MJ, AOGT**PDFR-AJ, AOMT070208PDPR-HJ

Shape	Designation	Coated		Uncoated	Applicable mill
		AH140	AH725	KS15F	
 -MJ	AOMT070202PDPR-MJ	●	●		 TPO07... Page H116
	AOMT070204PDPR-MJ	●	●		
	AOMT070208PDPR-MJ	●	●		
	AOMT070216PDPR-MJ	●	●		
	AOMT070208PDPR-HJ	●	●		
 -HJ	AOGT070204PDFR-AJ			●	HPO07... Page H117
 -HJ					
 -AJ					

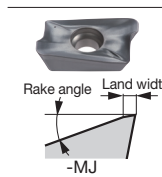
● AOMT**PDPR-MJ, AOGT**PDFR-AJ

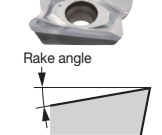
Shape	Designation	Coated		Uncoated	Applicable mill
		AH140	AH725	KS15F	
 -MJ	AOMT180508PDPR-MJ	●	●		 TPO18... Page H126
	AOMT180516PDPR-MJ	●	●		
	AOMT180524PDPR-MJ	●	●		
	AOMT180532PDPR-MJ	●	●		
	AOGT180504PDFR-AJ			●	
 -AJ	AOGT180508PDFR-AJ			●	EPO18... Page H126

● : Line up

Grade
 Insert
 Ext. Toolholder
 Int. Toolholder
 Threading
 Grooving
 Milling Cutter
 Miniature Tool
 Endmill
 Drilling Tool
 User's Guide
 Tooling System
 Index



Milling Insert

● APMT**PN-MJ

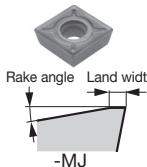
Shape	Designation	Coated									Applicable mill
		AH120	AH140	GH330	T3130						
 <p>Rake angle Land width -MJ</p>	APMT070308PN-MJ	●	●	●	●						ELP07/09/12... (old item)
	APMT09T308PN-MJ	●	●	●	●						
	APMT120408PN-MJ	●	●	●	●						



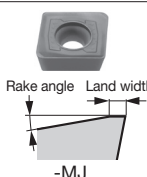

● APMT120416PR-MJ

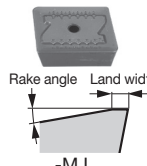
Shape	Designation	Coated								Applicable mill	
		AH120	T3130								
 <p>Rake angle Land width -MJ</p>	APMT120416PR-MJ	●	●								TZP12... HZP12... (old item)

● APMR190616PR-MJ

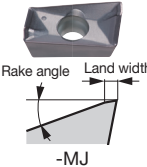
Shape	Designation	Coated								Applicable mill	
		AH120	T3130								
 <p>Rake angle Land width -MJ</p>	APMR190616PR-MJ	●	●								TZP19... (old item)

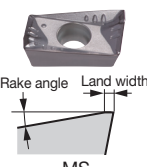
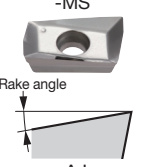





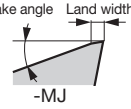

● ASMT**PDPR-MJ, ASGT11**PDFR-AJ, ASMT304PDPR-MS

Shape	Designation	Coated							Cermet	Uncoated	Applicable mill	
		AH120	AH130	AH140	AH725	T1115	T1215	T3130	DS1100	NS740		KS05F
 <p>Rake angle Land width -MJ</p>	ASMT11T304PDPR-MJ	●	●		●	●		●	●		 TPS11... Page H119	
	ASMT11T308PDPR-MJ	●	●	●	●	●	●	●	●			
	ASMT11T312PDPR-MJ	●			●			●	●			
 <p>Rake angle Land width -MJ</p>	ASMT11T316PDPR-MJ	●			●			●	●		TPO11... Page H119	
	ASMT11T320PDPR-MJ	●										
	ASMT11T330PDPR-MJ	●	●									
 <p>Rake angle Land width -MS</p>	ASMT11T304PDPR-MS		●	●							TLS11... Page H120	
	ASGT11T304PDFR-AJ							●		●	EPS11... Page H120	
 <p>Rake angle -AJ</p>	ASGT11T308PDFR-AJ							●		●	EPO11... Page H121	
												HPO11... Page H122
												ELS11... Page H122









● : Line up

Milling Insert

● ASMT17**PDPR-MJ, ASGT17**PDFR-AJ, ASMT170508PDPR-MS

Shape	Designation	Coated					Cermet	Uncoated		Applicable mill
		AH120	AH130	AH140	T1115	T3130	DS1100	NS740	KS05F	
         	ASMT170504PDPR-MJ	●	●		●	●				TPS17... EPS17... (old item)
	ASMT170508PDPR-MJ	●	●	●	●	●				
	ASMT170512PDPR-MJ	●	●			●				
	ASMT170516PDPR-MJ	●				●				
	ASMT170520PDPR-MJ	●				●				
	ASMT170530PDPR-MJ	●				●				
	ASMT170532PDPR-MJ	●				●				
	ASMT170508PDPR-MS			●	●					
	ASGT170504PDFR-AJ						●		●	
	ASGT170508PDFR-AJ						●		●	

● AVGT**PBER-MJ, AVGT**PBFR-AJ

Shape	Designation	Coated			Uncoated		Applicable mill
		AH120	AH130	AH3135	KS05F		
       	AVGT060300PBER-MJ			●			TUNG F^{REC} EPAV... Page H111 HPAV06-M Page H112 HPAV06-S Page H113
	AVGT060302PBER-MJ	●	●	●			
	AVGT060304PBER-MJ	●	●	●			
	AVGT060308PBER-MJ	●	●	●			
	AVGT060300PBFR-AJ				●		
	AVGT060302PBFR-AJ				●		
	AVGT060304PBFR-AJ				●		
	AVGT060308PBFR-AJ				●		

● CPMW**-EN, CPMT**-EN

Shape	Designation	Coated		Uncoated		Applicable mill
		GH330		UX30		
	CPMW050208EN	●		●		EVP1000 (old item)
	CPMW06T208EN	●		●		
	CPMT080308EN	●		●		

● : Line up

Grade
 Insert
 Toolholder
 Ext. Toolholder
 Int. Toolholder
 Threading
 Grooving
 Milling Cutter
 Miniature Tool
 Endmill
 Drilling Tool
 Tooling System
 User's Guide
 Index



Milling Insert

● DCMW**TN

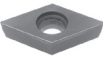
Shape	Designation	Coated					Applicable mill
		AH120	AH330				
	DCMW070204TN	●	●				EBP... Page H184
	DCMW11T304TN	●	●				HBP... (old item)

● DPCW11T3ZFR

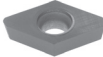
Shape	Designation	Coated		Cermet			Applicable mill
		AH740		NS740			
	DPCW11T3ZFR	●		●			TZF11... HZF11... (old item)

● EDKW53ZTR

Shape	Designation	Coated		Uncoated			Applicable mill
		GH330		UX30			
	EDKW53ZTR	●		●			ESD5000 (old item)

● ENEQ**TN-T

Shape	Designation	Coated					Applicable mill
		AH120					
	ENEQ090508TN-T	●					VSNE09...
	ENEQ100508TN-T	●					VSNE10...
	ENEQ130608TN-T	●					VSNE13...
	ENEQ160608TN-T	●					VSNE16... (old item)

● GDMT**PDPR-MJ, GDGT**PDFR-AJ

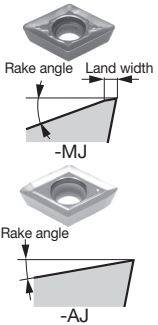
Shape	Designation	Coated					Uncoated		Applicable mill
		AH120	AH140	AH330	T3130	DS1100	UX30	TH10	
 <p>Rake angle Land width -MJ</p> <p>Rake angle -AJ</p>	GDMT10H3PDPR-MJ	●	●	●	●		●		TSD10/17...
	GDMT17X6PDPR-MJ	●	●	●	●		●		ESD10/17...
	GDGT10H3PDFR-AJ					●		●	HSD10/17...
	GDGT17X6PDFR-AJ					●		●	(old item)

● : Line up

Milling Insert

● HEHN532FN

Shape	Designation	Uncoated				Applicable mill
		TH10				
	HEHN532FN	●				QYE5300 (old item)

● HPKN532FN

Shape	Designation	Uncoated				Applicable mill
		TH10				
	HPKN532FN	●				QYP5300 (old item)

● LMEU**ZNEN-MJ

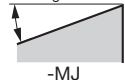
Shape	Designation	Coated				Applicable mill
		AH120	AH140	AH725	AH3135	
  Rake angle -MJ	LMEU100808ZNEN-MJ	●	●	●	●	TEC T-SLOT ASN 10/12/15... Page H159 TSN 10/12/15... Page H159
	LMEU100810ZNEN-MJ	●			●	
	LMEU100816ZNEN-MJ	●	●	●	●	
	LMEU100820ZNEN-MJ	●			●	
	LMEU100824ZNEN-MJ	●	●	●	●	
	LMEU100830ZNEN-MJ	●			●	
	LMEU100832ZNEN-MJ	●	●	●	●	
	LMEU120808ZNEN-MJ	●	●	●	●	
	LMEU120816ZNEN-MJ	●			●	
	LMEU120820ZNEN-MJ	●			●	
	LMEU120824ZNEN-MJ	●	●	●	●	
	LMEU120830ZNEN-MJ	●			●	
	LMEU120832ZNEN-MJ	●	●	●	●	
	LMEU150908ZNEN-MJ	●	●	●	●	
	LMEU150916ZNEN-MJ	●	●	●	●	
	LMEU150920ZNEN-MJ	●			●	
	LMEU150924ZNEN-MJ	●	●	●	●	
	LMEU150930ZNEN-MJ	●			●	
LMEU150932ZNEN-MJ	●	●	●	●		
LMEU150940ZNEN-MJ	●			●		
LMEU150950ZNEN-MJ	●			●		

● LMMU**PNER-MJ

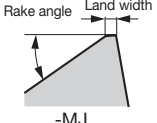
Shape	Designation	Coated						Applicable mill
		AH3135	AH120	AH140	AH725	T1215	T3225	
  Rake angle Land width -MJ	LMMU110708PNER-MJ	●	●	●	●	●	●	TEC MILL TPM11/16... Page H140 TLM11... Page H140 EPM11... Page H141
	LMMU110716PNER-MJ	●	●	●	●	●	●	
	LMMU110724PNER-MJ	●			●			
	LMMU110732PNER-MJ	●	●	●	●			
	LMMU160908PNER-MJ	●	●	●	●	●	●	
	LMMU160916PNER-MJ	●	●	●	●			
	LMMU160924PNER-MJ	●			●			
LMMU160932PNER-MJ	●	●	●	●				

● : Line up





Milling Insert





● LNCA64ZTR

Shape	Designation	Coated		Uncoated		Applicable mill
		T3130		UX30		
	LNCA64ZTR	●		●		VSN60001 (old item)

● LNCQ0906N-**L, LNCQ0906R-50S

Shape	Designation	Coated		Cermet		Applicable mill
		AH120	GH110	NS740		
   Rake angle	LNCQ0906N-100L	●	●	●		NMS09... EMS09... (old item)
	LNCQ0906N-50L	●	●	●		
	LNCQ0906R-50S	●	●	●		



● LNMU0303ZER-MJ, LNMU0303ZER-ML, LNMU0303ZER-MS, LNGU0303ZER-MH

Shape	Designation	Coated						Applicable mill
		AH130	AH3225	AH3035	AH725	AH8015	AH8005	
    Rake angle Land width -MJ Rake angle Land width -ML Rake angle Land width -MS Rake angle Land width -MH	LNMU0303ZER-MJ	●	●	●	●	●		DOFEED TXN03... Page H026 EXN03... Page H026, H027 HXN03... Page H028
	LNMU0303ZER-ML	●	●	●	●	●		
	LNMU0303ZER-MS	●	●					
	LNGU0303ZER-MH					●	●	

● : Line up

Milling Insert

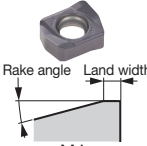
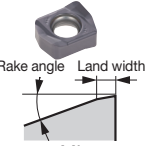
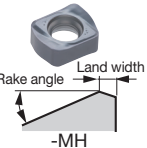
● LNMU06X5ZER-MJ, LNMU06X5ZER-ML, LNGU06X5ZER-MH, LNGU06X5ZER-W

Shape	Designation	Coated							Applicable mill
		AH130	AH3225	AH3035	AH725	AH120	AH8015	AH8005	
 -MJ	LNMU06X5ZER-MJ	●	●	●	●	●	●	●	DOFEED TXN06... Page H032 EXN06... Page H032
	LNMU06X5ZER-ML	●	●	●	●	●	●	●	
	LNGU06X5ZER-MH						●	●	
	LNGU06X5ZER-W				●				
 -ML									
 -MH									
 -W									

● LNMX040*R*-MJ, LNMX0405R4-ML, LNMX0405R4-HJ, LNMX0607ZER-HJ

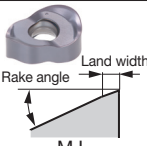
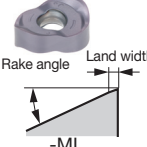
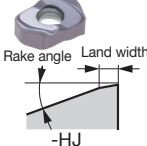
Shape	Designation	Coated		Applicable mill
		AH120	AH3135	
 -MJ	LNMX0405R4-MJ	●	●	DO TWIST BALL TXLN... Page H036 EXLN... Page H037 HXLN... Page H038
	LNMX0405R4-ML	●	●	
	LNMX0405ZER-HJ	●	●	
	LNMX0506R5-MJ	●	●	
	LNMX0607R6-MJ	●	●	
	LNMX0607ZER-HJ	●	●	
 -ML				
 -HJ				

● : Line up

Grade
Insert
Ext. Toolholder
Int. Toolholder
Threading
Grooving
Miniature Tool
Milling Cutter
Endmill
Drilling Tool
User's Guide Tooling System
Index



Milling Insert

● LQMU**PNER-MJ, LQMU110708PXER-MJ

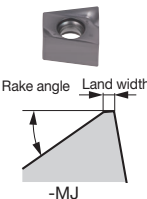
Shape	Designation	Coated									Applicable mill
		AH120	AH140	AH725	AH3135						
 <p>Rake angle Land width</p> <p>-MJ</p>	LQMU110704PNER-MJ	●	●	●						DOREC TPQ11/18... Page H136 EPQ11... Page H137	
	LQMU110708PNER-MJ	●	●	●							
	LQMU110708PXER-MJ	●			●						
	LQMU110716PNER-MJ	●	●	●							
	LQMU110720PNER-MJ	●									
	LQMU180804PNER-MJ	●	●	●							
	LQMU180808PNER-MJ	●	●	●							
	LQMU180816PNER-MJ	●	●	●							
	LQMU180824PNER-MJ	●	●	●							

● LSMT0202ZER-HM, LSMT0202R2-MM

Shape	Designation	Coated							Applicable mill
		AH3225	AH8015						
 <p>Rake angle Land width</p> <p>-HM</p> <p>-MM</p>	LSMT0202ZER-HM	●	●						TUNGF^{FEED} EXLS... Page H022 HXLS... Page H022
	LSMT0202R2-MM	●	●						

● ONMU0705ANPN-MJ, ONHU0705ANPN-MJ, ONMU0705ANPN-ML, ONHU0705ANTN-ML, ONHU0705ANPR-W

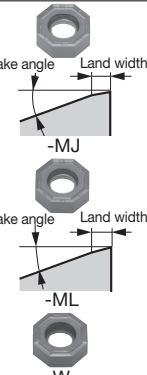
Shape	Designation	Coated											Applicable mill
		AH120	AH140	AH725	AH3135	T1115	T1215	T3225					
 <p>Rake angle Land width</p> <p>-MJ</p> <p>-ML</p> <p>-W</p>	ONMU0705ANPN-MJ		●	●	●	●	●	●					DOOCTO TAN07... Page H063, H064
	ONHU0705ANPN-MJ		●	●									
	ONMU0705ANPN-ML	●			●								
	ONHU0705ANTN-ML	●	●	●									
	ONHU0705ANPR-W	●											

● : Line up

Milling Insert

● ONGU0507ANEN-MJ, ONGU0507ANEN-W, ONMU0507ANEN-MJ

Shape	Designation	Coated				Applicable mill
		AH120	AH3135	T3225	T1215	
	ONGU0507ANEN-MJ	●	●	●	●	DOTMILL TASN13... Page H060
	ONGU0507ANEN-W	●	●			
	ONMU0507ANEN-MJ	●	●	●	●	

● OWMT0807ZNER-HJ, OWMT0807AAER-ML

Shape	Designation	Coated		Applicable mill
		AH130	AH3135	
	OWMT0807ZNER-HJ		●	DOOCTO TAN07... Page H063, H064
	OWMT0807AAER-ML	●	●	

● PNMU0905GNEN-MJ, PNCU0905GNEN-MJ, PNCU0905GNER-MJ, PNCU0905GNEN-ML, PNCU0905GNFR-AJ, PNCU0905GNER-W

Shape	Designation	Coated							Cermet	Uncoated	Applicable mill
		AH120	AH140	AH725	AH3135	T1115	T1215	T3130	T3225	NS740	
	PNMU0905GNEN-MJ	●			●		●	●			DOPENT TEN09R... Page H069 EEN09... Page H070
	PNCU0905GNEN-MJ	●			●		●	●			
	PNCU0905GNER-MJ	●	●	●		●	●	●	●		
	PNCU0905GNEN-ML				●						
	PNCU0905GNFR-AJ									●	
	PNCU0905GNER-W			●							

● : Line up



Milling Insert

● RCMT**EN-MJ, RCMT**EN-NMJ, RCMT**FN-NAJ

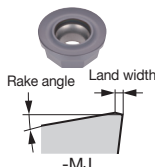
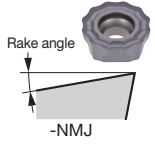
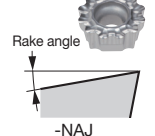
Shape	Designation	Coated			Uncoated		Applicable mill
		AH120	AH140	AH725	KS15F		
 -MJ  -NMJ  -NAJ	RCMT1204EN-MJ	●	●	●			ROUND SPLIT TRC12/16... Page H177 ERC12/16... Page H178
	RCMT1204EN-NMJ	●	●	●			
	RCMT1204FN-NAJ				●		
	RCMT1606EN-MJ	●	●	●			
	RCMT1606EN-NMJ	●	●	●			
	RCMT1606FN-NAJ				●		



● RDCA2004TN, RDCN2004TN, RDKN2004...

Shape	Designation	Coated		Uncoated		Applicable mill
		AH120		UX30	TH10	
	RDCA2004TN			●		TRD6000 ERD6000 (old item)
	RDCN2004TN			●		
	RDKN2004FN				●	
	RDKN2004TN	●		●		

● RDCM1203TN, RDMA1203TN

Shape	Designation	Uncoated		Applicable mill
		UX30		
	RDCM1203TN	●		ERD4000 (old item)
	RDMA1203TN	●		

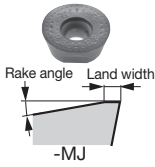
● RDMT**ZDPN-MJ, RDMW**ZDSN

Shape	Designation	Coated					Uncoated		Applicable mill
		AH120	AH130	AH140	AH330	T3130	UX30		
 -MJ 	RDMT1204ZDPN-MJ	●		●	●	●	●	TRD12/16... ERD12/16... (old item)	
	RDMW1204ZDSN	●		●	●	●			
	RDMT1606ZDPN-MJ	●	●	●	●	●	●		
	RDMW1606ZDSN	●		●	●	●			

● : Line up

Milling Insert

● RDMW**M0

Shape	Designation	Coated							Applicable mill
		AH120							
	RDMW0501M0	●							EWD05/07/10... Page H182
	RDMW0702M0	●							
	RDMW1003M0	●							

● RFEN2004ZFTN, RFEN2004M0TN

Shape	Designation	Coated		Uncoated		Applicable mill
		AH120	GH330	UX30	KS20	
	RFEN2004ZFTN	●	●	●	●	TRF6000 ERF6000 (old item)
	RFEN2004M0TN		●	●	●	

● RNGN**-E/T1

Shape	Designation	Ceramic		Applicable mill
		TS200	TS300	
	RNGN120700-E	●	●	CERAMIC MILL TFMRN... Page H072
	RNGN120700-T1	●	●	

● RNMU1307ZNER-MJ

Shape	Designation	Coated				Applicable mill
		AH120	AH3135	T1215	T3225	
 Rake angle Land width -MJ	RNMU1307ZNER-MJ	●	●	●	●	DOTMILL TASN13... Page H060

● RPMT**EN-MJ, RPMT**EN-ML

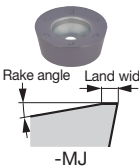
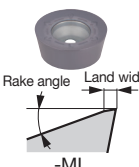
Shape	Designation	Coated			Applicable mill
		AH130	AH725	AH4035	
 Rake angle Land width -MJ	RPMT10T3EN-MJ	●	●	●	FIXRMILL TRP12/16... Page H172
	RPMT10T3EN-ML	●	●	●	
	RPMT1204EN-MJ	●	●	●	
	RPMT1204EN-ML	●	●	●	
	RPMT1606EN-MJ	●	●	●	
	RPMT1606EN-ML	●	●	●	
 Rake angle Land width -ML					ERP10/12/16... Page H172
					HRP10/12... Page H173

● : Line up

Grade
Insert
Toolholder
Ext. Toolholder
Int. Toolholder
Threading
Grooving
Miniature Tool
Milling Cutter
Endmill
Drilling Tool
Tooling System
User's Guide
Index



Milling Insert

● SCMT**-23

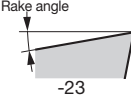
Shape	Designation	Coated							Applicable mill
		AH120							
 Rake angle  -23	SCMT09T308-23	●							EBD... Page H186
	SCMT120408-23	●							HBD... (old item)

● SDCN1504ZDSR, SDEN1504ZDSR, SDNN1504ZDSR

Shape	Designation	Coated				Applicable mill
		AH120	AH140	T1115	T3130	
	SDCN1504ZDSR	●	●		●	MILLFEED TXD15... (old item)
	SDEN1504ZDSR	●	●	●	●	
	SDNN1504ZDSR	●	●	●	●	

● SDCN42HTR, SDKN42HTR

Shape	Designation	Coated							Applicable mill
		GH330							
	SDCN42HTR	●							EUD4600 (old item)
	SDKN42HTR	●							





● SDKN42EF..., SDEN42EFTR24

Shape	Designation	Coated		Cermet	Uncoated		Applicable mill
		T3130		NS740	TH10	UX30	
	SDKN42EFTR	●		●			TMD4100I (old item)
	SDKN42EFFR				●		
	SDEN42EFTR24			●		●	

● : Line up

Milling Insert

● SDCN42Z..., SDEN42Z..., SDKN42Z..., SDCN42ZFN-DIA, SDKR42ZSR-MJ, SDMR1203AETN-MJ, SDKR1203AETN-MJ, SDKR42ZPN-MS



Shape	Designation	Coated										Cermet		Uncoated		PCD	Applicable mill	
		AH3135	AH120	AH130	AH140	AH330	GH330	T1115	T1215	T3130	T3225	NS740	N308	UX30	TH10	DX140		
   -MJ  -MS	SDCN42ZFN																	TMD4400RI-U Page H087 EMD4400RI TGD4400-A EGD4400 TFD4400-A (old item)
	SDCN42ZTN											●	●	●				
	SDCN42ZTN20											●						
	SDEN42ZFN														●			
	SDEN42ZTN	●	●		●		●	●	●			●	●	●				
	SDEN42ZTNCR	●	●		●	●						●						
	SDEN42ZTN20								●	●								
	SDKN42ZFN															●		
	SDKN42ZTN	●	●	●	●	●	●	●	●			●	●	●				
	SDKN42ZTNCR											●						
	SDKN42ZTN16								●	●								
	SDCN42ZFN-DIA																●	
	SDKR42ZSR-MJ	●	●			●	●		●	●								
	SDMR1203AETN-MJ											●						
	SDKR1203AETN-MJ											●						
	SDKR42ZPN-MS	●		●	●													

DX140: Packing quantity = 1pc.

● SDCN53HTR, SDKN53HTR

Shape	Designation	Coated							Applicable mill
		GH330							
	SDCN53HTR	●							TUD5600 (old item)
	SDKN53HTR	●							

● SDCN53ZTN, SDEN53Z..., SDKN53Z..., SDKR53ZSR-MJ

Shape	Designation	Coated					Cermet		Uncoated		Applicable mill	
		AH120	AH130	AH140	GH330	T3130	NS740	N308	UX30	TH10		
   -MJ	SDCN53ZTN						●	●			TMD5400RI Page H090	
	SDEN53ZFN								●			
	SDEN53ZTN				●		●		●			
	SDEN53ZTNCR						●					
	SDEN53ZTN20					●						
	SDKN53ZFN								●			
	SDKN53ZTN	●	●	●	●		●	●	●			
	SDKN53ZTNCR						●					
	SDKN53ZTN16					●						
	SDKR53ZSR-MJ				●	●						

● : Line up

Grade
Insert
Toolholder
Ext. Toolholder
Int. Toolholder
Threading
Grooving
Miniature Tool
Milling Cutter
Endmill
Drilling Tool
Tooling System
User's Guide
Index



Milling Insert

● SDMT050204PN-MJ, SDHT050204FN-AJ

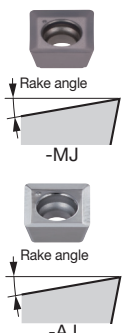
Shape	Designation	Coated		Uncoated					Applicable mill
		AH140	AH725	TH10					
	SDMT050204PN-MJ	●	●						TUNGQUAD TPD05... Page H129 EPD05... Page H129 ELD05... Page H130 EASD05... Page H221
	SDHT050204FN-AJ			●					

● SDMT1204AFPJ-MJ, SDMT1204AFTN-MJ, SDMT1204AFPJ-ML, SDMT1204AFPJ-MS, SDGT1204AFTN-MJ, SDGT1204AFFN-AJ

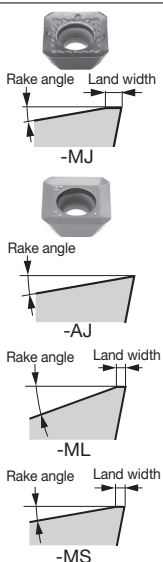
Shape	Designation	Coated					Cermet	Uncoated			Applicable mill
		AH120	AH140	AH330	GH330	T3130	NS740	TH10			
	SDMT1204AFPJ-MJ	●	●	●	●	●					TAD12... EAD12... (old item)
	SDMT1204AFTN-MJ						●				
	SDMT1204AFPJ-ML	●		●							
	SDMT1204AFPJ-MS		●								
	SDGT1204AFTN-MJ	●		●			●				
	SDGT1204AFFN-AJ							●			

● : Line up

Milling Insert



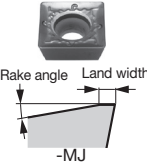
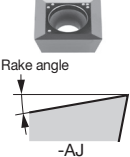
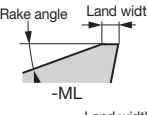
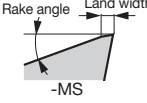







● SDMT1204PDSR-MJ, SDMT1204PDTR-MJ, SDMT1204PDPR-ML, SDMT1204PDPR-MS SDGT1204PDTR-MJ, SDGT1204PDFR-AJ

Shape	Designation	Coated					Cermet		Uncoated		Applicable mill
		AH120	AH140	AH330	GH330	T3130	NS740		TH10		
 -MJ  -AJ  -ML  -MS	SDMT1204PDSR-MJ	●	●	●	●	●					TPD12... EPD12... (old item)
	SDMT1204PDTR-MJ						●				
	SDMT1204PDPR-ML			●							
	SDMT1204PDPR-MS		●								
	SDGT1204PDTR-MJ		●		●		●				
	SDGT1204PDFR-AJ								●		

● SDMW090308TN, SDMW120408TN

Shape	Designation	Uncoated										Applicable mill	
		UX30											
	SDMW090308TN	●											ELD3000 ELD4000 (old item)
	SDMW120408TN	●											

● SECN1203AGFN, SEEN1203AG..., SEKN1203AG..., SEKR1203AGSR-MJ, SEKR1203AGPN-MS

Shape	Designation	Coated							Cermet		Uncoated		Applicable mill	
		AH120	AH130	AH140	AH330	GH330	T1115	T3130	NS740		UX30	TH10		
 SECN1203AGFN  SEEN1203AGFN  SEEN1203AGTN  SEEN1203AGTN-T  SEEN1203AGTNCR  SEEN1203AGTNCR-14  SEKN1203AGFN-T  SEKN1203AGTN  SEKN1203AGTN-T  SEKN1203AGTNCR SEKR1203AGSR-MJ SEKR1203AGPN-MS	SECN1203AGFN										●		TME4400R/LI TME4400RB EME4400 (old item)	
	SEEN1203AGFN											●		
	SEEN1203AGTN	●	●	●		●	●		●		●			
	SEEN1203AGTN-T								●		●			
	SEEN1203AGTNCR	●	●	●	●									
	SEEN1203AGTNCR-14								●					
	SEKN1203AGFN-T											●		
	SEKN1203AGTN	●	●	●	●	●			●		●			
	SEKN1203AGTN-T					●	●		●		●			
	SEKN1203AGTNCR								●					
	SEKR1203AGSR-MJ	●			●	●								
	SEKR1203AGPN-MS		●	●										

● : Line up

Grade
Insert
Toolholder
Ext. Toolholder
Int. Toolholder
Threading
Grooving
Miniature Tool
Endmill
Drilling Tool
Tooling System
User's Guide
Index



Milling Insert

● SE*N1504AG..., SEKR1504AGSR-MJ

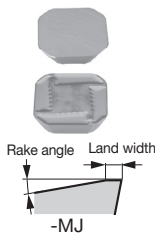
Shape	Designation	Coated				Cermet		Uncoated		Applicable mill	
		AH120	AH140	GH330	T3130	NS740		TH10	UX30		
 <p>Rake angle Land width -MJ</p>	SEEN1504AGTN					●				TME5400RI (old item)	
	SEKN1504AGFN							●	●		
	SEKN1504AGTN	●	●	●	●	●			●		
	SEKN1504AGTN-T				●	●					
	SEKR1504AGSR-MJ			●	●						

● SECN422TN, SECN422FN, SEEN422TN, SEEN422FN, SECN422FN-DIA

Shape	Designation	ISO Designation (Metric)	Cermet		Uncoated		PCD		Applicable mill	
			NS740	N308	UX30	TH10	DX140			
 <p>-DIA</p>	SECN422TN	SECN120308TN	●	●	●				EGE4000 QHE4000 (old item)	
	SECN422FN	SECN120308FN				●				
	SEEN422TN	SEEN120308TN	●	●	●					
	SEEN422FN	SEEN120308FN				●				
	SECN422FN-DIA	SECN120308FN-D					●			

DX140: Packing quantity = 1pc.

● SEEN1203AFTNCR-14, SEKN42AFTN, SEKN42AFFN, SEKN42AFTN16, SEKR42AFSR-MJ, SEKR1203AFPN-MS, SEKR1203AFTN-MJ, SEMR1203AFTN-MJ

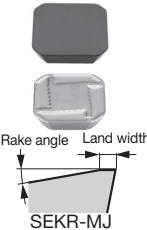
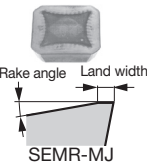
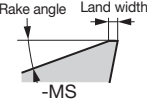
Shape	Designation	ISO Designation (Metric)	Coated					Cermet	Uncoated		Applicable mill
			AH120	AH130	AH140	GH330	T3130	NS740	TH10	UX30	
 <p>Rake angle Land width SEKR-MJ</p>  <p>Rake angle Land width SEMR-MJ</p>  <p>Rake angle Land width -MS</p>	SEEN1203AFTNCR-14						●			TGE4400I EGE4400 (old item)	
	SEKN42AFTN	SEKN1203AFTN	●	●	●	●					●
	SEKN42AFFN	SEKN1203AFFN							●		
	SEKN42AFTN16	SEKN1203AFTN-16					●				
	SEKR42AFSR-MJ	SEKR1203AFSR-MJ				●	●				
	SEKR1203AFPN-MS				●						
	SEKR1203AFTN-MJ							●			
	SEMR1203AFTN-MJ							●			



● : Line up

Milling Insert

● SECN42EFTRCR, SEEN42EFTRCR, SEKN42EFTR, SEKN42EFFR









Shape	Designation	ISO Designation (Metric)	Coated		Cermet	Uncoated		Applicable mill
			GH330	T3130	NS740	UX30	TH10	
	SECN42EFTRCR	SECN1203EFTR			●			EGE4100 (old item)
	SEEN42EFTRCR	SEEN1203EFTR			●			
	SEKN42EFTR	SEKN1203EFTR	●	●	●			
	SEKN42EFFR	SEKN1203EFFR					●	

● SE*N42ZFR, SECN42ZFR-DIA

Shape	Designation	Uncoated		PCD		Applicable mill
		TH10		DX140		
  -DIA	SECN42ZFR-DIA			●		THE4000RIA (old item)
	SECN42ZFR	●				
	SEEN42ZFR	●				

DX140: Packing quantity = 1pc.

● SEGW12X4ZE*R, SEGT12X4ZEFR-AJ, SEGW12X4ZEFR-*, 2QP-SECW12X41ZETR, 1QP-SECW12X4ZETR-*

Shape	Designation	Coated			Cermet	Uncoated	PCD	CBN	Applicable mill
		AH120	AH140	DS1100	NS740	KS05F	DX140	BX480	
         Rake angle -AJ -D Regular edge -WD Wiper edge -BD Wiper for burr removal	SEGW12X4ZEFR					●			TFE12R...-...A Page H082 TFE12R... Page H081 EFE12R... Page H081
	SEGW12X4ZEPR	●	●		●				
	SEGT12X4ZEFR-AJ			●		●			
	SEGW12X4ZEFR-D						●		
	SEGW12X4ZEFR-WD						●		
	SEGW12X4ZEFR-BD						●		
	2QP-SECW12X41ZETR							●	
	1QP-SECW12X4ZETR-W							●	
	1QP-SECW12X4ZETR-B							●	

DX140: Packing quantity = 1pc.

● : Line up



Milling Insert

● SEKR1504AFSR-MJ

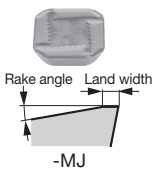
Shape	Designation	Coated						Applicable mill
		T3130						
 -MJ	SEKR1504AFSR-MJ	●						(old item)

● SF*N42ZFN, SFCN42ZFN-DIA

Shape	Designation	Uncoated		PCD				Applicable mill
		TH10		DX140				
 -DIA	SFCN42ZFN	●						THF4400RIA (old item)
	SFEN42ZFN	●						
	SFCN42ZFN-DIA			●				

DX140: Packing quantity = 1pc.

● SF*N53ZFN, SFCN53ZFN-DIA

Shape	Designation	Uncoated		PCD				Applicable mill
		TH10		DX140				
 -DIA	SFCN53ZFN	●						THF5400RIA (old item)
	SFEN53ZFN	●						
	SFCN53ZFN-DIA			●				

DX140: Packing quantity = 1pc.

● SN**56FTR

Shape	Designation	Cermet						Applicable mill
		X407						
	SNAA56FTR	●						MS... (old item)
	SNAG56FTR							
	SNCC56FTR							
	SNCJ56FTR							

● SNCN43Z..., SNKF43Z..., SNKN43ZTN

Shape	Designation	Coated		Cermet		Ceramic	Uncoated		Applicable mill
		T1115	T3130	NS740	N308	FX105	UX30	TH10	
	SNCN43ZFN							●	TGN4200R-A (old item)
	SNCN43ZTN			●	●			●	
	SNKF43ZFN							●	
	SNKF43ZTN	●						●	
	SNKN43ZTN	●	●	●		●		●	

Milling Insert

● SNEN12**Z...

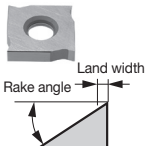
Shape	Designation	Uncoated										Applicable mill
		UX30	TH10									
	SNEN12T2ZFN	●	●									SVN4000 (old item)
	SNEN12T2ZTN	●	●									
	SNEN1233ZFN	●	●									
	SNEN1233ZTN	●	●									

● SNMU120608HNEN-MM, SNMU1206**EN-MM

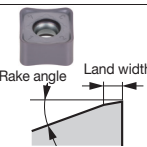
Shape	Designation	Coated												Applicable mill
		AH120	AH3135	T1215	T3225									
	SNMU120608HNEN-MM	●	●	●	●									DOQ TM MILL THSN12... Page H067
	SNMU120612EN-MM		●	●										
	SNMU120620EN-MM			●	●									

● SNGU1307ANEN-MJ, SNGU1307ANEN-W, SNGU1307ANEN-MH, SNMU1307ANEN-MJ

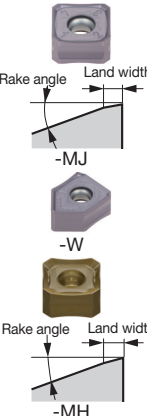
Shape	Designation	Coated												Applicable mill
		AH120	AH3135	T3225	T1215									
	SNGU1307ANEN-MJ	●	●	●	●									DOT TM MILL TASN13... Page H060
	SNGU1307ANEN-W	●	●											
	SNGU1307ANEN-MH			●										
	SNMU1307ANEN-MJ	●	●	●	●									

● SNMU1706ANPR-MJ, SNHU1706ANPR-MJ, SNMU1706ANTR-ML, SNHU1706ANTR-ML, SNHU1706ANFN-W

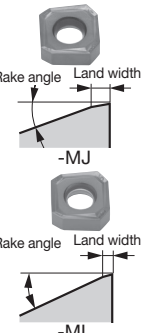
Shape	Designation	Coated														Applicable mill
		AH120	AH140	AH725	AH3135	T1215	T3225									
	SNMU1706ANPR-MJ		●	●	●	●	●									DOOCTO TAN07... Page H063, H064
	SNMU1706ANTR-ML	●				●										
	SNHU1706ANPR-MJ			●	●											
	SNHU1706ANTR-ML	●														
	SNHU1706ANFN-W	●														

● : Line up

Grade
Insert
Ext. Toolholder
Int. Toolholder
Threading
Grooving
Milling Cutter
Miniature Tool
Endmill
Drilling Tool
User's Guide Tooling System
Index





Milling Insert

● SNMN1204**TN

Shape	Designation	Coated			Cermic		Uncoated		Applicable mill
		AH120	T1115	T3130	FX105		UX30		
	SNMN120408TN				●				TGN4200R-A (Old item)
	SNMN120412TN	●	●	●	●		●		
	SNMN120416TN				●				
	SNMN120420TN				●				
	SNMN120424TN				●				

● SPCN42..., SPEN42..., SPKN42..., SPKR42SSR-MJ, SPGN120312TN

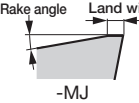
Shape	Designation	Coated					Cermet		Ceramic	Uncoated		Applicable mill
		AH120	AH140	GH330	T1115	T3130	NS740	N308	FX105	UX30	TH10	
  	SPCN42STR						●	●		●		TGP4100RIA/ RBA/RBAE (Old item)
	SPCN42SFR										●	
	SPEN42STR						●					
	SPKN42STR	●	●	●	●	●	●	●	●	●		
	SPKN42STL						●			●		
	SPKN42SFR										●	
	SPKN42SFL										●	
	SPKR42SSR-MJ			●	●	●						
	SPGN120312TN								●			
	SPEN423TN					●	●			●		
	SPEN423FN										●	

● SP*N42...

Shape	Designation	Coated		Cermet			Uncoated		Applicable mill
		T1115	T3130	NS740	X407	N308	UX30	TH10	
	SPAN42ZFR							●	TGP4200R-A (Old item)
	SPCN42ZFL							●	
	SPCN42ZFR							●	
	SPCN42ZTR			●	●	●			
	SPEN423TN		●	●			●		
	SPEN423FN							●	
	SPEN42ZTR			●					
	SPKN42ZFL							●	
	SPKN42ZFR							●	
	SPKN42ZTR	●	●	●	●	●	●		

● : Line up

Milling Insert

● SP*N53S..., SPKR53SSR-MJ

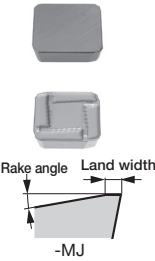
Shape	Designation	Coated			Cermet		Uncoated		Applicable mill
		GH330	T1115	T3130	NS740	N308	UX30	TH10	
 <p>Rake angle Land width -MJ</p>	SPCN53SFR							TGP5100RIA (Old item)	
	SPCN53STR					●	●		
	SPKN53SFR								●
	SPKN53STL						●		
	SPKN53STR	●	●		●		●		
	SPKN53STR20			●			●		
	SPKR53SSR-MJ	●		●					

● SPGN120412TN

Shape	Designation	Coated		Ceramic		Applicable mill
		T1115		FX105		
	SPGN120412TN	●		●		QFP4000 (Old item)

● SPHA**FNW

Shape	Designation	Cermet		Uncoated		Applicable mill
		N308		TH10		
	SPHA431FNW	●		●		TSP4000RIA-U Page H148
	SPHA435FNW	●		●		TFP4000IA TFD4400-A SFP4000R EFP4000R (Old item)

● SPMA422...

Shape	Designation	Cermet		Uncoated		Applicable mill
		NS740	N308	UX30	TH10	
	SPMA422TN	●	●	●		ECP4400R Page H220
	SPMA422FN				●	

● : Line up

Grade
Insert
Toolholder
Ext. Toolholder
Int. Toolholder
Threading
Grooving
Tool
Miniature Tool
Milling Cutter
Endmill
Drilling Tool
Tooling System
User's Guide
Index

A
B
C
D
E
F
G
H
I
J
K
L
M

Milling Insert

● SPMP..., SPMM**ERD

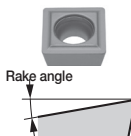
Shape	Designation	Coated							Applicable mill
		T313W	AH6030						
	SPMP771-CG		●						TCB... Page H223
	SPMP831-CG		●						
	SPMP042ER-CG		●						
	SPMP322ER-CG		●						
	SPMP432ER-CG		●						
	SPMP831DS	●							
	SPMP042ERD	●							
	SPMM322ERD	●							
	SPMM432ERD	●							

● SPMR1605PPTR-MJ, SPMR1605PPPR-ML, SPMR1605PPTR-MH

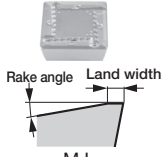
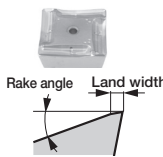
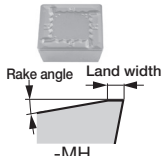
Shape	Designation	Coated			Uncoated				Applicable mill
		GH330	T1115	T3130	UX30				
 <p>-MJ</p>	SPMR1605PPTR-MJ	●	●	●	●				TPP16... (Old item)
	SPMR1605PPPR-ML	●							
	SPMR1605PPTR-MH	●		●	●				
 <p>-ML</p>									
 <p>-MH</p>									

● SQMU1206ZSR-MJ

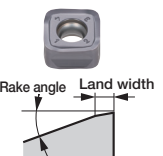
Shape	Designation	Coated							Applicable mill
		AH120	AH130	AH725	T3130				
 <p>-MJ</p>	SQMU1206ZSR-MJ	●	●	●	●				DOFEEDQUAD TXQ... Page H043

● : Line up

Milling Insert

● SSM..., SSS...

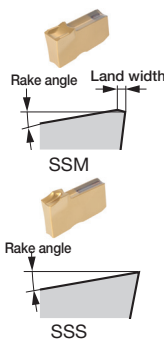
Shape	Designation	Coated							Applicable mill
		GH130							
 <p>SSM</p> <p>SSS</p>	SSM22N	●							TUNGSLIT S/ASG... Page H151
	SSM31N	●							
	SSM41N	●							
	SSS16N	●							
	SSS22N	●							
	SSS31N	●							
	SSS41N	●							

● SWMT13T3AFPR-MJ, SWMT13T3AFER-ML, SWMW13T3AFTR, SWMT13T3AFPR-HJ, SWMT13T3AFPR-MS, SWGT13T3AFPR-MJ, SWGT13T3AFFR-AJ

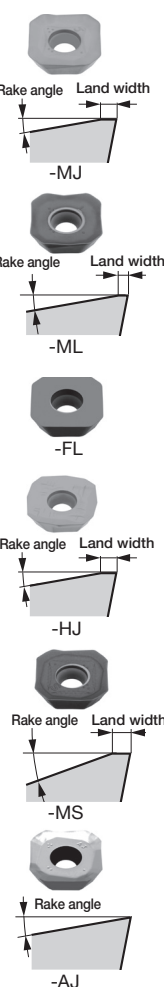
Shape	Designation	Coated							Cermet	Uncoated	Applicable mill		
		AH120	AH130	AH140	AH3135	T1115	T1215	T3130	T3225	DS1100		NS740	KS05F
 <p>-MJ</p> <p>-ML</p> <p>-FL</p> <p>-HJ</p> <p>-MS</p> <p>-AJ</p>	SWMT13T3AFPR-MJ	●	●	●	●	●	●	●	●	●	●	TUNG MILL TAW13... Page H074 EAW13... Page H075	
	SWMT13T3AFER-ML	●			●								
	SWMW13T3AFTR	●			●	●	●	●	●		●		
	SWMT13T3AFPR-HJ	●	●	●	●	●	●	●	●				
	SWMT13T3AFPR-MS		●	●	●								
	SWGT13T3AFPR-MJ	●			●					●			
	SWGT13T3AFFR-AJ										●		

● : Line up



Milling Insert

● SWMT1304PDPR-MJ, SWMT1304PDER-ML, SWMT1304PDPR-MS, SWGT1304PDPR-MJ, SWGT1304PDFR-AJ

Shape	Designation	Coated								Cermet		Uncoated		Applicable mill	
		AH120	AH130	AH140	AH3135	T1115	T1215	T3130	T3225	DS1100	NS740	KS05F			
 -MJ -ML -MS -AJ	SWMT1304PDPR-MJ	●	●	●	●	●	●	●	●	●			TUNG MILL TPW13... Page H132 EPW13... Page H133		
	SWMT1304PDER-ML	●			●										
	SWMT1304PDPR-MS		●	●											
	SWGT1304PDPR-MJ	●	●								●				
	SWGT1304PDFR-AJ	●	●							●				●	

● SWMT0904ZER-MM, SWMT0904UER-MM, SWMT1506ZER-MM, SWMT1506UER-MM, SWMT1506ZER-MT

Shape	Designation	Coated										Applicable mill			
		AH120	AH3135												
 -MT -MM	SWMT0904ZER-MM		●										MILLQ ^{UP} FEED TXSW09... Page H046 EXSW09... Page H046 TXSW15... Page H047		
	SWMT0904UER-MM		●												
	SWMT1506ZER-MM	●	●												
	SWMT1506UER-MM	●	●												
	SWMT1506ZER-MT	●	●												

● T*-R...

Shape	Designation	Coated								Applicable mill
		GH330								
	T1-R14	●								Thread milling cutter Page H214
	T1-R28	●								
	T2-R14	●								
	T2-R28	●								

Milling Insert

● TCGT160608PDER-MJ, TCMT160620PDER-NMJ

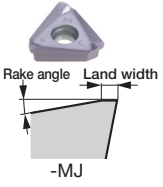
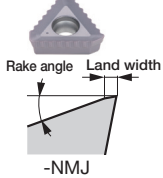
Shape	Designation	Coated				Applicable mill
		AH120	AH3135	T1215	T3225	
 -MJ	TCGT160608PDER-MJ	●	●			TUNG-TRISHRED LPTC16... Page H108 TPTC16... Page H108 EPTC16... Page H109
	TCMT160620PDER-NMJ	●	●	●	●	
 -NMJ						

● TDMN**N

Shape	Designation	Cermet	Uncoated	Applicable mill
		NS740	TH10 UX30	
	TDMN110304TN	●		ESD2000 (Old item)
	TDMN110304FN		●	
	TDMN110308TN	●	●	

● TECN32..., TEEN32..., TECN32ZFR-DIA, TEKR1603PEPR-MS

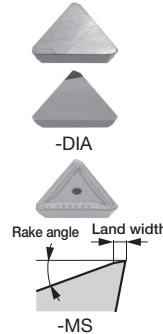
Shape	Designation	Coated								Cermet	Uncoated	PCD	Applicable mill			
		AH120	AH130	AH140	AH330	AH3135	GH330	T1115	T3130	T1215	T3225	NS740		N308	UX30	TH10
 -DIA -MS	TECN32ZFR													●		TSE3000R ESE3000R (Old item)
	TECN32ZTR										●	●	●			
	TEEN32ZFR													●		
	TEEN32ZTR	●	●	●	●	●	●	●	●	●	●	●	●			
	TECN32ZFR-DIA														●	
	TEKR1603PEPR-MS			●												

DX140: Packing quantity = 1pc.

● : Line up

Grade
Insert
Ext. Toolholder
Int. Toolholder
Threading
Grooving
Miniature Tool
Endmill
Drilling Tool
Tooling System
Index



Milling Insert

● TECN43..., TEEN43..., TECN43ZFR-DIA, TEKR2204PEPR-MS

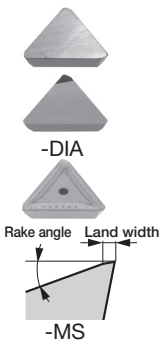
Shape	Designation	Coated								Cermet			Uncoated		PCD	Applicable mill	
		AH120	AH130	AH140	AH330	AH3135	GH330	T1115	T3130	T1215	T3225	NS740	N308	UX30	TH10		DX140
	TECN43ZFR																TSE4000RIAU Page H146 ESE4000R (Old item)
	TECN43ZTR										●	●	●				
	TEEN43ZFR													●			
	TEEN43ZTR	●	●	●	●	●	●	●	●	●	●	●	●	●			
	TECN43ZFR-DIA														●		
	TEKR2204PEPR-MS			●													

DX140: Packing quantity = 1pc.

● TNGU120708PER-MJ, TNMU1207R16PER-MJ, TNMU120708PER-MJ, TNMU120708PER-NMJ

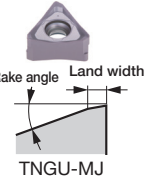
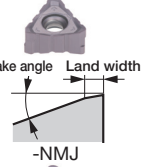
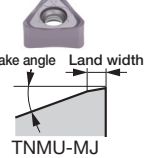
Shape	Designation	Coated															Applicable mill
		AH120	AH3135	T1215	T3225												
	TNMU070304PER-MJ	●	●														DOFTRI TPTN12... Page H094 EPTN12... Page H095
	TNMU070308PER-MJ	●	●														
	TNGU120708PER-MJ	●	●	●													
	TNMU1207R16PER-MJ	●	●														
	TNMU120708PER-MJ	●	●	●	●												
	TNMU120708PER-NMJ	●	●														
																	
																	

● TNKF64ZTR

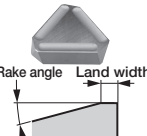
Shape	Designation	Uncoated											Applicable mill				
		UX30															
	TNKF64ZTR	●															TPN6400I (Old item)

● : Line up

Milling Insert

● TNMN43ZENS

Shape	Designation	Uncoated							Applicable mill
		UX30							
	TNMN43ZENS	●							TSN4000 ESN4000 (Old item)

● TOMT**PDER-MJ, TOMT150608PDER-NMJ, TOGT**PDFR-AJ

Shape	Designation	Coated				Uncoated			Applicable mill
		AH120	AH3135	T1215	T3225	KS05F			
	TOMT060302PDER-MJ	●	●						TUNG-TRI TPA06... Page H097 EPA06... Page H097 HPA06... Page H098 TPA10... Page H098 TLA10... Page H099 EPA10... Page H099 HPA10... Page H100 TPA15... Page H100 TLA15... Page H101 EPA15... Page H103
	TOMT060304PDER-MJ	●	●						
	TOMT060308PDER-MJ	●	●	●	●				
	TOMT100404PDER-MJ	●	●						
	TOMT100408PDER-MJ	●	●	●	●				
	TOMT100416PDER-MJ	●	●						
	TOMT150604PDER-MJ	●	●						
	TOMT150608PDER-MJ	●	●	●	●				
	TOMT150616PDER-MJ	●	●						
	TOMT150620PDER-MJ	●	●						
	TOMT150608PDER-NMJ	●	●		●				
	TOGT100404PDFR-AJ					●			
	TOGT100408PDFR-AJ					●			
	TOGT150604PDFR-AJ					●			
	TOGT150608PDFR-AJ					●			

● TPCA43ZTRW1, TPMA432TNW1

Shape	Designation	Cermet		Uncoated		Applicable mill
		NS740		UX30	TH10	
	TPCA43ZTRW1				●	PES1500... (Old item)
	TPMA432TNW1	●		●	●	

● TP*N43Z..., TPKR43ZSR-MJ, TPMP2204PDSR-MJ

Shape	Designation	Coated						Cermet		Uncoated		Applicable mill
		AH120	AH130	AH140	GH330	T1115	T3130	NS740	N308	UX30	TH10	
	TPCN43ZFR							●	●	●	●	TSP4000RIA-U Page H148
	TPCN43ZTR							●	●	●	●	
	TPEN43ZTR							●				TFP4000IA (Old item)
	TPEN43ZTRCR											
	TPKN43ZFR										●	
	TPKN43ZFL										●	
	TPKN43ZTR	●	●	●	●	●	●	●	●	●	●	
	TPKR43ZSR-MJ				●	●						
	TPMP2204PDSR-MJ				●	●						

● : Line up



Milling Insert

● TPMN**TN

Shape	Designation	Cermet					Applicable mill
		NS740					
	TPMN110304TN	●					(Old item)
	TPMN110308TN	●					
	TPMN160308TN	●					
	TPMN160312TN	●					
	TPMN220408TN	●					
	TPMN220412TN	●					

● TVKX**TN-MJ

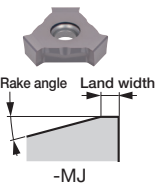
Shape	Designation	Coated			Applicable mill
		AH120	AH130	AH725	
	TVKX020202TN-MJ	●		●	TUNGSLIT ASV 02/03/04/05... Page H155
	TVKX020204TN-MJ	●		●	
	TVKX03X302TN-MJ	●		●	
	TVKX03X304TN-MJ	●		●	
	TVKX04H304TN-MJ	●	●	●	
	TVKX04H308TN-MJ	●	●	●	
	TVKX050404TN-MJ	●	●	●	
	TVKX050408TN-MJ	●	●	●	

● WCMT**-D4

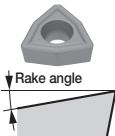
Shape	Designation	Coated		Applicable mill
		AH120	AH140	
	WCMT050308-D4	●	●	EVX... HVX... (Old item)
	WCMT06T308-D4	●	●	

● WDCN42ZFR-DIA

Shape	Designation	PCD					Applicable mill
		DX140					
	WDCN42ZFR-DIA	●					TMD4400RI-U Page H087 EMD4400RI TGD4400-A EGD4400 (Old item)

DX140: Packing quantity = 1pc.

● : Line up

Milling Insert

● WECN42ZFR-DIA

Shape	Designation	PCD					Applicable mill
		DX140					
 Wiper edge -DIA	WECN42ZFR-DIA	●					THE4000RIA (Old item)

DX140: Packing quantity = 1pc.

● WFCN**ZFR-DIA

Shape	Designation	PCD					Applicable mill
		DX140					
 Wiper edge -DIA	WFCN42ZFR-DIA	●					THF4400RIA
	WFCN53ZFR-DIA	●					THF5400RIA (Old item)

DX140: Packing quantity = 1pc.

● WNGU**TN-MJ

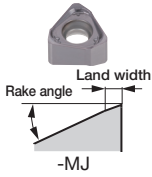
Shape	Designation	Coated				Applicable mill
		AH120	AH130	AH725	AH3135	
 -MJ	WNGU060304TN-MJ	●			●	TUNGUSLOT ASW 06/07/09... Page H157 TSW 06/07/09... Page H157
	WNGU060308TN-MJ	●	●	●	●	
	WNGU060310TN-MJ	●			●	
	WNGU060316TN-MJ	●	●	●		
	WNGU060320TN-MJ	●			●	
	WNGU07T304TN-MJ	●			●	
	WNGU07T308TN-MJ	●	●	●		
	WNGU07T310TN-MJ	●			●	
	WNGU07T316TN-MJ	●	●	●		
	WNGU07T320TN-MJ	●			●	
	WNGU090404TN-MJ	●			●	
	WNGU090408TN-MJ	●	●	●		
	WNGU090410TN-MJ	●			●	
	WNGU090416TN-MJ	●	●	●		
WNGU090420TN-MJ	●			●		

● WPAN42SFR

Shape	Designation	Cermet	Uncoated				Applicable mill
		N308	TH10				
 Wiper edge (2-corner type)	WPAN42SFR	●	●				TGP4100RIA/ RBA/RBAE (Old item)

● : Line up

Grade
Insert
Toolholder
Ext. Toolholder
Int. Toolholder
Threading
Grooving
Miniature Tool
Milling Cutter
Endmill
Drilling Tool
Tooling System
User's Guide
Index



Milling Insert









● WPAN42SFRS

Shape	Designation	Uncoated							Applicable mill
		TH10							
 Wiper edge (1-corner type)	WPAN42SFRS	●							TGP4100RIA/ RBA/RBAE (Old item)

● WPAN42ZFR

Shape	Designation	Uncoated							Applicable mill
		TH10							
 Wiper edge (2-corner type)	WPAN42ZFR	●							TGP4200R-A (Old item)

● WPMT**ZPR..., WPMT**ZPR-ML, WPMT**-MH, WPMT**-DML, WPMW**ZSR

Shape	Designation	Coated						Applicable mill
		AH120	AH130	AH140	AH730	T3130	AH3135	
	WPMW05H315ZPR	●		●		●	●	MILLFEED TXP05/06/08/09... Page H051 EXP05/06/08/09... Page H052 HXP... (Old item)
	WPMT05H315ZPR-ML	●		●		●	●	
	WPMT05H315ZPR-MH	●		●			●	
	WPMT05H315ZPR-DML				●			
	WPMW06X415ZPR	●		●		●	●	
	WPMT06X415ZPR-ML	●	●	●		●	●	
	WPMT06X415ZPR-MH	●		●			●	
	WPMT06X415ZPR-DML				●			
	WPMT080615ZSR	●	●	●		●	●	
	WPMT080615ZPR-ML	●	●	●		●	●	
	WPMT080615ZSR-MH	●		●			●	
	WPMT080615ZPR-DML				●			
	WPMT090725ZSR	●		●		●	●	
	WPMT090725ZPR-ML	●	●	●		●	●	
	WPMT090725ZSR-MH	●	●	●			●	
	WPMT090725ZPR-DML				●			

● WWCW13T3AFER-WS, WWCW13T3AFFR-WS, WWCW13T3AFFR-WD

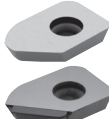
Shape	Designation	Coated		Cermet	Uncoated	PCD	Applicable mill
		GH110	DS1100	NS740	KS05F	DX140	
 -WD	WWCW13T3AFER-WS	●		●			TUNG MILL TAW13... Page H074 EAW13... Page H075
	WWCW13T3AFFR-WS		●		●		
	WWCW13T3AFFR-WD					●	

DX140: Packing quantity = 1pc.

● : Line up

Milling Insert

● WXHU**R-MJ

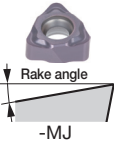
Shape	Designation	Coated							Applicable mill
		AH110							
	WXHU040305R-MJ	●							DOMMILL HFWX04... Page H171
	WXHU040310R-MJ	●							

● XCET310404ER

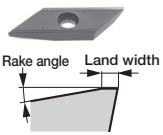
Shape	Designation	Coated			Cermet	Uncoated		Applicable mill
		AH330	AH120	AH3135	NS740	UX30		
	XCET310404ER	●	●	●	●	●		ECC31... Page H218

● XVCT16**R-AJ

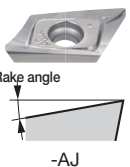
Shape	Designation	Uncoated							Applicable mill
		TH10							
	XVCT160504R-AJ	●							TUNG-ALUMILL TPV16... Page H143 EPV16... Page H143
	XVCT160508R-AJ	●							
	XVCT160512R-AJ	●							
	XVCT160516R-AJ	●							
	XVCT160520R-AJ	●							
	XVCT160524R-AJ	●							
	XVCT160525R-AJ	●							
	XVCT160530R-AJ	●							
	XVCT160532R-AJ	●							
	XVCT160540R-AJ	●							
XVCT160550R-AJ	●								

● XVGT**EC-MJ, XVGT**EP-MJ, XVGT**FC-AJ, XVGT**FP-AJ

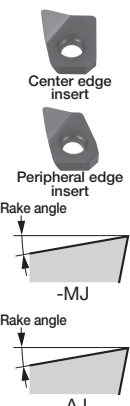
Shape	Designation	Coated									Applicable mill	
		AH730	DS1200									
	XVGT06H205EC-MJ	●										HYBRIDTACMILL EVH... (Old item)
	XVGT07X305EC-MJ	●										
	XVGT09X405EC-MJ	●										
	XVGT06H205EP-MJ	●										
	XVGT07X305EP-MJ	●										
	XVGT09X405EP-MJ	●										
	XVGT06H205FC-AJ		●									
	XVGT07X305FC-AJ		●									
	XVGT09X405FC-AJ		●									
	XVGT06H205FP-AJ		●									
	XVGT07X305FP-AJ		●									
	XVGT09X405FP-AJ		●									

● : Line up

Grade
 Insert
 Ext. Toolholder
 Int. Toolholder
 Threading
 Grooving
 Milling Cutter
 Miniature Tool
 Endmill
 Drilling Tool
 User's Guide Tooling System
 Index



Milling Insert

● XHGR**ER-MJ, XHGR**FR-AJ

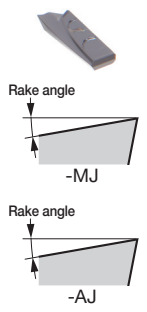
Shape	Designation	Coated								Applicable mill
		AH730	DS1200							
	XHGR110202ER-MJ	●								HYBRIDTACMILL EPH11/13/18... (Old item)
	XHGR110204ER-MJ	●								
	XHGR110205ER-MJ	●								
	XHGR110208ER-MJ	●								
	XHGR110210ER-MJ	●								
	XHGR110212ER-MJ	●								
	XHGR110215ER-MJ	●								
	XHGR110216ER-MJ	●								
	XHGR110220ER-MJ	●								
	XHGR130202ER-MJ	●								
	XHGR130204ER-MJ	●								
	XHGR130205ER-MJ	●								
	XHGR130208ER-MJ	●								
	XHGR130210ER-MJ	●								
	XHGR130212ER-MJ	●								
	XHGR130215ER-MJ	●								
	XHGR130216ER-MJ	●								
	XHGR130220ER-MJ	●								
	XHGR18T202ER-MJ	●								
	XHGR18T204ER-MJ	●								
	XHGR18T205ER-MJ	●								
	XHGR18T208ER-MJ	●								
	XHGR18T210ER-MJ	●								
	XHGR18T212ER-MJ	●								
	XHGR18T215ER-MJ	●								
	XHGR18T216ER-MJ	●								
	XHGR18T220ER-MJ	●								
	XHGR110200FR-AJ			●						
	XHGR110202FR-AJ			●						
	XHGR110204FR-AJ			●						
	XHGR110205FR-AJ			●						
	XHGR110208FR-AJ			●						
	XHGR110210FR-AJ			●						

● XHGR**ER-MJ, XHGR**FR-AJ

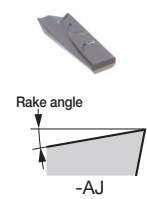
Shape	Designation	Coated								Applicable mill
		AH730	DS1200							
	XHGR130212FR-AJ		●							HYBRIDTACMILL EPH11/13/18... (Old item)
	XHGR130215FR-AJ		●							
	XHGR130216FR-AJ		●							
	XHGR130220FR-AJ		●							
	XHGR18T200FR-AJ		●							
	XHGR18T202FR-AJ		●							
	XHGR18T204FR-AJ		●							
	XHGR18T205FR-AJ		●							
	XHGR18T208FR-AJ		●							
	XHGR18T210FR-AJ		●							
	XHGR18T212FR-AJ		●							
	XHGR18T215FR-AJ		●							
	XHGR18T216FR-AJ		●							
	XHGR18T220FR-AJ		●							

● : Line up

Milling Insert

● XXGT**EC-MJ, XXGT**FC-AJ, XXGT**EP-MJ, XXGT**FP-AJ

Shape	Designation	Coated			Applicable mill
		AH730	DS1200		
<p>Center edge insert</p> <p>Peripheral edge insert</p> <p>Rake angle</p> <p>-MJ</p> <p>Rake angle</p> <p>-AJ</p>	XXGT06H205EC-MJ	●			HYBRIDTACMILL EXH... (Old item)
	XXGT07X305EC-MJ	●			
	XXGT09X408EC-MJ	●			
	XXGT06H205FC-AJ		●		
	XXGT07X305FC-AJ		●		
	XXGT09X408FC-AJ		●		
	XXGT06H205EP-MJ	●			
	XXGT07X305EP-MJ	●			
	XXGT09X408EP-MJ	●			
	XXGT06H205FP-AJ		●		
	XXGT07X305FP-AJ		●		
	XXGT09X408FP-AJ		●		

● XXMU**PR-MJ

Shape	Designation	Coated			Applicable mill
		AH120	AH140	AH3135	
<p>Rake angle Land width</p> <p>-MJ</p>	XXMU08T204PR-MJ	●	●	●	EVX... Page H216 HVX... (Old item)
	XXMU10H308PR-MJ	●	●	●	
	XXMU12X408PR-MJ	●	●	●	
	XXMU16X508PR-MJ	●	●	●	

● YDEN0905PDFR-D, YDEN0905PDFR-WD, YDEN0905PDFR-BD

Shape	Designation	PCD			Applicable mill
		DX140			
<p>Regular edge</p> <p>Wiper edge</p> <p>Wiper for burr removal</p>	YDEN0905PDFR-D	●			DPD09... Page H085 EDPD09... Page H085
	YDEN0905PDFR-WD	●			
	YDEN0905PDFR-BD	●			

DX140: Packing quantity = 1pc.

● YDEN1505ADFR-D, YDEN1505ADFR-WD

Shape	Designation	PCD			Applicable mill
		DX140			
<p>Regular edge</p> <p>Wiper edge</p>	YDEN1505ADFR-D	●			DAD15... (Old item)
	YDEN1505ADFR-WD	●			



DX140: Packing quantity = 1pc.

● : Line up





Milling Insert

● YDEN1505PDFR-D, YDEN1505PDFR-WD



Shape	Designation	PCD							Applicable mill
		DX140							
 Regular edge  Wiper edge	YDEN1505PDFR-D	●							DPD15... EDPD15... (Old item)
	YDEN1505PDFR-WD	●							

DX140: Packing quantity = 1pc.

● YDEN0603PDF/SR-D, YDEN0603PDFR-WD, YDEN0603PDFR-BD



Shape	Designation	PCD							Applicable mill
		DX110							
 _D  _WD  _BD	YDEN0603PDFR-D	●							TUNGSMILL TPYD06... Page H079 EPYD06... Page H079
	YDEN0603PDSR-D	●							
	YDEN0603PDFR-WD	●							
	YDEN0603PDFR-BD	●							

● YDEN2405PDFR-D, YDEN2405PDFR-WD, YDEN2405PDFR-BD

Shape	Designation	PCD							Applicable mill
		DX140							
 Regular edge  Wiper edge  Wiper for burr removal	YDEN2405PDFR-D	●							DPD24... (Old item)
	YDEN2405PDFR-WD	●							
	YDEN2405PDFR-BD	●							

DX140: Packing quantity = 1pc.

● YPEB12X3-1A**-D, YPEB12X3-1P**-D, YPEB12X3-2A**-D, YPEB12X3-FP**-D, YPEB12X3-2P07R-D

Shape	Designation	PCD							Applicable mill
		DX160							
 -1A/P  -FP  -2A/P	YPEB12X3-1A01R-D	●							TUNGSMILL TPYP12... EPYP12...
	YPEB12X3-1A02R-D	●							
	YPEB12X3-1A07R-D	●							
	YPEB12X3-1P02R-D	●							
	YPEB12X3-1P07R-D	●							
	YPEB12X3-FP02R-D	●							
	YPEB12X3-FP07R-D	●							
	YPEB12X3-2A01R-D	●							
	YPEB12X3-2A02R-D	●							
	YPEB12X3-2A07R-D	●							
	YPEB12X3-2P07R-D	●							

DX160: Packing quantity = 2pcs.

● : Line up

Milling Insert

● YPEN1505PPTR-Q

Shape	Designation	T-CBN							Applicable mill
		BX950							
	YPEN1505PPTR-Q	●							QPP15... (Old item)

BX950: Packing quantity = 1pc.



● ZDCA**TN

Shape	Designation	Uncoated							Applicable mill
		UX30							
	ZDCA0804TN ZDCA1105TN	● ●							TBF1000 (Old item)

● ZDMT**-MJ

Shape	Designation	Coated							Applicable mill
		AH120							
 Rake angle Land width -MJ	ZDMT4005-MJ ZDMT5006-MJ	● ●							EBD... Page H186 HBD... (Old item)

● ZFBM**-MJ, ZFRM**-MJ

Shape	Designation	Coated							Applicable mill
		AH710	AH725						
 Rake angle ZFBM-MJ	ZFBM080R00-MJ ZFBM100R00-MJ ZFBM120R00-MJ ZFBM160R00-MJ ZFBM200R00-MJ ZFBM250R00-MJ ZFBM300R00-MJ ZFBM320R00-MJ	● ● ● ● ● ● ● ●	● ● ● ● ● ● ● ●						BALLFNÖSE EBFU... Page H166 HBFM... Page H167
 Rake angle ZFRM-MJ	ZFRM120R05-MJ ZFRM120R10-MJ ZFRM160R05-MJ ZFRM160R10-MJ ZFRM160R15-MJ ZFRM200R10-MJ ZFRM200R15-MJ	● ● ● ● ● ● ●	● ● ● ● ● ● ●						

● : Line up

Grade
Insert
Toolholder
Ext. Toolholder
Int. Toolholder
Threading
Grooving
Miniature Tool
Milling Cutter
Endmill
Drilling Tool
Tooling System
User's Guide
Index

A
B
C
D
E
F
G
H
I
J
K
L
M

Milling Insert

● ZFBU**-MJ, ZFBU**-ML, ZFRU**-MJ

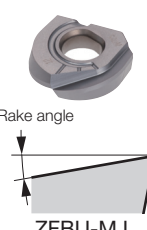
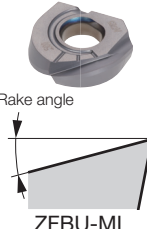
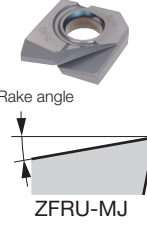
Shape	Designation	Coated							Applicable mills
		AH725							
 <p>Rake angle ZFBU-MJ</p>	ZFBU037R00-MJ	●							BALLFNÖSE EBFU... Page H166
	ZFBU050R00-MJ	●							
	ZFBU062R00-MJ	●							
	ZFBU075R00-MJ	●							
	ZFBU062R00-MJ	●							
	ZFBU100R00-MJ	●							
	ZFBU075R00-MJ	●							
	ZFBU125R00-MJ	●							
	ZFBU037R00-ML	●							
	ZFBU050R00-ML	●							
	ZFBU062R00-ML	●							
	ZFBU075R00-ML	●							
 <p>Rake angle ZFBU-ML</p>	ZFBU100R00-ML	●							
	ZFBU125R00-ML	●							
	ZFRU037R003-MJ	●							
	ZFRU050R003-MJ	●							
	ZFRU050R006-MJ	●							
	ZFRU050R012-MJ	●							
	ZFRU062R003-MJ	●							
	ZFRU062R006-MJ	●							
	ZFRU062R012-MJ	●							
	ZFRU075R003-MJ	●							
	ZFRU075R006-MJ	●							
	ZFRU075R012-MJ	●							
 <p>Rake angle ZFRU-MJ</p>	ZFRU100R003-MJ	●							
	ZFRU100R006-MJ	●							
	ZFRU100R012-MJ	●							
	ZFRU125R003-MJ	●							
	ZFRU125R006-MJ	●							
	ZFRU125R012-MJ	●							

● : Line up

Milling Insert

● ZNCA**FN, ZNMM**EN

Shape	Designation	Uncoated							Applicable mill
		UX30	TH10						
	ZNCA1002FN2	●	●						TBN1000 (Old item)
	ZNCA1203FN	●	●						
	ZNCA1603FN	●	●						
	ZNCA2004FN	●	●						
	ZNCA2505FN	●	●						
	ZNCA3005FN	●	●						
	ZNMM2004EN	●							
	ZNMM2505EN	●							
ZNMM3005EN	●								

● ZPET**_MJ

Shape	Designation	Coated							Applicable mill
		AH120	AH330						
 <small>Rake angle</small> <small>-MJ</small>	ZPET2004-MJ	●	●						EBP... Page H184 HBP... (Old item)
	ZPET2505-MJ	●	●						
	ZPET3006-MJ	●	●						
	ZPET3206-MJ	●	●						

● ZPCW**_QBN

Shape	Designation	T-CBN							Applicable mill
		BX950							
	ZPCW2003-QBN	●							EBB... (Old item)
	ZPCW25H3-QBN	●							
	ZPCW30T3-QBN	●							
	ZPCW4004-QBN	●							
	ZPCW5004-QBN	●							

BX950: Packing quantity = 1pc.

● ZRBM**_MM

Shape	Designation	Coated							Applicable mill
		APH730							
	ZRBM160-MM	●							BALL ^{NOSE} EBRU... Page H164 HBRM... Page H164
	ZRBM200-MM	●							
	ZRBM250-MM	●							
	ZRBU062-MM	●							
	ZRBU075-MM	●							
	ZRBU100-MM	●							

● : Line up

Grade
Insert
Toolholder
Ext. Toolholder
Int. Toolholder
Threading
Grooving
Miniature Tool
Milling Cutter
Endmill
Drilling Tool
Tooling System
User's Guide
Index



A
B
C
D
E
F
G
H
I
J
K
L
M

Milling Insert



● 2QP-SNGN..

Shape	Designation	CBN						Applicable mill
		BX910						
	2QP-SNGN090308	●						
	2QP-SNGN090312	●						





● 2QP-SPGW..., 2QP-SPGN...

Shape	Designation	CBN						Applicable mill
		BX910						
	2QP-SPGW09T308	●						
	2QP-SPGW09T312	●						
	2QP-SPGW120408	●						
	2QP-SPGW120412	●						
	2QP-SPGW120416	●						
	2QP-SPGN090308	●						
	2QP-SPGN090312	●						

● 3QP-TPGW..., 3QP-TPGN...

Shape	Designation	CBN						Applicable mill
		BX910						
	3QP-TPGW110308	●						
	3QP-TPGN110308	●						
	3QP-TPGN110312	●						
								

● S-CNGN..., S-RNGN..., S-SNGN..., S-TNGN...



Shape	Designation	CBN						Applicable mill
		BXC90						
	S-CNGN090308	●						
	S-CNGN090312	●						
	S-CNGN120408	●						
	S-CNGN120412	●						
	S-RNGN090300	●						
	S-RNGN120400	●						
	S-SNGN090308	●						
	S-SNGN090312	●						
	S-SNGN120308	●						
	S-SNGN120312	●						
	S-SNGN120408	●						
	S-SNGN120412	●						
	S-TNGN110308	●						
	S-TNGN110312	●						
	S-TNGN160408	●						
	S-TNGN160412	●						

● : Line up

Drilling Tool



Drilling Tool

		Inch	Metric
	2 Effective Drill	<input checked="" type="checkbox"/>	<input checked="" type="checkbox"/>
	J006, J009 J010 - J061		
	Indexable Drill	<input checked="" type="checkbox"/>	<input type="checkbox"/>
	J006 J063 - J092		
	Deep Hole Drill	<input checked="" type="checkbox"/>	<input checked="" type="checkbox"/>
	J007 J094 - J158		

Basic Selection of Drilling Tools

Application ranges of drilling tools

Indexable & Head-Changeable Drills

Inch

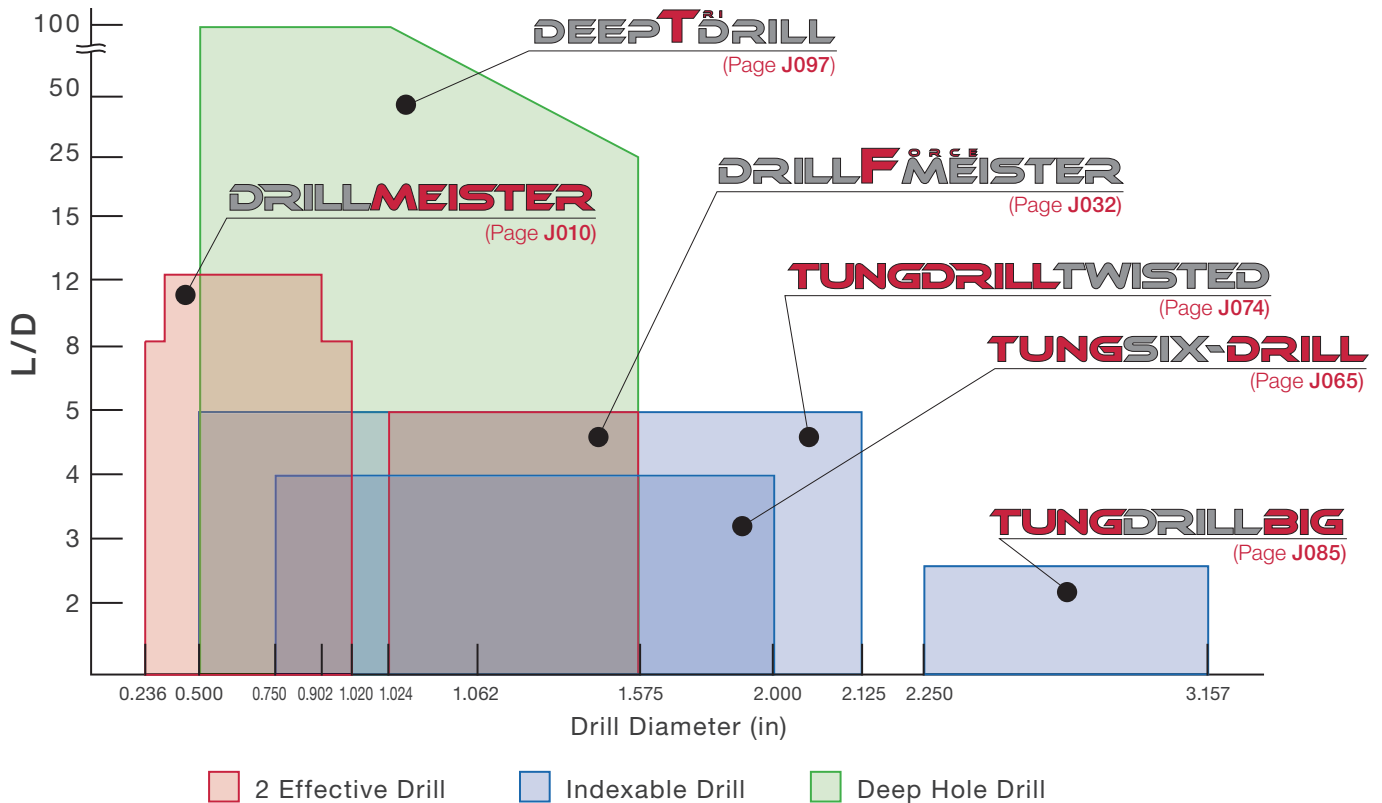

Hole diameter tolerance*

Inch

TUNGSIX-DRILL

L/D	Tool diameter	Hole diameter tolerance*
2	ø0.750 - ø1.062	+ 0.014 / 0
3	ø0.750 - ø1.062	+ 0.014 / 0
4	ø0.750 - ø2.000	+ 0.014 / 0

TUNGDRILLTWISTED

L/D	Tool diameter	Hole diameter tolerance*
2	ø0.500 - ø0.625	+ 0.010 / 0
	ø0.687 - ø2.125	+ 0.012 / 0
3	ø0.500 - ø0.625	+ 0.010 / 0
	ø0.687 - ø2.125	+ 0.012 / 0
4	ø0.500 - ø0.625	+ 0.016 / 0
	ø0.687 - ø2.125	+ 0.018 / 0
5	ø0.500 - ø0.625	+ 0.016 / 0
	ø0.687 - ø2.125	+ 0.018 / 0

DRILLMEISTER

L/D	Tool diameter	Hole diameter tolerance*
1.5	ø0.236 - ø1.020	+ 0.0020 / 0
3	ø0.236 - ø1.020	+ 0.0020 / 0
5	ø0.236 - ø0.783	+ 0.0024 / 0
	ø0.787 - ø1.020	+ 0.0026 / 0
8	ø0.276 - ø0.783	+ 0.0030 / 0
	ø0.787 - ø1.020	+ 0.0033 / 0
12	ø0.315 - ø0.705	+ 0.0031 / 0
	ø0.709 - ø0.902	+ 0.0037 / 0

DRILLF^{MEISTER}

L/D	Tool diameter	Hole diameter tolerance*
3	ø1.024 - ø1.142	+ 0.0020 / 0
	ø1.181 - ø1.575	+ 0.0024 / 0
5	ø1.024 - ø1.142	+ 0.0020 / 0
	ø1.181 - ø1.575	+ 0.0024 / 0

DEEPT^{DRILL}

L/D	Tool diameter	Hole diameter tolerance*
10	ø0.630 - ø1.500	+ 0.002 / - 0.004
15	ø0.500 - ø1.500	+ 0.002 / - 0.004
25	ø0.500 - ø1.500	+ 0.002 / - 0.004

*Just for reference

Indexable & Head-Changeable Drills

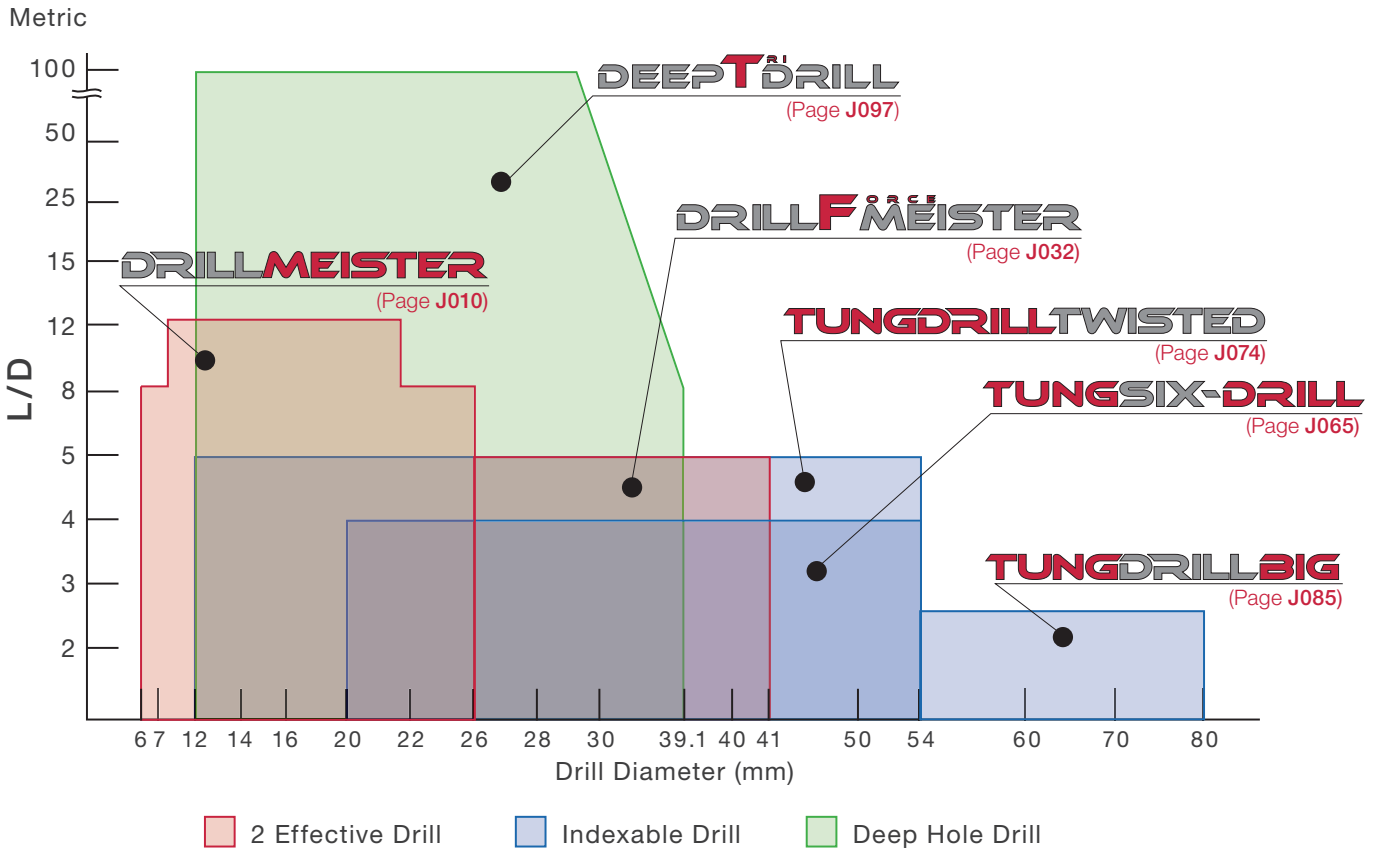



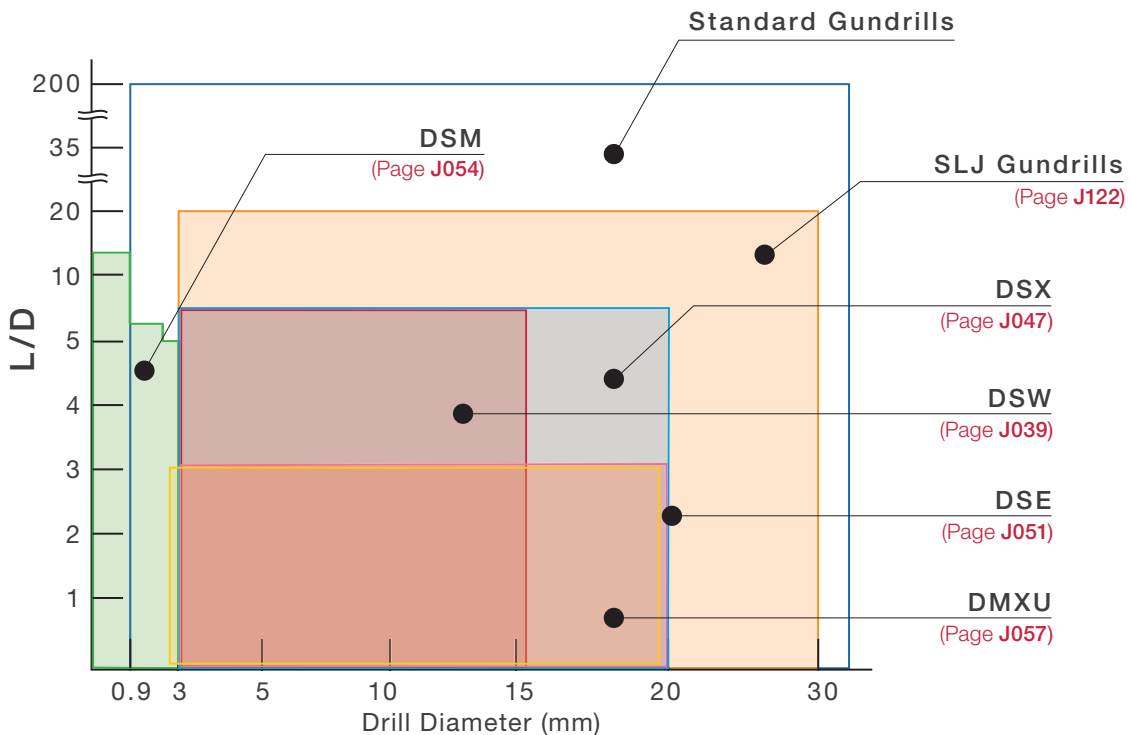





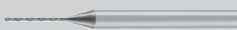

Solid Drills, Brazed Carbide Drills









General drilling - Quick Guide

★ : First choice
☆ : Second choice

Application	Tool diameter	L/D	Tool series	Appearance	IT class	Effective Cutting edge	Coolant supply	Workpiece material						Page
								P	M	K	N	S	H	
General drilling	ø0.394" - ø1.020" (ø6 mm - ø25.9 mm)	1.5 3 5 8 12	DRILLMEISTER Head changeable drill TIDU / TIDC / TIDCF		9 - 10	2	Int.	★	★	★	☆	★	★	J010 - J031
	ø1.024" - ø1.614" (ø26 mm - ø41 mm)	3 5	DRILLMEISTER Head changeable drill TISU		9 - 10	2	Int.	★	★	★	☆	★	★	J032 - J037
	ø3 mm - ø12 mm	3 5 8	SOLIDDRILL DSW		9 - 10	2	Int. / Ext.	★	★	★	☆	★	☆	J039 - J045
	ø0.1 mm - ø3 mm	5 10 15	SOLIDDRILL GIGAMINI DRILL DSM/DSM-CP		9 - 10	2	Ext.	★	★	★	☆	☆	☆	J054 - J056
	13/64" - 21/32" (ø3 mm - ø10 mm)	3 5 8	SOLIDDRILL GIGAJET DRILL DSXU / DSX		9 - 10	2	Int.	★	★	★	☆	☆	☆	J046 - J050
	ø3 mm - ø10 mm	2 3	SOLIDDRILL GIGAPOWER DRILL DSE		9 - 10	2	Ext.	★	☆	☆	☆	★	☆	J051 - J053
	#34" - 25/32"	2 3	SOLIDDRILL DMXU		9 - 10	2	Ext.	★	☆			★	☆	J057 - J059
	ø0.203" - ø0.625" (ø5 mm - ø16 mm)	5 8	SOLIDDRILL FDCU / FDC		9 - 10	2	Int.			★	★			J060 - J061
	ø0.750" - ø2.000"	2 3 4	TUNGDRILL Indexable Drill TDSU		11 -	1	Int.	★	★	★	☆	★	★	J064 - J073
	ø0.500" - ø2.125"	2 3 4 5	TUNGDRILL Indexable Drill TDXU		11 -	1	Int.	★	★	★	☆	★	★	J074 - J084
ø2.250" - ø3.157"	2	TUNGDRILL Indexable Drill TDB - TDSU / TDXU		11 -	1	Int.	★	★	★	☆	★	★	J085 - J091	

Deep drilling - Quick Guide

★ : First choice
☆ : Second choice

Application	Tool diameter	L/D	Tool series	Appearance	IT class	Effective Cutting edge	Coolant supply	Workpiece material						Page
								P	M	K	N	S	H	
Deep drilling	8 10 15 20 25 0.500" - 1.500" (0.12 mm - 0.39.1 mm)		DEEPTDRILL Head changeable deep drill MCTR/MCTRCH TRLG/TRLGCH		10	1	Int.	★	★	★	☆	★	★	J096 - J121
	Length ≤ 1650 mm (for gundrill machines)		GUNDRILL Brazed gundrill SLJ		7 - 8	1	Int.	★	★	★	☆	☆	☆	J122
	016 mm - 028 mm	-	TRI-FINE Indexable BTA drill FNTR		10	1	Int.	★	★	★	☆	★	☆	J128 - J131
	025 mm - 065 mm	-	FINE-BEAM Indexable BTA drill FNBM		10	1	Int.	★	★	★	☆	★	★	J132 - J137
	038 mm - 0106.99 mm	-	UNIDEX Indexable BTA drill KUSTS/KUDTS		10	1	Int.	★	★	★	☆	★	☆	J138 - J143
	08 mm - 065 mm	-	Brazed BTA drill MBU/UTE/BTU		9	1	Int.	★	★	★	☆	★	☆	J144 - J156
	030 mm - 063 mm	6 - 14	HF drill Head changeable deep drill HF		10	1	Int.	★	★	★	☆	★	★	J157 - J158

Grade
Insert
Toolholder
Ext. Toolholder
Int. Toolholder
Threading
Grooving
Miniature Tool
Milling Cutter
Endmill
Drilling Tool
Tooling System
User's Guide
Index



2 Effective Drill

Head changeable drill



DRILLMEISTER

Head changeable drill series



ø0.236" - ø1.020" (ø6 mm - ø25.9 mm) / L/D = 1.5, 3, 5, 8, 12
 ※ L/D = 12 : ø0.472" - ø0.488" (ø8 mm - ø22.9 mm)

J009 - J031

Inch Metric



DRILL FORCE MEISTER

Two cutting edges for productivity in large diameter drilling



ø1.024" - ø1.614" (ø26 mm - ø41 mm) / L/D = 3, 5

J032 - J037

Inch Metric

Solid Drill



SOLIDDRILL

High performance solid carbide drill

J038 - J061

Inch Metric



DSW



ø3 mm - ø12 mm / L/D = 3, 5, 8

J039 - J045

Inch Metric



DSXU / DSX

13/64" - 21/32" (ø3 mm - ø10 mm) / L/D = 3, 5, 8

J046 - J050

Inch Metric



DSE

ø3 mm - ø10 mm / L/D = 2, 3

J051 - J053

Inch Metric



DSM / DSM-CP

ø0.1 mm - ø3 mm / L/D = 5, 10, 15

J054 - J056

Inch Metric



DMXU

#34" - 25/32" / L/D = 2, 3

J057 - J059

Inch Metric



FDCU / FDC



ø0.203" - ø0.625" (ø5 mm - ø16 mm) / L/D = 5, 8

J060 - J061

Inch Metric



Changeable head system for easy operation

High accuracy, rigidity, and productivity

- Unique clamping structure provides high repeatability and reliability
- One-action head changing reduces tool set up time
- No re-grinding cost and reduced tool inventory requirements

Drill head

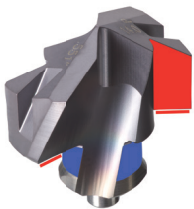

Drill body



- Contact area that supports the drill head against cutting force
- Contact area that maintains the accurate drill position

Groove to prevent the head from falling off

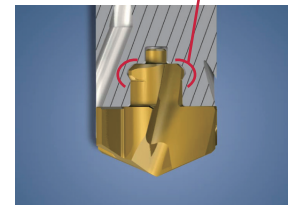

Increased body durability

- The new clamping mechanism greatly reduces the damage on cutting edges due to less holding power as seen with the competitors, which leads to long tool life.
- The unique clamping design prevents the head from falling off.



Reference pages: **J010 - J031**, Technical reference → **L073 - L074**

A
B
C
D
E
F
G
H
I
J
K
L
M

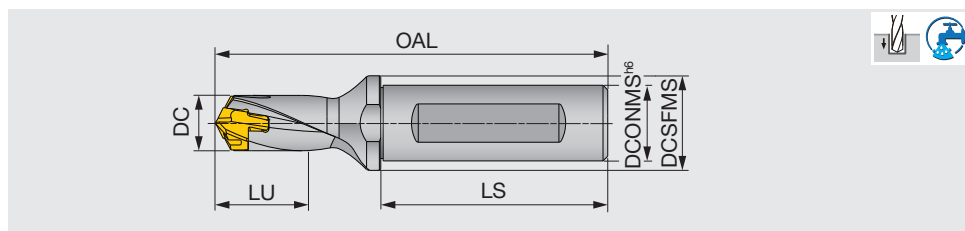

Inch	DC	DCONMS	DCSFMS	LU	LS	OAL		Pocket size	Head
						DMP	DMC		
TIDU0394F0625-1.5	0.394 - 0.429	0.625	0.787	0.591	1.890	3.118	3.142	10	DM*100 - DM*109
TIDU0433F0625-1.5	0.433 - 0.468	0.625	0.787	0.669	1.890	3.193	3.217	11	DM*110 - DM*119
TIDU0472F0625-1.5	0.472 - 0.508	0.625	0.787	0.709	1.890	3.268	3.292	12	DM*120 - DM*129
TIDU0512F0625-1.5	0.512 - 0.547	0.625	0.787	0.787	1.890	3.350	3.381	13	DM*130 - DM*139
TIDU0551F0625-1.5	0.551 - 0.587	0.625	0.787	0.827	1.890	3.508	3.539	14	DM*140 - DM*149
TIDU0591F0750-1.5	0.591 - 0.625	0.750	0.984	0.906	1.969	3.787	3.822	15	DM*150 - DM*159
TIDU0630F0750-1.5	0.630 - 0.665	0.750	0.984	0.945	1.969	3.909	3.948	16	DM*160 - DM*169
TIDU0669F0750-1.5	0.669 - 0.705	0.750	0.984	1.024	1.969	4.031	4.07	17	DM*170 - DM*179
TIDU0709F1000-1.5	0.709 - 0.744	1.000	1.260	1.063	2.205	4.390	4.433	18	DM*180 - DM*189
TIDU0748F1000-1.5	0.748 - 0.783	1.000	1.260	1.142	2.205	4.508	4.551	19	DM*190 - DM*199
TIDU0787F1000-1.5	0.787 - 0.823	1.000	1.260	1.181	2.205	4.630	-	20	DMP200 - DMP209
TIDU0827F1000-1.5	0.827 - 0.862	1.000	1.260	1.240	2.205	4.752	-	21	DMP210 - DMP219
TIDU0866F1000-1.5	0.866 - 0.902	1.000	1.260	1.299	2.205	4.874	-	22	DMP220 - DMP229
TIDU0906F1250-1.5	0.906 - 0.941	1.250	1.654	1.358	2.362	5.150	-	23	DMP230 - DMP239
TIDU0945F1250-1.5	0.945 - 0.980	1.250	1.654	1.417	2.362	5.272	-	24	DMP240 - DMP249
TIDU0984F1250-1.5	0.984 - 1.020	1.250	1.654	1.476	2.362	5.394	-	25	DMP250 - DMP259

Tool diameter	Hole diameter tolerance*
ø0.394 - ø1.020	+0.0020 / 0

An overall length (OAL) differs for when the DMP insert is mounted and when the DMC is mounted. (No difference for the drill shoulder)

*Just for reference

SPARE PARTS



Designation	Clamping key
TIDU0394 - TIDU0748	K-TID10-19.99
TIDU0787 - TIDU0984	K-TID20-26.99

Reference pages: Head → **J024 - J029**
 Standard cutting conditions → **J030**

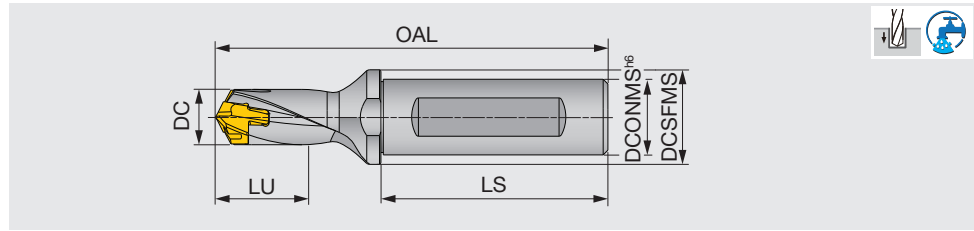

Metric	DC	DCONMS	DCSFMS	LU	LS	OAL		Pocket size	Head
						DMP	DMC		
TID060F12-1.5	6 - 6.4	12	16	10.1	45	68	-	6	DMP060 - DMP064
TID065F12-1.5	6.5 - 6.9	12	16	11.2	45	69.1	-	6	DMP065 - DMP069
TID070F12-1.5	7 - 7.4	12	16	12.3	45	70.1	-	7	DMP070 - DMP074
TID075F12-1.5	7.5 - 7.9	12	16	12.7	45	70.9	-	7	DMP075 - DMP079
TID080F12-1.5	8 - 8.9	12	16	13.5	45	72.4	-	8	DMP080 - DMP089
TID090F12-1.5	9 - 9.9	12	16	15.6	45	74.3	-	9	DMP090 - DMP099
TID100F16-1.5	10 - 10.9	16	20	16.8	48	79.2	79.8	10	DM*100 - DM*109
TID110F16-1.5	11 - 11.9	16	20	19	48	81.1	81.7	11	DM*110 - DM*119
TID120F16-1.5	12 - 12.9	16	20	20.2	48	83	83.6	12	DM*120 - DM*129
TID130F16-1.5	13 - 13.9	16	20	22.4	48	85.1	85.9	13	DM*130 - DM*139
TID140F16-1.5	14 - 14.9	16	20	23.5	48	89.1	89.9	14	DM*140 - DM*149
TID150F20-1.5	15 - 15.9	20	25	25.7	50	96.2	97.1	15	DM*150 - DM*159
TID160F20-1.5	16 - 16.9	20	25	26.9	50	99.3	100.3	16	DM*160 - DM*169
TID170F20-1.5	17 - 17.9	20	25	29.1	50	102.4	103.4	17	DM*170 - DM*179
TID180F25-1.5	18 - 18.9	25	32	30.3	56	111.5	112.6	18	DM*180 - DM*189
TID190F25-1.5	19 - 19.9	25	32	32.5	56	114.5	115.6	19	DM*190 - DM*199
TID200F25-1.5	20 - 20.9	25	32	33.6	56	117.6	-	20	DMP200 - DMP209
TID210F25-1.5	21 - 21.9	25	32	35.8	56	120.7	-	21	DMP210 - DMP219
TID220F25-1.5	22 - 22.9	25	32	37	56	123.8	-	22	DMP220 - DMP229
TID230F32-1.5	23 - 23.9	32	42	39.2	60	130.8	-	23	DMP230 - DMP239
TID240F32-1.5	24 - 24.9	32	42	40.4	60	133.9	-	24	DMP240 - DMP249
TID250F32-1.5	25 - 25.9	32	42	42.5	60	137	-	25	DMP250 - DMP259

Tool diameter	Hole diameter tolerance*
ø6 - ø25.9	+0.05 / 0

An overall length (OAL) differs for when the DMP insert is mounted and when the DMC is mounted. (No difference for the drill shoulder)

*Just for reference

SPARE PARTS



Designation	Clamping key
TID060-090	K-TID6-9.99
TID100-190	K-TID10-19.99
TID200-250	K-TID20-26.99



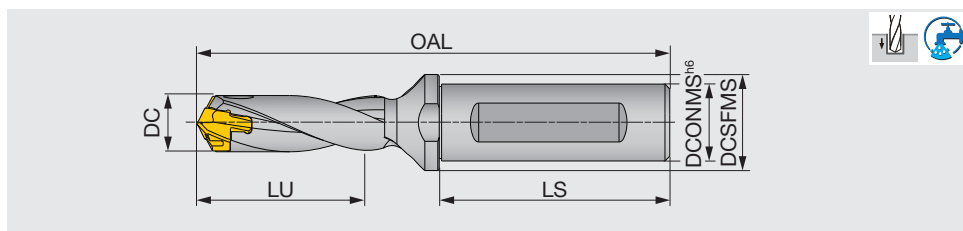

Inch	DC	DCONMS	DCSFMS	LU	LS	OAL		Pocket size	Head
						DMP	DMC		
TIDU0394F0625-3	0.394 - 0.409	0.625	0.787	1.181	1.890	3.709	3.733	10	DM*100 - DM*104
TIDU0413F0625-3	0.413 - 0.429	0.625	0.787	1.260	1.890	3.768	3.792	10	DM*105 - DM*109
TIDU0433F0625-3	0.433 - 0.449	0.625	0.787	1.299	1.890	3.843	3.867	11	DM*110 - DM*114
TIDU0453F0625-3	0.453 - 0.469	0.625	0.787	1.378	1.890	3.902	3.926	11	DM*115 - DM*119
TIDU0472F0625-3	0.472 - 0.488	0.625	0.787	1.417	1.890	3.976	4.000	12	DM*120 - DM*124
TIDU0492F0625-3	0.492 - 0.508	0.625	0.787	1.457	1.890	4.035	4.059	12	DM*125 - DM*129
TIDU0512F0625-3	0.512 - 0.528	0.625	0.787	1.535	1.890	4.118	4.149	13	DM*130 - DM*134
TIDU0532F0625-3	0.532 - 0.547	0.625	0.787	1.614	1.890	4.177	4.208	13	DM*135 - DM*139
TIDU0551F0625-3	0.551 - 0.567	0.625	0.787	1.654	1.890	4.335	4.366	14	DM*140 - DM*144
TIDU0571F0625-3	0.571 - 0.587	0.625	0.787	1.732	1.890	4.394	4.425	14	DM*145 - DM*149
TIDU0591F0750-3	0.591 - 0.626	0.750	0.984	1.772	1.969	4.673	4.708	15	DM*150 - DM*159
TIDU0630F0750-3	0.630 - 0.665	0.750	0.984	1.890	1.969	4.854	4.893	16	DM*160 - DM*169
TIDU0669F0750-3	0.669 - 0.705	0.750	0.984	2.008	1.969	5.035	5.074	17	DM*170 - DM*179
TIDU0709F1000-3	0.709 - 0.744	1.000	1.260	2.126	2.205	5.453	5.496	18	DM*180 - DM*189
TIDU0748F1000-3	0.748 - 0.783	1.000	1.260	2.244	2.205	5.630	5.673	19	DM*190 - DM*199
TIDU0787F1000-3	0.787 - 0.823	1.000	1.260	2.362	2.205	5.811	-	20	DMP200 - DMP209
TIDU0827F1000-3	0.827 - 0.862	1.000	1.260	2.480	2.205	5.992	-	21	DMP210 - DMP219
TIDU0866F1000-3	0.866 - 0.902	1.000	1.260	2.598	2.205	6.173	-	22	DMP220 - DMP229
TIDU0906F1250-3	0.906 - 0.941	1.250	1.654	2.718	2.362	6.508	-	23	DMP230 - DMP239
TIDU0945F1250-3	0.945 - 0.980	1.250	1.654	2.835	2.362	6.689	-	24	DMP240 - DMP249
TIDU0984F1250-3	0.984 - 1.020	1.250	1.654	2.953	2.362	6.870	-	25	DMP250 - DMP259

Tool diameter	Hole diameter tolerance*
ø0.394 - ø1.020	+0.0020 / 0

An overall length (OAL) differs for when the DMP insert is mounted and when the DMC is mounted. (No difference for the drill shoulder)

*Just for reference



SPARE PARTS

Designation	Clamping key
TIDU0394 - TIDU0748	K-TID10-19.99
TIDU0787 - TIDU0984	K-TID20-26.99

Reference pages: Head → **J024 - J029**
Standard cutting conditions → **J030**

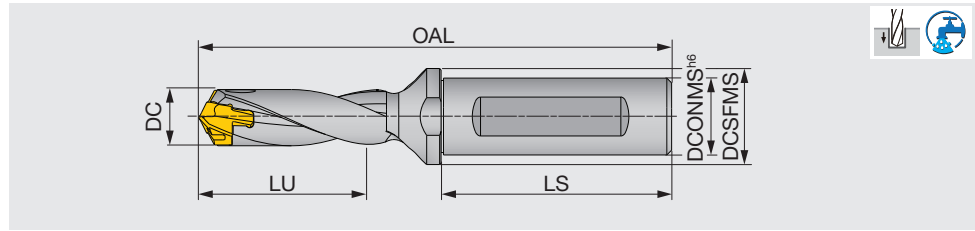

Metric	DC	DCONMS	DCSFMS	LU	LS	OAL		Pocket size	Head
						DMP	DMC		
TID060F12-3	6 - 6.4	12	16	19.1	45	77	-	6	DMP060 - DMP064
TID065F12-3	6.5 - 6.9	12	16	21.2	45	78.8	-	6	DMP065 - DMP069
TID070F12-3	7 - 7.4	12	16	22.3	45	80.6	-	7	DMP070 - DMP074
TID075F12-3	7.5 - 7.9	12	16	24.4	45	82.1	-	7	DMP075 - DMP079
TID080F12-3	8 - 8.4	12	16	25.5	45	84.4	-	8	DMP080 - DMP084
TID085F12-3	8.5 - 8.9	12	16	27.5	45	85.9	-	8	DMP085 - DMP089
TID090F12-3	9 - 9.4	12	16	28.6	45	87.8	-	9	DMP090 - DMP094
TID095F12-3	9.5 - 9.9	12	16	30.7	45	89.3	-	9	DMP095 - DMP099
TID100F16-3	10 - 10.4	16	20	31.8	48	94.2	94.8	10	DM*100 - DM*104
TID105F16-3	10.5 - 10.9	16	20	33.9	48	95.7	96.3	10	DM*105 - DM*109
TID110F16-3	11 - 11.4	16	20	35	48	97.6	98.2	11	DM*110 - DM*114
TID115F16-3	11.5 - 11.9	16	20	37.1	48	99.1	99.7	11	DM*115 - DM*119
TID120F16-3	12 - 12.4	16	20	38.2	48	101	101.6	12	DM*120 - DM*124
TID125F16-3	12.5 - 12.9	16	20	39.3	48	102.5	103.1	12	DM*125 - DM*129
TID130F16-3	13 - 13.4	16	20	41.4	48	104.6	105.4	13	DM*130 - DM*134
TID135F16-3	13.5 - 13.9	16	20	43.5	48	106.1	106.9	13	DM*135 - DM*139
TID140F16-3	14 - 14.4	16	20	44.5	48	110.1	110.9	14	DM*140 - DM*144
TID145F16-3	14.5 - 14.9	16	20	46.6	48	111.6	112.4	14	DM*145 - DM*149
TID150F20-3	15 - 15.9	20	25	47.7	50	118.7	119.6	15	DM*150 - DM*159
TID160F20-3	16 - 16.9	20	25	50.9	50	123.3	124.3	16	DM*160 - DM*169
TID170F20-3	17 - 17.9	20	25	54.1	50	127.9	128.9	17	DM*170 - DM*179
TID180F25-3	18 - 18.9	25	32	57.3	56	138.5	139.6	18	DM*180 - DM*189
TID190F25-3	19 - 19.9	25	32	60.5	56	143	144.1	19	DM*190 - DM*199
TID200F25-3	20 - 20.9	25	32	63.6	56	147.6	-	20	DMP200 - DMP209
TID210F25-3	21 - 21.9	25	32	66.8	56	152.2	-	21	DMP210 - DMP219
TID220F25-3	22 - 22.9	25	32	70	56	156.8	-	22	DMP220 - DMP229
TID230F32-3	23 - 23.9	32	42	73.2	60	165.3	-	23	DMP230 - DMP239
TID240F32-3	24 - 24.9	32	42	76.4	60	169.9	-	24	DMP240 - DMP249
TID250F32-3	25 - 25.9	32	42	79.5	60	174.5	-	25	DMP250 - DMP259

Tool diameter	Hole diameter tolerance*
ø6 - ø25.9	+0.05 / 0

*Just for reference

An overall length (OAL) differs for when the DMP insert is mounted and when the DMC is mounted. (No difference for the drill shoulder)

SPARE PARTS



Designation	Clamping key
TID060-095	K-TID6-9.99
TID100-190	K-TID10-19.99
TID200-250	K-TID20-26.99

Reference pages: Head → **J024 - J029**
Standard cutting conditions → **J030**



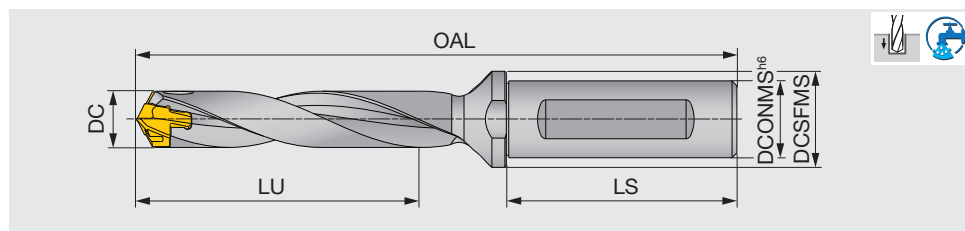

Inch	DC	DCONMS	DCSFMS	LU	LS	OAL		Pocket size	Head
						DMP	DMC		
TIDU0394F0625-5	0.394 - 0.409	0.625	0.787	1.969	1.890	4.575	4.599	10	DM*100 - DM*104
TIDU0413F0625-5	0.413 - 0.429	0.625	0.787	2.087	1.890	4.791	4.815	10	DM*105 - DM*109
TIDU0433F0625-5	0.433 - 0.449	0.625	0.787	2.165	1.890	4.984	5.008	11	DM*110 - DM*114
TIDU0453F0625-5	0.453 - 0.469	0.625	0.787	2.283	1.890	5.201	5.225	11	DM*115 - DM*119
TIDU0472F0625-5	0.472 - 0.488	0.625	0.787	2.362	1.890	5.394	5.418	12	DM*120 - DM*124
TIDU0492F0625-5	0.492 - 0.508	0.625	0.787	2.441	1.890	5.571	5.595	12	DM*125 - DM*129
TIDU0512F0625-5	0.512 - 0.528	0.625	0.787	2.559	1.890	5.811	5.842	13	DM*130 - DM*134
TIDU0532F0625-5	0.532 - 0.547	0.625	0.787	2.677	1.890	6.028	6.059	13	DM*135 - DM*139
TIDU0551F0625-5	0.551 - 0.567	0.625	0.787	2.756	1.890	6.307	6.338	14	DM*140 - DM*144
TIDU0571F0625-5	0.571 - 0.587	0.625	0.787	2.874	1.890	6.524	6.555	14	DM*145 - DM*149
TIDU0591F0750-5	0.591 - 0.626	0.750	0.984	2.953	1.969	6.839	6.874	15	DM*150 - DM*159
TIDU0630F0750-5	0.630 - 0.665	0.750	0.984	3.150	1.969	7.295	7.334	16	DM*160 - DM*169
TIDU0669F0750-5	0.669 - 0.705	0.750	0.984	3.346	1.969	7.752	7.791	17	DM*170 - DM*179
TIDU0709F1000-5	0.709 - 0.744	1.000	1.260	3.543	2.205	8.209	8.252	18	DM*180 - DM*189
TIDU0748F1000-5	0.748 - 0.783	1.000	1.260	3.740	2.205	8.661	8.704	19	DM*190 - DM*199
TIDU0787F1000-5	0.787 - 0.823	1.000	1.260	3.937	2.205	2.723	-	20	DMP200 - DMP209
TIDU0827F1000-5	0.827 - 0.862	1.000	1.260	4.134	2.205	7.646	-	21	DMP210 - DMP219
TIDU0866F1000-5	0.866 - 0.902	1.000	1.260	4.331	2.205	7.906	-	22	DMP220 - DMP229
TIDU0906F1250-5	0.906 - 0.941	1.250	1.654	4.528	2.362	8.319	-	23	DMP230 - DMP239
TIDU0945F1250-5	0.945 - 0.980	1.250	1.654	4.724	2.362	8.579	-	24	DMP240 - DMP249
TIDU0984F1250-5	0.984 - 1.020	1.250	1.654	4.921	2.362	8.839	-	25	DMP250 - DMP259

Tool diameter	Hole diameter tolerance*
ø0.394 - ø0.783	+0.0024 / 0
ø0.787 - ø1.020	+0.0026 / 0

An overall length (OAL) differs for when the DMP insert is mounted and when the DMC is mounted. (No difference for the drill shoulder)

*Just for reference

SPARE PARTS



Designation	Clamping key
TIDU0394 - TIDU0748	K-TID10-19.99
TIDU0787 - TIDU0984	K-TID20-26.99

Reference pages: Head → **J024 - J029**
Standard cutting conditions → **J030**

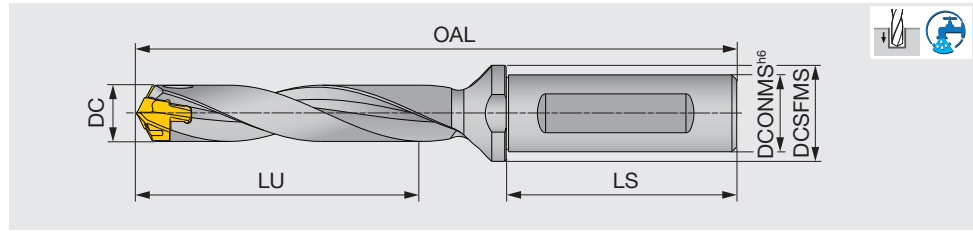

Metric	DC	DCONMS	DCSFMS	LU	LS	OAL		Pocket size	Head
						DMP	DMC		
TID060F12-5	6 - 6.4	12	16	31.1	45	89	-	6	DMP060 - DMP064
TID065F12-5	6.5 - 6.9	12	16	34.2	45	91.8	-	6	DMP065 - DMP069
TID070F12-5	7 - 7.4	12	16	36.3	45	94.6	-	7	DMP070 - DMP074
TID075F12-5	7.5 - 7.9	12	16	39.4	45	97.1	-	7	DMP075 - DMP079
TID080F12-5	8 - 8.4	12	16	41.5	45	100.4	-	8	DMP080 - DMP084
TID085F12-5	8.5 - 8.9	12	16	44.5	45	102.9	-	8	DMP085 - DMP089
TID090F12-5	9 - 9.4	12	16	46.6	45	105.8	-	9	DMP090 - DMP094
TID095F12-5	9.5 - 9.9	12	16	49.7	45	108.3	-	9	DMP095 - DMP099
TID100F16-5	10 - 10.4	16	20	51.8	48	114.2	114.8	10	DM*100 - DM*104
TID105F16-5	10.5 - 10.9	16	20	54.9	48	116.7	117.3	10	DM*105 - DM*109
TID110F16-5	11 - 11.4	16	20	57	48	119.6	120.2	11	DM*110 - DM*114
TID115F16-5	11.5 - 11.9	16	20	60.1	48	122.1	122.7	11	DM*115 - DM*119
TID120F16-5	12 - 12.4	16	20	62.2	48	125	125.6	12	DM*120 - DM*124
TID125F16-5	12.5 - 12.9	16	20	64.3	48	127.5	128.1	12	DM*125 - DM*129
TID130F16-5	13 - 13.4	16	20	67.4	48	130.6	131.4	13	DM*130 - DM*134
TID135F16-5	13.5 - 13.9	16	20	70.5	48	133.1	133.9	13	DM*135 - DM*139
TID140F16-5	14 - 14.4	16	20	72.5	48	138.2	139	14	DM*140 - DM*144
TID145F16-5	14.5 - 14.9	16	20	75.6	48	140.7	141.5	14	DM*145 - DM*149
TID150F20-5	15 - 15.9	20	25	77.7	50	148.7	149.6	15	DM*150 - DM*159
TID160F20-5	16 - 16.9	20	25	82.9	50	155.3	156.3	16	DM*160 - DM*169
TID170F20-5	17 - 17.9	20	25	88.1	50	161.9	162.9	17	DM*170 - DM*179
TID180F25-5	18 - 18.9	25	32	93.3	56	174.5	175.6	18	DM*180 - DM*189
TID190F25-5	19 - 19.9	25	32	98.5	56	181	182.1	19	DM*190 - DM*199
TID200F25-5	20 - 20.9	25	32	103.6	56	187.6	-	20	DMP200 - DMP209
TID210F25-5	21 - 21.9	25	32	108.8	56	194.2	-	21	DMP210 - DMP219
TID220F25-5	22 - 22.9	25	32	114	56	200.8	-	22	DMP220 - DMP229
TID230F32-5	23 - 23.9	32	42	119.2	60	211.3	-	23	DMP230 - DMP239
TID240F32-5	24 - 24.9	32	42	124.4	60	217.9	-	24	DMP240 - DMP249
TID250F32-5	25 - 25.9	32	42	129.5	60	224.5	-	25	DMP250 - DMP259

Tool diameter	Hole diameter tolerance*
ø6 - ø17.9	+0.06 / 0
ø18 - ø25.9	+0.065 / 0

An overall length (OAL) differs for when the DMP insert is mounted and when the DMC is mounted. (No difference for the drill shoulder)

*Just for reference



SPARE PARTS

Designation	Clamping key
TID060-095	K-TID6-9.99
TID100-190	K-TID10-19.99
TID200-250	K-TID20-26.99

Reference pages: Head → **J024 - J029**
Standard cutting conditions → **J030**



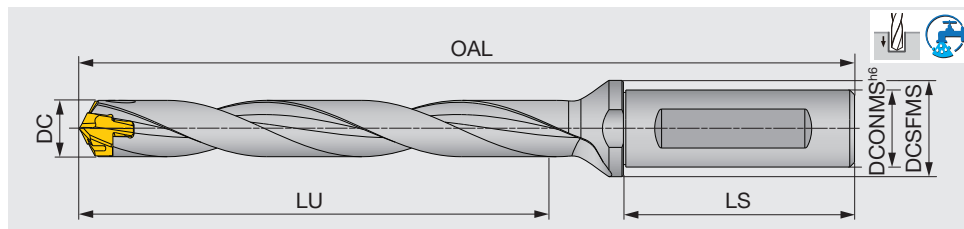

Inch	DC	DCONMS	DCSFMS	LU	LS	OAL		Pocket size	Head
						DMP	DMC		
TIDU0394F0625-8	0.394 - 0.409	0.625	0.787	3.150	1.890	5.677	5.701	10	DM*100 - DM*104
TIDU0413F0625-8	0.413 - 0.429	0.625	0.787	3.307	1.890	5.835	5.859	10	DM*105 - DM*109
TIDU0433F0625-8	0.433 - 0.449	0.625	0.787	3.465	1.890	6.008	6.032	11	DM*110 - DM*114
TIDU0453F0625-8	0.453 - 0.469	0.625	0.787	3.622	1.890	6.165	6.189	11	DM*115 - DM*119
TIDU0472F0625-8	0.472 - 0.488	0.625	0.787	3.780	1.890	6.339	6.363	12	DM*120 - DM*124
TIDU0492F0625-8	0.492 - 0.508	0.625	0.787	3.937	1.890	6.496	6.52	12	DM*125 - DM*129
TIDU0512F0625-8	0.512 - 0.528	0.625	0.787	4.094	1.890	6.677	6.708	13	DM*130 - DM*134
TIDU0532F0625-8	0.532 - 0.547	0.625	0.787	4.252	1.890	6.835	6.866	13	DM*135 - DM*139
TIDU0551F0625-8	0.551 - 0.567	0.625	0.787	4.409	1.890	7.091	7.122	14	DM*140 - DM*144
TIDU0571F0625-8	0.571 - 0.587	0.625	0.787	4.567	1.890	7.252	7.283	14	DM*145 - DM*149
TIDU0591F0750-8	0.591 - 0.626	0.750	0.984	4.724	1.969	7.626	7.661	15	DM*150 - DM*159
TIDU0630F0750-8	0.630 - 0.665	0.750	0.984	5.039	1.969	8.004	8.043	16	DM*160 - DM*169
TIDU0669F0750-8	0.669 - 0.705	0.750	0.984	5.354	1.969	8.382	8.421	17	DM*170 - DM*179
TIDU0709F1000-8	0.709 - 0.744	1.000	1.260	5.669	2.205	8.996	9.039	18	DM*180 - DM*189
TIDU0748F1000-8	0.748 - 0.783	1.000	1.260	5.984	2.205	9.370	9.413	19	DM*190 - DM*199
TIDU0787F1000-8	0.787 - 0.823	1.000	1.260	6.299	2.205	9.748	-	20	DMP200 - DMP209
TIDU0827F1000-8	0.827 - 0.862	1.000	1.260	6.614	2.205	10.126	-	21	DMP210 - DMP219
TIDU0866F1000-8	0.866 - 0.902	1.000	1.260	6.929	2.205	10.504	-	22	DMP220 - DMP229
TIDU0906F1250-8	0.906 - 0.941	1.250	1.654	7.244	2.362	11.035	-	23	DMP230 - DMP239
TIDU0945F1250-8	0.945 - 0.980	1.250	1.654	7.559	2.362	11.413	-	24	DMP240 - DMP249
TIDU0984F1250-8	0.984 - 1.020	1.250	1.654	7.874	2.362	11.791	-	25	DMP250 - DMP259

Tool diameter	Hole diameter tolerance*
ø0.394 - ø0.783	+0.0030 / 0
ø0.787 - ø1.020	+0.0033 / 0

An overall length (OAL) differs for when the DMP insert is mounted and when the DMC is mounted. (No difference for the drill shoulder)

*Just for reference

SPARE PARTS



Designation	Clamping key
TIDU0394 - TIDU0748	K-TID10-19.99
TIDU0787 - TIDU0984	K-TID20-26.99

Reference pages: Head → **J024 - J029**
Standard cutting conditions → **J030**

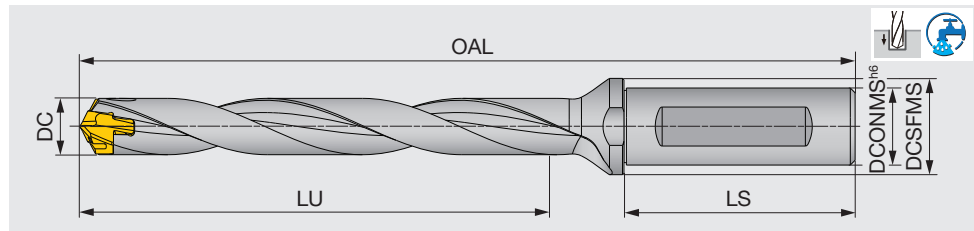

Metric	DC	DCONMS	DCSFMS	LU	LS	OAL		Pocket size	Head
						DMP	DMC		
TID070F12-8	7 - 7.4	12	16	57.3	45	115.6	-	7	DMP070 - DMP074
TID075F12-8	7.5 - 7.9	12	16	61.4	45	119.6	-	7	DMP075 - DMP079
TID080F12-8	8 - 8.4	12	16	65.5	45	124.4	-	8	DMP080 - DMP084
TID085F12-8	8.5 - 8.9	12	16	69.5	45	128.4	-	8	DMP085 - DMP089
TID090F12-8	9 - 9.4	12	16	73.6	45	132.8	-	9	DMP090 - DMP094
TID095F12-8	9.5 - 9.9	12	16	77.7	45	136.8	-	9	DMP095 - DMP099
TID100F16-8	10 - 10.4	16	20	81.8	48	144.2	144.8	10	DM*100 - DM*104
TID105F16-8	10.5 - 10.9	16	20	85.9	48	148.2	148.8	10	DM*105 - DM*109
TID110F16-8	11 - 11.4	16	20	90	48	152.6	153.2	11	DM*110 - DM*114
TID115F16-8	11.5 - 11.9	16	20	94.1	48	156.6	157.2	11	DM*115 - DM*119
TID120F16-8	12 - 12.4	16	20	98.2	48	161	161.6	12	DM*120 - DM*124
TID125F16-8	12.5 - 12.9	16	20	102.3	48	165	165.6	12	DM*125 - DM*129
TID130F16-8	13 - 13.4	16	20	106.4	48	169.6	170.4	13	DM*130 - DM*134
TID135F16-8	13.5 - 13.9	16	20	110.5	48	173.6	174.4	13	DM*135 - DM*139
TID140F16-8	14 - 14.4	16	20	114.5	48	180.1	180.9	14	DM*140 - DM*144
TID145F16-8	14.5 - 14.9	16	20	118.6	48	184.2	185	14	DM*145 - DM*149
TID150F20-8	15 - 15.9	20	25	122.7	50	193.7	194.6	15	DM*150 - DM*159
TID160F20-8	16 - 16.9	20	25	130.9	50	203.3	204.3	16	DM*160 - DM*169
TID170F20-8	17 - 17.9	20	25	139.1	50	212.9	213.9	17	DM*170 - DM*179
TID180F25-8	18 - 18.9	25	32	147.3	56	228.5	229.6	18	DM*180 - DM*189
TID190F25-8	19 - 19.9	25	32	155.5	56	238	239.1	19	DM*190 - DM*199
TID200F25-8	20 - 20.9	25	32	163.6	56	247.6	-	20	DMP200 - DMP209
TID210F25-8	21 - 21.9	25	32	171.8	56	257.2	-	21	DMP210 - DMP219
TID220F25-8	22 - 22.9	25	32	180	56	266.8	-	22	DMP220 - DMP229
TID230F32-8	23 - 23.9	32	42	188.2	60	280.3	-	23	DMP230 - DMP239
TID240F32-8	24 - 24.9	32	42	196.4	60	289.9	-	24	DMP240 - DMP249
TID250F32-8	25 - 25.9	32	42	204.5	60	299.5	-	25	DMP250 - DMP259

Tool diameter	Hole diameter tolerance*
ø7 - ø17.9	+0.07 / 0
ø18 - ø25.9	+0.085 / 0

An overall length (OAL) differs for when the DMP insert is mounted and when the DMC is mounted. (No difference for the drill shoulder)

*Just for reference



SPARE PARTS

Designation	Clamping key
TID060-095	K-TID6-9.99
TID100-190	K-TID10-19.99
TID200-250	K-TID20-26.99

Reference pages: Head → **J024 - J029**
Standard cutting conditions → **J030**



DRILLMEISTER

TIDU L/D=12

Head changeable drill

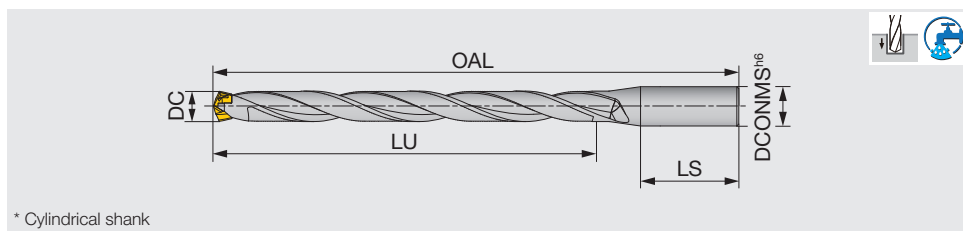

Inch	DC	DCONMS	LU	LS	OAL		Pocket size	Head
					DMP	DMC		
TIDU0472R0625-12	0.472 - 0.488	0.625	5.669	1.890	8.228	8.252	12	DM*120 - DM*124
TIDU0492R0625-12	0.492 - 0.508	0.625	5.906	1.890	8.465	8.489	12	DM*125 - DM*129
TIDU0512R0625-12	0.512 - 0.528	0.625	6.142	1.890	8.701	8.732	13	DM*130 - DM*134
TIDU0532R0625-12	0.531 - 0.547	0.625	6.378	1.890	8.937	8.968	13	DM*135 - DM*139
TIDU0551R0625-12	0.551 - 0.567	0.625	6.614	1.890	9.291	9.322	14	DM*140 - DM*144
TIDU0571R0625-12	0.571 - 0.587	0.625	6.850	1.890	9.528	9.559	14	DM*145 - DM*149
TIDU0591R0750-12	0.591 - 0.626	0.750	7.087	1.969	10.000	10.035	15	DM*150 - DM*159
TIDU0630R0750-12	0.630 - 0.665	0.750	7.559	1.969	10.512	10.551	16	DM*160 - DM*169
TIDU0669R0750-12	0.669 - 0.705	0.750	8.031	1.969	11.063	11.102	17	DM*170 - DM*179
TIDU0709R1000-12	0.709 - 0.744	1.000	8.504	2.205	11.811	11.854	18	DM*180 - DM*189
TIDU0748R1000-12	0.748 - 0.783	1.000	8.976	2.205	12.362	12.405	19	DM*190 - DM*199
TIDU0787R1000-12	0.787 - 0.823	1.000	9.449	2.205	12.874	-	20	DMP200 - DM*209
TIDU0827R1000-12	0.827 - 0.862	1.000	9.921	2.205	13.425	-	21	DMP210 - DM*219
TIDU0866R1000-12	0.866 - 0.902	1.000	10.394	2.205	13.976	-	22	DMP220 - DM*229

Tool diameter	Hole diameter tolerance*
ø0.472 - ø0.705	+0.0031 / 0
ø0.709 - ø0.902	+0.0037 / 0

An overall length (OAL) differs for when the DMP insert is mounted and when the DMC is mounted. (No difference for the drill shoulder)

*Just for reference

SPARE PARTS



Designation	Clamping key
TIDU472-0748, TID120-190	K-TID10-19.99
TIDU0787-0866, TID200-220	K-TID20-26.99

Reference pages: Head → **J024 - J029**
 Standard cutting conditions → **J030**

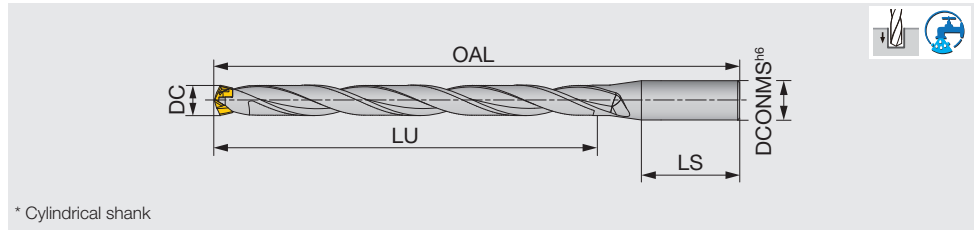

Metric	DC	DCONMS	LU	LS	OAL		Pocket size	Head
					DMP	DMC		
TID080R12-12	8 - 8.4	12	97.5	45	156.4	-	8	DM*080-DM*084
TID085R12-12	8.5 - 8.9	12	103.5	45	162.4	-	8	DM*085-DM*089
TID090R12-12	9 - 9.4	12	109.6	45	168.8	-	9	DM*090-DM*094
TID095R12-12	9.5 - 9.9	12	115.7	45	174.8	-	9	DM*095-DM*099
TID100R16-12	10 - 10.4	16	121.8	48	184.2	184.8	10	DM*100-DM*104
TID105R16-12	10.5 - 10.9	16	127.9	48	190.2	190.8	10	DM*105-DM*109
TID110R16-12	11 - 11.4	16	134.0	48	196.6	197.2	11	DM*110-DM*114
TID115R16-12	11.5 - 11.9	16	140.1	48	202.6	203.2	11	DM*115-DM*119
TID120R16-12	12 - 12.4	16	146.2	48	209	209.6	12	DM*120 - DM*124
TID125R16-12	12.5 - 12.9	16	152.3	48	215	215.6	12	DM*125 - DM*129
TID130R16-12	13 - 13.4	16	158.4	48	221.6	222.4	13	DM*130 - DM*134
TID135R16-12	13.5 - 13.9	16	164.5	48	227.6	228.4	13	DM*135 - DM*139
TID140R16-12	14 - 14.4	16	170.5	48	236.2	237	14	DM*140 - DM*144
TID145R16-12	14.5 - 14.9	16	176.6	48	242.2	243	14	DM*145 - DM*149
TID150R20-12	15 - 15.9	20	182.7	50	253.7	254.6	15	DM*150 - DM*159
TID160R20-12	16 - 16.9	20	194.9	50	267.3	268.3	16	DM*160 - DM*169
TID170R20-12	17 - 17.9	20	207.1	50	280.9	281.9	17	DM*170 - DM*179
TID180R25-12	18 - 18.9	25	219.3	56	300.5	301.6	18	DM*180 - DM*189
TID190R25-12	19 - 19.9	25	231.5	56	314	315.1	19	DM*190 - DM*199
TID200R25-12	20 - 20.9	25	243.6	56	327.6	-	20	DM*200 - DM*209
TID210R25-12	21 - 21.9	25	255.8	56	341.2	-	21	DM*210 - DM*219
TID220R25-12	22 - 22.9	25	268	56	354.8	-	22	DM*220 - DM*229

Tool diameter	Hole diameter tolerance*
ø8 - ø17.9	+0.08 / 0
ø18 - ø22.9	+0.095 / 0

An overall length (OAL) differs for when the DMP insert is mounted and when the DMC is mounted. (No difference for the drill shoulder)

*Just for reference

SPARE PARTS



Designation	Clamping key
TID100-190	K-TID10-19.99
TID200-220	K-TID20-26.99

Reference pages: Head → **J024 - J029**
Standard cutting conditions → **J030**



DRILLMEISTER

TIDC L/D=3

Head changeable drill

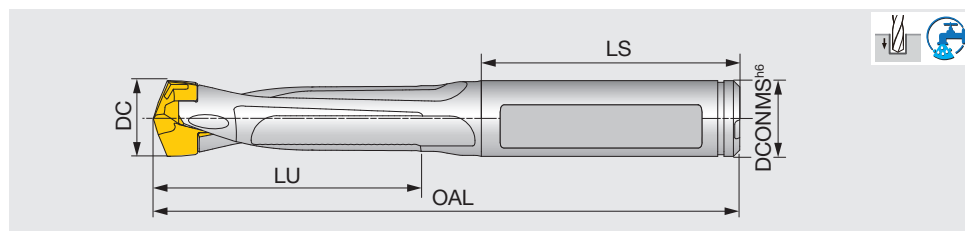

Metric	DC	DCONMS	LU	LS	OAL		Pocket size	Head
					DMP	DMC		
TIDC100C10-3	10 - 10.4	10	31.8	41	86.1	86.7	10	DM*100 - DM*104
TIDC105C11-3	10.5 - 10.9	11	33.4	41	87.6	88.2	10	DM*105 - DM*109
TIDC110C11-3	11 - 11.4	11	35	41	89.5	90.1	11	DM*110 - DM*114
TIDC115C12-3	11.5 - 11.9	12	36.6	41	91	91.6	11	DM*115 - DM*119
TIDC120C12-3	12 - 12.4	12	38.2	41	92.8	93.4	12	DM*120 - DM*124
TIDC125C13-3	12.5 - 12.9	13	39.8	46	98.3	98.9	12	DM*125 - DM*129
TIDC130C13-3	13 - 13.4	13	41.4	47	102.4	103.2	13	DM*130 - DM*134
TIDC135C14-3	13.5 - 13.9	14	43	43	99.9	100.7	13	DM*135 - DM*139
TIDC140C14-3	14 - 14.4	14	44.5	44	103	103.8	14	DM*140 - DM*144
TIDC145C15-3	14.5 - 14.9	15	46.1	45	105.5	106.3	14	DM*145 - DM*149
TIDC150C15-3	15 - 15.9	15	47.7	45	107.5	108.4	15	DM*150 - DM*159
TIDC160C16-3	16 - 16.9	16	50.9	48	117.5	118.5	16	DM*160 - DM*169
TIDC170C17-3	17 - 17.9	17	54.1	48	119.7	120.7	17	DM*170 - DM*179
TIDC180C18-3	18 - 18.9	18	57.3	48	123.3	124.4	18	DM*180 - DM*189
TIDC190C19-3	19 - 19.9	19	60.5	54	132.4	133.5	19	DM*190 - DM*199

Tool diameter	Hole diameter tolerance*
ø10 - ø19.9	+0.05 / 0

An overall length (OAL) differs for when the DMP insert is mounted and when the DMC is mounted. (No difference for the drill shoulder)

*Just for reference

SPARE PARTS



Designation	Clamping key
TIDC100-190	K-TID10-19.99

Reference pages: Head → **J024 - J029**

Standard cutting conditions → **J030**

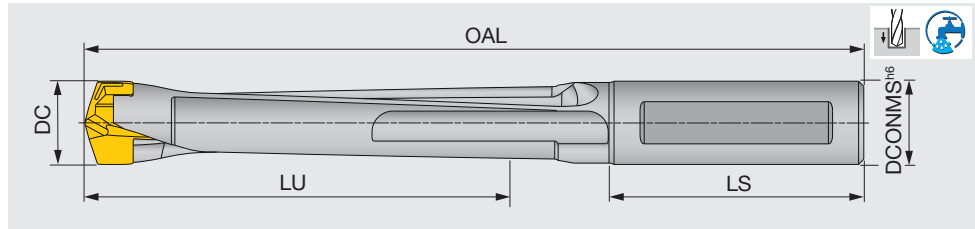

Metric	DC	DCONMS	LU	LS	OAL		Pocket size	Head
					DMP	DMC		
TIDC100C10-5	10 - 10.4	10	51.8	41	106.1	106.7	10	DM*100 - DM*104
TIDC105C11-5	10.5 - 10.9	11	54.4	41	108.6	109.2	10	DM*105 - DM*109
TIDC110C11-5	11 - 11.4	11	57	41	111.5	112.1	11	DM*110 - DM*114
TIDC115C12-5	11.5 - 11.9	12	59.6	41	114	114.6	11	DM*115 - DM*119
TIDC120C12-5	12 - 12.4	12	62.2	41	116.8	117.4	12	DM*120 - DM*124
TIDC125C13-5	12.5 - 12.9	13	64.8	46	124.3	124.9	12	DM*125 - DM*129
TIDC130C13-5	13 - 13.4	13	67.4	47	128.4	129.2	13	DM*130 - DM*134
TIDC135C14-5	13.5 - 13.9	14	70	43	126.9	127.7	13	DM*135 - DM*139
TIDC140C14-5	14 - 14.4	14	72.5	44	131	131.8	14	DM*140 - DM*144
TIDC145C15-5	14.5 - 14.9	15	75.1	45	134.5	135.3	14	DM*145 - DM*149
TIDC150C15-5	15 - 15.9	15	77.7	45	137.5	138.4	15	DM*150 - DM*159
TIDC160C16-5	16 - 16.9	16	82.9	48	149.5	150.5	16	DM*160 - DM*169
TIDC170C17-5	17 - 17.9	17	88.1	48	153.7	154.7	17	DM*170 - DM*179
TIDC180C18-5	18 - 18.9	18	93.3	48	159.3	160.4	18	DM*180 - DM*189
TIDC190C19-5	19 - 19.9	19	98.5	54	170.4	171.5	19	DM*190 - DM*199

Tool diameter	Hole diameter tolerance*
ø10 - ø19.9	+0.05 / 0

An overall length (OAL) differs for when the DMP insert is mounted and when the DMC is mounted. (No difference for the drill shoulder)

*Just for reference

SPARE PARTS



Designation	Clamping key
TIDC100-190	K-TID10-19.99

Reference pages: Head → **J024 - J029**
Standard cutting conditions → **J030**

Chamfering adapter

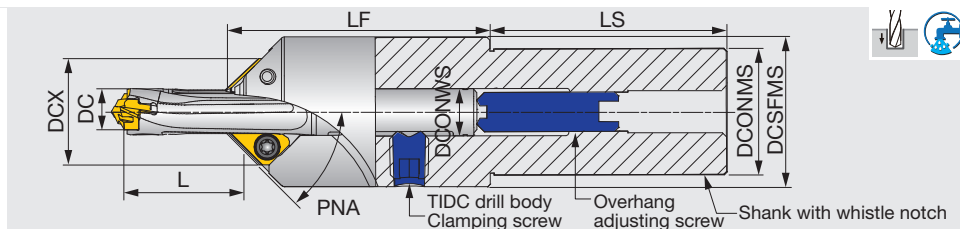

Inch	DC	DCONMS	DCSFMS	DCX	LF	LS	L* L/D = 3	L* L/D = 5	Drill body	DCONWS
TIDCF100-WU1.00-.394-.409	0.374 - 0.409	1.000	0.984	0.980	2.650	2.560	0.571 - 1.252	1.248 - 2.039	TIDC100C10-...	0.394
TIDCF110-WU1.00-.413-.449	0.413 - 0.449	1.000	0.984	1.020	2.650	2.560	0.618 - 1.311	1.228 - 2.134	TIDC105C11-..., TIDC110C11-...	0.433
TIDCF120-WU1.00-.453-.488	0.453 - 0.488	1.000	1.496	1.060	2.650	2.210	0.638 - 1.390	1.343 - 2.256	TIDC115C12-..., TIDC120C12-...	0.472
TIDCF130-WU1.00-.492-.528	0.492 - 0.528	1.000	1.496	1.100	2.650	2.560	0.594 - 1.447	1.331 - 2.339	TIDC125C13-..., TIDC130C13-...	0.512
TIDCF140-WU1.25-.531-.567	0.531 - 0.567	1.250	1.496	1.120	2.650	2.560	0.650 - 1.484	1.441 - 2.425	TIDC135C14-..., TIDC140C14-...	0.551
TIDCF150-WU1.25-.571-.626	0.571 - 0.626	1.250	1.496	1.160	2.650	2.560	0.634 - 1.559	1.563 - 2.551	TIDC145C15-..., TIDC150C15-...	0.591
TIDCF160-WU1.25-.630-.665	0.630 - 0.665	1.250	1.496	1.200	2.650	2.560	0.689 - 1.634	1.681 - 2.677	TIDC160C16-...	0.630
TIDCF170-WU1.25-.669-.705	0.669 - 0.705	1.250	1.496	1.240	2.650	2.560	0.697 - 1.689	1.630 - 2.768	TIDC170C17-...	0.669
TIDCF180-WU1.25-.709-.744	0.709 - 0.744	1.250	1.496	1.280	2.650	2.560	0.713 - 1.772	1.764 - 2.878	TIDC180C18-...	0.709
TIDCF190-WU1.25-.748-.783	0.748 - 0.783	1.250	1.496	1.320	2.950	2.560	0.756 - 1.756	1.732 - 2.909	TIDC190C19-...	0.748

Metric	DC	DCONMS	DCSFMS	DCX	LF	LS	L* L/D = 3	L* L/D = 5	Drill body	DCONWS
TIDCF100-W32	10 - 10.4	32	38	24.9	67.3	60	14.5 - 31.8	31.7 - 51.8	TIDC100C10-...	10
TIDCF110-W32	10.5 - 10.9	32	38	25.9	67.3	60	15.7 - 33.3	31.2 - 54.2	TIDC105C11-...	11
TIDCF110-W32	11 - 11.4	32	38	25.9	67.3	60	16.2 - 35.3	34.1 - 57.3	TIDC110C11-...	11
TIDCF120-W32	11.5 - 11.9	32	38	26.9	67.3	60	15.1 - 36.7	33.8 - 59.4	TIDC115C12-...	12
TIDCF120-W32	12 - 12.4	32	38	26.9	67.3	60	16.5 - 37.7	36.6 - 61.6	TIDC120C12-...	12
TIDCF130-W32	12.5 - 12.9	32	38	27.9	67.3	60	16.1 - 39.6	39.7 - 64.8	TIDC125C13-...	13
TIDCF130-W32	13 - 13.4	32	38	27.9	67.3	60	17.5 - 41.5	42.7 - 68	TIDC130C13-...	13
TIDCF140-W32	13.5 - 13.9	32	38	28.4	67.3	60	17.7 - 42.9	41.4 - 70.3	TIDC135C14-...	14
TIDCF140-W32	14 - 14.4	32	38	28.4	67.3	60	18.1 - 45	44.8 - 73.1	TIDC140C14-...	14
TIDCF150-W32	14.5 - 14.9	32	38	29.4	67.3	60	19.2 - 44.6	44 - 73.9	TIDC145C15-...	15
TIDCF150-W32	15 - 15.9	32	38	29.4	67.3	60	19.7 - 47.4	47.6 - 80.7	TIDC150C15-...	15
TIDCF160-W32	16 - 16.9	32	38	30.4	67.3	60	19.5 - 55.3	57 - 87.5	TIDC160C16-...	16
TIDCF170-W32	17 - 17.9	32	38	31.4	67.3	60	21.4 - 54.9	55.9 - 88.5	TIDC170C17-...	17
TIDCF180-W32	18 - 18.9	32	38	32.4	67.3	60	24.2 - 65.2	60 - 93	TIDC180C18-...	18
TIDCF190-W32	19 - 19.9	32	38	33.4	75	60	28.5 - 62.3	67 - 100	TIDC190C19-...	19

L* is the dimension when using 45° chamfering insert.

SPARE PARTS

Designation	Clamping screw	Grip	Overhang adjusting screw	Clamping screw of TIDC drill body	Torx bit	Wrench
TIDCF	SR14-544/S	SW6-SD	SRM10X10DIN916	SRM10X1.5S	BT15S	HW5.0

Recommended clamping torque: SR14-544/S = 3.54 lbf-ft, 4.8 N-m

CHAMFERING INSERT

XHGT-30A

XHGR-45A

XHGR-60A

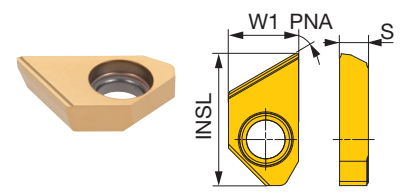
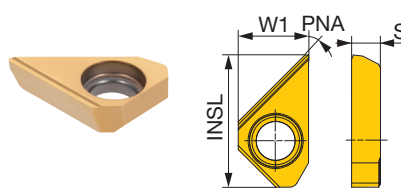
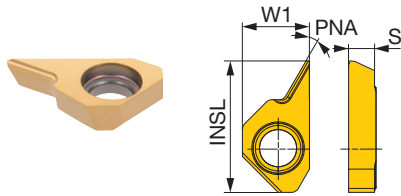

P	Steel	★									
M	Stainless	★									
K	Cast iron	★									
N	Non-ferrous	☆									
S	Superalloys	★									
H	Hard materials	★									

★ : First choice
☆ : Second choice

Designation	INSL (mm)	W1 (mm)	S (mm)	Coated								Chamfering angle PNA	Maximum width of chamfer ** (mm)	
				GH730										
XHGT090300-30A	16.00	8.5	3.3	●									30°	1.5
XHGR090300-45A	16.00	8.5	3.3	●									45°	6
XHGR090300-60A	16.00	8.5	3.3	●									60°	3.5

**Please reduce the feed rate to half when chamfering over 60% of maximum width of chamfer.

● : Line up
2 pieces per package

INSERT FOR SPECIAL CHAMFERING ADAPTERS

AOMT...

AOMT**-C45

AOMT**-N-**-DT

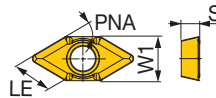
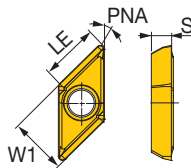
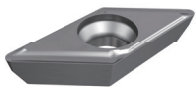

P	Steel	★									
M	Stainless	★									
K	Cast iron	★									
N	Non-ferrous	☆									
S	Superalloys	★									
H	Hard materials	★									

★ : First choice
☆ : Second choice

Designation	W1 (mm)	S (mm)	Coated								LE (mm)	Chamfering angle PNA	
			GH730										
AOMT060204-C45	0.223	0.077	●									0.177	45°
AOMT030204-N-30DT	0.157	0.063	●									0.157	30°
AOMT030204-N-45DT	0.110	0.063	●									0.157	45°

● : Line up

Grade
Insert
Ext. Toolholder
Int. Toolholder
Threading
Grooving
Miniature Tool
Milling Cutter
Endmill
Drilling Tool
Tooling System
User's Guide
Index

A
B
C
D
E
F
G
H
I
J
K
L
M

DRILL HEAD

DMP General purpose

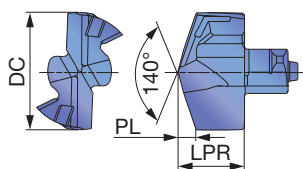
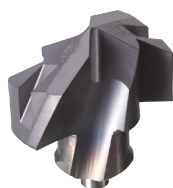

Tool diameter (Inch)	ø0.236" - ø0.705"	ø0.709" - ø1.020"
Head diameter tolerance	+0.0007" / 0	+0.0008" / 0
Tool diameter (mm)	ø6 - ø17.9	ø18 - ø25.9
Head diameter tolerance	+0.018 / 0	+0.021 / 0

P	Steel	★	★
M	Stainless	★	★
K	Cast iron	★	★
N	Non-ferrous	☆	☆
S	Superalloys	★	★
H	Hard materials	★	★

★ : First choice
 ☆ : Second choice

Designation	DC (in)	DC (mm)	LPR (mm)	Coated		PL (mm)	SSC	Pocket Size	Body
				AH725	AH9130				
DMP060	0.236	6	4	●		1.09	6	6	TID*060...
DMP061	0.240	6.1	4	●		1.11	6	6	TID*060...
DMP062	0.244	6.2	4	●		1.13	6	6	TID*060...
DMP063	0.248	6.3	4	●		1.15	6	6	TID*060...
DMP064	0.252	6.4	4	●		1.16	6	6	TID*060...
DMP065	0.256	6.5	4.3	●		1.18	6	6	TID*065...
DMP066	0.260	6.6	4.3	●		1.2	6	6	TID*065...
DMP067	0.264	6.7	4.3	●		1.22	6	6	TID*065...
DMP068	0.268	6.8	4.3	●		1.24	6	6	TID*065...
DMP069	0.272	6.9	4.3	●		1.26	6	6	TID*065...
DMP070	0.276	7	4.6	●		1.27	7	7	TID*070...
DMP071	0.280	7.1	4.6	●		1.29	7	7	TID*070...
DMP072	0.283	7.2	4.6	●		1.31	7	7	TID*070...
DMP073	0.287	7.3	4.6	●		1.33	7	7	TID*070...
DMP074	0.291	7.4	4.6	●		1.35	7	7	TID*070...
DMP075	0.295	7.5	4.6	●		1.36	7	7	TID*075...
DMP076	0.299	7.6	4.6	●		1.38	7	7	TID*075...
DMP077	0.303	7.7	4.6	●		1.4	7	7	TID*075...
DMP078	0.307	7.8	4.6	●		1.42	7	7	TID*075...
DMP079	0.311	7.9	4.6	●		1.44	7	7	TID*075...
DMP080	0.315	8	5.4	●		1.46	8	8	TID*080...
DMP081	0.319	8.1	5.4	●		1.47	8	8	TID*080...
DMP082	0.323	8.2	5.4	●		1.49	8	8	TID*080...
DMP083	0.327	8.3	5.4	●		1.51	8	8	TID*080...
DMP084	0.331	8.4	5.4	●		1.53	8	8	TID*080...
DMP085	0.335	8.5	5.4	●		1.55	8	8	TID*085...
DMP086	0.339	8.6	5.4	●		1.57	8	8	TID*085...
DMP087	0.343	8.7	5.4	●		1.58	8	8	TID*085...
DMP088	0.346	8.80	5.4	●		1.6	8	8	TID*085...
DMP089	0.350	8.9	5.4	●		1.62	8	8	TID*085...
DMP090	0.354	9	5.8	●		1.64	9	9	TID*090...
DMP091	0.358	9.1	5.8	●		1.66	9	9	TID*090...
DMP092	0.362	9.2	5.8	●		1.67	9	9	TID*090...
DMP093	0.366	9.3	5.8	●		1.69	9	9	TID*090...
DMP094	0.370	9.4	5.8	●		1.71	9	9	TID*090...
DMP095	0.374	9.5	5.8	●		1.73	9	9	TID*095...
DMP096	0.378	9.6	5.8	●		1.75	9	9	TID*095...
DMP097	0.382	9.7	5.8	●		1.77	9	9	TID*095...
DMP098	0.386	9.8	5.8	●		1.78	9	9	TID*095...
DMP099	0.390	9.9	5.8	●		1.8	9	9	TID*095...
DMP100	0.394	10	6.05	●	●	6.05	10	10	TID*100...
DMP101	0.398	10.1	6.05	●		6.05	10	10	TID*100...
DMP102	0.402	10.2	6.05	●		6.05	10	10	TID*100...
DMP103	0.406	10.3	6.05	●		6.05	10	10	TID*100...
DMP104	0.409	10.4	6.05	●		6.05	10	10	TID*100...

● : Line up

P	Steel	★	★
M	Stainless	★	★
K	Cast iron	★	★
N	Non-ferrous	☆	☆
S	Superalloys	★	★
H	Hard materials	★	★

★ : First choice
☆ : Second choice

Designation	DC (in)	DC (mm)	LPR (mm)	Coated		PL (mm)	SSC	Pocket Size	Body
				AH725	AH9130				
DMP105	0.413	10.5	6.05	●	●	6.05	10	10	TID*105...
DMP106	0.417	10.6	6.05	●		6.05	10	10	TID*105...
DMP107	0.421	10.7	6.05	●		6.05	10	10	TID*105...
DMP108	0.425	10.8	6.05	●	●	6.05	10	10	TID*105...
DMP109	0.429	10.9	6.05	●		6.05	10	10	TID*105...
DMP110	0.433	11	6.45	●	●	6.45	11	11	TID*110...
DMP111	0.437	11.1	6.45	●		6.45	11	11	TID*110...
DMP112	0.441	11.2	6.45	●		6.45	11	11	TID*110...
DMP113	0.445	11.3	6.45	●		6.45	11	11	TID*110...
DMP114	0.449	11.4	6.45	●		6.45	11	11	TID*110...
DMP115	0.453	11.5	6.45	●	●	6.45	11	11	TID*115...
DMP116	0.457	11.6	6.45	●		6.45	11	11	TID*115...
DMP117	0.461	11.7	6.45	●		6.45	11	11	TID*115...
DMP118	0.465	11.8	6.45	●		6.45	11	11	TID*115...
DMP119	0.469	11.9	6.45	●		6.45	11	11	TID*115...
DMP120	0.472	12	6.8	●	●	6.8	12	12	TID*120...
DMP121	0.476	12.1	6.8	●		6.8	12	12	TID*120...
DMP122	0.480	12.2	6.8	●		6.8	12	12	TID*120...
DMP123	0.484	12.3	6.8	●		6.8	12	12	TID*120...
DMP124	0.488	12.4	6.8	●		6.8	12	12	TID*120...
DMP125	0.492	12.5	6.8	●	●	6.8	12	12	TID*125...
DMP126	0.496	12.6	6.8	●	●	6.8	12	12	TID*125...
DMP127	0.500	12.7	6.8	●		6.8	12	12	TID*125...
DMP128	0.504	12.8	6.8	●		6.8	12	12	TID*125...
DMP129	0.508	12.9	6.8	●		6.8	12	12	TID*125...
DMP130	0.512	13	7.4	●	●	7.4	13	13	TID*130...
DMP131	0.516	13.1	7.4	●		7.4	13	13	TID*130...
DMP132	0.520	13.2	7.4	●		7.4	13	13	TID*130...
DMP133	0.524	13.3	7.4	●		7.4	13	13	TID*130...
DMP134	0.528	13.4	7.4	●		7.4	13	13	TID*130...
DMP135	0.531	13.5	7.4	●	●	7.4	13	13	TID*135...
DMP136	0.535	13.6	7.4	●		7.4	13	13	TID*135...
DMP137	0.539	13.7	7.4	●		7.4	13	13	TID*135...
DMP138	0.543	13.8	7.4	●	●	7.4	13	13	TID*135...
DMP139	0.547	13.90	7.4	●		7.4	13	13	TID*135...
DMP140	0.551	14	7.95	●	●	2.55	14	14	TID*140...
DMP141	0.555	14.1	7.95	●		2.57	14	14	TID*140...
DMP142	0.559	14.2	7.95	●	●	2.58	14	14	TID*140...
DMP143	0.563	14.3	7.95	●		2.6	14	14	TID*140...
DMP144	0.567	14.4	7.95	●		2.62	14	14	TID*140...
DMP145	0.571	14.5	7.95	●	●	2.64	14	14	TID*145...
DMP146	0.575	14.6	7.95	●		2.66	14	14	TID*145...
DMP147	0.579	14.7	7.95	●		2.68	14	14	TID*145...
DMP148	0.583	14.8	7.95	●		2.69	14	14	TID*145...
DMP149	0.587	14.9	7.95	●		2.71	14	14	TID*145...
DMP150	0.591	15	8.53	●	●	2.73	15	15	TID*150...
DMP151	0.594	15.1	8.53	●		2.75	15	15	TID*150...
DMP152	0.598	15.2	8.53	●	●	2.77	15	15	TID*150...
DMP153	0.602	15.3	8.53	●		2.78	15	15	TID*150...
DMP154	0.606	15.4	8.53	●		2.8	15	15	TID*150...
DMP155	0.610	15.5	8.53	●	●	2.82	15	15	TID*150...
DMP156	0.614	15.6	8.53	●		2.84	15	15	TID*150...
DMP157	0.618	15.7	8.53	●		2.86	15	15	TID*150...
DMP158	0.622	15.8	8.53	●	●	2.88	15	15	TID*150...
DMP159	0.626	15.9	8.53	●		2.89	15	15	TID*150...
DMP160	0.630	16	9.1	●	●	2.91	16	16	TID*160...
DMP161	0.634	16.1	9.1	●		2.93	16	16	TID*160...

ø6 - ø19.9 = 2 pieces per package
ø20 - ø25.9 = 1 piece per package

● : Line up

Grade
Insert
Toolholder
Ext. Toolholder
Int. Toolholder
Threading
Grooving
Miniature Tool
Endmill
Drilling Tool
Tooling System
User's Guide
Index



DMP General purpose

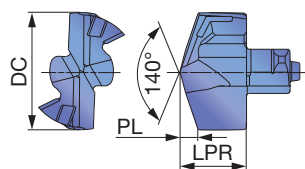

Tool diameter (Inch)	ø0.236" - ø0.705"	ø0.709" - ø1.020"
Head diameter tolerance	+0.0007" / 0	+0.0008" / 0
Tool diameter (mm)	ø6 - ø17.9	ø18 - ø25.9
Head diameter tolerance	+0.018 / 0	+0.021 / 0

P	Steel	★	★
M	Stainless	★	★
K	Cast iron	★	★
N	Non-ferrous	☆	☆
S	Superalloys	★	★
H	Hard materials	★	★

★ : First choice
☆ : Second choice

Designation	DC (in)	DC (mm)	LPR (mm)	Coated		PL (mm)	SSC	Pocket Size	Body
				AH725	AH9130				
DMP162	0.638	16.2	9.1	●		2.95	16	16	TID*160...
DMP163	0.642	16.3	9.1	●		2.97	16	16	TID*160...
DMP164	0.646	16.4	9.1	●		2.98	16	16	TID*160...
DMP165	0.650	16.5	9.1	●	●	3	16	16	TID*160...
DMP166	0.654	16.6	9.1	●		3.02	16	16	TID*160...
DMP1666	0.656	16.66	9.1	●		25.4	16	16	TID*160...
DMP167	0.657	16.7	9.1	●		3.04	16	16	TID*160...
DMP168	0.661	16.8	9.1	●		3.06	16	16	TID*160...
DMP169	0.665	16.9	9.1	●		3.08	16	16	TID*160...
DMP170	0.669	17	9.7	●	●	3.09	17	17	TID*170...
DMP171	0.673	17.1	9.7	●		3.11	17	17	TID*170...
DMP172	0.677	17.2	9.7	●		3.13	17	17	TID*170...
DMP173	0.681	17.3	9.7	●		3.15	17	17	TID*170...
DMP174	0.685	17.4	9.7	●		3.17	17	17	TID*170...
DMP175	0.689	17.5	9.7	●	●	3.18	17	17	TID*170...
DMP176	0.693	17.6	9.7	●		3.2	17	17	TID*170...
DMP177	0.697	17.7	9.7	●		3.22	17	17	TID*170...
DMP178	0.701	17.8	9.7	●		3.24	17	17	TID*170...
DMP179	0.705	17.9	9.7	●		3.26	17	17	TID*170...
DMP180	0.709	18	10.3	●	●	3.28	18	18	TID*180...
DMP181	0.713	18.1	10.3	●		3.29	18	18	TID*180...
DMP182	0.717	18.2	10.3	●		3.31	18	18	TID*180...
DMP183	0.720	18.3	10.3	●		3.33	18	18	TID*180...
DMP184	0.724	18.4	10.3	●		3.35	18	18	TID*180...
DMP185	0.728	18.5	10.3	●	●	3.37	18	18	TID*180...
DMP186	0.732	18.6	10.3	●		3.38	18	18	TID*180...
DMP187	0.736	18.7	10.3	●		3.4	18	18	TID*180...
DMP188	0.740	18.8	10.3	●		3.42	18	18	TID*180...
DMP189	0.744	18.9	10.3	●		3.44	18	18	TID*180...
DMP190	0.748	19	10.8	●	●	3.46	19	19	TID*190...
DMP1905	0.750	19.05	10.8	●		2.89	19	19	TID*190...
DMP191	0.752	19.1	10.8	●		3.48	19	19	TID*190...
DMP192	0.756	19.2	10.8	●		3.49	19	19	TID*190...
DMP193	0.760	19.3	10.8	●		3.51	19	19	TID*190...
DMP194	0.764	19.4	10.8	●		3.53	19	19	TID*190...
DMP1946	0.766	19.46	10.8	●		2.96	19	19	TID*190...
DMP195	0.768	19.5	10.8	●	●	3.55	19	19	TID*190...
DMP196	0.772	19.6	10.8	●		3.57	19	19	TID*190...
DMP197	0.776	19.7	10.8	●		3.59	19	19	TID*190...
DMP198	0.780	19.8	10.8	●		3.6	19	19	TID*190...
DMP1984	0.781	19.84	10.8	●		3.03	19	19	TID*190...
DMP199	0.783	19.9	10.8	●		3.62	19	19	TID*190...
DMP200	0.787	20	11.4	●		3.64	20	20	TID*200...
DMP201	0.791	20.1	11.4	●		3.66	20	20	TID*200...
DMP202	0.795	20.2	11.4	●		3.68	20	20	TID*200...
DMP203	0.799	20.3	11.4	●		3.69	20	20	TID*200...
DMP204	0.803	20.4	11.4	●		3.71	20	20	TID*200...

● : Line up

P	Steel	★	★
M	Stainless	★	★
K	Cast iron	★	★
N	Non-ferrous	☆	☆
S	Superalloys	★	★
H	Hard materials	★	★

★ : First choice
☆ : Second choice

Designation	DC (in)	DC (mm)	LPR (mm)	Coated		PL (mm)	SSC	Pocket Size	Body
				AH725	AH9130				
DMP205	0.807	20.5	11.4	●		3.73	20	20	TID*200...
DMP206	0.811	20.6	11.4	●		3.75	20	20	TID*200...
DMP207	0.815	20.7	11.4	●		3.77	20	20	TID*200...
DMP208	0.819	20.8	11.4	●		3.79	20	20	TID*200...
DMP209	0.823	20.9	11.4	●		3.8	20	20	TID*200...
DMP210	0.827	21	11.98	●		3.82	21	21	TID*210...
DMP211	0.831	21.1	11.98	●		3.84	21	21	TID*210...
DMP212	0.835	21.2	11.98	●		3.86	21	21	TID*210...
DMP213	0.839	21.3	11.98	●		3.88	21	21	TID*210...
DMP214	0.843	21.4	11.98	●		3.89	21	21	TID*210...
DMP215	0.846	21.5	11.98	●		3.91	21	21	TID*210...
DMP216	0.850	21.6	11.98	●		3.93	21	21	TID*210...
DMP217	0.854	21.7	11.98	●		3.95	21	21	TID*210...
DMP218	0.858	21.8	11.98	●		3.97	21	21	TID*210...
DMP219	0.862	21.9	11.98	●		3.99	21	21	TID*210...
DMP220	0.866	22	12.56	●		4	22	22	TID*220...
DMP221	0.870	22.1	12.56	●		4.02	22	22	TID*220...
DMP222	0.874	22.2	12.56	●		4.04	22	22	TID*220...
DMP223	0.878	22.3	12.56	●		4.06	22	22	TID*220...
DMP224	0.882	22.4	12.56	●		4.08	22	22	TID*220...
DMP225	0.886	22.5	12.56	●		4.09	22	22	TID*220...
DMP226	0.890	22.6	12.56	●		4.11	22	22	TID*220...
DMP227	0.894	22.7	12.56	●		4.13	22	22	TID*220...
DMP228	0.898	22.8	12.56	●		4.15	22	22	TID*220...
DMP229	0.902	22.9	12.56	●		4.17	22	22	TID*220...
DMP230	0.906	23	13.13	●		4.19	23	23	TID*230...
DMP231	0.909	23.1	13.13	●		4.2	23	23	TID*230...
DMP232	0.913	23.2	13.13	●		4.22	23	23	TID*230...
DMP233	0.917	23.3	13.13	●		4.24	23	23	TID*230...
DMP234	0.921	23.4	13.13	●		4.26	23	23	TID*230...
DMP235	0.925	23.5	13.13	●		4.28	23	23	TID*230...
DMP236	0.929	23.6	13.13	●		4.29	23	23	TID*230...
DMP237	0.933	23.7	13.13	●		4.31	23	23	TID*230...
DMP238	0.937	23.8	13.13	●		4.33	23	23	TID*230...
DMP239	0.941	23.9	13.13	●		4.35	23	23	TID*230...
DMP240	0.945	24	13.7	●		4.37	24	24	TID*240...
DMP241	0.949	24.1	13.7	●		4.39	24	24	TID*240...
DMP242	0.953	24.2	13.7	●		4.4	24	24	TID*240...
DMP243	0.957	24.3	13.7	●		4.42	24	24	TID*240...
DMP244	0.961	24.4	13.7	●		4.44	24	24	TID*240...
DMP245	0.965	24.5	13.7	●		4.46	24	24	TID*240...
DMP246	0.969	24.6	13.7	●		4.48	24	24	TID*240...
DMP247	0.972	24.7	13.7	●		4.5	24	24	TID*240...
DMP248	0.976	24.8	13.7	●		4.51	24	24	TID*240...
DMP249	0.980	24.9	13.7	●		4.53	24	24	TID*240...
DMP250	0.984	25	14.3	●		4.55	25	25	TID*250...
DMP251	0.988	25.1	14.3	●		4.57	25	25	TID*250...
DMP252	0.992	25.2	14.3	●		4.59	25	25	TID*250...
DMP253	0.996	25.3	14.3	●		4.6	25	25	TID*250...
DMP254	1.000	25.4	14.3	●		4.62	25	25	TID*250...
DMP255	1.004	25.5	14.3	●		4.64	25	25	TID*250...
DMP256	1.008	25.6	14.3	●		4.66	25	25	TID*250...
DMP257	1.012	25.7	14.3	●		4.68	25	25	TID*250...
DMP258	1.016	25.8	14.3	●		4.7	25	25	TID*250...
DMP259	1.020	25.9	14.3	●		4.71	25	25	TID*250...

ø10 - ø19.9 = 2 pieces per package

● : Line up

Grade
Insert
Toolholder
Ext. Toolholder
Int. Toolholder
Threading
Grooving
Miniature Tool
Milling Cutter
Endmill
Drilling Tool
Tooling System
User's Guide
Index



DMC High precision machining

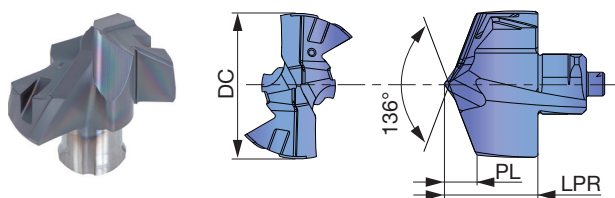

Tool diameter (inch)	ø0.394" - ø0.705"	ø0.709" - ø0.783"
Head diameter tolerance	+0.0007" / 0	+0.0008" / 0
Tool diameter (mm)	ø10 - ø17.9	ø18 - ø19.9
Head diameter tolerance	+0.018 / 0	+0.021 / 0

P Steel	★								
M Stainless	★								
K Cast iron	★								
N Non-ferrous	☆								
S Superalloys	★								
H Hard materials	★								

★ : First choice
☆ : Second choice

Designation	DC (in)	DC (mm)	LPR (mm)	Coated								PL (mm)	SSC	Pocket Size	Body
				AH9130											
DMC100	0.394	10	6.67	●								2.09	10	10	TID*100...
DMC101	0.398	10.1	6.67	●								2.11	10	10	TID*100...
DMC102	0.402	10.2	6.67	●								2.13	10	10	TID*100...
DMC103	0.406	10.3	6.67	●								2.15	10	10	TID*100...
DMC104	0.409	10.4	6.67	●								2.17	10	10	TID*100...
DMC105	0.413	10.5	6.67	●								2.19	10	10	TID*105...
DMC106	0.417	10.6	6.67	●								2.21	10	10	TID*105...
DMC107	0.421	10.7	6.67	●								2.23	10	10	TID*105...
DMC108	0.425	10.8	6.67	●								2.25	10	10	TID*105...
DMC109	0.429	10.9	6.67	●								2.27	10	10	TID*105...
DMC110	0.433	11	7.1	●								2.32	11	11	TID*110...
DMC111	0.437	11.1	7.1	●								2.34	11	11	TID*110...
DMC112	0.441	11.2	7.1	●								2.36	11	11	TID*110...
DMC113	0.445	11.3	7.1	●								2.38	11	11	TID*110...
DMC114	0.449	11.4	7.1	●								2.4	11	11	TID*110...
DMC115	0.453	11.5	7.1	●								2.42	11	11	TID*115...
DMC116	0.457	11.6	7.1	●								2.44	11	11	TID*115...
DMC117	0.461	11.7	7.1	●								2.46	11	11	TID*115...
DMC118	0.465	11.8	7.1	●								2.48	11	11	TID*115...
DMC119	0.469	11.9	7.1	●								2.5	11	11	TID*115...
DMC120	0.472	12	7.43	●								2.45	12	12	TID*120...
DMC121	0.476	12.1	7.43	●								2.47	12	12	TID*120...
DMC122	0.480	12.2	7.43	●								2.49	12	12	TID*120...
DMC123	0.484	12.3	7.43	●								2.51	12	12	TID*120...
DMC124	0.488	12.4	7.43	●								2.53	12	12	TID*120...
DMC125	0.492	12.5	7.43	●								2.55	12	12	TID*125...
DMC126	0.496	12.6	7.43	●								2.57	12	12	TID*125...
DMC127	0.500	12.7	7.43	●								2.59	12	12	TID*125...
DMC128	0.504	12.8	7.43	●								2.61	12	12	TID*125...
DMC129	0.508	12.9	7.43	●								2.63	12	12	TID*125...
DMC130	0.512	13	8.15	●								2.71	13	13	TID*130...
DMC131	0.516	13.1	8.15	●								2.73	13	13	TID*130...
DMC132	0.520	13.2	8.15	●								2.75	13	13	TID*130...
DMC133	0.524	13.3	8.15	●								2.77	13	13	TID*130...
DMC134	0.528	13.4	8.15	●								2.79	13	13	TID*130...
DMC135	0.531	13.5	8.15	●								2.81	13	13	TID*135...
DMC136	0.535	13.6	8.15	●								2.83	13	13	TID*135...
DMC137	0.539	13.7	8.15	●								2.85	13	13	TID*135...
DMC138	0.543	13.8	8.15	●								2.87	13	13	TID*135...
DMC139	0.547	13.9	8.15	●								2.89	13	13	TID*135...
DMC140	0.551	14	8.76	●								2.93	14	14	TID*140...
DMC141	0.555	14.1	8.76	●								2.95	14	14	TID*140...
DMC142	0.559	14.2	8.76	●								2.97	14	14	TID*140...
DMC143	0.563	14.3	8.76	●								2.99	14	14	TID*140...
DMC144	0.567	14.4	8.76	●								3.01	14	14	TID*140...
DMC145	0.571	14.5	8.76	●								3.03	14	14	TID*145...
DMC146	0.575	14.6	8.76	●								3.05	14	14	TID*145...

● : Line up

P	Steel	★
M	Stainless	★
K	Cast iron	★
N	Non-ferrous	☆
S	Superalloys	★
H	Hard materials	★

★ : First choice
☆ : Second choice

Designation	DC (in)	DC (mm)	LPR (mm)	Coated								PL (mm)	SSC	Pocket Size	Body
				AH9130											
DMC147	0.579	14.7	8.76	●								3.07	14	14	TID*145...
DMC148	0.583	14.8	8.76	●								3.09	14	14	TID*145...
DMC149	0.587	14.9	8.76	●								3.11	14	14	TID*145...
DMC150	0.591	15	9.44	●								3.18	15	15	TID*150...
DMC151	0.594	15.1	9.44	●								3.2	15	15	TID*150...
DMC152	0.598	15.2	9.44	●								3.22	15	15	TID*150...
DMC153	0.602	15.3	9.44	●								3.24	15	15	TID*150...
DMC154	0.606	15.4	9.44	●								3.26	15	15	TID*150...
DMC155	0.610	15.5	9.44	●								3.28	15	15	TID*150...
DMC156	0.614	15.6	9.44	●								3.3	15	15	TID*150...
DMC157	0.618	15.7	9.44	●								3.32	15	15	TID*150...
DMC158	0.622	15.8	9.44	●								3.34	15	15	TID*150...
DMC159	0.626	15.9	9.44	●								3.36	15	15	TID*150...
DMC160	0.630	16	10.07	●								3.39	16	16	TID*160...
DMC161	0.634	16.1	10.07	●								3.41	16	16	TID*160...
DMC162	0.638	16.2	10.07	●								3.43	16	16	TID*160...
DMC163	0.642	16.3	10.07	●								3.45	16	16	TID*160...
DMC164	0.646	16.4	10.07	●								3.47	16	16	TID*160...
DMC165	0.650	16.5	10.07	●								3.49	16	16	TID*160...
DMC166	0.654	16.6	10.07	●								3.51	16	16	TID*160...
DMC167	0.657	16.7	10.07	●								3.53	16	16	TID*160...
DMC168	0.661	16.8	10.07	●								3.55	16	16	TID*160...
DMC169	0.665	16.9	10.07	●								3.57	16	16	TID*160...
DMC170	0.669	17	10.68	●								3.57	17	17	TID*170...
DMC171	0.673	17.1	10.68	●								3.59	17	17	TID*170...
DMC172	0.677	17.2	10.68	●								3.61	17	17	TID*170...
DMC173	0.681	17.3	10.68	●								3.63	17	17	TID*170...
DMC174	0.685	17.4	10.68	●								3.65	17	17	TID*170...
DMC175	0.689	17.5	10.68	●								3.67	17	17	TID*170...
DMC176	0.693	17.6	10.68	●								3.69	17	17	TID*170...
DMC177	0.697	17.7	10.68	●								3.71	17	17	TID*170...
DMC178	0.701	17.8	10.68	●								3.73	17	17	TID*170...
DMC179	0.705	17.9	10.68	●								3.75	17	17	TID*170...
DMC180	0.709	18	11.35	●								3.78	18	18	TID*180...
DMC181	0.713	18.1	11.35	●								3.8	18	18	TID*180...
DMC182	0.717	18.2	11.35	●								3.82	18	18	TID*180...
DMC183	0.720	18.3	11.35	●								3.84	18	18	TID*180...
DMC184	0.724	18.4	11.35	●								3.86	18	18	TID*180...
DMC185	0.728	18.5	11.35	●								3.88	18	18	TID*180...
DMC186	0.732	18.6	11.35	●								3.9	18	18	TID*180...
DMC187	0.736	18.7	11.35	●								3.92	18	18	TID*180...
DMC188	0.740	18.8	11.35	●								3.94	18	18	TID*180...
DMC189	0.744	18.9	11.35	●								3.96	18	18	TID*180...
DMC190	0.748	19	11.91	●								3.99	19	19	TID*190...
DMC191	0.752	19.1	11.91	●								4.01	19	19	TID*190...
DMC192	0.756	19.2	11.91	●								4.03	19	19	TID*190...
DMC193	0.760	19.3	11.91	●								4.05	19	19	TID*190...
DMC194	0.764	19.4	11.91	●								4.07	19	19	TID*190...
DMC195	0.768	19.5	11.91	●								4.09	19	19	TID*190...
DMC196	0.772	19.6	11.91	●								4.11	19	19	TID*190...
DMC197	0.776	19.7	11.91	●								4.13	19	19	TID*190...
DMC198	0.780	19.8	11.91	●								4.15	19	19	TID*190...
DMC199	0.783	19.9	11.91	●								4.17	19	19	TID*190...

● : Line up

Grade
Insert
Toolholder
Ext. Toolholder
Int. Toolholder
Threading
Grooving
Miniature Tool
Endmill
Drilling Tool
Tooling System
Index



STANDARD CUTTING CONDITIONS

ISO	Workpiece material	Cutting speed Vc (sfm)	Feed: f (ipr)						
			DC (in)						
			ø0.236 - ø0.311	ø0.315 - 0.390	ø0.394 - ø0.469	ø0.472 - ø0.547	ø0.551 - ø0.626	ø0.630 - ø0.783	ø0.787 - ø1.020
P	Low carbon steel (C < 0.3) 1018, 1020, 1026, etc.	262 - 459	0.004 - 0.005	0.005 - 0.010	0.006 - 0.011	0.007 - 0.012	0.008 - 0.014	0.010 - 0.018	0.010 - 0.018
	High carbon steel (C > 0.3) 1045, 1055, etc.	230 - 394	0.004 - 0.005	0.005 - 0.010	0.006 - 0.011	0.007 - 0.012	0.008 - 0.014	0.010 - 0.018	0.010 - 0.018
	Low alloy steel 5120, etc.	230 - 394	0.003 - 0.005	0.004 - 0.010	0.006 - 0.011	0.006 - 0.013	0.007 - 0.014	0.009 - 0.016	0.010 - 0.018
	Alloy steel 4140, 8620, etc.	131 - 295	0.003 - 0.005	0.004 - 0.010	0.006 - 0.011	0.006 - 0.013	0.007 - 0.014	0.009 - 0.016	0.010 - 0.018
M	Stainless steel 304SS, 316SS, 17-4PH, etc.	98 - 230	0.003 - 0.004	0.004 - 0.006	0.005 - 0.007	0.006 - 0.008	0.006 - 0.009	0.006 - 0.010	0.007 - 0.012
K	Gray cast iron Class 25, Class 30, etc.	262 - 591	0.005 - 0.007	0.006 - 0.012	0.008 - 0.014	0.010 - 0.016	0.012 - 0.018	0.014 - 0.022	0.014 - 0.024
	Ductile cast iron 60-40-18, 60-55-06, etc.	262 - 459	0.005 - 0.007	0.006 - 0.012	0.008 - 0.014	0.010 - 0.016	0.012 - 0.018	0.014 - 0.022	0.014 - 0.024
N	Aluminum alloys 6061, 7075, etc.	262 - 722	0.004 - 0.008	0.008 - 0.014	0.010 - 0.016	0.012 - 0.018	0.014 - 0.020	0.016 - 0.024	0.020 - 0.030
S	Titanium alloys Ti-6Al-4V, etc.	66 - 164	0.002 - 0.003	0.002 - 0.005	0.003 - 0.006	0.004 - 0.011	0.005 - 0.008	0.006 - 0.009	0.007 - 0.011
	Nickel-based alloys	66 - 164	0.002 - 0.003	0.002 - 0.004	0.003 - 0.005	0.004 - 0.006	0.005 - 0.007	0.005 - 0.009	0.006 - 0.009
H	Hardened steel	66 - 164	0.002 - 0.003	0.002 - 0.005	0.003 - 0.006	0.004 - 0.007	0.005 - 0.008	0.006 - 0.009	0.006 - 0.010

Cutting conditions in the above table show standard cutting conditions.

Cutting conditions may change due to the rigidity and power of the machine and the workpiece material.

Machined hole diameter may change depending upon the rigidity of the machine tool or cutting conditions.

In case of L/D = 8,12 drill, the recommended range of cutting speeds and feeds is between the minimum and median values listed above.

CLAMPING KEY FOR MEASURING UN-CLAMPING TORQUE

To check drill body duration, measure un-clamping torque by using a torque-driver

Recommended value of un-clamping torque that means usable limit of a drill body shown in below table.

Clamping key for measuring
un-clamping torque:

KHS-TID10-19.99



* The clamping key
can be used with
general torque
drivers.



Head Designation	Recommended value of un-clamping torque that means usable limit of a drill body	
	(N·m)	(cN·m)
DM*100-109	0.2	20
DM*110-119	0.2	20
DM*120-129	0.25	25
DM*130-139	0.25	25
DM*140-149	0.3	30
DM*150-159	0.3	30
DM*160-169	0.35	35
DM*170-179	0.35	35
DM*180-189	0.4	40
DM*190-199	0.4	40

HOW TO MOUNT THE TIDC DRILL BODY INTO THE CHAMFER ADAPTOR

The overhang length of the drill can be changed by the adjusting screw at the bottom of the adaptor.
The rear end of the drill body must be in contact with the adjusting screw as the screw supports the drill against thrust force when drilling.

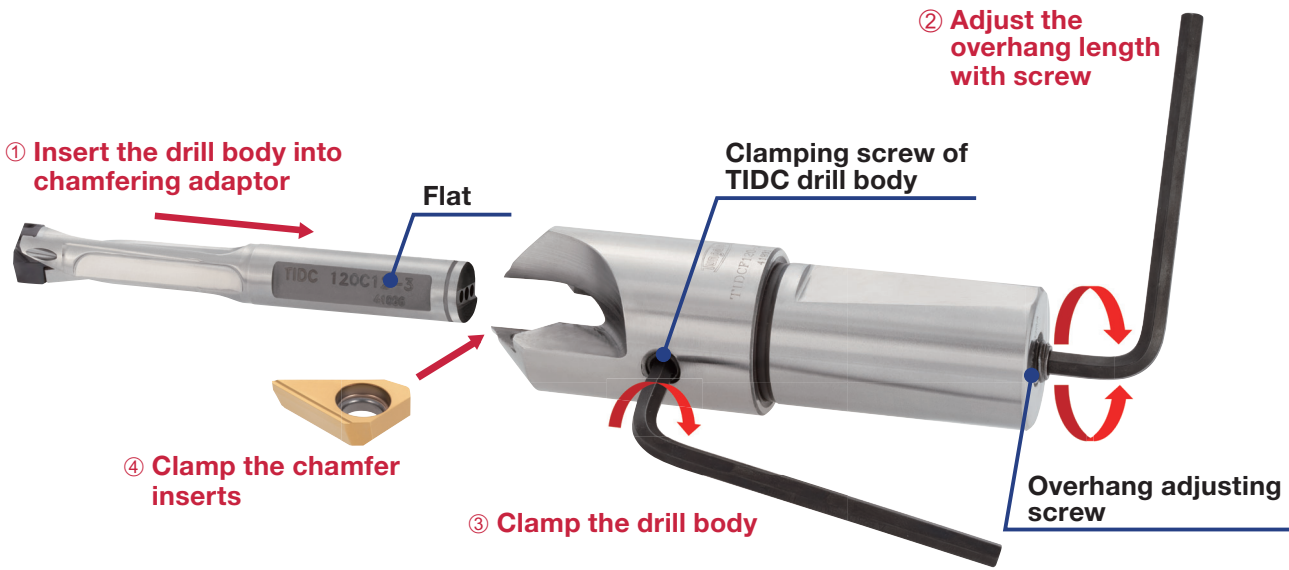

Procedure

- ① Place the TIDC drill body into the chamfer adaptor without chamfer inserts.
- ② Adjust the overhang length of the drill body with the adjusting screw at the bottom of the adaptor.
- ③ Adjust the position of the drill body so that the drill body is fixed at the flat and tighten the clamping screw of the drill body. This aligns the flutes of the TIDC drill body with the chamfer inserts.
- ④ To clamp the chamfer inserts, tighten the clamping screw of the insert while pushing the insert into the insert pocket.

Notice

Before removing the drill body from the adaptor, chamfer inserts must be unclamped. The overhang adjusting screw can be handled from the top of the adaptor with flat blade screwdriver. In this way, the overhang length of the drill body can be adjusted after the adaptor is positioned on the drill shank.

PARTS

Clamping screw of TIDC drill body	Overhang adjusting screw	Wrench	Chamfering Insert screw	Wrench	
				Torx bit	Grip
SRM10x10DIN916	SRM10x1.5S	HW5.0	SR14-544/S ***	BT15S	SW6-SD

*** SR14-544/S : 5 pieces per package

CAUTION FOR USING DRILLS WITH L/D = 8 & 12

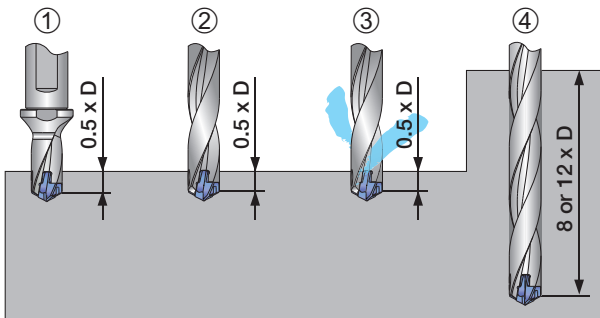

- ① Drill a pilot hole in the depth of 0.5 x D.
The same head diameter should be used for a pilot hole and a deep hole.
- ② Rotate the drill at a low speed, such as 100 min⁻¹, and feed it slowly into the pilot hole until the drill reaches several millimeters from the bottom.
- ③ Supply the coolant and rotate the drill at the recommended speed.
- ④ Drill the required depth under the recommended cutting conditions.

Note: In case of making L/D= 8 & 12 depth hole without a pilot hole, DMC type head should be used.

DRILL FORCE MEISTER

TISU L/D=3

Head indexable drill

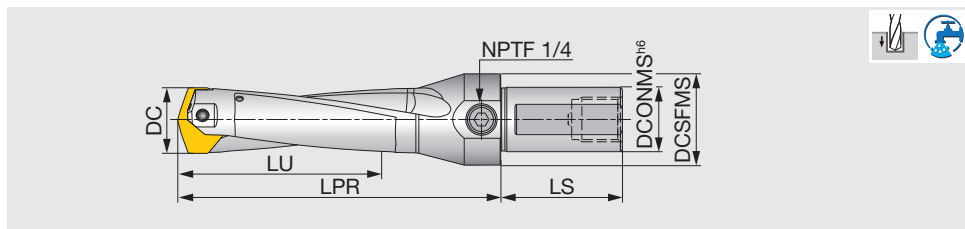

Inch	DCN	DCX	DCONMS	DCSFMS	LU	LPR	LS	Pocket size	Head
TISU1024F1250-3	1.024	1.059	1.250	1.772	3.257	5.315	2.362	26	SMP26*
TISU1063F1250-3	1.063	1.098	1.250	1.772	3.382	5.453	2.362	27	SMP27*
TISU1102F1250-3	1.102	1.138	1.250	1.772	3.508	5.606	2.362	28	SMP28*
TISU1142F1250-3	1.142	1.177	1.250	1.772	3.633	5.744	2.362	29	SMP29*
TISU1181F1250-3	1.181	1.217	1.250	1.772	3.758	5.894	2.362	30	SMP30*
TISU1220F1250-3	1.220	1.256	1.250	1.772	3.883	6.031	2.362	31	SMP31*
TISU1260F1500-3	1.260	1.295	1.500	2.165	4.009	6.378	2.677	32	SMP32*
TISU1299F1500-3	1.299	1.335	1.500	2.165	4.134	6.516	2.677	33	SMP33*
TISU1339F1500-3	1.339	1.374	1.500	2.165	4.260	6.654	2.677	34	SMP34*
TISU1378F1500-3	1.378	1.413	1.500	2.165	4.385	6.807	2.677	35	SMP35*
TISU1417F1500-3	1.417	1.453	1.500	2.165	4.510	6.945	2.677	36	SMP36*
TISU1457F1500-3	1.457	1.492	1.500	2.165	4.635	7.083	2.677	37	SMP37*
TISU1496F1500-3	1.496	1.531	1.500	2.165	4.760	7.240	2.677	38	SMP38*
TISU1535F1500-3	1.535	1.571	1.500	2.165	4.885	7.378	2.677	39	SMP39*
TISU1575F1500-3	1.575	1.614	1.500	2.165	5.011	7.516	2.677	40	SMP40*

Tool diameter	Hole diameter tolerance*
ø1.024 - ø1.177	+0.0020 / 0
ø1.181 - ø1.614	+0.0024 / 0

*Just for reference

SPARE PARTS



Designation	Clamping screw	Wrench		Screw for side port	Plug*
		Torx bit	Grip		
TISU1024F1250-3	TS50230D3	BLDT20/S7	H-TB2W	NPTF1/4	SL32IN
TISU1063F1250-3	TS50230D3	BLDT20/S7	H-TB2W	NPTF1/4	SL32IN
TISU1102F1250-3	TS50250D35	BLDT25/S7	H-TB2W	NPTF1/4	SL32IN
TISU1142F1250-3	TS50250D35	BLDT25/S7	H-TB2W	NPTF1/4	SL32IN
TISU1181F1250-3	TS60265D4	BLDT25/S7	H-TB2W	NPTF1/4	SL32IN
TISU1220F1250-3	TS60265D4	BLDT25/S7	H-TB2W	NPTF1/4	SL32IN
TISU1260F1500-3	TS60285D42	BLDT25/S7	H-TB2W	NPTF1/4	SL38IN
TISU1299F1500-3	TS60285D42	BLDT25/S7	H-TB2W	NPTF1/4	SL38IN
TISU1339F1500-3	TS60285D42	BLDT25/S7	H-TB2W	NPTF1/4	SL38IN
TISU1378F1500-3	TS60320D5	BLDT25/S7	H-TB2W	NPTF1/4	SL38IN
TISU1417F1500-3	TS60320D5	BLDT25/S7	H-TB2W	NPTF1/4	SL38IN
TISU1457F1500-3	TS60320D5	BLDT25/S7	H-TB2W	NPTF1/4	SL38IN
TISU1496F1500-3	TS80340D6	BLDT25/S7	H-TB2W	NPTF1/4	SL38IN
TISU1535F1500-3	TS80340D6	BLDT25/S7	H-TB2W	NPTF1/4	SL38IN
TISU1575F1500-3	TS80340D6	BLDT25/S7	H-TB2W	NPTF1/4	SL38IN

*Optional part
Inner thread size: NPTF1/4

Recommended clamping torque : TS50230D3= 3.69 lb-ft, 5 N-m, TS50250D35= 4.06 lb-ft, 5.5N-m, TS60265D4= 4.43 lb-ft, 6N-m, TS60285D42= 4.43 lb-ft, 6N-m, TS60320D5= 4.43 lb-ft, 6N-m, TS80340D6= 5.16 lb-ft, 7N-m

Reference pages: Head → **J034 - J035**
Standard cutting conditions → **J035**

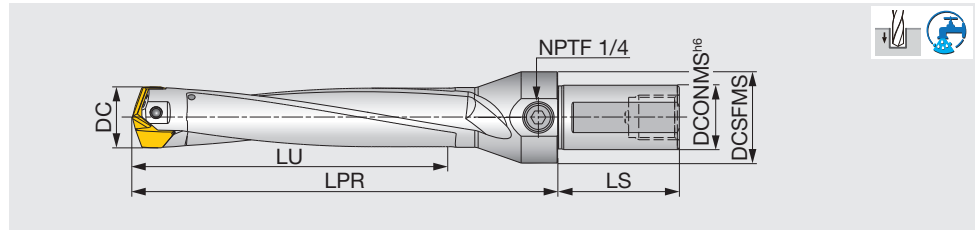

Inch	DCN	DCX	DCONMS	DCSFMS	LU	LPR	LS	Pocket size	Head
TISU1024F1250-5	1.024	1.059	1.250	1.772	5.304	7.362	2.362	26	SMP26*
TISU1063F1250-5	1.063	1.098	1.250	1.772	5.508	7.579	2.362	27	SMP27*
TISU1102F1250-5	1.102	1.138	1.250	1.772	5.713	7.811	2.362	28	SMP28*
TISU1142F1250-5	1.142	1.177	1.250	1.772	5.917	8.028	2.362	29	SMP29*
TISU1181F1250-5	1.181	1.217	1.250	1.772	6.121	8.256	2.362	30	SMP30*
TISU1220F1250-5	1.220	1.256	1.250	1.772	6.324	8.472	2.362	31	SMP31*
TISU1260F1500-5	1.260	1.295	1.500	2.165	6.528	8.898	2.677	32	SMP32*
TISU1299F1500-5	1.299	1.335	1.500	2.165	6.732	9.114	2.677	33	SMP33*
TISU1339F1500-5	1.339	1.374	1.500	2.165	6.937	9.331	2.677	34	SMP34*
TISU1378F1500-5	1.378	1.413	1.500	2.165	7.141	9.563	2.677	35	SMP35*
TISU1417F1500-5	1.417	1.453	1.500	2.165	7.345	9.780	2.677	36	SMP36*
TISU1457F1500-5	1.457	1.492	1.500	2.165	7.548	9.996	2.677	37	SMP37*
TISU1496F1500-5	1.496	1.531	1.500	2.165	7.752	10.232	2.677	38	SMP38*
TISU1535F1500-5	1.535	1.571	1.500	2.165	7.956	10.449	2.677	39	SMP39*
TISU1575F1500-5	1.575	1.614	1.500	2.165	8.161	10.665	2.677	40	SMP40*

Tool diameter	Hole diameter tolerance*
ø1.024 - ø1.177	+0.0030 / 0
ø1.181 - ø1.614	+0.0035 / 0

*Just for reference

SPARE PARTS



Designation	Clamping screw	Torx bit	Wrench	Grip	Screw for side port	Plug*
TISU1024F1250-5	TS50230D3	BLDT20/S7	H-TB2W	H-TB2W	NPTF1/4	SL32IN
TISU1063F1250-5	TS50230D3	BLDT20/S7	H-TB2W	H-TB2W	NPTF1/4	SL32IN
TISU1102F1250-5	TS50250D35	BLDT25/S7	H-TB2W	H-TB2W	NPTF1/4	SL32IN
TISU1142F1250-5	TS50250D35	BLDT25/S7	H-TB2W	H-TB2W	NPTF1/4	SL32IN
TISU1181F1250-5	TS60265D4	BLDT25/S7	H-TB2W	H-TB2W	NPTF1/4	SL32IN
TISU1220F1250-5	TS60265D4	BLDT25/S7	H-TB2W	H-TB2W	NPTF1/4	SL32IN
TISU1260F1500-5	TS60285D42	BLDT25/S7	H-TB2W	H-TB2W	NPTF1/4	SL38IN
TISU1299F1500-5	TS60285D42	BLDT25/S7	H-TB2W	H-TB2W	NPTF1/4	SL38IN
TISU1339F1500-5	TS60285D42	BLDT25/S7	H-TB2W	H-TB2W	NPTF1/4	SL38IN
TISU1378F1500-5	TS60320D5	BLDT25/S7	H-TB2W	H-TB2W	NPTF1/4	SL38IN
TISU1417F1500-5	TS60320D5	BLDT25/S7	H-TB2W	H-TB2W	NPTF1/4	SL38IN
TISU1457F1500-5	TS60320D5	BLDT25/S7	H-TB2W	H-TB2W	NPTF1/4	SL38IN
TISU1496F1500-5	TS80340D6	BLDT25/S7	H-TB2W	H-TB2W	NPTF1/4	SL38IN
TISU1535F1500-5	TS80340D6	BLDT25/S7	H-TB2W	H-TB2W	NPTF1/4	SL38IN
TISU1575F1500-5	TS80340D6	BLDT25/S7	H-TB2W	H-TB2W	NPTF1/4	SL38IN

*Optional part
Inner thread size: NPTF1/4

Recommended clamping torque : TS50230D3= 3.69 lb-ft, 5 N-m, TS50250D35= 4.06 lb-ft, 5.5N-m, TS60265D4= 4.43 lb-ft, 6N-m, TS60285D42= 4.43 lb-ft, 6N-m, TS60320D5= 4.43 lb-ft, 6N-m, TS80340D6= 5.16 lb-ft, 7N-m

Reference pages: Head → **J034 - J035**
Standard cutting conditions → **J035**

DRILL HEAD

SMP

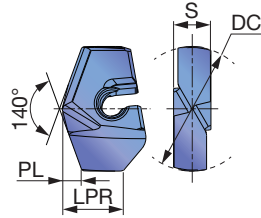
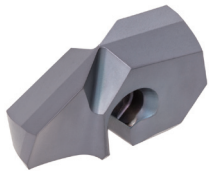

Tool diameter	Head diameter tolerance
ø1.024 - ø1.142	0.0006"
ø1.181 - ø1.575	0.0008"

Material	Symbol	Coated
P Steel	★	
M Stainless	★	
K Cast iron	★	
N Non-ferrous	☆	
S Superalloys	★	
H Hard materials	★	

★ : First choice
☆ : Second choice

Designation	DC (in)	DC (mm)	S (in)	Coated										LPR (in)	PL (in)	Pocket Size	Body				
				AH725																	
SMP260	1.024	26	0.295	●													0.457	0.186	26	TIS260F32-*	
SMP261	1.028	26.1	0.295	●														0.457	0.187	26	TIS260F32-*
SMP265	1.043	26.5	0.295	●														0.457	0.190	26	TIS260F32-*
SMP267	1.051	26.7	0.295	●														0.457	0.191	26	TIS260F32-*
SMP270	1.063	27	0.295	●														0.437	0.193	27	TIS270F32-*
SMP271	1.067	27.1	0.295	●														0.437	0.194	27	TIS270F32-*
SMP272	1.071	27.2	0.295	●														0.437	0.195	27	TIS270F32-*
SMP275	1.083	27.5	0.295	●														0.437	0.197	27	TIS270F32-*
SMP280	1.102	28	0.315	●														0.461	0.201	28	TIS280F32-*
SMP281	1.106	28.1	0.315	●														0.461	0.201	28	TIS280F32-*
SMP285	1.122	28.5	0.315	●														0.461	0.204	28	TIS280F32-*
SMP286	1.126	28.6	0.315	●														0.461	0.205	28	TIS280F32-*
SMP290	1.142	29	0.315	●														0.445	0.208	29	TIS290F32-*
SMP291	1.146	29.1	0.315	●														0.445	0.209	29	TIS290F32-*
SMP295	1.161	29.5	0.315	●														0.445	0.211	29	TIS290F32-*
SMP296	1.165	29.6	0.315	●														0.445	0.212	29	TIS290F32-*
SMP300	1.181	30	0.335	●														0.555	0.215	30	TIS300F32-*
SMP301	1.185	30.1	0.335	●														0.555	0.216	30	TIS300F32-*
SMP302	1.189	30.2	0.335	●														0.555	0.217	30	TIS300F32-*
SMP303	1.193	30.3	0.335	●														0.555	0.217	30	TIS300F32-*
SMP305	1.201	30.5	0.335	●														0.555	0.219	30	TIS300F32-*
SMP308	1.213	30.8	0.335	●														0.555	0.221	30	TIS300F32-*
SMP310	1.220	31	0.335	●														0.539	0.222	31	TIS310F32-*
SMP311	1.224	31.1	0.335	●														0.539	0.223	31	TIS310F32-*
SMP315	1.240	31.5	0.335	●														0.539	0.226	31	TIS310F32-*
SMP318	1.252	31.8	0.335	●														0.539	0.228	31	TIS310F32-*
SMP320	1.260	32	0.354	●														0.571	0.229	32	TIS320F40-*
SMP321	1.264	32.1	0.354	●														0.571	0.230	32	TIS320F40-*
SMP325	1.280	32.5	0.354	●														0.571	0.233	32	TIS320F40-*
SMP328	1.291	32.8	0.354	●														0.571	0.235	32	TIS320F40-*
SMP330	1.299	33	0.354	●														0.555	0.237	33	TIS330F40-*
SMP331	1.303	33.1	0.354	●														0.555	0.237	33	TIS330F40-*
SMP333	1.311	33.3	0.354	●														0.555	0.239	33	TIS330F40-*
SMP335	1.319	33.5	0.354	●														0.555	0.240	33	TIS330F40-*
SMP340	1.339	34	0.354	●														0.539	0.244	34	TIS340F40-*
SMP341	1.343	34.1	0.354	●														0.539	0.244	34	TIS340F40-*
SMP345	1.358	34.5	0.354	●														0.539	0.247	34	TIS340F40-*
SMP349	1.374	34.9	0.354	●														0.539	0.250	34	TIS340F40-*
SMP350	1.378	35	0.394	●														0.654	0.251	35	TIS350F40-*
SMP351	1.382	35.1	0.394	●														0.654	0.252	35	TIS350F40-*
SMP355	1.398	35.5	0.394	●														0.654	0.254	35	TIS350F40-*
SMP360	1.417	36	0.394	●														0.394	0.258	36	TIS360F40-*
SMP361	1.421	36.1	0.394	●														0.394	0.259	36	TIS360F40-*
SMP365	1.437	36.5	0.394	●														0.394	0.261	36	TIS360F40-*
SMP366	1.441	36.6	0.394	●														0.394	0.262	36	TIS360F40-*
SMP370	1.457	37	0.394	●														0.394	0.265	37	TIS370F40-*

● : Line up

P	Steel	★									
M	Stainless	★									
K	Cast iron	★									
N	Non-ferrous	☆									
S	Superalloys	★									
H	Hard materials	★									

★ : First choice
☆ : Second choice

Designation	DC (in)	DC (mm)	S (in)	Coated						LPR (in)	PL (in)	Pocket Size	Body	
				AH725										
SMP371	1.461	37.1	0.394	●							0.394	0.266	37	TIS370F40-*
SMP375	1.476	37.5	0.394	●							0.394	0.269	37	TIS370F40-*
SMP380	1.496	38	0.413	●							0.413	0.272	38	TIS380F40-*
SMP381	1.500	38.1	0.413	●							0.413	0.273	38	TIS380F40-*
SMP385	1.516	38.5	0.413	●							0.413	0.276	38	TIS380F40-*
SMP388	1.528	38.8	0.413	●							0.413	0.278	38	TIS380F40-*
SMP390	1.535	39	0.413	●							0.413	0.280	39	TIS390F40-*
SMP391	1.539	39.1	0.413	●							0.413	0.280	39	TIS390F40-*
SMP395	1.555	39.5	0.413	●							0.413	0.283	39	TIS390F40-*
SMP397	1.563	39.7	0.413	●							0.413	0.284	39	TIS390F40-*
SMP398	1.567	39.8	0.413	●							0.413	0.285	39	TIS390F40-*
SMP400	1.575	40	0.413	●							0.413	0.287	40	TIS400F40-*
SMP401	1.579	40.1	0.413	●							0.413	0.287	40	TIS400F40-*
SMP405	1.594	40.5	0.413	●							0.413	0.290	40	TIS400F40-*
SMP410	1.614	41	0.413	●							0.413	0.294	40	TIS380F40-*

● : Line up

STANDARD CUTTING CONDITIONS

ISO	Workpiece material	Cutting speed Vc (sfm)	Feed: f (ipr)		
			DC (in)		
			1.024" - 1.177"	1.181" - 1.403"	1.417" - 1.614"
P	Low carbon steels 1015, etc.	262 - 459	0.008 - 0.020	0.008 - 0.020	0.010 - 0.022
	Carbon steels, Alloy steels 1055, 4140, etc.	262 - 427	0.008 - 0.020	0.008 - 0.020	0.010 - 0.022
	Prehardened steels NAK80, PX5, etc.	164 - 328	0.008 - 0.020	0.008 - 0.020	0.010 - 0.022
M	Stainless steels S30400, etc.	131 - 262	0.006 - 0.012	0.006 - 0.012	0.008 - 0.014
K	Gray cast irons No.250B, No.300B, etc.	262 - 591	0.010 - 0.022	0.010 - 0.022	0.012 - 0.024
	Ductile cast irons 60-40-15, 80-55-06, etc.	262 - 459	0.010 - 0.022	0.010 - 0.022	0.012 - 0.024
N	Non ferrous materials	328 - 656	0.016 - 0.024	0.016 - 0.024	0.020 - 0.028
S	Heat-resistant alloy Inconel718, etc.	66 - 164	0.004 - 0.008	0.004 - 0.008	0.004 - 0.010
	Titanium alloys Ti-6Al-4V, etc.	98 - 197	0.004 - 0.008	0.004 - 0.008	0.004 - 0.010
H	Hardened materials	66 - 197	0.004 - 0.008	0.004 - 0.008	0.004 - 0.010

Grade
 Insert
 Ext. Toolholder
 Int. Toolholder
 Threading
 Grooving
 Miniature Tool
 Milling Cutter
 Endmill
 Drilling Tool
 Tooling System
 User's Guide
 Index



RECOMMENDED COOLANT PRESSURE AND VOLUME

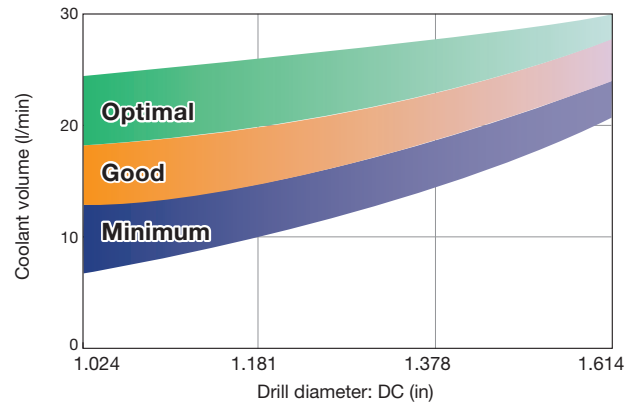
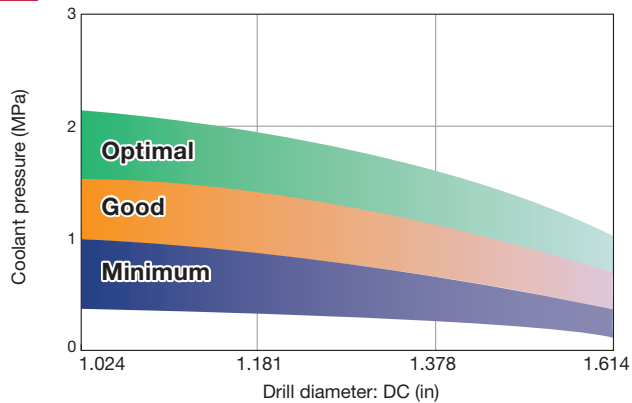

HOW TO CHANGE DRILL HEAD

To unclamp rotate the screw 3-5 times counter-clockwise.

No need to remove the screw from the body.

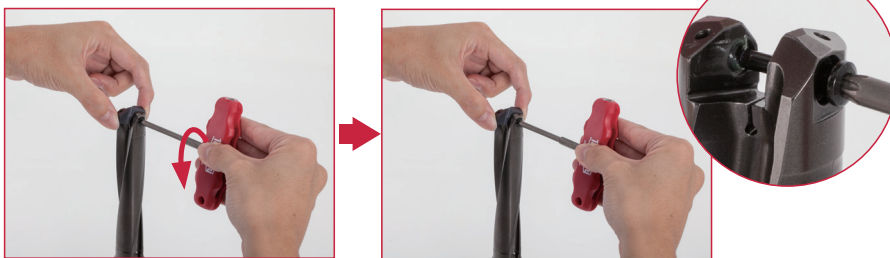

- Please change the screw to new one when the screw does not rotate smoothly

DRILL FÖRCE MEISTER

Regrinding holder

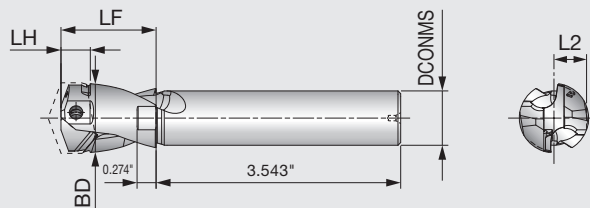

Inch	DCONMS	BD	LF	LH	L2	Head
SMP260-279-GH	0.787	1.004	1.378	0.425	0.472	SMP260 - SMP279
SMP280-299-GH	0.787	1.083	1.378	0.425	0.512	SMP280 - SMP299
SMP300-319-GH	0.787	1.161	1.378	0.512	0.551	SMP300 - SMP319
SMP320-349-GH	0.787	1.240	1.378	0.512	0.591	SMP320 - SMP349
SMP350-379-GH	0.787	1.358	1.575	0.579	0.650	SMP350 - SMP379
SMP380-410-GH	0.787	1.476	1.575	0.594	0.709	SMP380 - SMP410

1 Clamping

- Assemble the drill head on the regrinding holder or shortest standard holder (3xD)
- Set-up the drill head in the machine : Total run-out must be less than 0.0008"

2 Grinding the 1st clearance angle

- Set the drill for point angle (140°) and 1st clearance angle (8°)

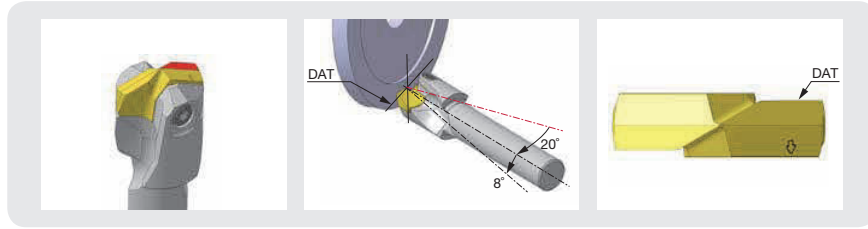

3 Grinding the 2nd clearance angle

- Set the drill for 2nd clearance angle (15°)

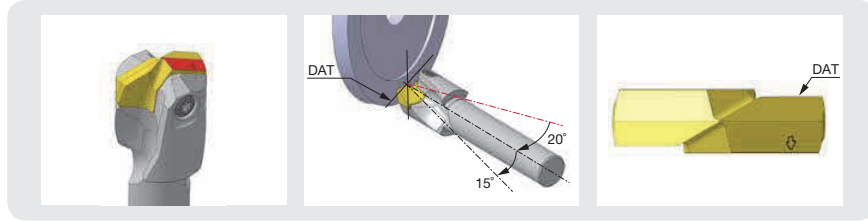

4 Grinding the chisel (Thinning)

- Set the drill for thinning angle (35°) with reference to drill axis and angle (30°) with reference to radial axis
- Keep the chisel thickness (0.0055" - 0.0079") and the thinning point must be over the center line

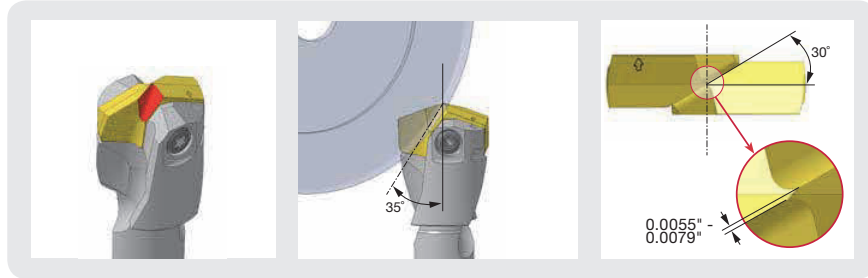

5 Edge preparation (Honing)

- Cutting edges should have honing by sand or brush (0.0016" - 0.0024")
- You can also use a diamond hand lapper for edge preparation

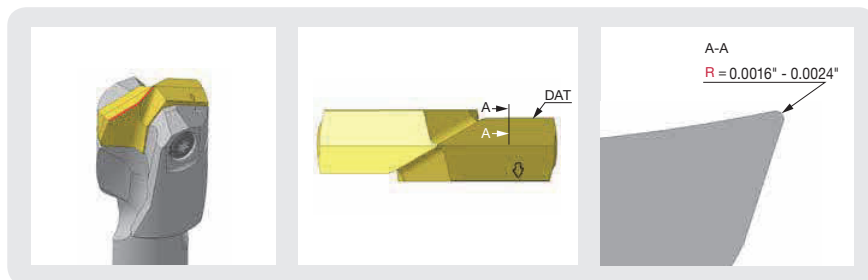

Grade

Insert

Ext. Toolholder

Int. Toolholder

Threading

Grooving

Miniature Tool

Milling Cutter

Endmill

Drilling Tool

Tooling System

User's Guide

Index

SOLIDDRILL Quick Guide



Series	DC	L/D	Point angle	Oil hole	Coated	Coated without	Description	P	M	K	N	S	H	See page
								Steel	Stainless	Cast iron	Non-ferrous	Superalloys	Hard materials	
DSW	ø3 mm - ø12 mm	3, 5, 8	140	With Without	●		Shank size: DIN Standard	●	●	●	●	●	●	J039 - J045
DSXU DSX	13/64" - 21/32" (ø3 mm - ø10 mm)	3, 5, 8	130	With	●		Shank size: 1 mm increments	●	●	●	●	●	●	J046 - J050
DSE	ø3 mm - ø10 mm	2, 3	140	Without	●		For drilling thin plates with low cutting force Shank size: Same as the drill diameter	●	●	●	●	●	●	J051 - J053
DSM DSM-CP	ø0.1 mm - ø3 mm	5, 10, 15	140 90 & 140	Without	●		Micro solid drill with ø3 mm shanks DSM-CP: Centering drill for DSM	●	●	●	●	●	●	J054 - J056
DMXU	#34" - 25/32"	2, 3	130	Without	●		Shank size: Same as the drill diameter	●	●	●	●	●	●	J057 - J059
FDCU FDC	ø0.203" - ø0.625" (ø5 mm - ø16 mm)	5, 8	135	With		●	Drills for reaming at high feed with straight flute			●	●			J060 - J061

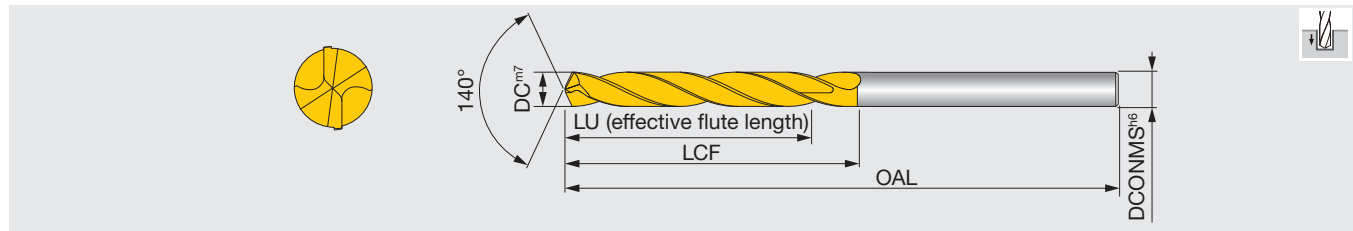

Metric	DC	AH725	DCONMS	LU	LCF	OAL	Metric	DC	AH725	DCONMS	LU	LCF	OAL
DSW030-014-06DE3	3	●	6	14	20	62	DSW076-029-08DE3	7.6	●	8	29	41	79
DSW031-014-06DE3	3.1	●	6	14	20	62	DSW077-029-08DE3	7.7	●	8	29	41	79
DSW032-014-06DE3	3.2	●	6	14	20	62	DSW078-029-08DE3	7.8	●	8	29	41	79
DSW033-014-06DE3	3.3	●	6	14	20	62	DSW079-029-08DE3	7.9	●	8	29	41	79
DSW034-014-06DE3	3.4	●	6	14	20	62	DSW080-029-08DE3	8	●	8	29	41	79
DSW035-014-06DE3	3.5	●	6	14	20	62	DSW081-035-10DE3	8.1	●	10	35	47	89
DSW036-014-06DE3	3.6	●	6	14	20	62	DSW082-035-10DE3	8.2	●	10	35	47	89
DSW037-014-06DE3	3.7	●	6	14	20	62	DSW083-035-10DE3	8.3	●	10	35	47	89
DSW038-017-06DE3	3.8	●	6	17	24	66	DSW084-035-10DE3	8.4	●	10	35	47	89
DSW039-017-06DE3	3.9	●	6	17	24	66	DSW085-035-10DE3	8.5	●	10	35	47	89
DSW040-017-06DE3	4	●	6	17	24	66	DSW086-035-10DE3	8.6	●	10	35	47	89
DSW041-017-06DE3	4.1	●	6	17	24	66	DSW087-035-10DE3	8.7	●	10	35	47	89
DSW042-017-06DE3	4.2	●	6	17	24	66	DSW088-035-10DE3	8.8	●	10	35	47	89
DSW043-017-06DE3	4.3	●	6	17	24	66	DSW089-035-10DE3	8.9	●	10	35	47	89
DSW044-017-06DE3	4.4	●	6	17	24	66	DSW090-035-10DE3	9	●	10	35	47	89
DSW045-017-06DE3	4.5	●	6	17	24	66	DSW091-035-10DE3	9.1	●	10	35	47	89
DSW046-017-06DE3	4.6	●	6	17	24	66	DSW092-035-10DE3	9.2	●	10	35	47	89
DSW047-017-06DE3	4.7	●	6	17	24	66	DSW093-035-10DE3	9.3	●	10	35	47	89
DSW048-020-06DE3	4.8	●	6	20	28	66	DSW094-035-10DE3	9.4	●	10	35	47	89
DSW049-020-06DE3	4.9	●	6	20	28	66	DSW095-035-10DE3	9.5	●	10	35	47	89
DSW050-020-06DE3	5	●	6	20	28	66	DSW096-035-10DE3	9.6	●	10	35	47	89
DSW051-020-06DE3	5.1	●	6	20	28	66	DSW097-035-10DE3	9.7	●	10	35	47	89
DSW052-020-06DE3	5.2	●	6	20	28	66	DSW098-035-10DE3	9.8	●	10	35	47	89
DSW053-020-06DE3	5.3	●	6	20	28	66	DSW099-035-10DE3	9.9	●	10	35	47	89
DSW054-020-06DE3	5.4	●	6	20	28	66	DSW100-035-10DE3	10	●	10	35	47	89
DSW055-020-06DE3	5.5	●	6	20	28	66	DSW101-040-12DE3	10.1	●	12	40	55	102
DSW056-020-06DE3	5.6	●	6	20	28	66	DSW102-040-12DE3	10.2	●	12	40	55	102
DSW057-020-06DE3	5.7	●	6	20	28	66	DSW103-040-12DE3	10.3	●	12	40	55	102
DSW058-020-06DE3	5.8	●	6	20	28	66	DSW104-040-12DE3	10.4	●	12	40	55	102
DSW059-020-06DE3	5.9	●	6	20	28	66	DSW105-040-12DE3	10.5	●	12	40	55	102
DSW060-020-06DE3	6	●	6	20	28	66	DSW106-040-12DE3	10.6	●	12	40	55	102
DSW061-024-08DE3	6.1	●	8	24	34	79	DSW107-040-12DE3	10.7	●	12	40	55	102
DSW062-024-08DE3	6.2	●	8	24	34	79	DSW108-040-12DE3	10.8	●	12	40	55	102
DSW063-024-08DE3	6.3	●	8	24	34	79	DSW109-040-12DE3	10.9	●	12	40	55	102
DSW064-024-08DE3	6.4	●	8	24	34	79	DSW110-040-12DE3	11	●	12	40	55	102
DSW065-024-08DE3	6.5	●	8	24	34	79	DSW111-040-12DE3	11.1	●	12	40	55	102
DSW066-024-08DE3	6.6	●	8	24	34	79	DSW112-040-12DE3	11.2	●	12	40	55	102
DSW067-024-08DE3	6.7	●	8	24	34	79	DSW113-040-12DE3	11.3	●	12	40	55	102
DSW068-024-08DE3	6.8	●	8	24	34	79	DSW114-040-12DE3	11.4	●	12	40	55	102
DSW069-024-08DE3	6.9	●	8	24	34	79	DSW115-040-12DE3	11.5	●	12	40	55	102
DSW070-024-08DE3	7	●	8	24	34	79	DSW116-040-12DE3	11.6	●	12	40	55	102
DSW071-029-08DE3	7.1	●	8	29	41	79	DSW117-040-12DE3	11.7	●	12	40	55	102
DSW072-029-08DE3	7.2	●	8	29	41	79	DSW118-040-12DE3	11.8	●	12	40	55	102
DSW073-029-08DE3	7.3	●	8	29	41	79	DSW119-040-12DE3	11.9	●	12	40	55	102
DSW074-029-08DE3	7.4	●	8	29	41	79	DSW120-040-12DE3	12	●	12	40	55	102
DSW075-029-08DE3	7.5	●	8	29	41	79							

● : Line up



SOLIDDRILL

DSW-DE5

Solid drill, 140° point angle, without coolant hole, DIN shank, L/D = 5, ø3 - ø12 mm

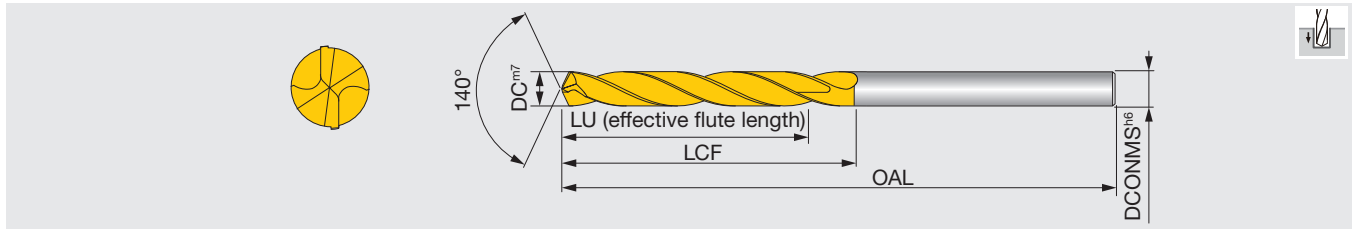

Metric	DC	AH725	DCONMS	LU	LCF	OAL	Metric	DC	AH725	DCONMS	LU	LCF	OAL
DSW030-023-06DE5	3	●	6	23	28	66	DSW076-043-08DE5	7.6	●	8	43	53	91
DSW031-023-06DE5	3.1	●	6	23	28	66	DSW077-043-08DE5	7.7	●	8	43	53	91
DSW032-023-06DE5	3.2	●	6	23	28	66	DSW078-043-08DE5	7.8	●	8	43	53	91
DSW033-023-06DE5	3.3	●	6	23	28	66	DSW079-043-08DE5	7.9	●	8	43	53	91
DSW034-023-06DE5	3.4	●	6	23	28	66	DSW080-043-08DE5	8	●	8	43	53	91
DSW035-023-06DE5	3.5	●	6	23	28	66	DSW081-049-10DE5	8.1	●	10	49	61	103
DSW036-023-06DE5	3.6	●	6	23	28	66	DSW082-049-10DE5	8.2	●	10	49	61	103
DSW037-023-06DE5	3.7	●	6	23	28	66	DSW083-049-10DE5	8.3	●	10	49	61	103
DSW038-029-06DE5	3.8	●	6	29	36	74	DSW084-049-10DE5	8.4	●	10	49	61	103
DSW039-029-06DE5	3.9	●	6	29	36	74	DSW085-049-10DE5	8.5	●	10	49	61	103
DSW040-029-06DE5	4	●	6	29	36	74	DSW086-049-10DE5	8.6	●	10	49	61	103
DSW041-029-06DE5	4.1	●	6	29	36	74	DSW087-049-10DE5	8.7	●	10	49	61	103
DSW042-029-06DE5	4.2	●	6	29	36	74	DSW088-049-10DE5	8.8	●	10	49	61	103
DSW043-029-06DE5	4.3	●	6	29	36	74	DSW089-049-10DE5	8.9	●	10	49	61	103
DSW044-029-06DE5	4.4	●	6	29	36	74	DSW090-049-10DE5	9	●	10	49	61	103
DSW045-029-06DE5	4.5	●	6	29	36	74	DSW091-049-10DE5	9.1	●	10	49	61	103
DSW046-029-06DE5	4.6	●	6	29	36	74	DSW092-049-10DE5	9.2	●	10	49	61	103
DSW047-029-06DE5	4.7	●	6	29	36	74	DSW093-049-10DE5	9.3	●	10	49	61	103
DSW048-035-06DE5	4.8	●	6	35	44	82	DSW094-049-10DE5	9.4	●	10	49	61	103
DSW049-035-06DE5	4.9	●	6	35	44	82	DSW095-049-10DE5	9.5	●	10	49	61	103
DSW050-035-06DE5	5	●	6	35	44	82	DSW096-049-10DE5	9.6	●	10	49	61	103
DSW051-035-06DE5	5.1	●	6	35	44	82	DSW097-049-10DE5	9.7	●	10	49	61	103
DSW052-035-06DE5	5.2	●	6	35	44	82	DSW098-049-10DE5	9.8	●	10	49	61	103
DSW053-035-06DE5	5.3	●	6	35	44	82	DSW099-049-10DE5	9.9	●	10	49	61	103
DSW054-035-06DE5	5.4	●	6	35	44	82	DSW100-049-10DE5	10	●	10	49	61	103
DSW055-035-06DE5	5.5	●	6	35	44	82	DSW101-056-12DE5	10.1	●	12	56	71	118
DSW056-035-06DE5	5.6	●	6	35	44	82	DSW102-056-12DE5	10.2	●	12	56	71	118
DSW057-035-06DE5	5.7	●	6	35	44	82	DSW103-056-12DE5	10.3	●	12	56	71	118
DSW058-035-06DE5	5.8	●	6	35	44	82	DSW104-056-12DE5	10.4	●	12	56	71	118
DSW059-035-06DE5	5.9	●	6	35	44	82	DSW105-056-12DE5	10.5	●	12	56	71	118
DSW060-035-06DE5	6	●	6	35	44	82	DSW106-056-12DE5	10.6	●	12	56	71	118
DSW061-043-08DE5	6.1	●	8	43	53	91	DSW107-056-12DE5	10.7	●	12	56	71	118
DSW062-043-08DE5	6.2	●	8	43	53	91	DSW108-056-12DE5	10.8	●	12	56	71	118
DSW063-043-08DE5	6.3	●	8	43	53	91	DSW109-056-12DE5	10.9	●	12	56	71	118
DSW064-043-08DE5	6.4	●	8	43	53	91	DSW110-056-12DE5	11	●	12	56	71	118
DSW065-043-08DE5	6.5	●	8	43	53	91	DSW111-056-12DE5	11.1	●	12	56	71	118
DSW066-043-08DE5	6.6	●	8	43	53	91	DSW112-056-12DE5	11.2	●	12	56	71	118
DSW067-043-08DE5	6.7	●	8	43	53	91	DSW113-056-12DE5	11.3	●	12	56	71	118
DSW068-043-08DE5	6.8	●	8	43	53	91	DSW114-056-12DE5	11.4	●	12	56	71	118
DSW069-043-08DE5	6.9	●	8	43	53	91	DSW115-056-12DE5	11.5	●	12	56	71	118
DSW070-043-08DE5	7	●	8	43	53	91	DSW116-056-12DE5	11.6	●	12	56	71	118
DSW071-043-08DE5	7.1	●	8	43	53	91	DSW117-056-12DE5	11.7	●	12	56	71	118
DSW072-043-08DE5	7.2	●	8	43	53	91	DSW118-056-12DE5	11.8	●	12	56	71	118
DSW073-043-08DE5	7.3	●	8	43	53	91	DSW119-056-12DE5	11.9	●	12	56	71	118
DSW074-043-08DE5	7.4	●	8	43	53	91	DSW120-056-12DE5	12	●	12	56	71	118
DSW075-043-08DE5	7.5	●	8	43	53	91							

● : Line up

Reference pages: Standard cutting conditions → J044

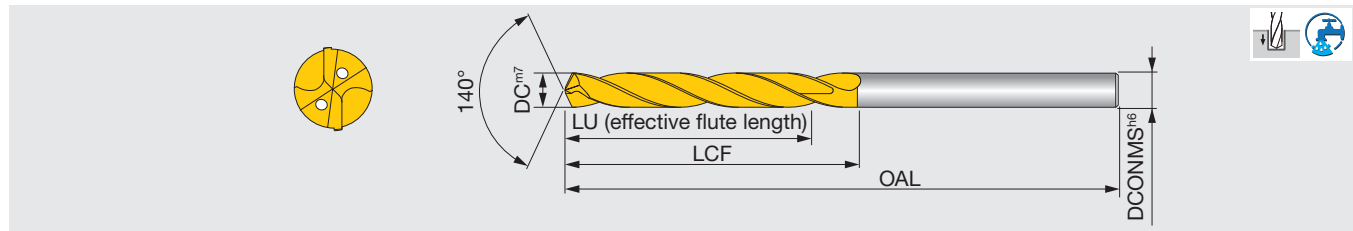

Metric	DC	AH725	DCONMS	LU	LCF	OAL	Metric	DC	AH725	DCONMS	LU	LCF	OAL
DSW030-023-06DI5	3	●	6	23	28	66	DSW076-043-08DI5	7.6	●	8	43	53	91
DSW031-023-06DI5	3.1	●	6	23	28	66	DSW077-043-08DI5	7.7	●	8	43	53	91
DSW032-023-06DI5	3.2	●	6	23	28	66	DSW078-043-08DI5	7.8	●	8	43	53	91
DSW033-023-06DI5	3.3	●	6	23	28	66	DSW079-043-08DI5	7.9	●	8	43	53	91
DSW034-023-06DI5	3.4	●	6	23	28	66	DSW080-043-08DI5	8	●	8	43	53	91
DSW035-023-06DI5	3.5	●	6	23	28	66	DSW081-049-10DI5	8.1	●	10	49	61	103
DSW036-023-06DI5	3.6	●	6	23	28	66	DSW082-049-10DI5	8.2	●	10	49	61	103
DSW037-023-06DI5	3.7	●	6	23	28	66	DSW083-049-10DI5	8.3	●	10	49	61	103
DSW038-029-06DI5	3.8	●	6	29	36	74	DSW084-049-10DI5	8.4	●	10	49	61	103
DSW039-029-06DI5	3.9	●	6	29	36	74	DSW085-049-10DI5	8.5	●	10	49	61	103
DSW040-029-06DI5	4	●	6	29	36	74	DSW086-049-10DI5	8.6	●	10	49	61	103
DSW041-029-06DI5	4.1	●	6	29	36	74	DSW087-049-10DI5	8.7	●	10	49	61	103
DSW042-029-06DI5	4.2	●	6	29	36	74	DSW088-049-10DI5	8.8	●	10	49	61	103
DSW043-029-06DI5	4.3	●	6	29	36	74	DSW089-049-10DI5	8.9	●	10	49	61	103
DSW044-029-06DI5	4.4	●	6	29	36	74	DSW090-049-10DI5	9	●	10	49	61	103
DSW045-029-06DI5	4.5	●	6	29	36	74	DSW091-049-10DI5	9.1	●	10	49	61	103
DSW046-029-06DI5	4.6	●	6	29	36	74	DSW092-049-10DI5	9.2	●	10	49	61	103
DSW047-029-06DI5	4.7	●	6	29	36	74	DSW093-049-10DI5	9.3	●	10	49	61	103
DSW048-035-06DI5	4.8	●	6	35	44	82	DSW094-049-10DI5	9.4	●	10	49	61	103
DSW049-035-06DI5	4.9	●	6	35	44	82	DSW095-049-10DI5	9.5	●	10	49	61	103
DSW050-035-06DI5	5	●	6	35	44	82	DSW096-049-10DI5	9.6	●	10	49	61	103
DSW051-035-06DI5	5.1	●	6	35	44	82	DSW097-049-10DI5	9.7	●	10	49	61	103
DSW052-035-06DI5	5.2	●	6	35	44	82	DSW098-049-10DI5	9.8	●	10	49	61	103
DSW053-035-06DI5	5.3	●	6	35	44	82	DSW099-049-10DI5	9.9	●	10	49	61	103
DSW054-035-06DI5	5.4	●	6	35	44	82	DSW100-049-10DI5	10	●	10	49	61	103
DSW055-035-06DI5	5.5	●	6	35	44	82	DSW101-056-12DI5	10.1	●	12	56	71	118
DSW056-035-06DI5	5.6	●	6	35	44	82	DSW102-056-12DI5	10.2	●	12	56	71	118
DSW057-035-06DI5	5.7	●	6	35	44	82	DSW103-056-12DI5	10.3	●	12	56	71	118
DSW058-035-06DI5	5.8	●	6	35	44	82	DSW104-056-12DI5	10.4	●	12	56	71	118
DSW059-035-06DI5	5.9	●	6	35	44	82	DSW105-056-12DI5	10.5	●	12	56	71	118
DSW060-035-06DI5	6	●	6	35	44	82	DSW106-056-12DI5	10.6	●	12	56	71	118
DSW061-043-08DI5	6.1	●	8	43	53	91	DSW107-056-12DI5	10.7	●	12	56	71	118
DSW062-043-08DI5	6.2	●	8	43	53	91	DSW108-056-12DI5	10.8	●	12	56	71	118
DSW063-043-08DI5	6.3	●	8	43	53	91	DSW109-056-12DI5	10.9	●	12	56	71	118
DSW064-043-08DI5	6.4	●	8	43	53	91	DSW110-056-12DI5	11	●	12	56	71	118
DSW065-043-08DI5	6.5	●	8	43	53	91	DSW111-056-12DI5	11.1	●	12	56	71	118
DSW066-043-08DI5	6.6	●	8	43	53	91	DSW112-056-12DI5	11.2	●	12	56	71	118
DSW067-043-08DI5	6.7	●	8	43	53	91	DSW113-056-12DI5	11.3	●	12	56	71	118
DSW068-043-08DI5	6.8	●	8	43	53	91	DSW114-056-12DI5	11.4	●	12	56	71	118
DSW069-043-08DI5	6.9	●	8	43	53	91	DSW115-056-12DI5	11.5	●	12	56	71	118
DSW070-043-08DI5	7	●	8	43	53	91	DSW116-056-12DI5	11.6	●	12	56	71	118
DSW071-043-08DI5	7.1	●	8	43	53	91	DSW117-056-12DI5	11.7	●	12	56	71	118
DSW072-043-08DI5	7.2	●	8	43	53	91	DSW118-056-12DI5	11.8	●	12	56	71	118
DSW073-043-08DI5	7.3	●	8	43	53	91	DSW119-056-12DI5	11.9	●	12	56	71	118
DSW074-043-08DI5	7.4	●	8	43	53	91	DSW120-056-12DI5	12	●	12	56	71	118
DSW075-043-08DI5	7.5	●	8	43	53	91							

● : Line up

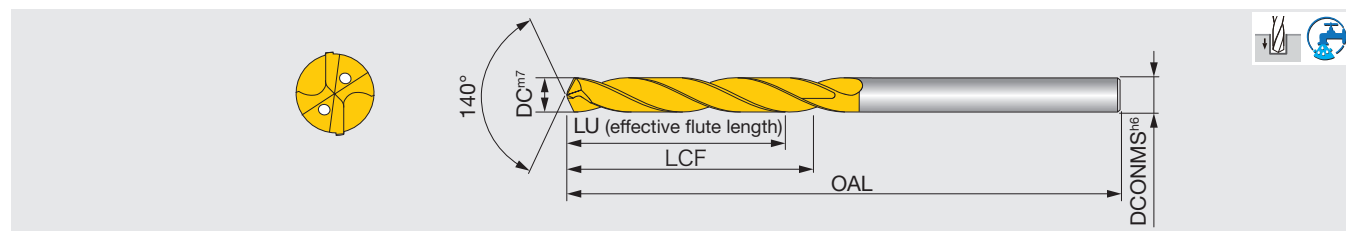

Metric	DC	AH725	DCONMS	LU	LCF	OAL	Metric	DC	AH725	DCONMS	LU	LCF	OAL
DSW030-029-06DI8	3	●	6	29	34	72	DSW076-064-08DI8	7.6	●	8	64	76	114
DSW031-029-06DI8	3.1	●	6	29	34	72	DSW077-064-08DI8	7.7	●	8	64	76	114
DSW032-029-06DI8	3.2	●	6	29	34	72	DSW078-064-08DI8	7.8	●	8	64	76	114
DSW033-029-06DI8	3.3	●	6	29	34	72	DSW079-064-08DI8	7.9	●	8	64	76	114
DSW034-029-06DI8	3.4	●	6	29	34	72	DSW080-064-08DI8	8	●	8	64	76	114
DSW035-029-06DI8	3.5	●	6	29	34	72	DSW081-080-10DI8	8.1	●	10	80	95	142
DSW036-029-06DI8	3.6	●	6	29	34	72	DSW082-080-10DI8	8.2	●	10	80	95	142
DSW037-029-06DI8	3.7	●	6	29	34	72	DSW083-080-10DI8	8.3	●	10	80	95	142
DSW038-036-06DI8	3.8	●	6	36	43	81	DSW084-080-10DI8	8.4	●	10	80	95	142
DSW039-036-06DI8	3.9	●	6	36	43	81	DSW085-080-10DI8	8.5	●	10	80	95	142
DSW040-036-06DI8	4	●	6	36	43	81	DSW086-080-10DI8	8.6	●	10	80	95	142
DSW041-036-06DI8	4.1	●	6	36	43	81	DSW087-080-10DI8	8.7	●	10	80	95	142
DSW042-036-06DI8	4.2	●	6	36	43	81	DSW088-080-10DI8	8.8	●	10	80	95	142
DSW043-036-06DI8	4.3	●	6	36	43	81	DSW089-080-10DI8	8.9	●	10	80	95	142
DSW044-036-06DI8	4.4	●	6	36	43	81	DSW090-080-10DI8	9	●	10	80	95	142
DSW045-036-06DI8	4.5	●	6	36	43	81	DSW091-080-10DI8	9.1	●	10	80	95	142
DSW046-036-06DI8	4.6	●	6	36	43	81	DSW092-080-10DI8	9.2	●	10	80	95	142
DSW047-036-06DI8	4.7	●	6	36	43	81	DSW093-080-10DI8	9.3	●	10	80	95	142
DSW048-048-06DI8	4.8	●	6	48	57	95	DSW094-080-10DI8	9.4	●	10	80	95	142
DSW049-048-06DI8	4.9	●	6	48	57	95	DSW095-080-10DI8	9.5	●	10	80	95	142
DSW050-048-06DI8	5	●	6	48	57	95	DSW096-080-10DI8	9.6	●	10	80	95	142
DSW051-048-06DI8	5.1	●	6	48	57	95	DSW097-080-10DI8	9.7	●	10	80	95	142
DSW052-048-06DI8	5.2	●	6	48	57	95	DSW098-080-10DI8	9.8	●	10	80	95	142
DSW053-048-06DI8	5.3	●	6	48	57	95	DSW099-080-10DI8	9.9	●	10	80	95	142
DSW054-048-06DI8	5.4	●	6	48	57	95	DSW100-080-10DI8	10	●	10	80	95	142
DSW055-048-06DI8	5.5	●	6	48	57	95							
DSW056-048-06DI8	5.6	●	6	48	57	95							
DSW057-048-06DI8	5.7	●	6	48	57	95							
DSW058-048-06DI8	5.8	●	6	48	57	95							
DSW059-048-06DI8	5.9	●	6	48	57	95							
DSW060-048-06DI8	6	●	6	48	57	95							
DSW061-064-08DI8	6.1	●	8	64	76	114							
DSW062-064-08DI8	6.2	●	8	64	76	114							
DSW063-064-08DI8	6.3	●	8	64	76	114							
DSW064-064-08DI8	6.4	●	8	64	76	114							
DSW065-064-08DI8	6.5	●	8	64	76	114							
DSW066-064-08DI8	6.6	●	8	64	76	114							
DSW067-064-08DI8	6.7	●	8	64	76	114							
DSW068-064-08DI8	6.8	●	8	64	76	114							
DSW069-064-08DI8	6.9	●	8	64	76	114							
DSW070-064-08DI8	7	●	8	64	76	114							
DSW071-064-08DI8	7.1	●	8	64	76	114							
DSW072-064-08DI8	7.2	●	8	64	76	114							
DSW073-064-08DI8	7.3	●	8	64	76	114							
DSW074-064-08DI8	7.4	●	8	64	76	114							
DSW075-064-08DI8	7.5	●	8	64	76	114							

● : Line up

Reference pages: Standard cutting conditions → **J045**

Recommended coolant pressure and volume for internal coolant supply:

The following graph is a reference guide for pressure and volume. Values should be adjusted according to work material and actual chip evacuation.

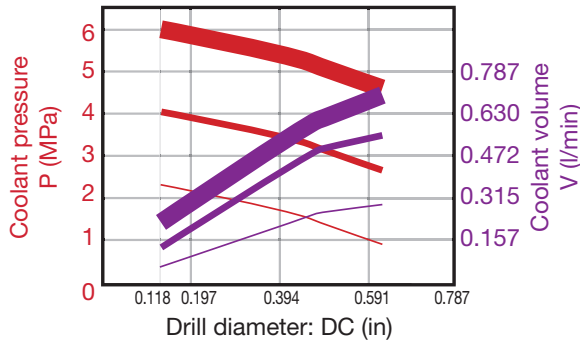

- : Ideal pressure
- : Enough pressure
- : Minimum pressure
- : Ideal volume
- : Enough volume
- : Minimum volume

Reference for required spindle power:

The required spindle power may vary depending on the type of work material or hardness. A spindle with sufficient power should be used when referring to the below graph.

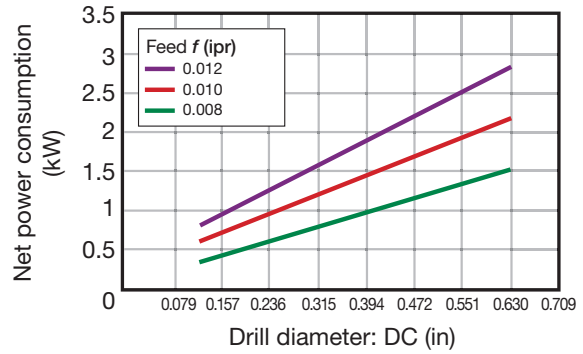

Work material : Alloy steel (SNCM439)
Cutting speed : $V_c = 328$ sfm

Designation system

DSW 088 - 035 - 10 - D E 3

1 Series	
DSW	Series name of solid drill

2 Drill diameter DC (mm)	
088	ø8.8

3 Effective flute length LU (mm)	
035	35

4 Shank diameter DCONMS (mm)	
10	ø10

5 DIN 6535 - Form HA	
----------------------	--

6 Coolant Supply	
E	External (without coolant hole)
I	Internal (with coolant hole)

7 Drilling depth	
Approximate value of L/D ratio.	
Caution: Code may be different from the actual length. This is dependent upon the tool diameter.	

Caution: "Effective flute length" shows the maximum flute length for effective chip evacuation. The actual drilling depth may be shorter than described depending on the work material or cutting conditions.

STANDARD CUTTING CONDITIONS

DSW-DE (External supply)

ISO	Workpiece material	Brinell hardness (HB)	Cutting speed: Vc (sfm)			Feed: f (ipr)		
			∅0.118 ~ ∅0.236	∅0.236 ~ ∅0.394	∅0.394 ~ ∅0.630	∅0.118 ~ ∅0.236	∅0.236 ~ ∅0.394	∅0.394 ~ ∅0.630
P	Low carbon steels (C < 0.3) 1018, 1020, 1026, etc.	~ 180	131 - 328	197 - 394	197 - 427	0.006 - 0.012	0.006 - 0.014	0.008 - 0.020
	Carbon steels (C > 0.3) 1045, 1055, etc.	180 ~ 300	131 - 295	164 - 394	197 - 427	0.006 - 0.012	0.006 - 0.014	0.008 - 0.016
	High alloy steels 4140, 8620, etc.	250 ~ 350	131 - 262	164 - 328	164 - 328	0.004 - 0.008	0.006 - 0.012	0.006 - 0.014
M	Stainless steels 304SS, 316SS, 17-4 PH, etc.	~ 200	66 - 131	98 - 164	98 - 197	0.002 - 0.008	0.004 - 0.010	0.004 - 0.012
K	Gray cast irons Class 25, Class 30, etc.	~ 200	131 - 295	164 - 312	164 - 328	0.006 - 0.012	0.008 - 0.016	0.008 - 0.020
	Ductile cast irons 65-40-18, 60-55-06, etc.	~ 300	98 - 262	131 - 295	148 - 295	0.004 - 0.012	0.008 - 0.016	0.008 - 0.016
N	Aluminum alloys 6061, 7075, etc.	-	131 - 295	164 - 328	164 - 328	0.006 - 0.012	0.008 - 0.016	0.008 - 0.020
S	Titanium alloys Ti-6Al-4V, etc	-	66 - 131	66 - 131	66 - 131	0.004 - 0.008	0.006 - 0.010	0.006 - 0.016
	Heat-resistant alloys, Inconel Inconel 718, etc.	250 ~	33 - 98	33 - 98	33 - 98	0.001 - 0.003	0.002 - 0.004	0.003 - 0.005
H	High hardened steels	~ 40HRC	66 - 131	66 - 131	66 - 131	0.002 - 0.006	0.002 - 0.006	0.002 - 0.008

The cutting parameters shown in the table are merely a starting guideline for general machining. Values should be varied depending on the power or rigidity of the machine to be used. Optimum conditions should be selected depending on the actual chip control or damage on edges. When using the smaller diameter tools in each range, set the feed "f" to the lower recommended values.

The coolant supply is critical for the provision of stable machining conditions and enhanced tool life. A large coolant volume should be supplied, especially when drilling difficult-to-cut materials. When drilling stainless steel with low machinability such as austenitic stainless steel with a depth deeper than L/D = 3, a pecking cycle or internal coolant supply is recommended.

DSW-DI (Internal supply)

ISO	Workpiece material	Brinell hardness (HB)	Cutting speed: Vc (sfm)			Feed: f (ipr)		
			∅0.118 ~ ∅0.236	∅0.236 ~ ∅0.394	∅0.394 ~ ∅0.630	∅0.118 ~ ∅0.236	∅0.236 ~ ∅0.394	∅0.394 ~ ∅0.630
P	Low carbon steels (C < 0.3) 1018, 1020, 1026, etc.	~ 180	230 - 459	262 - 525	295 - 623	0.006 - 0.012	0.006 - 0.014	0.008 - 0.020
	Carbon steels (C > 0.3) 1045, 1055, etc.	180 ~ 300	164 - 427	230 - 525	262 - 558	0.006 - 0.012	0.006 - 0.014	0.008 - 0.016
	High alloy steels 4140, 8620, etc.	250 ~ 350	131 - 328	197 - 459	197 - 525	0.004 - 0.008	0.006 - 0.012	0.006 - 0.014
M	Stainless steels 304SS, 316SS, 17-4 PH, etc.	~ 200	82 - 246	164 - 328	164 - 394	0.002 - 0.008	0.004 - 0.010	0.004 - 0.012
K	Gray cast irons Class 25, Class 30, etc.	~ 200	262 - 459	328 - 525	328 - 591	0.006 - 0.012	0.008 - 0.016	0.008 - 0.020
	Ductile cast irons 65-40-18, 60-55-06, etc.	~ 300	230 - 459	262 - 492	262 - 558	0.004 - 0.012	0.008 - 0.016	0.008 - 0.018
N	Aluminum alloys 6061, 7075, etc.	-	197 - 656	197 - 656	197 - 656	0.006 - 0.012	0.008 - 0.016	0.008 - 0.020
S	Titanium alloys Ti-6Al-4V, etc	-	66 - 197	98 - 262	98 - 262	0.004 - 0.008	0.004 - 0.010	0.006 - 0.016
	Heat-resistant alloys, Inconel Inconel 718, etc.	250 ~	33 - 98	33 - 131	33 - 131	0.001 - 0.003	0.002 - 0.004	0.003 - 0.006
H	High hardened steels	~ 40HRC	66 - 164	98 - 197	98 - 197	0.002 - 0.006	0.002 - 0.006	0.002 - 0.008

The cutting parameters shown in the table are merely a starting guideline for general machining. Values should be varied depending on the power or rigidity of the machine to be used. Optimum conditions should be selected depending on the actual chip control or damage on edges.

When using the smaller diameter tools in each range, set the feed “f” to the lower recommended values.

Oil holes that become blocked may cause drill breakages. A filter to prevent the circulation of chips must be used on the coolant supply system.

Grade
Insert
Ext. Toolholder
Int. Toolholder
Threading
Grooving
Miniature Tool
Milling Cutter
Endmill
Drilling Tool
Tooling System
User's Guide
Index



GIGAJETDRILL

DSXU-F03, F05

Solid drill, 140° point angle, with coolant hole, L/D = 3, 5, 8, $\phi 0.125'' - \phi 0.781''$

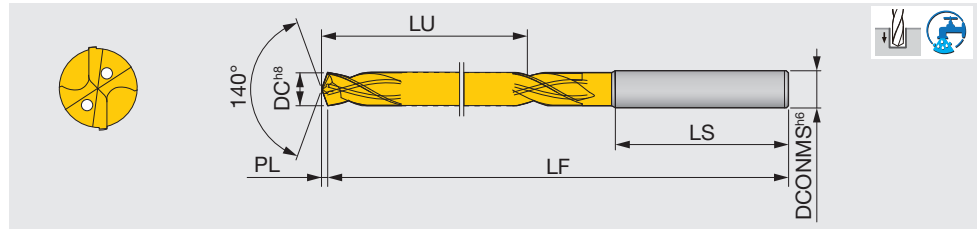

L/D = 3

Inch	DC	AH180	DCONMS	LU	LS	LF	PL
DSXU2031F03	13/64	●	0.203	1.137	2.050	3.230	0.037
DSXU2344F03	15/64	●	0.234	1.223	2.050	3.230	0.043
DSXU2500F03	1/4	●	0.25	1.345	2.090	3.390	0.045
DSXU2656F03	17/64	●	0.266	1.428	2.090	3.460	0.048
DSXU2813F03	9/32	●	0.281	1.551	2.130	3.620	0.051
DSXU3125F03	5/16	●	0.313	1.627	2.130	3.700	0.057
DSXU3438F03	11/32	●	0.344	1.833	2.170	3.940	0.063
DSXU3750F03	3/8	●	0.375	2.038	2.200	4.170	0.068
DSXU3906F03	25/64	●	0.391	2.041	2.200	4.170	0.071
DSXU4063F03	13/32	●	0.406	2.164	2.400	4.570	0.074
DSXU4219F03	27/64	●	0.422	2.247	2.400	4.570	0.077
DSXU4375F03	7/16	●	0.438	2.360	2.440	4.800	0.080
DSXU4531F03	29/64	●	0.453	2.442	2.440	4.800	0.082
DSXU4688F03	15/32	●	0.469	2.445	2.440	4.800	0.085
DSXU4844F03	31/64	●	0.484	2.648	2.480	5.040	0.088
DSXU5000F03	1/2	●	0.500	2.651	2.480	5.040	0.091
DSXU5156F03	33/64	●	0.516	2.854	2.520	5.280	0.094
DSXU5313F03	17/32	●	0.531	2.857	2.520	5.280	0.097
DSXU5469F03	35/64	●	0.547	2.86	2.520	5.280	0.100
DSXU5625F03	9/16	●	0.563	3.052	2.560	5.510	0.102
DSXU5938F03	19/32	●	0.594	3.258	2.600	5.750	0.108
DSXU6250F03	5/8	●	0.625	3.264	2.600	5.750	0.114
DSXU6562F03	21/32	●	0.656	3.469	2.640	5.980	0.119
DSXU6875F03	11/16	●	0.688	3.665	2.680	6.220	0.125

L/D = 5

Inch	DC	AH180	DCONMS	LU	LS	LF	PL
DSXU2031F05	13/64	●	0.203	1.767	2.050	3.780	0.037
DSXU2188F05	7/32	●	0.219	1.93	2.050	3.940	0.040
DSXU2344F05	15/64	●	0.234	1.933	2.050	3.940	0.043
DSXU2500F05	1/4	●	0.25	2.095	2.090	4.130	0.045
DSXU2656F05	17/64	●	0.266	2.248	2.090	4.290	0.048
DSXU2813F05	9/32	●	0.281	2.411	2.130	4.490	0.051
DSXU2969F05	19/64	●	0.297	2.574	2.130	4.650	0.054
DSXU3125F05	5/16	●	0.313	2.577	2.130	4.650	0.057
DSXU3281F05	21/64	●	0.328	2.74	2.170	5.000	0.060
DSXU3438F05	11/32	●	0.344	2.893	2.170	5.000	0.063
DSXU3594F05	23/64	●	0.359	3.055	2.200	5.350	0.065
DSXU3750F05	3/8	●	0.375	3.218	2.200	5.350	0.068
DSXU3906F05	25/64	●	0.391	3.221	2.200	5.350	0.071
DSXU4063F05	13/32	●	0.406	3.384	2.400	5.870	0.074
DSXU4219F05	27/64	●	0.422	3.537	2.400	5.870	0.077
DSXU4375F05	7/16	●	0.438	3.700	2.440	6.220	0.080
DSXU4531F05	29/64	●	0.453	3.862	2.440	6.220	0.082
DSXU4844F05	31/64	●	0.484	4.178	2.480	6.570	0.088
DSXU5000F05	1/2	●	0.500	4.181	2.480	6.570	0.091
DSXU5156F05	33/64	●	0.516	4.504	2.520	6.930	0.094
DSXU5313F05	17/32	●	0.531	4.507	2.520	6.930	0.097
DSXU5625F05	9/16	●	0.563	4.822	2.560	7.280	0.102
DSXU6250F05	5/8	●	0.625	5.154	2.600	7.640	0.114
DSXU6562F05	21/32	●	0.656	5.469	2.640	7.990	0.119

● : Line up

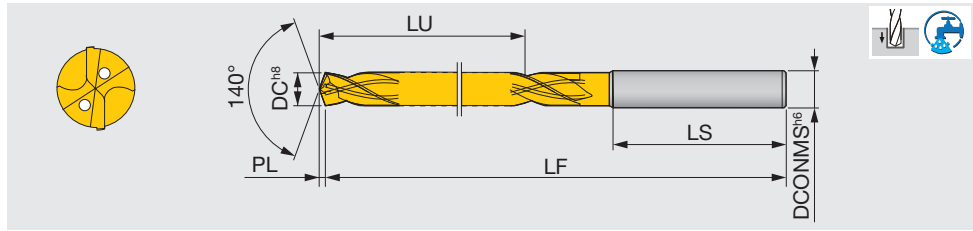

Metric	DC	AH180	DCONMS	LU	LS	LF	PL	Metric	DC	AH180	DCONMS	LU	LS	LF	PL
DSX0300F03	3	●	3	15.6	48	68	0.55	DSX0760F03	7.6	●	8	41.4	54	94	1.38
DSX0310F03	3.1	●	4	18.6	48	71	0.56	DSX0770F03	7.7	●	8	41.4	54	94	1.40
DSX0320F03	3.2	●	4	18.6	48	71	0.58	DSX0780F03	7.8	●	8	41.4	54	94	1.42
DSX0330F03	3.3	●	4	18.6	48	71	0.60	DSX0790F03	7.9	●	8	41.4	54	94	1.44
DSX0340F03	3.4	●	4	18.6	48	71	0.62	DSX0800F03	8	●	8	41.5	54	94	1.46
DSX0350F03	3.5	●	4	18.6	48	71	0.64	DSX0810F03	8.1	●	9	44.5	55	100	1.47
DSX0360F03	3.6	●	4	20.7	48	73	0.66	DSX0820F03	8.2	●	9	44.5	55	100	1.49
DSX0370F03	3.7	●	4	20.7	48	73	0.67	DSX0830F03	8.3	●	9	44.5	55	100	1.51
DSX0380F03	3.8	●	4	20.7	48	73	0.69	DSX0840F03	8.4	●	9	44.5	55	100	1.53
DSX0390F03	3.9	●	4	20.7	48	73	0.71	DSX0850F03	8.5	●	9	44.6	55	100	1.55
DSX0400F03	4	●	4	20.7	48	73	0.73	DSX0860F03	8.6	●	9	46.6	55	100	1.57
DSX0410F03	4.1	●	5	23.8	50	78	0.75	DSX0870F03	8.7	●	9	46.6	55	100	1.58
DSX0420F03	4.2	●	5	23.8	50	78	0.76	DSX0880F03	8.8	●	9	46.6	55	100	1.60
DSX0430F03	4.3	●	5	23.8	50	78	0.78	DSX0890F03	8.9	●	9	46.6	55	100	1.62
DSX0440F03	4.4	●	5	23.8	50	78	0.80	DSX0900F03	9	●	9	46.6	55	100	1.64
DSX0450F03	4.5	●	5	23.8	50	78	0.82	DSX0910F03	9.1	●	10	49.7	56	106	1.66
DSX0460F03	4.6	●	5	25.8	50	80	0.84	DSX0920F03	9.2	●	10	49.7	56	106	1.67
DSX0470F03	4.7	●	5	25.9	50	80	0.86	DSX0930F03	9.3	●	10	49.7	56	106	1.69
DSX0480F03	4.8	●	5	25.9	50	80	0.87	DSX0940F03	9.4	●	10	49.7	56	106	1.71
DSX0490F03	4.9	●	5	25.9	50	80	0.89	DSX0950F03	9.5	●	10	49.7	56	106	1.73
DSX0500F03	5	●	5	25.9	50	80	0.91	DSX0960F03	9.6	●	10	51.8	56	106	1.75
DSX0510F03	5.1	●	6	28.9	52	82	0.93	DSX0970F03	9.7	●	10	51.8	56	106	1.77
DSX0520F03	5.2	●	6	29	52	82	0.95	DSX0980F03	9.8	●	10	51.8	56	106	1.78
DSX0530F03	5.3	●	6	29	52	82	0.96	DSX0990F03	9.9	●	10	51.8	56	106	1.80
DSX0540F03	5.4	●	6	29	52	82	0.98	DSX1000F03	10	●	10	51.8	56	106	1.82
DSX0550F03	5.5	●	6	29	52	82	1.00								
DSX0560F03	5.6	●	6	31	52	82	1.02								
DSX0570F03	5.7	●	6	31	52	82	1.04								
DSX0580F03	5.8	●	6	31.1	52	82	1.06								
DSX0590F03	5.9	●	6	31.1	52	82	1.07								
DSX0600F03	6	●	6	31.1	52	82	1.09								
DSX0610F03	6.1	●	7	34.1	53	86	1.11								
DSX0620F03	6.2	●	7	34.1	53	86	1.13								
DSX0630F03	6.3	●	7	34.2	53	86	1.15								
DSX0640F03	6.4	●	7	34.2	53	86	1.16								
DSX0650F03	6.5	●	7	34.2	53	86	1.18								
DSX0660F03	6.6	●	7	36.2	53	88	1.20								
DSX0670F03	6.7	●	7	36.2	53	88	1.22								
DSX0680F03	6.8	●	7	36.2	53	88	1.24								
DSX0690F03	6.9	●	7	36.3	53	88	1.26								
DSX0700F03	7	●	7	36.3	53	88	1.27								
DSX0710F03	7.1	●	8	39.3	54	92	1.29								
DSX0720F03	7.2	●	8	39.3	54	92	1.31								
DSX0730F03	7.3	●	8	39.3	54	92	1.33								
DSX0740F03	7.4	●	8	39.4	54	92	1.35								
DSX0750F03	7.5	●	8	39.4	54	92	1.36								

● : Line up



GIGAJETDRILL

DSX-F05

Solid drill, 140° point angle, with coolant hole, L/D = 5, ø3 - ø10 mm

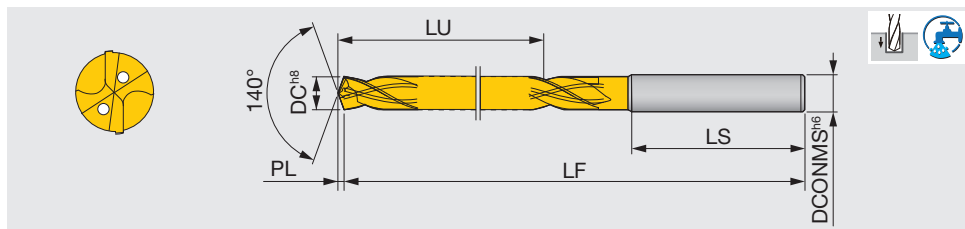

Metric	DC	AH180	DCONMS	LU	LS	LF	PL	Metric	DC	AH180	DCONMS	LU	LS	LF	PL
DSX0300F05	3	●	3	24.6	48	77	0.55	DSX0760F05	7.6	●	8	65.4	54	118	1.38
DSX0310F05	3.1	●	4	28.6	48	81	0.56	DSX0770F05	7.7	●	8	65.4	54	118	1.4
DSX0320F05	3.2	●	4	28.6	48	81	0.58	DSX0780F05	7.8	●	8	65.4	54	118	1.42
DSX0330F05	3.3	●	4	28.6	48	81	0.6	DSX0790F05	7.9	●	8	65.4	54	118	1.44
DSX0340F05	3.4	●	4	28.6	48	81	0.62	DSX0800F05	8	●	8	65.5	54	118	1.46
DSX0350F05	3.5	●	4	28.6	48	81	0.64	DSX0810F05	8.1	●	9	69.5	55	127	1.47
DSX0360F05	3.6	●	4	32.7	48	85	0.66	DSX0820F05	8.2	●	9	69.5	55	127	1.49
DSX0370F05	3.7	●	4	32.7	48	85	0.67	DSX0830F05	8.3	●	9	69.5	55	127	1.51
DSX0380F05	3.8	●	4	32.7	48	85	0.69	DSX0840F05	8.4	●	9	69.5	55	127	1.53
DSX0390F05	3.9	●	4	32.7	48	85	0.71	DSX0850F05	8.5	●	9	69.6	55	127	1.55
DSX0400F05	4	●	4	32.7	48	85	0.73	DSX0860F05	8.6	●	9	73.6	55	127	1.57
DSX0410F05	4.1	●	5	36.8	50	91	0.75	DSX0870F05	8.7	●	9	73.6	55	127	1.58
DSX0420F05	4.2	●	5	36.8	50	91	0.76	DSX0880F05	8.8	●	9	73.6	55	127	1.6
DSX0430F05	4.3	●	5	36.8	50	91	0.78	DSX0890F05	8.9	●	9	73.6	55	127	1.62
DSX0440F05	4.4	●	5	36.8	50	91	0.8	DSX0900F05	9	●	9	73.6	55	127	1.64
DSX0450F05	4.5	●	5	36.8	50	91	0.82	DSX0910F05	9.1	●	10	77.7	56	136	1.66
DSX0460F05	4.6	●	5	40.8	50	94	0.84	DSX0920F05	9.2	●	10	77.7	56	136	1.67
DSX0470F05	4.7	●	5	40.9	50	94	0.86	DSX0930F05	9.3	●	10	77.7	56	136	1.69
DSX0480F05	4.8	●	5	40.9	50	94	0.87	DSX0940F05	9.4	●	10	77.7	56	136	1.71
DSX0490F05	4.9	●	5	40.9	50	94	0.89	DSX0950F05	9.5	●	10	77.7	56	136	1.73
DSX0500F05	5	●	5	40.9	50	94	0.91	DSX0960F05	9.6	●	10	81.8	56	136	1.75
DSX0510F05	5.1	●	6	44.9	52	96	0.93	DSX0970F05	9.7	●	10	81.8	56	136	1.77
DSX0520F05	5.2	●	6	45	52	96	0.95	DSX0980F05	9.8	●	10	81.8	56	136	1.78
DSX0530F05	5.3	●	6	45	52	96	0.96	DSX0990F05	9.9	●	10	81.8	56	136	1.8
DSX0540F05	5.4	●	6	45	52	96	0.98	DSX1000F05	10	●	10	81.8	56	136	1.82
DSX0550F05	5.5	●	6	45	52	96	1								
DSX0560F05	5.6	●	6	49	52	100	1.02								
DSX0570F05	5.7	●	6	49	52	100	1.04								
DSX0580F05	5.8	●	6	49.1	52	100	1.06								
DSX0590F05	5.9	●	6	49.1	52	100	1.07								
DSX0600F05	6	●	6	49.1	52	100	1.09								
DSX0610F05	6.1	●	7	53.1	53	105	1.11								
DSX0620F05	6.2	●	7	53.1	53	105	1.13								
DSX0630F05	6.3	●	7	53.2	53	105	1.15								
DSX0640F05	6.4	●	7	53.2	53	105	1.16								
DSX0650F05	6.5	●	7	53.2	53	105	1.18								
DSX0660F05	6.6	●	7	57.2	53	109	1.2								
DSX0670F05	6.7	●	7	57.2	53	109	1.22								
DSX0680F05	6.8	●	7	57.2	53	109	1.24								
DSX0690F05	6.9	●	7	57.3	53	109	1.26								
DSX0700F05	7	●	7	57.3	53	109	1.27								
DSX0710F05	7.1	●	8	61.3	54	114	1.29								
DSX0720F05	7.2	●	8	61.3	54	114	1.31								
DSX0730F05	7.3	●	8	61.3	54	114	1.33								
DSX0740F05	7.4	●	8	61.4	54	114	1.35								
DSX0750F05	7.5	●	8	61.4	54	114	1.36								

● : Line up

Reference pages: Standard cutting conditions → J050

Solid drill, 140° point angle, with coolant hole, L/D = 8, ø3 - ø10 mm

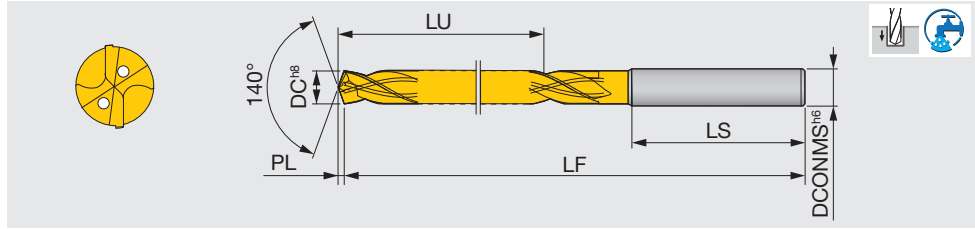

Metric	DC	AH180	DCONMS	LU	LS	LF	PL	Metric	DC	AH180	DCONMS	LU	LS	LF	PL
DSX0300F08	3	●	3	33.6	48	86	0.55	DSX0760F08	7.6		8	89.4	54	142	1.38
DSX0310F08	3.1		4	39.6	48	92	0.56	DSX0770F08	7.7		8	89.4	54	142	1.4
DSX0320F08	3.2		4	39.6	48	92	0.58	DSX0780F08	7.8		8	89.4	54	142	1.42
DSX0330F08	3.3		4	39.6	48	92	0.6	DSX0790F08	7.9		8	89.4	54	142	1.44
DSX0340F08	3.4		4	39.6	48	92	0.62	DSX0800F08	8	●	8	89.5	54	142	1.46
DSX0350F08	3.5	●	4	39.6	48	92	0.64	DSX0810F08	8.1		9	95.5	55	154	1.47
DSX0360F08	3.6		4	44.7	48	97	0.66	DSX0820F08	8.2		9	95.5	55	154	1.49
DSX0370F08	3.7		4	44.7	48	97	0.67	DSX0830F08	8.3	●	9	95.5	55	154	1.51
DSX0380F08	3.8		4	44.7	48	97	0.69	DSX0840F08	8.4		9	95.5	55	154	1.53
DSX0390F08	3.9		4	44.7	48	97	0.71	DSX0850F08	8.5	●	9	95.6	55	154	1.55
DSX0400F08	4	●	4	44.7	48	97	0.73	DSX0860F08	8.6		9	100.6	55	154	1.57
DSX0410F08	4.1		5	50.8	50	105	0.75	DSX0870F08	8.7		9	100.6	55	154	1.58
DSX0420F08	4.2		5	50.8	50	105	0.76	DSX0880F08	8.8		9	100.6	55	154	1.6
DSX0430F08	4.3		5	50.8	50	105	0.78	DSX0890F08	8.9		9	100.6	55	154	1.62
DSX0440F08	4.4		5	50.8	50	105	0.8	DSX0900F08	9	●	9	100.6	55	154	1.64
DSX0450F08	4.5	●	5	50.8	50	105	0.82	DSX0910F08	9.1		10	106.7	56	166	1.66
DSX0460F08	4.6		5	55.8	50	110	0.84	DSX0920F08	9.2		10	106.7	56	166	1.67
DSX0470F08	4.7		5	55.9	50	110	0.86	DSX0930F08	9.3		10	106.7	56	166	1.69
DSX0480F08	4.8		5	55.9	50	110	0.87	DSX0940F08	9.4		10	106.7	56	166	1.71
DSX0490F08	4.9		5	55.9	50	110	0.89	DSX0950F08	9.5	●	10	106.7	56	166	1.73
DSX0500F08	5	●	5	55.9	50	110	0.91	DSX0960F08	9.6		10	111.8	56	166	1.75
DSX0510F08	5.1	●	6	61.9	52	113	0.93	DSX0970F08	9.7		10	111.8	56	166	1.77
DSX0520F08	5.2		6	62	52	113	0.95	DSX0980F08	9.8		10	111.8	56	166	1.78
DSX0530F08	5.3		6	62	52	113	0.96	DSX0990F08	9.9		10	111.8	56	166	1.8
DSX0540F08	5.4		6	62	52	113	0.98	DSX1000F08	10	●	10	111.8	56	166	1.82
DSX0550F08	5.5	●	6	62	52	113	1								
DSX0560F08	5.6		6	67	52	118	1.02								
DSX0570F08	5.7		6	67	52	118	1.04								
DSX0580F08	5.8		6	67.1	52	118	1.06								
DSX0590F08	5.9		6	67.1	52	118	1.07								
DSX0600F08	6	●	6	67.1	52	118	1.09								
DSX0610F08	6.1		7	73.1	53	125	1.11								
DSX0620F08	6.2		7	73.1	53	125	1.13								
DSX0630F08	6.3		7	73.2	53	125	1.15								
DSX0640F08	6.4		7	73.2	53	125	1.16								
DSX0650F08	6.5	●	7	73.2	53	125	1.18								
DSX0660F08	6.6		7	78.2	53	130	1.2								
DSX0670F08	6.7		7	78.2	53	130	1.22								
DSX0680F08	6.8		7	78.2	53	130	1.24								
DSX0690F08	6.9		7	78.3	53	130	1.26								
DSX0700F08	7	●	7	78.3	53	130	1.27								
DSX0710F08	7.1		8	84.3	54	137	1.29								
DSX0720F08	7.2		8	84.3	54	137	1.31								
DSX0730F08	7.3		8	84.3	54	137	1.33								
DSX0740F08	7.4		8	84.4	54	137	1.35								
DSX0750F08	7.5	●	8	84.4	54	137	1.36								

● : Line up





STANDARD CUTTING CONDITIONS

ISO	Workpiece material	Hardness	Cutting speed: Vc (sfm)			Feed: f (ipr)		
			ø0.118 ~ ø0.236	ø0.236 ~ ø0.394	ø0.394 ~ ø0.787	ø0.118 ~ ø0.236	ø0.236 ~ ø0.394	ø0.394 ~ ø0.787
P	Mild steels, Low carbon steels 1018, 1020, 1026, etc.	< 180HB	230 - 459	262 - 525	295 - 623	0.006 - 0.010	0.008 - 0.014	0.010 - 0.016
	Carbon steels, Alloy steels 1045, 1055, etc.	180 ~ 300HB	164 - 427	230 - 525	262 - 558	0.006 - 0.010	0.008 - 0.014	0.010 - 0.016
	High alloy steels, etc. 4140, 8620, etc.	250 ~ 350HB	131 - 328	197 - 459	197 - 525	0.004 - 0.008	0.006 - 0.012	0.006 - 0.012
M	Stainless steels 304SS, 316SS, 17-4 PH, etc.	< 200HB	98 - 230	164 - 328	164 - 394	0.004 - 0.008	0.004 - 0.010	0.006 - 0.014
K	Gray cast irons Class 25, Class 30, etc.	< 200HB	262 - 459	328 - 525	328 - 591	0.006 - 0.014	0.008 - 0.016	0.010 - 0.020
	Ductile cast irons 60-40-18, 60-55-06, etc.	< 300HB	230 - 459	262 - 492	262 - 558	0.006 - 0.014	0.008 - 0.016	0.010 - 0.018
N	Aluminum alloys 6061, 7075, etc.	-	262 - 525	328 - 591	328 - 623	0.006 - 0.014	0.008 - 0.018	0.010 - 0.024
S	Titanium alloys Ti-6Al-4V, etc.	-	82 - 197	98 - 262	98 - 262	0.004 - 0.008	0.004 - 0.010	0.006 - 0.014
	Heat-resistant alloys Inconel, etc.	250HB <	33 - 98	33 - 131	33 - 131	0.001 - 0.004	0.002 - 0.006	0.004 - 0.010
H	High hardened steels	< 40HRC	66 - 164	98 - 197	98 - 197	0.003 - 0.004	0.004 - 0.006	0.005 - 0.008

Cutting conditions in the above table show standard cutting conditions.

Cutting conditions may change due to the rigidity and power of the machine and the workpiece material.

Especially in deep hole drilling (L/D is over 5), the lower cutting speed is better for longer tool life.

The coolant pressure must be 0.5 MPa - 1MPa. Especially for small diameter drill, the higher pressure is recommended.

Oil holes that become blocked may cause drill breakages. A filter to prevent the circulation of chips must be used on the coolant supply system.

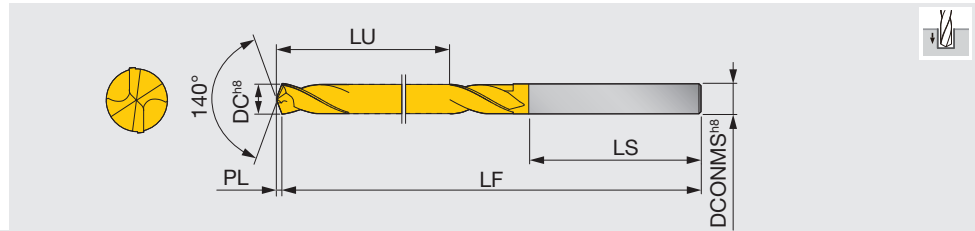

Metric	DC	AH180	DCONMS	LU	LS	LF	PL	Metric	DC	AH180	DCONMS	LU	LS	LF	PL
DSE0300F02	3	●	3	16.6	30	46	0.55	DSE0800F02	8	●	8	38.5	42	79	1.46
DSE0310F02	3.1		3.1	18.6	31	49	0.56	DSE0810F02	8.1		8.1	38.5	42	79	1.47
DSE0320F02	3.2	●	3.2	18.6	31	49	0.58	DSE0820F02	8.2		8.2	38.5	42	79	1.49
DSE0330F02	3.3		3.3	18.6	31	49	0.6	DSE0830F02	8.3		8.3	38.5	42	79	1.51
DSE0340F02	3.4	●	3.4	20.6	32	52	0.62	DSE0840F02	8.4		8.4	38.5	42	79	1.53
DSE0350F02	3.5	●	3.5	20.6	32	52	0.64	DSE0850F02	8.5	●	8.5	38.6	42	79	1.55
DSE0360F02	3.6		3.6	20.7	32	52	0.66	DSE0860F02	8.6		8.6	41.6	44	84	1.57
DSE0370F02	3.7		3.7	20.7	32	52	0.67	DSE0870F02	8.7		8.7	41.6	44	84	1.58
DSE0380F02	3.8		3.8	22.7	33	55	0.69	DSE0880F02	8.8		8.8	41.6	44	84	1.6
DSE0390F02	3.9		3.9	22.7	33	55	0.71	DSE0890F02	8.9		8.9	41.6	44	84	1.62
DSE0400F02	4	●	4	22.7	33	55	0.73	DSE0900F02	9	●	9	41.6	44	84	1.64
DSE0410F02	4.1		4.1	22.8	33	55	0.75	DSE0910F02	9.1		9.1	41.7	44	84	1.66
DSE0420F02	4.2		4.2	22.8	33	55	0.76	DSE0920F02	9.2		9.2	41.7	44	84	1.67
DSE0430F02	4.3	●	4.3	24.8	34	58	0.78	DSE0930F02	9.3		9.3	41.7	44	84	1.69
DSE0440F02	4.4		4.4	24.8	34	58	0.8	DSE0940F02	9.4		9.4	41.7	44	84	1.71
DSE0450F02	4.5	●	4.5	24.8	34	58	0.82	DSE0950F02	9.5	●	9.5	41.7	44	84	1.73
DSE0460F02	4.6		4.6	24.8	34	58	0.84	DSE0960F02	9.6		9.6	44.8	46	89	1.75
DSE0470F02	4.7		4.7	24.9	34	58	0.86	DSE0970F02	9.7		9.7	44.8	46	89	1.77
DSE0480F02	4.8		4.8	26.9	36	62	0.87	DSE0980F02	9.8		9.8	44.8	46	89	1.78
DSE0490F02	4.9		4.9	26.9	36	62	0.89	DSE0990F02	9.9		9.9	44.8	46	89	1.8
DSE0500F02	5	●	5	26.9	36	62	0.91	DSE1000F02	10	●	10	44.8	46	89	1.82
DSE0510F02	5.1	●	5.1	26.9	36	62	0.93								
DSE0520F02	5.2		5.2	27	36	62	0.95								
DSE0530F02	5.3		5.3	27	36	62	0.96								
DSE0540F02	5.4		5.4	29	38	66	0.98								
DSE0550F02	5.5	●	5.5	29	38	66	1								
DSE0560F02	5.6	●	5.6	29	38	66	1.02								
DSE0570F02	5.7		5.7	29	38	66	1.04								
DSE0580F02	5.8		5.8	29.1	38	66	1.06								
DSE0590F02	5.9		5.9	29.1	38	66	1.07								
DSE0600F02	6	●	6	29.1	38	66	1.09								
DSE0610F02	6.1		6.1	32.1	39	70	1.11								
DSE0620F02	6.2		6.2	32.1	39	70	1.13								
DSE0630F02	6.3		6.3	32.2	39	70	1.15								
DSE0640F02	6.4	●	6.4	32.2	39	70	1.16								
DSE0650F02	6.5	●	6.5	32.2	39	70	1.18								
DSE0660F02	6.6		6.6	32.2	39	70	1.2								
DSE0670F02	6.7		6.7	32.2	39	70	1.22								
DSE0680F02	6.8	●	6.8	35.2	40	74	1.24								
DSE0690F02	6.9		6.9	35.3	40	74	1.26								
DSE0700F02	7	●	7	35.3	40	74	1.27								
DSE0710F02	7.1		7.1	35.3	40	74	1.29								
DSE0720F02	7.2		7.2	35.3	40	74	1.31								
DSE0730F02	7.3		7.3	35.3	40	74	1.33								
DSE0740F02	7.4		7.4	35.4	40	74	1.35								
DSE0750F02	7.5	●	7.5	35.4	40	74	1.36								
DSE0760F02	7.6		7.6	38.4	42	79	1.38								
DSE0770F02	7.7		7.7	38.4	42	79	1.4								
DSE0780F02	7.8		7.8	38.4	42	79	1.42								
DSE0790F02	7.9		7.9	38.4	42	79	1.44								

● : Line up

Reference pages: Standard cutting conditions → J053

Grade
Insert
Toolholder
Ext. Toolholder
Int. Toolholder
Threading
Grooving
Miniature Tool
Endmill
Drilling Tool
Tooling System
User's Guide
Index



DSE-F03

Solid drill, 140° point angle, without coolant hole, shank diameter = tool diameter, L/D = 3, ø3 - ø10 mm

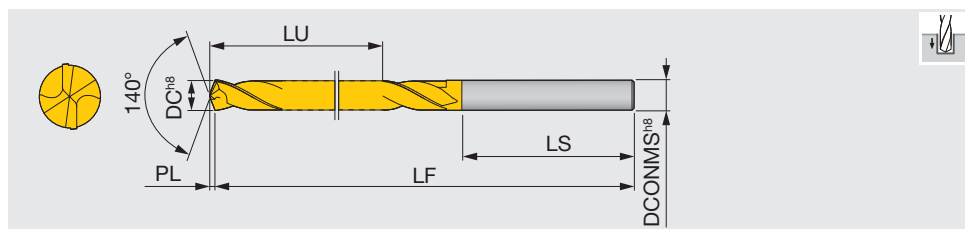

Metric	DC	AH180 DCONMS	LU	LS	LF	PL	
DSE0300F03	3	●	3	21.6	39	60	0.55
DSE0310F03	3.1		3.1	24.6	36	60	0.56
DSE0320F03	3.2	●	3.2	24.6	36	60	0.58
DSE0330F03	3.3		3.3	24.6	36	60	0.6
DSE0340F03	3.4	●	3.4	24.6	36	60	0.62
DSE0350F03	3.5	●	3.5	24.6	36	60	0.64
DSE0360F03	3.6		3.6	27.7	33	60	0.66
DSE0370F03	3.7		3.7	27.7	33	60	0.67
DSE0380F03	3.8		3.8	27.7	33	60	0.69
DSE0390F03	3.9		3.9	27.7	33	60	0.71
DSE0400F03	4	●	4	27.7	33	60	0.73
DSE0410F03	4.1		4.1	29.8	34	63	0.75
DSE0420F03	4.2		4.2	29.8	34	63	0.76
DSE0430F03	4.3	●	4.3	29.8	34	63	0.78
DSE0440F03	4.4		4.4	29.8	34	63	0.8
DSE0450F03	4.5	●	4.5	29.8	34	63	0.82
DSE0460F03	4.6		4.6	32.8	36	68	0.84
DSE0470F03	4.7		4.7	32.9	36	68	0.86
DSE0480F03	4.8		4.8	32.9	36	68	0.87
DSE0490F03	4.9		4.9	32.9	36	68	0.89
DSE0500F03	5	●	5	32.9	36	68	0.91
DSE0510F03	5.1	●	5.1	34.9	38	72	0.93
DSE0520F03	5.2		5.2	35	38	72	0.95
DSE0530F03	5.3		5.3	35	38	72	0.96
DSE0540F03	5.4		5.4	35	38	72	0.98
DSE0550F03	5.5	●	5.5	35	38	72	1
DSE0560F03	5.6		5.6	37	38	74	1.02
DSE0570F03	5.7		5.7	37	38	74	1.04
DSE0580F03	5.8		5.8	37.1	38	74	1.06
DSE0590F03	5.9		5.9	37.1	38	74	1.07
DSE0600F03	6	●	6	42.1	40	81	1.09
DSE0610F03	6.1		6.1	42.1	40	81	1.11
DSE0620F03	6.2		6.2	42.1	40	81	1.13
DSE0630F03	6.3		6.3	42.2	40	81	1.15
DSE0640F03	6.4		6.4	42.2	40	81	1.16
DSE0650F03	6.5	●	6.5	42.2	40	81	1.18
DSE0660F03	6.6		6.6	44.2	40	83	1.2
DSE0670F03	6.7		6.7	44.2	40	83	1.22
DSE0680F03	6.8	●	6.8	44.2	40	83	1.24
DSE0690F03	6.9		6.9	44.3	40	83	1.26
DSE0700F03	7	●	7	44.3	40	83	1.27
DSE0710F03	7.1		7.1	46.3	42	87	1.29
DSE0720F03	7.2		7.2	46.3	42	87	1.31
DSE0730F03	7.3		7.3	46.3	42	87	1.33
DSE0740F03	7.4	●	7.4	46.4	42	87	1.35
DSE0750F03	7.5	●	7.5	46.4	42	87	1.36
DSE0760F03	7.6		7.6	49.4	42	90	1.38
DSE0770F03	7.7		7.7	49.4	42	90	1.4
DSE0780F03	7.8		7.8	49.4	42	90	1.42
DSE0790F03	7.9		7.9	49.4	42	90	1.44

Metric	DC	AH180 DCONMS	LU	LS	LF	PL	
DSE0800F03	8	●	8	49.5	42	90	1.46
DSE0810F03	8.1		8.1	54.5	43	96	1.47
DSE0820F03	8.2		8.2	54.5	43	96	1.49
DSE0830F03	8.3		8.3	54.5	43	96	1.51
DSE0840F03	8.4		8.4	54.5	43	96	1.53
DSE0850F03	8.5	●	8.5	54.6	43	96	1.55
DSE0860F03	8.6	●	8.6	56.6	43	98	1.57
DSE0870F03	8.7		8.7	56.6	43	98	1.58
DSE0880F03	8.8		8.8	56.6	43	98	1.6
DSE0890F03	8.9		8.9	56.6	43	98	1.62
DSE0900F03	9	●	9	56.6	43	98	1.64
DSE0910F03	9.1		9.1	59.7	44	102	1.66
DSE0920F03	9.2		9.2	59.7	44	102	1.67
DSE0930F03	9.3		9.3	59.7	44	102	1.69
DSE0940F03	9.4		9.4	59.7	44	102	1.71
DSE0950F03	9.5	●	9.5	59.7	44	102	1.73
DSE0960F03	9.6		9.6	61.8	45	105	1.75
DSE0970F03	9.7		9.7	61.8	45	105	1.77
DSE0980F03	9.8		9.8	61.8	45	105	1.78
DSE0990F03	9.9		9.9	61.8	45	105	1.8
DSE1000F03	10	●	10	61.8	45	105	1.82

● : Line up

Reference pages: Standard cutting conditions → J053

STANDARD CUTTING CONDITIONS

ISO	Workpiece material	Hardness	Cutting speed: Vc (sfm)			Feed: f (ipr)		
			ø0.118" ~ ø0.236"	ø0.236" ~ ø0.394"	ø0.394" ~ ø0.630"	ø0.118" ~ ø0.236"	ø0.236" ~ ø0.394"	ø0.394" ~ ø0.630"
P	Mild steels, Low carbon steels	< 180HB	131 - 328	197 - 394	197 - 427	0.006 - 0.012	0.006 - 0.014	0.008 - 0.020
	Carbon steels, Alloy steels	180 ~ 300HB	131 - 295	164 - 394	197 - 427	0.006 - 0.012	0.006 - 0.014	0.006 - 0.016
	High alloy steels, etc.	250 ~ 350HB	131 - 262	164 - 328	164 - 328	0.004 - 0.008	0.006 - 0.010	0.006 - 0.014
M	Stainless steels	< 200HB	33 - 66	33 - 66	33 - 66	0.002 - 0.006	0.002 - 0.006	0.002 - 0.006
K	Gray cast irons	< 200HB	131 - 295	164 - 312	164 - 328	0.006 - 0.012	0.008 - 0.016	0.008 - 0.016
	Ductile cast irons	< 300HB	115 - 262	131 - 279	148 - 295	0.006 - 0.012	0.008 - 0.016	0.008 - 0.016
S	Titanium alloys		66 - 131	66 - 131	66 - 131	0.004 - 0.008	0.006 - 0.010	0.006 - 0.016
	Heat-resistant alloys	250HB <	33 - 98	33 - 98	33 - 98	0.001 - 0.003	0.002 - 0.004	0.003 - 0.005
H	High hardened steels	< 40HRC	66 - 131	66 - 131	66 - 131	0.002 - 0.006	0.002 - 0.006	0.003 - 0.008

Because the cutting conditions may be changed depending on the material type, hardness, machinability, machine tool, and coolant, the most appropriate conditions must be decided based on the chip control condition and tool failure mode.
 When using the smaller diameter tools in each range, set the feed "f" to the lower recommended values.
 When drilling difficult-to-cut materials, coolant supplying conditions are critical for successful drilling. So, the use of constant and flood coolant is highly recommended.
 When work material is austenitic stainless steel and the hole depth is over L/D = 2, using a step drilling program or a DSX drill with an oil hole is recommended.

Grade
A
Insert
B
Ext. Toolholder
C
Int. Toolholder
D
Threading
E
Grooving
F
Miniature Tool
G
Milling Cutter
H
Endmill
I
Drilling Tool
J
Tooling System
K
User's Guide
L
Index
M

GIGAMINIDRILL

DSM

Micro solid drill, 140° point angle, without coolant hole, shank diameter ø3 mm, L/D = 5 - 15, tool diameter ø0.1 - ø3 mm

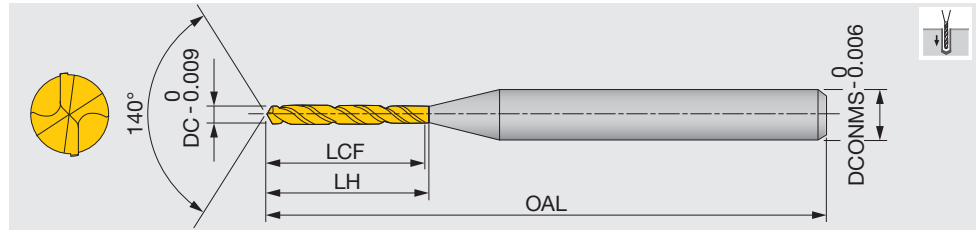

Metric	DC	Coated		DCONMS	LCF	LH	OAL	Metric	DC	Coated		DCONMS	LCF	LH	OAL
		YH170	YH180							YH170	YH180				
DSM0010G10	0.1	●		3	1.15	1.4	38	DSM0070G10	0.7	●		3	8.6	9.2	38
DSM0011G10	0.11	●		3	1.25	1.5	38	DSM0071G10	0.71			3	9.2	9.8	38
DSM0012G10	0.12	●		3	1.35	1.6	38	DSM0072G10	0.72			3	9.2	9.8	38
DSM0013G10	0.13	●		3	1.55	1.8	38	DSM0073G10	0.73			3	9.2	9.8	38
DSM0014G10	0.14	●		3	1.65	1.9	38	DSM0074G10	0.74			3	9.2	9.8	38
DSM0015G10	0.15	●		3	1.75	2	38	DSM0075G10	0.75	●		3	9.2	9.8	38
DSM0016G10	0.16	●		3	1.85	2.1	38	DSM0076G10	0.76			3	9.9	10.5	38
DSM0017G10	0.17	●		3	1.95	2.2	38	DSM0077G10	0.77			3	9.9	10.5	38
DSM0018G10	0.18	●		3	2.15	2.4	38	DSM0078G10	0.78			3	9.9	10.5	38
DSM0019G10	0.19	●		3	2.25	2.5	38	DSM0079G10	0.79			3	9.9	10.5	38
DSM0020G10	0.2	●		3	2.35	2.6	38	DSM0080G10	0.8	●		3	9.9	10.5	38
DSM0021G10	0.21	●		3	2.45	2.7	38	DSM0081G10	0.81			3	10.5	11.1	38
DSM0022G10	0.22	●		3	2.55	2.8	38	DSM0082G10	0.82			3	10.5	11.1	38
DSM0023G10	0.23	●		3	2.75	3	38	DSM0083G10	0.83			3	10.5	11.1	38
DSM0024G10	0.24	●		3	2.85	3.1	38	DSM0084G10	0.84			3	10.5	11.1	38
DSM0025G10	0.25	●		3	3	3.3	38	DSM0085G10	0.85			3	10.5	11.1	38
DSM0026G10	0.26	●		3	3.1	3.4	38	DSM0086G10	0.86			3	9.9	10.5	38
DSM0027G10	0.27	●		3	3.2	3.5	38	DSM0087G10	0.87			3	9.9	10.5	38
DSM0028G10	0.28	●		3	3.4	3.7	38	DSM0088G10	0.88	●		3	9.9	10.5	38
DSM0029G10	0.29	●		3	3.5	3.8	38	DSM0089G10	0.89			3	9.9	10.5	38
DSM0030G10	0.3	●		3	3.9	4.2	38	DSM0090G10	0.9	●		3	9.9	10.5	38
DSM0031G15	0.31	●		3	5.6	5.9	38	DSM0091G10	0.91			3	10.5	11.1	38
DSM0032G15	0.32	●		3	5.6	5.9	38	DSM0092G10	0.92			3	10.5	11.1	38
DSM0033G15	0.33	●		3	5.6	5.9	38	DSM0093G10	0.93			3	10.5	11.1	38
DSM0034G15	0.34	●		3	5.6	5.9	38	DSM0094G10	0.94			3	10.5	11.1	38
DSM0035G15	0.35	●		3	5.6	5.9	38	DSM0095G10	0.95			3	10.5	11.1	38
DSM0036G15	0.36	●		3	6.5	6.8	38	DSM0096G10	0.96			3	11	11.6	38
DSM0037G15	0.37	●		3	6.5	6.8	38	DSM0097G10	0.97	●		3	11	11.6	38
DSM0038G15	0.38	●		3	6.5	6.8	38	DSM0098G10	0.98			3	11	11.6	38
DSM0039G15	0.39	●		3	6.5	6.8	38	DSM0099G10	0.99			3	11	11.6	38
DSM0040G15	0.4	●		3	6.5	6.8	38	DSM0100G10	1	●		3	11.5	12.1	38
DSM0041G15	0.41	●		3	7.4	7.7	38	DSM0101G05	1.01			3	8	8.6	38
DSM0042G15	0.42	●		3	7.4	7.7	38	DSM0102G05	1.02			3	8	8.6	38
DSM0043G15	0.43	●		3	7.4	7.7	38	DSM0103G05	1.03			3	8	8.6	38
DSM0044G15	0.44	●		3	7.4	7.7	38	DSM0104G05	1.04			3	8	8.6	38
DSM0045G15	0.45	●		3	7.4	7.7	38	DSM0105G05	1.05			3	8	8.6	38
DSM0046G15	0.46	●		3	8.1	8.7	38	DSM0106G05	1.06			3	8	8.6	38
DSM0047G15	0.47	●		3	8.1	8.7	38	DSM0107G05	1.07			3	8	8.6	38
DSM0048G15	0.48	●		3	8.1	8.7	38	DSM0108G05	1.08	●		3	8	8.6	38
DSM0049G15	0.49	●		3	8.1	8.7	38	DSM0109G05	1.09			3	8	8.6	38
DSM0050G15	0.5	●		3	8.1	8.7	38	DSM0110G05	1.1	●		3	8	8.6	38
DSM0051G10	0.51			3	6.6	7.2	38	DSM0111G05	1.11			3	8.9	9.5	38
DSM0052G10	0.52			3	6.6	7.2	38	DSM0112G05	1.12			3	8.9	9.5	38
DSM0053G10	0.53			3	6.6	7.2	38	DSM0113G05	1.13			3	8.9	9.5	38
DSM0054G10	0.54			3	6.6	7.2	38	DSM0114G05	1.14			3	8.9	9.5	38
DSM0055G10	0.55	●		3	6.6	7.2	38	DSM0115G05	1.15			3	8.9	9.5	38
DSM0056G10	0.56			3	7.3	7.9	38	DSM0116G05	1.16			3	8.9	9.5	38
DSM0057G10	0.57			3	7.3	7.9	38	DSM0117G05	1.17			3	8.9	9.5	38
DSM0058G10	0.58			3	7.3	7.9	38	DSM0118G05	1.18			3	8.9	9.5	38
DSM0059G10	0.59			3	7.3	7.9	38	DSM0119G05	1.19			3	8.9	9.5	38
DSM0060G10	0.6	●		3	7.3	7.9	38	DSM0120G05	1.2	●		3	8.9	9.5	38
DSM0061G10	0.61			3	7.9	8.5	38	DSM0121G05	1.21			3	9.7	10.3	38
DSM0062G10	0.62			3	7.9	8.5	38	DSM0122G05	1.22			3	9.7	10.3	38
DSM0063G10	0.63			3	7.9	8.5	38	DSM0123G05	1.23			3	9.7	10.3	38
DSM0064G10	0.64			3	7.9	8.5	38	DSM0124G05	1.24			3	9.7	10.3	38
DSM0065G10	0.65	●		3	7.9	8.5	38	DSM0125G05	1.25			3	9.7	10.3	38
DSM0066G10	0.66			3	8.6	9.2	38	DSM0126G05	1.26			3	9.7	10.3	38
DSM0067G10	0.67			3	8.6	9.2	38	DSM0127G05	1.27			3	9.7	10.3	38
DSM0068G10	0.68			3	8.6	9.2	38								
DSM0069G10	0.69			3	8.6	9.2	38								

● : Line up

Reference pages: Standard cutting conditions → J056

Metric	DC	Coated		DCONMS	LCF	LH	OAL
		YH170	YH180				
DSM0128G05	1.28			3	9.7	10.3	38
DSM0129G05	1.29			3	9.7	10.3	38
DSM0130G05	1.3	●		3	9.7	10.3	38
DSM0131G05	1.31			3	10.5	11.1	38
DSM0132G05	1.32			3	10.5	11.1	38
DSM0133G05	1.33			3	10.5	11.1	38
DSM0134G05	1.34			3	10.5	11.1	38
DSM0135G05	1.35			3	10.5	11.1	38
DSM0136G05	1.36			3	10.5	11.1	38
DSM0137G05	1.37			3	10.5	11.1	38
DSM0138G05	1.38			3	10.5	11.1	38
DSM0139G05	1.39			3	10.5	11.1	38
DSM0140G05	1.4	●		3	10.5	11.1	38
DSM0141G05	1.41			3	11.3	11.9	38
DSM0142G05	1.42			3	11.3	11.9	38
DSM0143G05	1.43			3	11.3	11.9	38
DSM0144G05	1.44			3	11.3	11.9	38
DSM0145G05	1.45	●		3	11.3	11.9	38
DSM0146G05	1.46			3	11.3	11.9	38
DSM0147G05	1.47			3	11.3	11.9	38
DSM0148G05	1.48			3	11.3	11.9	38
DSM0149G05	1.49			3	11.3	11.9	38
DSM0150G05	1.5	●		3	11.3	11.9	38
DSM0151G05	1.51			3	12.1	12.7	45
DSM0152G05	1.52			3	12.1	12.7	45
DSM0153G05	1.53	●		3	12.1	12.7	45
DSM0154G05	1.54			3	12.1	12.7	45
DSM0155G05	1.55	●		3	12.1	12.7	45
DSM0156G05	1.56			3	12.1	12.7	45
DSM0157G05	1.57			3	12.1	12.7	45
DSM0158G05	1.58			3	12.1	12.7	45
DSM0159G05	1.59			3	12.1	12.7	45
DSM0160G05	1.6	●		3	12.1	12.7	45
DSM0161G05	1.61			3	12.9	13.6	45
DSM0162G05	1.62			3	12.9	13.6	45
DSM0163G05	1.63			3	12.9	13.6	45
DSM0164G05	1.64			3	12.9	13.6	45
DSM0165G05	1.65	●		3	12.9	13.6	45
DSM0166G05	1.66			3	12.9	13.6	45
DSM0167G05	1.67			3	12.9	13.6	45
DSM0168G05	1.68			3	12.9	13.6	45
DSM0169G05	1.69			3	12.9	13.6	45
DSM0170G05	1.7	●		3	12.9	13.6	45
DSM0171G05	1.71			3	13.7	14.3	45
DSM0172G05	1.72			3	13.7	14.3	45
DSM0173G05	1.73			3	13.7	14.3	45
DSM0174G05	1.74			3	13.7	14.3	45
DSM0175G05	1.75			3	13.7	14.3	45
DSM0176G05	1.76			3	13.7	14.3	45
DSM0177G05	1.77			3	13.7	14.3	45
DSM0178G05	1.78			3	13.7	14.3	45
DSM0179G05	1.79			3	13.7	14.3	45
DSM0180G05	1.8	●		3	13.7	14.3	45
DSM0181G05	1.81			3	14.5	15.1	45
DSM0182G05	1.82	●		3	14.5	15.1	45
DSM0183G05	1.83			3	14.5	15.1	45
DSM0184G05	1.84			3	14.5	15.1	45
DSM0185G05	1.85	●		3	14.5	15.1	45
DSM0186G05	1.86			3	14.5	15.1	45
DSM0187G05	1.87			3	14.5	15.1	45
DSM0188G05	1.88			3	14.5	15.1	45
DSM0189G05	1.89			3	14.5	15.1	45
DSM0190G05	1.9	●		3	14.5	15.1	45
DSM0191G05	1.91			3	15.3	15.9	45
DSM0192G05	1.92			3	15.3	15.9	45
DSM0193G05	1.93			3	15.3	15.9	45
DSM0194G05	1.94			3	15.3	15.9	45
DSM0195G05	1.95	●		3	15.3	15.9	45
DSM0196G05	1.96			3	15.3	15.9	45
DSM0197G05	1.97			3	15.3	15.9	45
DSM0198G05	1.98			3	15.3	15.9	45
DSM0199G05	1.99			3	15.3	15.9	45
DSM0200G05	2		●	3	15.3	15.9	45
DSM0201G05	2.01			3	16.1	16.7	45
DSM0202G05	2.02			3	16.1	16.7	45
DSM0203G05	2.03		●	3	16.1	16.7	45

Metric	DC	Coated		DCONMS	LCF	LH	OAL
		YH170	YH180				
DSM0204G05	2.04			3	16.1	16.7	45
DSM0205G05	2.05			3	16.1	16.7	45
DSM0206G05	2.06			3	16.1	16.7	45
DSM0207G05	2.07			3	16.1	16.7	45
DSM0208G05	2.08			3	16.1	16.7	45
DSM0209G05	2.09			3	16.1	16.7	45
DSM0210G05	2.1		●	3	16.1	16.7	45
DSM0211G05	2.11			3	16.9	17.5	45
DSM0212G05	2.12			3	16.9	17.5	45
DSM0213G05	2.13			3	16.9	17.5	45
DSM0214G05	2.14			3	16.9	17.5	45
DSM0215G05	2.15			3	16.9	17.5	45
DSM0216G05	2.16			3	16.9	17.5	45
DSM0217G05	2.17			3	16.9	17.5	45
DSM0218G05	2.18			3	16.9	17.5	45
DSM0219G05	2.19			3	16.9	17.5	45
DSM0220G05	2.2		●	3	16.9	17.5	45
DSM0221G05	2.21			3	17.7	18.3	45
DSM0222G05	2.22			3	17.7	18.3	45
DSM0223G05	2.23			3	17.7	18.3	45
DSM0224G05	2.24			3	17.7	18.3	45
DSM0225G05	2.25			3	17.7	18.3	45
DSM0226G05	2.26			3	17.7	18.3	45
DSM0227G05	2.27			3	17.7	18.3	45
DSM0228G05	2.28			3	17.7	18.3	45
DSM0229G05	2.29			3	17.7	18.3	45
DSM0230G05	2.3		●	3	17.7	18.3	45
DSM0231G05	2.31			3	18.5	19.1	55
DSM0232G05	2.32			3	18.5	19.1	55
DSM0233G05	2.33			3	18.5	19.1	55
DSM0234G05	2.34			3	18.5	19.1	55
DSM0235G05	2.35			3	18.5	19.1	55
DSM0236G05	2.36			3	18.5	19.1	55
DSM0237G05	2.37			3	18.5	19.1	55
DSM0238G05	2.38			3	18.5	19.1	55
DSM0239G05	2.39			3	18.5	19.1	55
DSM0240G05	2.4		●	3	18.5	19.1	55
DSM0241G05	2.41			3	19.3	19.9	55
DSM0242G05	2.42			3	19.3	19.9	55
DSM0243G05	2.43			3	19.3	19.9	55
DSM0244G05	2.44			3	19.3	19.9	55
DSM0245G05	2.45			3	19.3	19.9	55
DSM0246G05	2.46			3	19.3	19.9	55
DSM0247G05	2.47			3	19.3	19.9	55
DSM0248G05	2.48			3	19.3	19.9	55
DSM0249G05	2.49			3	19.3	19.9	55
DSM0250G05	2.5		●	3	19.3	19.9	55
DSM0251G05	2.51			3	20.1	20.7	55
DSM0252G05	2.52			3	20.1	20.7	55
DSM0253G05	2.53			3	20.1	20.7	55
DSM0254G05	2.54			3	20.1	20.7	55
DSM0255G05	2.55			3	20.1	20.7	55
DSM0256G05	2.56		●	3	20.1	20.7	55
DSM0257G05	2.57			3	20.1	20.7	55
DSM0258G05	2.58			3	20.1	20.7	55
DSM0259G05	2.59			3	20.1	20.7	55
DSM0260G05	2.6		●	3	20.1	20.7	55
DSM0261G05	2.61			3	20.9	21.5	55
DSM0262G05	2.62			3	20.9	21.5	55
DSM0263G05	2.63			3	20.9	21.5	55
DSM0264G05	2.64			3	20.9	21.5	55
DSM0265G05	2.65			3	20.9	21.5	55
DSM0266G05	2.66			3	20.9	21.5	55
DSM0267G05	2.67			3	20.9	21.5	55
DSM0268G05	2.68			3	20.9	21.5	55
DSM0269G05	2.69			3	20.9	21.5	55
DSM0270G05	2.7		●	3	20.9	21.5	55
DSM0271G05	2.71			3	21.7	22.3	55
DSM0272G05	2.72			3	21.7	22.3	55
DSM0273G05	2.73			3	21.7	22.3	55
DSM0274G05	2.74			3	21.7	22.3	55
DSM0275G05	2.75			3	21.7	22.3	55
DSM0276G05	2.76			3	21.7	22.3	55
DSM0277G05	2.77			3	21.7	22.3	55

● : Line up

Reference pages: Standard cutting conditions → J056

Grade
Insert
Toolholder
Ext. Toolholder
Int. Toolholder
Threading
Grooving
Miniature Tool
Milling Cutter
Endmill
Drilling Tool
Tooling System
Index



Metric	DC	Coated					Metric	DC	Coated					
		YH170	YH180	DCONMS	LCF	LH			OAL	YH170	YH180	DCONMS	LCF	LH
DSM0278G05	2.78			3	21.7	22.3	55	DSM0290G05	2.9	●	3	22.5	23.1	55
DSM0279G05	2.79			3	21.7	22.3	55	DSM0291G05	2.91		3	23.3	23.9	55
DSM0280G05	2.8		●	3	21.7	22.3	55	DSM0292G05	2.92		3	23.3	23.9	55
DSM0281G05	2.81			3	22.5	23.1	55	DSM0293G05	2.93		3	23.3	23.9	55
DSM0282G05	2.82			3	22.5	23.1	55	DSM0294G05	2.94		3	23.3	23.9	55
DSM0283G05	2.83			3	22.5	23.1	55	DSM0295G05	2.95		3	23.3	23.9	55
DSM0284G05	2.84			3	22.5	23.1	55	DSM0296G05	2.96		3	23.3	23.9	55
DSM0285G05	2.85			3	22.5	23.1	55	DSM0297G05	2.97		3	23.3	23.9	55
DSM0286G05	2.86			3	22.5	23.1	55	DSM0298G05	2.98		3	23.3	23.9	55
DSM0287G05	2.87			3	22.5	23.1	55	DSM0299G05	2.99		3	23.3	23.9	55
DSM0288G05	2.88			3	22.5	23.1	55	DSM0300G05	3	●	3	23.3	23.9	55
DSM0289G05	2.89			3	22.5	23.1	55							

● : Line up

STANDARD CUTTING CONDITIONS

ISO	Workpiece material	Cutting speed: Vc (sfm)			Feed: f (ipr)				
		ø0.1 ~ ø0.3 (ø0.004" ~ ø0.012")	ø0.3 ~ ø0.5 (ø0.012" ~ ø0.020")	ø0.5 ~ ø3 (ø0.020" ~ ø0.118")	ø0.1 ~ ø0.3 (ø0.004" ~ ø0.012")	ø0.3 ~ ø0.5 (ø0.012" ~ ø0.020")	ø0.5 ~ ø1 (ø0.020" ~ ø0.039")	ø1 ~ ø2 (ø0.039" ~ ø0.079")	ø2 ~ ø3 (ø0.079" ~ ø0.118")
P	Carbon steels, Alloy steels	16 - 66	49 - 98	82 - 197	0.0004 - 0.00016	0.00008 - 0.0004	0.00020 - 0.0020	0.0012 - 0.0035	0.0020 - 0.004
M	Stainless steels	7 - 39	20 - 59	33 - 66	0.0002 - 0.00016	0.00008 - 0.00031	0.00020 - 0.0012	0.0004 - 0.0016	0.0008 - 0.0020
K	Gray cast irons	16 - 49	33 - 82	66 - 164	0.0002 - 0.00016	0.00008 - 0.0005	0.00020 - 0.0012	0.0004 - 0.0024	0.0012 - 0.005
	Ductile cast irons	16 - 49	33 - 82	66 - 164	0.0004 - 0.00012	0.00008 - 0.0004	0.00020 - 0.0008	0.0004 - 0.0020	0.0012 - 0.004
N	Aluminum alloys	33 - 66	33 - 98	66 - 164	0.0004 - 0.0004	0.00020 - 0.0012	0.0004 - 0.0020	0.0016 - 0.006	0.0024 - 0.008
	Copper / Brass	33 - 66	33 - 98	66 - 164	0.0004 - 0.0004	0.00020 - 0.0012	0.0004 - 0.0020	0.0016 - 0.006	0.0024 - 0.008
S	Heat-resistant alloys	7 - 20	16 - 33	26 - 66	0.0002 - 0.00012	0.00008 - 0.00016	0.00008 - 0.00016	0.00008 - 0.00016	Not recommended
H	High hardened steels	13 - 26	20 - 33	20 - 52	0.0002 - 0.00008	0.00004 - 0.00020	0.00020 - 0.0008	0.0004 - 0.0012	0.0008 - 0.0024

When the drilling depth is deeper than L/D = 5, use drill pecking every 10 to 50% of the drill diameter.
The above cutting conditions apply when a water soluble cutting fluid is used. For drilling a hole smaller than ø0.012", use of a starting drill is recommended.
When setting the drill, the drill run out should be within 0.00008" on the taper. (Especially for the drill diameter smaller than ø0.020")

GIGAMINIDRILL

DSM-CP

Centering drill for DSM drill

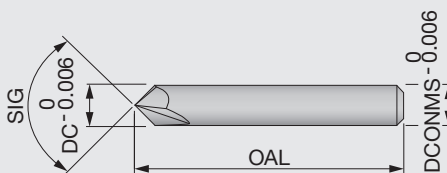

Metric	DC	YH170	DCONMS	OAL	SIG
DSM-CP90	3	●	3	38.1	90°
DSM-CP140	3	●	3	38.1	140°

● : Line up

STANDARD CUTTING CONDITIONS

ISO	Workpiece material	Cutting speed: Vc (sfm)	Feed: f (ipr)	
			DSM-CP90	DSM-CP140
P	Carbon, Mild and Alloy steels	98 - 262	0.00039 - 0.00236	0.00118 - 0.00314
K	Gray and ductile cast irons	98 - 262	0.00078 - 0.00236	0.00196 - 0.00393
N	Aluminum alloys	197 - 394	0.00078 - 0.0039	0.00196 - 0.0059
M	Stainless steels	49 - 131	0.00039 - 0.00118	0.00078 - 0.00236
H	High hardened steels (~45HRC)	33 - 131	Not recommended	0.00039 - 0.00196

For hard materials and stainless steels which have work-hardening nature, DSM-CP140 is recommended.
Above cutting conditions are when using a water-soluble cutting fluid. When using a water-insoluble type, set the cutting speed to lower side.

DMXU L/D=2 (VS type)

Solid-drill with 130° point angle without oil hole & shank size equal to drill dia., L/D = 2, dia = ø0.111" - ø0.781"

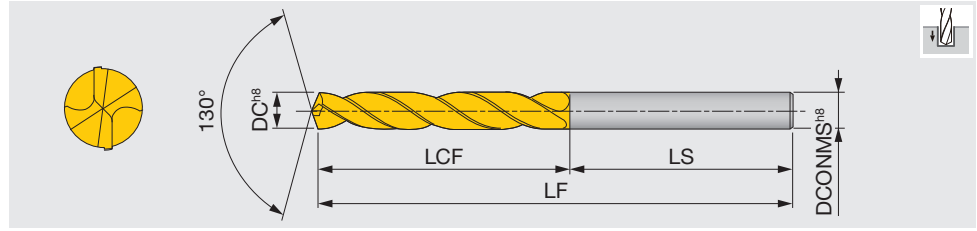

Inch	DC	AH170	DCONMS	LCF	LS	LF	Inch	DC	AH170	DCONMS	LCF	LS	LF
DMXU1110VS	#34	●	0.111	0.630	1.18	1.81	DMXU2969VS	19/64	●	0.297	1.46	1.65	3.11
DMXU1130VS	#33	●	0.113	0.630	1.18	1.81	DMXU3020VS	#N	●	0.302	1.46	1.65	3.11
DMXU1160VS	#32	●	0.116	0.630	1.18	1.81	DMXU3125VS	5/16	●	0.313	1.46	1.65	3.11
DMXU1200VS	#31	●	0.120	0.708	1.22	1.93	DMXU3160VS	#0	●	0.316	1.46	1.65	3.11
DMXU1250VS	1/8	●	0.125	0.708	1.22	1.93	DMXU3230VS	#P	●	0.323	1.46	1.65	3.11
DMXU1285VS	#30	●	0.129	0.708	1.22	1.93	DMXU3281VS	21/64	●	0.328	1.46	1.65	3.11
DMXU1360VS	#29	●	0.136	0.787	1.26	2.05	DMXU3320VS	#Q	●	0.332	1.46	1.65	3.11
DMXU1405VS	#28	●	0.141	0.787	1.26	2.05	DMXU3390VS	#R	●	0.339	1.57	1.73	3.31
DMXU1406VS	9/64	●	0.141	0.787	1.26	2.05	DMXU3438VS	11/32	●	0.344	1.57	1.73	3.31
DMXU1440VS	#27	●	0.144	0.787	1.26	2.05	DMXU3480VS	#S	●	0.348	1.57	1.73	3.31
DMXU1470VS	#26	●	0.147	0.886	1.30	2.17	DMXU3580VS	#T	●	0.358	1.57	1.73	3.31
DMXU1495VS	#25	●	0.150	0.886	1.30	2.17	DMXU3594VS	23/64	●	0.359	1.57	1.73	3.31
DMXU1520VS	#24	●	0.152	0.886	1.30	2.17	DMXU3680VS	#U	●	0.368	1.57	1.73	3.31
DMXU1540VS	#23	●	0.154	0.886	1.30	2.17	DMXU3750VS	3/8	●	0.375	1.69	1.81	3.50
DMXU1562VS	5/32	●	0.156	0.886	1.30	2.17	DMXU3770VS	#V	●	0.377	1.69	1.81	3.50
DMXU1570VS	#22	●	0.157	0.886	1.30	2.17	DMXU3860VS	#W	●	0.386	1.69	1.81	3.50
DMXU1590VS	#21	●	0.159	0.886	1.30	2.17	DMXU3906VS	25/64	●	0.391	1.69	1.81	3.50
DMXU1610VS	#20	●	0.161	0.886	1.30	2.17	DMXU3970VS	#X	●	0.397	1.69	1.81	3.50
DMXU1660VS	#19	●	0.166	0.945	1.34	2.28	DMXU4040VS	#Y	●	0.404	1.69	1.81	3.50
DMXU1695VS	#18	●	0.170	0.945	1.34	2.28	DMXU4062VS	13/32	●	0.406	1.69	1.81	3.50
DMXU1719VS	11/64	●	0.172	0.945	1.34	2.28	DMXU4130VS	#Z	●	0.413	1.69	1.81	3.50
DMXU1730VS	#17	●	0.173	0.945	1.34	2.28	DMXU4219VS	27/64	●	0.422	1.85	1.89	3.74
DMXU1770VS	#16	●	0.177	0.945	1.34	2.28	DMXU4375VS	7/16	●	0.438	1.85	1.89	3.74
DMXU1800VS	#15	●	0.180	0.945	1.34	2.28	DMXU4531VS	29/64	●	0.453	1.85	1.89	3.74
DMXU1820VS	#14	●	0.182	0.945	1.34	2.28	DMXU4688VS	15/32	●	0.469	2.01	2.01	4.02
DMXU1850VS	#13	●	0.185	0.945	1.34	2.28	DMXU4844VS	31/64	●	0.484	2.01	2.01	4.02
DMXU1875VS	3/16	●	0.188	1.02	1.42	2.44	DMXU5000VS	1/2	●	0.500	2.01	2.01	4.02
DMXU1890VS	#12	●	0.189	1.02	1.42	2.44	DMXU5050VS	TUBE	●	0.505	2.01	2.01	4.02
DMXU1910VS	#11	●	0.191	1.02	1.42	2.44	DMXU5156VS	33/64	●	0.516	2.01	2.01	4.02
DMXU1935VS	#10	●	0.194	1.02	1.42	2.44	DMXU5312VS	17/32	●	0.531	2.13	2.09	4.21
DMXU1960VS	#9	●	0.196	1.02	1.42	2.44	DMXU5469VS	35/64	●	0.547	2.13	2.09	4.21
DMXU1990VS	#8	●	0.199	1.02	1.42	2.44	DMXU5625VS	9/16	●	0.563	2.20	2.17	4.37
DMXU2010VS	#7	●	0.201	1.02	1.42	2.44	DMXU5781VS	37/64	●	0.578	2.20	2.17	4.37
DMXU2031VS	13/64	●	0.203	1.02	1.42	2.44	DMXU5937VS	19/32	●	0.594	2.28	2.24	4.53
DMXU2040VS	#6	●	0.204	1.02	1.42	2.44	DMXU6094VS	39/64	●	0.609	2.28	2.24	4.53
DMXU2055VS	#5	●	0.206	1.02	1.42	2.44	DMXU6250VS	5/8	●	0.625	2.28	2.24	4.53
DMXU2090VS	#4	●	0.209	1.10	1.50	2.60	DMXU6330VS	TUBE	●	0.633	2.36	2.32	4.69
DMXU2130VS	#3	●	0.213	1.10	1.50	2.60	DMXU6406VS	41/64	●	0.641	2.36	2.32	4.69
DMXU2188VS	7/32	●	0.219	1.10	1.50	2.60	DMXU6562VS	21/32	●	0.656	2.36	2.32	4.69
DMXU2210VS	#2	●	0.221	1.10	1.50	2.60	DMXU6875VS	11/16	●	0.688	2.44	2.40	4.85
DMXU2280VS	#1	●	0.228	1.10	1.50	2.60	DMXU7031VS	45/64	●	0.703	2.44	2.40	4.85
DMXU2344VS	15/64	●	0.234	1.10	1.50	2.60	DMXU7187VS	23/32	●	0.719	2.52	2.48	5.00
DMXU2380VS	#B	●	0.238	1.22	1.54	2.76	DMXU7344VS	47/64	●	0.734	2.52	2.48	5.00
DMXU2420VS	#C	●	0.242	1.22	1.54	2.76	DMXU7500VS	3/4	●	0.750	2.60	2.56	5.16
DMXU2460VS	#D	●	0.246	1.22	1.54	2.76	DMXU7590VS	TUBE	●	0.759	2.60	2.60	5.16
DMXU2500VS	1/4	●	0.250	1.22	1.54	2.76	DMXU7656VS	49/64	●	0.766	2.60	2.56	5.16
DMXU2570VS	#F	●	0.257	1.22	1.54	2.76	DMXU7812VS	25/32	●	0.781	2.60	2.56	5.16
DMXU2610VS	#G	●	0.261	1.22	1.54	2.76							
DMXU2656VS	17/64	●	0.266	1.34	1.57	2.91							
DMXU2660VS	#H	●	0.266	1.34	1.57	2.91							
DMXU2720VS	#I	●	0.272	1.34	1.57	2.91							
DMXU2770VS	#J	●	0.277	1.34	1.57	2.91							
DMXU2810VS	#K	●	0.281	1.34	1.57	2.91							
DMXU2812VS	9/32	●	0.281	1.34	1.57	2.91							
DMXU2900VS	#L	●	0.290	1.34	1.57	2.91							
DMXU2950VS	#M	●	0.295	1.34	1.57	2.91							

Cutting fluid should be sufficiently supplied to the drill point and the entrance of the hole. ● : Line up
 Use a water soluble cutting fluid containing relatively high content of extreme pressure additive for heavy duty cutting or use a water-insoluble cutting fluid.

Reference pages: Standard cutting conditions → J059



DMXU L/D=3 (VM type)

Solidrill with 130° point angle without oil hole & shank size equal to drill dia., L/D = 3, dia = ø0.199" - ø0.781"

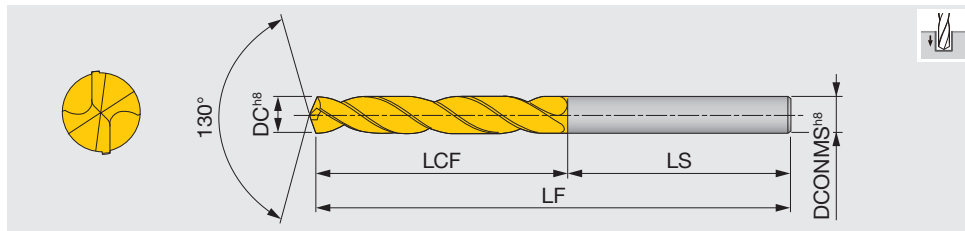

Inch	DC	AH170	DCONMS	LCF	LS	LF	Inch	DC	AH170	DCONMS	LCF	LS	LF
DMXU1990VM	#8	●	0.199	1.34	1.50	2.83	DMXU5625VM	9/16	●	0.562	3.50	2.44	5.94
DMXU2010VM	#7	●	0.201	1.34	1.50	2.83	DMXU5781VM	37/64	●	0.578	3.58	2.44	6.03
DMXU2031VM	13/64	●	0.203	1.34	1.50	2.83	DMXU5937VM	19/32	●	0.594	3.70	2.48	6.18
DMXU2040VM	#6	●	0.204	1.34	1.50	2.83	DMXU6094VM	39/64	●	0.609	3.70	2.48	6.18
DMXU2055VM	#5	●	0.206	1.34	1.50	2.83	DMXU6250VM	5/8	●	0.625	3.78	2.52	6.30
DMXU2090VM	#4	●	0.209	1.34	1.50	2.83	DMXU6330VM	TUBE	●	0.633	4.02	2.40	6.57
DMXU2130VM	#3	●	0.213	1.34	1.50	2.83	DMXU6406VM	41/64	●	0.641	4.02	2.40	6.57
DMXU2188VM	7/32	●	0.219	1.42	1.50	2.91	DMXU6562VM	21/32	●	0.656	4.02	2.40	6.57
DMXU2210VM	#2	●	0.221	1.34	1.50	2.91	DMXU6875VM	11/16	●	0.688	4.02	2.40	6.57
DMXU2280VM	#1	●	0.228	1.34	1.50	2.91	DMXU7031VM	45/64	●	0.703	4.02	2.40	6.57
DMXU2344VM	15/64	●	0.234	1.61	1.56	3.19	DMXU7187VM	23/32	●	0.719	4.49	2.40	7.05
DMXU2380VM	#B	●	0.238	1.34	1.58	3.19	DMXU7344VM	47/64	●	0.734	4.49	2.40	7.05
DMXU2420VM	#C	●	0.242	1.34	1.58	3.19	DMXU7500VM	3/4	●	0.750	4.49	2.40	7.05
DMXU2460VM	#D	●	0.246	1.34	1.58	3.19	DMXU7590VM	TUBE	●	0.759	4.49	2.40	7.05
DMXU2500VM	1/4	●	0.250	1.34	1.58	3.19	DMXU7656VM	49/64	●	0.766	4.49	2.40	7.05
DMXU2570VM	#F	●	0.257	1.69	1.57	3.27	DMXU7812VM	25/32	●	0.781	4.49	2.40	7.05
DMXU2610VM	#G	●	0.261	1.69	1.57	3.27							
DMXU2656VM	17/64	●	0.266	1.69	1.57	3.27							
DMXU2660VM	#H	●	0.266	1.69	1.57	3.27							
DMXU2720VM	#I	●	0.272	1.69	1.57	3.27							
DMXU2770VM	#J	●	0.277	1.77	1.65	3.43							
DMXU2810VM	#K	●	0.281	1.77	1.65	3.43							
DMXU2812VM	9/32	●	0.281	1.77	1.65	3.43							
DMXU2900VM	#L	●	0.290	1.77	1.65	3.43							
DMXU2950VM	#M	●	0.295	1.77	1.65	3.43							
DMXU2969VM	19/64	●	0.297	1.89	1.65	3.54							
DMXU3020VM	#N	●	0.302	1.77	1.65	3.54							
DMXU3125VM	5/16	●	0.313	1.77	1.65	3.54							
DMXU3160VM	#O	●	0.316	2.09	1.69	3.78							
DMXU3230VM	#P	●	0.323	2.09	1.69	3.78							
DMXU3281VM	21/64	●	0.328	2.09	1.69	3.78							
DMXU3320VM	#Q	●	0.332	2.09	1.69	3.78							
DMXU3390VM	#R	●	0.339	2.17	1.69	3.86							
DMXU3438VM	11/32	●	0.344	2.17	1.69	3.86							
DMXU3480VM	#S	●	0.348	2.17	1.69	3.86							
DMXU3580VM	#T	●	0.358	2.28	1.73	4.02							
DMXU3594VM	23/64	●	0.359	2.28	1.73	4.02							
DMXU3680VM	#U	●	0.368	2.28	1.73	4.02							
DMXU3750VM	3/8	●	0.375	2.36	1.77	4.13							
DMXU3770VM	#V	●	0.377	2.36	1.77	4.13							
DMXU3860VM	#W	●	0.386	2.36	1.77	4.13							
DMXU3906VM	25/64	●	0.390	2.36	1.77	4.13							
DMXU3970VM	#X	●	0.397	2.60	1.81	4.41							
DMXU4040VM	#Y	●	0.404	2.60	1.81	4.41							
DMXU4062VM	13/32	●	0.406	2.60	1.81	4.41							
DMXU4130VM	#Z	●	0.413	2.60	1.81	4.41							
DMXU4219VM	27/64	●	0.422	2.67	1.81	4.49							
DMXU4375VM	7/16	●	0.438	2.80	1.85	4.65							
DMXU4531VM	29/64	●	0.453	2.87	1.89	4.76							
DMXU4688VM	15/32	●	0.469	2.87	1.89	4.76							
DMXU4844VM	31/64	●	0.484	2.99	2.32	5.32							
DMXU5000VM	1/2	●	0.500	3.07	2.32	5.39							
DMXU5050VM	TUBE	●	0.505	3.07	2.32	5.39							
DMXU5156VM	33/64	●	0.516	3.31	2.36	5.67							
DMXU5312VM	17/32	●	0.531	3.31	2.36	5.67							
DMXU5469VM	35/64	●	0.547	3.39	2.40	5.79							

Cutting fluid should be sufficiently supplied to the drill point and the entrance of the hole.
 Use a water soluble cutting fluid containing relatively high content of extreme pressure additive for heavy duty cutting or use a water-insoluble cutting fluid.

● : Line up

Reference pages: Standard cutting conditions → J059

STANDARD CUTTING CONDITIONS

ISO	Workpiece material	Examples (JIS)	Hardness	Cutting speed Vc (sfm)	Feed: f (ipr)			
					ø0.118 ~ ø0.197	ø0.197 ~ ø0.394	ø0.394 ~ ø0.630	ø0.630 ~ ø0.787
P	Mild steels · Low Carbon steels	1018, etc.	< 180HB	131 - 262	0.006 - 0.010	0.006 - 0.012	0.008 - 0.016	0.010 - 0.020
	Carbon steels · Alloy steels	1045, etc.	180 ~ 300HB	131 - 262	0.006 - 0.010	0.006 - 0.012	0.008 - 0.016	0.010 - 0.020
	High alloy steels, etc.	4140, etc.	250 ~ 350HB	131 - 230	0.004 - 0.008	0.006 - 0.010	0.006 - 0.012	0.008 - 0.016
M	Stainless steels	304SS, etc.	< 200HB	66 - 131	0.002 - 0.008	0.004 - 0.010	0.004 - 0.012	0.006 - 0.012
K	Gray cast irons	Class 25, etc.	< 300HB	131 - 262	0.006 - 0.014	0.010 - 0.018	0.012 - 0.024	0.014 - 0.026
	Ductile cast irons	60-40-18, etc.	< 300HB	131 - 262	0.006 - 0.012	0.008 - 0.016	0.010 - 0.020	0.012 - 0.024
S	Titanium alloys	Ti-6Al-4V, etc.		66 - 131	0.004 - 0.008	0.006 - 0.010	0.006 - 0.012	0.008 - 0.016
	Heat-resistant alloys	Inconel 718, etc.	250HB <	33 - 98	0.001 - 0.003	0.002 - 0.004	0.003 - 0.005	0.003 - 0.005
H	Hardened material		< 45HRC	33 - 98	0.001 - 0.003	0.002 - 0.004	0.003 - 0.005	0.003 - 0.005

Because the cutting conditions may be changed depending on the material type, hardness, machinability, machine tool, and coolant, the most appropriate conditions must be decided whilst referring the chip control condition and tool failure mode.

When using the smaller side of the diameter range, the feed rate should be set lower.

When drilling difficult-to-cut materials, coolant supplying conditions are critical for successful drilling. So, the use of constant and flood coolant is highly recommended.

For the standard DMX-type drills, somewhat large honing width intended for drilling of general steels is applied. But, when drilling difficult-to-cut materials having high hardness, requiring lowering the feed rate, the honing width should be modified.

The drills with special honing specification are made to order on request.

Inconel is trademark of Huntington Alloys, Inc.

Grade
Insert
Ext. Toolholder
Int. Toolholder
Threading
Grooving
Miniature Tool
Milling Cutter
Endmill
Drilling Tool
Tooling System
User's Guide
Index



FDCU

Straight flute solid drill for high feed drilling of aluminum and cast iron, with oil hole

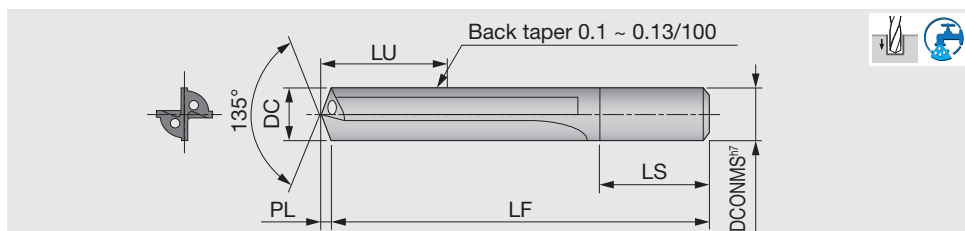
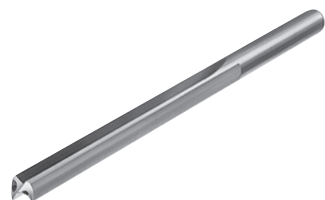

L/D = 5 (S type)

Inch	DC	G1F	DCONMS	LU	LS	LF
FDCU203S	0.2031	●	0.2362	1.73	1.57	3.35
FDCU218S	0.2188	●	0.2362	1.89	1.57	3.54
FDCU234S	0.2344	●	0.2362	1.89	1.57	3.54
FDCU265S	0.2656	●	0.2756	2.20	1.57	3.94
FDCU296S	0.2969	●	0.3150	2.52	1.65	4.33
FDCU312S	0.3125	●	0.3150	2.52	1.65	4.33
FDCU328S	0.3281	●	0.3543	2.68	1.73	4.53

L/D = 8 (L type)

Inch	DC	G1F	DCONMS	LU	LS	LF
FDCU218L	0.2188	●	0.2362	2.60	1.57	4.33
FDCU250L	0.2500	●	0.2756	2.83	1.57	4.53
FDCU265L	0.2656	●	0.2756	3.03	1.57	4.72
FDCU281L	0.2813	●	0.3150	3.27	1.65	4.92
FDCU328L	0.3281	●	0.3543	3.70	1.73	5.51
FDCU343L	0.3438	●	0.3543	3.90	1.73	5.71

DC	Tool diameter tolerance
0.2031 ≤ DC ≤ 0.2344	+0.0008 ~ +0.0004
0.2344 < DC ≤ 0.3281	+0.0010 ~ +0.0006

● : Line up

DC	Tool diameter tolerance
0.2188 ≤ DC	+0.0008 ~ +0.0004
0.2500 < DC ≤ 0.3438	+0.0010 ~ +0.0006

● : Line up

FDC-S L/D=5

Solid drill for cast iron and aluminum alloy, with straight flute, 135° point angle, with coolant hole, L/D = 5, ø5.1 - ø16 mm

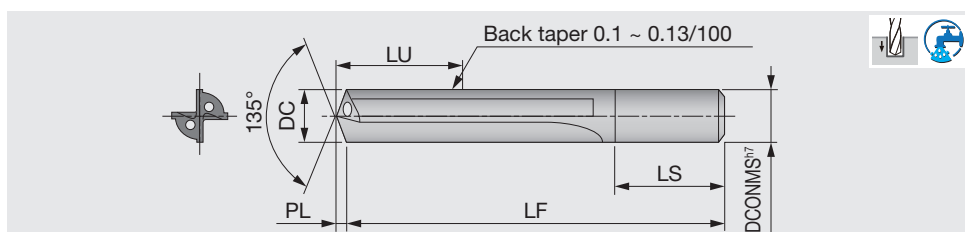
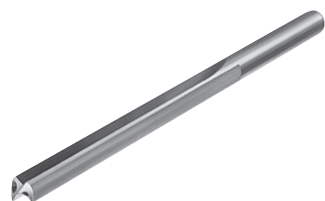

Metric	DC	G1F	DCONMS	LU	LS	LF	PL
FDC0510S	5.1	●	6	45.1	40	85	1.06
FDC0600S	6	●	6	49.2	40	90	1.24
FDC0840S	8.4	●	9	69.7	44	115	1.74
FDC0860S	8.6	●	9	73.8	44	120	1.78
FDC1050S	10.5	●	11	86.2	46	140	2.17
FDC1100S	11	●	11	90.3	46	140	2.28
FDC1150S	11.5	●	12	94.4	48	150	2.38
FDC1200S	12	●	12	98.5	48	150	2.49

Metric	DC	G1F	DCONMS	LU	LS	LF	PL
FDC1250S	12.5	●	13	102.6	50	160	2.59
FDC1300S	13	●	13	106.7	50	160	2.69
FDC1350S	13.5	●	14	110.8	52	170	2.8
FDC1400S	14	●	14	114.9	52	170	2.9
FDC1450S	14.5	●	15	119	54	180	3
FDC1500S	15	●	15	123.1	54	180	3.11
FDC1550S	15.5	●	16	127.2	56	190	3.21
FDC1600S	16	●	16	131.3	56	190	3.31

DC	Tolerance (mm)
5 ≤ DC ≤ 6	+0.02 ~ +0.01
6 < DC ≤ 16	+0.025 ~ +0.015

● : Line up

Coolant

- Supply coolant through the inside of a drill.
- The coolant pressure should be 0.5 to 1 MPa.
- Use water-soluble coolant containing a large amount of extreme pressure additive.

Reference pages: Standard cutting conditions → J061

FDC-L L/D=8

Solid drill for cast iron and aluminum alloy, with straight flute, 135° point angle, with coolant hole, L/D = 8, $\phi 5 - \phi 10$ mm

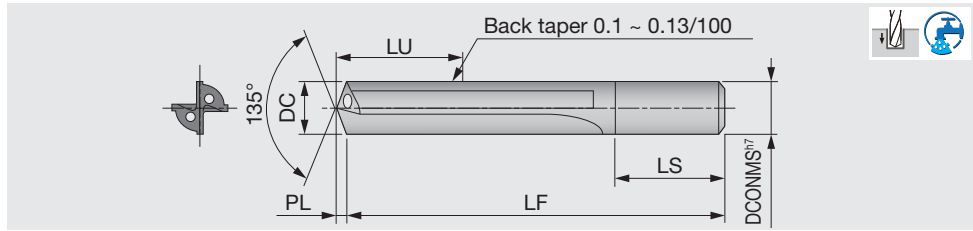
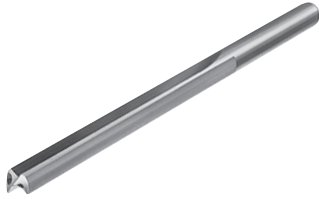

Metric	DC	G1F	DCONMS	LU	LS	LF	PL
FDC0500L	5	●	5	56	38	95	1.04
FDC0550L	5.5	●	6	62.1	40	105	1.14
FDC0600L	6	●	6	67.2	40	110	1.24
FDC0620L	6.2	●	7	73.3	40	115	1.28
FDC0650L	6.5	●	7	73.4	40	115	1.35
FDC0680L	6.8	●	7	78.4	40	120	1.41
FDC0700L	7	●	7	78.5	40	120	1.45
FDC0750L	7.5	●	8	84.6	42	125	1.55

Metric	DC	G1F	DCONMS	LU	LS	LF	PL
FDC0780L	7.8	●	8	89.6	42	130	1.62
FDC0800L	8	●	8	89.7	42	130	1.66
FDC0850L	8.5	●	9	95.8	44	140	1.76
FDC0860L	8.6	●	9	100.8	44	145	1.78
FDC0900L	9	●	9	100.9	44	145	1.86
FDC0950L	9.5	●	10	107	44	150	1.97
FDC1000L	10	●	10	112.1	46	160	2.07

● : Line up

DC	Tolerance (mm)
5 ≤ DC ≤ 6	+0.02 ~ +0.01
6 < DC < 10	+0.025 ~ +0.015

Coolant

- Supply coolant through the inside of a drill.
- The coolant pressure should be 0.5 to 1 MPa.
- Use water-soluble coolant containing a large amount of extreme pressure additive.

STANDARD CUTTING CONDITIONS

ISO	Workpiece material	Cutting speed: Vc (sfm)			Feed: f (ipr)		
		$\phi 5 \sim \phi 8$ $\phi 0.1969 - \phi 0.3150$	$\phi 8 \sim \phi 12$ $\phi 0.3150 - \phi 0.4724$	$\phi 12 \sim \phi 16$ $\phi 0.4724 - \phi 0.6300$	$\phi 5 \sim \phi 8$ $\phi 0.1969 - \phi 0.3150$	$\phi 8 \sim \phi 12$ $\phi 0.3150 - \phi 0.4724$	$\phi 12 \sim \phi 16$ $\phi 0.4724 - \phi 0.6300$
N	Aluminum alloys	330 - 460	390 - 520	460 - 590	0.004 - 0.010	0.006 - 0.012	0.006 - 0.012
K	Gray cast irons	300 - 390	360 - 460	430 - 520	0.004 - 0.010	0.006 - 0.012	0.008 - 0.012
	Ductile cast irons	200 - 260	230 - 300	230 - 330	0.004 - 0.010	0.006 - 0.012	0.006 - 0.012

Caution: When changing a tool, completely clean the chips which may be clogged in the collet or adapter.

Note: The cutting conditions shown above may vary depending on the work material, coolant dilution ratio and coolant supply pressure used.

CUTTING PERFORMANCE

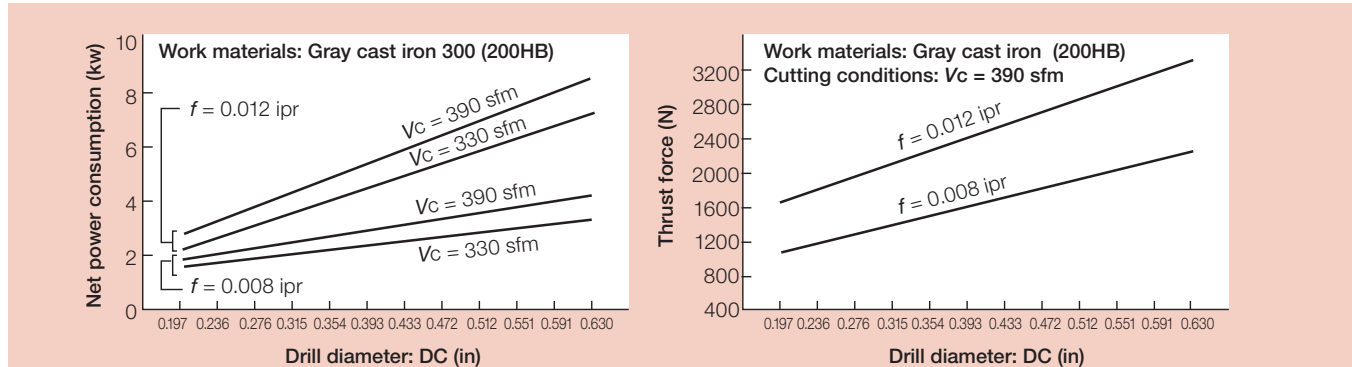



TungSix-Drill

Indexable drill

Inch Metric

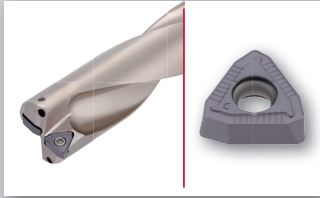

TUNGSIX-DRILL

Indexable drill with 6-corner inserts for high productivity



ø0.750" - ø2.000" / L/D = 2, 3, 4

J006,
J064 - J073



TUNGDRILLTWISTED

Indexable drill with 4-corner inserts for various drilling applications



ø0.500" - ø2.125" / L/D = 2, 3, 4, 5

J006,
J074 - J084

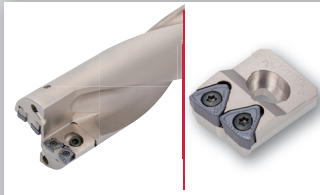

TUNGDRILLBIG

Large diameter drill with cartridges for TungSix-Drill and TungDrillTwisted inserts



ø2.250" - ø3.150" / L/D = 2.5

J006,
J085 - J091





Indexable drill

6 cornered insert with high performance and high economical solution

Double-sided insert with 6-cutting edges

TungSixDrill is the first indexable drill in the world to adapt double-sided inserts with 6-cutting edges, reducing the insert consumption for the customers.

One insert type for both the central and peripheral pockets

One side has the central edge and other side has the peripheral edge.

Low cutting force even with double sided insert

The cutting forces are almost equal to competitors positive single sided inserts, especially at higher feed rates, thus complementing higher productivity.

Peripheral side

Central side

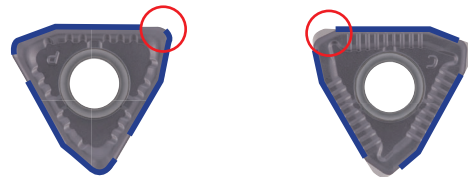

Optimal distance between each cutting edge

Prevents the overlapping of damaged edges



TUNGSIX-DRILL

TDSU-F L/D=2

L/D = 2, flat, tool diameter $\phi 0.812'' - \phi 1.062''$

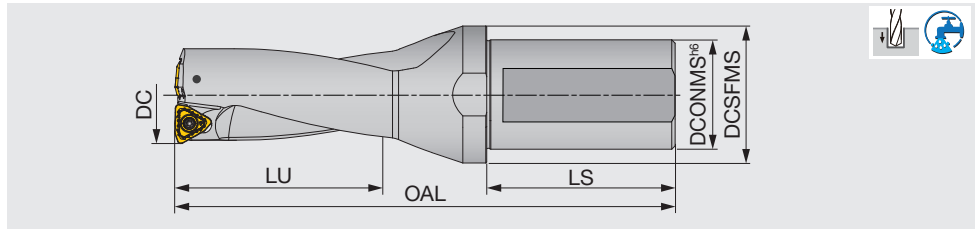

Inch	DC	DCONMS	DCSFMS	LU	LS	OAL	Max. offset** (radial)	WT(lb)	Insert
TDSU-0750FS-02***	0.750	1.000	1.457	1.500	2.280	4.897	0.004	0.365	WWMU05X205R-D*
TDSU0812F-2	0.812	1.000	1.457	1.657	2.205	4.697	0.031	0.7	WWMU05X205R-D*
TDSU0875F-2	0.875	1.000	1.457	1.782	2.205	4.862	0.020	0.7	WWMU05X205R-D*
TDSU0937F-2	0.937	1.000	1.457	1.911	2.205	5.028	0.047	0.9	WWMU060306R-D*
TDSU1000F-2	1.000	1.000	1.457	2.035	2.205	5.197	0.026	0.9	WWMU060306R-D*
TDSU1062F-2	1.062	1.250	1.575	2.161	2.342	5.500	0.012	1.3	WWMU060306R-D*

** For offsetting on lathe *** Drill with side port

SPARE PARTS

Designation	Clamping screw	Wrench
TDSU-0750FS-02	CSPB-2.2	IP-7D
TDSU0812... - TDSU0875...	CSPB-2.2	IP-7D
TDSU0937... - TDSU1062...	CSPB-2.5	IP-8D

Tool diameter	Tool diameter tolerance	Hole diameter tolerance*
$\phi 0.750 - \phi 1.062$	+ 0.008 / 0	+ 0.014 / 0

*Just for reference

Recommended clamping torque:
CSPB-2.2 = 0.74 lb-ft, CSPB-2.5 = 2.87 lb-ft

TUNGSIX-DRILL

TDSU L/D=2

L/D = 2, Whistle notch, tool diameter $\phi 1.125'' - \phi 2.000''$

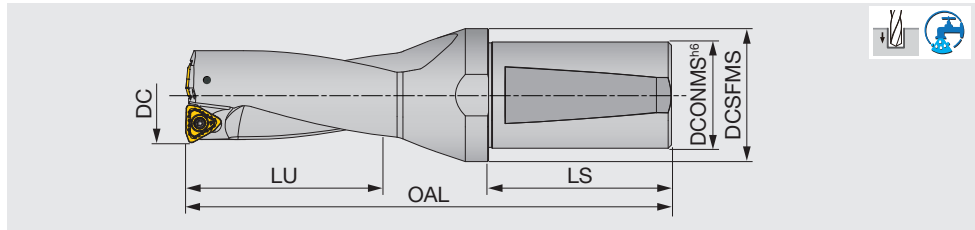

Inch	DC	DCONMS	DCSFMS	LU	LS	OAL	Max. offset** (radial)	WT(lb)	Insert
TDSU1125-02	1.125	1.250	1.575	2.250	2.280	5.892	0.043	1.5	WWMU08X408R-D*
TDSU1187-02	1.187	1.250	1.575	2.374	2.280	6.079	0.019	1.6	WWMU08X408R-D*
TDSU1250-02	1.250	1.250	1.575	2.500	2.280	6.267	0.008	1.7	WWMU08X408R-D*
TDSU1312-02	1.312	1.500	1.969	2.624	2.688	6.862	0.055	2.5	WWMU09X510R-D*
TDSU1375-02	1.375	1.500	1.969	2.750	2.688	7.049	0.047	2.6	WWMU09X510R-D*
TDSU1437-02	1.437	1.500	1.969	2.874	2.688	7.237	0.027	2.8	WWMU09X510R-D*
TDSU1500-02	1.500	1.500	1.969	3.000	2.688	7.424	0.015	2.9	WWMU09X510R-D*
TDSU1562-02	1.562	1.500	1.969	3.124	2.688	7.612	0.074	3.0	WWMU11X512R-D*
TDSU1625-02	1.625	1.500	2.165	3.250	2.688	7.799	0.059	3.3	WWMU11X512R-D*
TDSU1687-02	1.687	1.500	2.165	3.374	2.688	7.987	0.051	3.5	WWMU11X512R-D*
TDSU1750-02	1.750	1.500	2.165	3.500	2.688	8.174	0.027	3.7	WWMU11X512R-D*
TDSU1812-02	1.812	1.500	2.165	3.624	2.688	8.362	0.015	3.9	WWMU11X512R-D*
TDSU1875-02	1.875	1.500	2.165	3.750	2.688	8.549	0.094	4.2	WWMU13X512R-D*
TDSU1937-02	1.937	1.500	2.165	3.874	2.688	8.737	0.078	4.3	WWMU13X512R-D*
TDSU2000-02	2.000	1.500	2.165	4.000	2.688	8.924	0.067	4.6	WWMU13X512R-D*

** For offsetting on lathe

SPARE PARTS

Designation	Clamping screw	Wrench
TDSU1125... - TDSU1250...	CSTB-3	T-9D
TDSU1312... - TDSU1500...	CSTB-4	T-15D
TDSU1562... - TDSU2000...	CSTB-5	T-20D

Tool diameter	Tool diameter tolerance	Hole diameter tolerance*
$\phi 1.125 - \phi 2.000$	+ 0.004	+ 0.008 / -0.004

*Just for reference

Recommended clamping torque:
CSTB-3 = 1.70 lb-ft, CSTB-4 = 2.58 lb-ft, CSTB-5 = 3.69 lb-ft

Reference pages: Inserts → **J068**, Standard cutting conditions → **J070 - J071**

TUNGSIX-DRILL

TDSU-F L/D=3

L/D = 3, flat, tool diameter $\phi 0.812'' - \phi 1.062''$

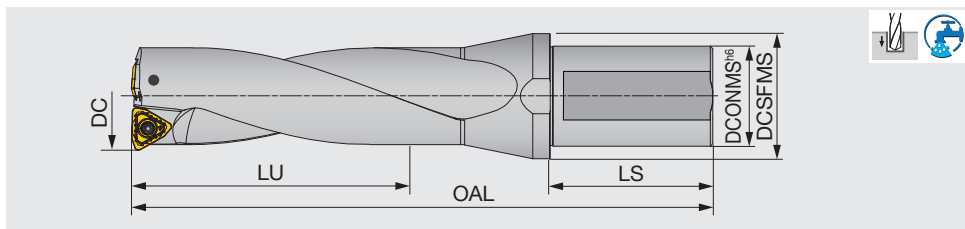

Inch	DC	DCONMS	DCSFMS	LU	LS	OAL	Max. offset** (radial)	WT(lb)	Insert
TDSU-0750FS-03***	0.750	1.000	1.457	2.250	2.280	5.653	0.004	0.38	WWMU05X205R-D*
TDSU0812F-3	0.812	1.000	1.457	2.470	2.205	5.547	0.031	0.7	WWMU05X205R-D*
TDSU0875F-3	0.875	1.000	1.457	2.657	2.205	5.697	0.020	0.7	WWMU05X205R-D*
TDSU0937F-3	0.937	1.000	1.457	2.848	2.205	5.929	0.047	0.9	WWMU060306R-D*
TDSU1000F-3	1.000	1.000	1.457	3.035	2.205	6.157	0.026	0.9	WWMU060306R-D*
TDSU1062F-3	1.062	1.250	1.575	3.221	2.342	6.524	0.012	1.3	WWMU060306R-D*

** For offsetting on lathe *** Drill with side port

SPARE PARTS

Designation	Clamping screw	Wrench
TDSU-0750FS-03	CSPB-2.2	IP-7D
TDSU0812... - TDSU0875...	CSPB-2.2	IP-7D
TDSU0937... - TDSU1062...	CSPB-2.5	IP-8D

Tool diameter	Tool diameter tolerance	Hole diameter tolerance*
$\phi 0.750 - \phi 1.062$	+ 0.008 / 0	+ 0.014 / 0

*Just for reference

Recommended clamping torque:

CSPB-2.2 = 0.74 lb-ft, CSPB-2.5 = 2.87 lb-ft

TUNGSIX-DRILL

TDSU L/D=3

L/D = 3, Whistle notch, tool diameter $\phi 1.125'' - \phi 2.000''$

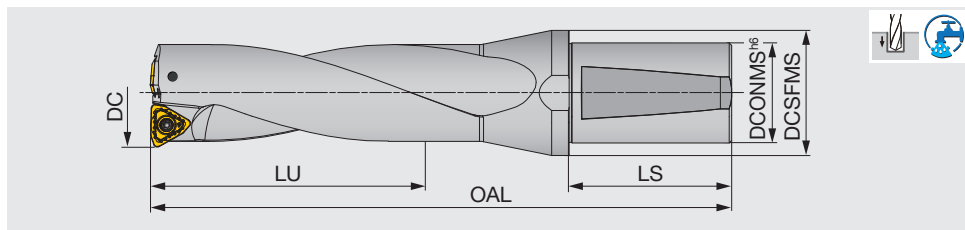

Inch	DC	DCONMS	DCSFMS	LU	LS	OAL	Max. offset** (radial)	WT(lb)	Insert
TDSU1125-03	1.125	1.250	1.575	3.375	2.280	7.017	0.043	1.7	WWMU08X408R-D*
TDSU1187-03	1.187	1.250	1.575	3.561	2.280	7.267	0.019	1.8	WWMU08X408R-D*
TDSU1250-03	1.250	1.250	1.575	3.750	2.280	7.517	0.008	1.9	WWMU08X408R-D*
TDSU1312-03	1.312	1.500	1.969	3.936	2.688	8.174	0.055	2.8	WWMU09X510R-D*
TDSU1375-03	1.375	1.500	1.969	4.125	2.688	8.424	0.047	2.9	WWMU09X510R-D*
TDSU1437-03	1.437	1.500	1.969	4.311	2.688	8.674	0.027	3.1	WWMU09X510R-D*
TDSU1500-03	1.500	1.500	1.969	4.500	2.688	8.924	0.015	3.3	WWMU09X510R-D*
TDSU1562-03	1.562	1.500	1.969	4.686	2.688	9.174	0.074	3.4	WWMU11X512R-D*
TDSU1625-03	1.625	1.500	2.165	4.875	2.688	9.424	0.059	3.8	WWMU11X512R-D*
TDSU1687-03	1.687	1.500	2.165	5.061	2.688	9.674	0.051	4.1	WWMU11X512R-D*
TDSU1750-03	1.750	1.500	2.165	5.250	2.688	9.924	0.027	4.3	WWMU11X512R-D*
TDSU1812-03	1.812	1.500	2.165	5.436	2.688	10.174	0.015	4.6	WWMU11X512R-D*
TDSU1875-03	1.875	1.500	2.165	5.625	2.688	10.424	0.094	4.9	WWMU13X512R-D*
TDSU1937-03	1.937	1.500	2.165	5.811	2.688	10.674	0.078	5.1	WWMU13X512R-D*
TDSU2000-03	2.000	1.500	2.165	6.000	2.688	10.924	0.067	5.5	WWMU13X512R-D*

** For offsetting on lathe

SPARE PARTS

Designation	Clamping screw	Wrench
TDSU1125... - TDSU1250...	CSTB-3	T-9D
TDSU1312... - TDSU1500...	CSTB-4	T-15D
TDSU1562... - TDSU2000...	CSTB-5	T-20D

Tool diameter	Tool diameter tolerance	Hole diameter tolerance*
$\phi 1.125 - \phi 2.000$	+ 0.004	+ 0.008 / -0.004

*Just for reference

Recommended clamping torque:

CSTB-3 = 1.70 lb-ft, CSTB-4 = 2.58 lb-ft, CSTB-5 = 3.69 lb-ft

Reference pages: Inserts → **J068**, Standard cutting conditions → **J070 - J071**

TUNGSIK-DRILL

TDSU-F L/D=4

L/D = 4, flat, tool diameter $\varnothing 0.812'' - \varnothing 2.000''$

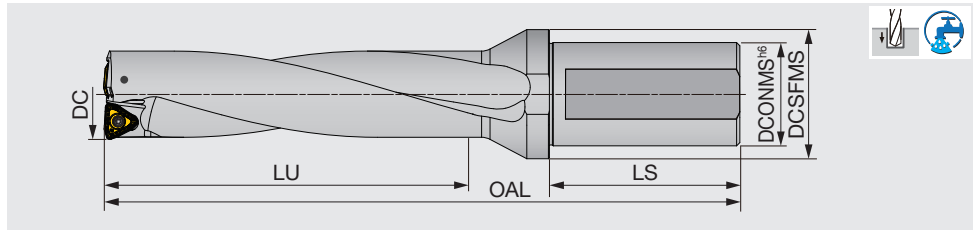

Inch	DC	DCONMS	DCSFMS	LU	LS	OAL	Max. offset** (radial)	WT(lb)	Insert
TDSU-0750FS-04***	0.750	1.000	1.457	3.000	2.280	6.401	0.004	0.4	WWMU05X205R-D*
TDSU0812F-4	0.812	1.000	1.457	3.250	2.343	6.457	0.031	0.7	WWMU05X205R-D*
TDSU0875F-4	0.875	1.000	1.457	3.500	2.343	6.669	0.016	0.7	WWMU05X205R-D*
TDSU0937F-4	0.938	1.000	1.457	3.750	2.343	6.969	0.047	0.9	WWMU060306R-D*
TDSU1000F-4	1.000	1.000	1.457	4.000	2.343	7.260	0.024	0.9	WWMU060306R-D*
TDSU1062F-4	1.063	1.250	1.575	4.250	2.343	7.551	0.012	1.3	WWMU060306R-D*
TDSU1125F-4	1.125	1.250	1.575	4.500	2.343	7.897	0.043	1.5	WWMU08X408R-D*
TDSU1187F-4	1.187	1.250	1.575	4.748	2.343	8.179	0.019	1.6	WWMU08X408R-D*
TDSU1250F-4	1.250	1.250	1.575	5.000	2.343	8.470	0.008	1.7	WWMU08X408R-D*
TDSU1312F-4	1.312	1.500	1.969	5.248	2.736	9.161	0.055	2.5	WWMU09X510R-D*
TDSU1375F-4	1.375	1.500	1.969	5.500	2.736	9.452	0.047	2.6	WWMU09X510R-D*
TDSU1437F-4	1.437	1.500	1.969	5.748	2.736	9.744	0.027	2.8	WWMU09X510R-D*
TDSU1500F-4	1.500	1.500	1.969	6.000	2.736	10.034	0.015	2.9	WWMU09X510R-D*
TDSU1625F-4	1.625	1.500	2.165	6.500	2.736	10.643	0.059	3.3	WWMU11X512R-D*
TDSU1687F-4	1.687	1.500	2.165	6.748	2.736	10.934	0.051	3.5	WWMU11X512R-D*
TDSU1750F-4	1.750	1.500	2.165	7.000	2.736	11.226	0.027	3.7	WWMU11X512R-D*
TDSU1812F-4	1.812	1.500	2.165	7.248	2.736	11.517	0.015	3.9	WWMU11X512R-D*
TDSU1875F-4	1.875	1.500	2.165	7.500	2.736	11.815	0.094	4.2	WWMU13X512R-D*
TDSU1937F-4	1.937	1.500	2.165	7.748	2.736	12.036	0.078	4.3	WWMU13X512R-D*
TDSU2000F-4	2.000	1.500	2.165	8.000	2.736	12.327	0.067	4.6	WWMU13X512R-D*

** For offsetting on lathe *** Drill with side port

SPARE PARTS

Designation	Clamping screw	Wrench
TDSU-0750FS-04	CSPB-2.2	IP-7D
TDSU0812... - TDSU0875...	CSPB-2.2	IP-7D
TDSU0937... - TDSU1062...	CSPB-2.5	IP-8D
TDSU1125... - TDSU1250...	CSTB-3	T-9D
TDSU1312... - TDSU1500...	CSTB-4	T-15D
TDSU1562... - TDSU2000...	CSTB-5	T-20D

Recommended clamping torque: CSPB-2.2 = 0.74 lb-ft, CSPB-2.5 = 2.87 lb-ft, CSTB-3 = 1.70 lb-ft, CSTB-4 = 2.58 lb-ft, CSTB-5 = 3.69 lb-ft

Tool diameter	Tool diameter tolerance	Hole diameter tolerance*
$\varnothing 0.750 - \varnothing 2.000$	+ 0.008 / 0	+ 0.014 / 0

*Just for reference

Reference pages: Inserts → **J068**, Standard cutting conditions → **J070 - J071**

Grade
Insert
Toolholder
Ext. Toolholder
Int. Toolholder
Threading
Grooving
Miniature Tool
Endmill
Drilling Tool
Tooling System
User's Guide
Index



INSERT

DJ

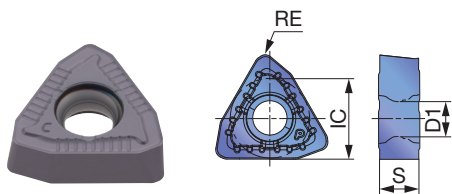

P	Steel	☆	★						
M	Stainless	★	☆						
K	Cast iron	☆	★						
N	Non-ferrous	☆	☆						
S	Superalloys	★	☆						
H	Hard materials	★	☆						

★ : First choice
 ☆ : Second choice

Designation	IC (in)	S (in)	Coated		D1 (in)	RE (in)	DCN (in)	DCX (in)
			AH3135	AH9030				
WWMU05X205R-DJ	0.228	0.094	●	●	0.098	0.020	0.812	0.875
WWMU060306R-DJ	0.264	0.114	●	●	0.118	0.024	0.937	1.062
WWMU08X408R-DJ	0.315	0.154	●	●	0.134	0.031	1.125	1.250
WWMU09X510R-DJ	0.382	0.193	●	●	0.173	0.039	1.312	1.500
WWMU11X512R-DJ	0.445	0.224	●	●	0.217	0.047	1.562	1.812
WWMU13X512R-DJ	0.512	0.224	●	●	0.217	0.047	1.875	2.000

● : Line up

DS

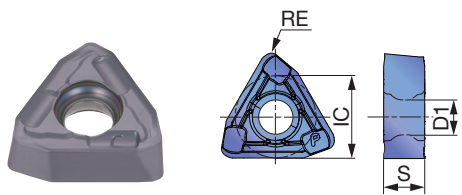

P	Steel	★						
M	Stainless	★						
K	Cast iron							
N	Non-ferrous	★						
S	Superalloys	★						
H	Hard materials							





★ : First choice
 ☆ : Second choice

Designation	IC (in)	S (in)	Coated		D1 (in)	RE (in)	DCN (in)	DCX (in)
			AH6030					
WWMU05X205R-DS	0.228	0.094	●		0.098	0.020	0.812	0.925
WWMU060306R-DS	0.264	0.114	●		0.118	0.024	0.941	1.063
WWMU08X408R-DS	0.315	0.154	●		0.134	0.031	1.125	1.250
WWMU09X510R-DS	0.382	0.193	●		0.173	0.039	1.312	1.500
WWMU11X512R-DS	0.445	0.224	●		0.217	0.047	1.562	1.812
WWMU13X512R-DS	0.512	0.224	●		0.217	0.047	1.875	2.000

● : Line up

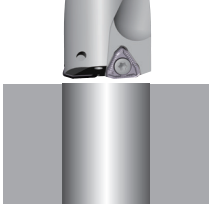
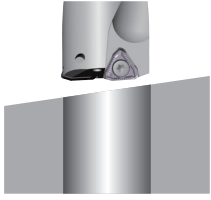
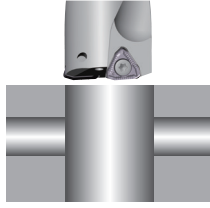
APPLICATION RANGE

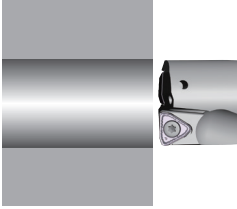
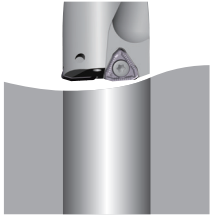
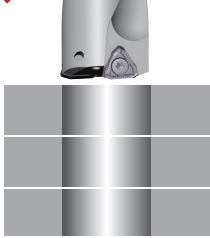
*In case of Interrupted cutting, feed should be decreased.

Feed <i>f</i> (ipr)	Refer to J060 - J061 page	0.002	0.002	0.002
Application range	OK Plane surface 	OK Slant surface 	OK Cross hole 	OK Plunging 
Feed <i>f</i> (ipr)	0.004	0.002	Disapprove	Disapprove
Application range	OK Boring 	OK Round surface 	X Stacked plates 	X Back boring 

Grade
A
B
C
D
E
F
G
H
I
J
K
L
M

Insert
Toolholder
Ext. Toolholder
Int. Toolholder
Threading
Grooving
Milling Cutter
Miniature Tool
Endmill
Drilling Tool
Tooling System
User's Guide
Index

STANDARD CUTTING CONDITIONS



ISO	Workpiece materials	Priority	Chip breakers	Grade	Cutting speed Vc (sfm)
P	Low carbon steels (C < 0.3) 1018, 1020, 1026, etc.	First choice	DS	AH6030	525 - 820
		Wear resistance	DJ	AH9030	525 - 1050
	Carbon steels (C > 0.3) 1045, 1055, etc.	First choice	DJ	AH9030	262 - 820
		Fracture resistance	DJ	AH3135	262 - 820
	Low alloy steels 5120, etc.	First choice	DS	AH6030	525 - 820
		Wear resistance	DJ	AH9030	525 - 820
Alloy steels 4140, 8620, etc.	First choice	DJ	AH9030	262 - 656	
	Fracture resistance	DJ	AH3135	262 - 656	
M	Stainless steels (Austenitic) 304SS, 316SS, etc.	First choice	DS	AH6030	328 - 656
		Fracture resistance	DJ	AH3135	328 - 656
	Stainless steels (Martensitic and ferritic) 430SS, 416SS, etc.	First choice	DS	AH6030	328 - 656
		Fracture resistance	DJ	AH3135	328 - 656
	Stainless steels (Precipitation hardening) 17-4 PH, etc.	First choice	DS	AH6030	262 - 394
		Fracture resistance	DJ	AH3135	262 - 394
K	Gray cast irons Class 25, Class 30, etc.	First choice	DJ	AH9030	262 - 820
		Fracture resistance	DJ	AH3135	262 - 656
	Ductile cast irons 60-40-18, 60-55-06, etc.	First choice	DJ	AH9030	262 - 656
		Fracture resistance	DJ	AH3135	262 - 492
N	Aluminum alloy	First choice	DS	AH6030	656 - 1312
S	Heat resistant alloy Inconel718, etc.	First choice	DS	AH6030	66 - 197
		Fracture resistance	DJ	AH3135	66 - 197
	Titanium alloys Ti-6Al-4V, etc.	First choice	DS	AH6030	131 - 394
		Fracture resistance	DJ	AH3135	131 - 394
H	Hardened steel Over 40HRC	First choice	DJ	AH9030	164 - 328
		Fracture resistance	DJ	AH3135	131 - 262

Feed: f (ipr)

	L/D = 2, 3			L/D = 4		
	DC (in)			DC (in)		
$\phi 0.787 - \phi 1.083$	$\phi 1.102 - \phi 1.496$	$\phi 1.535 - \phi 2.126$	$\phi 0.787 - \phi 1.063$	$\phi 1.102 - \phi 1.496$	$\phi 1.353 - \phi 2.126$	
0.0016 - 0.0039	0.0016 - 0.0039	0.0016 - 0.0039	0.0016 - 0.0039	0.0016 - 0.0039	0.0016 - 0.0039	
0.0016 - 0.0039	0.0016 - 0.0039	0.0016 - 0.0039	0.0016 - 0.0039	0.0016 - 0.0039	0.0016 - 0.0039	
0.0024 - 0.0059	0.0024 - 0.0063	0.0031 - 0.0071	0.0024 - 0.0059	0.0024 - 0.0059	0.0031 - 0.0067	
0.0016 - 0.0047	0.0016 - 0.0051	0.0016 - 0.0059	0.0016 - 0.0047	0.0016 - 0.0051	0.0016 - 0.0059	
0.0016 - 0.0047	0.0016 - 0.0047	0.0016 - 0.0047	0.0016 - 0.0047	0.0016 - 0.0047	0.0016 - 0.0047	
0.0024 - 0.0047	0.0024 - 0.0055	0.0024 - 0.0055	0.0024 - 0.0047	0.0024 - 0.0055	0.0024 - 0.0055	
0.0024 - 0.0059	0.0024 - 0.0063	0.0031 - 0.0071	0.0024 - 0.0059	0.0024 - 0.0059	0.0031 - 0.0067	
0.0016 - 0.0047	0.0016 - 0.0051	0.0016 - 0.0059	0.0016 - 0.0047	0.0016 - 0.0051	0.0016 - 0.0059	
0.0016 - 0.0039	0.0016 - 0.0047	0.0016 - 0.0047	0.0016 - 0.0047	0.0016 - 0.0047	0.0016 - 0.0047	
0.0016 - 0.0039	0.0016 - 0.0047	0.0016 - 0.0047	0.0016 - 0.0047	0.0016 - 0.0047	0.0016 - 0.0047	
0.0016 - 0.0039	0.0016 - 0.0047	0.0016 - 0.0047	0.0016 - 0.0047	0.0016 - 0.0047	0.0016 - 0.0047	
0.0016 - 0.0039	0.0016 - 0.0047	0.0016 - 0.0047	0.0016 - 0.0047	0.0016 - 0.0047	0.0016 - 0.0047	
0.0016 - 0.0039	0.0016 - 0.0039	0.0016 - 0.0039	0.0016 - 0.0039	0.0016 - 0.0039	0.0016 - 0.0039	
0.0016 - 0.0039	0.0016 - 0.0039	0.0016 - 0.0039	0.0016 - 0.0039	0.0016 - 0.0039	0.0016 - 0.0039	
0.0024 - 0.0059	0.0024 - 0.0071	0.0031 - 0.0079	0.0024 - 0.0059	0.0024 - 0.0063	0.0031 - 0.0071	
0.0024 - 0.0051	0.0024 - 0.0063	0.0031 - 0.0071	0.0024 - 0.0051	0.0024 - 0.0063	0.0031 - 0.0071	
0.0024 - 0.0059	0.0024 - 0.0071	0.0031 - 0.0079	0.0024 - 0.0059	0.0024 - 0.0063	0.0031 - 0.0071	
0.0024 - 0.0051	0.0024 - 0.0063	0.0031 - 0.0071	0.0024 - 0.0051	0.0024 - 0.0063	0.0031 - 0.0071	
0.0039 - 0.0071	0.0039 - 0.0079	0.0039 - 0.0098	0.0039 - 0.0071	0.0039 - 0.0079	0.0039 - 0.0079	
0.0039 - 0.0071	0.0039 - 0.0079	0.0039 - 0.0098	0.0039 - 0.0071	0.0039 - 0.0079	0.0039 - 0.0079	
0.0016 - 0.0031	0.0016 - 0.0031	0.0016 - 0.0039	0.0016 - 0.0039	0.0016 - 0.0039	0.0016 - 0.0039	
0.0016 - 0.0031	0.0016 - 0.0031	0.0016 - 0.0039	0.0016 - 0.0039	0.0016 - 0.0039	0.0016 - 0.0039	
0.0024 - 0.0039	0.0024 - 0.0047	0.0024 - 0.0055	0.0024 - 0.0055	0.0024 - 0.0055	0.0024 - 0.0055	
0.0024 - 0.0039	0.0024 - 0.0047	0.0024 - 0.0055	0.0024 - 0.0055	0.0024 - 0.0055	0.0024 - 0.0055	
0.0016 - 0.0031	0.0016 - 0.0031	0.0016 - 0.0039	0.0016 - 0.0031	0.0016 - 0.0031	0.0016 - 0.0031	
0.0016 - 0.0031	0.0016 - 0.0031	0.0016 - 0.0039	0.0016 - 0.0031	0.0016 - 0.0031	0.0016 - 0.0031	

Grade
Insert
Toolholder
Ext. Toolholder
Int. Toolholder
Threading
Grooving
Grooving
Miniature Tool
Milling Cutter
Endmill
Drilling Tool
Tooling System
User's Guide
Index





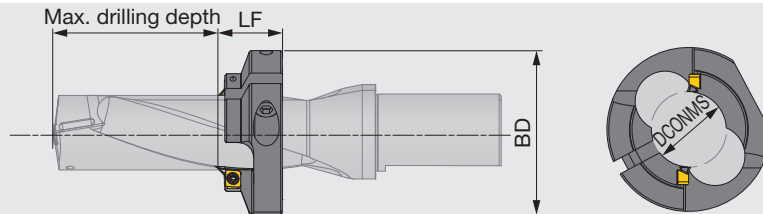

TDXCF chamfering tool

Chamfering tool for TungDrillTwisted and TungSix-Drill



Inch	DCONMS	BD	LF	Application drill	Max. drilling depth		
					L/D = 2	L/D = 3	L/D = 4
TDXCF210L25	0.791	1.929	0.984	TDSU0812...	0.700	1.512	-
TDXCF230L25	0.870	1.929	0.984	TDSU0875...	0.825	1.700	-
TDXCF240L25	0.909	1.929	0.984	TDSU0937...	0.950	1.887	-
TDXCF260L30	0.982	2.520	1.181	TDSU1000...	0.878	1.878	-
TDXCF270L30	1.020	2.520	1.181	TDSU1062...	1.003	2.065	-
TDXCF290L30	1.098	2.520	1.181	TDSU1125...	-	-	3.486
TDXCF300L30	1.138	2.520	1.181	TDSU1187...	-	-	3.726
TDXCF320L30	1.217	2.520	1.181	TDSU1250...	-	-	3.976
TDXCF340L30	1.291	2.520	1.181	TDSU1312...	-	-	4.226
TDXCF350L30	1.331	2.520	1.181	TDSU1375...	-	-	4.476
TDXCF370L30	1.409	3.346	1.181	TDSU1437...	-	-	4.726
TDXCF380L30	1.449	3.346	1.181	TDSU1500...	-	-	4.977
TDXCF400L30	1.528	3.346	1.181	TDSU1562...	-	-	5.245
TDXCF410L30	1.567	3.346	1.181	TDSU1625...	-	-	5.496
TDXCF430L30	1.638	3.346	1.181	TDSU1687...	-	-	5.746
TDXCF450L30	1.717	3.346	1.181	TDSU1750...	-	-	5.998
TDXCF460L30	1.756	3.346	1.181	TDSU1812...	-	-	6.248
TDXCF480L30	1.835	3.346	1.181	TDSU1875...	-	-	6.496
TDXCF500L30	1.913	3.346	1.181	TDSU1937...	-	-	6.746
TDXCF510L30	1.953	3.346	1.181	TDSU2000...	-	-	6.996

SPARE PARTS

Designation	 Screw for insert	 Screw for ring	 Wrench for insert	 Wrench for ring
TDXCF210 - 250	CSPB-4S	CM6X16	IP-15D	P-5
TDXCF260 - 540	CSPB-4S	CM8X1.25X20-A	IP-15D	P-6

Recommended clamping torque: CSPB-4S = 2.58 lb-ft

INSERT

XHGX-45A



P	Steel	★								
M	Stainless	★								
K	Cast iron	★								
N	Non-ferrous	☆								
S	Superalloys	★								
H	Hard materials	★								

Designation	PNA	C (in)	Coated										
			GHT 30										
XHGX090700R-45A	45°	0.100	●										

★ : First choice
☆ : Second choice

● : Line up

Caution in mounting the chamfering tool on the drill body

- ① Place the ring on the drill body and match the positions of flutes on drill and ring. Temporarily clamp the ring with the ring screw tightened lightly.
- ② Place the inserts, and tighten the insert screw lightly.
- ③ Adjust the ring position with a presetter, height gauge, or Vernier caliper, and securely tighten the ring screw, then the insert screw.

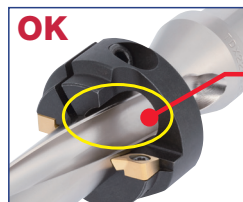

Match the positions of flutes on drill and ring.

(Inserts will be automatically set to the right positions.)

The cutting edge of the insert is in the ring flute.

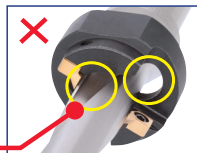

The flutes on drill and ring do not match.

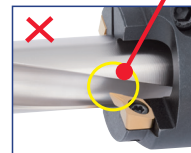

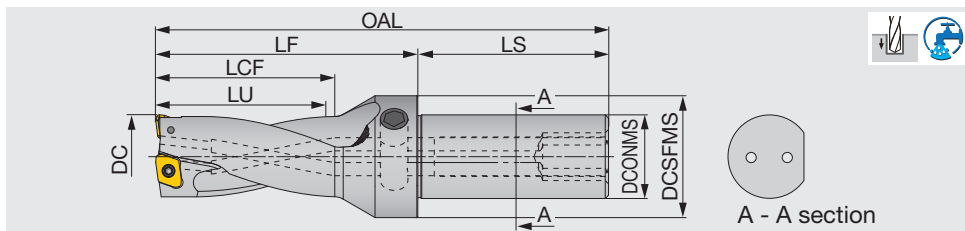

Inch	DC	DCONMS	DCSFMS	LU	LS	LCF	LF	OAL	Max. offset** (radial)	WT(lb)	Insert
TDXU-0500FS-02	0.500	0.750	1.250	1.015	1.015	1.130	2.019	4.034	0.030	0.44	XPMT040104R-D*
TDXU-0531FS-02	0.531	0.750	1.250	1.077	1.077	1.200	2.089	4.104	0.024	0.45	XPMT040104R-D*
TDXU-0562FS-02	0.562	0.750	1.250	1.139	1.139	1.260	2.152	4.167	0.018	0.45	XPMT040104R-D*
TDXU-0625FS-02	0.625	0.750	1.250	1.271	1.271	1.390	2.283	4.304	0.026	0.46	XPMT050204R-D*
TDXU-0687FS-02	0.687	1.000	1.457	1.393	1.393	1.510	2.471	4.770	0.048	0.79	XPMT06X308R-D*
TDXU-0750FS-02	0.75	1.000	1.457	1.519	1.519	1.640	2.591	4.890	0.027	0.82	XPMT06X308R-D*
TDXU-0812FS-02	0.812	1.000	1.457	1.643	1.643	1.760	2.729	5.028	0.015	0.85	XPMT06X308R-D*
TDXU-0875FS-02	0.875	1.000	1.457	1.773	1.773	1.890	2.849	5.152	0.045	0.88	XPMT07H308R-D*
TDXU-0937FS-02	0.937	1.000	1.457	1.897	1.897	2.020	2.991	5.294	0.029	0.93	XPMT07H308R-D*
TDXU-1000FS-02	1.000	1.000	1.457	2.023	2.023	2.140	3.111	5.414	0.013	0.96	XPMT07H308R-D*
TDXU-1062FS-02	1.062	1.250	1.575	2.153	2.153	2.270	3.401	5.710	0.059	1.3	XPMT08T308R-D*
TDXU-1125FS-02	1.125	1.250	1.575	2.279	2.279	2.400	3.541	5.850	0.043	1.38	XPMT08T308R-D*
TDXU-1187FS-02	1.187	1.250	1.575	2.403	2.403	2.520	3.658	5.967	0.026	1.45	XPMT08T308R-D*
TDXU-1250FS-02	1.250	1.250	1.575	2.529	2.529	2.650	3.783	6.092	0.010	1.52	XPMT08T308R-D*
TDXU-1312FS-02	1.312	1.500	1.969	2.667	2.667	2.790	4.013	6.744	0.088	2.25	XPMT110412R-D*
TDXU-1375FS-02	1.375	1.500	1.969	2.793	2.793	2.910	4.155	6.886	0.072	2.32	XPMT110412R-D*
TDXU-1437FS-02	1.437	1.500	1.969	2.917	2.917	3.040	4.272	7.003	0.055	2.34	XPMT110412R-D*
TDXU-1500FS-02	1.500	1.500	1.969	3.043	3.043	3.160	4.413	7.144	0.038	2.53	XPMT110412R-D*
TDXU-1562FS-02	1.562	1.500	1.969	3.167	3.167	3.290	4.553	7.284	0.022	2.54	XPMT110412R-D*
TDXU-1625FS-02	1.625	1.500	2.165	3.311	3.311	3.430	4.728	7.477	0.128	2.85	XPMT150512R-D*
TDXU-1687FS-02	1.687	1.500	2.165	3.435	3.435	3.550	4.868	7.617	0.115	3.02	XPMT150512R-D*
TDXU-1750FS-02	1.750	1.500	2.165	3.561	3.561	3.680	4.986	7.735	0.097	3.14	XPMT150512R-D*
TDXU-1812FS-02	1.812	1.500	2.165	3.685	3.685	3.810	5.128	7.877	0.082	3.3	XPMT150512R-D*
TDXU-1875FS-02	1.875	1.500	2.165	3.811	3.811	3.930	5.251	8.000	0.063	3.49	XPMT150512R-D*
TDXU-1937FS-02	1.937	1.500	2.165	3.935	3.935	4.050	5.385	8.134	0.049	3.61	XPMT150512R-D*
TDXU-2000FS-02	2.000	1.500	2.165	4.061	4.061	4.180	5.510	8.259	0.030	3.82	XPMT150512R-D*
TDXU-2125FS-02	2.125	1.500	2.165	4.311	4.311	4.430	5.790	8.548	-	4.24	XPMT150512R-D*

** For offsetting on lathe

Tool diameter	Tool diameter tolerance	Hole diameter tolerance
$\varnothing 0.500 - \varnothing 0.625$	+ 0.004 / 0	+ 0.010 / 0
$\varnothing 0.687 - \varnothing 2.125$	+ 0.008 / 0	+ 0.012 / 0

SPARE PARTS



Designation	Clamping screw	Torx driver	Plug *	
			Side port	Rear port (Optional parts)
TDXU500 - TDXU0562	CSPB-2H	IP-6DB	NPTF1/8	(NPTF1/4)
TDXU-0625FS-02	CSPB-2L043	IP-6DB	NPTF1/8	(NPTF1/4)
TDXU0687 - TDXU0812	CSPB-2.2	IP-7D	NPTF1/8	(SL25IN)
TDXU0875 - TDXU1000	CSPB-2.5	IP-8D	NPTF1/8	(SL25IN)
TDXU1062 - TDXU1250	CSTB-3	T-9D	NPTF1/4	(SL32IN)
TDXU1312 - TDXU1562	CSTB-4	T-15D	NPTF1/4	(SL38IN)
TDXU1625 - TDXU2125	CSTB-5	T-20D	NPTF1/4	(SL38IN)

Recommended clamping torque: CSPB-2H/CSPB-2L043= 0.52 lb-ft, CSPB-2.2= 0.74 lb-ft, CSPB-2.5= 0.96 lb-ft, CSTB-3= 1.70 lb-ft, CSTB-4= 2.58 lb-ft, CSTB-5= 3.69 lb-ft

* Please see the dimensions on page **J078**.

Reference pages: Inserts → **J079 - J080**, Standard cutting conditions → **J081**

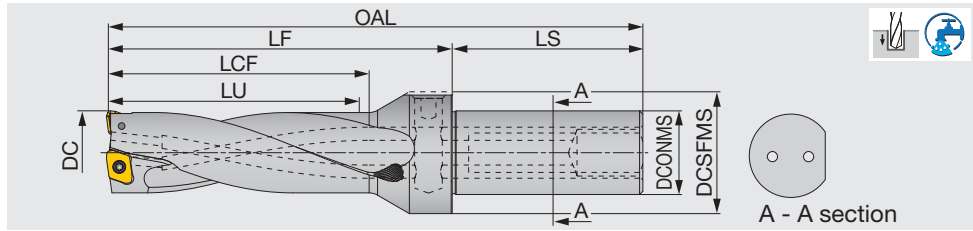

Inch	DC	DCONMS	DCSFMS	LU	LS	LCF	LF	OAL	Max. offset** (radial)	WT(lb)	Insert
TDXU-0500FS-03	0.500	0.750	1.250	1.515	2.000	1.630	2.519	4.534	0.030	0.45	XPMT040104R-D*
TDXU-0531FS-03	0.531	0.750	1.250	1.608	2.000	1.730	2.620	4.635	0.024	0.46	XPMT040104R-D*
TDXU-0562FS-03	0.562	0.750	1.250	1.701	2.000	1.820	2.715	4.730	0.018	0.47	XPMT040104R-D*
TDXU-0625FS-03	0.625	0.750	1.250	1.896	2.000	2.020	2.909	4.930	0.026	0.49	XPMT050204R-D*
TDXU-0687FS-03	0.687	1.000	1.457	2.080	2.280	2.200	3.159	5.458	0.048	0.83	XPMT06X308R-D*
TDXU-0750FS-03	0.750	1.000	1.457	2.269	2.280	2.390	3.341	5.640	0.027	0.87	XPMT06X308R-D*
TDXU-0812FS-03	0.812	1.000	1.457	2.455	2.280	2.580	3.542	5.841	0.015	0.91	XPMT06X308R-D*
TDXU-0875FS-03	0.875	1.000	1.457	2.648	2.280	2.770	3.724	6.027	0.045	0.95	XPMT07H308R-D*
TDXU-0937FS-03	0.937	1.000	1.457	2.834	2.280	2.960	3.929	6.232	0.029	1.03	XPMT07H308R-D*
TDXU-1000FS-03	1.000	1.000	1.457	3.023	2.280	3.210	4.111	6.314	0.013	1.05	XPMT07H308R-D*
TDXU-1062FS-03	1.062	1.250	1.575	3.215	2.280	3.340	4.464	6.773	0.059	1.43	XPMT08T308R-D*
TDXU-1125FS-03	1.125	1.250	1.575	3.404	2.280	3.520	4.666	6.975	0.043	1.52	XPMT08T308R-D*
TDXU-1187FS-03	1.187	1.250	1.575	3.590	2.280	3.710	4.845	7.154	0.026	1.62	XPMT08T308R-D*
TDXU-1250FS-03	1.250	1.250	1.575	3.779	2.280	3.900	5.033	7.342	0.010	1.74	XPMT08T308R-D*
TDXU-1312FS-03	1.312	1.500	1.969	3.979	2.688	4.100	5.325	8.056	0.088	2.51	XPMT110412R-D*
TDXU-1375FS-03	1.375	1.500	1.969	4.168	2.688	4.290	5.530	8.261	0.072	2.61	XPMT110412R-D*
TDXU-1437FS-03	1.437	1.500	1.969	4.354	2.688	4.470	5.709	8.440	0.055	2.63	XPMT110412R-D*
TDXU-1500FS-03	1.500	1.500	1.969	4.543	2.688	4.660	5.913	8.644	0.038	2.86	XPMT110412R-D*
TDXU-1562FS-03	1.562	1.500	1.969	4.729	2.688	4.850	6.115	8.846	0.022	2.92	XPMT110412R-D*
TDXU-1625FS-03	1.625	1.500	2.165	4.936	2.688	5.050	6.353	9.102	0.128	3.33	XPMT150512R-D*
TDXU-1687FS-03	1.687	1.500	2.165	5.122	2.688	5.240	6.555	9.304	0.115	3.57	XPMT150512R-D*
TDXU-1750FS-03	1.750	1.500	2.165	5.311	2.688	5.430	6.736	9.485	0.097	3.74	XPMT150512R-D*
TDXU-1812FS-03	1.812	1.500	2.165	5.497	2.688	5.620	6.941	9.690	0.082	3.95	XPMT150512R-D*
TDXU-1875FS-03	1.875	1.500	2.165	5.686	2.688	5.800	7.126	9.875	0.063	4.22	XPMT150512R-D*
TDXU-1937FS-03	1.937	1.500	2.165	5.872	2.688	5.990	7.322	10.071	0.049	4.41	XPMT150512R-D*
TDXU-2000FS-03	2.000	1.500	2.165	6.061	2.688	6.180	7.510	10.259	0.030	4.6	XPMT150512R-D*
TDXU-2125FS-03	2.125	1.500	2.165	6.436	2.688	6.550	7.915	10.664	-	5.31	XPMT150512R-D*

** For offsetting on lathe

Tool diameter	Tool diameter tolerance	Hole diameter tolerance
$\varnothing 0.500 - \varnothing 0.625$	+ 0.004 / 0	+ 0.010 / 0
$\varnothing 0.687 - \varnothing 2.125$	+ 0.008 / 0	+ 0.012 / 0

SPARE PARTS



Designation	Clamping screw	Torx driver	Plug *	
			Side port	Rear port (Optional parts)
TDXU500 - TDXU0562	CSPB-2H	IP-6DB	NPTF1/8	(NPTF1/4)
TDXU-0625FS-03	CSPB-2L043	IP-6DB	NPTF1/8	(NPTF1/4)
TDXU0687-TDXU0812	CSPB-2.2	IP-7D	NPTF1/8	(SL25IN)
TDXU0875 - TDXU1000	CSPB-2.5	IP-8D	NPTF1/8	(SL25IN)
TDXU1062 - TDXU1250	CSTB-3	T-9D	NPTF1/4	(SL32IN)
TDXU1312 - TDXU1562	CSTB-4	T-15D	NPTF1/4	(SL38IN)
TDXU1625 - TDXU2125	CSTB-5	T-20D	NPTF1/4	(SL38IN)

Recommended clamping torque: CSPB-2H/CSPB-2L043= 0.52 lb-ft, CSPB-2.2= 0.74 lb-ft, CSPB-2.5= 0.96 lb-ft, CSTB-3= 1.70 lb-ft, CSTB-4= 2.58 lb-ft, CSTB-5= 3.69 lb-ft

* Please see the dimensions on page **J078**.

Reference pages: Inserts → **J079 - J080**, Standard cutting conditions → **J081**



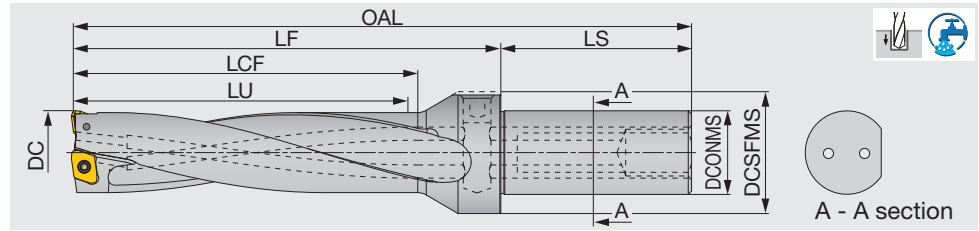

Inch	DC	DCONMS	DCSFMS	LU	LS	LCF	LF	OAL	Max. offset** (radial)	WT(lb)	Insert
TDXU-0500FS-04	0.500	0.750	1.250	2.015	2.000	2.130	3.019	5.034	0.030	0.460	XPMT040104R-D*
TDXU-0531FS-04	0.531	0.750	1.250	2.139	2.000	2.260	3.151	5.166	0.024	0.480	XPMT040104R-D*
TDXU-0562FS-04	0.562	0.750	1.250	2.263	2.000	2.390	3.278	5.293	0.018	0.490	XPMT040104R-D*
TDXU-0625FS-04	0.625	0.750	1.250	2.521	2.000	2.640	3.535	5.556	0.026	0.520	XPMT050204R-D*
TDXU-0687FS-04	0.687	1.000	1.457	2.767	2.280	2.890	3.847	6.146	0.048	0.860	XPMT06X308R-D*
TDXU-0750FS-04	0.750	1.000	1.457	3.019	2.280	3.140	4.091	6.390	0.027	0.920	XPMT06X308R-D*
TDXU-0812FS-04	0.812	1.000	1.457	3.267	2.280	3.390	4.355	6.654	0.015	0.960	XPMT06X308R-D*
TDXU-0875FS-04	0.875	1.000	1.457	3.523	2.280	3.640	4.599	6.902	0.045	1.030	XPMT07H308R-D*
TDXU-0937FS-04	0.937	1.000	1.457	3.771	2.280	3.890	4.867	7.170	0.029	1.130	XPMT07H308R-D*
TDXU-1000FS-04	1.000	1.000	1.457	4.023	2.280	4.140	5.111	7.414	0.013	1.140	XPMT07H308R-D*
TDXU-1062FS-04	1.062	1.250	1.575	4.277	2.280	4.400	5.527	7.836	0.059	1.560	XPMT08T308R-D*
TDXU-1125FS-04	1.125	1.250	1.575	4.529	2.280	4.650	5.791	8.100	0.043	1.660	XPMT08T308R-D*
TDXU-1187FS-04	1.187	1.250	1.575	4.777	2.280	4.900	6.032	8.341	0.026	1.800	XPMT08T308R-D*
TDXU-1250FS-04	1.250	1.250	1.575	5.029	2.280	5.150	6.283	8.592	0.010	1.950	XPMT08T308R-D*
TDXU-1312FS-04	1.312	1.500	1.969	5.291	2.688	5.410	6.637	9.368	0.088	2.770	XPMT110412R-D*
TDXU-1375FS-04	1.375	1.500	1.969	5.543	2.688	5.660	6.905	9.636	0.072	2.900	XPMT110412R-D*
TDXU-1437FS-04	1.437	1.500	1.969	5.791	2.688	5.910	7.146	9.877	0.055	2.930	XPMT110412R-D*
TDXU-1500FS-04	1.500	1.500	1.969	6.043	2.688	6.160	7.413	10.144	0.038	3.180	XPMT110412R-D*
TDXU-1562FS-04	1.562	1.500	1.969	6.291	2.688	6.410	7.677	10.408	0.022	3.310	XPMT110412R-D*
TDXU-1625FS-04	1.625	1.500	2.165	6.561	2.688	6.680	7.978	10.727	0.128	3.820	XPMT150512R-D*
TDXU-1687FS-04	1.687	1.500	2.165	6.809	2.688	6.930	8.242	10.991	0.115	4.120	XPMT150512R-D*
TDXU-1750FS-04	1.750	1.500	2.165	7.061	2.688	7.180	8.486	11.235	0.097	4.340	XPMT150512R-D*
TDXU-1812FS-04	1.812	1.500	2.165	7.309	2.688	7.430	8.754	11.503	0.082	4.600	XPMT150512R-D*
TDXU-1875FS-04	1.875	1.500	2.165	7.561	2.688	7.680	9.001	11.750	0.063	4.950	XPMT150512R-D*
TDXU-1937FS-04	1.937	1.500	2.165	7.809	2.688	7.930	9.259	12.008	0.049	5.210	XPMT150512R-D*
TDXU-2000FS-04	2.000	1.500	2.165	8.061	2.688	8.180	9.510	12.259	0.030	5.370	XPMT150512R-D*
TDXU-2125FS-04	2.125	1.500	2.165	8.561	2.688	8.680	10.040	12.789	-	6.390	XPMT150512R-D*

** For offsetting on lathe

Tool diameter	Tool diameter tolerance	Hole diameter tolerance
$\varnothing 0.500 - \varnothing 0.625$	+ 0.004 / 0	+ 0.016 / 0
$\varnothing 0.687 - \varnothing 2.125$	+ 0.008 / 0	+ 0.018 / 0

SPARE PARTS



Designation	Clamping screw	Torx driver	Plug *	
			Side port	Rear port (Optional parts)
TDXU500 - TDXU0562	CSPB-2H	IP-6DB	NPTF1/8	(NPTF1/4)
TDXU-0625FS-04	CSPB-2L043	IP-6DB	NPTF1/8	(NPTF1/4)
TDXU0687 - TDXU0812	CSPB-2.2	IP-7D	NPTF1/8	(SL25IN)
TDXU0875 - TDXU1000	CSPB-2.5	IP-8D	NPTF1/8	(SL25IN)
TDXU1062 - TDXU1250	CSTB-3	T-9D	NPTF1/4	(SL32IN)
TDXU1312 - TDXU1562	CSTB-4	T-15D	NPTF1/4	(SL38IN)
TDXU1625 - TDXU2000	CSTB-5	T-20D	NPTF1/4	(SL38IN)

Recommended clamping torque: CSPB-2H/CSPB-2L043= 0.52 lb-ft, CSPB-2.2= 0.74 lb-ft, CSPB-2.5= 0.96 lb-ft, CSTB-3= 1.70 lb-ft, CSTB-4= 2.58 lb-ft, CSTB-5= 3.69 lb-ft

* Please see the dimensions on page **J078**.

Reference pages: Inserts → **J079 - J080**, Standard cutting conditions → **J081**

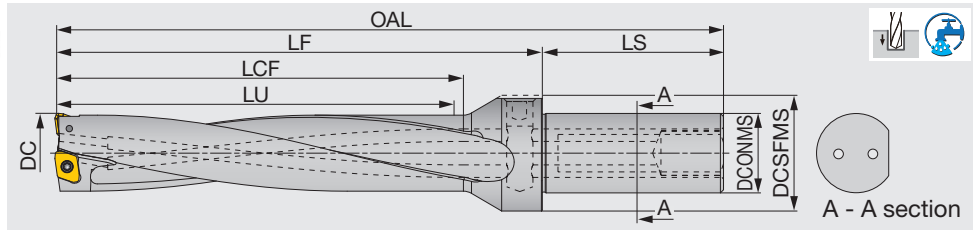

Inch	DC	DCONMS	DCSFMS	LU	LS	LCF	LF	OAL	Max. offset** (radial)	WT(lb)	Insert
TDXU-0500FS-05	0.500	0.750	1.250	2.515	2.000	2.630	3.519	5.534	0.030	0.47	XPMT040104R-D*
TDXU-0531FS-05	0.531	0.750	1.250	2.670	2.000	2.790	3.682	5.697	0.024	0.5	XPMT040104R-D*
TDXU-0562FS-05	0.562	0.750	1.250	2.825	2.000	2.950	3.841	5.856	0.018	0.51	XPMT040104R-D*
TDXU-0625FS-05	0.625	0.750	1.250	3.146	2.000	3.270	4.161	6.182	0.026	0.55	XPMT050204R-D*
TDXU-0687FS-05	0.687	1.000	1.457	3.454	2.280	3.580	4.535	6.834	0.048	0.9	XPMT06X308R-D*
TDXU-0750FS-05	0.750	1.000	1.457	3.769	2.280	3.890	4.841	7.140	0.027	0.96	XPMT06X308R-D*
TDXU-0812FS-05	0.812	1.000	1.457	4.079	2.280	4.200	5.168	7.467	0.015	1.02	XPMT06X308R-D*
TDXU-0875FS-05	0.875	1.000	1.457	4.398	2.280	4.520	5.474	7.777	0.045	1.1	XPMT07H308R-D*
TDXU-0937FS-05	0.937	1.000	1.457	4.708	2.280	4.830	5.805	8.108	0.029	1.22	XPMT07H308R-D*
TDXU-1000FS-05	1.000	1.000	1.457	5.023	2.280	5.140	6.111	8.414	0.013	1.23	XPMT07H308R-D*
TDXU-1062FS-05	1.062	1.250	1.575	5.339	2.280	5.460	6.590	8.899	0.059	1.69	XPMT08T308R-D*
TDXU-1125FS-05	1.125	1.250	1.575	5.654	2.280	5.770	6.916	9.225	0.043	1.81	XPMT08T308R-D*
TDXU-1187FS-05	1.187	1.250	1.575	5.964	2.280	6.080	7.219	9.528	0.026	1.97	XPMT08T308R-D*
TDXU-1250FS-05	1.250	1.250	1.575	6.279	2.280	6.400	7.533	9.842	0.010	2.16	XPMT08T308R-D*
TDXU-1312FS-05	1.312	1.500	1.969	6.603	2.688	6.720	7.949	10.680	0.088	3.03	XPMT110412R-D*
TDXU-1375FS-05	1.375	1.500	1.969	6.918	2.688	7.040	8.280	11.011	0.072	3.19	XPMT110412R-D*
TDXU-1437FS-05	1.437	1.500	1.969	7.228	2.688	7.350	8.583	11.314	0.055	3.22	XPMT110412R-D*
TDXU-1500FS-05	1.500	1.500	1.969	7.543	2.688	7.660	8.913	11.644	0.038	3.51	XPMT110412R-D*
TDXU-1562FS-05	1.562	1.500	1.969	7.853	2.688	7.970	9.239	11.970	0.022	3.7	XPMT110412R-D*
TDXU-1625FS-05	1.625	1.500	2.165	8.186	2.688	8.300	9.603	12.352	0.128	4.3	XPMT150512R-D*
TDXU-1687FS-05	1.687	1.500	2.165	8.496	2.688	8.610	9.929	12.678	0.115	4.67	XPMT150512R-D*
TDXU-1750FS-05	1.750	1.500	2.165	8.811	2.688	8.930	10.236	12.985	0.097	4.94	XPMT150512R-D*
TDXU-1812FS-05	1.812	1.500	2.165	9.121	2.688	9.240	10.567	13.316	0.082	5.25	XPMT150512R-D*
TDXU-1875FS-05	1.875	1.500	2.165	9.436	2.688	9.550	10.876	13.625	0.063	5.68	XPMT150512R-D*
TDXU-1937FS-05	1.937	1.500	2.165	9.746	2.688	9.860	11.196	13.945	0.049	6.01	XPMT150512R-D*
TDXU-2000FS-05	2.000	1.500	2.165	10.061	2.688	10.180	11.510	14.259	0.030	6.14	XPMT150512R-D*
TDXU-2125FS-05	2.125	1.500	2.165	10.686	2.688	10.800	12.165	14.914	-	7.46	XPMT150512R-D*

** For offsetting on lathe

Tool diameter	Tool diameter tolerance	Hole diameter tolerance
$\varnothing 0.500$ - $\varnothing 0.625$	+ 0.004 / 0	+ 0.016 / 0
$\varnothing 0.687$ - $\varnothing 2.125$	+ 0.008 / 0	+ 0.018 / 0

SPARE PARTS



Designation	Clamping screw	Torx driver	Plug *	
			Side port	Rear port (Optional parts)
TDXU500 - TDXU0562	CSPB-2H	IP-6DB	NPTF1/8	(NPTF1/4)
TDXU-0625FS-05	CSPB-2L043	IP-6DB	NPTF1/8	(NPTF1/4)
TDXU0687 - TDXU0812	CSPB-2.2	IP-7D	NPTF1/8	(SL25IN)
TDXU0875 - TDXU1000	CSPB-2.5	IP-8D	NPTF1/8	(SL25IN)
TDXU1062 - TDXU1250	CSTB-3	T-9D	NPTF1/4	(SL32IN)
TDXU1312 - TDXU1562	CSTB-4	T-15D	NPTF1/4	(SL38IN)
TDXU1625 - TDXU2000	CSTB-5	T-20D	NPTF1/4	(SL38IN)

Recommended clamping torque: CSPB-2H/CSPB-2L043= 0.52 lb-ft, CSPB-2.2= 0.74 lb-ft, CSPB-2.5= 0.96 lb-ft, CSTB-3= 1.70 lb-ft, CSTB-4= 2.58 lb-ft, CSTB-5=3.69 lb-ft

* Please see the dimensions on page **J078**.

Reference pages: Inserts → **J079 - J080**, Standard cutting conditions → **J081**



TungCap C-TDX

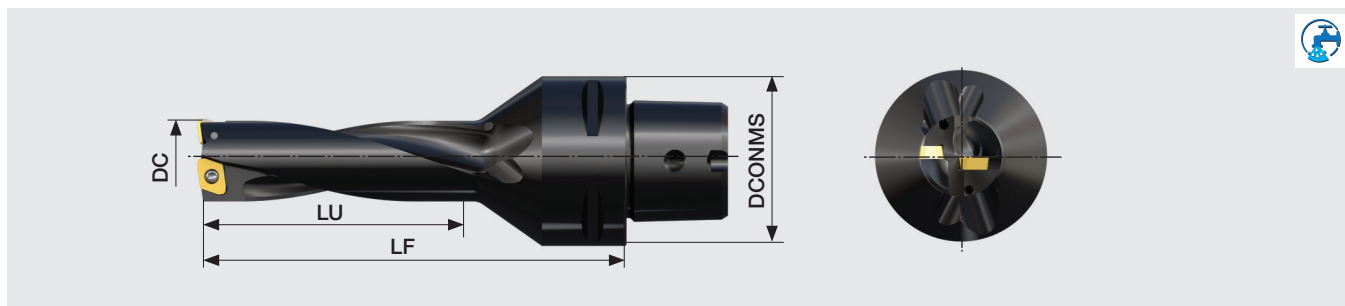

Metric	DCONMS	DC	LF	L	Max. offset** (radial)	Insert
C4TDX150L082-3	40	15	82	45	0.9	XPMT050204R-D*
C4TDX200L101-3	40	20	101	60	0.5	XPMT06X308R-D*
C4TDX250L125-3	40	25	125	75	0.4	XPMT07H308R-D*
C4TDX300L139-3	40	30	139	90	0.7	XPMT08T308R-D*
C6TDX200L101-3	63	20	101	60	0.5	XPMT06X308R-D*
C6TDX250L121-3	63	25	121	75	0.4	XPMT07H308R-D*
C6TDX300L139-3	63	30	139	90	0.7	XPMT08T308R-D*
C6TDX350L159-3	63	35	159	105	1.8	XPMT110412R-D*
C6TDX400L177-3	63	40	177	120	0.5	XPMT110412R-D*

Applicable for 14 MPa pressure coolant
 ** For offsetting on lathe

SPARE PARTS



Designation	Clamping screw	Screw
C4TDX150L082-3	CSTB-2L040	T-6D
C4TDX200L101-3	CSTB-2.2R	T-7D
C4TDX250L125-3	CSTB-2.5	T-8D
C4TDX300L139-3	CSTB-3	T-9D
C6TDX200L101-3	CSTB-2.2R	T-7D
C6TDX250L121-3	CSTB-2.5	T-8D
C6TDX300L139-3	CSTB-3	T-9D
C6TDX350L159-3	CSTB-4	T-15D
C6TDX400L177-3	CSTB-4	T-15D

Side port

Inch	D	H	L	W	G	L1	C
NPTF1/8	0.374	0.161	0.312	0.187	NPTF1/8	0.156	0.028
NPTF1/4	0.492	0.228	0.437	0.250	NPTF1/4	0.239	0.039

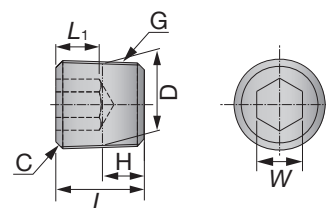

Rear port

Inch	D	H	L	W	G1	G2
SL25IN	0.866	0.472	0.669	0.669	M16X1.5	NPTF1/8
SL32IN	1.142	0.591	0.827	0.866	M22X2.0	NPTF1/4
SL38IN	1.496	0.591	0.827	0.866	M30X2.0	NPTF1/4

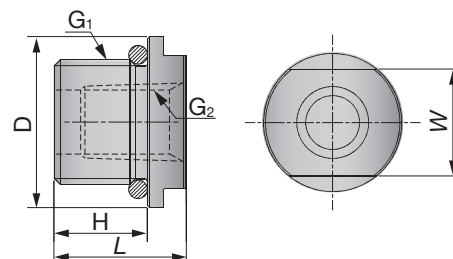

Reference pages: Inserts → **J079 - J080**, Standard cutting conditions → **J081**

INSERT

DJ

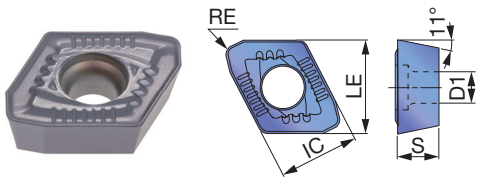

P	Steel			★	☆								
M	Stainless	☆		★									
K	Cast iron		☆	☆	★								
N	Non-ferrous	★		☆									
S	Superalloys	☆		★	☆								
H	Hard materials	☆		★	☆								

★ : First choice
☆ : Second choice

Designation	IC (in)	LE (in)	Coated				S (in)	D1 (in)	RE (in)	DCN (in)	DCX (in)
			AH725	T1115	AH6030	AH9030					
XPMT040104R-DJ	0.169	0.177	●	●	●	●	0.063	0.090	0.016	0.492	0.571
XPMT050204R-DJ	0.205	0.213	●	●	●	●	0.094	0.090	0.016	0.591	0.669
XPMT06X308R-DJ	0.236	0.276	●	●	●	●	0.118	0.100	0.032	0.689	0.847
XPMT07H308R-DJ	0.276	0.323	●	●	●	●	0.142	0.110	0.032	0.866	1.024
XPMT08T308R-DJ	0.335	0.390	●	●	●	●	0.156	0.130	0.032	1.063	1.260
XPMT110412R-DJ	0.441	0.492	●	●	●	●	0.187	0.170	0.047	1.299	1.614
XPMT150512R-DJ	0.591	0.634	●	●	●	●	0.219	0.220	0.047	1.654	2.126

● : Line up

DS

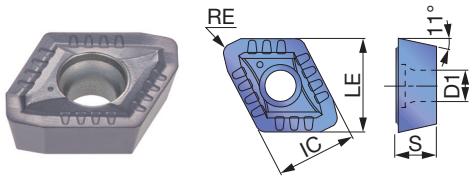

P	Steel	☆	★										
M	Stainless	☆	★										
K	Cast iron												
N	Non-ferrous	☆											
S	Superalloys	☆	★										
H	Hard materials												

★ : First choice
☆ : Second choice

Designation	IC (in)	LE (in)	Coated		S (in)	D1 (in)	RE (in)	DCN (in)	DCX (in)
			AH725	AH6030					
XPMT040104R-DS	0.169	0.177	●	●	0.063	0.090	0.016	0.492	0.571
XPMT050204R-DS	0.205	0.213	●	●	0.094	0.090	0.016	0.591	0.669
XPMT06X308R-DS	0.236	0.276	●	●	0.118	0.100	0.032	0.689	0.847
XPMT07H308R-DS	0.276	0.323	●	●	0.142	0.110	0.032	0.866	1.024
XPMT08T308R-DS	0.335	0.390	●	●	0.156	0.130	0.032	1.063	1.260
XPMT110412R-DS	0.441	0.492	●	●	0.187	0.170	0.047	1.299	1.614
XPMT150512R-DS	0.591	0.634	●	●	0.219	0.220	0.047	1.654	2.126

● : Line up

DW

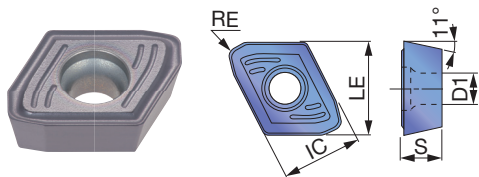

P	Steel	☆	★	☆											
M	Stainless	☆	★	☆											
K	Cast iron		☆	★											
N	Non-ferrous	☆	★												
S	Superalloys	☆	★	☆											
H	Hard materials	☆	★	☆											

★ : First choice
☆ : Second choice

Designation	IC (in)	LE (in)	Coated							S (in)	D1 (in)	RE (in)	DCN (in)	DCX (in)
			AH725	AH6030	AH9030									
XPMT040104R-DW	0.169	0.177	●	●	●					0.063	0.090	0.016	0.492	0.571
XPMT050204R-DW	0.205	0.213	●	●	●					0.094	0.090	0.016	0.591	0.669
XPMT06X308R-DW	0.236	0.276	●	●	●					0.118	0.100	0.032	0.689	0.847
XPMT07H308R-DW	0.276	0.323	●	●	●					0.142	0.110	0.032	0.866	1.024
XPMT08T308R-DW	0.335	0.390	●	●	●					0.156	0.130	0.032	1.063	1.260
XPMT110412R-DW	0.441	0.492	●	●	●					0.187	0.170	0.047	1.299	1.614
XPMT150512R-DW	0.591	0.634	●	●	●					0.219	0.220	0.047	1.654	2.126

● : Line up

DG

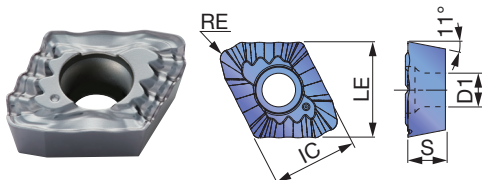

P	Steel	★													
M	Stainless	☆													
K	Cast iron														
N	Non-ferrous	★													
S	Superalloys	☆													
H	Hard materials														

★ : First choice
☆ : Second choice

Designation	IC (in)	LE (in)	Coated							S (in)	D1 (in)	RE (in)	DCN (in)	DCX (in)
			AH725											
XPMT08T308R-DG	0.335	0.390	●							0.156	0.130	0.032	1.063	1.260
XPMT110412R-DG	0.441	0.492	●							0.187	0.170	0.047	1.299	1.614
XPMT150512R-DG	0.591	0.634	●							0.219	0.220	0.047	1.654	2.126

● : Line up

RECOMMENDED INSERT

ISO	Workpiece material	First choice	High feed	High speed	Troubleshooting			
					Chipping resistance	Wear resistance	Surface finish	Chip control
P	Low carbon steels (C ≤ 0.3%)	DS, AH6030	-	-	DS, AH725	-	DW, AH6030	DG, AH725
	Carbon steels (C > 0.3%) Alloy steels	DJ, AH6030	DW, AH6030	DJ, AH9030	DW, AH725	DJ, AH9030	DW, AH6030	-
	Low alloy steels	DS, AH6030	-	-	DS, AH725	-	DW, AH6030	-
M	Stainless steel	DS, AH6030	-	-	DS, AH725	-	DW, AH6030	DG, AH725
K	Gray cast irons	DJ, AH9030	DW, AH9030	DJ, T1115	DW, AH725	-	DW, AH9030	-
	Ductile cast irons	DJ, AH9030	DW, AH9030	-	DW, AH725	-	DW, AH9030	-
N	Aluminum alloy	DJ, AH725	DW, AH725	DS, AH6030	-	-	DW, AH725	DG, AH725
S	Titanium alloys Heat-resistant alloys	DS, AH6030	-	-	DW, AH725	-	DW, AH725	DG, AH725
H	Hardened steel	DJ, AH9030	DW, AH9030	-	DW, AH725	-	DW, AH9030	-

STANDARD CUTTING CONDITIONS

ISO	Workpiece material	Cutting speed Vc (sfm)	Series L/D	Feed: f (ipr)				
				ø0.500" - ø0.562"	ø0.625"	ø0.687" - ø1.000"	ø1.062" - ø1.25"	ø1.312" - ø2.000"
P	Low carbon steels (C < 0.3) 1018, 1026, etc.	525 - 1050	2D, 3D	0.0008 - 0.0024	0.0008 - 0.0024	0.0016 - 0.0039	0.0016 - 0.0039	0.0016 - 0.0039
			4D, 5D	0.0008 - 0.0024	0.0008 - 0.0024	0.0016 - 0.0039	0.0016 - 0.0039	0.0016 - 0.0039
	Carbon steels (C > 0.3) 1045, 1055, etc.	262 - 820	2D, 3D	0.0016 - 0.0039	0.0016 - 0.0047	0.0024 - 0.0051	0.0024 - 0.0059	0.0031 - 0.0071
			4D, 5D	0.0016 - 0.0031	0.0016 - 0.0031	0.0024 - 0.0039	0.0024 - 0.0047	0.0031 - 0.0055
M	Low alloy steels 4130, etc.	525 - 820	2D, 3D	0.0016 - 0.0031	0.0016 - 0.0031	0.0024 - 0.0047	0.0024 - 0.0047	0.0024 - 0.0055
			4D, 5D	0.0016 - 0.0031	0.0016 - 0.0031	0.0024 - 0.0047	0.0024 - 0.0047	0.0024 - 0.0055
	Alloy steels 4140, 5120, etc.	262 - 656	2D, 3D	0.0016 - 0.0039	0.0016 - 0.0047	0.0024 - 0.0051	0.0024 - 0.0059	0.0031 - 0.0071
			4D, 5D	0.0016 - 0.0031	0.0016 - 0.0031	0.0024 - 0.0039	0.0024 - 0.0047	0.0031 - 0.0055
K	Stainless steels (Austenitic) 304, 316, etc.	328 - 656	2D, 3D	0.0008 - 0.0031	0.0008 - 0.0031	0.0016 - 0.0039	0.0016 - 0.0047	0.0016 - 0.0047
			4D, 5D	0.0008 - 0.0031	0.0008 - 0.0031	0.0016 - 0.0039	0.0016 - 0.0047	0.0016 - 0.0047
	Stainless steels (Martensitic and ferritic) 430, 416, etc.	328 - 722	2D, 3D	0.0008 - 0.0031	0.0008 - 0.0031	0.0016 - 0.0039	0.0016 - 0.0047	0.0016 - 0.0047
4D, 5D			0.0008 - 0.0031	0.0008 - 0.0031	0.0016 - 0.0039	0.0016 - 0.0047	0.0016 - 0.0047	
S	Stainless steels (Precipitation hardening) 630, etc.	262 - 394	2D, 3D	0.0016 - 0.0031	0.0016 - 0.0031	0.0016 - 0.0031	0.0016 - 0.0039	0.0024 - 0.0039
			4D, 5D	0.0016 - 0.0031	0.0016 - 0.0031	0.0016 - 0.0031	0.0016 - 0.0039	0.0024 - 0.0039
N	Gray cast irons Class 25, Class 30, etc.	262 - 820	2D, 3D	0.0024 - 0.0047	0.0024 - 0.0047	0.0024 - 0.0059	0.0024 - 0.0071	0.0031 - 0.0079
			4D, 5D	0.0024 - 0.0039	0.0024 - 0.0039	0.0024 - 0.0047	0.0024 - 0.0055	0.0031 - 0.0063
H	Ductile cast irons 60-40-18, etc.	262 - 656	2D, 3D	0.0016 - 0.0047	0.0016 - 0.0047	0.0024 - 0.0059	0.0024 - 0.0071	0.0031 - 0.0079
			4D, 5D	0.0016 - 0.0039	0.0016 - 0.0039	0.0024 - 0.0047	0.0024 - 0.0055	0.0031 - 0.0063
N	Aluminum alloy 333.0, 383.0, etc.	656 - 1312	2D, 3D	0.0039 - 0.0047	0.0039 - 0.0059	0.0059 - 0.0079	0.0059 - 0.0079	0.0059 - 0.0098
			4D, 5D	0.0031 - 0.0047	0.0031 - 0.0047	0.0047 - 0.0063	0.0047 - 0.0063	0.0047 - 0.0079
S	Heat-resistant alloys Inconel 718, etc.	66 - 197	2D, 3D	0.0016 - 0.0031	0.0016 - 0.0031	0.0016 - 0.0039	0.0016 - 0.0039	0.0016 - 0.0039
			4D, 5D	0.0016 - 0.0031	0.0016 - 0.0031	0.0016 - 0.0039	0.0016 - 0.0039	0.0016 - 0.0039
H	Titanium alloys Ti-6Al-4V, etc.	131 - 394	2D, 3D	0.0024 - 0.0039	0.0024 - 0.0039	0.0024 - 0.0047	0.0024 - 0.0047	0.0024 - 0.0047
			4D, 5D	0.0024 - 0.0031	0.0024 - 0.0031	0.0024 - 0.0039	0.0024 - 0.0039	0.0024 - 0.0039
H	Hardened steel ≥ 40HRC	131 - 328	2D, 3D	0.0016 - 0.0031	0.0016 - 0.0031	0.0016 - 0.0039	0.0016 - 0.0039	0.0016 - 0.0039
			4D, 5D	0.0016 - 0.0031	0.0016 - 0.0031	0.0016 - 0.0031	0.0016 - 0.0031	0.0016 - 0.0031

STANDARD CUTTING CONDITIONS FOR DG TYPE CHIPBREAKER

ISO	Workpiece material	Cutting speed Vc (sfm)	Series L/D	Feed: f (ipr)	
				ø1.062" - ø1.250"	ø1.312" - ø2.000"
P	Low carbon steels (C < 0.3) 1018, 1026, etc.	260 - 590	2D, 3D 4D, 5D	0.0016 - 0.0039	

When using the smaller side of the diameter range, the feed rate should be set lower.

When using DW insert for work materials of 40 HRC, the feed rate should be set below 50%.

For difficult-to-cut materials (heat-resistant alloys, etc.), the cutting speed should be set 25% below that of carbon steels.

High speed machining means cutting speeds over 150 m/min (429 sfm).

For high-feed machining, apply a feed rate that is approximately 1.5 times the standard feed conditions.

When using DW insert for troubleshooting, use it within the range of standard cutting conditions.

DG type chipbreaker is suitable for heavy machines that have low-rpm spindles. If chatter occurs, a lower feed rate is recommended.

Grade
Insert
Toolholder
Ext. Toolholder
Int. Toolholder
Threading
Grooving
Miniature Tool
Milling Cutter
Endmill
Drilling Tool
Tooling System
User's Guide
Index



TUNGDRILLTWISTED

TDXCF chamfering tool

Chamfering tool for TungDrillTwisted and TungSix-Drill

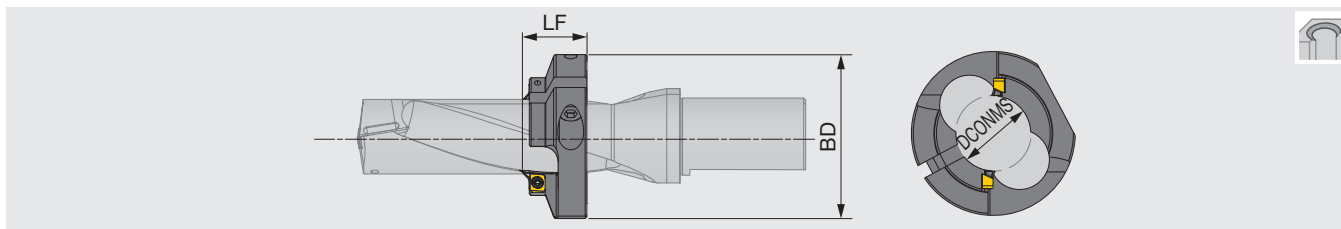

Inch	DCONMS	BD	LF	Application drill	L/D = 2		L/D = 3		L/D = 4		L/D = 5	
					TDX***F	TDX***W	TDX***F	TDX***W	TDX***F	TDX***W	TDX***F	TDX***W
TDXCF150L25	0.681	1.929	0.984	TDX175*25-*	0.512	0.740	1.201	1.429	1.890	2.118	2.579	2.807
TDXCF160L25	0.681	1.929	0.984	TDX180*25-*	0.551	0.783	1.260	1.492	1.969	2.201	2.677	2.909
TDXCF180L25	0.713	1.929	0.984	TDX185*25-*	0.591	0.831	1.319	1.559	2.047	2.287	2.776	3.016
TDXCF190L25	0.713	1.929	0.984	TDX190*25-*	0.630	0.874	1.378	1.622	2.126	2.370	2.874	3.118
TDXCF210L25	0.752	1.929	0.984	TDX195*25-*	0.669	0.921	1.437	1.689	2.205	2.457	2.972	3.224
TDXCF230L25	0.752	1.929	0.984	TDX200*25-*	0.787	0.965	1.575	1.752	2.323	2.539	3.110	3.327
TDXCF240L25	0.791	1.929	0.984	TDX205*25-*	0.827	1.012	1.634	1.819	2.402	2.626	3.209	3.433
TDXCF260L30	0.791	1.929	0.984	TDX210*25-*	0.866	1.055	1.693	1.882	2.480	2.709	3.307	3.535
TDXCF270L30	0.831	1.929	0.984	TDX215*25-*	0.906	1.102	1.752	1.949	2.559	2.795	3.406	3.642
TDXCF290L30	0.831	1.929	0.984	TDX220*25-*	0.945	1.146	1.811	2.012	2.638	2.878	3.504	3.744
TDXCF300L30	0.870	1.929	0.984	TDX225*25-*	0.984	1.193	1.870	2.079	2.717	2.965	3.602	3.850
TDXCF320L30	0.870	1.929	0.984	TDX230*25-*	1.024	1.236	1.929	2.142	2.795	3.047	3.701	3.953
TDXCF340L30	0.909	1.929	0.984	TDX235*25-*	1.063	1.283	1.988	2.209	2.874	3.134	3.799	4.059
TDXCF350L30	0.909	1.929	0.984	TDX240*25-*	1.102	1.327	2.047	2.272	2.953	3.217	3.898	4.161
TDXCF370L30	0.943	1.929	0.984	TDX245*25-*	1.142	1.374	2.106	2.339	3.031	3.303	3.996	4.268
TDXCF380L30	0.943	1.929	0.984	TDX250*25-*	1.181	1.417	2.165	2.402	3.110	3.386	4.094	4.370
TDXCF400L30	0.982	2.520	1.181	TDX255*25-*	1.024	1.268	2.028	2.272	2.992	3.276	3.996	4.280
TDXCF410L30	0.982	2.520	1.181	TDX260*25-*	1.063	1.311	2.087	2.335	3.071	3.358	4.094	4.382
TDXCF430L30	1.020	2.520	1.181	TDX270*32-*	1.142	1.402	2.205	2.465	3.228	3.528	4.291	4.591
TDXCF450L30	1.059	2.520	1.181	TDX280*32-*	1.193	1.492	2.295	2.594	3.386	3.697	4.488	4.799
TDXCF460L30	1.098	2.520	1.181	TDX290*32-*	1.272	1.583	2.413	2.724	3.543	3.866	4.685	5.008
TDXCF480L30	1.138	2.520	1.181	TDX300*32-*	1.350	1.673	2.531	2.854	3.701	4.035	4.882	5.217
TDXCF500L30	1.177	2.520	1.181	TDX310*32-*	1.429	1.764	2.650	2.984	3.858	4.205	5.079	5.425
TDXCF510L30	1.217	2.520	1.181	TDX320*32-*	1.508	1.854	2.768	3.114	4.016	4.374	5.276	5.634

SPARE PARTS



Designation	Screw for insert	Screw for ring	Wrench for insert	Wrench for ring
TDXCF130 - 250	CSPB-4S	CM6X16	IP-15D	P-5
TDXCF260 - 540	CSPB-4S	CM8X1.25X20-A	IP-15D	P-6

Recommended clamping torque: CSPB-4S = 2.58 lb-ft

INSERT

XHGX-45A



P	Steel	★							
M	Stainless	★							
K	Cast iron	★							
N	Non-ferrous	☆							
S	Superalloys	★							
H	Hard materials	★							

★ : First choice
☆ : Second choice

Designation	PNA	C (in)	Coated										
			GHT 30										
XHGX090700R-45A	45°	0.100	●										

● : Line up

Caution in mounting the chamfering tool on the drill body

- ① Place the ring on the drill body and match the positions of flutes on drill and ring. Temporarily clamp the ring with the ring screw tightened lightly.
- ② Place the inserts, and tighten the insert screw lightly.
- ③ Adjust the ring position with a presetter, height gauge, or Vernier caliper, and securely tighten the ring screw, then the insert screw.

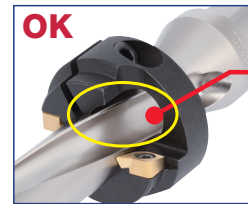

Match the positions of flutes on drill and ring.

(Inserts will be automatically set to the right positions.)

The cutting edge of the insert is in the ring flute.

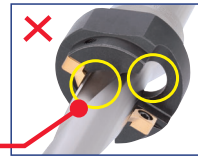

The flutes on drill and ring do not match.

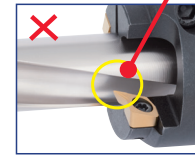

EZ sleeve

Eccentric sleeve for TungDrillTwisted and TungSix-Drill

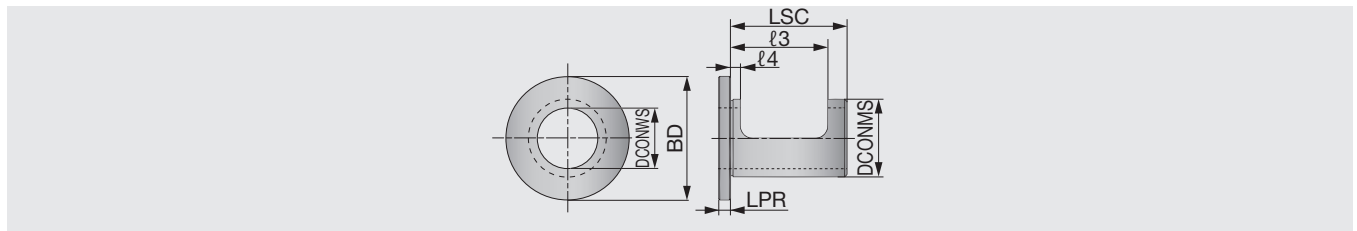

Inch	DCONWS	DCONMS	BD	LSC	LPR	l3	l4	Hole diameter adjustment	Cutting edge height adjustment
EZ0.75-1.25	0.750	1.250	1.750	2.000	0.200	1.575	0.375	+0.016 ~ - 0.008	+0.008 ~ - 0.006
EZ1.00-1.50	1.000	1.500	2.000	2.500	0.200	1.965	0.375	+0.016 ~ - 0.008	+0.008 ~ - 0.006
EZ1.25-2.00	1.250	2.000	2.500	2.700	0.200	1.965	0.375	+0.016 ~ - 0.008	+0.008 ~ - 0.006
EZ1.50-2.00	1.500	2.000	2.750	2.900	0.200	1.965	0.375	+0.024 ~ - 0.008	+0.012 ~ - 0.008

SPARE PARTS

Designation	Wrench
EZ...	P-2.5

Use EZ sleeves for the following purposes

Hole diameter adjustment on the milling machine

Adjusting the finishing diameter when milling

Adjusting the finishing diameter in tool-rotating applications such as on machining centers and milling machines:



By using **EZ sleeve**, the finishing diameter can be adjusted in the range from **+0.024"** to **-0.008"**.

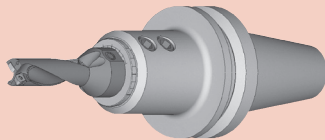

Scale for adjusting finishing diameter in milling (Periphery of sleeve)

Adjusting cutting edge height on lathe

Lathe

Adjusting of the cutting edge height in work rotating applications such as on lathes:



By using **EZ sleeve**, the cutting edge height can be adjusted in the range from **+0.012"** to **-0.008"**. It results in eliminating troubles caused by improper cutting-edge height.

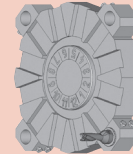

Scale for adjusting cutting edge height in turning (Front face of sleeve)

Setting of EZ sleeve

Hole diameter adjustment on the milling machine

As shown in the Figure on the right, set the EZ sleeve between the drill shank and the toolholder.

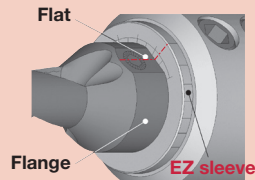

Align the graduated scale on the periphery of the EZ sleeve with the center of the flat of the drill flange.

In the Figure shown on the right, the sleeve is set so that the finishing diameter will be increased by 0.4 mm.

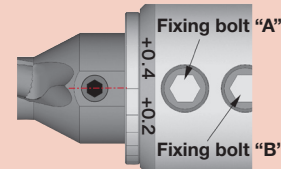

When rotating the EZ sleeve, insert the wrench into the hole at the flange periphery and rotate the EZ sleeve.
Screws A + B have to be loosened.
Secure the drill by screw A.
Secure the EZ sleeve by lightly tightening screw B.
Tighten screw B only lightly otherwise EZ sleeve can be damaged!

Adjusting cutting edge height on lathe

As shown in the Figure on the right, set the EZ sleeve between the drill shank and the toolblock.

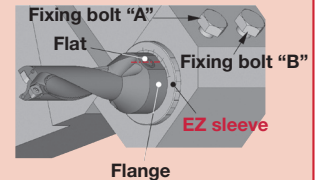

Align the graduated scale on the front face of the EZ sleeve with the center of the flat of the drill flange.

In the Figure shown on the right, the sleeve is set so that the center of the drill will shift by 0.1 mm to the plus (+) direction.

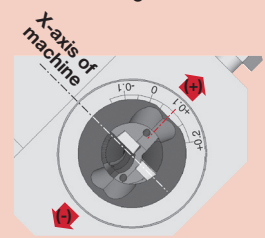

Cautious points

- The scale is only a rough guide, so be sure to measure the actual drilling diameter to confirm the result. Especially in turning, test machining is recommended as the drilling diameter will vary according to the adjustment.
- Can not be used for collet chuck holders.
- Over L/D 4 or bigger adjustment, please reduce feed.
- For smaller adjustment, the drill itself will interfere with the hole diameter. It is recommended that hole diameter should be adjusted to a larger diameter than the drill diameter.

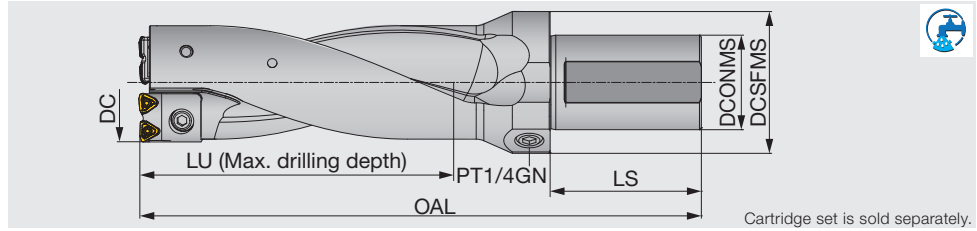

Body Inch	Cartridge set Inch	DC	DCONMS	DCSFMS	LU	LS	OAL	WT(lb)	Setting plate		Insert
									Designation	Thickness	
TDBU2250-2447-2.5	TDSCA57-62	2.250	2.000	2.953	6.117	4.000	11.957	8.8	-	-	WWMU08X408R-D*
TDBU2250-2447-2.5	TDSCA57-62	2.289	2.000	2.953	6.117	4.000	11.957	8.8	AP0801	0.020	WWMU08X408R-D*
TDBU2250-2447-2.5	TDSCA57-62	2.329	2.000	2.953	6.117	4.000	11.957	8.8	AP0802	0.039	WWMU08X408R-D*
TDBU2250-2447-2.5	TDSCA57-62	2.368	2.000	2.953	6.117	4.000	11.957	8.8	AP0803	0.059	WWMU08X408R-D*
TDBU2250-2447-2.5	TDSCA57-62	2.407	2.000	2.953	6.117	4.000	11.957	8.8	AP0804	0.079	WWMU08X408R-D*
TDBU2250-2447-2.5	TDSCA57-62	2.447	2.000	2.953	6.117	4.000	11.957	8.8	AP0805	0.098	WWMU08X408R-D*
TDBU2461-2579-2.5	TDSCA63-66	2.461	2.000	2.953	6.447	4.000	12.567	10.1	-	-	WWMU08X408R-D*
TDBU2461-2579-2.5	TDSCA63-66	2.500	2.000	2.953	6.447	4.000	12.567	10.1	AP0801	0.020	WWMU08X408R-D*
TDBU2461-2579-2.5	TDSCA63-66	2.539	2.000	2.953	6.447	4.000	12.567	10.1	AP0802	0.039	WWMU08X408R-D*
TDBU2461-2579-2.5	TDSCA63-66	2.579	2.000	2.953	6.447	4.000	12.567	10.1	AP0803	0.059	WWMU08X408R-D*
TDBU2632-2868-2.5	TDSCA67-73	2.632	2.000	2.953	7.170	4.000	13.544	11.9	-	-	WWMU09X510R-D*
TDBU2632-2868-2.5	TDSCA67-73	2.671	2.000	2.953	7.170	4.000	13.544	11.9	AP1101	0.020	WWMU09X510R-D*
TDBU2632-2868-2.5	TDSCA67-73	2.711	2.000	2.953	7.170	4.000	13.544	11.9	AP1102	0.039	WWMU09X510R-D*
TDBU2632-2868-2.5	TDSCA67-73	2.750	2.000	2.953	7.170	4.000	13.544	11.9	AP1103	0.059	WWMU09X510R-D*
TDBU2632-2868-2.5	TDSCA67-73	2.789	2.000	2.953	7.170	4.000	13.544	11.9	AP1104	0.079	WWMU09X510R-D*
TDBU2632-2868-2.5	TDSCA67-73	2.829	2.000	2.953	7.170	4.000	13.544	11.9	AP1105	0.098	WWMU09X510R-D*
TDBU2632-2868-2.5	TDSCA67-73	2.868	2.000	2.953	7.170	4.000	13.544	11.9	AP1106	0.118	WWMU09X510R-D*
TDBU2921-3157-2.5	TDSCA74-80	2.921	2.000	2.953	7.894	4.000	13.973	13.7	-	-	WWMU11X512R-D*
TDBU2921-3157-2.5	TDSCA74-80	2.961	2.000	2.953	7.894	4.000	13.973	13.7	AP1101	0.020	WWMU11X512R-D*
TDBU2921-3157-2.5	TDSCA74-80	3.000	2.000	2.953	7.894	4.000	13.973	13.7	AP1102	0.039	WWMU11X512R-D*
TDBU2921-3157-2.5	TDSCA74-80	3.039	2.000	2.953	7.894	4.000	13.973	13.7	AP1103	0.059	WWMU11X512R-D*
TDBU2921-3157-2.5	TDSCA74-80	3.079	2.000	2.953	7.894	4.000	13.973	13.7	AP1104	0.079	WWMU11X512R-D*
TDBU2921-3157-2.5	TDSCA74-80	3.118	2.000	2.953	7.894	4.000	13.973	13.7	AP1105	0.098	WWMU11X512R-D*
TDBU2921-3157-2.5	TDSCA74-80	3.157	2.000	2.953	7.894	4.000	13.973	13.7	AP1106	0.118	WWMU11X512R-D*

Body SPARE PARTS

Designation	① Setting plate screw	Plug Screw	② Cartridge screw	③ Setting plate 1	③ Setting plate 2	③ Setting plate 3	③ Setting plate 4	③ Setting plate 5	③ Setting plate 6	Wrench for setting plate	Wrench for cartridge	Wrench for plug	④ Washer
TDBU2250-2447-2.5	CSTB-3	PT1/4GN	CM5X0.8X12	AP0801	AP0802	AP0803	AP0804	AP0805	-	T-9D	P-4	P-6	5.3X10X1.6
TDBU2461-2579-2.5	CSTB-3	PT1/4GN	CHHM6-15	AP0801	AP0802	AP0803	-	-	-	T-9D	P-5	P-6	6.4X12.5X1.6
TDBU2632-2868-2.5	CSTB-3	PT1/4GN	CM6X16	AP1101	AP1102	AP1103	AP1104	AP1105	AP1106	T-9D	P-5	P-6	6.4X12.5X1.6
TDBU2921-3157-2.5	CSTB-3	PT1/4GN	CM6X16	AP1101	AP1102	AP1103	AP1104	AP1105	AP1106	T-9D	P-5	P-6	6.4X12.5X1.6

Cartridge set SPARE PARTS

Designation	⑤ Insert screw	Wrench
TDSCA57-62	CSTB-3	T-9F
TDSCA63-66	CSTB-3	T-9F
TDSCA67-73	CSTB-4	T-15F
TDSCA74-80	CSTB-5	T-20F

Cartridge SPARE PARTS

Designation	Insert screw (x2)	Setting plate screw
TDS08CA-C-57-62	CSTB-3	-
TDS08CA-C-63-66	CSTB-3	-
TDS09CA-C-67-73	CSTB-4	-
TDS11CA-C-74-80	CSTB-5	-

SPARE PARTS

Designation	Insert screw (x2)	Setting plate screw (x2)
TDS08CA-P-57-62	CSTB-3	CSTB-3
TDS08CA-P-63-66	CSTB-3	CSTB-3
TDS09CA-P-67-73	CSTB-4	CSTB-3
TDS11CA-P-74-80	CSTB-5	CSTB-3

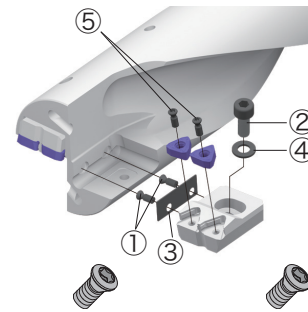

Recommended clamping torque: CSTB-3 = 1.70 lb-ft, CSTB-4 = 2.58 lb-ft, CSTB-5 = 3.69 lb-ft

Reference pages: Inserts → **J086**, Standard cutting conditions → **J087**

INSERT

DJ

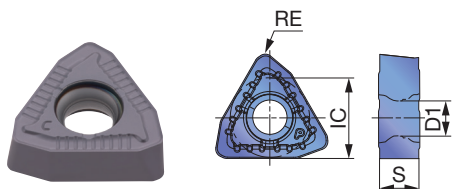

P	Steel	☆	★						
M	Stainless	★	☆						
K	Cast iron	☆	★						
N	Non-ferrous	★	☆						
S	Superalloys	★	☆						
H	Hard materials	★	☆						

★ : First choice
☆ : Second choice

Designation	IC (in)	S (in)	Coated						D1 (in)	RE (in)	DCN (in)	DCX (in)
			AH3135	AH9030								
WWMU05X205R-DJ	0.228	0.094	●	●					0.098	0.020	0.787	0.925
WWMU060306R-DJ	0.264	0.114	●	●					0.118	0.024	0.941	1.063
WWMU08X408R-DJ	0.315	0.154	●	●					0.134	0.031	1.083	1.260
WWMU09X510R-DJ	0.382	0.193	●	●					0.173	0.039	1.299	1.331
WWMU11X512R-DJ	0.445	0.224	●	●					0.217	0.047	1.535	1.811
WWMU13X512R-DJ	0.512	0.224	●	●					0.217	0.047	1.850	2.126

● : Line up

DS

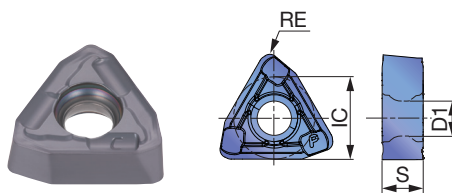

P	Steel	★							
M	Stainless	★							
K	Cast iron								
N	Non-ferrous								
S	Superalloys	★							
H	Hard materials								

★ : First choice
☆ : Second choice

Designation	IC (in)	S (in)	Coated						D1 (in)	RE (in)	DCN (in)	DCX (in)
			AH6030									
WWMU05X205R-DS	0.228	0.094	●						0.098	0.020	0.787	0.925
WWMU060306R-DS	0.264	0.114	●						0.118	0.024	0.941	1.063
WWMU08X408R-DS	0.315	0.154	●						0.134	0.031	1.083	1.260
WWMU09X510R-DS	0.382	0.193	●						0.173	0.039	1.299	1.331
WWMU11X512R-DS	0.445	0.224	●						0.217	0.047	1.535	1.811
WWMU13X512R-DS	0.512	0.224	●						0.217	0.047	1.850	2.126

● : Line up

STANDARD CUTTING CONDITIONS

ISO	Workpiece material	Priority	Chip breakers	Grade	Cutting speed Vc (sfm)	Feed: f (ipr)		
						DC (in)		
						ø2.165 - ø2.205	ø2.244 - ø2.874	ø2.913 - ø3.150
P	Low carbon steels (C<0.3) 1018, 1020, 1026, etc.	First choice	DS	AH6030	525 - 820	0.0016 - 0.0039	0.0016 - 0.0039	0.0016 - 0.0039
		Wear resistance	DJ	AH9030	525 - 1050	0.0016 - 0.0039	0.0016 - 0.0039	0.0016 - 0.0039
	Carbon steels (C>0.3) 1045, 1055, etc.	First choice	DJ	AH9030	262 - 820	0.0024 - 0.0063	0.0024 - 0.0071	0.0031 - 0.0079
		Fracture resistance	DJ	AH3135	262 - 820	0.0016 - 0.0051	0.0016 - 0.0059	0.0016 - 0.0063
	Low alloy steels 5120, etc.	First choice	DS	AH6030	525 - 820	0.0016 - 0.0047	0.0016 - 0.0047	0.0016 - 0.0047
		Wear resistance	DJ	AH9030	525 - 820	0.0024 - 0.0055	0.0024 - 0.0055	0.0024 - 0.0055
	Alloy steels 4140, 8620, etc.	First choice	DJ	AH9030	262 - 656	0.0024 - 0.0063	0.0024 - 0.0071	0.0031 - 0.0079
		Fracture resistance	DJ	AH3135	262 - 656	0.0016 - 0.0051	0.0016 - 0.0055	0.0016 - 0.0059
M	Stainless steels (Austenitic) 304SS, 316SS, etc.	First choice	DS	AH6030	328 - 656	0.0016 - 0.0047	0.0016 - 0.0047	0.0016 - 0.0047
		—	DJ	AH3135	328 - 656	0.0016 - 0.0047	0.0016 - 0.0047	0.0016 - 0.0047
	Stainless steels (Martensitic and ferritic) 430SS, 416SS, etc.	First choice	DS	AH6030	328 - 656	0.0016 - 0.0047	0.0016 - 0.0047	0.0016 - 0.0047
		—	DJ	AH3135	328 - 656	0.0016 - 0.0047	0.0016 - 0.0047	0.0016 - 0.0047
	Stainless steels (Precipitation hardening) 17-4 PH, etc.	First choice	DS	AH6030	262 - 394	0.0016 - 0.0039	0.0016 - 0.0039	0.0016 - 0.0039
		—	DJ	AH3135	262 - 394	0.0016 - 0.0039	0.0016 - 0.0039	0.0016 - 0.0039
K	Gray cast irons Class 25, Class 30, etc.	First choice	DJ	AH9030	262 - 820	0.0024 - 0.0071	0.0031 - 0.0079	0.0031 - 0.0087
		Fracture resistance	DJ	AH3135	262 - 656	0.0024 - 0.0059	0.0031 - 0.0063	0.0031 - 0.0071
	Ductile cast irons 60-40-18, 60-55-06, etc.	First choice	DJ	AH9030	262 - 656	0.0024 - 0.0063	0.0024 - 0.0071	0.0031 - 0.0079
		Fracture resistance	DJ	AH3135	262 - 492	0.0024 - 0.0059	0.0031 - 0.0063	0.0031 - 0.0071
N	Aluminum alloy	First choice	DS	AH6030	656 - 1312	0.0039 - 0.0079	0.0039 - 0.0091	0.0039 - 0.0098
		—	DJ	AH9030	656 - 1312	0.0039 - 0.0079	0.0039 - 0.0091	0.0039 - 0.0098
S	Heat-resistant alloys Inconel718, etc.	First choice	DS	AH6030	66 - 197	0.0016 - 0.0031	0.0016 - 0.0039	0.0016 - 0.0039
		—	DJ	AH3135	66 - 197	0.0016 - 0.0031	0.0016 - 0.0039	0.0016 - 0.0039
	Titanium alloys Ti-6Al-4V, etc.	First choice	DS	AH6030	131 - 394	0.0024 - 0.0047	0.0024 - 0.0055	0.0024 - 0.0055
		—	DJ	AH3135	131 - 394	0.0024 - 0.0047	0.0024 - 0.0055	0.0024 - 0.0055
H	Hardened steel < 40HRC	First choice	DJ	AH9030	164 - 328	0.0016 - 0.0031	0.0016 - 0.0039	0.0016 - 0.0039
		Fracture resistance	DJ	AH3135	131 - 262	0.0016 - 0.0031	0.0016 - 0.0039	0.0016 - 0.0039

Caution

Machine

- Use drills on a fully covered machine to maintain safety.
- Use drills on a high powered machine such as a BT50.
- Figure on right shows reference of required machine power.

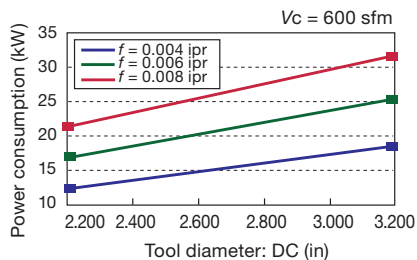

Cutting coolant

- Internal coolant supply is recommended.
- Coolant pressure higher than 1MPa is essential.
- Use water soluble type coolant.

Grade
Insert
Toolholder
Ext. Toolholder
Int. Toolholder
Threading
Grooving
Miniature Tool
Milling Cutter
Endmill
Drilling Tool
Tooling System
Index



TDB, TDX cartridge set

Adjustable tool diameter, L/D = 2.5, tool diameter $\varnothing 2.250'' - \varnothing 3.157''$

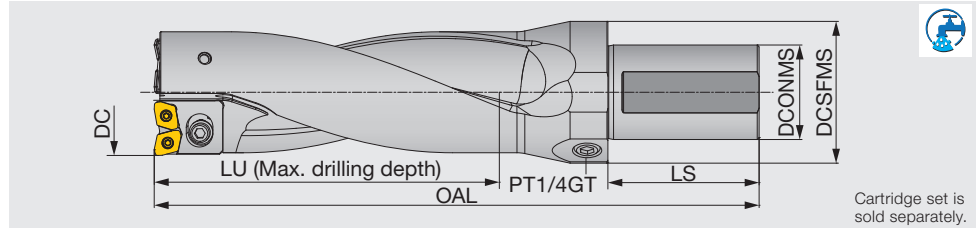

Cartridge set is sold separately.

Body	Cartridge set	DC	DCONMS	DCSFMS	LU	LS	OAL	WT(lb)	Setting plate Designation	Setting plate Thickness	Insert
Inch	Inch										
TDBU2250-2447-2.5	TDXCA57-62	2.250	2.000	2.953	6.117	4.000	11.874	8.8	-	-	XPMT08T308R-D*
TDBU2250-2447-2.5	TDXCA57-62	2.289	2.000	2.953	6.117	4.000	11.874	8.8	AP0801	0.020	XPMT08T308R-D*
TDBU2250-2447-2.5	TDXCA57-62	2.329	2.000	2.953	6.117	4.000	11.874	8.8	AP0802	0.039	XPMT08T308R-D*
TDBU2250-2447-2.5	TDXCA57-62	2.368	2.000	2.953	6.117	4.000	11.874	8.8	AP0803	0.059	XPMT08T308R-D*
TDBU2250-2447-2.5	TDXCA57-62	2.407	2.000	2.953	6.117	4.000	11.874	8.8	AP0804	0.079	XPMT08T308R-D*
TDBU2250-2447-2.5	TDXCA57-62	2.447	2.000	2.953	6.117	4.000	11.874	8.8	AP0805	0.098	XPMT08T308R-D*
TDBU2461-2579-2.5	TDXCA63-66	2.461	2.000	2.953	6.447	4.000	12.465	10.1	-	-	XPMT08T308R-D*
TDBU2461-2579-2.5	TDXCA63-66	2.500	2.000	2.953	6.447	4.000	12.465	10.1	AP0801	0.020	XPMT08T308R-D*
TDBU2461-2579-2.5	TDXCA63-66	2.539	2.000	2.953	6.447	4.000	12.465	10.1	AP0802	0.039	XPMT08T308R-D*
TDBU2461-2579-2.5	TDXCA63-66	2.579	2.000	2.953	6.447	4.000	12.465	10.1	AP0803	0.059	XPMT08T308R-D*
TDBU2632-2868-2.5	TDXCA67-73	2.632	2.000	2.953	7.170	4.000	13.449	11.9	-	-	XPMT110412R-D*
TDBU2632-2868-2.5	TDXCA67-73	2.671	2.000	2.953	7.170	4.000	13.449	11.9	AP1101	0.020	XPMT110412R-D*
TDBU2632-2868-2.5	TDXCA67-73	2.711	2.000	2.953	7.170	4.000	13.449	11.9	AP1102	0.039	XPMT110412R-D*
TDBU2632-2868-2.5	TDXCA67-73	2.750	2.000	2.953	7.170	4.000	13.449	11.9	AP1103	0.059	XPMT110412R-D*
TDBU2632-2868-2.5	TDXCA67-73	2.789	2.000	2.953	7.170	4.000	13.449	11.9	AP1104	0.079	XPMT110412R-D*
TDBU2632-2868-2.5	TDXCA67-73	2.829	2.000	2.953	7.170	4.000	13.449	11.9	AP1105	0.098	XPMT110412R-D*
TDBU2632-2868-2.5	TDXCA67-73	2.868	2.000	2.953	7.170	4.000	13.449	11.9	AP1106	0.118	XPMT110412R-D*
TDBU2921-3157-2.5	TDXCA74-80	2.921	2.000	2.953	7.894	4.000	13.843	13.7	-	-	XPMT110412R-D*
TDBU2921-3157-2.5	TDXCA74-80	2.961	2.000	2.953	7.894	4.000	13.843	13.7	AP1101	0.020	XPMT110412R-D*
TDBU2921-3157-2.5	TDXCA74-80	3.000	2.000	2.953	7.894	4.000	13.843	13.7	AP1102	0.039	XPMT110412R-D*
TDBU2921-3157-2.5	TDXCA74-80	3.039	2.000	2.953	7.894	4.000	13.843	13.7	AP1103	0.059	XPMT110412R-D*
TDBU2921-3157-2.5	TDXCA74-80	3.079	2.000	2.953	7.894	4.000	13.843	13.7	AP1104	0.079	XPMT110412R-D*
TDBU2921-3157-2.5	TDXCA74-80	3.118	2.000	2.953	7.894	4.000	13.843	13.7	AP1105	0.098	XPMT110412R-D*
TDBU2921-3157-2.5	TDXCA74-80	3.157	2.000	2.953	7.894	4.000	13.843	13.7	AP1106	0.118	XPMT110412R-D*

Body

SPARE PARTS

Designation	① Setting plate screw	Plug Screw	② Cartridge screw	③ Setting plate 1	③ Setting plate 2	③ Setting plate 3	③ Setting plate 4	③ Setting plate 5	③ Setting plate 6	Wrench for setting plate	Wrench for cartridge	Wrench for plug	④ Washer
TDBU2250-2447-2.5	CSTB-3	PT1/4GN	CM5X0.8X12	AP0801	AP0802	AP0803	AP0804	AP0805	-	T-9D	P-4	P-6	5.3X10X1.6
TDBU2461-2579-2.5	CSTB-3	PT1/4GN	CHHM6-15	AP0801	AP0802	AP0803	-	-	-	T-9D	P-5	P-6	6.4X12.5X1.6
TDBU2632-2868-2.5	CSTB-3	PT1/4GN	CM6X16	AP1101	AP1102	AP1103	AP1104	AP1105	AP1106	T-9D	P-5	P-6	6.4X12.5X1.6
TDBU2921-3157-2.5	CSTB-3	PT1/4GN	CM6X16	AP1101	AP1102	AP1103	AP1104	AP1105	AP1106	T-9D	P-5	P-6	6.4X12.5X1.6

Cartridge set

SPARE PARTS

Designation	⑤ Insert screw	Wrench
TDXCA57-62	CSTB-3	T-9F
TDXCA63-66	CSTB-3	T-9F
TDXCA67-73	CSTB-4	T-15F
TDXCA74-80	CSTB-4	T-15F

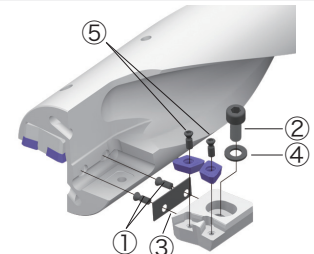

Cartridge

SPARE PARTS

Designation	Insert screw (x2)	Setting plate screw
TDX08CA-C1	CSTB-3	-
TDX08CA-C2	CSTB-3	-
TDX11CA-C1	CSTB-4	-
TDX11CA-C2	CSTB-4	-

SPARE PARTS

Designation	Insert screw (x2)	Setting plate screw (x2)
TDX08CA-P1	CSTB-3	CSTB-3
TDX08CA-P2	CSTB-3	CSTB-3
TDX11CA-P1	CSTB-4	CSTB-3
TDX11CA-P2	CSTB-4	CSTB-3

Recommended clamping torque: CSTB-3= 1.70 lb-ft, CSTB-4= 2.58 lb-ft

Reference pages: Inserts → **J089 - J090**, Standard cutting conditions → **J090 - J091**

INSERT

DJ

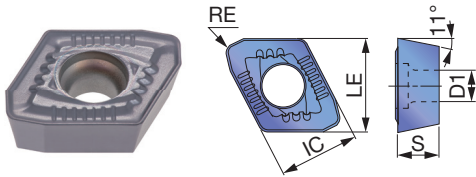

P	Steel			★	☆				
M	Stainless	☆		★					
K	Cast iron		☆	☆	★				
N	Non-ferrous	☆		★					
S	Superalloys	☆		★	☆				
H	Hard materials	☆		★	☆				

★ : First choice
☆ : Second choice

Designation	IC (in)	LE (in)	Coated				S (in)	D1 (in)	RE (in)	DCN (in)	DCX (in)
			AH725	T1115	AH6030	AH9030					
XPMT08T308R-DJ	0.335	0.390	●	●	●	●	0.156	0.134	0.031	2.250	2.579
XPMT110412R-DJ	0.441	0.492	●	●	●	●	0.187	0.173	0.047	2.632	3.157

● : Line up

DS

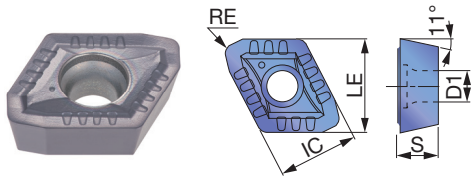

P	Steel	☆	★						
M	Stainless	☆	★						
K	Cast iron								
N	Non-ferrous	☆							
S	Superalloys	☆	★						
H	Hard materials								

★ : First choice
☆ : Second choice

Designation	IC (in)	LE (in)	Coated				S (in)	D1 (in)	RE (in)	DCN (in)	DCX (in)
			AH725	AH6030							
XPMT08T308R-DS	0.335	0.390	●	●			0.156	0.134	0.031	2.250	2.579
XPMT110412R-DS	0.441	0.492	●	●			0.187	0.173	0.047	2.632	3.157

● : Line up

DW

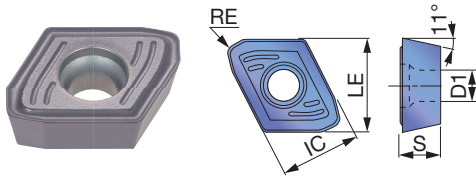

P	Steel	☆	★	☆					
M	Stainless	☆	★	☆					
K	Cast iron		☆	★					
N	Non-ferrous	☆	★						
S	Superalloys	☆	★	☆					
H	Hard materials	☆	★	☆					

★ : First choice
☆ : Second choice

Designation	IC (in)	LE (in)	Coated				S (in)	D1 (in)	RE (in)	DCN (in)	DCX (in)
			AH725	AH6030	AH9030						
XPMT08T308R-DW	0.335	0.390	●	●	●		0.156	0.134	0.031	2.250	2.579
XPMT110412R-DW	0.441	0.492	●	●	●		0.187	0.173	0.047	2.632	3.157

● : Line up

Grade
Insert
Toolholder
Ext. Toolholder
Int. Toolholder
Threading
Grooving
Milling Cutter
Miniature Tool
Endmill
Drilling Tool
User's Guide
Tooling System
Index

A
B
C
D
E
F
G
H
I
J
K
L
M

INSERT

DG

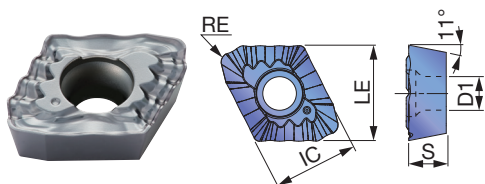

P	Steel	★							
M	Stainless	☆							
K	Cast iron								
N	Non-ferrous	★							
S	Superalloys	☆							
H	Hard materials								

★ : First choice
 ☆ : Second choice

Designation	IC (in)	LE (in)	Coated							S (in)	D1 (in)	RE (in)	DCN (in)	DCX (in)
			AH725											
XPMT08T308R-DG	0.335	0.390	●							0.156	0.134	0.031	2.250	2.579
XPMT110412R-DG	0.441	0.492	●							0.187	0.173	0.047	2.632	3.157

● : Line up

RECOMMENDED INSERT

ISO	Workpiece material	First choice	High feed	High speed	Chipping resistance	Troubleshooting		
						Wear resistance	Surface finish	Chip control
P	Low carbon steels (C ≤ 0.3%)	DS, AH6030	-	-	DS, AH725	-	DW, AH6030	DG, AH725
	Carbon steels (C > 0.3%) Alloy steels	DJ, AH6030	DW, AH6030	DJ, AH9030	DW, AH725	DJ, AH9030	DW, AH6030	-
	Low alloy steels	DS, AH6030	-	-	DS, AH725	-	DW, AH6030	-
M	Stainless steel	DS, AH6030	-	-	DS, AH725	-	DW, AH6030	DG, AH725
K	Gray cast irons	DJ, AH9030	DW, AH9030	DJ, T1115	DW, AH725	-	DW, AH9030	-
	Ductile cast irons	DJ, AH9030	DW, AH9030	-	DW, AH725	-	DW, AH9030	-
N	Aluminum alloy	DJ, AH725	DW, AH725	DS, AH6030		-	DW, AH725	DG, AH725
S	Titanium alloys Heat-resistant alloys	DS, AH6030	-	-	DW, AH725	-	DW, AH725	DG, AH725
H	Hardened steel	DJ, AH9030	DW, AH9030	-	DW, AH725	-	DW, AH9030	-

STANDARD CUTTING CONDITIONS

ISO	Workpiece material	Cutting speed Vc (sfm)	Feed: f (ipr)		
			ø2.165 ~ ø2.441	ø2.480 ~ ø2.874	ø2.913 ~ ø3.150
P	Low carbon steels (C < 0.3) 1018, 1026, etc.	525 - 1050	0.0016 - 0.0039	0.0016 - 0.0039	0.0016 - 0.0039
	Carbon steels (C > 0.3) 1045, 1055, etc.	262 - 820	0.0031 - 0.0071	0.0031 - 0.0071	0.0039 - 0.0079
	Low alloy steels 4130, etc.	525 - 820	0.0016 - 0.0063	0.0016 - 0.0063	0.0016 - 0.0063
	Alloy steels 4140, 5120, etc.	262 - 656	0.0031 - 0.0071	0.0031 - 0.0071	0.0031 - 0.0079
M	Stainless steels (Austenitic) 304, 316, etc.	328 - 656	0.0016 - 0.0047	0.0016 - 0.0047	0.0024 - 0.0055
	Stainless steels (Martensitic and ferritic) 430, 416, etc.	328 - 656	0.0016 - 0.0047	0.0016 - 0.0047	0.0024 - 0.0055
	Stainless steels (Precipitation hardening) 630, etc.	262 - 394	0.0016 - 0.0039	0.0016 - 0.0039	0.0024 - 0.0047
K	Gray cast irons Class 25, Class 30, etc.	262 - 820	0.0031 - 0.0079	0.0031 - 0.0079	0.0039 - 0.0087
	Ductile cast irons 60-40-18, etc.	262 - 656	0.0031 - 0.0079	0.0031 - 0.0079	0.0039 - 0.0087
N	Aluminum alloy 333.0, 383.0, etc.	656 - 1312	0.0059 - 0.0098	0.0059 - 0.0098	0.0071 - 0.011
S	Heat-resistant alloys Inconel 718, etc.	66 - 197	0.0016 - 0.0039	0.0016 - 0.0039	0.0016 - 0.0039
	Titanium alloys Ti-6Al-4V, etc.	131 - 394	0.0024 - 0.0047	0.0024 - 0.0047	0.0024 - 0.0047
H	Hardened steel ≥ 40HRC	131 - 328	0.0016 - 0.0039	0.0016 - 0.0039	0.0016 - 0.0039

Standard cutting conditions for DG type chipbreaker

ISO	Workpiece material	Cutting speed Vc (sfm)	Series L/D	Feed: f (ipr)	
				ø1.062" - ø1.250"	ø1.312" - ø2.000"
P	Low carbon steels (C < 0.3) 1018, 1026, etc.	260 - 590	2D, 3D 4D, 5D	0.0016 - 0.0039	

Caution

Machine

- Use drills on a fully covered machine to maintain safety.
- Use drills on a high powered machine such as a BT50.
- Figure on right shows reference of required machine power.

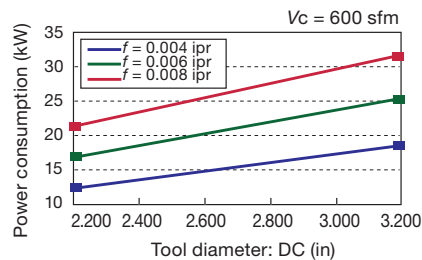

Cutting coolant

- Use water soluble type coolant with internal supply.
- Coolant pressure higher than 1MPa is essential.

Grade
Insert
Ext. Toolholder
Int. Toolholder
Threading
Grooving
Miniature Tool
Endmill
Drilling Tool
Tooling System
Index

Drilling Insert

● LPMT03X206R-D4, LPMT05X204-D4

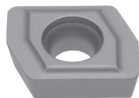
Shape	Designation	Coated			Applicable drill diameter	Applicable drill
		T313W				
	LPMT03X206R-D4	●			φ14 ~ φ17.5 (φ0.551" - φ0.689")	TDJ (Former products)
	LPMT05X204-D4	●			φ14 ~ φ17.5 (φ0.551" - φ0.689")	

● SPMP831DS, SPMP/M**2ERD

Shape	Designation	ISO Metric Designation	Coated			Applicable drill diameter	Applicable drill
			T313W				
	SPMP831DS	SPMT060204-DS	●			φ18 ~ φ19.5 (φ0.709" - φ0.768")	TDR, for Peripheral side (Former products)
	SPMP042ERD	SPMP080308ER-D	●			φ20 ~ φ28.5 (φ0.787" - φ1.122")	
	SPMM322ERD	SPMT090308ER-D	●			φ29 ~ φ34.5 (φ1.142" - φ1.358")	
	SPMM432ERD	SPMT120408ER-D	●			φ35 ~ φ49 (φ1.378" - φ1.929")	

● TPMP**ZDS, TPMP**ZERD, TPMM**ZERD

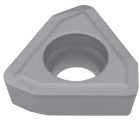
Shape	Designation	Coated			Applicable drill diameter	Applicable drill
		T313W				
	TPMP83ZDS	●			φ18 ~ φ19.5 (φ0.709" - φ0.768")	TDR, for Central side (Former products)
	TPMP04ZERD	●			φ20 ~ φ28.5 (φ0.787" - φ1.122")	
	TPMM32ZERD	●			φ29 ~ φ34.5 (φ1.142" - φ1.358")	
	TPMM43ZERD	●			φ35 ~ φ54 (φ1.378" - φ2.126")	

TPMM43ZERD can be used on the peripheral side.

● WCMT**-D...

Shape	Designation	Coated			Applicable drill
		AH120	AH140	T313W	
	WCMT050308-DC			●	for counter boring, and drilling.
	WCMT050308-D4	●	●	●	
	WCMT06T308-DC			●	
	WCMT06T308-D4	●	●	●	
	WCMT080412-DC			●	
	WCMT080412-D4			●	

● : Line up

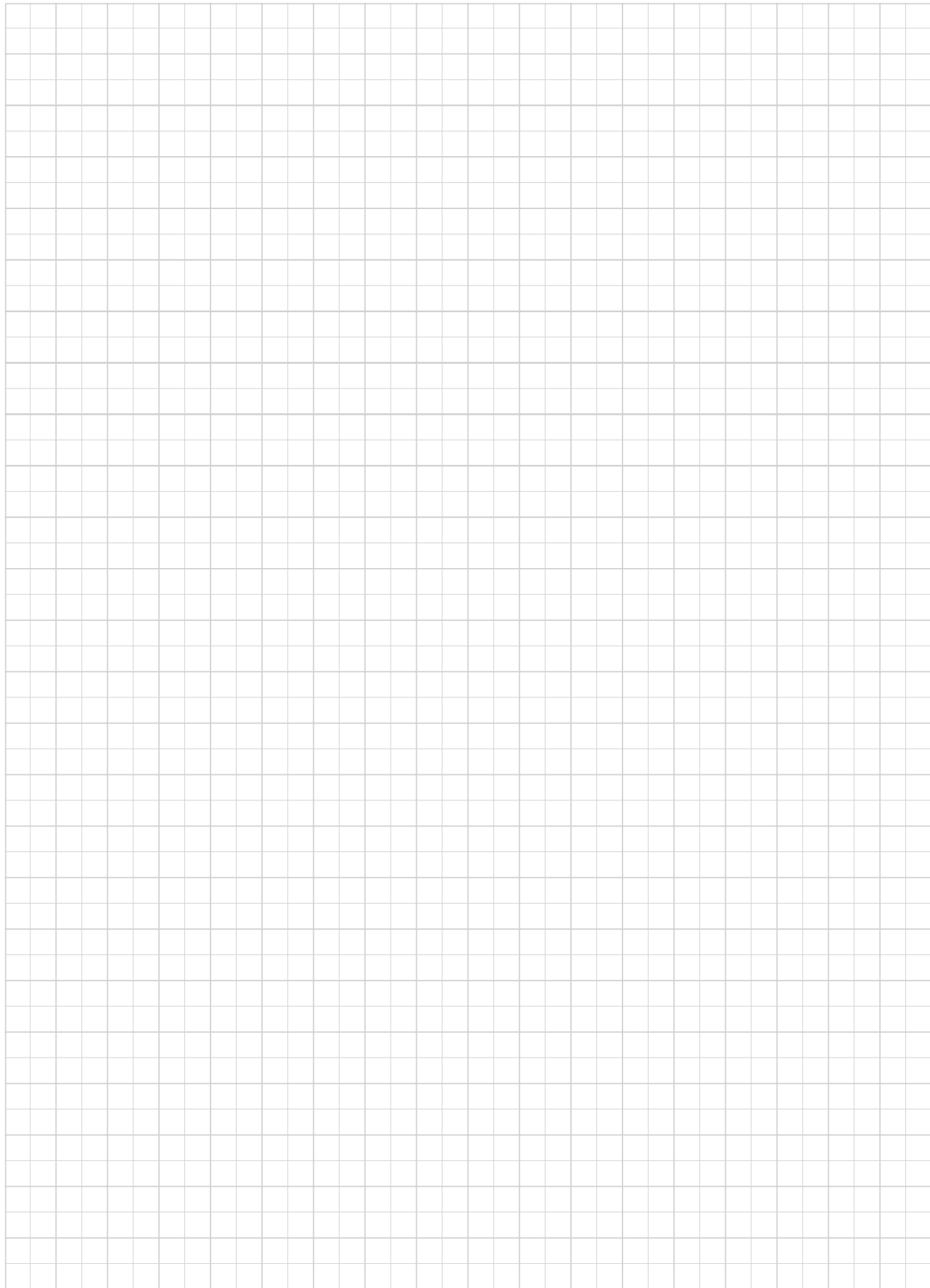

Grade
 Insert
 Ext. Toolholder
 Int. Toolholder
 Threading
 Grooving
 Miniature Tool
 Milling Cutter
 Endmill
Drilling Tool
 Tooling System
 User's Guide
 Index



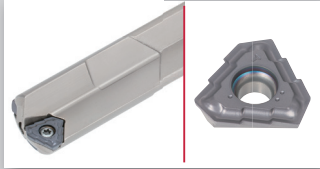

Deep Hole Drill

Inch Metric



DEEPTRI

Excellent productivity and stability in deep hole drilling



 $\varnothing 0.472'' - \varnothing 1.575''$ ($\varnothing 12 \text{ mm} - \varnothing 40 \text{ mm}$) / L/D = 8, 10, 15, 20, 25, for machining centers
 OAL < 64.961" (1650 mm) for gundrill machines (standard line-ups)

J007, J095
J096 - J121



GUNDRILL

Brazed gundrills suitable for small diameter deep hole drilling

 $\varnothing 3 \text{ mm} - \varnothing 12.2 \text{ mm}$ ($\varnothing 0.118'' - \varnothing 0.480''$)
 OAL $\leq 1650 \text{ mm}$ ($\varnothing 64.00''$) (standard line-ups)

J007, J095
J122



TRI-FINE

Direct mount drill head with 3-cornered inserts

 $\varnothing 16 \text{ mm} - \varnothing 28 \text{ mm}$ ($\varnothing 0.630'' - \varnothing 1.102''$)

J007, J124
J128 - J131

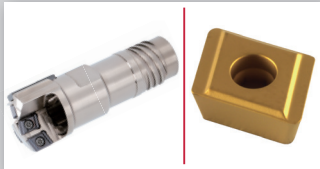

FINE-BEAM

Direct mount deep hole drilling heads

 $\varnothing 25 \text{ mm} - \varnothing 65 \text{ mm}$ ($\varnothing 0.984'' - \varnothing 2.559''$)

J007, J124
J132 - J137



UNIDEX

Indexable deep hole drilling heads with adjustable diameters

 $\varnothing 38 \text{ mm} - \varnothing 106.99 \text{ mm}$ ($\varnothing 1.496'' - \varnothing 4.212''$)

J007, J124
J138 - J143



Brazed BTA tool

New solution for BTA drilling with two types of tools: single tube and double tube

 $\varnothing 8 - \varnothing 65$ ($\varnothing 0.315'' - \varnothing 0.614''$)

J007, J125 - 127
J144 - J156

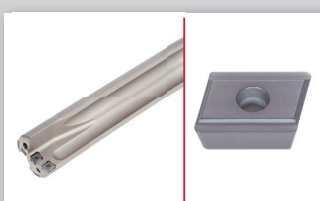

HF drills for deep hole drilling





Indexable deep hole drills for large diameter with high productivity

 $\varnothing 30 \text{ mm} - \varnothing 63 \text{ mm}$ ($\varnothing 1.181'' - \varnothing 2.480''$),
hole depth: L/D=14

J007, J157 - J158

Indexable Gundrill guide

Indexable Gundrills & Brazed Gundrills

Drill type	Lathes & machining centers			Gundrill machines			Brazed tool
	MCTR	MCTRCH	MCTR	TRLG	TRLGCH	TRLG	SLJ
Indexable Gundrills Brazed Gundrill							
	<input checked="" type="checkbox"/> Inch <input checked="" type="checkbox"/> Metric	<input checked="" type="checkbox"/> Inch <input checked="" type="checkbox"/> Metric	<input checked="" type="checkbox"/> Inch <input checked="" type="checkbox"/> Metric	<input checked="" type="checkbox"/> Inch <input checked="" type="checkbox"/> Metric	<input checked="" type="checkbox"/> Inch <input checked="" type="checkbox"/> Metric	<input checked="" type="checkbox"/> Inch <input checked="" type="checkbox"/> Metric	<input type="checkbox"/> Inch <input checked="" type="checkbox"/> Metric
Drill diameter	ø0.500" - ø1.062" (ø12 mm - ø28mm)	ø0.578" - ø0.937" (ø14 mm - ø28 mm)	ø1.125" - ø1.500" (ø28.01 mm - ø40 mm)	ø0.472" - ø1.102" (ø12 mm - ø28 mm)	ø0.591" - ø0.937" (ø14 mm - ø28 mm)	ø1.181" (ø28.01 mm - ø40 mm)	ø3 - ø12.2
MCTR: Drilling depth TRLG, SLJ: Tool over all length	Max L/D = 25	Max L/D = 25	Max L/D = 25	31.567" - 39.516" (801.8 mm - 1003.7 mm)	65.039" - 72.181" (1652 mm - 1653.4 mm)	65.075" (1002.9 mm - 1652.9 mm)	ø3 - ø4.1 : Max = 800 mm ø4.1 - ø4.9 : Max = 1250 mm ø4.9 - ø12.2 : Max = 2000 mm
Hole tolerance (in) ^{*1}	+ 0.002 / - 0.004	+ 0.002 / - 0.005	+ 0.002 / - 0.004	+ 0.002 / - 0.004	+ 0.002 / - 0.005	+ 0.002 / - 0.004	+0.03 / -0.01
Surface finish Ra (µm)	1	1	1	1	1	1	3 - 25
Machine	Deep hole drilling machines	-	-	-	-	-	-
	NC machines	○	○	○	-	-	-
	Lathes	○	○	○	△	△	△
	Machining centers M/C	○	○	○	△	△	△
	Gundrill machines	-	-	-	○	○	○
Workpiece material	P Steel	★★★	★★★	★★★	★★★	★★★	★★
	M Stainless	★★	★★	★★	★★	★★	★
	K Cast iron	★★★	★★★	★★★	★★★	★★★	★★★
	N Non-ferrous	★★	★★	★★	★★	★★	★★★
	S Superalloys	★★	★★	★★	★★	★★	★
H Hard materials (≥40HRC)	★★★	★★★	★★★	★★★	★★★	★★★	★
Insert type	LOGT / TOHT	TOHT	FBH / FBM	LOGT / TOHT	TOHT	FBH / FBM	-
Page	J097 - J100	J101	J1012 - J107	J108 - J109	J110	J111 - J121	J122 - J123

*1: Just for reference

★★★(Excellent) ←→ ★(Standard)

Grade
Insert
Toolholder
Ext. Toolholder
Int. Toolholder
Threading
Grooving
Miniature Tool
Endmill
Drilling Tool
Tooling System
Index



DEEPT^{RI}DRILL



Indexable gundrill
 for extreme productivity
 and stability

Ultimate efficiency

Unique chipbreakers on the cutting edge enable impressive chip control and high feed rates.

Excellent chip control

- Chip splitters breaks chips into smaller segments to facilitate smooth Chip evacuation process
- Its smooth chip evacuation ability allows the use in standard lathes and machining centers

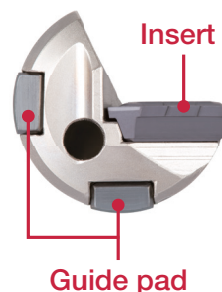

Performance comparison with other types of drills

P 1055

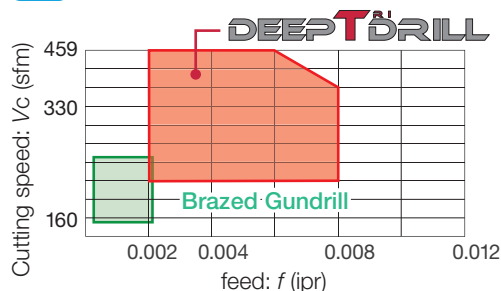

Chip control

P 1055 Drill diameter : DC = 0.827"



Cutting speed : Vc = 328 sfm
 feed : f = 0.006 ipr



Vc = 197 sfm
 f = 0.002 ipr

Two bodies available for machining centers, lathes, and gundrill machines

MCTR : for machining centers and lathes



Tool dia.: DC = 0.500" - 1.575" (12 mm - 40 mm)
 *Max. DC = 40 : Available tailor-made tools
 L/D : 8, 10, 15, 20, 25

TRLG : for gundrill machines



Tool dia. : DC = 0.472" - 1.181" (12 mm - 30 mm)
 *Max. DC = 40 : Available tailor-made tools
 Overall length: 31.496", 39.370", 59.055", 64.961"
 (800 mm, 1000 mm, 1500 mm, 1650 mm)

* Can be tailored up to 94.488" (2400 mm) overall length

Reference pages: **J097 - J121**, Technical references → **L084**

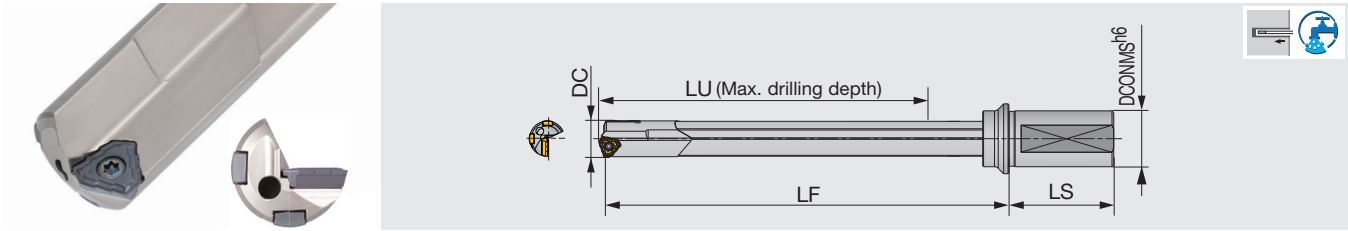

Inch	DC	DCONMS	LU	LS	LF	Insert	Guide pad
MCTR17.45XU25.4A-10	0.687	1.000	7.173	2.205	8.661	TOHT08..	GP05-075, GP05-18-075-DC
MCTR18.24XU25.4-10	0.718	1.000	7.598	2.205	9.134	TOHT09..	GP06-085, GP06-20-085-DC
MCTR18.64XU25.4-10	0.734	1.000	7.598	2.205	9.134	TOHT09..	GP06-085, GP06-20-085-DC
MCTR19.05XU25.4-10	0.750	1.000	7.992	2.205	9.567	TOHT09..	GP06-085, GP06-20-085-DC
MCTR19.94XU31.75-10	0.785	1.250	7.992	2.362	10.039	TOHT09..	GP06-085, GP06-20-085-DC
MCTR20.62XU31.75-10	0.812	1.250	8.394	2.362	10.039	TOHT10..	GP06-085, GP06-20-085-DC
MCTR22.23XU31.75-10	0.875	1.250	9.189	2.362	10.945	TOHT11..	GP06-100, GP06-20-100-DC
MCTR23.80XU31.75-10	0.937	1.250	9.976	2.362	11.850	TOHT11..	GP06-100, GP06-20-100-DC
MCTR25.40XU31.75-10	1.000	1.250	10.382	2.362	12.283	TOHT12..	GP06, GP06-20-120-DC
MCTR26.97XU31.75X-10	1.062	1.250	11.169	2.362	13.189	TOHT12..	GP06, GP06-20-120-DC

Metric	DC	DCONMS	LU	LS	LF	Insert	Guide pad
MCTR16.00XM25A-10	16	25	172.2	56	209	TOHT08...	GP05-075, GP05-18-075-DC
MCTR16.50XM25A-10	16.5	25	172.2	56	209	TOHT08...	GP05-075, GP05-18-075-DC
MCTR17.00XM25A-10	17	25	182.2	56	220	TOHT08...	GP05-075, GP05-18-075-DC
MCTR18.00XM25A-10	18	25	192.2	56	232	TOHT08...	GP05-075, GP05-18-075-DC
MCTR19.00XM25-10	19	25	203	56	243	TOHT09...	GP06-085, GP06-20-085-DC
MCTR20.00XM32-10	20	32	213	60	255	TOHT09...	GP06-085, GP06-20-085-DC
MCTR21.00XM32-10	21	32	223.2	60	266	TOHT10...	GP06-085, GP06-20-085-DC
MCTR22.00XM32-10	22	32	233.4	60	278	TOHT11...	GP06-100, GP06-20-100-DC
MCTR23.00XM32-10	23	32	243.4	60	289	TOHT11...	GP06-100, GP06-20-100-DC
MCTR24.00XM32-10	24	32	253.4	60	301	TOHT11...	GP06-100, GP06-20-100-DC
MCTR25.00XM32-10	25	32	263.4	60	312	TOHT11...	GP06-100, GP06-20-100-DC
MCTR26.00XM40-10	26	40	273.7	70	324	TOHT12...	GP06, GP06-20-120-DC
MCTR27.00XM40-10	27	40	283.7	70	335	TOHT12...	GP06, GP06-20-120-DC
MCTR28.00XM40-10	28	40	283.7	70	337	TOHT12...	GP06, GP06-20-120-DC

DC	Tool diameter tolerance	Applicable tolerance range of hole diameter
0.630 - 1.102	0 / - 0.003	+ 0.002 / - 0.004

(Unit: Inch)

SPARE PARTS

Designation	Insert		Guide pad	
	Screw	Wrench	Screw	Wrench
MCTR16... - MCTR20.00...	SR14-560/S	T-8F	SR34-508	T-7F
MCTR20.62... - MCTR21...	SR34-506	T-9F	SR34-508	T-7F
MCTR22... - MCTR25.00...	SR14-571/S	T-10/5	SR34-508	T-7F
MCTR25.4... - MCTR28...	SR14-506	T-15F	SR34-508	T-7F

Recommended clamping torque (lb-ft): SR34-506=0.66, SR34-508=0.9, SR14-560/S=0.89, SR14-571/S=3.2, SR14-506=3.54



DEEPT^{AI} DRILL

MCTR L/D=15

Drill body for lathes and machining centers, L/D = 15, Tool diameter $\varnothing 0.5"$ - $\varnothing 1.062"$ and $\varnothing 12\text{mm}$ - $\varnothing 28\text{mm}$

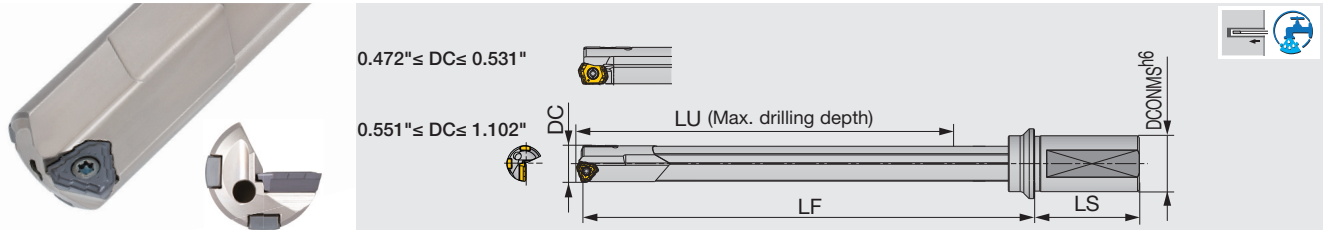

Inch	DC	DCONMS	LU	LS	LF	Insert	Guide pad
MCTR12.70XU25.4-15	0.500	1.000	7.748	2.205	9.016	LOGT06..	GP04-055, GP04-16-055-DC
MCTR13.49XU25.4-15	0.531	1.000	8.339	2.205	9.646	LOGT06..	GP04-055, GP04-16-055-DC
MCTR14.27XU25.4-15	0.562	1.000	8.937	2.205	10.276	TOHT07..	GP05-060, GP05-18-060-DC
MCTR15.88XU25.4-15	0.625	1.000	9.528	2.205	10.984	TOHT07..	GP05-060, GP05-18-060-DC
MCTR17.45XU25.4A-15	0.687	1.000	10.717	2.205	12.205	TOHT08..	GP05-075, GP05-18-075-DC
MCTR18.24XU25.4-15	0.718	1.000	11.339	2.205	12.874	TOHT09..	GP06-085, GP06-20-085-DC
MCTR18.64XU25.4-15	0.734	1.000	11.339	2.205	12.874	TOHT09..	GP06-085, GP06-20-085-DC
MCTR19.05XU25.4-15	0.750	1.000	11.929	2.205	13.504	TOHT09..	GP06-085, GP06-20-085-DC
MCTR19.94XU31.75-15	0.785	1.250	12.520	2.362	14.173	TOHT09..	GP06-085, GP06-20-085-DC
MCTR20.62XU31.75-15	0.812	1.250	12.528	2.362	14.173	TOHT10..	GP06-085, GP06-20-085-DC
MCTR22.23XU31.75-15	0.875	1.250	13.717	2.362	15.472	TOHT11..	GP06-100, GP06-20-100-DC
MCTR23.80XU31.75-15	0.937	1.250	14.898	2.362	16.772	TOHT11..	GP06-100, GP06-20-100-DC
MCTR25.40XU31.75-15	1.000	1.250	15.500	2.362	17.402	TOHT12..	GP06, GP06-20-120-DC
MCTR26.97XU31.75X-15	1.062	1.250	16.681	2.362	18.701	TOHT12..	GP06, GP06-20-120-DC

Metric	DC	DCONMS	LU	LS	LF	Insert	Guide pad
MCTR12.00XM20-15	12	20	196.8	50	225	LOGT06...	GP04-055, GP04-16-055-DC
MCTR12.50XM20-15	12.5	20	196.8	50	226	LOGT06...	GP04-055, GP04-16-055-DC
MCTR13.00XM25-15	13	25	211.8	56	245	LOGT06...	GP04-055, GP04-16-055-DC
MCTR13.50XM25-15	13.5	25	211.8	56	245	LOGT06...	GP04-055, GP04-16-055-DC
MCTR14.00XM25-15	14	25	227	56	245	TOHT07...	GP05-060, GP05-18-060-DC
MCTR14.50XM25-15	14.5	25	227	56	262	TOHT07...	GP05-060, GP05-18-060-DC
MCTR15.00XM25-15	15	25	242	56	278	TOHT07...	GP05-060, GP05-18-060-DC
MCTR16.00XM25A-15	16	25	257.2	56	294	TOHT08...	GP05-075, GP05-18-075-DC
MCTR16.50XM25A-15	16.5	25	257.2	56	294	TOHT08...	GP05-075, GP05-18-075-DC
MCTR17.00XM25A-15	17	25	272.2	56	310	TOHT08...	GP05-075, GP05-18-075-DC
MCTR17.50XM25A-15	17.5	25	272.2	56	310	TOHT08...	GP05-075, GP05-18-075-DC
MCTR18.00XM25A-15	18	25	287.2	56	327	TOHT08...	GP05-075, GP05-18-075-DC
MCTR18.50XM25-15	18.5	25	288	56	327	TOHT09...	GP06-085, GP06-20-085-DC
MCTR19.00XM25-15	19	25	303	56	343	TOHT09...	GP06-085, GP06-20-085-DC
MCTR19.50XM25-15	19.5	25	303	56	343	TOHT09...	GP06-085, GP06-20-085-DC
MCTR20.00XM32-15	20	32	318	60	360	TOHT09...	GP06-085, GP06-20-085-DC
MCTR21.00XM32-15	21	32	333.2	60	376	TOHT10...	GP06-085, GP06-20-085-DC
MCTR22.00XM32-15	22	32	348.4	60	393	TOHT11...	GP06-100, GP06-20-100-DC
MCTR23.00XM32-15	23	32	363.4	60	409	TOHT11...	GP06-100, GP06-20-100-DC
MCTR24.00XM32-15	24	32	378.4	60	426	TOHT11...	GP06-100, GP06-20-100-DC
MCTR25.00XM32-15	25	32	393.4	60	442	TOHT11...	GP06-100, GP06-20-100-DC
MCTR26.00XM40-15	26	40	408.7	70	459	TOHT12...	GP06, GP06-20-120-DC
MCTR27.00XM40-15	27	40	423.7	70	475	TOHT12...	GP06, GP06-20-120-DC
MCTR28.00XM40-15	28	40	423.7	70	477	TOHT12...	GP06, GP06-20-120-DC

DC	Tool diameter tolerance	Applicable tolerance range of hole diameter
0.472 - 1.102	0 / - 0.003	+ 0.002 / - 0.004

(Unit: Inch)

SPARE PARTS

Designation	Insert		Guide pad	
	Screw	Wrench	Screw	Wrench
MCTR12... - MCTR13.5...	SR10503833L040	T-7F	CSPB-2L043	IP-6F
MCTR14... - MCTR20.00...	SR14-560/S	T-8F	SR34-508	T-7F
MCTR20.62... - MCTR21...	SR34-506	T-9F	SR34-508	T-7F
MCTR22... - MCTR25.00...	SR14-571/S	T-10/5	SR34-508	T-7F
MCTR25.4... - MCTR28...	SR14-506	T-15F	SR34-508	T-7F

Recommended clamping torque (lb-ft): CSPB-2L043=0.52, SR34-506=0.66, SR34-508=0.66, SR14-560/S=0.89, SR10503833L040=0.96, SR14-571/S=3.2, SR14-506=3.54

Reference pages: Inserts, Guide pads → **J114 - J117**, Standard cutting conditions → **J118**

Drill body for lathes and machining centers, L/D = 20, Tool diameter $\phi 12 - \phi 15$ mm

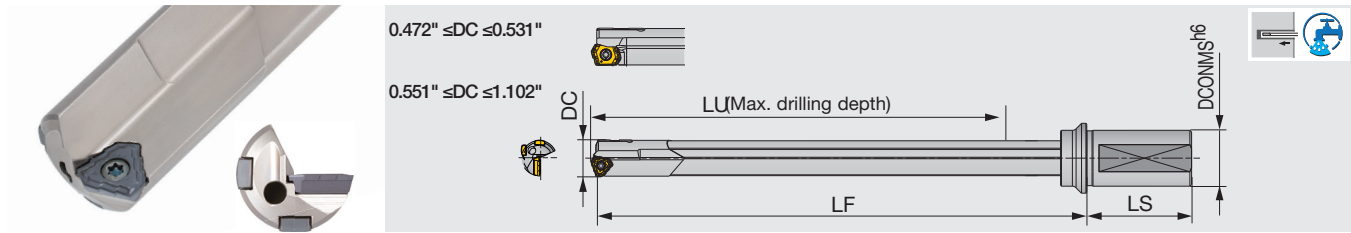

Metric	DC	DCONMS	LU	LS	LF	Insert	Guide pad
MCTR12.00XM20-20	12	20	261.8	50	290	LOGT06...	GP04-055, GP04-16-055-DC
MCTR12.50XM20-20	12.5	20	261.8	50	291	LOGT06...	GP04-055, GP04-16-055-DC
MCTR13.00XM25-20	13	25	281.8	56	315	LOGT06...	GP04-055, GP04-16-055-DC
MCTR13.50XM25-20	13.5	25	281.8	56	315	LOGT06...	GP04-055, GP04-16-055-DC
MCTR14.00XM25-20	14	25	302	56	336	TOHT07...	GP05-060, GP05-18-060-DC
MCTR14.50XM25-20	14.5	25	302	56	337	TOHT07...	GP05-060, GP05-18-060-DC
MCTR15.00XM25-20	15	25	322	56	358	TOHT07...	GP05-060, GP05-18-060-DC

ϕD_c	Tool diameter tolerance	Applicable tolerance range of hole diameter
12 - 15	0 / - 0.07	+ 0.05 / - 0.1

SPARE PARTS

Designation	Insert		Guide pad	
	Screw	Wrench	Screw	Wrench
MCTR12...-MCTR13.5...	SR10503833L040	T-7F	CSPB-2L043	IP-6F
MCTR14...-MCTR15...	SR14-560/S	T-8F	SR34-508	T-7F

Recommended clamping torque (N·m): CSPB-2L043=0.7, SR34-508=0.9, SR14-560/S=1.2, SR10503833L040=1.3

Grade
Insert
Toolholder
Ext. Toolholder
Int. Toolholder
Threading
Grooving
Miniature Tool
Milling Cutter
Endmill
Drilling Tool
Tooling System
User's Guide
Index



DEEPT^{AI} DRILL

MCTR L/D=25

Drill body for lathes and machining centers, L/D = 25, Tool diameter $\varnothing 0.5'' - \varnothing 1.062''$ and $\varnothing 12\text{mm} - \varnothing 28\text{mm}$

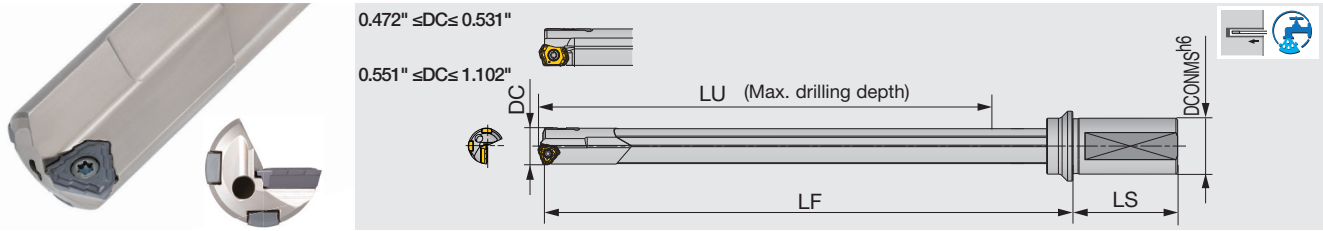

Inch	DC	DCONMS	LU	LS	LF	Insert	Guide pad
MCTR12.70XU25.4-25	0.500	1.000	12.866	2.205	14.134	LOGT06..	GP04-055, GP04-16-055-DC
MCTR13.49XU25.4-25	0.531	1.000	13.850	2.205	15.157	LOGT06..	GP04-055, GP04-16-055-DC
MCTR14.27XU25.4-25	0.562	1.000	14.843	2.205	16.181	TOHT07..	GP05-060, GP05-18-060-DC
MCTR15.88XU25.4-25	0.625	1.000	15.827	2.205	17.283	TOHT07..	GP05-060, GP05-18-060-DC
MCTR17.45XU25.4A-25	0.687	1.000	17.803	2.205	19.291	TOHT08..	GP05-075, GP05-18-075-DC
MCTR18.24XU25.4-25	0.718	1.000	18.819	2.205	20.354	TOHT09..	GP06-085, GP06-20-085-DC
MCTR18.64XU25.4-25	0.734	1.000	18.819	2.205	20.354	TOHT09..	GP06-085, GP06-20-085-DC
MCTR19.05XU25.4-25	0.750	1.000	19.803	2.205	21.378	TOHT09..	GP06-085, GP06-20-085-DC
MCTR19.94XU31.75-25	0.785	1.250	20.787	2.362	22.441	TOHT09..	GP06-085, GP06-20-085-DC
MCTR20.62XU31.75-25	0.812	1.250	20.795	2.362	22.441	TOHT10..	GP06-085, GP06-20-085-DC
MCTR22.23XU31.75-25	0.875	1.250	22.772	2.362	24.528	TOHT11..	GP06-100, GP06-20-100-DC
MCTR23.80XU31.75-25	0.937	1.250	24.740	2.362	26.614	TOHT11..	GP06-100, GP06-20-100-DC
MCTR25.40XU31.75-25	1.000	1.250	25.736	2.362	27.638	TOHT12..	GP06, GP06-20-120-DC
MCTR26.97XU31.75X-25	1.062	1.250	27.705	2.362	29.724	TOHT12..	GP06, GP06-20-120-DC

Metric	DC	DCONMS	LU	LS	LF	Insert	Guide pad
MCTR12.00XM20-25	12	20	326.8	50	355	LOGT06...	GP04-055, GP04-16-055-DC
MCTR12.50XM20-25	12.5	20	326.8	50	356	LOGT06...	GP04-055, GP04-16-055-DC
MCTR13.00XM25-25	13	25	351.8	56	385	LOGT06...	GP04-055, GP04-16-055-DC
MCTR13.50XM25-25	13.5	25	351.8	56	385	LOGT06...	GP04-055, GP04-16-055-DC
MCTR14.00XM25-25	14	25	377	56	411	TOHT07...	GP05-060, GP05-18-060-DC
MCTR14.50XM25-25	14.5	25	377	56	412	TOHT07...	GP05-060, GP05-18-060-DC
MCTR15.00XM25-25	15	25	402	56	438	TOHT07...	GP05-060, GP05-18-060-DC
MCTR16.00XM25A-25	16	25	427.2	56	464	TOHT08...	GP05-075, GP05-18-075-DC
MCTR16.50XM25A-25	16.5	25	427.2	56	464	TOHT08...	GP05-075, GP05-18-075-DC
MCTR17.00XM25A-25	17	25	452.2	56	490	TOHT08...	GP05-075, GP05-18-075-DC
MCTR17.50XM25A-25	17.5	25	452.2	56	490	TOHT08...	GP05-075, GP05-18-075-DC
MCTR18.00XM25A-25	18	25	477.2	56	517	TOHT08...	GP05-075, GP05-18-075-DC
MCTR18.50XM25-25	18.5	25	478	56	517	TOHT09...	GP06-085, GP06-20-085-DC
MCTR19.00XM25-25	19	25	503	56	543	TOHT09...	GP06-085, GP06-20-085-DC
MCTR19.50XM25-25	19.5	25	503	56	543	TOHT09...	GP06-085, GP06-20-085-DC
MCTR20.00XM32-25	20	32	528	60	570	TOHT09...	GP06-085, GP06-20-085-DC
MCTR21.00XM32-25	21	32	553.2	60	596	TOHT10...	GP06-085, GP06-20-085-DC
MCTR22.00XM32-25	22	32	578.4	60	623	TOHT11...	GP06-100, GP06-20-100-DC
MCTR23.00XM32-25	23	32	603.4	60	649	TOHT11...	GP06-100, GP06-20-100-DC
MCTR24.00XM32-25	24	32	628.4	60	676	TOHT11...	GP06-100, GP06-20-100-DC
MCTR25.00XM32-25	25	32	653.4	60	702	TOHT11...	GP06-100, GP06-20-100-DC
MCTR26.00XM40-25	26	40	678.7	70	729	TOHT12...	GP06, GP06-20-120-DC
MCTR27.00XM40-25	27	40	703.7	70	755	TOHT12...	GP06, GP06-20-120-DC
MCTR28.00XM40-25	28	40	703.7	70	757	TOHT12...	GP06, GP06-20-120-DC

DC	Tool diameter tolerance	Applicable tolerance range of hole diameter
0.472 - 1.102	0 / - 0.003	+ 0.002 / - 0.004

(Unit: Inch)

SPARE PARTS

Designation	Insert		Guide pad	
	Screw	Wrench	Screw	Wrench
MCTR12... - MCTR13.5...	SR10503833L040	T-7F	CSPB-2L043	IP-6F
MCTR14... - MCTR20.00...	SR14-560/S	T-8F	SR34-508	T-7F
MCTR20.62... - ...MCTR21...	SR34-506	T-9F	SR34-508	T-7F
MCTR22... - MCTR25.00...	SR14-571/S	T-10/5	SR34-508	T-7F
MCTR25.4... - MCTR28...	SR14-506	T-15F	SR34-508	T-7F

Recommended clamping torque (lb-ft): CSPB-2L043=0.52, SR34-506=0.66, SR34-508=0.66, SR14-560/S=0.89, SR10503833L040=0.96, SR14-571/S=2.36, SR14-506=3.54

Reference pages: Inserts, Guide pads → **J114 - J117**, Standard cutting conditions → **J118**

DEEPT^{AI} DRILL

MCTRCH L/D=25

Drill body for drilling cross hole applications on CNC lathes and machining centers, L/D = 25, Tool diameters $\phi 0.578"$ - $\phi 0.937"$ and $\phi 14\text{mm}$ - $\phi 28\text{mm}$

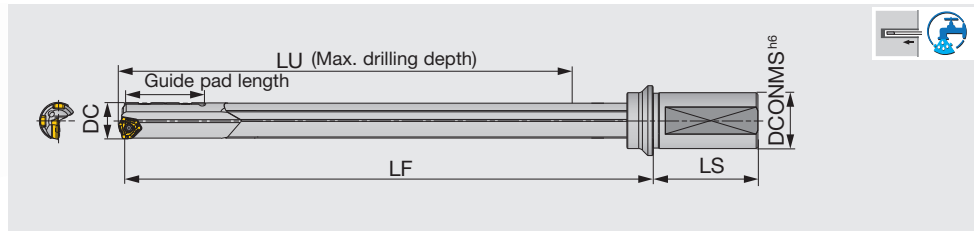

Inch	DC	DCONMS	LU	LS	LF	Insert	Guide pad	Guide pad length
MCTRCH14.68XU25.4-25	0.578	1.000	14.843	2.205	16.220	TOHT07...	GP05-060, GP05-18-060-DC	1.260
MCTRCH15.06XU25.4-25	0.593	1.000	15.827	2.205	17.244	TOHT07...	GP05-060, GP05-18-060-DC	1.260
MCTRCH18.24XU25.4-25	0.718	1.000	18.819	2.205	20.354	TOHT09...	GP06-085, GP06-20-085-DC	1.575
MCTRCH18.64XU25.4-25	0.734	1.000	18.819	2.205	20.354	TOHT09...	GP06-085, GP06-20-085-DC	1.575
MCTRCH23.80XU31.75-25	0.937	1.250	24.740	2.362	26.614	TOHT11...	GP06, GP06-20-120-DC	1.575

Metric	DC	DCONMS	LU	LS	LF	Insert	Guide pad	Guide pad length
MCTRCH14.00XM25-25	14	25	377	56	411	TOHT07...	GP05-060, GP05-18-060-DC	32
MCTRCH15.00XM25-25	15	25	402	56	438	TOHT07...	GP05-060, GP05-18-060-DC	32
MCTRCH16.00XM25A-25	16	25	427.2	56	464	TOHT08...	GP05-075, GP05-18-075-DC	32
MCTRCH18.00XM25A-25	18	25	477.2	56	517	TOHT08...	GP05-075, GP05-18-075-DC	32
MCTRCH19.00XM25-25	19	25	503	56	543	TOHT09...	GP06-085, GP06-20-085-DC	40
MCTRCH20.00XM32-25	20	32	528	60	570	TOHT09...	GP06-085, GP06-20-085-DC	40
MCTRCH23.00XM32-25	23	32	603.4	60	649	TOHT11...	GP06-100, GP06-20-100-DC	40
MCTRCH24.00XM32-25	24	32	628.4	60	676	TOHT11...	GP06-100, GP06-20-100-DC	40
MCTRCH28.00XM40-25	28	40	703.7	70	757	TOHT12...	GP06, GP06-20-120-DC	40

DC	Tool diameter tolerance	Applicable tolerance range of hole diameter
$\phi 0.551$ - $\phi 1.102$	0 / - 0.004	+ 0.002 / - 0.005

(Unit: Inch)

SPARE PARTS

Designation	Insert		Guide pad	
	Screw	Wrench	Screw	Wrench
MCTRCH14... - MCTRCH20...	SR14-560/S	T-8F	SR34-508	T-7F
MCTRCH23... - MCTRCH24...	SR14-571/S	T-10/5	SR34-508	T-7F
MCTRCH28...	SR14-506	T-15F	SR34-508	T-7F

Recommended clamping torque (lb-ft): SR34-508=0.66, SR14-560/S=0.89, SR14-571/S=2.36, SR14-506=3.54

Reference pages: Inserts, Guide pads → **J114 - J117**, Standard cutting conditions → **J118**

Grade
Insert
Toolholder
Ext. Toolholder
Int. Toolholder
Threading
Grooving
Miniature Tool
Cutter
Endmill
Drilling Tool
Tooling System
User's Guide
Index



DEEPT^{AI} DRILL

MCTR-F L/D=8

Drill body for lathes and machining centers, L/D = 8, Tool diameter $\varnothing 33.1$, $\varnothing 39.1$ mm

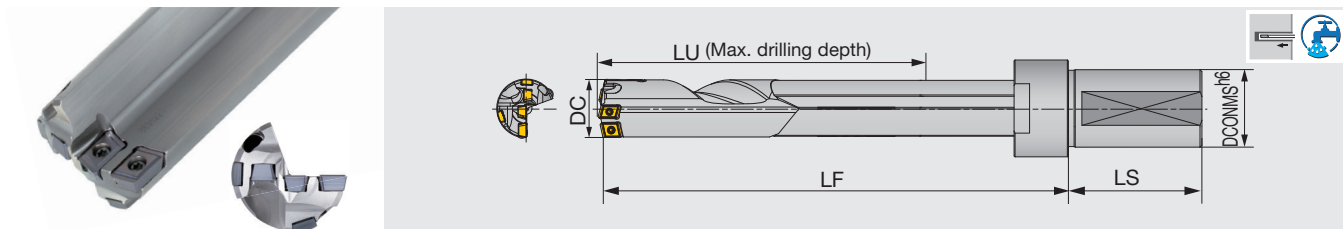

Metric	DC	DCONMS	LU	LS	LF	Insert	Guide pad
MCTR33.10XFM40-8	33.1	40	275	69	350	FBM065**G-C, FBM065**G-I/FBM070**DL-I, FBH075**G-P	GP07, GP07-20-120-DC
MCTR39.10XFM40-8	39.1	40	323	69	407	FBM080**G-C, FBM065**G-I/FBM070**DL-I, FBH090**G-P	GP08, GP08-25-155-DC

DC	Tool diameter tolerance	Applicable tolerance range of hole diameter
33.1, 39.1	0 / - 0.07	+ 0.05 / - 0.1

Max. DC = 40: Available tailor-made tools

(Unit: mm)

SPARE PARTS



Designation	Insert								Guide pad	
	Central		Intermediate		Peripheral		Screw	Wrench		
	Screw	Wrench	Screw	Wrench	Screw	Wrench				
MCTR33.1..., MCTR39.1...	CSTB-2.5	T-8F	CSTB-2.5	T-8F	CSTB-2.5	T-8F	CSTB-3S	T-9F		

Recommended clamping torque (N·m): CSTB2.5=1.3, CSTB-3S=2.3

Note: The drill body surface is blackened for corrosion resistance and may appear uneven.

This, however, will not affect the performance of the drill.

Drill body for lathes and machining centers, L/D = 10, Tool diameter $\phi 1.125'' - \phi 1.500''$ and $\phi 29\text{mm} - \phi 40\text{mm}$

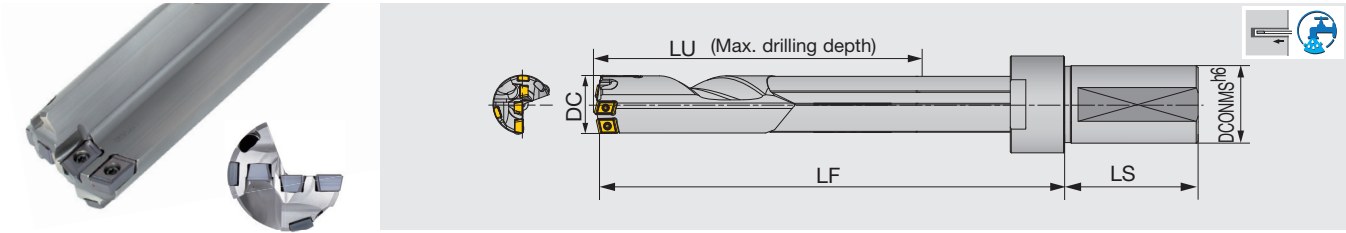

Inch	DC	DCONMS	LU	LS	LF	Insert	Guide pad
MCTR28.58XFU31.75-10	1.125	1.250	11.520	2.717	14.173	FBM065**G-C, FBM055**G-I/FBM060**DL-I, FBH060**G-P	GP06, GP06-20-120-DC
MCTR31.75XFU31.75-10	1.250	1.250	12.717	2.717	15.551	FBM065**G-C, FBM065**G-I/FBM070**DL-I, FBH075**G-P	GP06, GP06-20-120-DC
MCTR34.93XFU31.75-10	1.375	1.250	13.902	2.717	16.850	FBM065**G-C, FBM065**G-I/FBM070**DL-I, FBH075**G-P	GP07, GP07-20-120-DC
MCTR38.10XFU31.75-10	1.500	1.250	15.488	2.717	18.661	FBM080**G-C, FBM065**G-I/FBM070**DL-I, FBH090**G-P	GP08, GP08-25-155-DC

Metric	DC	DCONMS	LU	LS	LF	Insert	Guide pad
MCTR29.00XFM40-10	29	40	292.6	69	360	FBM065**G-C, FBM055**G-I/FBM060**DL-I, FBH060**G-P	GP06, GP06-20-120-DC
MCTR30.00XFM40-10	30	40	312.9	69	383	FBM065**G-C, FBM065**G-I/FBM070**DL-I, FBH075**G-P	GP06, GP06-20-120-DC
MCTR31.00XFM40-10	31	40	312.9	69	383	FBM065**G-C, FBM065**G-I/FBM070**DL-I, FBH075**G-P	GP06, GP06-20-120-DC
MCTR32.00XFM40-10	32	40	323	69	395	FBM065**G-C, FBM065**G-I/FBM070**DL-I, FBH075**G-P	GP06, GP06-20-120-DC
MCTR33.00XFM40-10	33	40	333.1	69	406	FBM065**G-C, FBM065**G-I/FBM070**DL-I, FBH075**G-P	GP06, GP06-20-120-DC
MCTR34.00XFM40-10	34	40	343	69	418	FBM065**G-C, FBM065**G-I/FBM070**DL-I, FBH075**G-P	GP07, GP07-20-120-DC
MCTR35.00XFM40-10	35	40	353.1	69	428	FBM065**G-C, FBM065**G-I/FBM070**DL-I, FBH075**G-P	GP07, GP07-20-120-DC
MCTR36.00XFM40-10	36	40	363.1	69	441	FBM080**G-C, FBM065**G-I/FBM070**DL-I, FBH075**G-P	GP07, GP07-20-120-DC
MCTR37.00XFM40-10	37	40	373	69	451	FBM080**G-C, FBM065**G-I/FBM070**DL-I, FBH075**G-P	GP07, GP07-20-120-DC
MCTR38.00XFM40-10	38	40	383.1	69	464	FBM080**G-C, FBM065**G-I/FBM070**DL-I, FBH075**G-P	GP07, GP07-20-120-DC
MCTR39.00XFM40-10	39	40	393.4	69	474	FBM080**G-C, FBM065**G-I/FBM070**DL-I, FBH090**G-P	GP08, GP08-25-155-DC
MCTR40.00XFM40-10	40	40	403.3	69	487	FBM080**G-C, FBM065**G-I/FBM070**DL-I, FBH090**G-P	GP08, GP08-25-155-DC

DC	Tool diameter tolerance	Applicable tolerance range of hole diameter
1.125 - 1.500	0 / - 0.003	+ 0.002 / - 0.004

Max. DC = 40: Available tailor-made tools (Unit: Inch)

SPARE PARTS



Designation	Insert						Guide pad	
	Central		Intermediate		Peripheral		Screw	Wrench
	Screw	Wrench	Screw	Wrench	Screw	Wrench		
MCTR28.58... - MCTR29...	CSTB-2.5	T-8F	CSTB-2.2	T-7F	CSTB-2.2	T-7F	SR34-508	T-7F
MCTR30... - MCTR33...	CSTB-2.5	T-8F	CSTB-2.5	T-8F	CSTB-2.5	T-8F	SR34-508	T-7F
MCTR34... - MCTR40...	CSTB-2.5	T-8F	CSTB-2.5	T-8F	CSTB-2.5	T-8F	CSTB-3S	T-9F

Recommended clamping torque (lb-ft): SR34-508=0.66, CSTB-2.2=0.74, CSTB-2.5=0.96, CSTB-3S=1.70,

Note: The drill body surface is blackened for corrosion resistance and may appear uneven. This will not affect the performance of the drill.



DEEPT^{AI} DRILL

MCTR-F L/D=15

Drill body for lathes and machining centers, L/D = 15, Tool diameter $\phi 1.125'' - \phi 1.500''$ and $\phi 29\text{mm} - \phi 40\text{mm}$

2-effective Drill
Indexable Drill
Deep Hole Drill

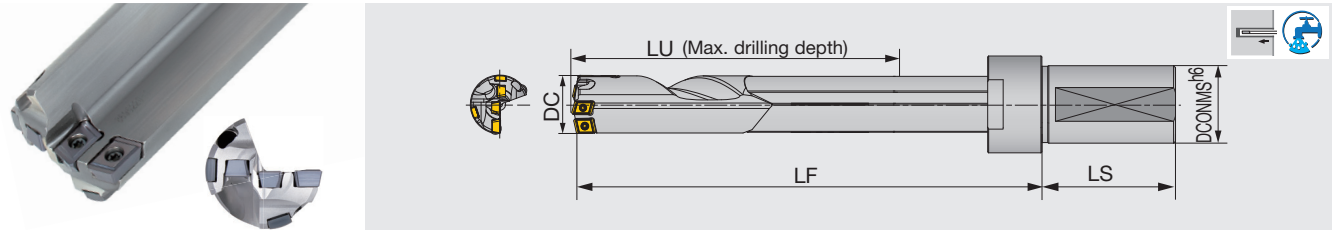

Inch	DC	DCONMS	LU	LS	LF	Insert	Guide pad
MCTR28.58XFU31.75-15	1.125	1.250	17.228	2.717	19.882	FBM065**G-C, FBM055**G-I/FBM060**DL-I, FBH060**G-P	GP06, GP06-20-120-DC
MCTR31.75XFU31.75-15	1.250	1.250	19.016	2.717	21.850	FBM065**G-C, FBM065**G-I/FBM070**DL-I, FBH075**G-P	GP06, GP06-20-120-DC
MCTR34.93XFU31.75-15	1.375	1.250	20.791	2.717	23.740	FBM065**G-C, FBM065**G-I/FBM070**DL-I, FBH075**G-P	GP07, GP07-20-120-DC
MCTR38.10XFU31.75-15	1.500	1.250	23.165	2.717	26.339	FBM080**G-C, FBM065**G-I/FBM070**DL-I, FBH090**G-P	GP08, GP08-25-155-DC

Metric	DC	DCONMS	LU	LS	LF	Insert	Guide pad
MCTR29.00XFM40-15	29	40	437.6	69	505	FBM065**G-C, FBM055**G-I/FBM060**DL-I, FBH060**G-P	GP06, GP06-20-120-DC
MCTR30.00XFM40-15	30	40	467.9	69	538	FBM065**G-C, FBM065**G-I/FBM070**DL-I, FBH075**G-P	GP06, GP06-20-120-DC
MCTR31.00XFM40-15	31	40	467.9	69	538	FBM065**G-C, FBM065**G-I/FBM070**DL-I, FBH075**G-P	GP06, GP06-20-120-DC
MCTR32.00XFM40-15	32	40	483	69	555	FBM065**G-C, FBM065**G-I/FBM070**DL-I, FBH075**G-P	GP06, GP06-20-120-DC
MCTR33.00XFM40-15	33	40	498.1	69	571	FBM065**G-C, FBM065**G-I/FBM070**DL-I, FBH075**G-P	GP06, GP06-20-120-DC
MCTR34.00XFM40-15	34	40	513	69	588	FBM065**G-C, FBM065**G-I/FBM070**DL-I, FBH075**G-P	GP07, GP07-20-120-DC
MCTR35.00XFM40-15	35	40	528.1	69	603	FBM065**G-C, FBM065**G-I/FBM070**DL-I, FBH075**G-P	GP07, GP07-20-120-DC
MCTR36.00XFM40-15	36	40	543.1	69	621	FBM080**G-C, FBM065**G-I/FBM070**DL-I, FBH075**G-P	GP07, GP07-20-120-DC
MCTR37.00XFM40-15	37	40	558	69	636	FBM080**G-C, FBM065**G-I/FBM070**DL-I, FBH075**G-P	GP07, GP07-20-120-DC
MCTR38.00XFM40-15	38	40	573.1	69	654	FBM080**G-C, FBM065**G-I/FBM070**DL-I, FBH075**G-P	GP07, GP07-20-120-DC
MCTR39.00XFM40-15	39	40	588.4	69	669	FBM080**G-C, FBM065**G-I/FBM070**DL-I, FBH090**G-P	GP08, GP08-25-155-DC
MCTR40.00XFM40-15	40	40	603.3	69	687	FBM080**G-C, FBM065**G-I/FBM070**DL-I, FBH090**G-P	GP08, GP08-25-155-DC

DC	Tool diameter tolerance	Applicable tolerance range of hole diameter
1.125 - 1.500	0 / - 0.003	+ 0.002 / - 0.004

Max. DC = 40: Available tailor-made tools (Unit: Inch)

SPARE PARTS



Designation	Insert							
	Central		Intermediate		Peripheral		Guide pad	
	Screw	Wrench	Screw	Wrench	Screw	Wrench	Screw	Wrench
MCTR28.58... - MCTR29...	CSTB-2.5	T-8F	CSTB-2.2	T-7F	CSTB-2.2	T-7F	SR34-508	T-7F
MCTR30... - MCTR33...	CSTB-2.5	T-8F	CSTB-2.5	T-8F	CSTB-2.5	T-8F	SR34-508	T-7F
MCTR34... - MCTR40...	CSTB-2.5	T-8F	CSTB-2.5	T-8F	CSTB-2.5	T-8F	CSTB-3S	T-9F

Recommended clamping torque (lb-ft): SR34-508=0.66, CSTB-2.2=0.74, CSTB-2.5=0.96, CSTB-3S=1.7

Note: The drill body surface is blackened for corrosion resistance and may appear uneven. This will not affect the performance of the drill.

Reference pages: Inserts, Guide pads → **J114 - J117**, Standard cutting conditions → **J118**

DEEPT^{RI} DRILL

MCTR-F L/D=25

Drill body for lathes and machining centers, L/D = 25, Tool diameter $\phi 1.125'' - \phi 1.500''$ and $\phi 30\text{mm}$

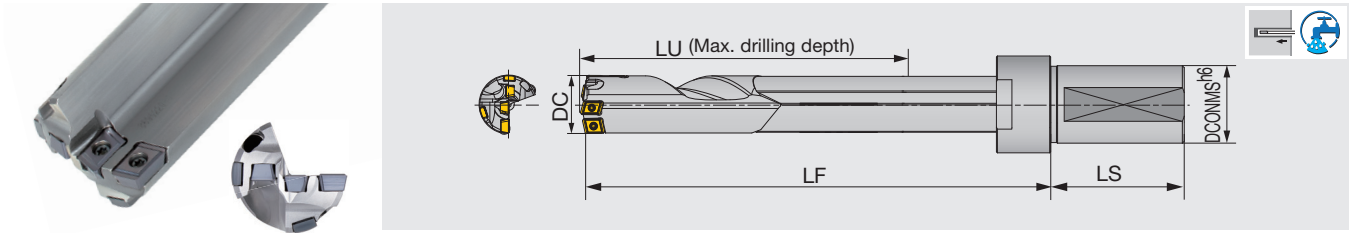

Inch	DC	DCONMS	LU	LS	LF	Insert	Guide pad
MCTR28.58XFU31.75-25	1.125	1.250	28.646	2.717	31.299	FBM065**G-C, FBM055**G-I/FBM060**DL-I, FBH060**G-P	GP06, GP06-20-120-DC
MCTR31.75XFU31.75-25	1.250	1.250	31.614	2.717	34.449	FBM065**G-C, FBM065**G-I/FBM070**DL-I, FBH075**G-P	GP06, GP06-20-120-DC
MCTR34.93XFU31.75-25	1.375	1.250	34.571	2.717	37.520	FBM065**G-C, FBM065**G-I/FBM070**DL-I, FBH075**G-P	GP07, GP07-20-120-DC
MCTR38.10XFU31.75-25	1.500	1.250	38.520	2.717	41.693	FBM080**G-C, FBM065**G-I/FBM070**DL-I, FBH090**G-P	GP08, GP08-25-155-DC

Metric	DC	DCONMS	LU	LS	LF	Insert	Guide pad
MCTR30.00XFM40-25	30	40	777.9	69	848	FBM065**G-C/I, FBH075**G-P	GP06, GP06-20-120-DC

DC	Tool diameter tolerance	Applicable tolerance range of hole diameter
1.125 - 1.500	0 / - 0.003	+ 0.002 / - 0.004

Max. DC = 40: Specials available upon request (Unit: Inch)

SPARE PARTS

Designation	Insert						Guide pad	
	Central		Intermediate		Peripheral		Screw	Wrench
	Screw	Wrench	Screw	Wrench	Screw	Wrench		
MCTR28...	CSTB-2.5	T-8F	CSTB-2.2	T-7F	CSTB-2.2	T-7F	SR34-508	T-7F
MCTR30... - MCTR31...	CSTB-2.5	T-8F	CSTB-2.5	T-8F	CSTB-2.5	T-8F	SR34-508	T-7F
MCTR34... - MCTR38...	CSTB-2.5	T-8F	CSTB-2.5	T-8F	CSTB-2.5	T-8F	CSTB-3S	T-9F

Recommended clamping torque (lb-ft): SR34-508=0.66, CSTB-2.2=0.74, CSTB-2.5=0.96, CSTB-3S=1.7

Note: The drill body surface is blackened for corrosion resistance and may appear uneven. This will not affect the performance of the drill.

Reference pages: Inserts, Guide pads → **J114 - J117**, Standard cutting conditions → **J118**

DEEPT^{ri}DRILL

MCTR Quotation sheet

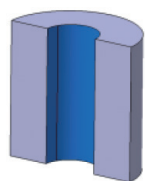
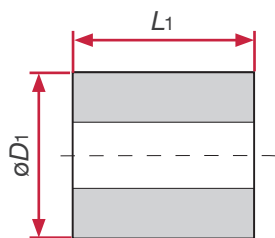

Through

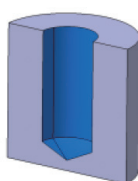

Blind

ϕD_1	
L_1	
Hole tolerance	

Request

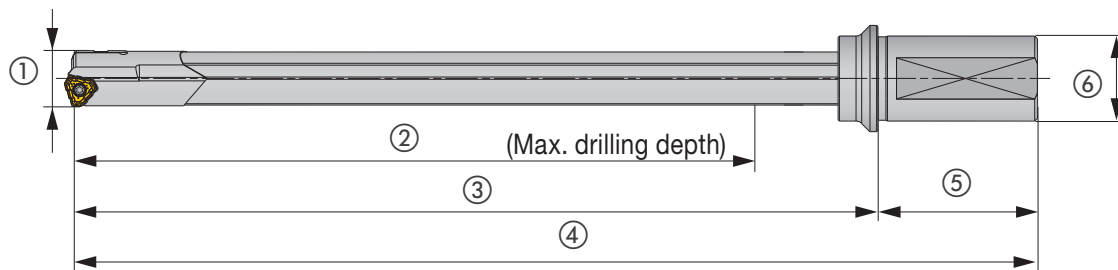

①	
②	
③	

④	
⑤	
⑥	

Description	
Quote QTY	pcs
*MOQ: 1pc	

Technical data

Machine type	<input type="checkbox"/> MCT	<input type="checkbox"/> Lathe
	<input type="checkbox"/> Vertical	<input type="checkbox"/> Horizontal
Machine name		
Power	Kw	
Coolant type	<input type="checkbox"/> Oil	<input type="checkbox"/> Water-soluble

Workpiece

Part	
Material	
Hardness	

Driver

Driver	DCONMS		LS		Driver code	Coverage	
	Inch	Metric	Inch	Metric		Inch	Metric
	0.984	25	2.205	56	M25	$\phi 0.551 - \phi 0.775$	$\phi 14 - \phi 19.69$
	1.260	32	2.362	60	M32	$\phi 0.775 - \phi 1.011$	$\phi 19.7 - \phi 25.69$
	1.575	40	2.756	70	M40	$\phi 1.011 - \phi 1.102$	$\phi 25.7 - \phi 28$
	1.000	25.4	2.205	56	U25.4	$\phi 0.551 - \phi 0.775$	$\phi 14 - \phi 19.69$
	1.250	31.75	2.362	60	U31.75	$\phi 0.775 - \phi 1.011$	$\phi 19.7 - \phi 25.69$
	1.500	38.1	2.756	70	U38.1	$\phi 1.011 - \phi 1.102$	$\phi 25.7 - \phi 28$

- Please check "●" in the list of driver.
- If you need special design, please send us detail information.
- If the drill depth is more than " $\phi D_1 \times 30$ ", you should use 2 types of DeepTriDrill, a short and a long one, because of tool fracture caused by chattering.

DESIGNATION FOR TAILOR MADE TOOLS

For tailor-made drills, use the below guide line to make the designation (Cat. No).

1

MCTR

2

18.50 XM

3

25 - 22

4

1 Series	2 Drill diameter DC (mm)	3 Driver diameter DCONMS (mm)	4 L/D ratio
MCTR	DeepTri-Drill (For machining centers and lathes)	18.50 18.50	
MCTRCH	DeepTri-Drill (For gundrill machines, cross hole specification)	25 25	

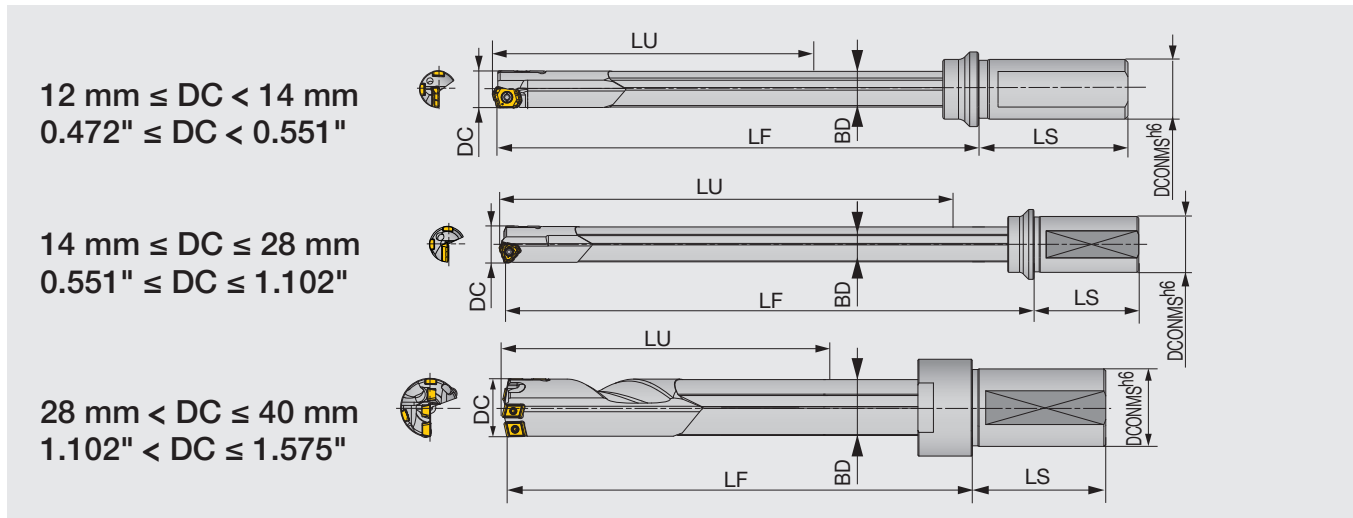

AVAILABLE RANGE OF TAILOR MADE DRILL BODIES

DC	DCONMS	LU	LS	LF	BD	DC	DCONMS	LU	LS	LF	BD
12 - 12.49	20	124.8 - 326.8	50	153 - 225	11.5	24.7 - 25.69	32	211.4 - 653.7	60	260 - 702	24
12.5 - 12.99	20	123.8 - 326.8	50	153 - 226	12	25.7 - 26.69	40	219.7 - 678.7	70	270 - 719	25
13 - 13.49	25	122.8 - 351.8	56	156 - 245	12.5	26.7 - 27.69	40	227.7 - 703.7	70	279 - 745	26
13.5 - 13.99	25	122.8 - 351.8	56	156 - 245	13	27.7 - 28	40	227.7 - 703.7	70	281 - 747	27
14 - 14.49	25	122 - 377	56	156 - 411	13.5	28.01 - 29	40	148.7 - 728.7	69	215 - 795	27
14.5 - 14.99	25	122 - 377	56	157 - 412	14	29.01 - 29.99	40	153.7 - 753.7	69	222 - 822	28
15 - 15.99	25	130 - 402	56	166 - 438	14.5	30 - 31	40	158.7 - 778.7	69	228 - 848	29
16 - 16.79	25	138.2 - 427.2	56	175 - 464	15.5	31.01 - 32	40	163.7 - 803.7	69	235 - 875	30
16.8 - 17.69	25	146.2 - 452.2	56	184 - 490	16.2	32.01 - 33	40	168.7 - 828.7	69	241 - 901	31
17.7 - 18.69	25	154.2 - 478	56	194 - 517	17.2	33.01 - 34	40	173.7 - 853.7	69	248 - 928	32
18.7 - 19.69	25	163 - 503	56	203 - 543	18.2	34.01 - 35	40	178.7 - 878.7	69	253 - 953	32
19.7 - 20.69	32	171 - 528.2	60	213 - 570	19	35.01 - 36	40	183.7 - 903.7	69	261 - 981	34
20.7 - 21.69	32	179.2 - 553.2	60	222 - 596	20	36.01 - 37	40	188.7 - 928.7	69	266 - 1006	34
21.7 - 22.69	32	187.2 - 578.4	60	232 - 623	21	37.01 - 38	40	193.7 - 953.7	69	274 - 1034	36
22.7 - 23.69	32	195.4 - 603.4	60	241 - 649	22	38.01 - 39	40	198.7 - 978.7	69	279 - 1059	36
23.7 - 24.69	32	203.4 - 628.4	60	251 - 676	23	39.01 - 40	40	203.7 - 1003.7	69	287 - 1087	38

(unit: mm)

Grade
Insert
Toolholder
Ext. Toolholder
Int. Toolholder
Threading
Grooving
Miniature Tool
Milling Cutter
Endmill
Drilling Tool
User's Guide Tooling System
Index



DEEPT^{RI} DRILL TRLG

Drill body for gundrill machines, Tool diameters $\phi 0.5"$ - $\phi 0.531"$ and $\phi 12\text{mm}$ - $\phi 28\text{mm}$

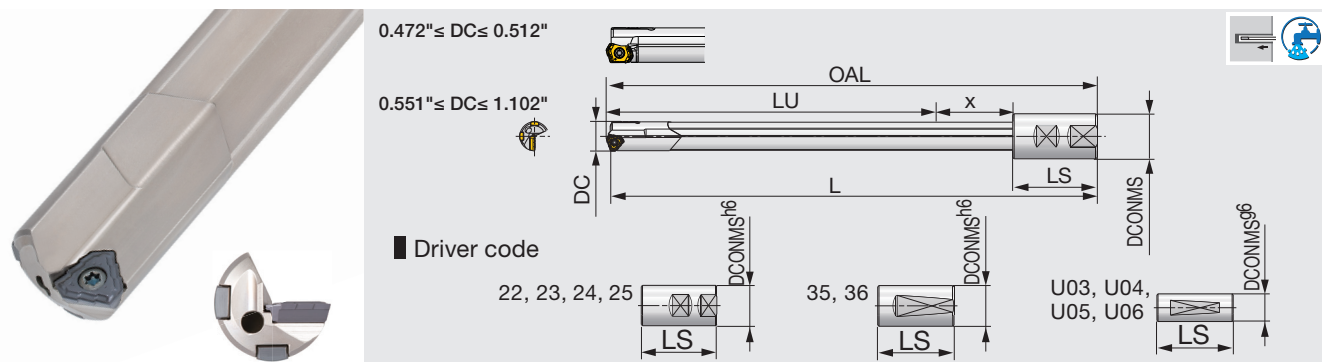

Inch	DC	L	DCONMS	LU	OAL	LS	x	Driver code	Insert	Guide pad
TRLG12.70X1219-U04	0.500	47.992	1.000	44.559	48.063	2.756	0.748	U04	LOGT06...	GP04-055, GP04-16-055-DC
TRLG12.70X1524-U04	0.500	60.000	1.000	56.567	60.071	2.756	0.748	U04	LOGT06...	GP04-055, GP04-16-055-DC
TRLG13.49X1219-U04	0.531	47.992	1.000	44.520	48.063	2.756	0.787	U04	LOGT06...	GP04-055, GP04-16-055-DC
TRLG13.49X1527-U04	0.531	60.118	1.000	56.646	60.189	2.756	0.787	U04	LOGT06...	GP04-055, GP04-16-055-DC

Metric	DC	L	DCONMS	LU	OAL	LS	x	Driver code	Insert	Guide pad
TRLG12.00X800-U03	12	800	19.05	713.8	801.8	70	18	U03	LOGT06...	GP04-055, GP04-16-055-DC
TRLG12.00X800-22	12	800	20	733.8	801.8	50	18	22	LOGT06...	GP04-055, GP04-16-055-DC
TRLG12.00X1000-U03	12	1000	19.05	913.8	1001.8	70	18	U03	LOGT06...	GP04-055, GP04-16-055-DC
TRLG12.00X1000-22	12	1000	20	933.8	1001.8	50	18	22	LOGT06...	GP04-055, GP04-16-055-DC
TRLG12.00X1650-U03	12	1650	19.05	1563.8	1651.8	70	18	U03	LOGT06...	GP04-055, GP04-16-055-DC
TRLG12.00X1650-22	12	1650	20	1583.8	1651.8	50	18	22	LOGT06...	GP04-055, GP04-16-055-DC
TRLG13.00X800-U04	13	800	25.4	711.8	801.8	70	20	U04	LOGT06...	GP04-055, GP04-16-055-DC
TRLG13.00X800-23	13	800	25	725.8	801.8	56	20	23	LOGT06...	GP04-055, GP04-16-055-DC
TRLG13.00X1000-U04	13	1000	25.4	911.8	1001.8	70	20	U04	LOGT06...	GP04-055, GP04-16-055-DC
TRLG13.00X1000-23	13	1000	25	925.8	1001.8	56	20	23	LOGT06...	GP04-055, GP04-16-055-DC
TRLG13.00X1650-U04	13	1650	25.4	1561.8	1651.8	70	20	U04	LOGT06...	GP04-055, GP04-16-055-DC
TRLG13.00X1650-23	13	1650	25	1575.8	1651.8	56	20	23	LOGT06...	GP04-055, GP04-16-055-DC
TRLG14.00X800-23	14	800	25	725	802	56	21	23	TOHT07...	GP05-060, GP05-18-060-DC
TRLG14.00X800-U04	14	800	25.4	711	802	70	21	U04	TOHT07...	GP05-060, GP05-18-060-DC
TRLG14.00X1000-23	14	1000	25	925	1002	56	21	23	TOHT07...	GP05-060, GP05-18-060-DC
TRLG14.00X1000-U04	14	1000	25.4	911	1002	70	21	U04	TOHT07...	GP05-060, GP05-18-060-DC
TRLG14.00X1650-23	14	1650	25	1575	1652	56	21	23	TOHT07...	GP05-060, GP05-18-060-DC
TRLG14.00X1650-U04	14	1650	25.4	1561	1652	70	21	U04	TOHT07...	GP05-060, GP05-18-060-DC
TRLG14.50X800-23	14.5	800	25	724	802	56	22	23	TOHT07...	GP05-060, GP05-18-060-DC
TRLG14.50X800-U04	14.5	800	25.4	710	802	70	22	U04	TOHT07...	GP05-060, GP05-18-060-DC
TRLG14.50X1000-23	14.5	1000	25	924	1002	56	22	23	TOHT07...	GP05-060, GP05-18-060-DC
TRLG14.50X1000-U04	14.5	1000	25.4	910	1002	70	22	U04	TOHT07...	GP05-060, GP05-18-060-DC
TRLG14.50X1650-23A	14.5	1650	25	1574	1652	56	22	23	TOHT07...	GP05-060, GP05-18-060-DC
TRLG14.50X1650-U04	14.5	1650	25.4	1560	1652	70	22	U04	TOHT07...	GP05-060, GP05-18-060-DC
TRLG15.00X800-23	15	800	25	723	802	56	23	23	TOHT07...	GP05-060, GP05-18-060-DC
TRLG15.00X800-U04	15	800	25.4	709	802	70	23	U04	TOHT07...	GP05-060, GP05-18-060-DC
TRLG15.00X1000-23	15	1000	25	923	1002	56	23	23	TOHT07...	GP05-060, GP05-18-060-DC
TRLG15.00X1000-U04	15	1000	25.4	909	1002	70	23	U04	TOHT07...	GP05-060, GP05-18-060-DC
TRLG15.00X1650-23	15	1650	25	1573	1652	56	23	23	TOHT07...	GP05-060, GP05-18-060-DC
TRLG15.00X1650-U04	15	1650	25.4	1559	1652	70	23	U04	TOHT07...	GP05-060, GP05-18-060-DC
TRLG16.00X800-23A	16	800	25	722.2	802.2	56	24	23	TOHT08...	GP05-075, GP05-18-075-DC
TRLG16.00X800-U04A	16	800	25.4	708.2	802.2	70	24	U04	TOHT08...	GP05-075, GP05-18-075-DC
TRLG16.00X1000-23A	16	1000	25	922.2	1002.2	56	24	23	TOHT08...	GP05-075, GP05-18-075-DC
TRLG16.00X1000-U04A	16	1000	25.4	908.2	1002.2	70	24	U04	TOHT08...	GP05-075, GP05-18-075-DC
TRLG16.00X1500-23A	16	1500	25	1422.2	1502.2	56	24	23	TOHT08...	GP05-075, GP05-18-075-DC
TRLG16.00X1500-U04A	16	1500	25.4	1408.2	1502.2	70	24	U04	TOHT08...	GP05-075, GP05-18-075-DC
TRLG17.00X800-23A	17	800	25	721.2	802.2	56	25	23	TOHT08...	GP05-075, GP05-18-075-DC

Metric	DC	L	DCONMS	LU	OAL	LS	x	Driver code	Insert	Guide pad
TRLG17.00X800-U04A	17	800	25.4	707.2	802.2	70	25	U04	TOHT08...	GP05-075, GP05-18-075-DC
TRLG17.00X1000-23A	17	1000	25	921.2	1002.2	56	25	23	TOHT08...	GP05-075, GP05-18-075-DC
TRLG17.00X1000-U04A	17	1000	25.4	907.2	1002.2	70	25	U04	TOHT08...	GP05-075, GP05-18-075-DC
TRLG18.00X800-23A	18	800	25	719.2	802.2	56	27	23	TOHT08...	GP05-075, GP05-18-075-DC
TRLG18.00X800-U04A	18	800	25.4	705.2	802.2	70	27	U04	TOHT08...	GP05-075, GP05-18-075-DC
TRLG18.00X1000-23A	18	1000	25	919.2	1002.2	56	27	23	TOHT08...	GP05-075, GP05-18-075-DC
TRLG18.00X1000-U04A	18	1000	25.4	905.2	1002.2	70	27	U04	TOHT08...	GP05-075, GP05-18-075-DC
TRLG18.00X1500-23A	18	1500	25	1419.2	1502.2	56	27	23	TOHT08...	GP05-075, GP05-18-075-DC
TRLG18.00X1500-U04A	18	1500	25.4	1405.2	1502.2	70	27	U04	TOHT08...	GP05-075, GP05-18-075-DC
TRLG18.50X1500-23	18.5	1500	25	1420	1503	56	27	23	TOHT09...	GP06-085, GP06-20-085-DC
TRLG18.50X1500-U04	18.5	1500	25.4	1406	1503	70	27	U04	TOHT09...	GP06-085, GP06-20-085-DC
TRLG19.00X800-23	19	800	25	719	803	56	28	23	TOHT09...	GP06-085, GP06-20-085-DC
TRLG19.00X800-U04	19	800	25.4	705	803	70	28	U04	TOHT09...	GP06-085, GP06-20-085-DC
TRLG19.00X1000-23	19	1000	25	919	1003	56	28	23	TOHT09...	GP06-085, GP06-20-085-DC
TRLG19.00X1000-U04	19	1000	25.4	905	1003	70	28	U04	TOHT09...	GP06-085, GP06-20-085-DC
TRLG20.00X800-24	20	800	32	713	803	60	30	24	TOHT09...	GP06-085, GP06-20-085-DC
TRLG20.00X800-U05	20	800	31.75	703	803	70	30	U05	TOHT09...	GP06-085, GP06-20-085-DC
TRLG20.00X1000-24	20	1000	32	913	1003	60	30	24	TOHT09...	GP06-085, GP06-20-085-DC
TRLG20.00X1000-U05	20	1000	31.75	903	1003	70	30	U05	TOHT09...	GP06-085, GP06-20-085-DC
TRLG21.00X1000-24	21	1000	32	912.2	1003.2	60	31	24	TOHT10...	GP06-085, GP06-20-085-DC
TRLG21.00X1000-U05	21	1000	31.75	902.2	1003.2	70	31	U05	TOHT10...	GP06-085, GP06-20-085-DC
TRLG22.00X1000-24	22	1000	32	910.4	1003.4	60	33	24	TOHT11...	GP06-100, GP06-20-100-DC
TRLG22.00X1000-U05	22	1000	31.75	900.4	1003.4	70	33	U05	TOHT11...	GP06-100, GP06-20-100-DC
TRLG22.00X1500-24	22	1500	32	1410.4	1503.4	60	33	24	TOHT11...	GP06-100, GP06-20-100-DC
TRLG22.00X1500-U05	22	1500	31.75	1400.4	1503.4	70	33	U05	TOHT11...	GP06-100, GP06-20-100-DC
TRLG23.00X1000-24	23	1000	32	909.4	1003.4	60	34	24	TOHT11...	GP06-100, GP06-20-100-DC
TRLG23.00X1000-U05	23	1000	31.75	899.4	1003.4	70	34	U05	TOHT11...	GP06-100, GP06-20-100-DC
TRLG23.00X1500-24	23	1500	32	1409.4	1503.4	60	34	24	TOHT11...	GP06-100, GP06-20-100-DC
TRLG23.00X1500-U05	23	1500	31.75	1399.4	1503.4	70	34	U05	TOHT11...	GP06-100, GP06-20-100-DC
TRLG24.00X1000-24	24	1000	32	907.4	1003.4	60	36	24	TOHT11...	GP06-100, GP06-20-100-DC
TRLG24.00X1000-U05	24	1000	31.75	897.4	1003.4	70	36	U05	TOHT11...	GP06-100, GP06-20-100-DC
TRLG24.00X1500-24	24	1500	32	1407.4	1503.4	60	36	24	TOHT11...	GP06-100, GP06-20-100-DC
TRLG24.00X1500-U05	24	1500	31.75	1397.4	1503.4	70	36	U05	TOHT11...	GP06-100, GP06-20-100-DC
TRLG25.00X1000-24	25	1000	32	906.4	1003.4	60	37	24	TOHT11...	GP06-100, GP06-20-100-DC
TRLG25.00X1000-U05	25	1000	31.75	896.4	1003.4	70	37	U05	TOHT11...	GP06-100, GP06-20-100-DC
TRLG26.00X1000-25	26	1000	40	894.7	1003.7	70	39	25	TOHT12...	GP06, GP06-20-120-DC
TRLG26.00X1000-U06	26	1000	38.1	894.7	1003.7	70	39	U06	TOHT12...	GP06, GP06-20-120-DC
TRLG27.00X1000-25	27	1000	40	893.7	1003.7	70	40	25	TOHT12...	GP06, GP06-20-120-DC
TRLG27.00X1000-U06	27	1000	38.1	893.7	1003.7	70	40	U06	TOHT12...	GP06, GP06-20-120-DC
TRLG28.00X1000-25	28	1000	40	891.7	1003.7	70	42	25	TOHT12...	GP06, GP06-20-120-DC
TRLG28.00X1000-U06	28	1000	38.1	891.7	1003.7	70	42	U06	TOHT12...	GP06, GP06-20-120-DC

DC	Tool diameter tolerance	Applicable tolerance range of hole diameter
0.472 - 1.102	0 / - 0.003	+ 0.002 / - 0.004

(Unit: Inch)

SPARE PARTS

Designation	Insert		Guide pad	
	Screw	Wrench	Screw	Wrench
TRLG12... - TRLG13...	SR10503833L040	T-7F	CSPB-2L043	IP-6F
TRLG14... - TRLG20...	SR14-560/S	T-8F	SR34-508	T-7F
TRLG21...	SR34-506	T-9F	SR34-508	T-7F
TRLG22... - TRLG25...	SR14-571/S	T-10/5	SR34-508	T-7F
TRLG26... - TRLG28...	SR14-506	T-15F	SR34-508	T-7F

Recommended clamping torque (lb-ft): CSPB-2L043=0.52, SR34-508=0.66, SR34-506=0.66, SR14-560/S=0.89, SR10503833L040=0.96, SR14-571/S=2.36, SR14-506=3.54

Reference pages: Inserts, Guide pads → **J114 - J117**, Standard cutting conditions → **J118**

DEEPT^{RI} DRILL TRLGCH

Drill body for drilling cross hole applications on gun drilling machines, Tool diameters $\varnothing 0.578''$ - $\varnothing 0.937''$ and $\varnothing 15\text{mm}$ - $\varnothing 24\text{mm}$

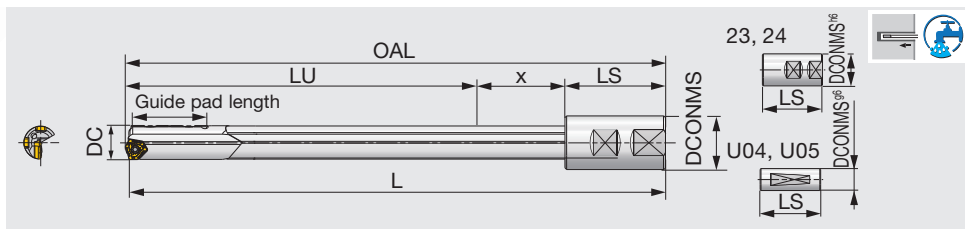
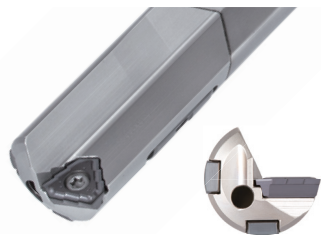

Inch	DC	L	DCONMS	LU	OAL	LS	X	Driver code	Insert	Guide pad	Guide pad length
TRLGCH14.68X1830-U05	0.578	72.047	1.250	68.504	72.126	2.756	0.866	U05	TOHT07...	GP05-060, GP05-18-060-DC	32
TRLGCH15.06X1830-U05	0.593	72.047	1.250	68.465	72.126	2.756	0.906	U05	TOHT07...	GP05-060, GP05-18-060-DC	32
TRLGCH18.24X1830-U05	0.718	72.047	1.250	68.346	72.165	2.756	1.063	U05	TOHT09...	GP06-085, GP06-20-085-DC	40
TRLGCH18.64X1830-U05	0.734	72.047	1.250	68.346	72.165	2.756	1.063	U05	TOHT09...	GP06-085, GP06-20-085-DC	40
TRLGCH23.42X1830-U05	0.922	72.047	1.250	68.087	72.181	2.756	1.339	U05	TOHT11...	GP06-100, GP06-20-100-DC	40
TRLGCH23.80X1830-U05	0.937	72.047	1.250	68.008	72.181	2.756	1.417	U05	TOHT11...	GP06-100, GP06-20-100-DC	40

Metric	DC	L	DCONMS	LU	OAL	LS	X	Driver code	Insert	Guide pad	Guide pad length
TRLGCH15.00X1650-U04	15	1650	25.4	1559	1652	70	23	U04	TOHT07...	GP05-060, GP05-18-060-DC	32
TRLGCH15.00X1650-23	15	1650	25	1573	1652	56	23	23	TOHT07...	GP05-060, GP05-18-060-DC	32
TRLGCH18.00X1650-U04A	18	1650	25.4	1555.2	1652.2	70	27	U04	TOHT08...	GP05-075, GP05-18-075-DC	32
TRLGCH18.00X1650-23A	18	1650	25	1569.2	1652.2	56	27	23	TOHT08...	GP05-075, GP05-18-075-DC	40
TRLGCH23.00X1650-U05	23	1650	31.75	1549.4	1653.4	70	34	U05	TOHT11...	GP06-100, GP06-20-100-DC	40
TRLGCH23.00X1650-24	23	1650	32	1559.4	1653.4	60	34	24	TOHT11...	GP06-100, GP06-20-100-DC	40
TRLGCH24.00X1650-U05	24	1650	31.75	1547.4	1653.4	70	36	U05	TOHT11...	GP06-100, GP06-20-100-DC	40
TRLGCH24.00X1650-24	24	1650	32	1557.4	1653.4	60	36	24	TOHT11...	GP06-100, GP06-20-100-DC	40

DC	Tool diameter tolerance	Applicable tolerance range of hole diameter
$\varnothing 0.578$ - $\varnothing 0.945$	0 / - 0.004	+ 0.002 / - 0.005

(Unit: Inch)

SPARE PARTS



Designation	Insert		Guide pad	
	Screw	Wrench	Screw	Wrench
TRLGCH14... - TRLGCH18...	SR14-560/S	T-8F	SR34-508	T-7F
TRLGCH23... - TRLGCH24...	SR14-571/S	T-10/5	SR34-508	T-7F

Recommended clamping torque (lb-ft): SR34-508=0.66, R14-560/S=0.89, SR14-571/S=2.36

Reference pages: Inserts, Guide pads → **J114 - J117**, Standard cutting conditions → **J118**

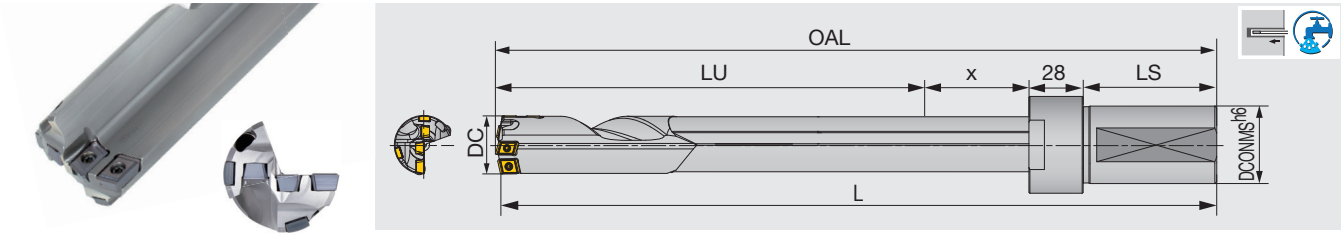

Inch	DC	L	DCONMS	LU	OAL	LS	x	Driver code	Insert	Guide pad
TRLG29.36X1828-FU31.75	1.156	71.969	1.250	66.520	72.071	27.165	1.732	FU31.75	FBM065**G-C, FBM055**G-I/FBM060**DL-I, FBH060**G-P	GP06, GP06-20-120-DC
Metric	DC	L	DCONMS	LU	OAL	LS	x	Driver code	Insert	Guide pad
TRLG30.00X1000-FM40	30	1000	40	860.9	1002.9	69	45	FM40	FBM065**G-C, FBM065**G-I/FBM070**DL-I, FBH075**G-P	GP06, GP06-20-120-DC
TRLG30.00X1650-FM40	30	1650	40	1510.9	1652.9	69	45	FM40	FBM065**G-C, FBM065**G-I/FBM070**DL-I, FBH075**G-P	GP06, GP06-20-120-DC
TRLG30.00X1650-FU38.1	30	1650	38.1	1510.9	1652.9	69	45	FU38.1	FBM065**G-C, FBM065**G-I/FBM070**DL-I, FBH075**G-P	GP06, GP06-20-120-DC

DC	Tool diameter tolerance	Applicable tolerance range of hole diameter
1.181	0 / - 0.003	+ 0.002 / - 0.004

Max. DC = 40: Available tailor-made tools

(Unit: Inch)

SPARE PARTS



Designation	Insert						Guide pad	
	Central		Intermediate		Peripheral		Screw	Wrench
	Screw	Wrench	Screw	Wrench	Screw	Wrench	Screw	Wrench
TRLG30...	CSTB-2.5	T-8F	CSTB-2.5	T-8F	CSTB-2.5	T-8F	SR34-508	T-7F

Recommended clamping torque (lb-ft): SR34-508=0.66, CSTB-2.5=0.96

Note: The drill body surface is blackened for corrosion resistance and may appear uneven. This will not affect the performance of the drill.

DESIGNATION FOR TAILOR MADE TOOLS

For tailor-made drills, use the below guide line to make the designation (Cat. No).

1 **TRLG** **2** **18.50** **3** **X 900** **4** **- 23**

1 Series	
TRLG	DeepTri-Drill (for gundrill machines)
TRLGCH	DeepTri-Drill (For gundrill machines, cross hole specification)

2 Drill diameter DC (mm)	
18.50	18.50

3 Overall length: L (mm)	
900	900

4 Driver code	
23	23

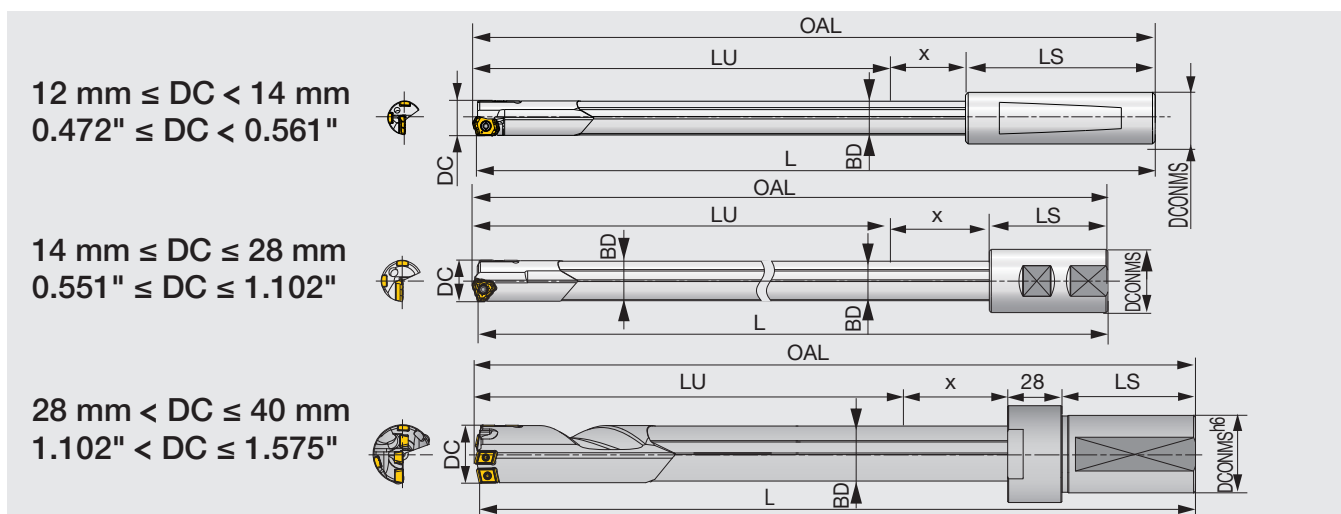

AVAILABLE RANGE OF TAILOR MADE DRILL BODIES

DC	L	x	BD	DC	L	x	BD
12 - 12.49	400 - 2400	18	11.5	24.7 - 25.69	400 - 2400	37	24
12.5 - 12.99	400 - 2400	19	12	25.7 - 26.69	400 - 2400	39	25
13 - 13.49	400 - 2400	20	12.5	26.7 - 27.69	400 - 2400	40	26
13.5 - 13.99	400 - 2400	20	13	27.7 - 28	400 - 2400	42	27
14 - 14.49	400 - 2400	21	13.5	28.01 - 29	400 - 2400	42	27
14.5 - 14.99	400 - 2400	22	14	29.01 - 29.99	400 - 2400	44	28
15 - 15.99	400 - 2400	23	14.5	30 - 31	400 - 2400	45	29
16 - 16.79	400 - 2400	24	15.5	31.01 - 32	400 - 2400	47	30
16.8 - 17.69	400 - 2400	25	16.2	32.01 - 33	400 - 2400	48	31
17.7 - 18.69	400 - 2400	27	17.2	33.01 - 34	400 - 2400	50	32
18.7 - 19.69	400 - 2400	28	18.2	34.01 - 35	400 - 2400	50	32
19.7 - 20.69	400 - 2400	30	19	35.01 - 36	400 - 2400	53	34
20.7 - 21.69	400 - 2400	31	20	36.01 - 37	400 - 2400	53	34
21.7 - 22.69	400 - 2400	33	21	37.01 - 38	400 - 2400	56	36
22.7 - 23.69	400 - 2400	34	22	38.01 - 39	400 - 2400	56	36
23.7 - 24.69	400 - 2400	36	23	39.01 - 40	400 - 2400	59	38

Please provide the driver shape necessary for your request

(Unit: mm)

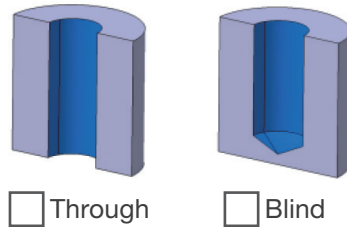
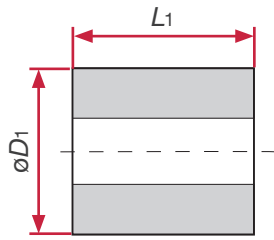

ϕD_1	
L_1	
Hole tolerance	

Request

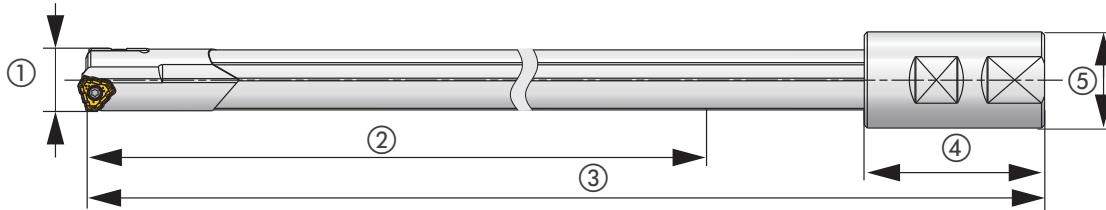

①	
②	
③	

④	
⑤	
⑥	

Description	
Quote QTY	pcs
*MOQ: 1pc	

Technical data

Machine type	<input type="checkbox"/> GM* <input type="checkbox"/> Lathe
	<input type="checkbox"/> Vertical <input type="checkbox"/> Horizontal
Machine name	
Power	Kw
Coolant type	<input type="checkbox"/> Oil <input type="checkbox"/> Water-soluble

*Gundrill machine

Workpiece

Part	
Material	
Hardness	

Driver

Driver	●	DCONMS		LS		Driver code	Coverage	
		Inch	Metric	Inch	Metric		Inch	Metric
		0.984	25	2.205	56	23	$\phi 0.551 - \phi 0.775$	$\phi 14 - \phi 19.69$
		1.260	32	2.362	60	24	$\phi 0.551 - \phi 1.011$	$\phi 14 - \phi 25.69$
		1.260	32	2.756	70	25	$\phi 0.551 - \phi 1.130$	$\phi 14 - \phi 28.69$
		1.969	50	2.756	80	26	$\phi 0.551 - \phi 1.130$	$\phi 14 - \phi 28.69$
		0.984	25	2.205	56	35	$\phi 0.551 - \phi 0.775$	$\phi 14 - \phi 19.69$
		1.260	32	2.362	60	36	$\phi 0.551 - \phi 1.011$	$\phi 14 - \phi 25.69$
		1.000	25.4	2.756	70	U04	$\phi 0.551 - \phi 0.775$	$\phi 14 - \phi 19.69$
		1.250	31.75	2.756	70	U05	$\phi 0.551 - \phi 1.011$	$\phi 14 - \phi 25.69$
		1.500	38.1	2.756	70	U06	$\phi 0.551 - \phi 1.102$	$\phi 14 - \phi 28$

- Please check "●" in the list of driver.
- If you need special design, please send us detail information.
- In case of using machines other than a Gundrill machine, if the drill depth is more than " $\phi D_1 \times 30$ ", you should use 2 types of DeepTriDrill, a short and a long one, because of tool fracture caused by chattering.



INSERT

LOGT-NDJ

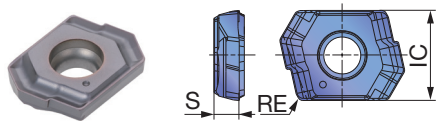

P	Steel	★								
M	Stainless	★								
K	Cast iron	★								
N	Non-ferrous	★								
S	Superalloys	★								
H	Hard materials	★								

★ : First choice
☆ : Second choice

Designation	DCN (in)	DCX (in)	Coated								S (in)	RE (in)	
			AH725										
LOGT060204R-NDJ	0.472	0.551	●									0.079	0.016

● : Line up
Package quantity = 10 pcs.

TOHT-NDL (07..., 08...)

TOHT-NDL (09... - 12...)

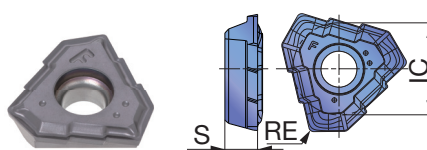
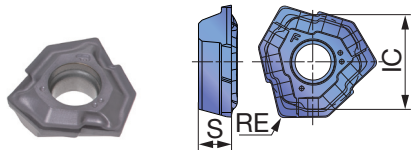

P	Steel	★								
M	Stainless	★								
K	Cast iron	★								
N	Non-ferrous	★								
S	Superalloys	★								
H	Hard materials	★								

★ : First choice
☆ : Second choice

Designation	DCN (in)	DCX (in)	Coated								IC (in)	S (in)	RE (in)	
			AH725											
TOHT070304R-NDL	0.551	0.630	●									0.303	0.091	0.016
TOHT080305R-NDL	0.630	0.709	●									0.337	0.110	0.020
TOHT090305R-NDL	0.709	0.787	●									0.328	0.118	0.020
TOHT100305R-NDL	0.788	0.866	●									0.363	0.130	0.020
TOHT110405R-NDL	0.866	0.984	●									0.409	0.150	0.020
TOHT120405R-NDL	0.985	1.102	●									0.456	0.169	0.020

● : Line up
Package quantity = 10 pcs.

INSERT

TOHT-NDJ (070..., 080...)

TOHT-NDJ (090... - 120...)

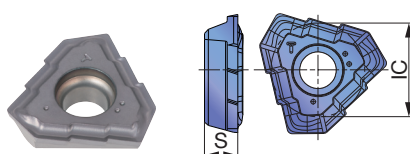
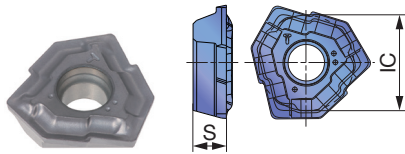

P	Steel	★																		
M	Stainless	★																		
K	Cast iron	★																		
N	Non-ferrous	★																		
S	Superalloys	★																		
H	Hard materials	★																		

★ : First choice
☆ : Second choice

Designation	DCN (in)	DCX (in)	Coated										IC (in)	S (in)						
			AH725																	
TOHT070304R-NDJ	0.551	0.630	●															0.303	0.091	
TOHT080305R-NDJ	0.630	0.709	●																0.337	0.110
TOHT090305R-NDJ	0.709	0.787	●																0.328	0.118
TOHT100305R-NDJ	0.788	0.866	●																0.363	0.130
TOHT110405R-NDJ	0.866	0.984	●																0.409	0.150
TOHT120405R-NDJ	0.985	1.102	●																0.456	0.169

● : Line up
Package quantity = 10 pcs.

■ Identifications for NDJ and NDJ geometries ■ Recommended feed rates

Chipbreaker	NDL	NDJ
Cutting edge strength	Strong	Very strong
ID on insert		

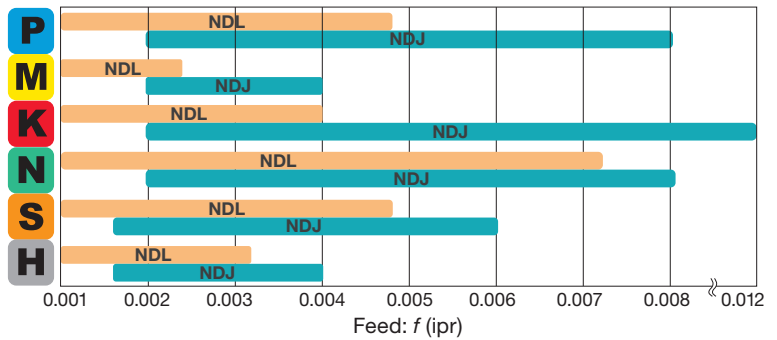

FBM-C (For central)

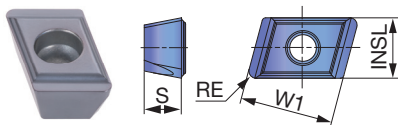

P	Steel	★	☆																	
M	Stainless	★	☆																	
K	Cast iron	★	☆																	
N	Non-ferrous	★	☆																	
S	Superalloys	★	☆																	
H	Hard materials	★	☆																	

★ : First choice
☆ : Second choice

Designation	INSL (in)	W1 (in)	Coated										S (in)	DCN (in)	DCX (in)	RE (in)							
			AH725	AH8015																			
FBM070408L-G-C	0.256	0.394	●	●															0.157	1.103	1.378	0.031	
FBM080408L-G-C	0.315	0.394	●	●																0.157	1.378	1.575	0.031

● : Line up
Package quantity = 10 pcs.

FBM-I (For intermediate)

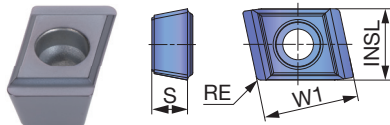

G type chipbreaker	DL type chipbreaker
FBM060304R-G-I	FBM060304R-DL-I
FBM070404R-G-I	FBM070404R-DL-I

The designation of insert with G type and DL type is different, even in the same shape.

Please refer to the table above to check the insert designation. Both inserts can be mounted on the drill body.

	P Steel	M Stainless	K Cast iron	N Non-ferrous	S Superalloys	H Hard materials
★	★	★	★	★	★	★
☆	☆	☆	☆	☆	☆	☆

★ : First choice
☆ : Second choice

Designation	INSL (in)	W1 (in)	Coated								S (in)	DCN (in)	DCX (in)	RE (in)	
			AH725	AH8015											
FBM060304R-G-I	0.217	0.315	●	●								0.118	1.103	1.181	0.016
FBM060304R-DL-I	0.217	0.315	●									0.118	1.103	1.181	0.016
FBM070404R-G-I	0.256	0.394	●	●								0.157	1.181	1.575	0.016
FBM070404R-DL-I	0.256	0.394	●									0.157	1.181	1.575	0.016

● : Line up

Package quantity = 10 pcs.

Recommended feed rates

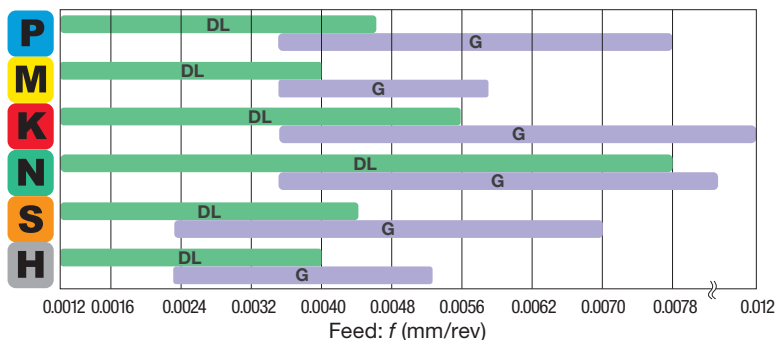

For cross hole drilling, please use the new DL type chipbreaker because the feed needs to be reduced.

FBH-P (For peripheral)

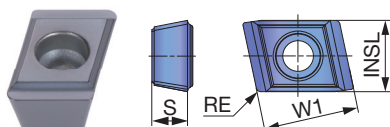

	P Steel	M Stainless	K Cast iron	N Non-ferrous	S Superalloys	H Hard materials
★	★	★	★	★	★	★
☆	☆	☆	☆	☆	☆	☆

★ : First choice
☆ : Second choice

Designation	INSL (in)	W1 (in)	Coated				S (in)	DCN (in)	DCX (in)	RE (in)
			AH725	UC3120	AH8015	AH3135				
FBH060304R-G-P	0.236	0.315	●	●			0.118	1.103	1.181	0.016
FBH060308R-G-P	0.236	0.315	●		●	●	0.118	1.103	1.181	0.031
FBH080404R-G-P	0.295	0.394	●	●			0.157	1.181	1.496	0.016
FBH080408R-G-P	0.295	0.394	●		●	●	0.157	1.181	1.496	0.031
FBH090404R-G-P	0.354	0.394	●	●			0.157	1.496	1.575	0.016
FBH090408R-G-P	0.354	0.394	●		●	●	0.157	1.496	1.575	0.031

● : Line up

Package quantity = 10 pcs.

GUIDE PAD

GP04, 05, 06, 07, 08

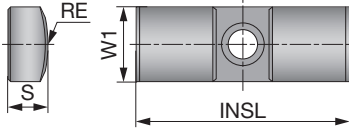

	P	M	K	N	S	H
Steel	☆	☆	★	☆		
Stainless	☆	☆	★	☆		
Cast iron	☆	☆	★	☆		
Non-ferrous	☆	☆	★	☆		
Superalloys	☆	☆	★	☆		
Hard materials	☆	☆	★	☆		

★ : First choice
☆ : Second choice

Designation	DCN (in)	DCX (in)	Coated				W1 (in)	INSL (in)	S (in)	RE (in)	Chamfer
			F1122	F2122	FH3125	FH3135					
GP04-055	0.472	0.5508	● ▲				0.157	0.63	0.079	0.217	Single
GP04-16-055-DC	0.472	0.5508			● ●		0.157	0.63	0.079	0.217	Double
GP05-060	0.5512	0.6295	● ▲				0.197	0.709	0.098	0.236	Single
GP05-18-060-DC	0.5512	0.6295			● ●		0.197	0.709	0.098	0.236	Double
GP05-075	0.6299	0.7087	● ▲				0.197	0.709	0.098	0.295	Single
GP05-18-075-DC	0.6299	0.7087			● ●		0.197	0.709	0.098	0.295	Double
GP06-085	0.7091	0.8268	● ▲				0.236	0.787	0.118	0.335	Single
GP06-20-085-DC	0.7091	0.8268			● ●		0.236	0.787	0.118	0.335	Double
GP06-100	0.8271	0.9843	● ▲				0.236	0.787	0.118	0.394	Single
GP06-20-100-DC	0.8271	0.9843			● ●		0.236	0.787	0.118	0.394	Double
GP06	0.9846	1.2992	● ▲				0.236	0.787	0.118	0.472	Single
GP06-20-120-DC	0.9846	1.2992			● ●		0.236	0.787	0.118	0.472	Double
GP07	1.2996	1.496	● ▲				0.276	0.787	0.138	0.472	Single
GP07-20-120-DC	1.2996	1.496			● ●		0.276	0.787	0.138	0.472	Double
GP08	1.4965	1.575	● ▲				0.315	0.984	0.177	0.610	Single
GP08-25-155-DC	1.4965	1.575			● ●		0.315	0.984	0.177	0.610	Double

● : Line up
▲ : To be discontinued
Package quantity = 5 pcs.

REPLACING GUIDE PADS

Guide pads are subject to wear, like inserts

- The guide pad has two sides.
- Each guide pad can be used on two sides. When the first corner wears out to 70% of the width, reverse the guide pad to use the second side.
- Replace with a new guide pad when the second side wears out.

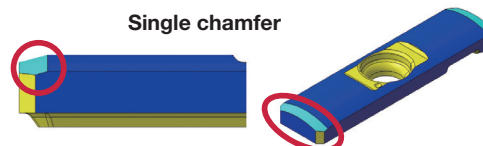
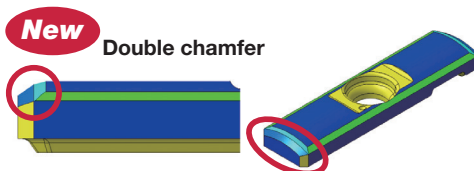
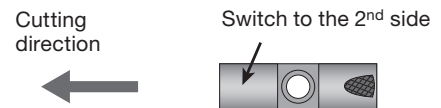
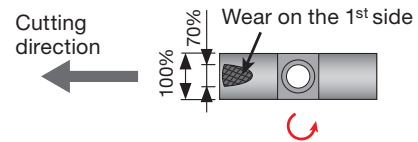
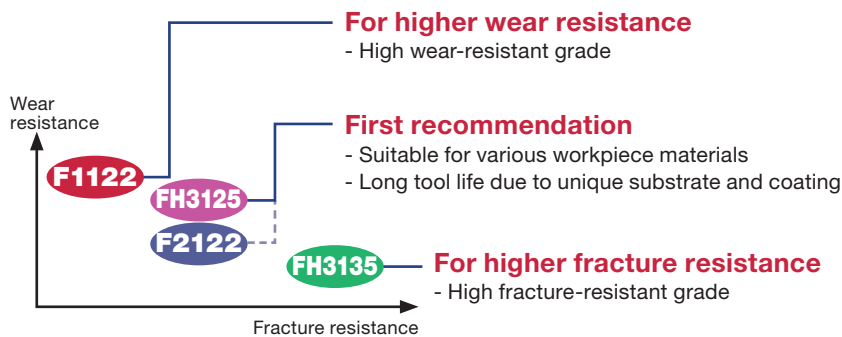

SHIM

SHIMSET-GP04

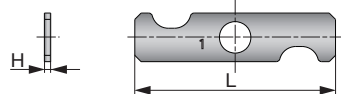

SHIMSET-GP05

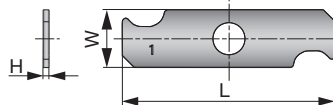

SHIMSET-GP06

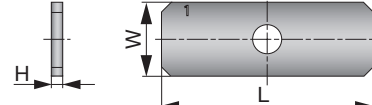

Designation	DC	W	L	H
SHIMSET-GP04	12 - 13.99	4	16	2
SHIMSET-GP05	14 - 15.99	5	18	2.5
SHIMSET-GP06	16 - 18	5	18	2.5

(Unit: mm)

Shim thickness: 0.01 / 0.02 / 0.03 / 0.04 / 0.05 mm
 Shim sheets are sold as set.
 Package quantity = 5 pcs. (1 pc per each thickness)

Shim sheet combinations by adjusting diameter

Adjustment diameter	Shim thickness in guide pad of diameter side.	Shim thickness in guide pad of bearing side.	Required number of shim set
+0.0004	0.0004	-	1
+0.0008	0.0008	0.0004	1
+0.0012	0.0012	0.0004 + 0.0008	1
+0.0016	0.0016	0.0004 + 0.0012	1
+0.0020	0.0020	0.0008 + 0.0012	1
+0.0024	0.0004 + 0.0020	0.0008 + 0.0016	1
+0.0028	0.0008 + 0.0020	0.0012 + 0.0016	1
+0.0031	0.0012 + 0.0020	0.0016 + 0.0016	2
+0.0035	0.0016 + 0.0020	0.0016 + 0.0020	2
+0.0039	0.0020 + 0.0020	0.0016 + 0.0016 + 0.0008	2

(Unit: in)

Guide pad of diameter side

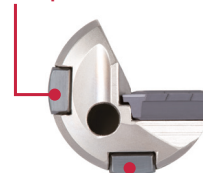

Guide pad of bearing side

STANDARD CUTTING CONDITIONS

ISO	Workpiece material	Priority	Chip-breaker	Cutting speed Vc (sfm)	f (ipr)			
					ø0.472 - ø0.551	ø0.551 - ø0.709	ø0.709 - ø1.102	ø1.103 - ø1.575
P	Low carbon steel (C < 0.3) 70,1025, etc.	For low feed machines	NDL	164 - 328	-	0.0012 - 0.004	0.0012 - 0.004	-
		First choice	NDJ/G	262 - 459	0.0020 - 0.0039	0.0020 - 0.004	0.0020 - 0.004	0.004 - 0.008
	Carbon steel (C > 0.3) 1045c,1055, etc.	For low feed machines	NDL	164 - 328	-	0.0012 - 0.004	0.0012 - 0.005	-
		First choice	NDJ/G	262 - 459	0.0020 - 0.0063	0.0020 - 0.006	0.0020 - 0.008	0.004 - 0.008
M	Low alloy steel (C < 0.3) 5120, etc.	For low feed machines	NDL	164 - 328	-	0.0012 - 0.004	0.0012 - 0.004	-
		First choice	NDJ/G	262 - 459	0.0020 - 0.0039	0.0020 - 0.004	0.0020 - 0.004	0.004 - 0.008
	Alloy steel (C > 0.3) 4140, etc.	For low feed machines	NDL	164 - 328	-	0.0012 - 0.004	0.0012 - 0.005	-
		First choice	NDJ/G	262 - 394	0.0020 - 0.0063	0.0020 - 0.006	0.0020 - 0.008	0.004 - 0.008
K	Stainless steel (Austenitic) 304,316, etc.	For low feed machines	NDL	164 - 328	-	0.0012 - 0.002	0.0012 - 0.002	-
		First choice	NDJ/G	197 - 328	0.0020 - 0.0039	0.0020 - 0.004	0.0020 - 0.004	0.004 - 0.006
	Stainless steel (Martensitic, Ferritic) 430,416, etc.	For low feed machines	NDL	164 - 328	-	0.0012 - 0.002	0.0012 - 0.002	-
		First choice	NDJ/G	197 - 328	0.0020 - 0.0039	0.0020 - 0.004	0.0020 - 0.004	0.004 - 0.006
S	Stainless steel (Precipitation hardening) S17400, etc.	For low feed machines	NDL	164 - 328	-	0.0012 - 0.002	0.0012 - 0.002	-
		First choice	NDJ/G	197 - 328	0.0020 - 0.0039	0.0020 - 0.004	0.0020 - 0.004	0.004 - 0.006
	Gray cast iron No.250B, etc.	For low feed machines	NDL	164 - 328	-	0.0012 - 0.006	0.0020 - 0.007	-
		First choice	NDJ/G	262 - 459	0.0020 - 0.0098	0.0020 - 0.010	0.0020 - 0.012	0.004 - 0.012
H	Ductile cast iron 700, etc.	For low feed machines	NDL	164 - 328	-	0.0012 - 0.006	0.0020 - 0.007	-
		First choice	NDJ/G	262 - 459	0.0020 - 0.0098	0.0020 - 0.010	0.0020 - 0.012	0.004 - 0.012
	Aluminum alloys	For low feed machines	NDL	262 - 525	-	0.0012 - 0.006	0.0012 - 0.006	-
		First choice	NDJ/G	328 - 656	0.0020 - 0.0079	0.0020 - 0.008	0.0020 - 0.008	0.004 - 0.010
N	Heat-resistant alloys Inconel 718, etc.	For low feed machines	NDL	65.6 - 164	-	0.0012 - 0.002	0.0012 - 0.003	-
		First choice	NDJ/G	65.6 - 164	0.0016 - 0.0031	0.0016 - 0.003	0.0016 - 0.004	0.002 - 0.005
	Titanium alloys Ti-6Al-4V, etc.	For low feed machines	NDL	98.4 - 197	-	0.0012 - 0.004	0.0012 - 0.005	-
		First choice	NDJ/G	98.4 - 197	0.0020 - 0.0051	0.0020 - 0.005	0.0020 - 0.006	0.004 - 0.007
H	Hardened steel ≥ 40HRC	For low feed machines	NDL	131 - 328	-	0.0012 - 0.003	0.0012 - 0.003	-
		First choice	NDJ/G	164 - 328	0.0016 - 0.0031	0.0016 - 0.003	0.0016 - 0.004	0.002 - 0.005

APPLICATION RANGE

Feed f (ipr)	0.001 - 0.002	0.001 - 0.05	0.004 - 0.012
Application	<p>OK Cross hole drilling</p>	<p>OK Inclined exit</p> <p>0.630" or less (for standard drill)</p>	<p>OK Boring</p>

Note 1) When drilling cross holes or exiting the inclined surface, make sure the guide-pads are suitable.
 Note 2) A pilot hole is needed prior to a boring operation. $ap \geq 0.040"$ is recommended for boring operations.

SHAPES OF THE HOLE BOTTOM

DC	Insert	Maximum difference PL
0.472 - 0.551	LOGT06	0.071
0.551 - 0.630	TOHT07	0.079
0.630 - 0.709	TOHT08	0.087
0.709 - 0.787	TOHT09	0.118
0.788 - 0.866	TOHT10	0.126
0.866 - 0.984	TOHT11	0.134
0.985 - 1.102	TOHT12	0.146

(Unit: Inch)

LOGT06...

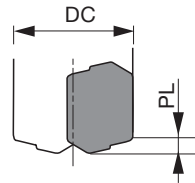

TOHT07..., 08...

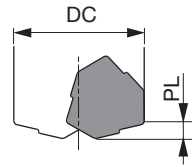

TOHT09... - TOHT12...

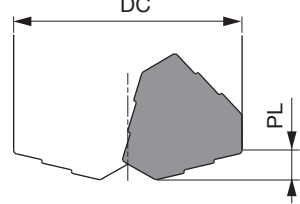

DC	Central	Insert Intermediate	Peripheral	Maximum difference PL
1.103 - 1.142	FBM070408L-G-C	FBM060304R-G-I	FBH060304R-G-P	0.102
1.142 - 1.181	FBM070408L-G-C	FBM060304R-G-I	FBH060304R-G-P	0.102
1.181 - 1.220	FBM070408L-G-C	FBM070404R-G-I	FBH080404R-G-P	0.114
1.221 - 1.260	FBM070408L-G-C	FBM070404R-G-I	FBH080404R-G-P	0.118
1.260 - 1.299	FBM070408L-G-C	FBM070404R-G-I	FBH080404R-G-P	0.122
1.300 - 1.339	FBM070408L-G-C	FBM070404R-G-I	FBH080404R-G-P	0.118
1.339 - 1.378	FBM070408L-G-C	FBM070404R-G-I	FBH080404R-G-P	0.122
1.378 - 1.417	FBM080408L-G-C	FBM070404R-G-I	FBH080404R-G-P	0.122
1.418 - 1.457	FBM080408L-G-C	FBM070404R-G-I	FBH080404R-G-P	0.118
1.457 - 1.496	FBM080408L-G-C	FBM070404R-G-I	FBH080404R-G-P	0.122
1.496 - 1.535	FBM080408L-G-C	FBM070404R-G-I	FBH090404R-G-P	0.134
1.536 - 1.575	FBM080408L-G-C	FBM070404R-G-I	FBH090404R-G-P	0.13

(Unit: Inch)

FBM...

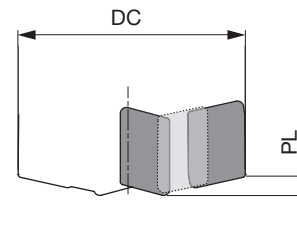

Grade
Insert
Ext. Toolholder
Int. Toolholder
Threading
Grooving
Miniature Tool
Milling Cutter
Endmill
Drilling Tool
Tooling System
User's Guide
Index





REQUIRED SPINDLE POWER AND COOLANT PRESSURE

Net power

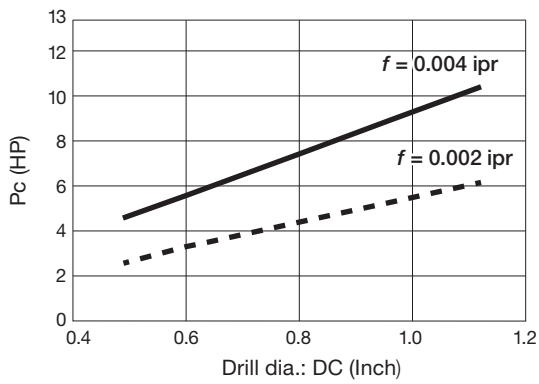

Torque

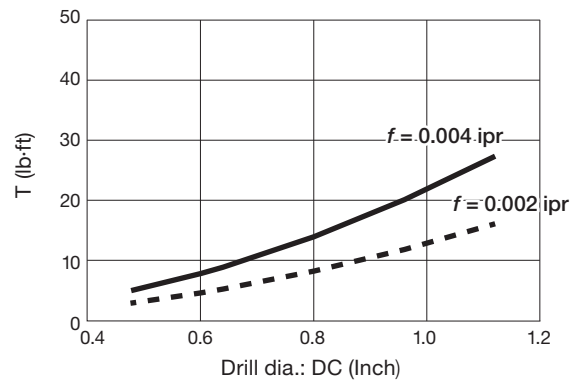

Net power

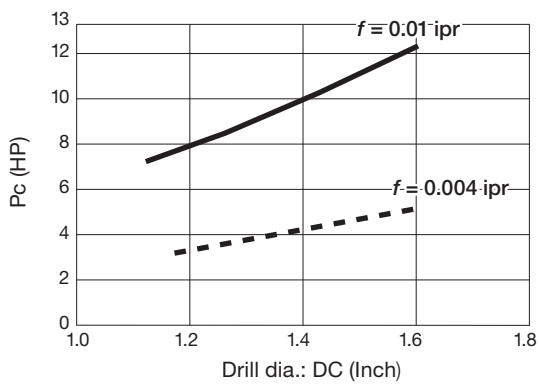

Torque

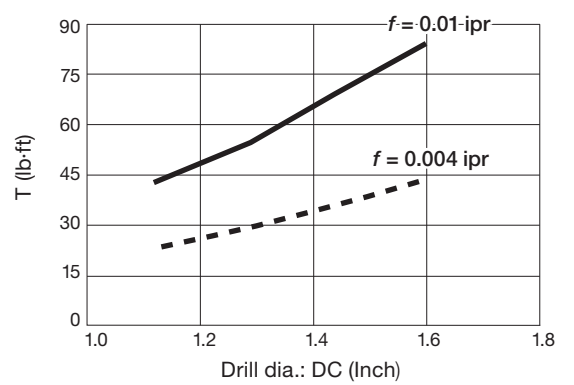

Coolant pressure

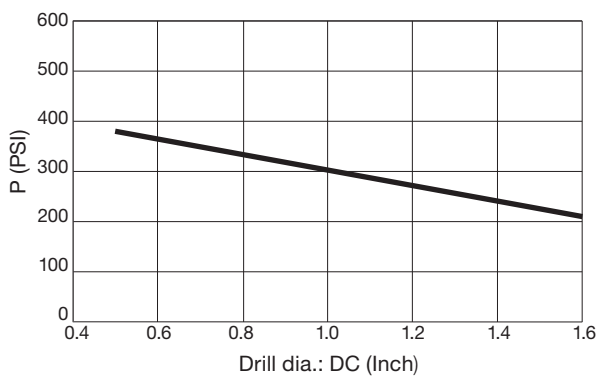

Coolant flow rate

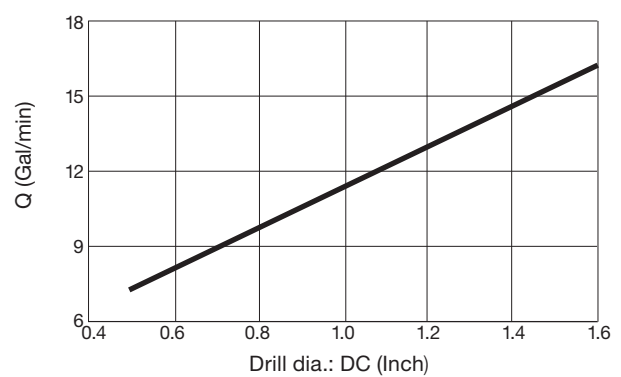

PROPER DEEPTRI-DRILL MODEL FOR SUITABLE CROSS HOLE DISTANCE.

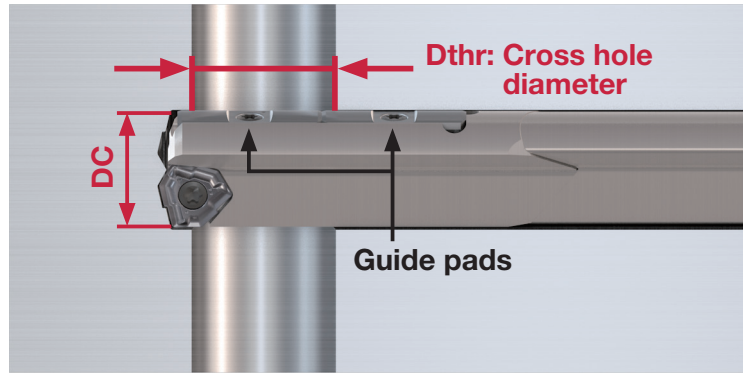
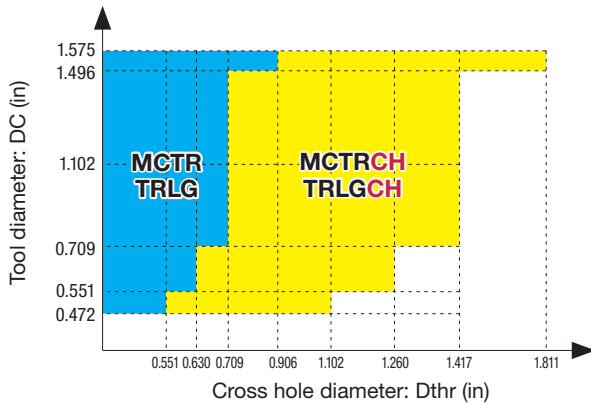

CAUTIONS FOR CROSS HOLE DRILLING

- Decrease the feed rate when the drill head comes in contact with a cross hole. ($f = 0.001 - 0.002$ ipr)
- **Retract the gundrill with a slow rotation. ($n = 4$ rpm, $V_f = 12$ ipm)**
- **When the gundrill is rapidly pulled out without rotating, the insert and/or guide pads may come in contact with burrs on the cross holes on the way back, resulting in damages**

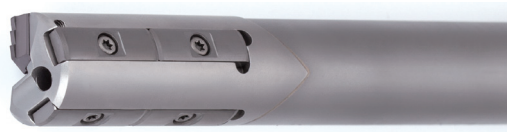

A tailor-made tool for a cross hole distance over 0.630"

DRILLING PROCEDURE ON MACHINING CENTERS AND LATHES

Proceed as instructed below in order to maximize the tool performance safely.

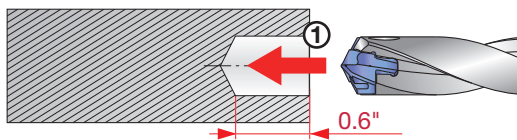

① Drill the guide hole

Hole diameter tolerance: $+0.0004'' - +0.004''$
Hole depth: $H = 0.6''$

Please use DrillMeister or TDX + EZ sleeve to make a guide hole

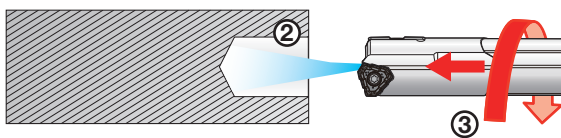

② Start coolant

③ Slowly insert DeepTriDrill into the guide hole

No. of revolution: $n = 50 - 100$ rpm
Feed speed: $V_f = 4 - 12$ ipm

Caution: Do not rotate the drill at machining speed outside the hole

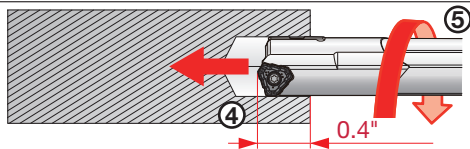

④ Stop the drill at 0.4" depth

⑤ Start rotating at machining speed

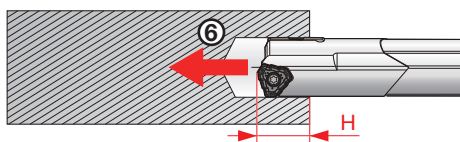

⑥ Start feed

At the entrance ($H = 0.4'' - 0.6''$)
→ Feed: $f = 80\%$ of programmed feed
Hole depth: $H \geq 0.6''$ → Feed: $f = 100\%$

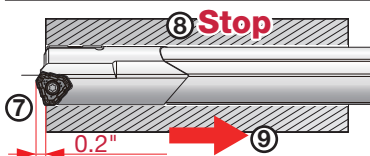

⑦ For through hole

Continue drilling until the drill head passes through the workpiece by 0.2"

⑧ Stop the rotation and coolant

⑨ Return the drill (Head back to the starting position)

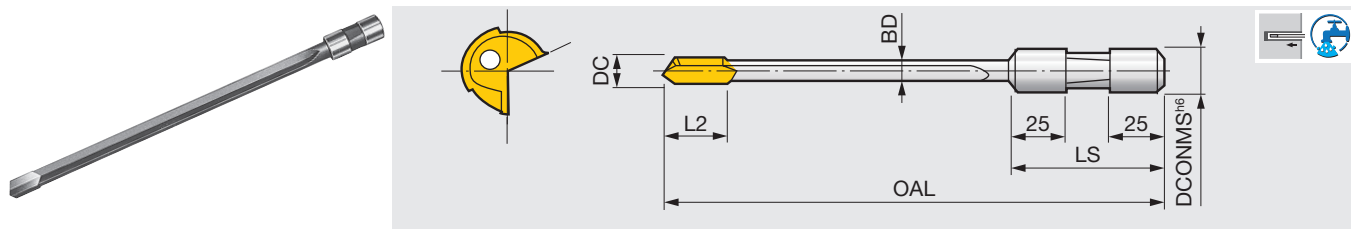

Metric	DC	DCONMS	L2	OAL
SLJ0300L0400NA	3	12.7	15	400
SLJ0300L0600NA	3	12.7	15	600
SLJ0500L0600NA	5	12.7	25	600
SLJ0550L0600NA	5.5	19.05	25	600
SLJ0600L0600NA	6	19.05	25	600
SLJ0700L0600NA	7	19.05	25	600
SLJ0800L0600NA	8	19.05	25	600
SLJ1000L0600NA	10	19.05	30	600
SLJ0500L1000NA	5	12.7	25	1000
SLJ0600L1000NA	6	19.05	25	1000
SLJ0700L1000NA	7	19.05	25	1000
SLJ0800L1000NA	8	19.05	25	1000
SLJ1000L1000NA	10	19.05	30	1000
SLJ0600L1250NA	6	19.05	25	1250
SLJ0610L1250NA	6.1	19.05	25	1250
SLJ0620L1250NA	6.2	19.05	25	1250
SLJ0700L1250NA	7	19.05	25	1250
SLJ0800L1250NA	8	19.05	25	1250
SLJ0810L1250NA	8.1	19.05	25	1250
SLJ0820L1250NA	8.2	19.05	25	1250
SLJ1000L1250NA	10	19.05	30	1250
SLJ1010L1250NA	10.1	19.05	30	1250
SLJ1020L1250NA	10.2	19.05	30	1250
SLJ1200L1250NA	12	19.05	30	1250
SLJ1210L1250NA	12.1	19.05	30	1250
SLJ1220L1250NA	12.2	19.05	30	1250
SLJ0600L1650NA	6	19.05	25	1650
SLJ0610L1650NA	6.1	19.05	25	1650
SLJ0620L1650NA	6.2	19.05	25	1650
SLJ0700L1650NA	7	19.05	25	1650
SLJ0800L1650NA	8	19.05	25	1650
SLJ0810L1650NA	8.1	19.05	25	1650
SLJ0820L1650NA	8.2	19.05	25	1650
SLJ1000L1650NA	10	19.05	30	1650
SLJ1010L1650NA	10.1	19.05	30	1650
SLJ1020L1650NA	10.2	19.05	30	1650
SLJ1200L1650NA	12	19.05	30	1650
SLJ1210L1650NA	12.1	19.05	30	1650
SLJ1220L1650NA	12.2	19.05	30	1650

TUBE DIAMETER

DC	BD	DC	BD	DC	BD
3 - 3.19	2.9	5.2 - 5.49	5	8.7 - 9.19	8.5
3.2 - 3.39	3.1	5.5 - 5.79	5.3	9.2 - 9.69	9
3.4 - 3.59	3.3	5.8 - 5.99	5.6	9.7 - 10.39	9.5
3.6 - 3.89	3.5	6 - 6.19	5.8	10.4 - 10.89	10
3.9 - 4.09	3.7	6.2 - 6.59	5.9	10.9 - 11.39	10.6
4.1 - 4.29	3.9	6.6 - 7.09	6.4	11.4 - 11.99	11.1
4.3 - 4.49	4.1	7.1 - 7.59	6.9	12 - 12.2	11.7
4.5 - 4.89	4.3	7.6 - 8.09	7.4		
4.9 - 5.19	4.7	8.1 - 8.69	7.9		

STANDARD CUTTING CONDITIONS

ISO	Workpiece material	Heat treatment	Hardness		Cutting speed Vc (sfm)	feed f (ipr)	
			HB	HRC			
P	Free-cutting carbon steel		160 - 190	(5) - (11)	427	Refer to Fig. 1	
	C10C ~ C15 S10C ~ S15C	Cold drawn					
	S30C ~ S50C C30 ~ C50	Cold drawn	200 - 230	(12) - 20	328		
	S35C ~ S50C C30 ~ C50	Hardened and tempered	250 - 300	25 - 32	262		
	Carbon steels		110 ~ 120		427		
	S10C ~ S35C C10 ~ C30	Annealed	120 ~ 185	~ (9)	394		
	S10C ~ S50C C10 ~ C50	Annealed	170 ~ 200	(5) ~ (13)	328		
	S20C ~ S30C C20 ~ C30	Hardened and tempered	210 ~ 250	(16) ~ 24	295		
	S30C ~ S55C C30 ~ C55	Hardened and tempered	260 ~ 310	26 ~ 33	230		
	S50C ~ C50 ~	Hardened and tempered	320 ~ 375	34 ~ 40	164		
	S50C ~ C55 ~	Hardened and tempered	380 ~ 440	41 ~ 47	131		
	Alloy steels	Annealed or Hardened and tempered	150 ~ 230	~ (20)	295		Refer to Fig. 2
			240 ~ 310	23 ~ 33	230		Refer to Fig. 2
			315 ~ 370	34 ~ 40	164		Refer to Fig. 3
380 ~ 440			40 ~ 47	131			
Cast steels	Hardened and tempered	140 ~ 180	~ (8)	328	Refer to Fig. 2		
		190 ~ 240	(11) ~ 22	295			
Tool steels	Annealed	150 ~ 200	~ (13)	230	Refer to Fig. 3		
		210 ~ 300	(16) ~ 32	164			
M	Stainless steels Ferritic SUS405, 430 X6Cr17	Annealed	150 ~ 200	~ (13)	230	Refer to Fig. 3	
	Austenitic SUS304, 305 X5CrNi18-9	Annealed	160 ~ 220	~ (18)	164		
	Martensitic SUS403, 410 X12Cr13	Annealed Hardened and tempered	160 ~ 220 300 ~ 350	~ (18) 32 ~ 38	230 164		
K	Gray cast iron		110 ~ 180		295	Refer to Fig. 4	
			190 ~ 220		262		
			220 ~ 260		230		
	Ductile cast iron		120 ~ 170		262	Refer to Fig. 5	
			180 ~ 240		213		
			240 ~ 280		180		
			260 ~ 320		131		
	Malleable cast irons		110 ~ 180		295		
		190 ~ 220		262			
N	Cast aluminum alloys Aluminum die cast alloys	Annealed	5000load 40 ~ 100		591	Refer to Fig. 4	
	Copper alloys	Annealed	120 ~ 160 160 ~ 205		< 492	Refer to Fig. 4 Refer to Fig. 5	
H	Bearing steels		150 ~ 210		230	Refer to Fig. 3	
	Heat-resistant alloys				66		
	High speed steels		210 ~ 285	(16) ~ 30	164		

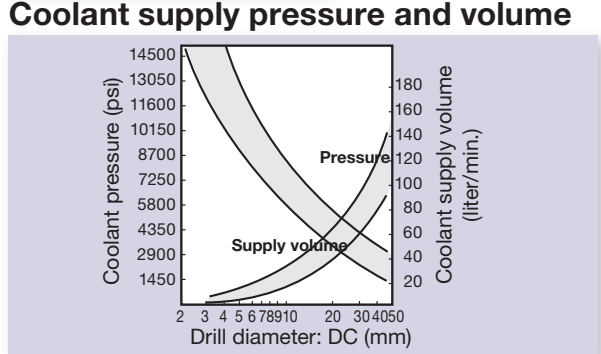
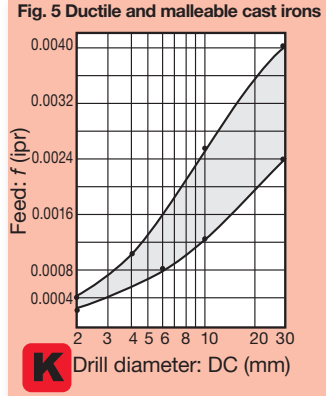
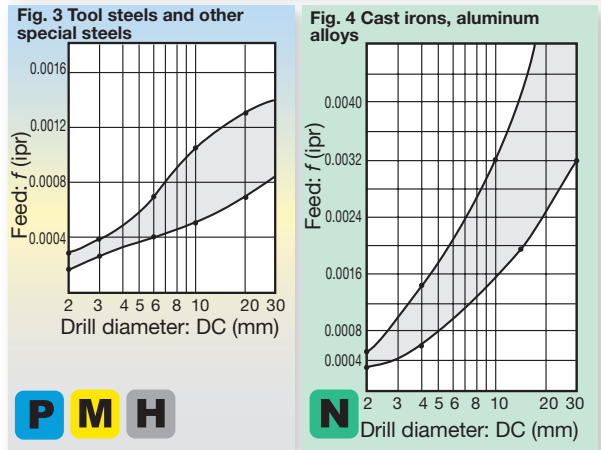
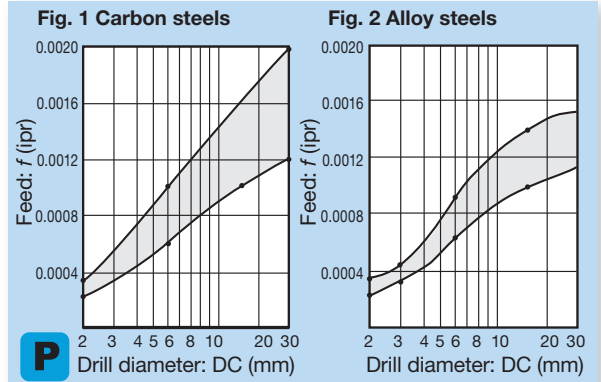

Guidelines for attainable accuracies

Workpiece material	Surface roughness (µm)	Roundness (µm)	Cylindricity (µm)	Oversizing (µm)
Carbon and alloy steels	6 ~ 25	5 ~ 10	10 ~ 15	- 5 ~ 30
Cast irons	3 ~ 15	3 ~ 5	5 ~ 10	- 5 ~ 15
Aluminum alloys, Copper alloys	0.3 ~ 6	3 ~ 5	5 ~ 10	- 10 ~ 5

Note: Over size values given in the table are based on the drill diameter.

Cutting fluid







A water-insoluble fluid is recommended when machining with gun drills. When using water soluble fluid, use the fluid for heavy duty cutting in higher concentration. A water-insoluble fluid must be taken care for Fire prevention

Grade
Insert
Toolholder
Ext. Toolholder
Int. Toolholder
Threading
Grooving
Milling Cutter
Miniature Tool
Endmill
Drilling Tool
Tooling System
User's Guide
Index

A
B
C
D
E
F
G
H
I
J
K
L
M







Drill Head Category

Solid drilling - Indexable drill heads -

Applications		STS (Single Tube System) 			DTS (Double Tube System) 		
		TRI-FINE	FINE-BEAM	UNIDEX	TRI-FINE	FINE-BEAM	UNIDEX
Solid drill head		FNTR	FNBM	KUSTS	FNTR-D	FNBM-D	KUDTS
							
Drill diameter		ø16 mm - ø28 mm (ø0.630" - ø1.102")	ø25 mm - ø65 mm (ø0.984" - ø2.559")	ø38 mm - ø293.99 mm (ø1.496" - ø4.212")	ø18.4 mm - ø28 mm (ø0.724" - ø1.102")	ø25 mm - ø65 mm (ø0.984" - ø2.559")	ø38 mm - ø106.99 mm (ø1.496" - ø4.212")
Thread type	External 4-start thread	○	○	○	○	○	○
	Internal single-start thread	○	○	○	-	-	-
Hole tolerance		IT10	IT10	IT10	IT10	IT10	IT10
Surface finish Ra (µm)		2	2	3	2	2	3
Machine	Deep hole drilling machines	○	○	○	○	○	○
	NC machines	-	-	-	○	○	○
	Lathes	-	-	-	○	○	○
	Machining centers M/C	-	-	-	○	○	○
	Gundrill machines	-	-	-	-	-	-
Workpiece material	P Steel	★★★	★★★	★★★	★★★	★★★	★★★
	M Stainless	★★★	★★★	★★★	★★★	★★★	★★★
	K Cast iron	★★★	★★★	★★★	★★★	★★★	★★★
	N Non-ferrous	★★★	★★★	★★★	★★★	★★★	★★★
	S Superalloys	★★	★★	★★	★★	★★	★★
	H Hard materials (≥40HRC)	★★	★★	★★	★★	★★	★★
Insert type		TOHT	FBH / FBM	NPMX / TPMX (508 / 1123)	TOHT	FBH / FBM	NPMX / TPMX (508 / 1123)
Plus Cartridge and Guide pad +1 mm - +5 mm		-	-	○	-	-	○
Page		J128 - J131	J132 - J133 J135 - J137	J138 - J139 J142 - J143	J129 - J131	J134 - J137	J140 - J143

★★★(Excellent) ←→ ★(Standard)

Solid drilling - Brazed drill heads -

Applications		STS (Single Tube System) 			DTS (Double Tube System) 
		MBU	UTE	BTU	ETU
Brazed drilling heads					
Drill diameter		ø8 mm - ø14.79 mm (ø0.315" - ø0.582")	ø12.6 mm - ø20 mm (ø0.496" - ø0.787")	ø12.6 mm - ø65 mm (ø0.496" - ø0.614")	ø18.4 mm - ø65 mm (ø0.724" - ø2.559")
Thread type	External single-start thread	○	-	-	-
	External 2-start thread	-	○*1	○*1	-
	External 4-start thread	-	○*2	○*2	○
	Internal single-start thread	-	-	-	-
Hole tolerance		IT9	IT9	IT9	IT9
Surface finish Ra (µm)		2	2	2	2
Machine	Deep hole drilling machines	○	○	○	○
	NC machines	-	-	-	○
	Lathes	-	-	-	○
	Machining centers M/C	-	-	-	○
	Gundrill machines	-	-	-	-
Workpiece material	P Steel	★★★	★★★	★★★	★★★
	M Stainless	★★★	★★★	★★★	★★★
	K Cast iron	★★★	★★★	★★★	★★★
	N Non-ferrous	★★★	★★★	★★★	★★★
	S Superalloys	★★	★★	★★	★★
	H Hard materials (≥40HRC)	★★	★★	★★	★★
Page		J144, J149	J145, J149	J146 - J147, J149	J148 - J149

*1: UTE & BTU Drill head : ø12.6 mm - ø15.59 mm, External 2-start thread





*2: UTE & BTU Drill head : ø15.6 mm -, External 4-start thread

★★★ (Excellent) ← → ★ (Standard)



Drill Tube Category

Drill Tubes

Applications			STS (Single Tube System)				DTS (Double Tube System)		
			UMBB	ST	ST	UB	OT	IT	
Drill tubes									
Tube diameter			ø7.1 mm - ø12 mm (ø0.280" - ø0.472")	ø11 mm - ø13 mm (ø0.433" - ø0.512")	ø14 mm - ø274 mm (ø0.551" - ø10.787")	ø12 mm - ø274 mm (ø0.472" - ø10.787")	ø18 mm - ø166 mm (ø0.709" - ø6.535")	ø10 mm - ø130 mm (ø0.394" - ø5.118")	
Thread type			Internal single-start thread	Internal 2-start thread	Internal 4-start thread	External single-start thread	Internal 4-start thread	-	
Drill Head	Indexable	Solid	FNTR	-	-	○	○	○	○
			FNBM	-	-	○	○	○	○
			KUSTS	-	-	○	○	-	-
			KUDTS	-	-	-	-	○	○
	Brazed	Solid	MBU	○	-	-	-	-	-
			UTE	-	○	○	-	-	-
			BTU	-	○	○	-	-	-
			ETU	-	-	-	-	○	○
Drill diameter			ø8 mm - ø14.79 mm (ø0.315" - ø0.582")	ø12.6 mm - ø15.59 mm (ø0.496" - ø0.614")	ø15.6 mm - ø291.99 mm (ø0.614" - ø11.496")	ø14.5 mm - ø293.99 mm (ø0.571" - ø11.574")	ø18.4 mm - ø183.99 mm (ø0.724" - ø7.244")	ø18.4 mm - ø183.99 mm (ø0.724" - ø7.244")	
Solid			○	○	○	○	○	○	
Counter			-	-	○ ^{*1}	○ ^{*1}	○ ^{*1}	○	
Trepanning			-	-	○ ^{*2}	○ ^{*2}	-	-	
Page			J150	J150	J150	J152	J154	J154	

*1. Counter : ST / UB / OT Tube - Drill diameter ø25 mm or more

*2. Trepanning : ST / UB Tube - Drill diameter ø100 mm or more

Single Tube System (STS) and Double Tube System (DTS)

Single Tube System (STS)

The STS may also be referred to as the BTA system in the deep hole drilling process. A large volume of coolant is pumped under high pressure to the cutting area in the workpiece. Chips are then forced out through the drill tube at the back and they do not touch workpiece allowing super surface finish. STS is a very good method to obtain holes of high productivity and high accuracy by using a dedicated drilling machine and a sealing with the workpiece.

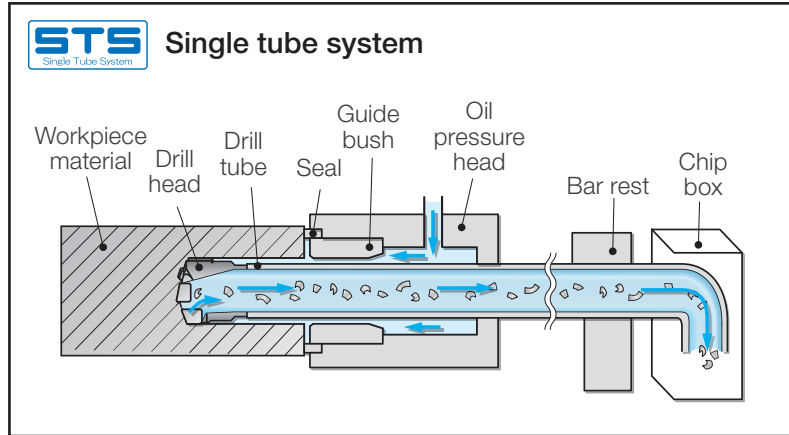

Double Tube System (DTS)

The DTS is characterized by its two tube construction and is therefore known as the double tube system. A sealing system and pressure head, which is required in the Single Tube System (STS) is not necessary for the DTS and it is therefore suitable for conventional general purpose machines such as lathes or machining centers.

In general, because of less efficient chip evacuation than the STS the recommended max drilling depth is 1000mm. However, the unique DTC-R tube connector that is capable of supplying high pressure coolant can successfully achieve drilling depths of up to 2000 mm.

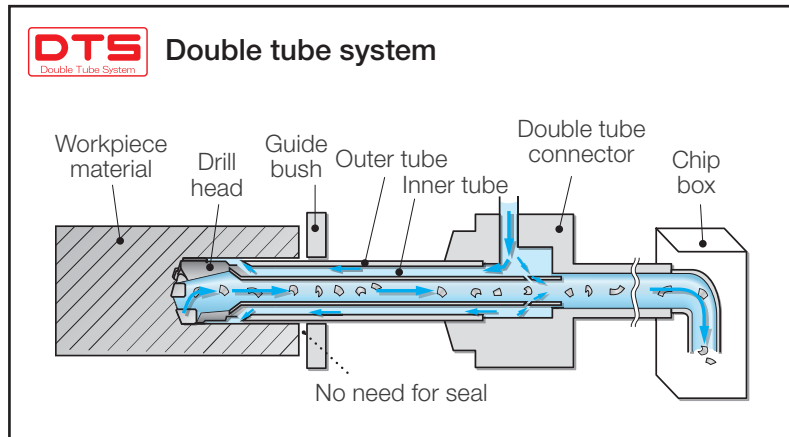

TRI-FINE

TRI-FINE STS-EX

Indexable head with external 4-start thread for single tube system

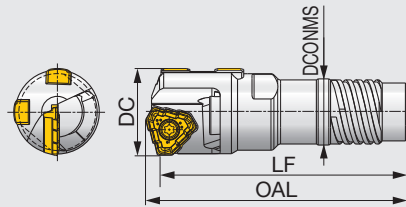

Metric	DC		Drill tube		OAL	LF	DCONMS	Insert	Guide pad
	(in)	(mm)	Designation	Dia. (mm)					
FNTR-0097S-16.00	0.630	16	ST0097	14	57	55	12.6	TOHT080305R	GP06-075
FNTR-0098S-17.00	0.669	17	ST0098	15	57	55	13.6	TOHT080305R	GP06-075
FNTR-0000S-20.00	0.787	20	ST0000	17	59	56	15.5	TOHT090305R	GP06-085
FNTR-00S-21.00	0.827	21	ST00	18	63	60	16	TOHT100305R	GP06-085
FNTR-01S-22.00	0.866	22	ST01	20	69	65.5	18	TOHT110405R	GP06-100
FNTR-01S-24.00	0.945	24	ST01	20	69	65.5	18	TOHT110405R	GP06-100
FNTR-02S-25.00	0.984	25	ST02	22	69	65.5	19.5	TOHT110405R	GP06-100
FNTR-02S-25.40	1.000	25.4	ST02	22	69	65.5	19.5	TOHT120405R	GP06
FNTR-02S-26.00	1.024	26	ST02	22	69	65.5	19.5	TOHT120405R	GP06
FNTR-03S-28.00	1.102	28	ST03	24	69	65.5	21	TOHT120405R	GP06

INSERT SPARE PARTS



Designation	Screw	Wrench
TOHT080305R	CSTB-2.5S	T-8F
TOHT080305R	CSTB-2.5S	T-8F
TOHT090305R	CSTB-2.5S	T-8F
TOHT100305R	CSTB-3S	T-9F
TOHT110405R	CSTB-3.5H	T-15F
TOHT110405R	CSTB-3.5H	T-15F
TOHT110405R	CSTB-3.5H	T-15F
TOHT120405R	CSTB-4S	T-15F
TOHT120405R	CSTB-4S	T-15F
TOHT120405R	CSTB-4S	T-15F

GUIDE PAD SPARE PARTS



Designation	Screw	Wrench
GP06-075	CSTB-2.2S	T-7F
GP06-075	CSTB-2.2S	T-7F
GP06-085	CSTB-2.2S	T-7F
GP06-085	CSTB-2.2S	T-7F
GP06-100	CSTB-2.2S	T-7F
GP06-100	CSTB-2.2S	T-7F
GP06-100	CSTB-2.2S	T-7F
GP06-100	CSTB-2.2S	T-7F
GP06	CSTB-2.2S	T-7F
GP06	CSTB-2.2S	T-7F
GP06	CSTB-2.2S	T-7F

Recommended clamping torque (N·m): CSTB-2.2S=1, CSTB-2.5S=1.3, CSTB-3S=2.3, CSTB-3.5H=3, CSTB-4S=3

TRI-FINE

TRI-FINE STS-IN

Indexable head with internal single-start thread for single tube system

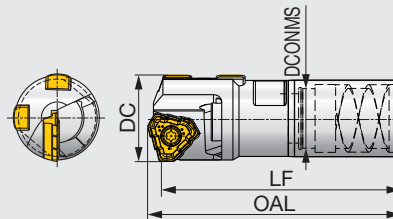

Metric	DC		Drill tube		OAL	LF	DCONMS	Insert	Guide pad
	(in)	(mm)	Designation	Dia. (mm)					
FNTR-13N-1-16.00	0.630	16	UB13-1	13	55.5	53.5	10.8	TOHT080305R	GP06-075
FNTR-14N-2-18.00	0.709	18	UB14-2	14	55.5	53.5	12.1	TOHT080305R	GP06-075
FNTR-18N-20.00	0.787	20	UB18	18	61	58	14.5	TOHT090305R	GP06-085
FNTR-20N-22.00	0.866	22	UB20	20	63.5	60	16	TOHT110405R	GP06-100
FNTR-20N-24.00	0.945	24	UB20	20	63.5	60	16	TOHT110405R	GP06-100
FNTR-22N-25.00	0.984	25	UB22	22	63.5	60	17	TOHT110405R	GP06-100
FNTR-22N-26.00	1.024	26	UB22	22	68.5	65	17	TOHT120405R	GP06
FNTR-24N-28.00	1.102	28	UB24	24	68.5	65	19	TOHT120405R	GP06

INSERT SPARE PARTS



Designation	Screw	Wrench
TOHT080305R	CSTB-2.5S	T-8F
TOHT080305R	CSTB-2.5S	T-8F
TOHT090305R	CSTB-2.5S	T-8F
TOHT110405R	CSTB-3.5H	T-15F
TOHT110405R	CSTB-3.5H	T-15F
TOHT110405R	CSTB-3.5H	T-15F
TOHT120405R	CSTB-4S	T-15F
TOHT120405R	CSTB-4S	T-15F

GUIDE PAD SPARE PARTS



Designation	Screw	Wrench
GP06-075	CSTB-2.2S	T-7F
GP06-075	CSTB-2.2S	T-7F
GP06-085	CSTB-2.2S	T-7F
GP06-100	CSTB-2.2S	T-7F
GP06-100	CSTB-2.2S	T-7F
GP06-100	CSTB-2.2S	T-7F
GP06-100	CSTB-2.2S	T-7F
GP06	CSTB-2.2S	T-7F
GP06	CSTB-2.2S	T-7F

Recommended clamping torque (N·m): CSTB-2.2S=1, CSTB-2.5S, CSTB-3S=2.3, CSTB-3.5H=3, CSTB-4S=3

Indexable head with external 4-start thread for double tube system

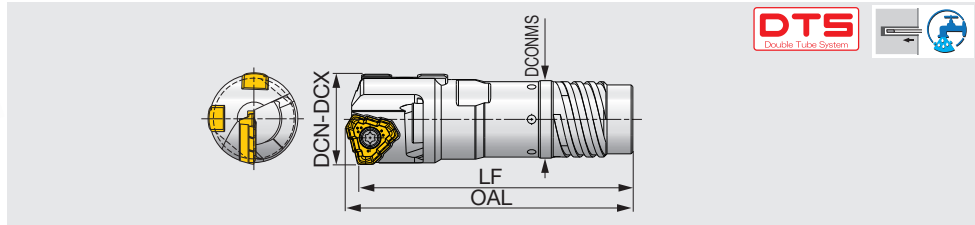

Metric	DCN		DCX		Outer tube			Insert	Guide pad		
	(in)	(mm)	(in)	(mm)	Designation	Dia. (mm)	OAL				
FNTR-00D-xx.xx	0.725	18.41	0.787	20	OT00	18	62	59	16	TOHT090305R	GP06-085
FNTR-01D-xx.xx	0.788	20.01	0.827	21	OT01	19.5	66.5	63.5	18	TOHT100305R	GP06-085
FNTR-01D-xx.xx	0.827	21.01	0.858	21.8	OT01	19.5	66.5	63.5	18	TOHT100305R	GP06-100
FNTR-02D-xx.xx	0.859	21.81	0.866	21.99	OT02	21.5	66.5	63.5	19.5	TOHT100305R	GP06-100
FNTR-02D-xx.xx	0.866	22	0.949	24.1	OT02	21.5	69	65.5	19.5	TOHT110405R	GP06-100
FNTR-03D-xx.xx	0.949	24.11	0.984	25	OT03	23.5	69	65.5	21	TOHT110405R	GP06-100
FNTR-03D-xx.xx	0.985	25.01	1.039	26.4	OT03	23.5	71	67.5	21	TOHT120405R	GP06
FNTR-04D-xx.xx	1.040	26.41	1.102	28	OT04	26	74	70.5	23.5	TOHT120405R	GP06

e.g. Designation for tool diameter ø20 mm : FNTR-00D-20.00

INSERT SPARE PARTS

Designation	Screw	Wrench
TOHT090305R	CSTB-2.5S	T-8F
TOHT100305R	CSTB-3S	T-9F
TOHT100305R	CSTB-3S	T-9F
TOHT100305R	CSTB-3S	T-9F
TOHT110405R	CSTB-3.5H	T-15F
TOHT110405R	CSTB-3.5H	T-15F
TOHT120405R	CSTB-4S	T-15F
TOHT120405R	CSTB-4S	T-15F

GUIDE PAD SPARE PARTS

Designation	Screw	Wrench
GP06-085	CSTB-2.2S	T-7F
GP06-085	CSTB-2.2S	T-7F
GP06-100	CSTB-2.2S	T-7F
GP06-100	CSTB-2.2S	T-7F
GP06-100	CSTB-2.2S	T-7F
GP06-100	CSTB-2.2S	T-7F
GP06	CSTB-2.2S	T-7F
GP06	CSTB-2.2S	T-7F

Recommended clamping torque (N·m): CSTB-2.2S=1, CSTB-2.5S, CSTB-3S=2.3, CSTB-3.5H=3, CSTB-4S=3

INSERT

TOHT-NDJ (070..., 080...)

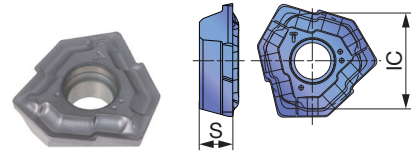

TOHT-NDJ (090... - 120...)

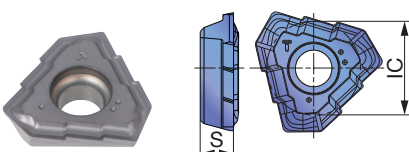

P Steel	★								
M Stainless	★								
K Cast iron	★								
N Non-ferrous	★								
S Superalloys	★								
H Hard materials	★								

★ : First choice
☆ : Second choice

Designation	DCN (in)	DCX (in)	Coated							IC (in)	S (in)
			AH725								
TOHT080305R-NDJ	0.630	0.709	●							0.337	0.110
TOHT090305R-NDJ	0.709	0.787	●							0.328	0.118
TOHT100305R-NDJ	0.788	0.866	●							0.363	0.130
TOHT110405R-NDJ	0.866	0.984	●							0.409	0.150
TOHT120405R-NDJ	0.985	1.102	●							0.456	0.169

● : Line up
Package quantity = 10 pcs.

Reference pages: Inserts → **J130 - J131**, Guide pads → **J131**,
Drill tube (STS) → **J150**, Drill tube (DTS) → **J154**



INSERT

TOHT-NDL (07..., 08...)

TOHT-NDL (09... - 12...)

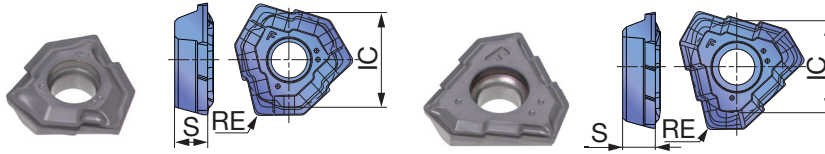

P	Steel	★																		
M	Stainless	★																		
K	Cast iron	★																		
N	Non-ferrous	★																		
S	Superalloys	★																		
H	Hard materials	★																		

★ : First choice
☆ : Second choice

Designation	DCN (in)	DCX (in)	Coated										IC (in)	S (in)	RE (in)			
			AH725															
TOHT070304R-NDL	0.551	0.630	●													0.303	0.091	0.016
TOHT080305R-NDL	0.630	0.709	●													0.337	0.110	0.020
TOHT090305R-NDL	0.709	0.787	●													0.328	0.118	0.020
TOHT100305R-NDL	0.788	0.866	●													0.363	0.130	0.020
TOHT110405R-NDL	0.866	0.984	●													0.409	0.150	0.020
TOHT120405R-NDL	0.985	1.102	●													0.456	0.169	0.020

● : Line up
Package quantity = 10 pcs.

ISO classifications for Insert grades

Grade	ISO area						
	10	15	20	25	30	35	40
P							
M							
K							
N							
S							
H							

GUIDE PAD

GP06

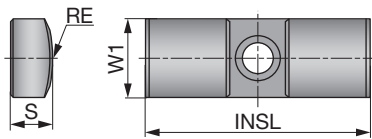

P	Steel	☆	☆	★	☆
M	Stainless	☆	☆	★	☆
K	Cast iron	☆	☆	★	☆
N	Non-ferrous	☆	☆	★	☆
S	Superalloys	☆	☆	★	☆
H	Hard materials	☆	☆	★	☆

★ : First choice
☆ : Second choice

Designation	DCN (in)	DCX (in)	Coated				W1 (in)	INSL (in)	S (in)	RE (in)
			F1122	F2122	FH3125	FH3135				
GP06-075	0.630	0.709	●	▲			0.236	0.787	0.118	0.295
GP06-20-075-DC	0.630	0.709			●	●	0.236	0.787	0.118	0.295
GP06-085	0.709	0.827	●	▲			0.236	0.787	0.118	0.335
GP06-20-085-DC	0.709	0.827			●	●	0.236	0.787	0.118	0.335
GP06-100	0.827	0.984	●	▲			0.236	0.787	0.118	0.394
GP06-20-100-DC	0.827	0.984			●	●	0.236	0.787	0.118	0.394
GP06	0.985	1.299	●	▲			0.236	0.787	0.118	0.472
GP06-20-120-DC	0.985	1.299			●	●	0.236	0.787	0.118	0.472

● : Line up
▲ : To be discontinued
Package quantity = 5 pcs.

REPLACING GUIDE PADS

Guide pads are subject to wear, like inserts.

- The guide pad has two sides.
- Each guide pad can be used on two sides. When the first corner wears out to 70% of the width, reverse the guide pad to use the second side.
- Replace with a new guide pad when the second side wears out.

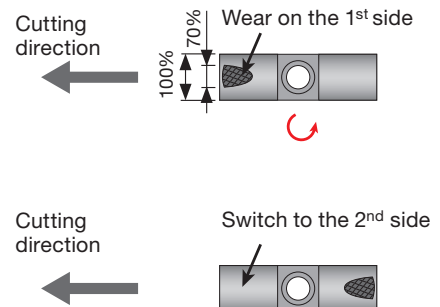
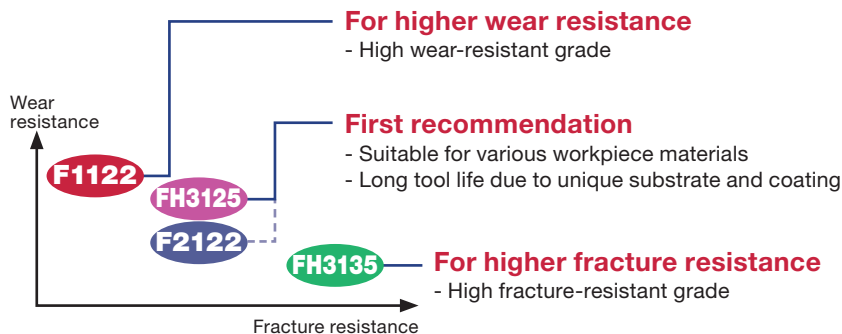

GP	06-075	F2122
Series	Size	Grade

Grade
Insert
Toolholder
Ext. Toolholder
Int. Toolholder
Threading
Grooving
Milling Cutter
Miniature Tool
Endmill
Drilling Tool
Tooling System
User's Guide
Index



Direct mount indexable head with external 4-start thread for single tube system (STS), tool diameter: $\varnothing 25$ - $\varnothing 65$ mm (0.984" - 2.559")

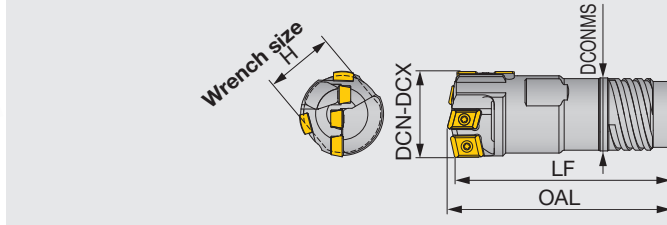

Metric	DCN		DCX		Drill tube		Drill head			
	(in)	(mm)	(in)	(mm)	Designation	Dia. (mm)	OAL	LF	DCONMS	H
FNBM-02S-xx.xx	0.984	25	1.039	26.4	ST02	22	73	70	19.5	19
FNBM-03S-xx.xx	1.040	26.41	1.130	28.7	ST03	24	73	70	21	21
FNBM-04S-xx.xx	1.130	28.71	1.220	31	ST04	26	78	75	23.5	24
FNBM-05S-xx.xx	1.221	31.01	1.311	33.3	ST05	28	78	75	25.5	26
FNBM-06S-xx.xx	1.311	33.31	1.425	36.2	ST06	30	83	80	28	28
FNBM-07S-xx.xx	1.426	36.21	1.559	39.6	ST07	33	93	90	30	30
FNBM-08S-xx.xx	1.559	39.61	1.693	43	ST08	36	99	95	33	32
FNBM-09S-xx.xx	1.693	43.01	1.850	47	ST09	39	104	100	36	36
FNBM-10S-xx.xx	1.851	47.01	2.035	51.7	ST10	43	104	100	39	38
FNBM-11S-xx.xx	2.036	51.71	2.213	56.2	ST11	47	114	110	43	46
FNBM-12S-xx.xx	2.213	56.21	2.559	65	ST12	51	120	115	47.5	50
FNBM-13S-xx.xx	2.386	60.61	2.559	65	ST13	56	120	115	51	54

e.g. Designation for tool diameter $\varnothing 30$ mm : FNBM-04S-30.00

SPARE PARTS



Tool diameter DCN - DCX (mm)	Insert									Guide pad		
	① Peripheral			② Intermediate			③ Central			④		
	Insert	Screw	Wrench	Insert	Screw	Wrench	Insert	Screw	Wrench	Guide pad	Screw	Wrench
25.00 - 28.00	FBH060304R-G-P	CSTB-2.2	T-7F	FBM060304R-G-I	CSTB-2.2	T-7F	FBM060308L-G-C	CSTB-2.2	T-7F	GP06	CSTB-2.2S	T-7F
	FBH060308R-HF-P	CSTB-2.2	T-7F	FBM060304R-HF-I	CSTB-2.2	T-7F	FBM060308L-HF-C	CSTB-2.2	T-7F	GP06	CSTB-2.2S	T-7F
28.01 - 29.99	FBH060304R-G-P	CSTB-2.2	T-7F	FBM060304R-G-I	CSTB-2.2	T-7F	FBM070408L-G-C	SR14-560-HG	T-8F	GP06	CSTB-2.2S	T-7F
	FBH060308R-HF-P	CSTB-2.2	T-7F	FBM060304R-HF-I	CSTB-2.2	T-7F	FBM070408L-HF-C	SR14-560-HG	T-8F	GP06	CSTB-2.2S	T-7F
30.00 - 35.00	FBH080404R-G-P	SR14-560-HG	T-8F	FBM070404R-G-I	SR14-560-HG	T-8F	FBM070408L-G-C	SR14-560-HG	T-8F	GP07	CSTB-3S	T-9F
	FBH080408R-HF-P	SR14-560-HG	T-8F	FBM070404R-HF-I	SR14-560-HG	T-8F	FBM070408L-HF-C	SR14-560-HG	T-8F	GP07	CSTB-3S	T-9F
35.01 - 38.00	FBH080404R-G-P	SR14-560-HG	T-8F	FBM070404R-G-I	SR14-560-HG	T-8F	FBM080408L-G-C	SR14-560-HG	T-8F	GP07	CSTB-3S	T-9F
	FBH080408R-HF-P	SR14-560-HG	T-8F	FBM070404R-HF-I	SR14-560-HG	T-8F	FBM080408L-HF-C	SR14-560-HG	T-8F	GP07	CSTB-3S	T-9F
38.01 - 39.00	FBH090404R-G-P	SR14-560-HG	T-8F	FBM070404R-G-I	SR14-560-HG	T-8F	FBM080408L-G-C	SR14-560-HG	T-8F	GP07	CSTB-3S	T-9F
	FBH090408R-HF-P	SR14-560-HG	T-8F	FBM070404R-HF-I	SR14-560-HG	T-8F	FBM080408L-HF-C	SR14-560-HG	T-8F	GP07	CSTB-3S	T-9F
39.01 - 41.00	FBH090404R-G-P	SR14-560-HG	T-8F	FBM070404R-G-I	SR14-560-HG	T-8F	FBM080408L-G-C	SR14-560-HG	T-8F	GP08	CSTB-3S	T-9F
	FBH090408R-HF-P	SR14-560-HG	T-8F	FBM070404R-HF-I	SR14-560-HG	T-8F	FBM080408L-HF-C	SR14-560-HG	T-8F	GP08	CSTB-3S	T-9F
41.01 - 44.00	FBH090404R-G-P	SR14-560-HG	T-8F	FBM080404R-G-I	SR14-560-HG	T-8F	FBM080408L-G-C	SR14-560-HG	T-8F	GP08	CSTB-3S	T-9F
	FBH090408R-HF-P	SR14-560-HG	T-8F	FBM080404R-HF-I	SR14-560-HG	T-8F	FBM080408L-HF-C	SR14-560-HG	T-8F	GP08	CSTB-3S	T-9F
44.01 - 45.00	FBH090404R-G-P	SR14-560-HG	T-8F	FBM080404R-G-I	SR14-560-HG	T-8F	FBM100408L-G-C	SR14-560-HG	T-8F	GP08	CSTB-3S	T-9F
	FBH090408R-HF-P	SR14-560-HG	T-8F	FBM080404R-HF-I	SR14-560-HG	T-8F	FBM100408L-HF-C	SR14-560-HG	T-8F	GP08	CSTB-3S	T-9F
45.01 - 47.00	FBH090404R-G-P	SR14-560-HG	T-8F	FBM080404R-G-I	SR14-560-HG	T-8F	FBM100408L-G-C	SR14-560-HG	T-8F	GP10S	CSTB-3.5	T-15F
	FBH090408R-HF-P	SR14-560-HG	T-8F	FBM080404R-HF-I	SR14-560-HG	T-8F	FBM100408L-HF-C	SR14-560-HG	T-8F	GP10S	CSTB-3.5	T-15F
47.01 - 51.00	FBH110404R-G-P	SR14-560-HG	T-8F	FBM080404R-G-I	SR14-560-HG	T-8F	FBM100408L-G-C	SR14-560-HG	T-8F	GP10S	CSTB-3.5	T-15F
	FBH110408R-HF-P	SR14-560-HG	T-8F	FBM080404R-HF-I	SR14-560-HG	T-8F	FBM100408L-HF-C	SR14-560-HG	T-8F	GP10S	CSTB-3.5	T-15F
51.01 - 54.00	FBH110404R-G-P	SR14-560-HG	T-8F	FBM100404R-G-I	SR14-560-HG	T-8F	FBM100408L-G-C	SR14-560-HG	T-8F	GP10S	CSTB-3.5	T-15F
	FBH110408R-HF-P	SR14-560-HG	T-8F	FBM100404R-HF-I	SR14-560-HG	T-8F	FBM100408L-HF-C	SR14-560-HG	T-8F	GP10S	CSTB-3.5	T-15F
54.01 - 57.00	FBH110404R-G-P	SR14-560-HG	T-8F	FBM100404R-G-I	SR14-560-HG	T-8F	FBM130408L-G-C	SR14-560-HG	T-8F	GP10S	CSTB-3.5	T-15F
	FBH110408R-HF-P	SR14-560-HG	T-8F	FBM100404R-HF-I	SR14-560-HG	T-8F	FBM130408L-HF-C	SR14-560-HG	T-8F	GP10S	CSTB-3.5	T-15F
57.01 - 60.00	FBH110404R-G-P	SR14-560-HG	T-8F	FBM100404R-G-I	SR14-560-HG	T-8F	FBM130408L-G-C	SR14-560-HG	T-8F	GP12	CSTB-3.5	T-15F
	FBH110408R-HF-P	SR14-560-HG	T-8F	FBM100404R-HF-I	SR14-560-HG	T-8F	FBM130408L-HF-C	SR14-560-HG	T-8F	GP12	CSTB-3.5	T-15F
60.01 - 64.00	FBH130404R-G-P	SR14-560-HG	T-8F	FBM100404R-G-I	SR14-560-HG	T-8F	FBM130408L-G-C	SR14-560-HG	T-8F	GP12	CSTB-3.5	T-15F
	FBH130408R-HF-P	SR14-560-HG	T-8F	FBM100404R-HF-I	SR14-560-HG	T-8F	FBM130408L-HF-C	SR14-560-HG	T-8F	GP12	CSTB-3.5	T-15F
64.01 - 65.00	FBH130404R-G-P	SR14-560-HG	T-8F	FBM130404R-G-I	SR14-560-HG	T-8F	FBM130408L-G-C	SR14-560-HG	T-8F	GP12	CSTB-3.5	T-15F
	FBH130408R-HF-P	SR14-560-HG	T-8F	FBM130404R-HF-I	SR14-560-HG	T-8F	FBM130408L-HF-C	SR14-560-HG	T-8F	GP12	CSTB-3.5	T-15F

Please see the page **J135 - J137** for the grades of inserts and guide pads.

Drill heads come with clamping screws and wrenches but do not include inserts and guide pads.

Please purchase inserts and guide pads separately.

Recommended clamping torque (N·m): CSTB-2.2/CSTB-2.2S = 1, SR14-560-HG = 1.2, CSTB-3S = 2.3, CSTB-3.5 = 3.5

G type chipbreaker	HF type chipbreaker
FBH060304R-G-P	FBH060308R-HF-P
FBH080404R-G-P	FBH080408R-HF-P
FBH090404R-G-P	FBH090408R-HF-P
FBH110404R-G-P	FBH110408R-HF-P
FBH130404R-G-P	FBH130408R-HF-P
FBM060304R-G-I	FBM060304R-HF-I
FBM070404R-G-I	FBM070404R-HF-I
FBM080404R-G-I	FBM080404R-HF-I
FBM100404R-G-I	FBM100404R-HF-I
FBM130404R-G-I	FBM130404R-HF-I
FBM060308L-G-C	FBM060308L-HF-C
FBM070408L-G-C	FBM070408L-HF-C
FBM080408L-G-C	FBM080408L-HF-C
FBM100408L-G-C	FBM100408L-HF-C
FBM130408L-G-C	FBM130408L-HF-C

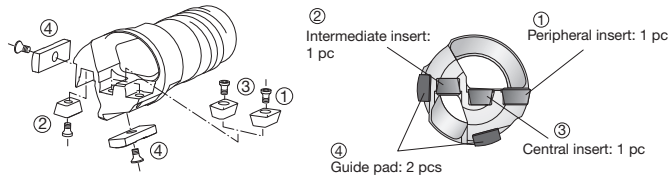

The designation of insert with G type and HF type is different, even in the same shape.

Please refer to the table on the left to check the insert designation. Both inserts can be mounted on the drill head.

Reference pages: Inserts → **J135 - J136**, Guide pads → **J137**, Drill tube (STS) → **J150**

Direct mount indexable head with internal single-start thread for single tube system (STS), tool diameter: $\varnothing 25 - \varnothing 65 \text{ mm}$ (0.984" - 2.559")

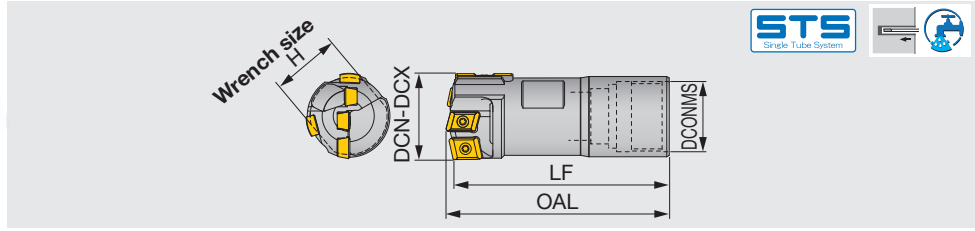

Metric	DCN		DCX		Drill tube		Drill head			
	(in)	(mm)	(in)	(mm)	Designation	Dia. (mm)	OAL	LF	DCONMS	H
FNBM-22N-xx.xx	0.984	25	1.063	26.99	UB22	22	73	70	20	19
FNBM-24N-xx.xx	1.063	27	1.142	29	UB24	24	73	70	22	21
FNBM-24N-xx.xx	1.142	29.01	1.181	29.99	UB24	24	73	70	22	24
FNBM-26N-xx.xx	1.181	30	1.259	31.99	UB26	26	78	75	24	24
FNBM-28N-xx.xx	1.260	32	1.338	33.99	UB28	28	78	75	26	26
FNBM-30N-xx.xx	1.339	34	1.456	36.99	UB30	30	93	90	27	28
FNBM-33N-xx.xx	1.457	37	1.574	39.99	UB33	33	98	95	30	30
FNBM-36N-xx.xx	1.575	40	1.732	43.99	UB36	36	104	100	33	32
FNBM-39N-xx.xx	1.732	44	1.850	46.99	UB39	39	109	105	37	36
FNBM-43N-xx.xx	1.850	47	2.047	51.99	UB43	43	109	105	41	38
FNBM-47N-xx.xx	2.047	52	2.244	56.99	UB47	47	114	110	44	46
FNBM-51N-xx.xx	2.244	57	2.401	60.99	UB51	51	120	115	49	46
FNBM-56N-xx.xx	2.402	61	2.559	65	UB56	56	120	115	53	54

e.g. Designation for tool diameter $\varnothing 30 \text{ mm}$: FNBM-26N-30.00

SPARE PARTS



Tool diameter DCN - DCX (mm)	Insert									Guide pad		
	① Peripheral			② Intermediate			③ Central			④		
	Insert	Screw	Wrench	Insert	Screw	Wrench	Insert	Screw	Wrench	Guide pad	Screw	Wrench
25.00 - 28.00	FBH060304R-G-P	CSTB-2.2	T-7F	FBM060304R-G-I	CSTB-2.2	T-7F	FBM060308L-G-C	CSTB-2.2	T-7F	GP06	CSTB-2.2S	T-7F
	FBH060308R-HF-P	CSTB-2.2	T-7F	FBM060304R-HF-I	CSTB-2.2	T-7F	FBM060308L-HF-C	CSTB-2.2	T-7F	GP06	CSTB-2.2S	T-7F
28.01 - 29.99	FBH060304R-G-P	CSTB-2.2	T-7F	FBM060304R-G-I	CSTB-2.2	T-7F	FBM070408L-G-C	SR14-560-HG	T-8F	GP06	CSTB-2.2S	T-7F
	FBH060308R-HF-P	CSTB-2.2	T-7F	FBM060304R-HF-I	CSTB-2.2	T-7F	FBM070408L-HF-C	SR14-560-HG	T-8F	GP06	CSTB-2.2S	T-7F
30.00 - 35.00	FBH080404R-G-P	SR14-560-HG	T-8F	FBM070404R-G-I	SR14-560-HG	T-8F	FBM070408L-G-C	SR14-560-HG	T-8F	GP07	CSTB-3S	T-9F
	FBH080408R-HF-P	SR14-560-HG	T-8F	FBM070404R-HF-I	SR14-560-HG	T-8F	FBM070408L-HF-C	SR14-560-HG	T-8F	GP07	CSTB-3S	T-9F
35.01 - 38.00	FBH080404R-G-P	SR14-560-HG	T-8F	FBM070404R-G-I	SR14-560-HG	T-8F	FBM080408L-G-C	SR14-560-HG	T-8F	GP07	CSTB-3S	T-9F
	FBH080408R-HF-P	SR14-560-HG	T-8F	FBM070404R-HF-I	SR14-560-HG	T-8F	FBM080408L-HF-C	SR14-560-HG	T-8F	GP07	CSTB-3S	T-9F
38.01 - 39.00	FBH090404R-G-P	SR14-560-HG	T-8F	FBM070404R-G-I	SR14-560-HG	T-8F	FBM080408L-G-C	SR14-560-HG	T-8F	GP07	CSTB-3S	T-9F
	FBH090408R-HF-P	SR14-560-HG	T-8F	FBM070404R-HF-I	SR14-560-HG	T-8F	FBM080408L-HF-C	SR14-560-HG	T-8F	GP07	CSTB-3S	T-9F
39.01 - 41.00	FBH090404R-G-P	SR14-560-HG	T-8F	FBM070404R-G-I	SR14-560-HG	T-8F	FBM080408L-G-C	SR14-560-HG	T-8F	GP08	CSTB-3S	T-9F
	FBH090408R-HF-P	SR14-560-HG	T-8F	FBM070404R-HF-I	SR14-560-HG	T-8F	FBM080408L-HF-C	SR14-560-HG	T-8F	GP08	CSTB-3S	T-9F
41.01 - 44.00	FBH090404R-G-P	SR14-560-HG	T-8F	FBM080404R-G-I	SR14-560-HG	T-8F	FBM080408L-G-C	SR14-560-HG	T-8F	GP08	CSTB-3S	T-9F
	FBH090408R-HF-P	SR14-560-HG	T-8F	FBM080404R-HF-I	SR14-560-HG	T-8F	FBM100408L-G-C	SR14-560-HG	T-8F	GP08	CSTB-3S	T-9F
44.01 - 45.00	FBH090408R-HF-P	SR14-560-HG	T-8F	FBM080404R-HF-I	SR14-560-HG	T-8F	FBM100408L-HF-C	SR14-560-HG	T-8F	GP08	CSTB-3S	T-9F
	FBH100404R-G-P	SR14-560-HG	T-8F	FBM080404R-G-I	SR14-560-HG	T-8F	FBM100408L-G-C	SR14-560-HG	T-8F	GP08	CSTB-3S	T-9F
45.01 - 47.00	FBH090404R-G-P	SR14-560-HG	T-8F	FBM080404R-G-I	SR14-560-HG	T-8F	FBM100408L-G-C	SR14-560-HG	T-8F	GP10S	CSTB-3.5	T-15F
	FBH090408R-HF-P	SR14-560-HG	T-8F	FBM080404R-HF-I	SR14-560-HG	T-8F	FBM100408L-HF-C	SR14-560-HG	T-8F	GP10S	CSTB-3.5	T-15F
47.01 - 51.00	FBH110404R-G-P	SR14-560-HG	T-8F	FBM080404R-G-I	SR14-560-HG	T-8F	FBM100408L-G-C	SR14-560-HG	T-8F	GP10S	CSTB-3.5	T-15F
	FBH110408R-HF-P	SR14-560-HG	T-8F	FBM080404R-HF-I	SR14-560-HG	T-8F	FBM100408L-HF-C	SR14-560-HG	T-8F	GP10S	CSTB-3.5	T-15F
51.01 - 54.00	FBH110404R-G-P	SR14-560-HG	T-8F	FBM100404R-G-I	SR14-560-HG	T-8F	FBM100408L-G-C	SR14-560-HG	T-8F	GP10S	CSTB-3.5	T-15F
	FBH110408R-HF-P	SR14-560-HG	T-8F	FBM100404R-HF-I	SR14-560-HG	T-8F	FBM100408L-HF-C	SR14-560-HG	T-8F	GP10S	CSTB-3.5	T-15F
54.01 - 57.00	FBH110404R-G-P	SR14-560-HG	T-8F	FBM100404R-G-I	SR14-560-HG	T-8F	FBM130408L-G-C	SR14-560-HG	T-8F	GP12	CSTB-3.5	T-15F
	FBH110408R-HF-P	SR14-560-HG	T-8F	FBM100404R-HF-I	SR14-560-HG	T-8F	FBM130408L-HF-C	SR14-560-HG	T-8F	GP12	CSTB-3.5	T-15F
57.01 - 60.00	FBH110404R-G-P	SR14-560-HG	T-8F	FBM100404R-G-I	SR14-560-HG	T-8F	FBM130408L-G-C	SR14-560-HG	T-8F	GP12	CSTB-3.5	T-15F
	FBH110408R-HF-P	SR14-560-HG	T-8F	FBM100404R-HF-I	SR14-560-HG	T-8F	FBM130408L-HF-C	SR14-560-HG	T-8F	GP12	CSTB-3.5	T-15F
60.01 - 64.00	FBH130404R-G-P	SR14-560-HG	T-8F	FBM100404R-G-I	SR14-560-HG	T-8F	FBM130408L-G-C	SR14-560-HG	T-8F	GP12	CSTB-3.5	T-15F
	FBH130408R-HF-P	SR14-560-HG	T-8F	FBM100404R-HF-I	SR14-560-HG	T-8F	FBM130408L-HF-C	SR14-560-HG	T-8F	GP12	CSTB-3.5	T-15F
64.01 - 65.00	FBH130404R-G-P	SR14-560-HG	T-8F	FBM130404R-G-I	SR14-560-HG	T-8F	FBM130408L-G-C	SR14-560-HG	T-8F	GP12	CSTB-3.5	T-15F
	FBH130408R-HF-P	SR14-560-HG	T-8F	FBM130404R-HF-I	SR14-560-HG	T-8F	FBM130408L-HF-C	SR14-560-HG	T-8F	GP12	CSTB-3.5	T-15F

Please see the page **J135 - J137** for the grades of inserts and guide pads.

Drill heads come with clamping screws and wrenches but do not include inserts and guide pads.

Please purchase inserts and guide pads separately.

Recommended clamping torque (N·m): CSTB-2.2/CSTB-2.2S = 1, SR14-560-HG = 1.2, CSTB-3S = 2.3, CSTB-3.5 = 3.5

G type chipbreaker	HF type chipbreaker
FBH060304R-G-P	FBH060308R-HF-P
FBH080404R-G-P	FBH080408R-HF-P
FBH090404R-G-P	FBH090408R-HF-P
FBH110404R-G-P	FBH110408R-HF-P
FBH130404R-G-P	FBH130408R-HF-P
FBM060304R-G-I	FBM060304R-HF-I
FBM070404R-G-I	FBM070404R-HF-I
FBM080404R-G-I	FBM080404R-HF-I
FBM100404R-G-I	FBM100404R-HF-I
FBM130404R-G-I	FBM130404R-HF-I
FBM060308L-G-C	FBM060308L-HF-C
FBM070408L-G-C	FBM070408L-HF-C
FBM080408L-G-C	FBM080408L-HF-C
FBM100408L-G-C	FBM100408L-HF-C
FBM130408L-G-C	FBM130408L-HF-C

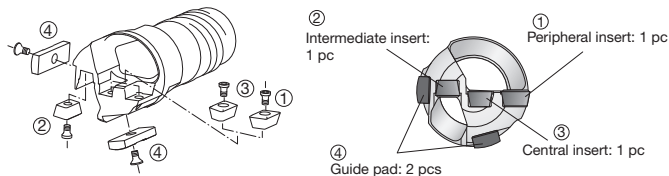

The designation of insert with G type and HF type is different, even in the same shape.

Please refer to the table on the left to check the insert designation. Both inserts can be mounted on the drill head.

Reference pages: Inserts → **J135 - J136**, Guide pads → **J137**,
Drill tube (STS) → **J150**

Direct mount indexable head with external 4-start thread for double tube system (DTS), tool diameter: $\varnothing 25 - \varnothing 65$ mm (0.984" - 2.559")

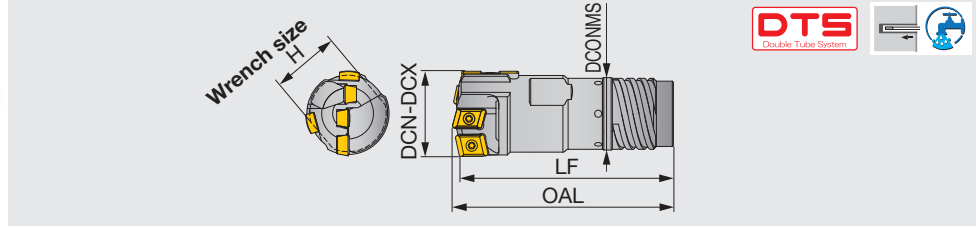

Metric	DCN		DCX		Outer tube		Drill head			
	(in)	(mm)	(in)	(mm)	Designation	Dia. (mm)	OAL	LF	DCONMS	H
FNBM-03D-xx.xx	0.984	25	1.039	26.4	OT03	23.5	73	70	21	19
FNBM-04D-xx.xx	1.040	26.41	1.130	28.7	OT04	26	78	75	23.5	21
FNBM-05D-xx.xx	1.130	28.71	1.220	31	OT05	28	78	75	25.5	24
FNBM-06D-xx.xx	1.221	31.01	1.311	33.3	OT06	30.5	83	80	28	26
FNBM-07D-xx.xx	1.311	33.31	1.425	36.2	OT07	33	93	90	30	28
FNBM-08D-xx.xx	1.426	36.21	1.559	39.6	OT08	35.5	99	95	33	30
FNBM-09D-xx.xx	1.559	39.61	1.693	43	OT09	39	104	100	36	32
FNBM-10D-xx.xx	1.693	43.01	1.850	47	OT10	42.5	104	100	39	36
FNBM-11D-xx.xx	1.851	47.01	2.035	51.7	OT11	46.5	114	110	43	38
FNBM-12D-xx.xx	2.036	51.71	2.213	56.2	OT12	51	120	115	47.5	46
FNBM-13D-xx.xx	2.213	56.21	2.386	60.6	OT13	55.5	120	115	51	50
FNBM-13D-xx.xx	2.386	60.61	2.559	65	OT13	55.5	120	115	51	54

e.g. Designation for tool diameter $\varnothing 30$ mm : FNBM-05D-30.00

SPARE PARTS

Tool diameter DCN - DCX (mm)	Insert									Guide pad		
	① Peripheral			② Intermediate			③ Central			④		
	Insert	Screw	Wrench	Insert	Screw	Wrench	Insert	Screw	Wrench	Guide pad	Screw	Wrench
25.00 - 28.00	FBH060304R-G-P	CSTB-2.2	T-7F	FBM060304R-G-I	CSTB-2.2	T-7F	FBM060308L-G-C	CSTB-2.2	T-7F	GP06	CSTB-2.2S	T-7F
28.01 - 29.99	FBH060308R-HF-P	CSTB-2.2	T-7F	FBM060304R-HF-I	CSTB-2.2	T-7F	FBM060308L-HF-C	CSTB-2.2	T-7F	GP06	CSTB-2.2S	T-7F
30.00 - 35.00	FBH060304R-G-P	CSTB-2.2	T-7F	FBM060304R-G-I	CSTB-2.2	T-7F	FBM070408L-G-C	SR14-560-HG	T-8F	GP06	CSTB-2.2S	T-7F
35.01 - 38.00	FBH080408R-HF-P	SR14-560-HG	T-8F	FBM070404R-G-I	SR14-560-HG	T-8F	FBM070408L-HF-C	SR14-560-HG	T-8F	GP07	CSTB-3S	T-9F
38.01 - 39.00	FBH080408R-HF-P	SR14-560-HG	T-8F	FBM070404R-HF-I	SR14-560-HG	T-8F	FBM070408L-HF-C	SR14-560-HG	T-8F	GP07	CSTB-3S	T-9F
39.01 - 41.00	FBH080408R-HF-P	SR14-560-HG	T-8F	FBM070404R-G-I	SR14-560-HG	T-8F	FBM080408L-G-C	SR14-560-HG	T-8F	GP07	CSTB-3S	T-9F
41.01 - 44.00	FBH090408R-HF-P	SR14-560-HG	T-8F	FBM070404R-HF-I	SR14-560-HG	T-8F	FBM080408L-HF-C	SR14-560-HG	T-8F	GP08	CSTB-3S	T-9F
44.01 - 45.00	FBH090408R-HF-P	SR14-560-HG	T-8F	FBM070404R-G-I	SR14-560-HG	T-8F	FBM080408L-HF-C	SR14-560-HG	T-8F	GP08	CSTB-3S	T-9F
45.01 - 47.00	FBH090408R-HF-P	SR14-560-HG	T-8F	FBM080404R-G-I	SR14-560-HG	T-8F	FBM100408L-HF-C	SR14-560-HG	T-8F	GP10S	CSTB-3.5	T-15F
47.01 - 51.00	FBH110408R-HF-P	SR14-560-HG	T-8F	FBM080404R-HF-I	SR14-560-HG	T-8F	FBM100408L-HF-C	SR14-560-HG	T-8F	GP10S	CSTB-3.5	T-15F
51.01 - 54.00	FBH110408R-HF-P	SR14-560-HG	T-8F	FBM100404R-G-I	SR14-560-HG	T-8F	FBM100408L-G-C	SR14-560-HG	T-8F	GP10S	CSTB-3.5	T-15F
54.01 - 57.00	FBH110408R-HF-P	SR14-560-HG	T-8F	FBM100404R-HF-I	SR14-560-HG	T-8F	FBM130408L-G-C	SR14-560-HG	T-8F	GP10S	CSTB-3.5	T-15F
57.01 - 60.00	FBH130408R-HF-P	SR14-560-HG	T-8F	FBM100404R-G-I	SR14-560-HG	T-8F	FBM130408L-HF-C	SR14-560-HG	T-8F	GP12	CSTB-3.5	T-15F
60.01 - 64.00	FBH130408R-HF-P	SR14-560-HG	T-8F	FBM130404R-G-I	SR14-560-HG	T-8F	FBM130408L-G-C	SR14-560-HG	T-8F	GP12	CSTB-3.5	T-15F
64.01 - 65.00	FBH130408R-HF-P	SR14-560-HG	T-8F	FBM130404R-HF-I	SR14-560-HG	T-8F	FBM130408L-HF-C	SR14-560-HG	T-8F	GP12	CSTB-3.5	T-15F

G type chipbreaker	HF type chipbreaker
FBH060304R-G-P	FBH060308R-HF-P
FBH080404R-G-P	FBH080408R-HF-P
FBH090404R-G-P	FBH090408R-HF-P
FBH110404R-G-P	FBH110408R-HF-P
FBH130404R-G-P	FBH130408R-HF-P
FBM060304R-G-I	FBM060304R-HF-I
FBM070404R-G-I	FBM070404R-HF-I
FBM080404R-G-I	FBM080404R-HF-I
FBM100404R-G-I	FBM100404R-HF-I
FBM130404R-G-I	FBM130404R-HF-I
FBM060308L-G-C	FBM060308L-HF-C
FBM070408L-G-C	FBM070408L-HF-C
FBM080408L-G-C	FBM080408L-HF-C
FBM100408L-G-C	FBM100408L-HF-C
FBM130408L-G-C	FBM130408L-HF-C

Please see the page **J135 - J137** for the grades of inserts and guide pads.
 Drill heads come with clamping screws and wrenches but do not include inserts and guide pads.
 Please purchase inserts and guide pads separately.
 Recommended clamping torque (N·m): CSTB-2.2/CSTB-2.2S = 1, SR14-560-HG = 1.2, CSTB-3S = 2.3, CSTB-3.5 = 3.5

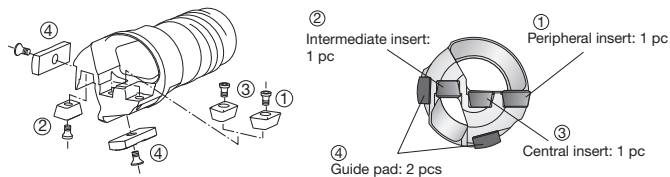

The designation of insert with G type and HF type is different, even in the same shape.
 Please refer to the table on the left to check the insert designation. Both inserts can be mounted on the drill head.

Reference pages: Inserts → **J135 - J136**, Guide pads → **J137**,
 Drill tube (DTS) → **J154**

INSERT

FBM-C (Central insert)

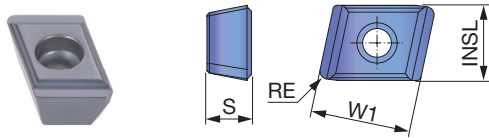

P	Steel	★	☆																
M	Stainless	★	☆																
K	Cast iron	★	☆																
N	Non-ferrous	★	☆																
S	Superalloys	★	☆																
H	Hard materials	★	☆																

★ : First choice
☆ : Second choice

Designation	INSL (in)	W1 (in)	Coated		S (in)	DCN (in)	DCX (in)	RE (in)
			AH725	AH8015				
FBM060308L-G-C	0.217	0.315	●		0.118	0.984	1.102	0.031
FBM060308L-HF-C	0.217	0.315	●	●	0.118	0.984	1.102	0.031
FBM070408L-G-C	0.256	0.394	●	●	0.157	1.106	1.378	0.031
FBM070408L-HF-C	0.256	0.394	●	●	0.157	1.106	1.378	0.031
FBM080408L-G-C	0.315	0.394	●	●	0.157	1.378	1.732	0.031
FBM080408L-HF-C	0.315	0.394	●	●	0.157	1.378	1.732	0.031
FBM100408L-G-C	0.374	0.394	●		0.157	1.733	2.126	0.031
FBM100408L-HF-C	0.374	0.394	●	●	0.157	1.733	2.126	0.031
FBM130408L-G-C	0.492	0.394	●		0.157	2.126	2.559	0.031
FBM130408L-HF-C	0.492	0.394	●	●	0.157	2.126	2.559	0.031

● : Line-up

FBM-I (Intermediate insert)

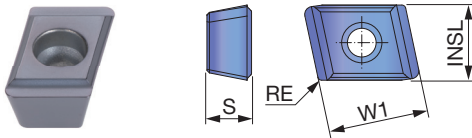

P	Steel	★	☆																
M	Stainless	★	☆																
K	Cast iron	★	☆																
N	Non-ferrous	★	☆																
S	Superalloys	★	☆																
H	Hard materials	★	☆																

★ : First choice
☆ : Second choice

Designation	INSL (in)	W1 (in)	Coated		S (in)	DCN (in)	DCX (in)	RE (in)
			AH725	AH8015				
FBM060304R-G-I	0.217	0.315	●	●	0.118	0.984	1.181	0.016
FBM060304R-HF-I	0.217	0.315	●	●	0.118	0.984	1.181	0.016
FBM070404R-G-I	0.256	0.394	●	●	0.157	1.181	1.614	0.016
FBM070404R-HF-I	0.256	0.394	●	●	0.157	1.181	1.614	0.016
FBM080404R-G-I	0.315	0.394	●		0.157	1.615	2.008	0.016
FBM080404R-HF-I	0.315	0.394	●	●	0.157	1.615	2.008	0.016
FBM100404R-G-I	0.374	0.394	●		0.157	2.008	2.520	0.016
FBM100404R-HF-I	0.374	0.394	●	●	0.157	2.008	2.520	0.016
FBM130404R-G-I	0.492	0.394	●		0.157	2.520	2.559	0.016
FBM130404R-HF-I	0.492	0.394	●	●	0.157	2.520	2.559	0.016

● : Line-up

Grade
Insert
Toolholder
Ext. Toolholder
Int. Toolholder
Threading
Grooving
Miniature Tool
Endmill
Drilling Tool
Tooling System
User's Guide
Index



FBH-P (Peripheral insert)

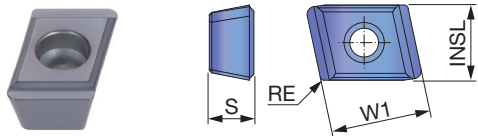

P	Steel	★	☆	☆	☆
M	Stainless	★	☆	☆	☆
K	Cast iron	★	☆	☆	☆
N	Non-ferrous	★	☆	☆	☆
S	Superalloys	★	☆	☆	☆
H	Hard materials	★	☆	☆	☆

★ : First choice
 ☆ : Second choice

Designation	INSL (in)	W1 (in)	Coated				S (in)	DCN (in)	DCX (in)	RE (in)
			AH725	UC3120	AH8015	AH3135				
FBH060304R-G-P	0.236	0.315	●	●			0.118	0.984	1.181	0.016
FBH060308R-G-P	0.236	0.315	●		●	●	0.118	1.103	1.181	0.031
FBH060308R-HF-P	0.236	0.315	●		●		0.118	0.984	1.181	0.031
FBH080404R-G-P	0.295	0.394	●	●			0.157	1.181	1.496	0.016
FBH080408R-G-P	0.295	0.394	●		●	●	0.157	1.181	1.496	0.031
FBH080408R-HF-P	0.295	0.394	●		●		0.157	1.181	1.496	0.031
FBH090404R-G-P	0.354	0.394	●	●			0.157	1.496	1.850	0.016
FBH090408R-G-P	0.354	0.394	●		●	●	0.157	1.496	1.575	0.031
FBH090408R-HF-P	0.354	0.394	●		●		0.157	1.496	1.850	0.031
FBH110404R-G-P	0.433	0.394	●				0.157	1.851	2.362	0.016
FBH110408R-HF-P	0.433	0.394	●		●		0.157	1.851	2.362	0.031
FBH130404R-G-P	0.512	0.394	●				0.157	2.363	2.559	0.016
FBH130408R-HF-P	0.512	0.394	●		●		0.157	2.363	2.559	0.031

● : Line-up

ISO classifications for Insert grades

	Grade	(Former name)	ISO area								
			5	10	15	20	25	30	35	40	
P	AH8015	-									
	AH725	(UC2220)									
M	AH8015	-									
	AH725	(UC2220)									
K	AH8015	-									
	AH725	(UC2220)									
N	AH8015	-									
	AH725	(UC2220)									
S	AH8015	-									
	AH725	(UC2220)									

GUIDE PAD

GP06, 07, 08, 10S, 12

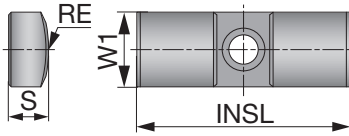

P	Steel	☆	☆	★	☆
M	Stainless	☆	☆	★	☆
K	Cast iron	☆	☆	★	☆
N	Non-ferrous	☆	☆	★	☆
S	Superalloys	☆	☆	★	☆
H	Hard materials	☆	☆	★	☆

★ : First choice
☆ : Second choice

Designation	DCN (in)	DCX (in)	Coated				W1 (in)	INSL (in)	S (in)	RE (in)
			F1122	F2122	FH3125	FH3135				
GP06	0.984	1.181	●	▲			0.236	0.787	0.118	0.472
GP06-20-120-DC	0.984	1.181			●	●	0.236	0.787	0.118	0.472
GP07	1.181	1.535	●	▲			0.276	0.787	0.138	0.472
GP07-20-120-DC	1.181	1.535			●	●	0.276	0.787	0.138	0.472
GP08	1.536	1.772	●	▲			0.315	0.984	0.177	0.610
GP08-25-155-DC	1.536	1.772			●	●	0.315	0.984	0.177	0.610
GP10S	1.772	2.244	●	▲			0.394	1.181	0.177	0.787
GP10-30-200-DC	1.772	2.244			●	●	0.394	1.181	0.177	0.787
GP12	2.244	2.559	●	▲			0.472	1.378	0.217	0.984
GP12-35-250-DC	2.244	2.559			●	●	0.472	1.378	0.217	0.984

All of the above guide pads are finished with coating.

● : Line up
▲ : To be discontinued
Package quantity = 5 pcs.

REPLACING GUIDE PADS

Guide pads are subject to wear, like inserts

- The guide pad has two sides.
- Each guide pad can be used on two sides. When the first corner wears out to 70% of the width, reverse the guide pad to use the second side.
- Replace with a new guide pad when the second side wears out.

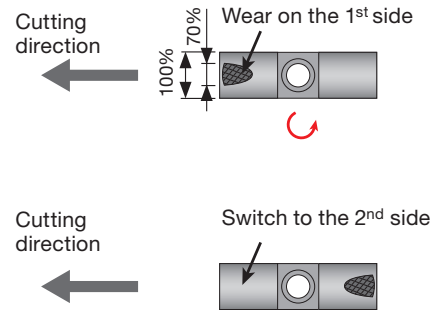
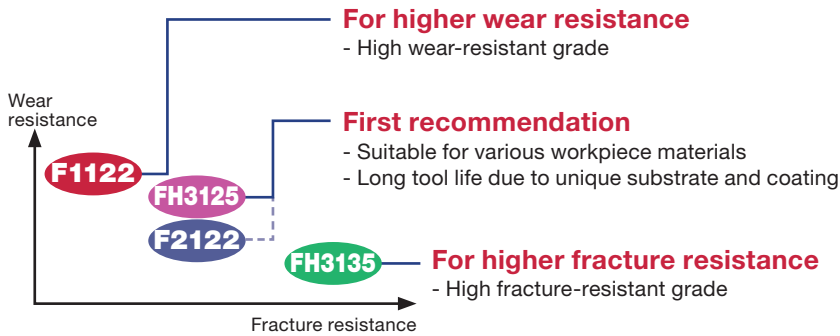

NOTE FOR MOUNTING A DRILL HEAD

Please be sure to use a wrench for a drill head to be clamped firmly.

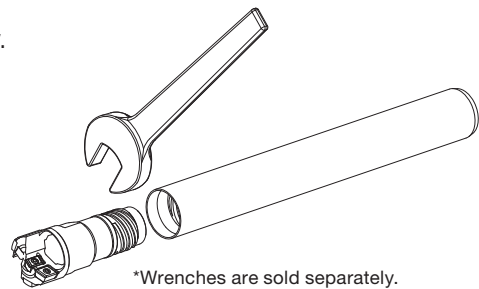

*Wrenches are sold separately.

UNIDEX

UNIDEX STS-EX

Indexable drill head with external 4-start thread for single tube system (STS), diameters adjustable, tool diameter $\varnothing 38.00 - \varnothing 106.99$ mm (1.496" - 4.212")

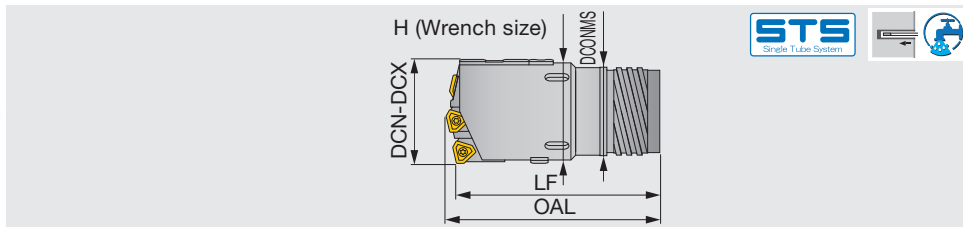

Metric	DCN		DCX		CICT	Drill tube			Drill head		
	(in)	(mm)	(in)	(mm)		Designation	Dia. (mm)	OAL	LF	DCONMS	H
KUSTS07E-xx.xx	1.496	38	1.559	39.6	3	ST07	33	90	85	30	37
KUSTS08E-xx.xx	1.559	39.61	1.693	43	3	ST08	36	91	85	33	40
KUSTS09E-xx.xx	1.693	43.01	1.850	47	3	ST09	39	101	95	36	43
KUSTS10E-xx.xx	1.851	47.01	2.035	51.7	3	ST10	43	102	95	39	48
KUSTS11E-xx.xx	2.036	51.71	2.213	56.2	3	ST11	47	107	100	43	52
KUSTS12E-xx.xx	2.213	56.21	2.386	60.6	3	ST12	51	118	110	47	57
KUSTS13E-xx.xx	2.386	60.61	2.559	65	3	ST13	56	119	110	51	61
KUSTS14E-xx.xx	2.559	65	2.637	66.99	3	ST14	56	159	150	52	63
KUSTS15E-xx.xx	2.638	67	2.874	72.99	3	ST15	62	159	150	58	69
KUSTS16E-xx.xx	2.874	73	3.149	79.99	3	ST16	68	160	150	63	76
KUSTS17E-xx.xx	3.150	80	3.425	86.99	3	ST17	75	191	180	70	83
KUSTS18E-xx.xx	3.425	87	3.937	99.99	3	ST18	82	193	180	77	96
KUSTS19E-xx.xx	3.937	100	4.212	106.99	3	ST19	94	193	180	89	102

e.g. Designation for tool diameter $\varnothing 60$ mm: KUSTS12E-60.00
Drill heads with the diameter $\varnothing 92$ mm or over have a top guide pocket.
Adjusting diameters has to be required before using.

UNIDEX

UNIDEX STS-IN

Indexable drill head with internal single-start thread for single tube system (STS), diameters adjustable, tool diameter $\varnothing 38.00 - \varnothing 106.99$ mm (1.496" - 4.212")

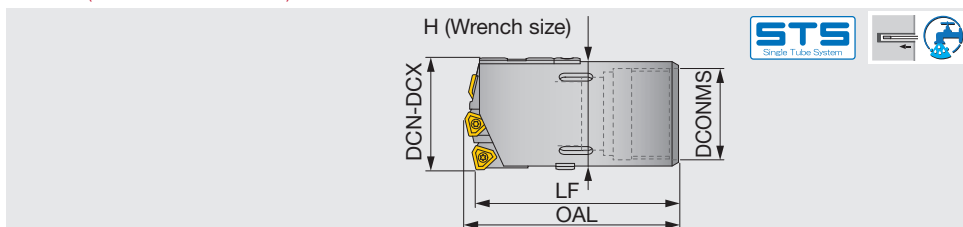

Metric	DCN		DCX		CICT	Drill tube			Drill head		
	(in)	(mm)	(in)	(mm)		Designation	Dia. (mm)	OAL	LF	DCONMS	H
KUSTS33-xx.xx	1.496	38	1.574	39.99	3	UB33	33	85	80	30	37
KUSTS36-xx.xx	1.575	40	1.732	43.99	3	UB36	36	86	80	33	41
KUSTS39-xx.xx	1.732	44	1.850	46.99	3	UB39	39	96	90	37	43
KUSTS43-xx.xx	1.850	47	2.047	51.99	3	UB43	43	97	90	41	48
KUSTS47-xx.xx	2.047	52	2.244	56.99	3	UB47	47	107	100	44	53
KUSTS51-xx.xx	2.244	57	2.401	60.99	3	UB51	51	118	110	49	57
KUSTS56-xx.xx	2.402	61	2.677	67.99	3	UB56	56	119	110	53	64
KUSTS62-xx.xx	2.677	68	2.952	74.99	3	UB62	62	129	120	59	71
KUSTS68-xx.xx	2.953	75	3.189	80.99	3	UB68	68	161	150	65	77
KUSTS75-xx.xx	3.189	81	3.582	90.99	3	UB75	75	162	150	71	87
KUSTS82-xx.xx	3.583	91	3.897	98.99	3	UB82	82	162	150	79	95
KUSTS94-xx.xx	3.898	99	4.212	106.99	3	UB94	94	163	150	90	102

e.g. Designation for tool diameter $\varnothing 60$ mm: KUSTS51-60.00
Drill heads with the diameter $\varnothing 92$ mm or over have a top guide pocket.
Adjusting diameters has to be required before using.

Reference pages: UNIDEX STS-EX: Inserts → **J142**, Standard cutting conditions → **J143**, Drill tube (STS) → **J150**
UNIDEX STS-IN: Inserts → **J142**, Standard cutting conditions → **J143**, Drill tube (STS) → **J152**
Screw, Guide pad → **J141**

SPARE PARTS



Tool diameter DCN-DCX (mm)	Cartridge			Guide pad							
	Peripheral	Intermediate	Central	Guide pad		Filler		Protector		Sub guide pad	
	Cartridge①	Cartridge②	Cartridge③	④	Qty.	⑤	Qty.	⑥	Qty.	⑦	Qty.
38 - 39.99	OZ05R	IOZ05R	IOZ05R	GP08	2	-	-	GPT08	2	CUG08	1
40 - 44.99	OZ402 - 04	IOZ05R	IOZ05R	GP08	2	-	-	GPT08	2	CUG08	1
45 - 47.99	OZ402 - 04	IOZ05R	IOZ402 - 04	GP10	2	-	-	GPT10	2	CUG08	1
48 - 51.99	OZ402 - 04	IOZ402 - 04	IOZ402 - 04	GP10	2	-	-	GPT10	2	CUG08	1
52 - 54.99	OZ402 - 32	IOZ402 - 04	IOZ402 - 04	GP10	2	-	-	GPT10	2	CUG08	1
55 - 57.99	OZ402 - 32	IOZ402 - 04	IOZ402 - 32	GP10	2	-	-	GPT10	2	CUG08	1
58 - 59.99	OZ402 - 32	IOZ402 - 32	IOZ402 - 32	GP10	2	-	-	GPT10	2	CUG08	1
60 - 63.99	OZ402 - 32	IOZ402 - 32	IOZ402 - 32	GP14	2	-	-	GPT14	2	CUG08	1
64 - 67.99	OZ402 - 43	IOZ402 - 32	IOZ402 - 32	GP14	2	-	-	GPT14	2	CUG10	1
68 - 77.99	OZ402 - 32	IOZ402 - 43	IOZ402 - 43	GP14	2	-	-	GPT14	2	CUG10	1
78 - 84.99	OZ402 - 43	IOZ402 - 43	IOZ402 - 43	GP14	2	-	-	GPT14	2	CUG10	1
85 - 91.99	OZ402 - 63	IOZ402 - 43	IOZ402 - 43	GP14	2	-	-	GPT14	2	CUG10	1
92 - 98.99	OZ402 - 43	IOZ402 - 63	IOZ402 - 63	GP14	2	FILLER14	1	GPT14	2	CUG10	1
99 - 106.99	OZ402 - 63	IOZ402 - 63	IOZ402 - 63	GP18	2	FL18 - M	1	GPT18 - M	2	CUG14 - M	1

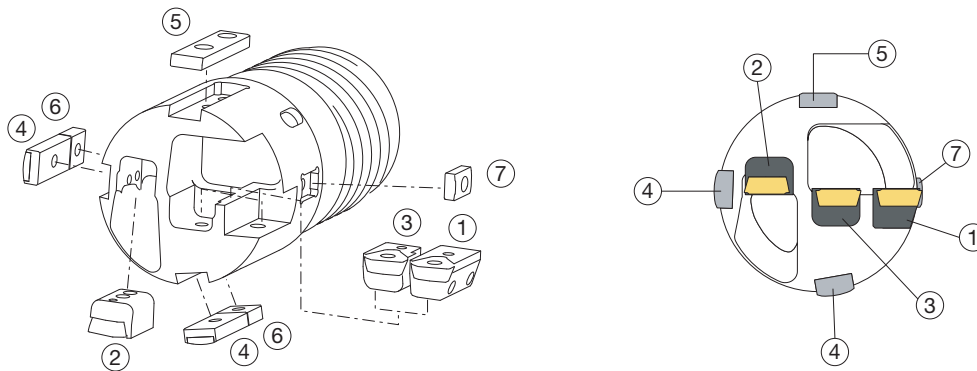

* Depending on tool diameters, parts may not be positioned as shown in the above.

INSERT

Tool diameter DCN-DCX (mm)	Peripheral insert			Intermediate insert			Central insert		
	New	Conventional	Qty.	New	Conventional	Qty.	New	Conventional	Qty.
	38 - 39.99	NPMX08**R...	508 - 05R	1	NPMX08**R...	508 - 05R	1	NPMX08**R...	508 - 05R
40 - 44.99	TPMX14**R...	1123 - 04R	1	NPMX08**R...	508 - 05R	1	NPMX08**R...	508 - 05R	1
45 - 47.99	TPMX14**R...	1123 - 04R	1	NPMX08**R...	508 - 05R	1	TPMX14**R...	1123 - 04R	1
48 - 51.99	TPMX14**R...	1123 - 04R	1	TPMX14**R...	1123 - 04R	1	TPMX14**R...	1123 - 04R	1
52 - 54.99	TPMX17**R...	1123 - 32R	1	TPMX14**R...	1123 - 04R	1	TPMX14**R...	1123 - 04R	1
55 - 57.99	TPMX17**R...	1123 - 32R	1	TPMX14**R...	1123 - 04R	1	TPMX17**R...	1123 - 32R	1
58 - 59.99	TPMX17**R...	1123 - 32R	1	TPMX17**R...	1123 - 32R	1	TPMX17**R...	1123 - 32R	1
60 - 63.99	TPMX17**R...	1123 - 32R	1	TPMX17**R...	1123 - 32R	1	TPMX17**R...	1123 - 32R	1
64 - 67.99	TPMX24**R...	1123 - 43R	1	TPMX17**R...	1123 - 32R	1	TPMX17**R...	1123 - 32R	1
68 - 77.99	TPMX17**R...	1123 - 32R	1	TPMX24**R...	1123 - 43R	1	TPMX24**R...	1123 - 43R	1
78 - 84.99	TPMX24**R...	1123 - 43R	1	TPMX24**R...	1123 - 43R	1	TPMX24**R...	1123 - 43R	1
85 - 91.99	TPMX28**R...	1123 - 63R	1	TPMX24**R...	1123 - 43R	1	TPMX24**R...	1123 - 43R	1
92 - 98.99	TPMX24**R...	1123 - 43R	1	TPMX28**R...	1123 - 63R	1	TPMX28**R...	1123 - 63R	1
99 - 106.99	TPMX28**R...	1123 - 63R	1	TPMX28**R...	1123 - 63R	1	TPMX28**R...	1123 - 63R	1

The tool diameter can be increased up to 5 mm using the plus (+) spare parts. (The expansion allowance depends on tool diameters.)
Drill heads come with cartridge, guide pad, filler, protector, sub guide pad, and wrench, but do not include inserts.

Grade
Insert
Ext. Toolholder
Int. Toolholder
Threading
Grooving
Miniature Tool
Endmill
Drilling Tool
Tooling System
Index



Indexable drill head with external 4-start thread for double tube system (DTS), diameters adjustable, tool diameter $\varnothing 38 - \varnothing 106.99$ mm (1.496" - 4.212")

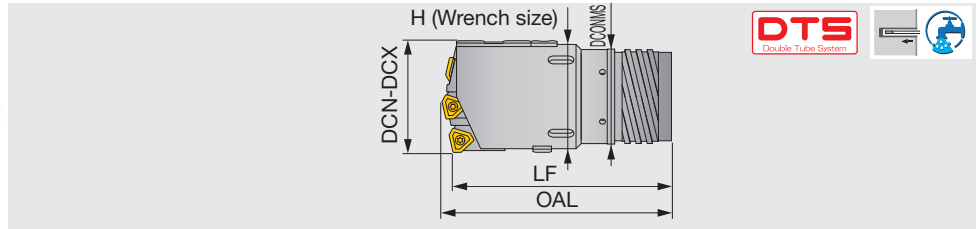

Metric	DCN		DCX		CICT	Drill tube		Drill head			
	(in)	(mm)	(in)	(mm)		Designation	Dia. (mm)	OAL	LF	DCONMS	H
KUDTS08E-xx.xx	1.496	38	1.559	39.6	3	OT08	35.5	90	85	33	37
KUDTS09E-xx.xx	1.559	39.61	1.693	43	3	OT09	39	91	85	36	40
KUDTS10E-xx.xx	1.693	43.01	1.850	47	3	OT10	42.5	101	95	39	43
KUDTS11E-xx.xx	1.851	47.01	2.035	51.7	3	OT11	46.5	102	100	43	48
KUDTS12E-xx.xx	2.036	51.71	2.213	56.2	3	OT12	51	107	100	47	52
KUDTS13E-xx.xx	2.213	56.21	2.559	65	3	OT13	55.5	119	110	51	61
KUDTS14E-xx.xx	2.559	65	2.637	66.99	3	OT14	56	159	150	52	63
KUDTS15E-xx.xx	2.638	67	2.874	72.99	3	OT15	62	159	150	58	69
KUDTS16E-xx.xx	2.874	73	3.149	79.99	3	OT16	68	160	150	63	76
KUDTS17E-xx.xx	3.150	80	3.425	86.99	3	OT17	75	191	180	70	83
KUDTS18E-xx.xx	3.425	87	3.937	99.99	3	OT18	82	193	180	77	96
KUDTS19E-xx.xx	3.937	100	4.212	106.99	3	OT19	94	193	180	89	102

e.g. Designation for tool diameter $\varnothing 60$ mm: KUDTS13E-60.00
 Drill heads with the diameter $\varnothing 92$ mm or over have a top guide pocket.
 Adjusting diameters has to be required before using.

SPARE PARTS

Tool diameter DCN-DCX (mm)	Cartridge			Guide pad							
	Peripheral	Intermediate	Central	Guide pad		Filler		Protector		Sub guide pad	
	Cartridge ①	Cartridge ②	Cartridge ③	④	Qty.	⑤	Qty.	⑥	Qty.	⑦	Qty.
38 - 39.99	OZ05R	IOZ05R	IOZ05R	GP08	2	-	-	GPT08	2	CUG08	1
40 - 44.99	OZ402 - 04	IOZ05R	IOZ05R	GP08	2	-	-	GPT08	2	CUG08	1
45 - 47.99	OZ402 - 04	IOZ05R	IOZ402 - 04	GP10	2	-	-	GPT10	2	CUG08	1
48 - 51.99	OZ402 - 04	IOZ402 - 04	IOZ402 - 04	GP10	2	-	-	GPT10	2	CUG08	1
52 - 54.99	OZ402 - 32	IOZ402 - 04	IOZ402 - 04	GP10	2	-	-	GPT10	2	CUG08	1
55 - 57.99	OZ402 - 32	IOZ402 - 04	IOZ402 - 32	GP10	2	-	-	GPT10	2	CUG08	1
58 - 59.99	OZ402 - 32	IOZ402 - 32	IOZ402 - 32	GP10	2	-	-	GPT10	2	CUG08	1
60 - 63.99	OZ402 - 32	IOZ402 - 32	IOZ402 - 32	GP14	2	-	-	GPT14	2	CUG08	1
64 - 67.99	OZ402 - 43	IOZ402 - 32	IOZ402 - 32	GP14	2	-	-	GPT14	2	CUG10	1
68 - 77.99	OZ402 - 32	IOZ402 - 43	IOZ402 - 43	GP14	2	-	-	GPT14	2	CUG10	1
78 - 84.99	OZ402 - 43	IOZ402 - 43	IOZ402 - 43	GP14	2	-	-	GPT14	2	CUG10	1
85 - 91.99	OZ402 - 63	IOZ402 - 43	IOZ402 - 43	GP14	2	-	-	GPT14	2	CUG10	1
92 - 98.99	OZ402 - 43	IOZ402 - 63	IOZ402 - 63	GP14	2	FILLER14	1	GPT14	2	CUG10	1
99 - 106.99	OZ402 - 63	IOZ402 - 63	IOZ402 - 63	GP18	2	FL18 - M	1	GPT18 - M	2	CUG14 - M	1

Filler is to protect a top guide pocket and included in the drill heads with $\varnothing 92$ mm or over.

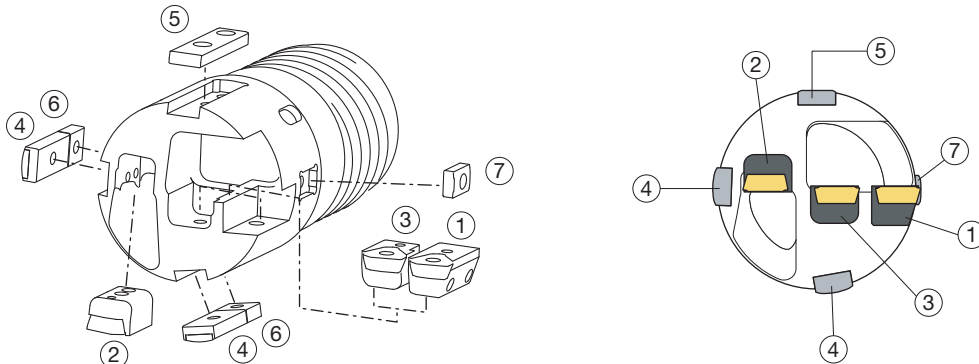

* Depending on tool diameters, parts may not be positioned as shown in the above.

Reference pages: Inserts → **J142**, Standard cutting conditions → **J143**, Drill tube (DTS) → **J154**
 Screw, Guide pad → **J141**

INSERT

Tool diameter DCN-DCX (mm)	Peripheral insert		Qty.	Intermediate insert		Qty.	Central insert		Qty.
	New	Conventional		New	Conventional		New	Conventional	
38 - 39.99	NPMX08**R...	508 - 05R	1	NPMX08**R...	508 - 05R	1	NPMX08**R...	508 - 05R	1
40 - 44.99	TPMX14**R...	1123 - 04R	1	NPMX08**R...	508 - 05R	1	NPMX08**R...	508 - 05R	1
45 - 47.99	TPMX14**R...	1123 - 04R	1	NPMX08**R...	508 - 05R	1	TPMX14**R...	1123 - 04R	1
48 - 51.99	TPMX14**R...	1123 - 04R	1	TPMX14**R...	1123 - 04R	1	TPMX14**R...	1123 - 04R	1
52 - 54.99	TPMX17**R...	1123 - 32R	1	TPMX14**R...	1123 - 04R	1	TPMX14**R...	1123 - 04R	1
55 - 57.99	TPMX17**R...	1123 - 32R	1	TPMX14**R...	1123 - 04R	1	TPMX17**R...	1123 - 32R	1
58 - 59.99	TPMX17**R...	1123 - 32R	1	TPMX17**R...	1123 - 32R	1	TPMX17**R...	1123 - 32R	1
60 - 63.99	TPMX17**R...	1123 - 32R	1	TPMX17**R...	1123 - 32R	1	TPMX17**R...	1123 - 32R	1
64 - 67.99	TPMX24**R...	1123 - 43R	1	TPMX17**R...	1123 - 32R	1	TPMX17**R...	1123 - 32R	1
68 - 77.99	TPMX17**R...	1123 - 32R	1	TPMX24**R...	1123 - 43R	1	TPMX24**R...	1123 - 43R	1
78 - 84.99	TPMX24**R...	1123 - 43R	1	TPMX24**R...	1123 - 43R	1	TPMX24**R...	1123 - 43R	1
85 - 91.99	TPMX28**R...	1123 - 63R	1	TPMX24**R...	1123 - 43R	1	TPMX24**R...	1123 - 43R	1
92 - 98.99	TPMX24**R...	1123 - 43R	1	TPMX28**R...	1123 - 63R	1	TPMX28**R...	1123 - 63R	1
99 - 106.99	TPMX28**R...	1123 - 63R	1	TPMX28**R...	1123 - 63R	1	TPMX28**R...	1123 - 63R	1

The tool diameter can be increased up to 5 mm using the plus (+) spare parts. (The expansion allowance depends on tool diameters.)
Drill heads come with cartridge, guide pad, filler, protector, sub guide pad, and wrench, but do not include inserts.

SCREW

Tool diameter DCN - DCX (mm)	Insert						Guide pad					
	Peripheral		Intermediate		Central		Guide pad/Filler		Protector		Sub guide pad	
	Screw	Wrench	Screw	Wrench	Screw	Wrench	Screw	Wrench	Screw	Wrench	Screw	Wrench
38 - 39.99	CSTB-2.2	T-7D	CSTB-2.2	T-7D	CSTB-2.2	T-7D	CSTB-3S	T-9D	CSTB-3S	T-9D	CSTB-3S	T-9D
40 - 44.99	CSTB-2.5	T-8D	CSTB-2.2	T-7D	CSTB-2.2	T-7D	CSTB-3S	T-9D	CSTB-3S	T-9D	CSTB-3S	T-9D
45 - 47.99	CSTB-2.5	T-8D	CSTB-2.2	T-7D	CSTB-2.5	T-8D	CSTB-4S	T-15D	CSTB-4S	T-15D	CSTB-3S	T-9D
48 - 51.99	CSTB-2.5	T-8D	CSTB-2.5	T-8D	CSTB-2.5	T-8D	CSTB-4S	T-15D	CSTB-4S	T-15D	CSTB-3S	T-9D
52 - 54.99	CSTB-3.5D	T-9D	CSTB-2.5	T-8D	CSTB-2.5	T-8D	CSTB-4S	T-15D	CSTB-4S	T-15D	CSTB-3S	T-9D
55 - 57.99	CSTB-3.5D	T-9D	CSTB-2.5	T-8D	CSTB-3.5D	T-9D	CSTB-4S	T-15D	CSTB-4S	T-15D	CSTB-3S	T-9D
58 - 59.99	CSTB-3.5D	T-9D	CSTB-3.5D	T-9D	CSTB-3.5D	T-9D	CSTB-4S	T-15D	CSTB-4S	T-15D	CSTB-3S	T-9D
60 - 63.99	CSTB-3.5D	T-9D	CSTB-3.5D	T-9D	CSTB-3.5D	T-9D	CSTB-4S	T-15D	CSTB-4S	T-15D	CSTB-3S	T-9D
64 - 67.99	CSTB-4M	T-15D	CSTB-3.5D	T-9D	CSTB-3.5D	T-9D	CSTA-5S	T-15D	CSTA-5S	T-15D	CSTB-3S	T-9D
68 - 77.99	CSTB-3.5D	T-9D	CSTB-4M	T-15D	CSTB-4M	T-15D	CSTA-5S	T-15D	CSTA-5S	T-15D	CSTB-3S	T-9D
78 - 84.99	CSTB-4M	T-15D	CSTB-4M	T-15D	CSTB-4M	T-15D	CSTA-5S	T-15D	CSTA-5S	T-15D	CSTB-3S	T-9D
85 - 91.99	CSTB-5	T-20D	CSTB-4M	T-15D	CSTB-4M	T-15D	CSTA-5S	T-15D	CSTA-5S	T-15D	CSTB-3S	T-9D
92 - 98.99	CSTB-4M	T-15D	CSTB-5	T-20D	CSTB-5	T-20D	CSTA-5S	T-15D	CSTA-5S	T-15D	CSTB-3S	T-9D
99 - 106.99	CSTB-5	T-20D	CSTB-5	T-20D	CSTB-5	T-20D	LS1206S	H3	LS1206S	H3	CSTA-5S	T-15D

SCREW

Tool diameter DCN - DCX (mm)	Cartridge screws							
	Peripheral				Intermediate		Central	
	Screw	Wrench	Adjustable screw	Wrench	Screw	Wrench	Screw	Wrench
38 - 39.99	LS1803RH	H2	AS0003-5	H1.5	CSTB-3	T-9D	CSTB-3	T-9D
40 - 44.99	LS1803.5RH	H2.5	AS0004-8	H2	CSTB-3	T-9D	CSTB-3	T-9D
45 - 47.99	LS1803.5RH	H2.5	AS0004-8	H2	CSTB-3	T-9D	CSTB-3.5	T-9D
48 - 51.99	LS1803.5RH	H2.5	AS0004-8	H2	CSTB-3.5	T-15D	CSTB-3.5	T-15D
52 - 54.99	LS1805RH	H3	AS0005-10	H2.5	CSTB-3.5	T-15D	CSTB-3.5	T-15D
55 - 57.99	LS1805RH	H3	AS0005-10	H2.5	CSTB-3.5	T-15D	CSTA-5	T-15D
58 - 59.99	LS1805RH	H3	AS0005-10	H2.5	CSTA-5	T-15D	CSTA-5	T-15D
60 - 63.99	LS1805RH	H3	AS0005-10	H2.5	CSTA-5	T-15D	CSTA-5	T-15D
64 - 67.99	LS1806RH	H4	AS0005-15	H2.5	CSTA-5	T-15D	CSTA-5	T-15D
68 - 77.99	LS1805RH	H3	AS0005-10	H2.5	LS1206	H3	LS1206	H3
78 - 84.99	LS1806RH	H4	AS0005-15	H2.5	LS1206	H3	LS1206	H3
85 - 91.99	LS1806RH	H4	AS0006-15	H3	LS1206	H3	LS1206	H3
92 - 98.99	LS1806RH	H4	AS0005-15	H2.5	LS1206	H3	LS1206S	H3
99 - 106.99	LS1806RH	H4	AS0006-15	H3	LS1206	H3	LS1206S	H3

Guide pads and protectors



Guide pad	Dimensions (in)	Lock screw	Wrench	Protector	Dimensions (in)	Lock screw	Wrench
	W H L				W H		
GP08	0.315 0.177 0.984	CSTB-3S	T-9D	GPT08	0.315 0.177	CSTB-3S	T-9D
GP08-25-155-DC	0.315 0.177 0.984	CSTB-3S	T-9D	GPT08	0.315 0.177	CSTB-3S	T-9D
GP10	0.394 0.236 1.378	CSTB-4S	T-15D	GPT10	0.394 0.236	CSTB-4S	T-15D
GP10-35-200-DC	0.394 0.236 1.378	CSTB-4S	T-15D	GPT10	0.394 0.236	CSTB-4S	T-15D
GP14	0.551 0.295 1.575	CSTA-5S	T-15D	GPT14	0.551 0.295	CSTA-5S	T-15D
GP14-40-250-DC	0.551 0.295 1.575	CSTA-5S	T-15D	GPT14	0.551 0.295	CSTA-5S	T-15D
GP18	0.709 0.354 1.575	LS1206S / LS1206SSS ***	H3	GPT18-M	0.709 0.354	LS1206S	H3
GP18-40-300-DC	0.709 0.354 1.575	LS1206S / LS1206SSS ***	H3	GPT18-M	0.709 0.354	LS1206S	H3

***LS1206SSS for dimensional guide pad
(for diameter ϕ 118.00 - ϕ 150.99, ϕ 169.00 - ϕ 208.99 and ϕ 233.00 - ϕ 247.99 mm)

● : Line up, ▲ : To be discontinued
Package quantity = 5 pcs.

Grade
Insert
Toolholder
Ext. Toolholder
Int. Toolholder
Threading
Grooving
Miniature Tool
Milling Cutter
Endmill
Drilling Tool
Tooling System
User's Guide
Index

INSERT

NPMX..., TPMX.../508-05R..., 1123_**R...

TPMX type (New)
1123 type (Conventional)

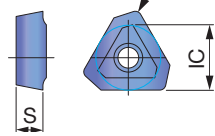

NPMX type (New)
508 type (Conventional)

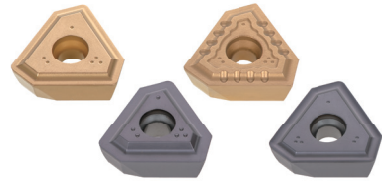
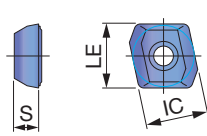

Right-hand type

Metric		Chipbreaker		AH8015	UC1220 (DLX2)	UC1125 (DLXT)	UC1230 (DLX3)	UC3215 (KLX2)	UC3210 (KLXT3)	UC2220 (NLX)	UC3120 (KLXT)	IC (in)	S (in)	R (in)	LE (in)
New	Conventional	New	Conventional												
NPMX080308R-G	508-05R	G	-									0.315	0.125	-	0.329
NPMX080304R-B	508-05RBR1	B	BR1									0.315	0.125	-	0.329
TPMX140308R-G	-	G	-									0.333	0.138	0.031	-
TPMX140304R-B	-	B	-									0.333	0.138	0.031	-
TPMX140304R-B	1123-04R	G	-									0.333	0.138	0.031	-
TPMX140304R-B	-	B	-									0.333	0.138	0.031	-
TPMX140304R-B	1123-04RBR1	B	BR1									0.333	0.138	0.016	-
TPMX140308R-DT	1123-04RS	DT	S									0.333	0.138	0.031	-
TPMX170408R-G	-	G	-									0.406	0.157	0.031	-
TPMX170408R-G	1123-32R	G	-									0.406	0.157	0.031	-
TPMX170404R-B	-	B	-									0.406	0.157	0.031	-
TPMX170404R-B	1123-32RBR1	B	BR1									0.406	0.157	0.016	-
TPMX170408R-BG	-	BG	-									0.406	0.157	0.031	-
TPMX170408R-BG	1123-32RB	BG	B									0.406	0.157	0.031	-
TPMX170408R-DT	1123-32RS	DT	S									0.406	0.157	0.031	-
TPMX240512R-G	-	G	-									0.559	0.217	0.047	-
TPMX240512R-G	1123-43R	G	-									0.559	0.217	0.047	-
TPMX240504R-B	-	B	-									0.559	0.217	0.047	-
TPMX240504R-B	1123-43RBR1	B	BR1									0.559	0.217	0.016	-
TPMX240512R-BG	-	BG	-									0.559	0.217	0.047	-
TPMX240512R-BG	1123-43RB	BG	B									0.559	0.217	0.047	-
TPMX240512R-DT	1123-43RS	DT	S									0.559	0.217	0.047	-
TPMX280716R-G	-	G	-									0.669	0.295	0.063	-
TPMX280716R-G	1123-63R	G	-									0.669	0.295	0.063	-
TPMX280708R-B	-	B	-									0.669	0.295	0.063	-
TPMX280708R-B	1123-63RBR1	B	BR1									0.669	0.295	0.031	-
TPMX280716R-BG	-	BG	-									0.669	0.295	0.063	-
TPMX280716R-BG	1123-63RB	BG	B									0.669	0.295	0.063	-
TPMX280716R-DT	1123-63RS	DT	S									0.669	0.295	0.063	-

● : Line up

Left-hand type

Metric		Chipbreaker		AH8015	UC1220 (DLX2)	UC1125 (DLXT)	UC1230 (DLX3)	UC3215 (KLX2)	UC3210 (KLXT3)	UC2220 (NLX)	UC3120 (KLXT)	IC (in)	S (in)	R (in)	LE (in)
New	Conventional	New	Conventional												
TPMX140308L-G	1123-04L	G	-									0.333	0.138	0.031	-
TPMX170408L-G	1123-32L	G	-									0.406	0.157	0.031	-
TPMX170408L-BG	1123-32LB	BG	B									0.406	0.157	0.031	-
TPMX170408L-DT	1123-32LS	DT	S									0.406	0.157	0.031	-
TPMX240512L-G	1123-43L	G	-									0.559	0.217	0.047	-
TPMX240512L-BG	1123-43LB	BG	B									0.559	0.217	0.047	-
TPMX240512L-DT	1123-43LS	DT	S									0.559	0.217	0.047	-
TPMX280716L-G	1123-63L	G	-									0.669	0.295	0.063	-
TPMX280716L-BG	1123-63LB	BG	B									0.669	0.295	0.063	-

● : Line up

Chipbreaker

<p>G (New)</p> <p>Versatile</p>	<p>B (New) BR1 (Conventional)</p> <p>Good chip control for heat-resistant alloy</p>
<p>BG (New) B (Conventional)</p> <p>Good chip control for difficult-to-cut steel</p>	<p>DT (New) S (Conventional)</p> <p>Reduced cutting force</p>

*Difficult-to-cut steel: Material that tends to produce long chips

ISO classifications for Insert grades

● : Line up

	Grade	(Former name)	ISO area												
			5	10	15	20	25	30	35	40					
P	AH8015	-													
	UC1220 (DLX2)														
	UC2220 (NLX)														
	UC1125 (DLXT)														
	UC1230 (DLX3)														
M	UC3120 (KLXT)														
	AH8015	-													
	UC2220 (NLX)														
K	UC1230 (DLX3)														
	UC3120 (KLXT)														
	AH8015	-													
N	UC3215 (KLX2)														
	UC3120 (KLXT)														
S	AH8015	-													
	UC3210 (KLXT3)														
	UC2220 (NLX)														
	UC3120 (KLXT)														
	UC1230 (DLX3)														

STANDARD CUTTING CONDITIONS

ISO	Workpiece materials		Hardness (HB)	Cutting speed Vc (sfm)	Feed: fn (in/rev)						
					Drill dia. (in)						
P	Carbon steels Casting steels High carbon steels Carbon tool steels	1010 - 1025	0.10 - 0.25%C Non-hardened	125	197 - 394	0.003 - 0.006	0.004 - 0.008	0.005 - 0.009	0.006 - 0.010	0.007 - 0.012	
		1025 - 1055	0.25 - 0.25%C Non-hardened	190	197 - 394	0.003 - 0.006	0.004 - 0.008	0.005 - 0.009	0.006 - 0.010	0.007 - 0.012	
			0.25 - 0.25%C Hardened and tempered	250	197 - 394	0.003 - 0.006	0.004 - 0.008	0.005 - 0.009	0.006 - 0.010	0.007 - 0.012	
		SK	0.55 - 0.80%C Non-hardened	220	197 - 394	0.003 - 0.006	0.004 - 0.008	0.005 - 0.009	0.006 - 0.010	0.007 - 0.012	
	0.55 - 0.80%C Hardened and tempered		300	197 - 394	0.003 - 0.006	0.004 - 0.008	0.005 - 0.009	0.006 - 0.010	0.007 - 0.012		
	Low alloy steels Casting steels (alloying element < 5%)	SNC, DCr, SNCN SCM, SMn		Non-hardened	200	197 - 328	0.003 - 0.006	0.004 - 0.008	0.005 - 0.009	0.006 - 0.010	0.007 - 0.012
				Hardened and tempered	275	197 - 328	0.003 - 0.006	0.004 - 0.008	0.005 - 0.009	0.006 - 0.010	0.007 - 0.012
					300	164 - 328	0.003 - 0.006	0.004 - 0.008	0.005 - 0.009	0.006 - 0.010	0.007 - 0.012
	High alloy steels Casting steel Tool steels	SNS, SKD, SKT SKH, SK		Non-hardened	200	197 - 394	0.003 - 0.006	0.004 - 0.008	0.005 - 0.009	0.006 - 0.010	0.007 - 0.012
				Hardened and tempered	325	197 - 394	0.003 - 0.006	0.004 - 0.008	0.005 - 0.009	0.006 - 0.010	0.007 - 0.012
M	Stainless steels	430SS	Ferritic	200	197 - 361	0.003 - 0.006	0.004 - 0.008	0.005 - 0.009	0.006 - 0.010	0.007 - 0.012	
		410SS	Martensite	240	197 - 361	0.003 - 0.006	0.004 - 0.008	0.005 - 0.009	0.006 - 0.010	0.007 - 0.012	
		304SS,316SS	Austenite	180	197 - 361	0.003 - 0.006	0.004 - 0.008	0.005 - 0.009	0.006 - 0.010	0.007 - 0.012	
K	Ductile cast irons	60-40-18 - 65-45-120	Ferritic / Pearlitic	180	197 - 328	0.003 - 0.005	0.004 - 0.006	0.005 - 0.007	0.006 - 0.008	0.007 - 0.009	
		80-55-06 - 100-70-03	Pearlitic	260	197 - 328	0.003 - 0.005	0.004 - 0.006	0.005 - 0.007	0.006 - 0.008	0.007 - 0.009	
	Gray cast irons	Class 10 - Class 20	Low tensile strength	160	197 - 328	0.003 - 0.005	0.004 - 0.006	0.005 - 0.007	0.006 - 0.008	0.007 - 0.009	
		Class 25 - Class 35	High tensile strength	250	197 - 328	0.003 - 0.005	0.004 - 0.006	0.005 - 0.007	0.006 - 0.008	0.007 - 0.009	
	Malleable cast irons	FCMB, FCMW	Ferritic	130	197 - 328	0.003 - 0.005	0.004 - 0.006	0.005 - 0.007	0.006 - 0.008	0.007 - 0.009	
FCMWP, FCMP		Pearlitic	230	197 - 328	0.003 - 0.005	0.004 - 0.006	0.005 - 0.007	0.006 - 0.008	0.007 - 0.009		
N	Aluminum alloys Forging		Non-aged	60	197 - 427	0.003 - 0.008	0.004 - 0.010	0.005 - 0.011	0.006 - 0.012	0.007 - 0.013	
			Soluted, Aged	100	197 - 427	0.003 - 0.008	0.004 - 0.010	0.005 - 0.011	0.006 - 0.012	0.007 - 0.013	
	Aluminum alloys Casting		≤12% Si	Non-aged	75	197 - 427	0.003 - 0.008	0.004 - 0.010	0.005 - 0.011	0.006 - 0.012	0.007 - 0.013
			Soluted, Aged	90	197 - 427	0.003 - 0.008	0.004 - 0.010	0.005 - 0.011	0.006 - 0.012	0.007 - 0.013	
			>12% Si	High silicon	130	197 - 427	0.003 - 0.008	0.004 - 0.010	0.005 - 0.011	0.006 - 0.012	0.007 - 0.013
	Copper alloys		>1% Pb	Free cutting copper	110	197 - 427	0.003 - 0.008	0.004 - 0.010	0.005 - 0.011	0.006 - 0.012	0.007 - 0.013
			Brass, Red brass	90	197 - 427	0.003 - 0.008	0.004 - 0.010	0.005 - 0.011	0.006 - 0.012	0.007 - 0.013	
S	Nickel-based alloys		Fe base	Non-aged	200	66 - 213	0.003 - 0.006	0.004 - 0.008	0.005 - 0.009	0.006 - 0.010	0.007 - 0.012
				Soluted, Aged	280	66 - 213	0.003 - 0.006	0.004 - 0.008	0.005 - 0.009	0.006 - 0.010	0.007 - 0.012
			Ni / Co base	Non-aged	250	66 - 213	0.003 - 0.006	0.004 - 0.008	0.005 - 0.009	0.006 - 0.010	0.007 - 0.012
				Soluted, Aged	350	66 - 213	0.003 - 0.006	0.004 - 0.008	0.005 - 0.009	0.006 - 0.010	0.007 - 0.012
				Casted	320	66 - 213	0.003 - 0.006	0.004 - 0.008	0.005 - 0.009	0.006 - 0.010	0.007 - 0.012
	Titanium alloys		α		Rm400	98 - 328	0.003 - 0.006	0.004 - 0.008	0.005 - 0.009	0.006 - 0.010	0.007 - 0.012
			α - β		Rm1050	98 - 328	0.003 - 0.006	0.004 - 0.008	0.005 - 0.009	0.006 - 0.010	0.007 - 0.012

The above values should not be used as the exact recommendations. They may need modification depending on the machining conditions, materials, etc.

Grade
Insert
Toolholder
Ext. Toolholder
Int. Toolholder
Threading
Grooving
Miniature Tool
Milling Cutter
Endmill
Drilling Tool
Tooling System
User's Guide
Index



MBU

MBU type drill head

Brazed drill head with external single-start thread for single tube system (STS), tool diameter $\varnothing 8 - \varnothing 14.79 \text{ mm}$ (0.315" - 0.582")

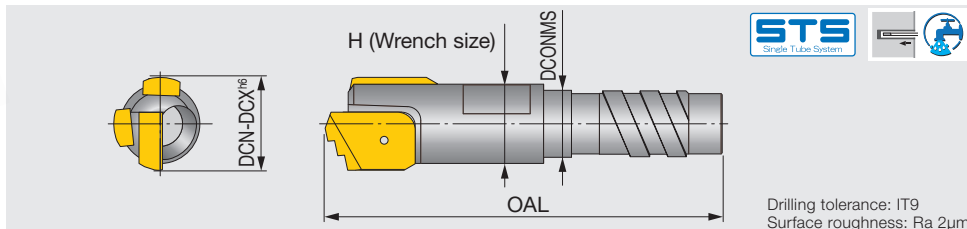

Metric	DCN		DCX		Drill tube		OAL	DCNMS	H
	(in)	(mm)	(in)	(mm)	Designation	Dia. (mm)			
MBU-0899-1 xx.xx	0.315	8	0.328	8.32	UMBB071	7.1	34	6	6
MBU-0899-2 xx.xx	0.328	8.33	0.341	8.65	UMBB071	7.1	34	6	6
MBU-0899-3 xx.xx	0.341	8.66	0.354	8.99	UMBB071	7.1	34	6	6
MBU-0999-1 xx.xx	0.354	9	0.367	9.32	UMBB083	8.3	34	7.2	7
MBU-0999-2 xx.xx	0.367	9.33	0.380	9.65	UMBB083	8.3	34	7.2	7
MBU-0999-3 xx.xx	0.380	9.66	0.393	9.99	UMBB083	8.3	34	7.2	7
MBU-1099-1 xx.xx	0.394	10	0.406	10.32	UMBB090	9	34	7.6	8
MBU-1099-2 xx.xx	0.407	10.33	0.419	10.65	UMBB090	9	34	7.6	8
MBU-1099-3 xx.xx	0.420	10.66	0.433	10.99	UMBB090	9	34	7.6	8
MBU-1199-1 xx.xx	0.433	11	0.446	11.32	UMBB100	10	34	8.6	9
MBU-1199-2 xx.xx	0.446	11.33	0.459	11.65	UMBB100	10	34	8.6	9
MBU-1199-3 xx.xx	0.459	11.66	0.472	11.99	UMBB100	10	34	8.6	9
MBU-1349-1 xx.xx	0.472	12	0.487	12.36	UMBB110	11	34	9.1	10
MBU-1349-2 xx.xx	0.487	12.37	0.501	12.73	UMBB110	11	34	9.1	10
MBU-1349-3 xx.xx	0.502	12.74	0.516	13.1	UMBB110	11	34	9.1	10
MBU-1349-4 xx.xx	0.516	13.11	0.531	13.49	UMBB110	11	34	9.1	10
MBU-1449-1 xx.xx	0.531	13.5	0.544	13.82	UMBB120	12	34	10.8	11
MBU-1449-2 xx.xx	0.544	13.83	0.557	14.15	UMBB120	12	34	10.8	11
MBU-1449-3 xx.xx	0.557	14.16	0.570	14.48	UMBB120	12	34	10.8	11
MBU-1449-4 xx.xx	0.570	14.49	0.582	14.79	UMBB120	12	34	10.8	11

e.g. Designation for tool diameter $\varnothing 9 \text{ mm}$: MBU-0899-1 9.00

The interface of the drill tube has a unique shape. Please be sure to use UMBB drill tube.

ISO classifications for Insert grades

	Grade	(Former name)	ISO area								
			5	10	15	20	25	30	35	40	
P	1122	(PC ZAP)		Blue	Blue	Blue					
M	3112	(TF ZAP)			Yellow	Yellow	Yellow				
K	3112	(TF ZAP)		Red	Red	Red					
N	3112	(TF ZAP)			Green	Green					
S	3112	(TF ZAP)			Orange	Orange					

Reference pages: Standard cutting conditions → **J149**, Drill tube (STS) → **J150**

UTE

UTE type drill head

Brazed drill head with external 2-start or 4-start thread for single tube system (STS), tool diameter $\phi 12.6 - \phi 20$ mm (0.496" - 0.787")

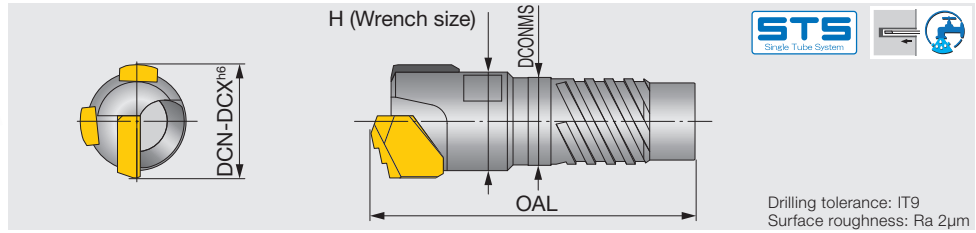

Metric	DCN		DCX		Drill tube		OAL	DCONMS	H
	(in)	(mm)	(in)	(mm)	Designation	Dia. (mm)			
UTE-0094-1 xx.xx	0.496	12.6	0.509	12.92	ST0094	11	40	9.6	10
UTE-0094-2 xx.xx	0.509	12.93	0.511	12.99	ST0094	11	40	9.6	10
UTE-0094-3 xx.xx	0.512	13	0.522	13.25	ST0094	11	40	9.6	10
UTE-0094-4 xx.xx	0.522	13.26	0.535	13.6	ST0094	11	40	9.6	10
UTE-0095-1 xx.xx	0.536	13.61	0.548	13.93	ST0095	12	40	10.6	11
UTE-0095-2 xx.xx	0.549	13.94	0.551	13.99	ST0095	12	40	10.6	11
UTE-0095-3 xx.xx	0.551	14	0.561	14.26	ST0095	12	40	10.6	11
UTE-0095-4 xx.xx	0.562	14.27	0.575	14.6	ST0095	12	40	10.6	11
UTE-0096-1 xx.xx	0.575	14.61	0.588	14.93	ST0096	13	40	11.6	12
UTE-0096-2 xx.xx	0.588	14.94	0.601	15.26	ST0096	13	40	11.6	12
UTE-0096-3 xx.xx	0.601	15.27	0.614	15.59	ST0096	13	40	11.6	12
UTE-0097-1 xx.xx	0.614	15.6	0.628	15.96	ST0097	14	40	12.6	13
UTE-0097-2 xx.xx	0.629	15.97	0.643	16.32	ST0097	14	40	12.6	13
UTE-0097-3 xx.xx	0.643	16.33	0.657	16.7	ST0097	14	40	12.6	13
UTE-0098-1 xx.xx	0.658	16.71	0.670	17.03	ST0098	15	40	13.6	14
UTE-0098-2 xx.xx	0.671	17.04	0.683	17.36	ST0098	15	40	13.6	14
UTE-0098-3 xx.xx	0.684	17.37	0.697	17.7	ST0098	15	40	13.6	14
UTE-0099-1 xx.xx	0.697	17.71	0.712	18.09	ST0099	16	40	14.5	15
UTE-0099-2 xx.xx	0.713	18.1	0.728	18.48	ST0099	16	40	14.5	15
UTE-0099-3 xx.xx	0.728	18.49	0.744	18.9	ST0099	16	40	14.5	15
UTE-0000-1 xx.xx	0.744	18.91	0.758	19.26	ST0000	17	40	15.5	16
UTE-0000-2 xx.xx	0.759	19.27	0.772	19.62	ST0099	17	40	15.5	16
UTE-0000-3 xx.xx	0.773	19.63	0.787	20	ST0099	17	40	15.5	16

e.g. Designation for tool diameter $\phi 12.92$ mm: UTE-0094-1 12.92

UTE Drill head : $\phi 12.6$ mm - $\phi 15.59$ mm, External 2-start thread

UTE Drill head : $\phi 15.6$ mm - $\phi 20$ mm, External 4-start thread

ISO classifications for Insert grades

Grade	(Former name)	ISO area							
		5	10	15	20	25	30	35	40
P	1122 (UP ZAP)								
M	3112 (TF ZAP)								
K	3112 (TF ZAP)								
N	3112 (TF ZAP)								
S	3132 (TFKS ZAP)								

Reference pages: Standard cutting conditions → **J149**, Drill tube (STS) → **J150**

BTU

BTU type drill head (Small diameter, 2 edges)

Brazed drill head with external 2-start thread for single tube system (STS), tool diameter $\phi 12.6 - \phi 15.59$ mm (0.496" - 0.614")

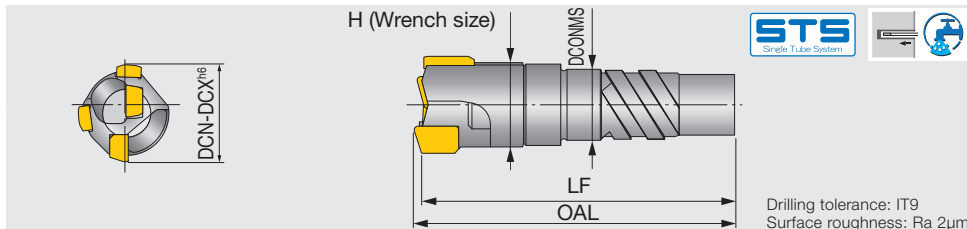

Metric	DCN		DCX		Drill tube		OAL	LF	DCONMS	H
	(in)	(mm)	(in)	(mm)	Designation	Dia. (mm)				
BTU-00941 xx.xx	0.496	12.6	0.516	13.1	ST0094	11	43	41.9	9.6	10
BTU-00942 xx.xx	0.516	13.11	0.535	13.6	ST0094	11	43	41.9	9.6	10
BTU-00951 xx.xx	0.536	13.61	0.555	14.1	ST0095	12	43	41.8	10.6	11
BTU-00952 xx.xx	0.556	14.11	0.575	14.6	ST0095	12	43	41.8	10.6	11
BTU-00961 xx.xx	0.575	14.61	0.594	15.1	ST0096	13	43	41.7	11.6	12
BTU-00962 xx.xx	0.595	15.11	0.614	15.59	ST0096	13	43	41.7	11.6	12

e.g. Designation for tool diameter $\phi 13.1$ mm: BTU-00941 13.10

ISO classifications for Insert grades

	Grade	(Former name)	ISO area								
			5	10	15	20	25	30	35	40	
P	1122	(UP ZAP)				20	25	30			
M	2122	(N3 ZAP)						30	35	40	
K	1122	(UP ZAP)			15	20	25				
N	1122	(UP ZAP)			15	20	25				
S	1122	(UP ZAP)			15	20	25				

BTU

BTU type drill head (3 edges)

Brazed drill head with external 4-start thread for single tube system (STS),
tool diameter $\phi 15.6 - \phi 65$ mm (0.614" - 0.559")

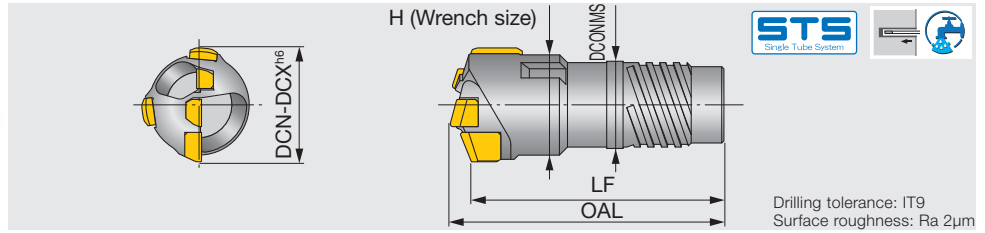

Metric	DCN		DCX		Drill tube		OAL	LF	DCONMS	H
	(in)	(mm)	(in)	(mm)	Designation	Dia. (mm)				
BTU-00971 xx.xx	0.614	15.6	0.638	16.2	ST0097	14	43	40.3	12.6	-
BTU-00972 xx.xx	0.638	16.21	0.657	16.7	ST0097	14	43	40.3	12.6	14
BTU-00981 xx.xx	0.658	16.71	0.677	17.2	ST0098	15	43	40.3	13.6	15
BTU-00982 xx.xx	0.678	17.21	0.697	17.7	ST0098	15	43	40.3	13.6	15
BTU-00991 xx.xx	0.697	17.71	0.724	18.4	ST0099	16	47	44.2	14.5	15
BTU-00992 xx.xx	0.725	18.41	0.744	18.9	ST0099	16	47	44.1	14.5	-
BTU-001 xx.xx	0.744	18.91	0.756	19.2	ST0000	17	47	44.1	15.5	17
BTU-002 xx.xx	0.756	19.21	0.787	20	ST0000	17	47	44	15.5	18
BTU-011 xx.xx	0.788	20.01	0.823	20.9	ST00	18	52.5	49.4	16	18
BTU-012 xx.xx	0.823	20.91	0.858	21.8	ST00	18	52.5	49.4	16	19
BTU-021 xx.xx	0.859	21.81	0.902	22.9	ST01	20	56	52.8	18	20
BTU-022 xx.xx	0.902	22.91	0.949	24.1	ST01	20	56	52.6	18	21
BTU-031 xx.xx	0.949	24.11	0.992	25.2	ST02	22	57.5	54	19.5	23
BTU-032 xx.xx	0.993	25.21	1.039	26.4	ST02	22	57.5	54	19.5	24
BTU-041 xx.xx	1.040	26.41	1.083	27.5	ST03	24	57.5	53.8	21	25
BTU-042 xx.xx	1.083	27.51	1.130	28.7	ST03	24	57.5	53.8	21	26
BTU-051 xx.xx	1.130	28.71	1.173	29.8	ST04	26	63.5	59.5	23.5	27
BTU-052 xx.xx	1.174	29.81	1.220	31	ST04	26	63.5	59.3	23.5	28
BTU-061 xx.xx	1.221	31.01	1.264	32.1	ST05	28	63.5	59.4	25.5	29
BTU-062 xx.xx	1.264	32.11	1.311	33.3	ST05	28	63.5	59.1	25.5	30
BTU-071 xx.xx	1.311	33.31	1.370	34.8	ST06	30	63.5	59	28	32
BTU-072 xx.xx	1.370	34.81	1.425	36.2	ST06	30	63.5	58.9	28	33
BTU-081 xx.xx	1.426	36.21	1.469	37.3	ST07	33	73.5	68.7	30	34
BTU-082 xx.xx	1.469	37.31	1.512	38.4	ST07	33	73.5	68.5	30	35
BTU-083 xx.xx	1.512	38.41	1.559	39.6	ST07	33	73.5	68.3	30	36
BTU-091 xx.xx	1.559	39.61	1.598	40.6	ST08	36	73.5	68.2	33	37
BTU-092 xx.xx	1.599	40.61	1.646	41.8	ST08	36	73.5	68	33	38
BTU-093 xx.xx	1.646	41.81	1.693	43	ST08	36	73.5	67.8	33	39
BTU-101 xx.xx	1.693	43.01	1.744	44.3	ST09	39	75	69.5	36	41
BTU-102 xx.xx	1.744	44.31	1.795	45.6	ST09	39	75	69.3	36	42
BTU-103 xx.xx	1.796	45.61	1.850	47	ST09	39	75	69.1	36	43
BTU-111 xx.xx	1.851	47.01	1.909	48.5	ST10	43	75	68.8	39	44
BTU-112 xx.xx	1.910	48.51	1.972	50.1	ST10	43	75	68.7	39	46
BTU-113 xx.xx	1.973	50.11	2.035	51.7	ST10	43	75	68.5	39	47
BTU-121 xx.xx	2.036	51.71	2.094	53.2	ST11	47	82	75.2	43	49
BTU-122 xx.xx	2.095	53.21	2.154	54.7	ST11	47	82	75.2	43	50
BTU-123 xx.xx	2.154	54.71	2.213	56.2	ST11	47	82	75.2	43	51
BTU-131 xx.xx	2.213	56.21	2.299	58.4	ST12	51	84	77.4	47	54
BTU-132 xx.xx	2.300	58.41	2.386	60.6	ST12	51	84	76.9	47	55
BTU-133 xx.xx	2.386	60.61	2.472	62.8	ST12	51	84	76.8	47	57
BTU-134 xx.xx	2.473	62.81	2.559	65	ST12	51	84	76.5	47	59
BTU-133L xx.xx	2.386	60.61	2.472	62.8	ST13	56	84	76.8	51	57
BTU-134L xx.xx	2.473	62.81	2.559	65	ST13	56	84	76.5	51	59

e.g. Designation for tool diameter $\phi 16.2$ mm: BTU-00971 16.20

ISO classifications for Insert grades

	Grade	(Former name)	ISO area							
			5	10	15	20	25	30	35	40
P	1122	(UP ZAP)								
	1132	(UX-2 ZAP)								
M	1132	(UX-2 ZAP)								
	2122	(N3 ZAP)								
K	3132	(TFKS ZAP)								
N	3132	(TFKS ZAP)								
S	3132	(TFKS ZAP)								

Reference pages: Standard cutting conditions → **J149**, Drill tube (STS) → **J150**

ETU

ETU type drill head

Brazed drill head with external 4-start thread for double tube system (DTS), tool diameter $\varnothing 18.4 - \varnothing 65$ mm (0.724" - 2.559")

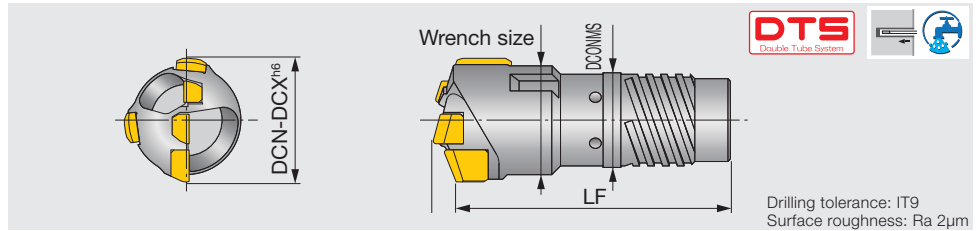

Metric	DCN		DCX		Drill tube		OAL	LF	DCONMS	H
	(in)	(mm)	(in)	(mm)	Designation	Dia. (mm)				
ETU-001 xx.xx	0.724	18.4	0.756	19.2	OT00	18	50	47.1	16	17
ETU-002 xx.xx	0.756	19.21	0.787	20	OT00	18	50	47	16	18
ETU-011 xx.xx	0.788	20.01	0.823	20.9	OT01	20	56	52.8	18	18
ETU-012 xx.xx	0.823	20.91	0.858	21.8	OT01	20	56	52.7	18	19
ETU-021 xx.xx	0.859	21.81	0.902	22.9	OT02	22	56	52.8	19.5	20
ETU-022 xx.xx	0.902	22.91	0.949	24.1	OT02	22	56	52.6	19.5	21
ETU-031 xx.xx	0.949	24.11	0.992	25.2	OT03	24	57.5	54	21	23
ETU-032 xx.xx	0.993	25.21	1.039	26.4	OT03	24	57.5	54	21	24
ETU-041 xx.xx	1.040	26.41	1.083	27.5	OT04	26	60.5	56.8	23.5	25
ETU-042 xx.xx	1.083	27.51	1.130	28.7	OT04	26	60.5	56.8	23.5	26
ETU-051 xx.xx	1.130	28.71	1.173	29.8	OT05	28	63.5	59.5	25.5	27
ETU-052 xx.xx	1.174	29.81	1.220	31	OT05	28	63.5	59.3	25.5	28
ETU-061 xx.xx	1.221	31.01	1.264	32.1	OT06	31	63.5	59.4	28	29
ETU-062 xx.xx	1.264	32.11	1.311	33.3	OT06	31	63.5	59.2	28	30
ETU-071 xx.xx	1.311	33.31	1.370	34.8	OT07	33	70.5	66	30	32
ETU-072 xx.xx	1.370	34.81	1.425	36.2	OT07	33	70.5	65.8	30	33
ETU-081 xx.xx	1.426	36.21	1.469	37.3	OT08	36	73.5	68.7	33	34
ETU-082 xx.xx	1.469	37.31	1.512	38.4	OT08	36	73.5	68.5	33	35
ETU-083 xx.xx	1.512	38.41	1.559	39.6	OT08	36	73.5	68.3	33	36
ETU-091 xx.xx	1.559	39.61	1.598	40.6	OT09	39	73.5	68.2	36	37
ETU-092 xx.xx	1.599	40.61	1.646	41.8	OT09	39	73.5	68	36	38
ETU-093 xx.xx	1.646	41.81	1.693	43	OT09	39	73.5	67.9	36	39
ETU-101 xx.xx	1.693	43.01	1.744	44.3	OT10	43	75	69.5	39	41
ETU-102 xx.xx	1.744	44.31	1.795	45.6	OT10	43	75	69.3	39	42
ETU-103 xx.xx	1.796	45.61	1.850	47	OT10	43	75	69.1	39	43
ETU-111 xx.xx	1.851	47.01	1.909	48.5	OT11	47	79	72.9	43	44
ETU-112 xx.xx	1.910	48.51	1.972	50.1	OT11	47	79	72.8	43	46
ETU-113 xx.xx	1.973	50.11	2.035	51.7	OT11	47	79	72.5	43	47
ETU-121 xx.xx	2.036	51.71	2.094	53.2	OT12	51	82	75.3	47	49
ETU-122 xx.xx	2.095	53.21	2.154	54.7	OT12	51	82	75.5	47	50
ETU-123 xx.xx	2.154	54.71	2.213	56.2	OT12	51	82	75.3	47	51
ETU-131 xx.xx	2.213	56.21	2.299	58.4	OT13	56	84	77.4	51	54
ETU-132 xx.xx	2.300	58.41	2.386	60.6	OT13	56	84	76.9	51	55
ETU-133 xx.xx	2.386	60.61	2.472	62.8	OT13	56	84	77	51	57
ETU-134 xx.xx	2.473	62.81	2.559	65	OT13	56	84	76.6	51	59

e.g. Designation for tool diameter $\varnothing 19.2$ mm: ETU-001 19.20

ISO classifications for Insert grades

	Grade	(Former name)	ISO area								
			5	10	15	20	25	30	35	40	
P	1122	(UP ZAP)		■	■	■					
	1132	(UX-2 ZAP)				■	■	■			
M	1132	(UX-2 ZAP)					■	■	■		
	2122	(N3 ZAP)						■	■	■	
K	3132	(TFKS ZAP)			■	■	■				
N	3132	(TFKS ZAP)		■	■	■					
S	3132	(TFKS ZAP)			■	■	■				

Reference pages: Standard cutting conditions → **J149**, Drill tube (DTS) → **J154**

STANDARD CUTTING CONDITIONS

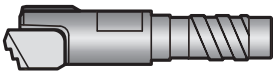

MBU

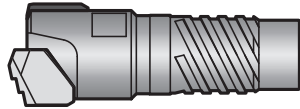

UTE



**BTU
(2 edges)**

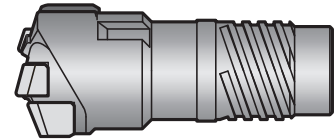

**BTU
(3 edges)**

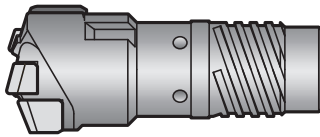

**ETU
(3 edges)**

ISO	Workpiece material	JIS	Condition	Hardness (HB)	Cutting speed Vc (sfm)	Feed per revolution: fn (in/rev)				
						Drill dia. (in)				
						0.315" - 0.787"	0.496" - 0.787"	0.788" - 1.220"	1.221" - 1.693"	1.693" - 2.559"
P	Carbon steels Cast steels High carbon steels Carbon tool steels	1010 - 1025	0.1 - 0.25 %C Non-hardened	125	230 - 427	0.002 - 0.005	0.003 - 0.006	0.004 - 0.007	0.005 - 0.008	0.006 - 0.012
		1025 - 1055	0.25 - 0.25 %C Non-hardened	190	230 - 427	0.002 - 0.005	0.003 - 0.006	0.004 - 0.007	0.005 - 0.008	0.006 - 0.012
		SK	0.25 - 0.25 %C Hardened	250	230 - 427	0.002 - 0.005	0.003 - 0.006	0.004 - 0.007	0.005 - 0.008	0.006 - 0.012
			0.55 - 0.80 %C Non-hardened	220	230 - 427	0.002 - 0.005	0.003 - 0.006	0.004 - 0.007	0.005 - 0.008	0.006 - 0.012
	Low alloy steels Cast steels (alloying element < 5%)	SNC, DCr, SNCN SCM, SMn	Non-hardened	200	230 - 361	0.002 - 0.005	0.003 - 0.006	0.004 - 0.007	0.005 - 0.008	0.006 - 0.012
				275	197 - 361	0.002 - 0.004	0.003 - 0.005	0.004 - 0.006	0.005 - 0.007	0.006 - 0.011
		Hardened	300	197 - 361	0.002 - 0.004	0.003 - 0.005	0.004 - 0.006	0.005 - 0.007	0.006 - 0.011	
			350	197 - 361	0.002 - 0.004	0.003 - 0.005	0.004 - 0.006	0.005 - 0.007	0.006 - 0.011	
	High alloy steels, Cast steels Tool steels	SNS, SKD, SKT SKH, SK	Non-hardened	200	230 - 427	0.002 - 0.005	0.003 - 0.006	0.004 - 0.007	0.005 - 0.008	0.006 - 0.012
			Hardened	325	230 - 427	0.002 - 0.004	0.003 - 0.005	0.004 - 0.006	0.005 - 0.007	0.006 - 0.011
M	Stainless steels	430SS	Ferritic	200	131 - 361	0.002 - 0.005	0.003 - 0.006	0.004 - 0.011	0.005 - 0.012	0.006 - 0.014
		410SS	Martensitic	240	131 - 361	0.002 - 0.005	0.003 - 0.006	0.004 - 0.011	0.005 - 0.012	0.006 - 0.014
		304SS, 316SS	Austenitic	180	131 - 361	0.002 - 0.005	0.002 - 0.005	0.003 - 0.010	0.004 - 0.011	0.006 - 0.013
K	Ductile cast iron	60-40-18 - 65-45-120	Ferritic / Pearlitic	180	164 - 361	0.002 - 0.005	0.003 - 0.006	0.004 - 0.007	0.005 - 0.008	0.006 - 0.012
		80-55-06 - 100-70-03	Pearlitic	260	164 - 361	0.002 - 0.005	0.003 - 0.006	0.004 - 0.007	0.005 - 0.008	0.006 - 0.012
	Gray cast iron	Class 10 - Class 20	Low tensile strength	160	197 - 361	0.002 - 0.005	0.002 - 0.005	0.003 - 0.007	0.004 - 0.008	0.006 - 0.010
		Class 25 - Class 35	High tensile strength	250	197 - 361	0.002 - 0.005	0.002 - 0.005	0.003 - 0.007	0.004 - 0.008	0.006 - 0.010
	Malleable cast irons	FCMB, FCMW FCMWP, FCMP	Ferritic Pearlitic	130 230	230 - 361 230 - 361	0.002 - 0.005 0.002 - 0.005	0.002 - 0.005 0.002 - 0.005	0.003 - 0.007 0.003 - 0.007	0.004 - 0.008 0.004 - 0.008	0.006 - 0.010 0.006 - 0.010
N	Aluminum alloy Wrought	Non-aged	60	213 - 427	0.002 - 0.005	0.003 - 0.006	0.004 - 0.008	0.006 - 0.010	0.006 - 0.012	
		Soluted, Aged	100	213 - 427	0.002 - 0.005	0.003 - 0.006	0.004 - 0.008	0.006 - 0.010	0.006 - 0.012	
	Aluminum alloy Cast	<=12% Si	Non-aged	75	213 - 427	0.002 - 0.005	0.003 - 0.006	0.004 - 0.008	0.006 - 0.010	0.006 - 0.012
			Soluted, Aged	90	213 - 427	0.002 - 0.005	0.003 - 0.006	0.004 - 0.008	0.006 - 0.010	0.006 - 0.012
		>12% Si	High silicon content	130	213 - 427	0.002 - 0.005	0.003 - 0.006	0.004 - 0.008	0.006 - 0.010	0.006 - 0.012
	Copper alloys	>1% Pb	Free-cutting copper	110	213 - 427	0.002 - 0.005	0.003 - 0.006	0.004 - 0.008	0.006 - 0.010	0.006 - 0.012
Brass, Red brass			90	213 - 427	0.002 - 0.005	0.003 - 0.006	0.004 - 0.008	0.006 - 0.010	0.006 - 0.012	
S	Heat-resistant alloy	Fe based alloys	Non-aged	200	66 - 164	0.002 - 0.005	0.002 - 0.005	0.003 - 0.006	0.005 - 0.007	0.006 - 0.010
			Soluted, Aged	280	66 - 164	0.002 - 0.005	0.002 - 0.005	0.003 - 0.006	0.005 - 0.007	0.006 - 0.010
		Ni / Co based alloys	Non-aged	250	66 - 164	0.002 - 0.005	0.002 - 0.005	0.003 - 0.006	0.005 - 0.007	0.006 - 0.010
			Soluted, Aged	350	66 - 164	0.002 - 0.005	0.002 - 0.005	0.003 - 0.006	0.005 - 0.007	0.006 - 0.010
	Titanium alloys	α	Cast	320	66 - 164	0.002 - 0.005	0.002 - 0.005	0.003 - 0.006	0.005 - 0.007	0.006 - 0.010
			Rm400	98 - 197	0.002 - 0.004	0.002 - 0.004	0.003 - 0.005	0.004 - 0.006	0.005 - 0.008	
α-β	Rm1050	98 - 197	0.002 - 0.004	0.002 - 0.004	0.003 - 0.005	0.004 - 0.006	0.005 - 0.008			

The above values may need modification depending on the machining conditions, materials, etc.

Grade
Insert
Toolholder
Ext. Toolholder
Int. Toolholder
Threading
Grooving
Miniature Tool
Milling Cutter
Endmill
Drilling Tool
User's Guide Tooling System
Index



ST

ST - for single tube system

Drill tube for single tube system (STS), internal thread type, 2-start thread (tool dia. ≤ ø15.59 mm, 0.614") or 4-start thread (tool dia. ≥ ø15.6 mm, 0.614")

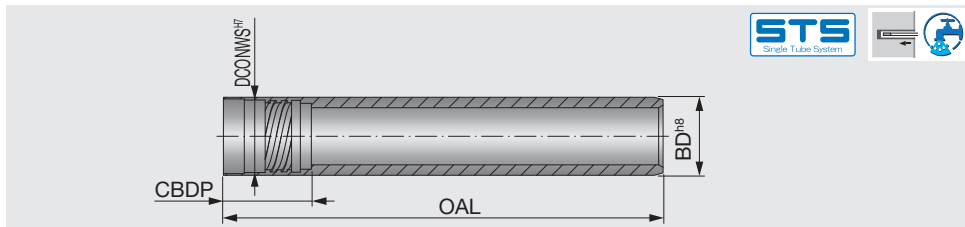

Metric	DCN - DCX		OAL		BD	DCONWS	CBDP	Metric	DCN - DCX		OAL	BD	DCONWS	CBDP	
	(in)	(mm)	1600	2600					(in)	(mm)					Special length
ST0094	0.496 - 0.535	12.6 - 13.6	●	○	11	9.6	22	ST14	2.559 - 2.637	65 - 66.99	○	56	52	75	
ST0095	0.536 - 0.575	13.61 - 14.6	●	○	12	10.6	22	ST15	2.638 - 2.874	67 - 72.99	○	62	58	75	
ST0096	0.575 - 0.614	14.61 - 15.59	●	○	13	11.6	22	ST16	2.874 - 3.149	73 - 79.99	○	68	63	75	
ST0097	0.614 - 0.657	15.6 - 16.7	●	○	14	12.6	21	ST17	3.15 - 3.425	80 - 86.99	○	75	70	97	
ST0098	0.658 - 0.697	16.71 - 17.7	●	●	○	15	13.6	21	ST18	3.425 - 3.937	87 - 99.99	○	82	77	97
ST0099	0.697 - 0.744	17.71 - 18.9	●	●	○	16	14.5	22	ST19	3.937 - 4.409	100 - 111.99	○	94	89	97
ST0000	0.744 - 0.787	18.91 - 20	●	●	○	17	15.5	22	ST20	4.409 - 4.881	112 - 123.99	○	106	101	118
ST00	0.788 - 0.858	20.01 - 21.8	●	●	○	18	16	27.5	ST21	4.882 - 5.354	124 - 135.99	○	118	113	118
ST01	0.859 - 0.949	21.81 - 24.1	●	○	○	20	18	30	ST22	5.354 - 5.826	136 - 147.99	○	130	125	118
ST02	0.949 - 1.039	24.11 - 26.4	●	○	○	22	19.5	30	ST23	5.827 - 6.299	148 - 159.99	○	142	137	139
ST03	1.040 - 1.130	26.41 - 28.7	●	○	○	24	21	30	ST24	6.299 - 6.771	160 - 171.99	○	154	149	139
ST04	1.130 - 1.220	28.71 - 31	●	○	○	26	23.5	33	ST25	6.772 - 7.244	172 - 183.99	○	166	161	139
ST05	1.221 - 1.311	31.01 - 33.3	●	○	○	28	25.5	33	ST26	7.244 - 7.716	184 - 195.99	○	178	173	144
ST06	1.311 - 1.425	33.31 - 36.2	●	○	○	30	28	33	ST27	7.717 - 8.189	196 - 207.99	○	190	185	144
ST07	1.426 - 1.559	36.21 - 39.6	●	○	○	33	30	40	ST28	8.189 - 8.661	208 - 219.99	○	202	197	144
ST08	1.559 - 1.693	39.61 - 43	●	○	○	36	33	40	ST29	8.661 - 9.133	220 - 231.99	○	214	208	164
ST09	1.693 - 1.850	43.01 - 47	●	○	○	39	36	40	ST30	9.134 - 9.606	232 - 243.99	○	226	220	164
ST10	1.851 - 2.035	47.01 - 51.7	●	○	○	43	39	40	ST31	9.606 - 10.078	244 - 255.99	○	238	232	164
ST11	2.036 - 2.213	51.71 - 56.2	●	○	○	47	43	44	ST32	10.079 - 10.551	256 - 267.99	○	250	244	184
ST12	2.213 - 2.386	56.21 - 60.6	●	○	○	51	47	44	ST33	10.551 - 11.023	268 - 279.99	○	262	256	184
ST13	2.386 - 2.559	60.61 - 65	○	○	○	56	51	44	ST34	11.024 - 11.496	280 - 291.99	○	274	268	184

Please specify the length (L) when ordering.
e.g. For ø60 mm drill diameter / 2600 mm drill tube length: ST12X2600
The lengths that are not in the above will be available upon request.

● : Line up
○ : Item to be customized

UMBB

UMBB - for single tube system with MBU

Drill tube with internal single-start thread for MBU drill head

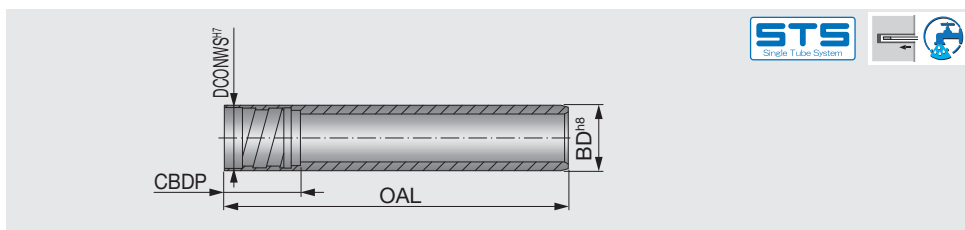

Metric	DCN - DCX		OAL	BD	DCONWS	CBDP
	(in)	(mm)				
UMBB071	0.315 - 0.354	8 - 8.99	○	7.1	6	13.5
UMBB083	0.354 - 0.393	9 - 9.99	○	8.3	7.2	13.5
UMBB090	0.394 - 0.433	10 - 10.99	○	9	7.6	13.5
UMBB100	0.433 - 0.472	11 - 11.99	○	10	8.6	13.5
UMBB110	0.472 - 0.531	12 - 13.49	○	11	9.1	13.5
UMBB120	0.531 - 0.582	13.5 - 14.79	○	12	10.8	13.5

Please specify the length (L) when ordering.
e.g. For ø11 mm drill diameter / 1000 mm drill tube length: UMBB100X1000

○ : Item to be customized

Reference pages: ST: Drill head → **J128** (TRI-FINE STS-EX), **J132** (FINE BEAM STS-EX), **J138** (UNIDEX STS-EX), **J145** (UTE), **J146 - J147** (BTU)

UMBB: Drill head → **J144** (MBU)

TUBE LENGTH FOR SPECIAL DRILLS

Drill tubes with the lengths that are not for standard items will be available upon request. Please use the below guide to calculate the drill tube length.

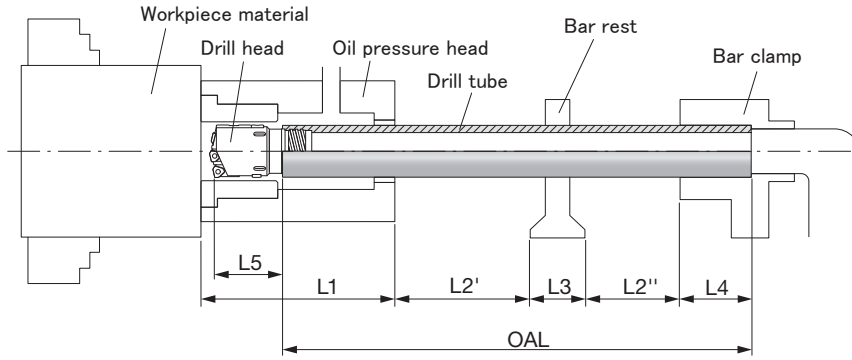

- L = Drill tube whole length
- L1 = Oil pressure head length
- L2 = Drilling depth (L2' + L2'')
- L3 = Bar rest length
- L4 = Drill tube clamp length
- L5 = Length from drill tube tip and peripheral edge tip

$$\text{Drill tube length OAL} = L1 + L2 + L3 + L4 - L5$$

BTU



DCN - DCX		L5
(in)	(mm)	
0.496 - 0.697	12.6 - 17.7	20
0.697 - 0.756	17.71 - 19.2	23
0.756 - 0.858	19.21 - 21.8	22
0.859 - 0.949	21.81 - 24.1	23
0.949 - 1.130	24.11 - 28.7	24
1.130 - 1.311	28.71 - 33.3	27
1.311 - 1.425	33.31 - 36.2	26
1.426 - 1.598	36.21 - 40.6	29
1.599 - 1.693	40.61 - 43	28
1.693 - 1.850	43.01 - 47	30
1.851 - 2.035	47.01 - 51.7	29
2.036 - 2.213	51.71 - 56.2	32
2.213 - 2.299	56.21 - 58.4	34
2.300 - 2.559	58.41 - 65	33

FINE-BEAM



DCN - DCX		L5
(in)	(mm)	
0.984 - 1.130	25 - 28.7	40
1.130 - 1.311	28.71 - 33.3	42
1.311 - 1.425	33.31 - 36.2	47
1.426 - 1.559	36.21 - 39.6	50
1.559 - 1.693	39.61 - 43	55
1.693 - 2.035	43.01 - 51.7	60
2.036 - 2.213	51.71 - 56.2	66
2.213 - 2.559	56.21 - 65	71

UNIDEX



DCN - DCX		L5
(in)	(mm)	
1.496 - 1.693	38 - 43	45
1.693 - 2.035	43.01 - 51.7	55
2.036 - 2.213	51.71 - 56.2	56
2.213 - 2.559	56.21 - 65	66
2.559 - 3.149	65 - 79.99	75
3.150 - 4.409	80 - 111.99	83
4.409 - 5.826	112 - 147.99	87
5.827 - 7.244	148 - 183.99	86
7.244 - 10.078	184 - 255.99	101
10.079 - 11.496	256 - 291.99	106

TRI-FINE



DCN - DCX		L5
(in)	(mm)	
0.630 - 0.657	16 - 16.7	34
0.658 - 0.697	16.71 - 17.7	34
0.697 - 0.744	17.71 - 18.9	34
0.744 - 0.787	18.91 - 20	34
0.788 - 0.858	20.01 - 21.8	32.5
0.859 - 0.866	21.81 - 21.99	33.5
0.866 - 0.949	22 - 24.1	35.5
0.949 - 1.039	24.11 - 26.4	35.5
1.040 - 1.102	26.41 - 28	35.5

Grade
Insert
Ext. Toolholder
Int. Toolholder
Threading
Grooving
Miniature Tool
Milling Cutter
Endmill
Drilling Tool
Tooling System
User's Guide
Index



UB

UB - for single tube system

Drill tube for single tube system (STS), external thread type, single-start thread

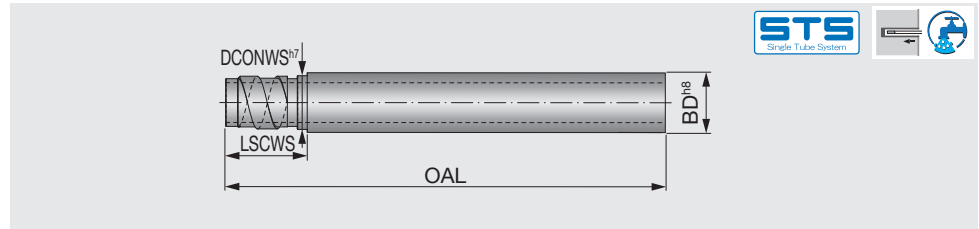

Metric	DCN - DCX		OAL Special length	BD	DCONWS	LSCWS	Metric	DCN - DCX		OAL Special length	BD	DCONWS	LSCWS
	(in)	(mm)						(in)	(mm)				
UB12-1	0.571 - 0.591	14.5 - 15	○	12	11.5	23	UB56	2.402 - 2.677	61 - 67.99	○	56	53	41
UB12-2	0.591 - 0.61	15.01 - 15.5	○	12	11.8	23	UB62	2.677 - 2.952	68 - 74.99	○	62	59	41
UB13-1	0.611 - 0.63	15.51 - 16	○	13	12.4	23	UB68	2.953 - 3.189	75 - 80.99	○	68	65	71
UB13-2	0.630 - 0.650	16.01 - 16.5	○	13	12.7	23	UB75	3.189 - 3.582	81 - 90.99	○	75	71	71
UB14-1	0.650 - 0.679	16.51 - 17.25	○	14	13.4	23	UB82	3.583 - 3.897	91 - 98.99	○	82	79	71
UB14-2	0.680 - 0.709	17.26 - 18	○	14	13.7	23	UB94	3.898 - 4.370	99 - 110.99	○	94	90	71
UB15	0.709 - 0.748	18.01 - 19	○	15	14.4	23	UB106	4.370 - 4.842	111 - 122.99	○	106	102	71
UB16.5	0.748 - 0.787	19.01 - 19.99	○	16.5	15.4	23	UB118	4.843 - 5.315	123 - 134.99	○	118	114	71
UB18	0.787 - 0.866	20 - 21.99	○	18	16.5	26	UB130	5.315 - 5.866	135 - 148.99	○	130	126	71
UB20	0.866 - 0.984	22 - 24.99	○	20	19	26	UB142	5.866 - 6.378	149 - 161.99	○	142	139	71
UB22	0.984 - 1.063	25 - 26.99	○	22	20	26	UB154	6.378 - 6.850	162 - 173.99	○	154	151	86
UB24	1.063 - 1.181	27 - 29.99	○	24	22	26	UB166	6.850 - 7.322	174 - 185.99	○	166	163	86
UB26	1.181 - 1.259	30 - 31.99	○	26	24	26	UB178	7.323 - 7.795	186 - 197.99	○	178	175	86
UB28	1.260 - 1.338	32 - 33.99	○	28	26	26	UB190	7.795 - 8.267	198 - 209.99	○	190	187	86
UB30	1.339 - 1.456	34 - 36.99	○	30	27	41	UB202	8.268 - 8.740	210 - 221.99	○	202	199	86
UB33	1.457 - 1.574	37 - 39.99	○	33	30	41	UB214	8.740 - 9.212	222 - 233.99	○	214	211	86
UB36	1.575 - 1.732	40 - 43.99	○	36	33	41	UB226	9.213 - 9.685	234 - 245.99	○	226	223	86
UB39	1.732 - 1.850	44 - 46.99	○	39	37	41	UB238	9.685 - 10.157	246 - 257.99	○	238	235	86
UB43	1.850 - 2.047	47 - 51.99	○	43	41	41	UB250	10.157 - 10.63	258 - 269.99	○	250	247	121
UB47	2.047 - 2.244	52 - 56.99	○	47	44	41	UB262	10.63 - 11.102	270 - 281.99	○	262	259	121
UB51	2.244 - 2.401	57 - 60.99	○	51	49	41	UB274	11.102 - 11.574	282 - 293.99	○	274	271	121

Please specify the length (L) when ordering.
e.g. For ø60 mm drill diameter / 2600 mm drill tube length: UB51X2600

○ : Item to be customized

Reference pages: Drill head → **J128** (TRI-FINE STS-IN), **J133** (FINE BEAM STS-IN), **J138** (UNIDEX STS-IN)

TUBE LENGTH FOR SPECIAL DRILLS

Please use the below guide to calculate the drill tube length.

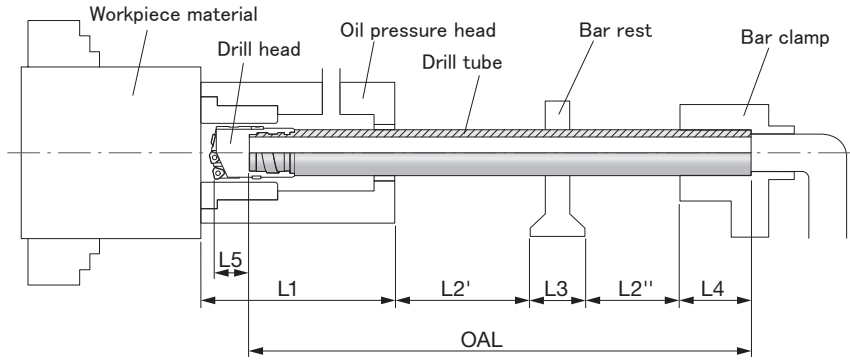

OAL = Drill tube whole length
 L1 = Oil pressure head length
 L2 = Drilling depth (L2' + L2'')
 L3 = Bar rest length
 L4 = Drill tube clamp length
 L5 = Length from drill tube tip and peripheral edge tip

$$\text{Drill tube length OAL} = L1 + L2 + L3 + L4 - L5$$

FINE-BEAM



DCN - DCX		L5
(in)	(mm)	
0.984 - 1.181	25 - 29.99	45
1.181 - 1.338	30 - 33.99	50
1.339 - 1.456	34 - 36.99	50
1.457 - 1.574	37 - 39.99	55
1.575 - 1.732	40 - 43.99	60
1.732 - 2.047	44 - 51.99	65
2.047 - 2.244	52 - 56.99	70
2.244 - 2.559	57 - 65	75

UNIDEX



DCN - DCX		L5
(in)	(mm)	
1.496 - 1.732	38 - 43.99	40
1.732 - 2.047	44 - 51.99	50
2.047 - 2.244	52 - 56.99	60
2.244 - 2.677	57 - 67.99	70
2.677 - 6.378	68 - 161.99	80
6.378 - 10.157	162 - 257.99	105
10.157 - 11.574	258 - 293.99	90

TRI-FINE



DCN - DCX		L5
(in)	(mm)	
0.63 - 0.65	16 - 16.5	31.5
0.65 - 0.679	16.51 - 17.25	31.5
0.68 - 0.709	17.26 - 18	31.5
0.709 - 0.748	18.01 - 19	31.5
0.748 - 0.787	19.01 - 19.99	31.5
0.787 - 0.866	20 - 21.99	33
0.866 - 0.984	22 - 24.99	35
0.984	25	35
0.985 - 1.063	25.01 - 26.99	40
1.063 - 1.102	27 - 28	40

Grade
 Insert
 Ext. Toolholder
 Int. Toolholder
 Threading
 Grooving
 Miniature Tool
 Milling Cutter
 Endmill
 Drilling Tool
 Tooling System
 User's Guide
 Index

A
 B
 C
 D
 E
 F
 G
 H
 I
 J
 K
 L
 M

OT & IT

OT & IT - for double tube system

Outer tube and inner tube for double tube system

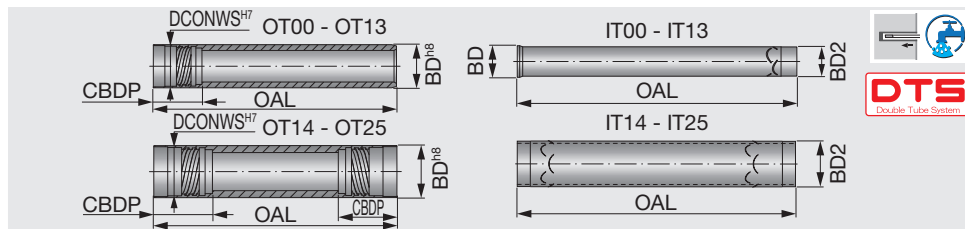
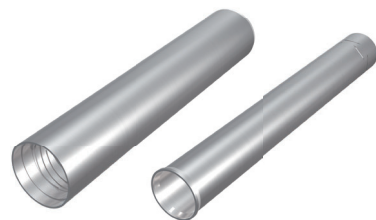

Outer tube (OT)

Inner tube (IT)

Metric	DCN - DCX		OAL Special length	BD	DCONWS	CBDP	Metric	DCN - DCX		OAL Special length	BD	BD2
	(in)	(mm)						(in)	(mm)			
OT00	0.724 - 0.787	18.4 - 20	○	18	16	27.5	IT00	0.724 - 0.787	18.4 - 20	○	12	10
OT01	0.788 - 0.858	20.01 - 21.8	○	19.5	18	30	IT01	0.788 - 0.858	20.01 - 21.8	○	14	12
OT02	0.859 - 0.949	21.81 - 24.1	○	21.5	19.5	30	IT02	0.859 - 0.949	21.81 - 24.1	○	15	13
OT03	0.949 - 1.039	24.11 - 26.4	○	23.5	21	30	IT03	0.949 - 1.039	24.11 - 26.4	○	16	14
OT04	1.040 - 1.130	26.41 - 28.7	○	26	23.5	33	IT04	1.040 - 1.130	26.41 - 28.7	○	18	16
OT05	1.130 - 1.220	28.71 - 31	○	28	25.5	33	IT05	1.130 - 1.220	28.71 - 31	○	20	18
OT06	1.221 - 1.311	31.01 - 33.3	○	30.5	28	33	IT06	1.221 - 1.311	31.01 - 33.3	○	22	20
OT07	1.311 - 1.425	33.31 - 36.2	○	33	30	40	IT07	1.311 - 1.425	33.31 - 36.2	○	24	22
OT08	1.426 - 1.559	36.21 - 39.6	○	35.5	33	40	IT08	1.426 - 1.559	36.21 - 39.6	○	26	24
OT09	1.559 - 1.693	39.61 - 43	○	39	36	40	IT09	1.559 - 1.693	39.61 - 43	○	29	27
OT10	1.693 - 1.850	43.01 - 47	○	42.5	39	40	IT10	1.693 - 1.850	43.01 - 47	○	32	30
OT11	1.851 - 2.035	47.01 - 51.7	○	46.5	43	44	IT11	1.851 - 2.035	47.01 - 51.7	○	35	32
OT12	2.036 - 2.213	51.71 - 56.2	○	51	47	44	IT12	2.036 - 2.213	51.71 - 56.2	○	39	36
OT13	2.213 - 2.559	56.21 - 65	○	55.5	51	44	IT13	2.213 - 2.559	56.21 - 65	○	43	40
OT14	2.559 - 2.637	65 - 66.99	○	56	52	75	IT14	2.559 - 2.637	65 - 66.99	○	-	40
OT15	2.756 - 2.874	70 - 72.99	○	62	58	75	IT15	2.756 - 2.874	70 - 72.99	○	-	44
OT16	2.874 - 3.149	73 - 79.99	○	68	63	75	IT16	2.874 - 3.149	73 - 79.99	○	-	48
OT17	3.150 - 3.425	80 - 86.99	○	75	70	97	IT17	3.15 - 3.425	80 - 86.99	○	-	54
OT18	3.425 - 3.937	87 - 99.99	○	82	77	97	IT18	3.425 - 3.937	87 - 99.99	○	-	60
OT19	3.937 - 4.409	100 - 111.99	○	94	89	97	IT19	3.937 - 4.409	100 - 111.99	○	-	70
OT20	4.409 - 4.881	112 - 123.99	○	106	101	118	IT20	4.409 - 4.881	112 - 123.99	○	-	80
OT21	4.882 - 5.354	124 - 135.99	○	118	113	118	IT21	4.882 - 5.354	124 - 135.99	○	-	80
OT22	5.354 - 5.826	136 - 147.99	○	130	125	118	IT22	5.354 - 5.826	136 - 147.99	○	-	95
OT23	5.827 - 6.299	148 - 159.99	○	142	137	139	IT23	5.827 - 6.299	148 - 159.99	○	-	100
OT24	6.299 - 6.771	160 - 171.99	○	154	149	139	IT24	6.299 - 6.771	160 - 171.99	○	-	120
OT25	6.772 - 7.244	172 - 183.99	○	166	161	139	IT25	6.772 - 7.244	172 - 183.99	○	-	130

○ : Item to be customized

Please specify the length when ordering.

e.g. For ø60 mm drill diameter / 1070 mm drill outer tube length: OT13X1070

Please choose the inner tube length according to the below.

- ▶ tool diameter: ø18.40 - 65.00 mm (OT00 - OT13) Inner tube length = Outer tube length + 30 mm
- ▶ tool diameter: ø65.00 - 123.99 mm (OT14 - OT20) Inner tube length = Outer tube length + 190 mm
- ▶ tool diameter: ø124.00 - 183.99 mm (OT21 - OT25) Inner tube length = Outer tube length + 220 mm

TUBE LENGTH FOR SPECIAL DRILLS

Please use the below guide to calculate the drill tube length.

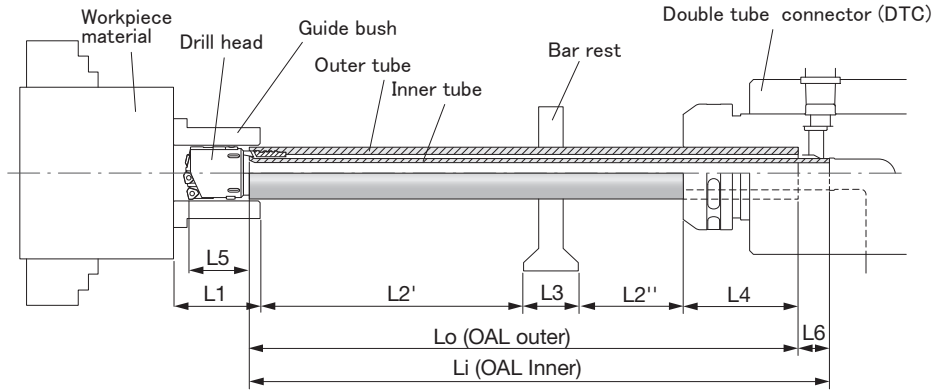

Lo = Outer tube whole length
 Li = Inner tube whole length
 L1 = Guide bush length (or Pilot hole depth)
 L2 = Drilling depth (L2' + L2'')
 L3 = Bar rest length
 L4 = Length of outer tube in connector *
 L5 = Length from drill tube tip and peripheral edge tip
 L6 = Difference between outer tube length and inner tube length

Outer tube length $Lo = L1 + L2 + L3 + L4 - L5$

Inner tube length $Li = Lo + L6$

DTC type	L4 *	L6 **
DTC 4R type (OT00 - OT13)	120	30
DTC 5R type (OT14 - OT20)	0	190
DTC 6R type (OT21 - OT25)	0	220

(mm)

The outer tube should enter in the guide bush or the pilot hole with at least 5 mm.

ETU



DCN - DCX		L5
(in)	(mm)	
0.724 - 0.787	18.4 - 20	20
0.788 - 0.949	20.01 - 24.1	23
0.949 - 1.130	24.11 - 28.7	24
1.130 - 1.311	28.71 - 33.3	27
1.311 - 1.425	33.31 - 36.2	26
1.426 - 1.598	36.21 - 40.6	29
1.599 - 1.693	40.61 - 43	28
1.693 - 1.850	43.01 - 47	30
1.851 - 2.035	47.01 - 51.7	29
2.036 - 2.213	51.71 - 56.2	32
2.213 - 2.299	56.21 - 58.4	34
2.300 - 2.559	58.41 - 65	33

FINE-BEAM



DCN - DCX		L5
(in)	(mm)	
0.984 - 1.039	25 - 26.4	40
1.040 - 1.220	26.41 - 31	42
1.221 - 1.311	31.01 - 33.3	47
1.311 - 1.425	33.31 - 36.2	50
1.426 - 1.559	36.21 - 39.6	55
1.559 - 1.850	39.61 - 47	60
1.851 - 2.035	47.01 - 51.7	66
2.036 - 2.559	51.71 - 65	71

UNIDEX



DCN - DCX		L5
(in)	(mm)	
1.496 - 1.693	38 - 43	45
1.693 - 1.850	43.01 - 47	55
1.851 - 2.035	47.01 - 51.7	51
2.036 - 2.213	51.71 - 56.2	56
2.213 - 2.559	56.21 - 65	66
2.559 - 3.149	65 - 79.99	75
3.150 - 4.409	80 - 111.99	83
4.409 - 5.826	112 - 147.99	87
5.827 - 7.244	148 - 183.99	86

TRI-FINE



DCN - DCX		L5
(in)	(mm)	
0.724 - 0.787	18.4 - 20	31.5
0.788 - 0.858	20.01 - 21.8	33.5
0.859 - 0.866	21.81 - 21.99	33.5
0.866 - 0.949	22 - 24.1	35.5
0.949 - 0.984	24.11 - 25	35.5
0.985 - 1.039	25.01 - 26.4	37.5
1.040 - 1.102	26.41 - 28	37.5

Grade
Insert
Ext. Toolholder
Int. Toolholder
Threading
Grooving
Miniature Tool
Milling Cutter
Endmill
Drilling Tool
Tooling System
User's Guide
Index



CONVERSION ADAPTER

Adapter for external thread - internal thread conversion

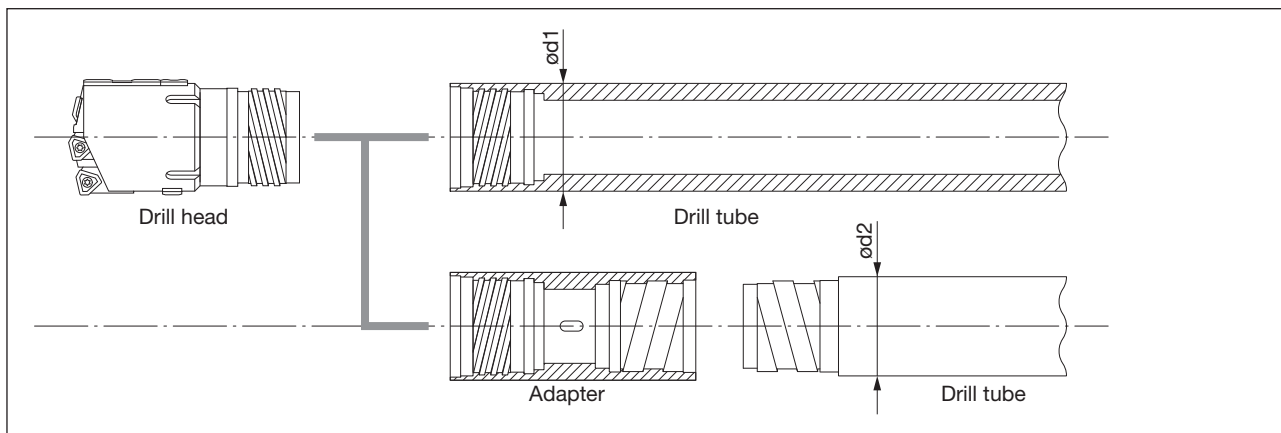

$\phi d1$: Outer diameter of the tube that is applicable for the drill head
 $\phi d2$: Outer diameter of the tube that is connected with the adapter

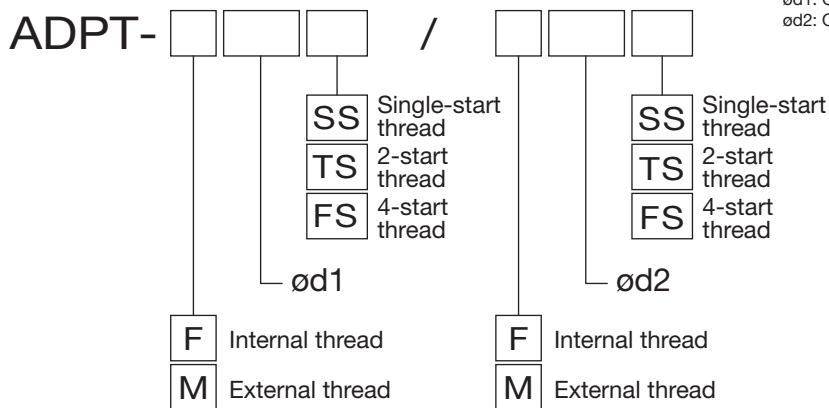

Designation example

For the conversion from ST11 to UB47

ADPT-F47FS / F47SS

↑ ↑
 ST11 UB47

* The adapters to change sizes will be available upon request.

HF Drill : Indexable drill for deep hole

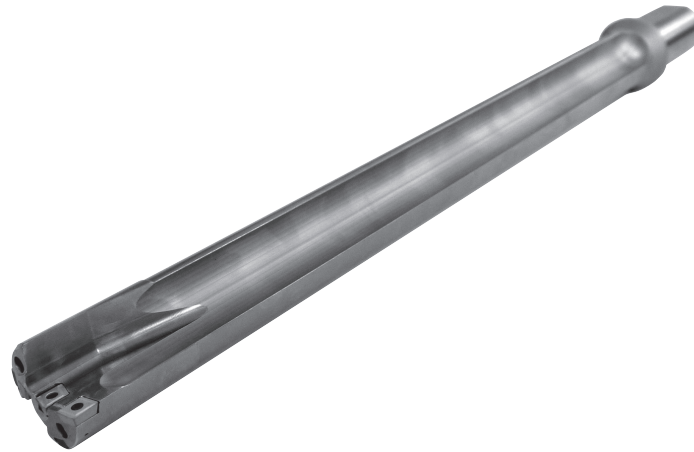

■ Economical for middle range deep hole drilling

- Tool diameter range: $\varnothing 30$ - $\varnothing 63$ mm (*)
- Drilling depth: 6xD - 14xD
- Shortened drilling time when using conventional machine
- * Other diameters are available upon request.

■ Effective machining on conventional machines

- Recommended for use on Horizontal M/C
- Can also be used on turning machine

■ Good chip evacuation

- FBM inserts enable best chip control
- Unique head design eliminates chip jamming
- Curved flute design ensures good chip evacuation

■ Easy to use, rigid drill body

- Direct mount inserts, no diameter adjustment necessary
- Body is made from heat treated tool steel

■ High quality surface finish

- Burnishing effect improves surface finish
- Possible to eliminate finish process

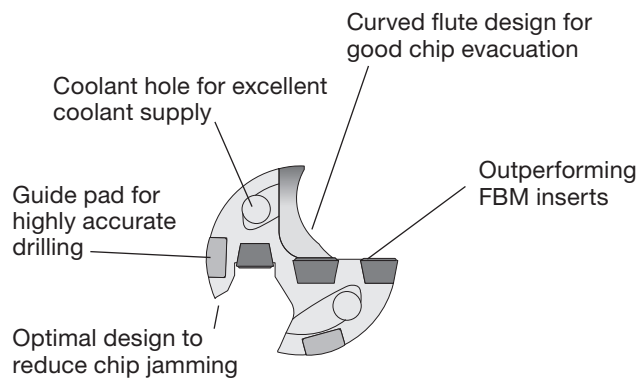

Grade

Insert

Ext. Toolholder

Int. Toolholder

Threading

Grooving

Miniature Tool

Milling Cutter

Endmill

Drilling Tool

Tooling System

User's Guide

Index

● PRACTICAL EXAMPLE

Cutting conditions

Tool diameter DC: $\varnothing 30$ mm
 Drilling depth: 200 mm
 Workpiece material: S45C
 Cutting speed V_c : 100 m/min
 Feed f : 0.1 mm/rev
 Machine: BT50 M/C

No spiral marks caused by chips

Burnishing effect by guide pads improves surface finish

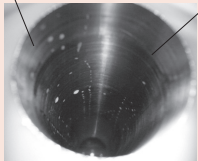

BT50 M/C Machining data

Excellent chip evacuation ensures the stable drilling on M/C.

Cutting speed V_c (m/min)

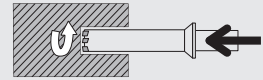
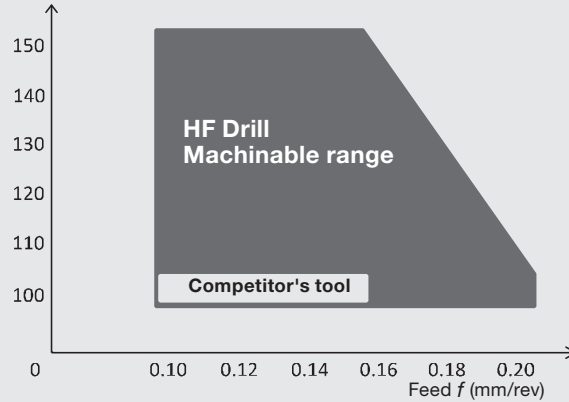

- Water-soluble coolant
- Pressure: 1.5 MPa
- Through spindle

Tool diameter DC: $\varnothing 30$ mm
 Drilling depth: 200 mm
 Workpiece material: S45C
 Cutting speed V_c : 100 - 150 m/min
 Feed f : 0.1 - 0.2 mm/rev
 Machine: BT50 Horizontal M/C (Max 11 kW)

Cautionary points in use

To start the tool, a pilot hole is required. (tolerance: + 0.1 to 0.15 mm)

Tool diameter DC (mm)	Pilot hole length H (mm)
$\varnothing 30 \sim \varnothing 39$	over 10
$\varnothing 39.01 \sim \varnothing 45$	over 12.5
$\varnothing 45.01 \sim \varnothing 57$	over 15
$\varnothing 57.01 \sim \varnothing 63$	over 17.5

- The pilot hole should ideally have a flat bottom, but generally an indexable drill is acceptable to create a pilot hole if the inner insert touches the bottom last.
- DrillForce-Meister series or TDX drills are recommended for a pilot hole drilling.

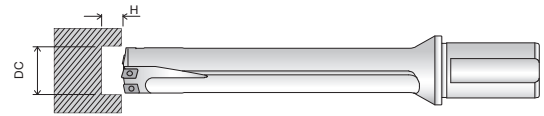

Tooling System



Tooling System - Content structure

Products are listed by series.

Please refer the table of contents.

Tooling items in the catalog are our standard stock items.

How to use the page

Method 1.

Select the series name (1) described at the left end of each page and choose a designation you need (4) in the dimension table (3).

1 Name of the series

4 Designation

3 Dimension table

Method 2.

Select the series name on K003 and check the details on the product page.

2 Series name and item

5 Dimension

4 Designation

3 Dimension drawing (conforming to ISO13399)

6 Spare parts

7 Reference pages

2 Series name and item

5 Dimension

4 Designation

3 Dimension drawing (conforming to ISO13399)

6 Spare parts

7 Reference pages

When ordering



- Please specify the designation and quantity.
e.g. Chuck: **CAT 40 ER32X4.000** ... 1 (one chuck per package)

Collet: **ER32 SPR6-7** ... 1 (one collet per package)

*The designation in the catalog may be described with spaces. Please remove such spaces.

*Inserts are sold separately.

Main products

		Inch	Metric
	TUNGCAP Quick change system with polygon PSC coupling tooling K004 - K054	<input type="checkbox"/>	<input checked="" type="checkbox"/>
	TUNGHOLD Tooling system for holders with unique functions in wide varieties HSK A/E - K055 CAT - K079 Tung Shrink - K064 K055 - K135	<input checked="" type="checkbox"/>	<input checked="" type="checkbox"/>
	Other tooling system Spin Jet - K136 Swiss Bore - K142 K136 - K153	<input checked="" type="checkbox"/>	<input checked="" type="checkbox"/>



Productivity increases when used on CNC turret lathes / turning centers

Reduce downtime in your machine

- Short setup time - no tool adjustment required on the machine
- Once adjusted outside the machine, high precision

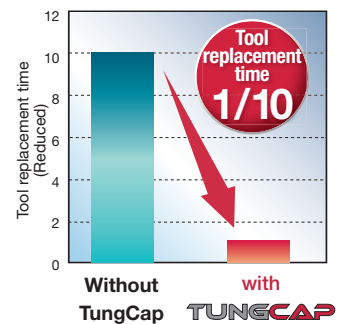

Measurement outside the machine

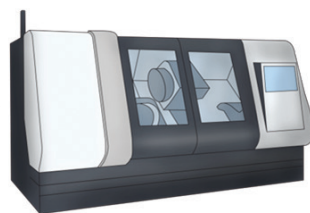

Input measured data



Short tool change time

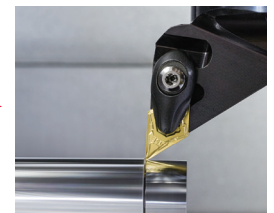

High precision in simple process

Reference pages: **K006 - K054**

Breakdown for total operation time

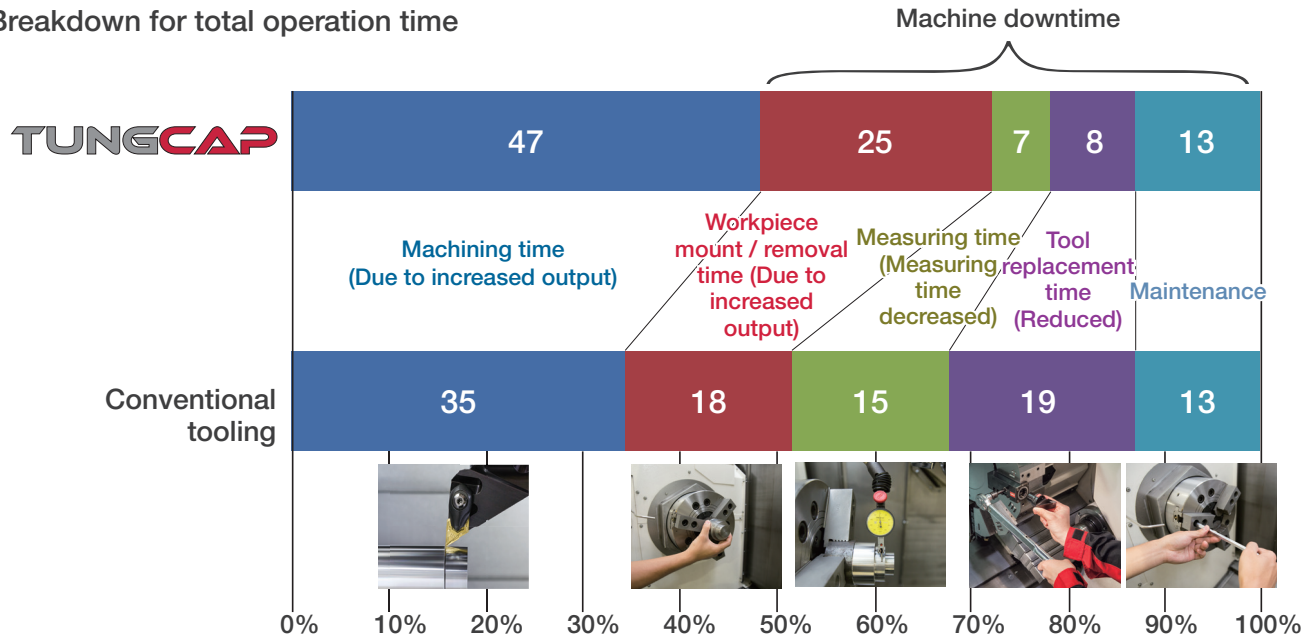

Tooling for multi-tasking machine

A multi-tasking machine is a combination of a turning center and a machining center, which allows a workpiece to be completed in a single machine setup. TungCap offers a complete range of efficient tooling solutions in such a highly advanced machine-tool.

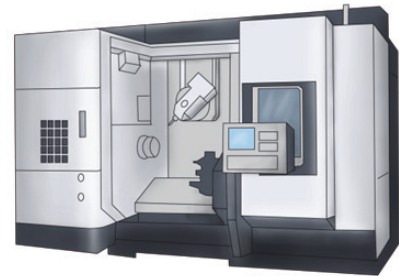

Easy tool management

Suitable for a wide range of applications

- TungCap modular system enhances tooling flexibility in a wide range of applications, without compromising other interface adapters
- Dual contact Cat holders for USA also available

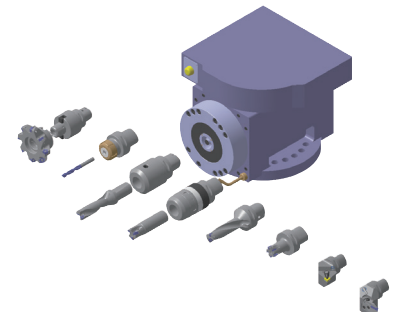

Ideal tooling

An optimized overhang length can be set with an extension or reduction holder

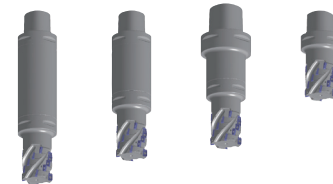

Cutting heads for a B-axis locked at 45° in multi-tasking machines

A large radial stroke is possible for B-axis
 Heavy-duty machining is possible due to diverse cutting force
 No interference in machining corner radii



Grade
 Insert
 Toolholder
 Ext. Toolholder
 Int. Toolholder
 Threading
 Grooving
 Grooving
 Miniature Tool
 Milling Cutter
 Endmill
 Drilling Tool
 Tooling System
 User's Guide
 Index



Turning tool

<p>CN**43 / CN**1204 CN**33 / CN**0904</p>  <p>B056 -</p>	 <p>C*PCLNR/L****-CHP K009</p>	 <p>C*PCLNR/L****-12N K008</p>	 <p>C*ACLNR/L****-N K008</p>	 <p>C6PCMNN**--CHP K010</p>	 <p>C*ACLNN00****-N K009</p>	<p>Cutting head for external turning & facing</p>
<p>DN**43 / DN**1504 (DN**44 / DN**1506)</p>  <p>B067 -</p>	 <p>C*PDJNR/L****-CHP K013</p>	 <p>C*PDJNR/L****-15N K012</p>	 <p>C*ADJNR/L****-N K012</p>	 <p>C6PDMNL**--CHP K013</p>	 <p>C*ADNNN00****-15N K016</p>	
<p>WN**43 / WN**0804 WN**33 / WN**0604</p>  <p>B101 -</p>	 <p>C*PWLNR/L****-CHP K011</p>	 <p>C*AWLNR/L****-N K011</p>	<p>VN**33 / VN**1604</p>  <p>B096 -</p>	 <p>C*PVJNR/L****-16-CHP K015</p>	 <p>C*AVJNR/L****-16N K015</p>	
			<p>VC**33 / VC**1604</p>  <p>B155 -</p>	 <p>C*SVJCR/L****-16N K016</p>	 <p>C*SVVCN00****-16N K017</p>	
<p>DN**33 / DN**1104</p>  <p>B067 -</p>	 <p>C4PDUNR/L****-11 K019</p>	<p>DN**43 / DN**1504</p>  <p>B067 -</p>	 <p>C*ADUNR/L****-15 K019</p>	<p>CN**43 / CN**1204 CN**33 / CN**0904</p>  <p>B056 -</p>	 <p>C4PCLNR/L****-N K018</p>	
<p>DRILLMEISTER J010</p>  <p>Side-lock holder (For weldon-shank) C*EM**X** K033</p>	 <p>Side-lock holder (For whistle-notch shank) C*EM**X**E K034</p>	<p>Boring bar</p>  <p>D022 -</p>	<p>Sleeve SC**** K031</p> 	<p>Boring bar Adapter C*ABB**** K031 C*ADI** K032</p> 	<p>Cutting head for internal turning</p>	
<p>TUNGDRILL J074 TUNGSIX-DRILL J065</p> 	<p>TungDrill Twisted drill C*TDX****L***-3 K027</p> 					
<p>16ER/L**</p>  <p>E010 -</p>	 <p>C*CER/L****-16ERN K021</p>	<p>Cutting head for threading</p>				
<p>DGS, SGS, DGM, SGM, DTX, DTE, DGG, DTR, SGN, DTM, DGL</p>  <p>F178 -</p>	<p>Blade</p>  <p>F175 -</p>	<p>Adapter for parting-off blade</p>  <p>K032</p>	 <p>C*CHSR/L****N K022</p>	 <p>C*CHFVR/L****N K022</p>	<p>Cutting head for grooving</p>	
<p>Toolholder for external turning</p>  <p>C018 -</p>	 <p>C*ADES-20 K029</p>	 <p>C*ASHR/L**--45 K030</p>	 <p>C*ASHR/L*** K029</p>	 <p>C*ASHA20 K029</p>	 <p>C*ADE-**R/L K029</p>	<p>Adapter for toolholder with square shank</p>

Please see the page **B/C/E/F/J/K***** for the product details.

System for Multi-Tasking Machine

TOOLING SYSTEM

Tool spindle

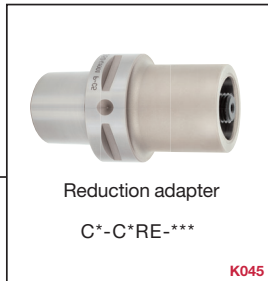
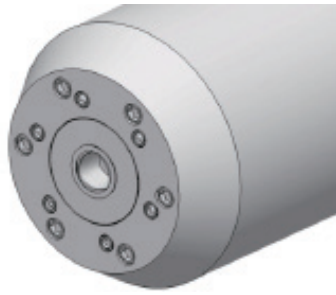

Rotating tool

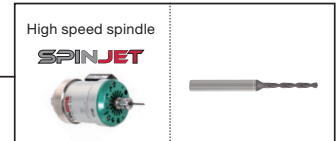
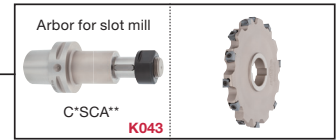
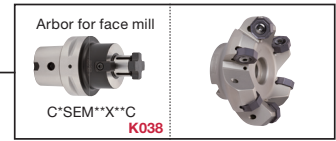
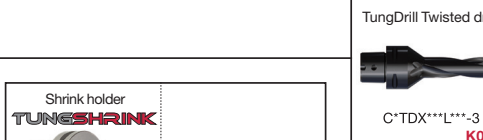
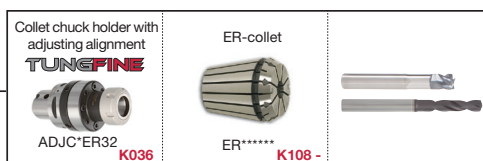
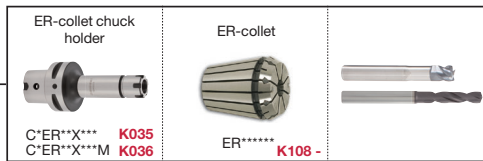
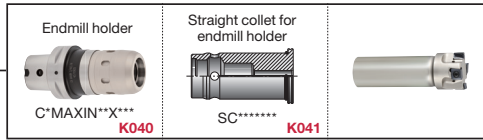

MULTICLAMPC*



MULTICLAMPC*
K045

Grade
Insert
Toolholder
Ext. Toolholder
Int. Toolholder
Threading
Grooving
Miniature Tool
Milling Cutter
Endmill
Drilling Tool
Tooling System
User's Guide
Index



Please see the page B/C/E/F/J/K*** for the product details.

Double-clamp toolholder, with 95° approach angle, for negative 80° rhombic inserts

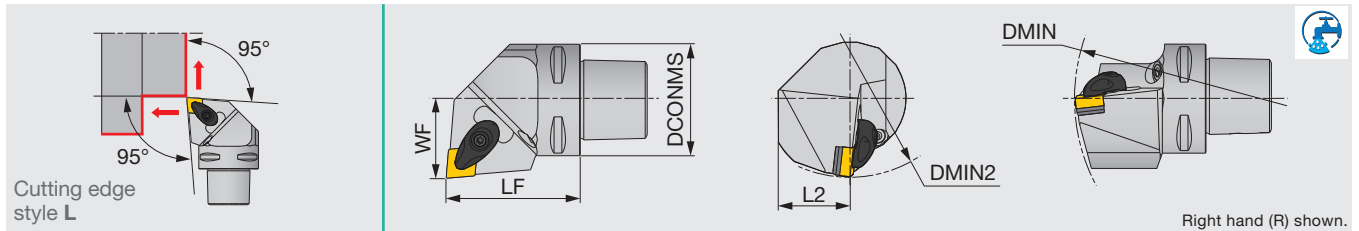

Right hand (R) shown.

Metric	DCONMS	LF	L2	WF	DMIN	DMIN2	RE	Insert
C3ACLNR/L22040-0904N	32	40	20	22	110	121	0.8	CN**0904**E
C4ACLNR/L27050-0904N	40	50	25	27	140	110	0.8	CN**0904**E
C4ACLNR/L27050-12N	40	50	25	27	140	110	0.8	CN**1204...
C5ACLNR/L35060-12N	50	60	32	35	165	110	0.8	CN**1204...
C6ACLNR/L45065-0904N	63	65	35	45	190	110	0.8	CN**0904**E
C6ACLNR/L45065-12N	63	65	41	45	190	125	0.8	CN**1204...
C6ACLNR/L45065-16N	63	65	41	45	190	125	1.2	CN**1604...

Applicable for 7 MPa coolant

SPARE PARTS	Clamp	Clamping screw	Coolant parts	Shim	Shim screw	Spring	Spring pin	Wrench 1	Wrench 2
C*ACLNR***-0904N	ACP3S-E	ACS-5W	SATZ-M10X1-5	ASC322	CSTB-3.5	BP-7	SP-2.5	-	T-15F
C*ACLNR***-12N	ACP4S	ACS-5W	SATZ-M8X1-M3	ASC422	CSTB-3.5	BP-7	SP-2.5	-	T-15F
C6ACLNR*45065-16N	ACP5S	ACS-6W	SATZ-M8X1-M3	ASC533	CSTB-5	BP-8.8	SP-2.5	KEYV-T20	-

C-PCLNR/L

Lever-lock toolholder, with 95° approach angle, for negative 80° rhombic inserts

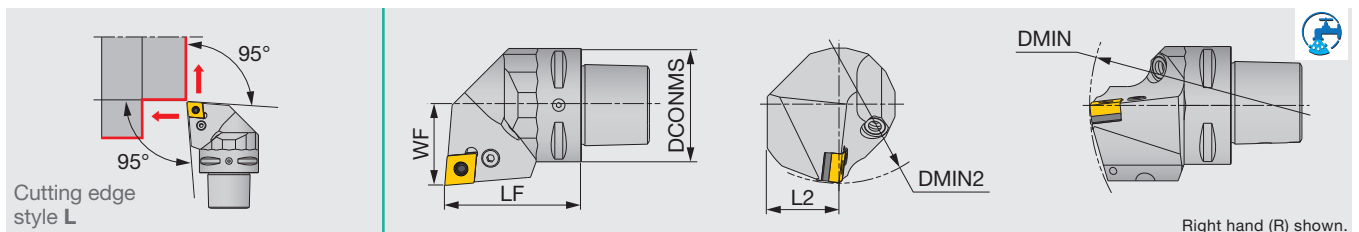

Right hand (R) shown.

Metric	DCONMS	LF	L2	WF	DMIN	DMIN2	RE	Insert
C5PCLNR/L35060-12	50	60	32	35	-	-	0.8	CN**1204...
C5PCLNR/L35060-12N	50	60	32	35	165	110	0.8	CN**1204...
C6PCLNR/L45065-12N	63	65	41	45	190	125	0.8	CN**1204...

The item without DMIN and DMIN2 cannot be used for boring.
Applicable for 7 MPa coolant

SPARE PARTS	Coolant parts	Lever	Clamping screw	Shim	Spring pin	Wrench
C5PCLNR*35060-12	EZ104	LCL4	LCS4	LSC42	LSP4	P-3
C*PCLNR***-12N	SATZ-M10X1-M5	LCL4	LCS4	LSC42	LSP4	P-3

Reference pages: C-ACLNR/L, C-PCLNR/L: Inserts → **B056 -**, CBN → **B172 -**, PCD → **B194 -**

Lever-lock toolholder, with 95° approach angle, for negative 80° rhombic inserts, with high pressure coolant capability

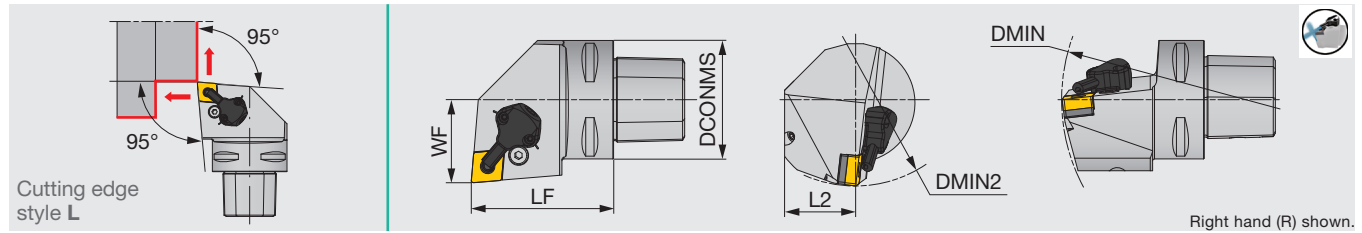

Metric	DCONMS	LF	L2	WF	DMIN	DMIN2	RE	Insert
C4PCLNR/L27050-0904-CHP	40	50	25	27	140	110	0.8	CN**0904...
C4PCLNR/L27050-12-CHP	40	50	25	27	140	110	0.8	CN**1204...
C5PCLNR/L35060-12-CHP	50	60	32	35	165	110	0.8	CN**1204...
C6PCLNR/L45065-0904-CHP	63	65	41	45	190	125	0.8	CN**0904...
C6PCLNR/L45065-12-CHP	63	65	41	45	190	125	0.8	CN**1204...

Applicable for 14 MPa coolant

SPARE PARTS						COOLANT SET				
Designation	Shim	Clamping screw	Spring pin	Lever	Wrench	Designation	Coolant unit	Mounting screw	Wrench	O-ring
C*PCLNR/L**12-CHP	LSC42	LCS4	LSP4	LCL4	P-3	C*PCLNR/L**CHP	CU-CW-CHP	SRM3	T-8F	OR6.4X0.9N
C*PCLNR/L**0904-CHP	LSC317	LCS3	LSP3	LCL33	P-2.5					

C-ACLNN

Double-clamp toolholder, with 50° approach angle, for negative 80° rhombic inserts

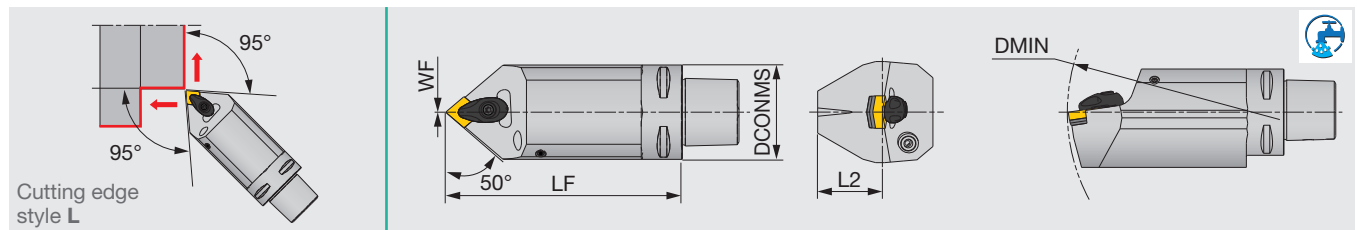

Metric	DCONMS	LF	L2	WF	DMIN	RE	Insert
C5ACLNN00090-12 ⁽¹⁾	50	90	32	0	-	0.8	CN**1204...
C5ACLNN00090-12N ⁽²⁾	50	90	32	0	165	0.8	CN**1204...
C5ACLNN00125-12 ⁽¹⁾	50	125	32	0	-	0.8	CN**1204...
C5ACLNN00125-12N ⁽²⁾	50	125	32	0	165	0.8	CN**1204...
C6ACLNN00100-12N ⁽²⁾	63	100	37.5	0	190	0.8	CN**1204...
C6ACLNN00140-12N ⁽²⁾	63	140	37.5	0	190	0.8	CN**1204...

The items without DMIN cannot be used for boring.

(1) Applicable for 3 MPa coolant (2) Applicable for 7 MPa coolant

SPARE PARTS									
Designation	Clamp	Clamping screw	Coolant parts	Shim	Shim screw	Spring	Spring pin	Wrench	
C5ACLNN00090-12	ACP4S	ACS-5W	EZ83	ASC422	CSTB-3.5	BP-7	SP-2.5	T-15F	
C5ACLNN00090-12N	ACP4S	ACS-5W	SATZ-M8X1-M3	ASC422	CSTB-3.5	BP-7	SP-2.5	T-15F	
C5ACLNN00125-12	ACP4S	ACS-5W	EZ83	ASC422	CSTB-3.5	BP-7	SP-2.5	T-15F	
C5ACLNN00125-12N	ACP4S	ACS-5W	SATZ-M8X1-M3	ASC422	CSTB-3.5	BP-7	SP-2.5	T-15F	
C6ACLNN00100-12N	ACP4S	ACS-5W	SATZ-M8X1-M3	ASC422	CSTB-3.5	BP-7	SP-2.5	T-15F	
C6ACLNN00140-12N	ACP4S	ACS-5W	SATZ-M8X1-M3	ASC422	CSTB-3.5	BP-7	SP-2.5	T-15F	

Reference pages: C-PCLNR/L-CHP, C-ACLNN: Inserts → **B056 -**, CBN → **B172 -**, PCD → **B194 -**



Double-clamp toolholder, with 50° approach angle, for negative 80° rhombic inserts

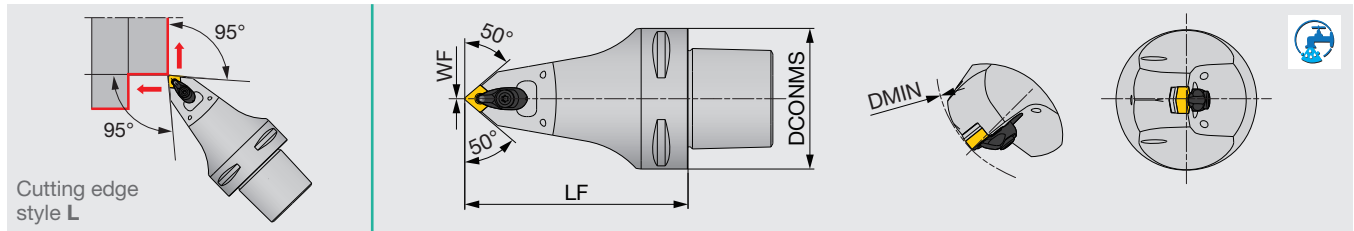

Metric	DCONMS	LF	WF	DMIN	RE	Insert
C6ACMNN00100-0904N	63	100	0	110	0.8	CN**0904**E
C6ACMNN00140-0904N	63	140	0	110	0.8	CN**0904**E
C6ACMNN00100-12N	63	100	0	110	0.8	CN**1204...
C6ACMNN00140-12N	63	140	0	110	0.8	CN**1204...

Applicable for 7 MPa coolant

SPARE PARTS

Designation	Clamp	Clamping screw	Shim	Shim screw	Spring	Spring pin	Wrench
C6ACMNN001**-0904N	ACP3S-E	ACS-5W	ACS322	CSTB-3.5	BP-7	SP-2.5	T-15F
C6ACMNN001**-12N	ACP4S	ACS-5W	ASC422	CSTB-3.5	BP-7	SP-2.5	T-15F

C-PCMNN-CHP

Lever-lock toolholder, with 50° approach angle, for negative 80° rhombic inserts, with high pressure coolant capability

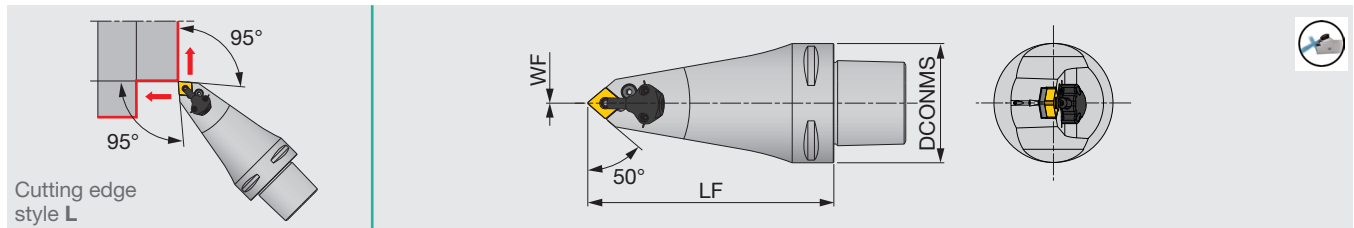

Metric	DCONMS	LF	WF	RE	Insert
C6PCMNN00130-12-CHP	63	130	0	0.8	CN**1204...

Applicable for 14 MPa coolant

Cannot be used for boring.

SPARE PARTS

Designation	Shim	Spring pin	Lever	Clamping screw	Wrench	Coolant unit
C6PCMNN00130-12-CHP	LSC42	LSP4	LCL4	LCS4	P-3	CU-CW-CHP

COOLANT SET

Designation	Coolant unit	Mounting screw	Wrench 2	O-ring
C6PCMNN00130-12-CHP	CU-CW-CHP	SRM3	T-8F	OR6.4X0.9N

Reference pages: C-ACMNN, C-PCMNN-CHP: Inserts → **B056 -**, CBN → **B172 -**, PCD → **B194 -**

Double-clamp toolholder, with 95° approach angle, for negative 80° trigon inserts

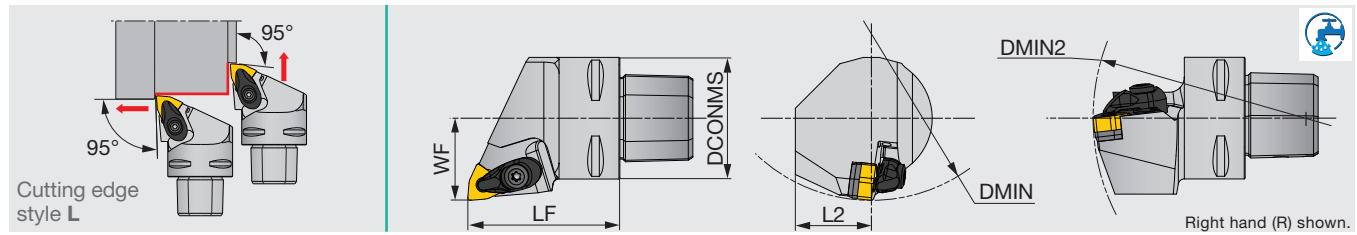

Metric	DCONMS	LF	L2	WF	DMIN	DMIN2	RE	Insert
C4AWLNR/L27050-0604N	40	50	25	27	140	110	0.8	WN**0604...
C4AWLNR/L27050-08N	40	50	25	27	-	-	0.8	WN**0804...
C6AWLNR/L45065-08N	63	65	35	45	190	110	0.8	WN**0804...

The items without DMIN and DMIN2 cannot be used for boring.
Applicable for 7 MPa coolant

SPARE PARTS

Designation	Clamp	Clamp screw	Coolant parts	Shim	Shim screw	Spring	Spring pin	Wrench
C4AWLNR/L27050-0604N	ACP3S-E	ACS-5W	-	ASW322	CSTB-3.5	BP-7	SP-2.5	T-15F
C4AWLNR/L27050-08N	ACP4S	ACS-5W	-	ASW422	CSTB-3.5	BP-7	SP-2.5	T-15F
C6AWLNR/L45065-08N	ACP4S	ACS-5W	SATZ-M8X1-M3	ASW422	CSTB-3.5	BP-7	SP-2.5	T-15F

Lever-lock toolholder, for negative 80° trigon inserts, with high pressure coolant capability

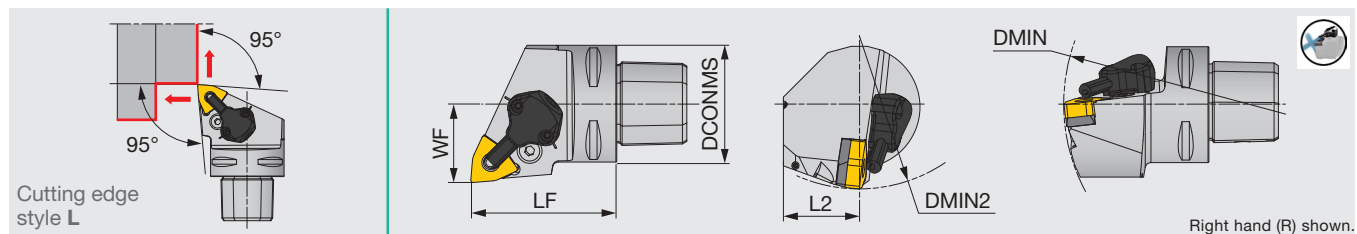

Metric	DCONMS	LF	L2	WF	DMIN	DMIN2	RE	Insert
C4PWLNR/L27050-0604-CHP	40	50	25	27	140	110	0.8	WN**0604...
C4PWLNR/L27050-08-CHP	40	50	25	27	140	110	0.8	WN**0804...
C6PWLNR/L45065-08-CHP	63	65	41	45	190	125	0.8	WN**0804...

Applicable for 14 MPa coolant

SPARE PARTS

Designation	Shim	Clamping screw	Spring pin	Lever	Wrench	Designation	Coolant unit	Mounting screw	Wrench	O-ring
C*PWLNR/L**08-CHP	LSW42BL	LCS4	LSP4	LCL4	P-3	C*PWLNR/L**08-CHP	CU-CW-CHP	SRM3	T-8F	OR6.4X0.9N
C*PWLNR/L**0604-CHP	LSW312	LCS3	LSP3	LCL3	P-2.5					

COOLANT SET



C-ADJNR/L

Double-clamp toolholder, with 93° approach angle, for negative 55° rhombic inserts

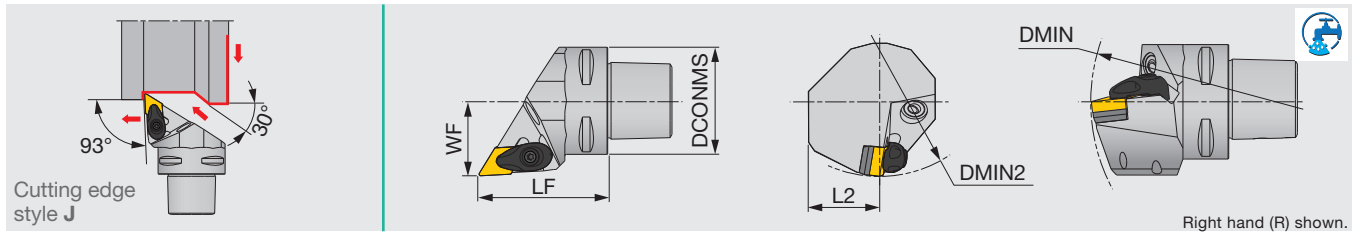

Metric	DCONMS	LF	L2	WF	DMIN	DMIN2	RE	Insert
C3ADJNR/L22050-1104N	32	50	20	22	121	85	0.8	DN**1104...
C4ADJNR/L27050-1104N	40	50	25	27	145	110	0.8	DN**1104...
C4ADJNR/L27050-15N	40	50	25	27	145	110	0.8	DN**15...
C5ADJNR/L35060-15N	50	60	32	35	165	110	0.8	DN**15...
C6ADJNR/L45065-1104N	63	65	35	45	190	110	0.8	DN**1104...
C6ADJNR/L45065-15N	63	65	41	45	190	110	0.8	DN**15...
C6ADJNR/L45135-15N	63	135	41	45	190	110	0.8	DN**15...

Applicable for 7 MPa coolant

SPARE PARTS	Clamp	Clamping screw	Coolant parts	Shim	Shim screw	Spring	Spring pin	Wrench
C*ADJN**-1104N	ACP3S-E	ACS-5W	-	ASD322	CSTB-3.5	BP-7	SP-2.5	T-15F
C4ADJN*27050-15N	ACP4S	ACS-5W	-	ASD432	CSTB-3.5	BP-7	SP-2.5	T-15F
C5ADJN*35060-15N	ACP4S	ACS-5W	SATZ-M10X1-M5	ASD432	CSTB-3.5	BP-7	SP-2.5	T-15F
C6ADJN*45065-15N	ACP4S	ACS-5W	SATZ-M10X1-M5	ASD432	CSTB-3.5	BP-7	SP-2.5	T-15F
C6ADJN*45135-15N	ACP4S	ACS-5W	SATZ-M10X1-M5	ASD432	CSTB-3.5	BP-7	SP-2.5	T-15F

Option: ASD423 (Shim for DN**1506**)

TUNGCAP**C-PDJNR/L**

Lever-lock toolholder, with 93° approach angle, for negative 55° rhombic inserts

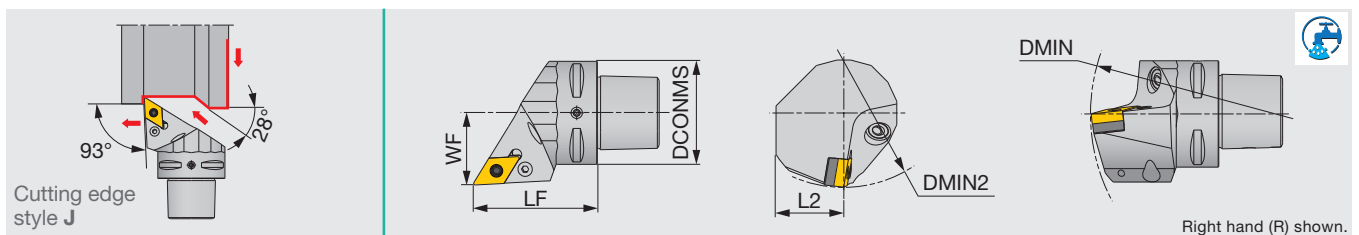

Metric	DCONMS	LF	L2	WF	DMIN	DMIN2	RE	Insert
C5PDJNR/L35060-15N	50	60	32	35	165	110	0.8	DN**1504(06)
C6PDJNR/L45065-15N	63	65	41	45	195	95	0.8	DN**1504(06)

Applicable for 7 MPa coolant

SPARE PARTS	Coolant parts	Shim	Lever	Clamping screw	Spring pin	Wrench
C5PDJN*35060-15N	SATZ-M10X1-M5	LSD43A	LCL4	LCS4	LSP4	P-3
C6PDJN*45065-15N	SATZ-M10X1-M5	LSD43A	LCL4	LCS4	LSP4S	P-3

Option: LSD42A (Shim for DN**1506**), LSP4S (Spring pin for DN**1506**)

Reference pages: C-ADJNR/L, C-PDJNR/L: Inserts → **B067 -**, CBN → **B174 -**, PCD → **B194 -**

Lever-lock toolholder, with 93° approach angle, for negative 55° rhombic inserts, with high pressure coolant capability

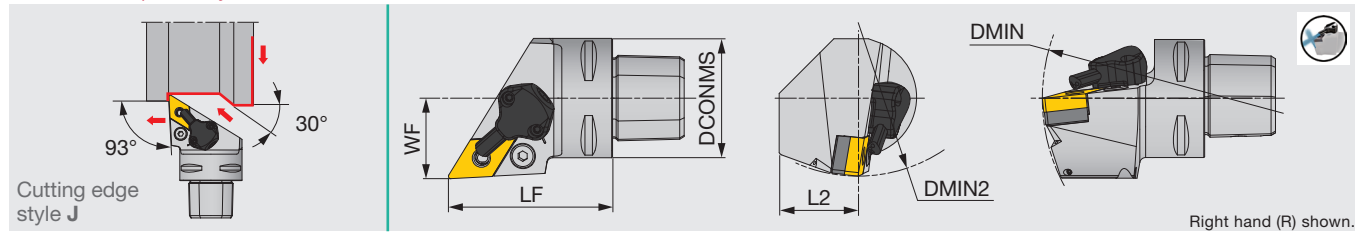

Metric	DCONMS	LF	L2	WF	DMIN	DMIN2	RE	Insert
C4PDJNR/L27055-1104-CHP	40	55	25	27	140	110	0.8	DN**1104...
C4PDJNR/L27055-15-CHP	40	55	25	27	140	110	0.8	DN**1504(06)...
C5PDJNR/L35060-15-CHP	50	60	32	35	165	110	0.8	DN**1504(06)...
C6PDJNR/L45065-1104-CHP	63	65	41	45	190	110	0.8	DN**1104...
C6PDJNR/L45065-15-CHP	63	65	41	45	190	110	0.8	DN**1504(06)...

Applicable for 14 MPa coolant

SPARE PARTS						COOLANT SET				
Designation	Shim	Clamping screw	Spring pin	Lever	Wrench	Designation	Coolant unit	Mounting screw	Wrench	O-ring
C*PDJNR/L**-15-CHP	LSD43A	LCS4	LSP4	LCL4	P-3	C*PDJLNR/L**-CHP	CU-D-CHP	SRM3	T-8F	OR6.4X0.9N
C*PDJNR/L**1104-CHP	ELSD32	LCS3	LSP3	LCL33L	P-2.5					

Option: LSD42A (Shim for DN**1506**), LSP4S (Spring pin for DN**1506**)

Lever-lock toolholder, with 48° approach angle, for negative 55° rhombic inserts, with high pressure coolant capability

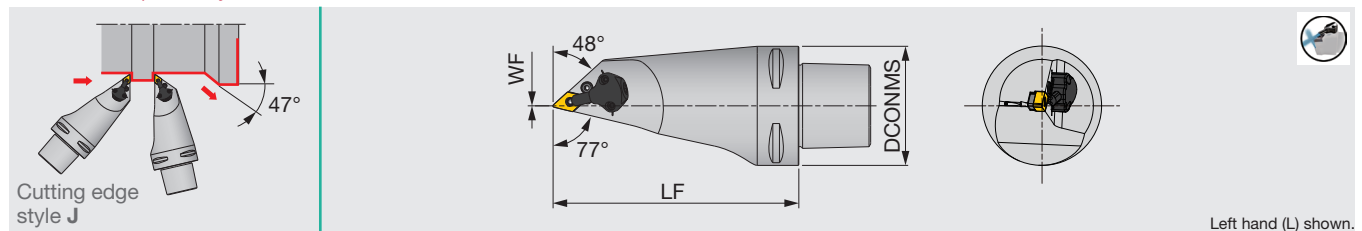

Metric	DCONMS	LF	WF	RE	Insert
C6PDMNL00130-1104-CHP	63	130	0	0.8	DN**1104...

Applicable for 14 MPa coolant

Cannot be used for boring

SPARE PARTS						
Designation	Shim	Spring pin	Lever	Clamping screw	Wrench	Coolant unit
C6PDMNL00130-1104-CHP	ELSD32	LSP3	LCL33L	LCS3	P-2.5	CU-D-CHP

COOLANT SET				
Designation	Coolant unit	Mounting screw	Wrench 2	O-ring
C6PDMNL00130-1104-CHP	CU-D-CHP	SRM3	T-8F	OR6.4X0.9N



Double-clamp toolholder, with 93° approach angle, for negative 60° triangular inserts

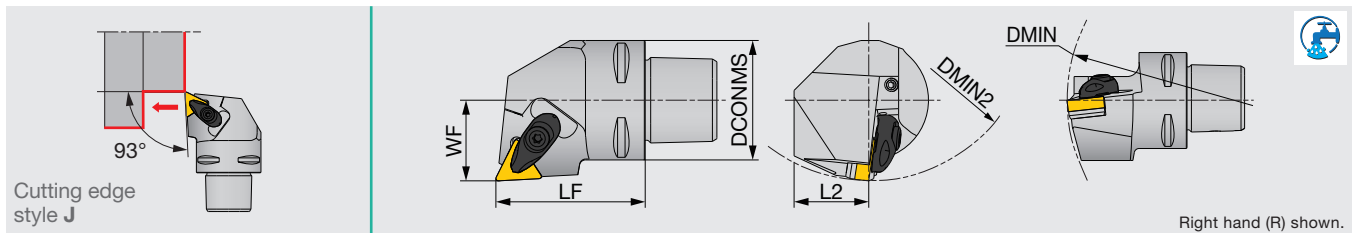

Right hand (R) shown.

Metric	DCONMS	LF	L2	WF	DMIN	DMIN2	RE	Insert
C4ATJNR/L27050-16N	40	50	25	27	140	110	0.8	TN**1604...

Applicable for 7 MPa coolant

SPARE PARTS

Designation	Clamp	Clamp screw	Shim	Shim screw	Spring	Spring pin	Wrench
C4ATJNR/L...	ACP3S	ACS-5W	AST322	CSTB-3.5	BP-7	SP-2.5	T-15F

TUNECAP

C-PTJNR/L

Lever-lock toolholder, with 93° approach angle, for negative 60° triangular inserts

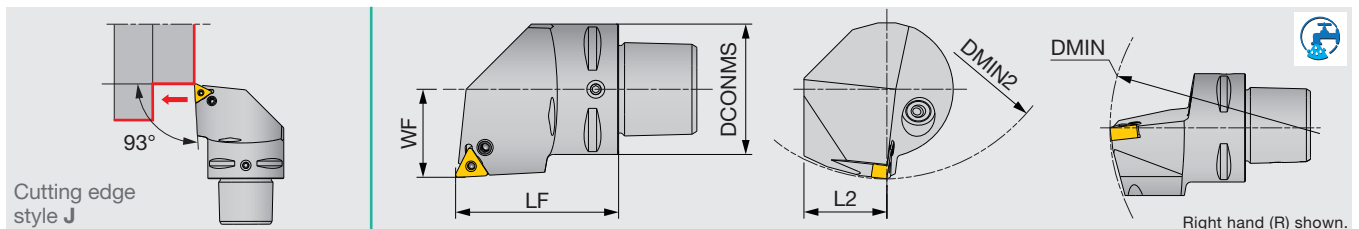

Right hand (R) shown.

Metric	DCONMS	LF	L2	WF	DMIN	DMIN2	RE	Insert
C4PTJNR/L27050-1104N	40	50	25	27	140	110	0.8	TN**1104**E

Applicable for 7 MPa coolant

SPARE PARTS

Designation	Coolant parts	Lever	Clamping screw	Wrench
C4PTJNR/L27050-1104N	SATZ-M8X1-M3	LCL23	LCS23A	P-2.5

Reference pages: C-ATJNR/L: Inserts → **B086 -**, CBN → **B178 -**, PCD → **B194 -**
 C-PTJNR/L: Inserts → **B086 -**

Double-clamp toolholder, with 93° approach angle, for negative 35° rhombic inserts

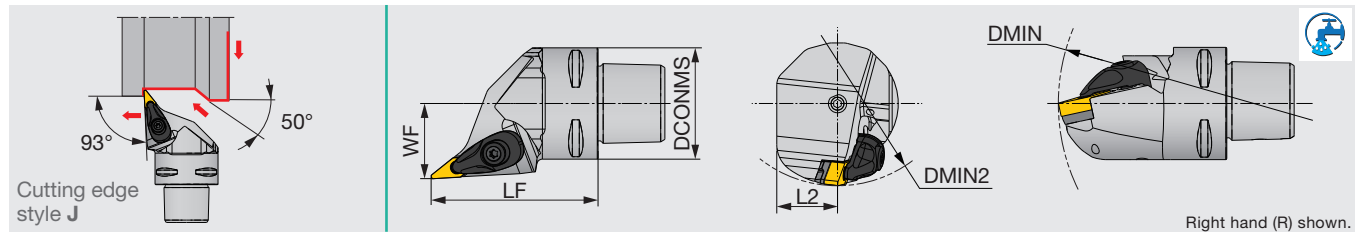

Metric	DCONMS	LF	L2	WF	DMIN	DMIN2	RE**	Insert
C4AVJNR/L27060-1204N	40	60	20	27	140	55	0.8	VN**1204...
C4AVJNR/L27060-16N	40	60	25	27	140	110	0.8	VN**1604...
C6AVJNR/L45065-1204N	63	65	31.5	45	190	81	0.8	VN**1204...
C6AVJNR/L45065-16N	63	65	35	45	190	81	0.8	VN**1604...

Applicable for 7 MPa coolant

SPARE PARTS									
Designation	Clamp	Clamp screw	Coolant parts	Shim	Shim screw	Spring	Spring pin	Wrench 1	Wrench 2
C4AVJNR/L...	ACP3L-E	ACS-5W	-	ASV222	CSTB-3	BP-7	SP-2.5	T-9F	T-15F
C6AVJNR/L...	ACP3L-E	ACS-5W	SATZ-M10X1-M5	ASV222	CSTB-3	BP-7	SP-2.5	T-9F	T-15F

Lever-lock toolholder, with 93° approach angle, for negative 35° rhombic inserts, with high pressure coolant capability

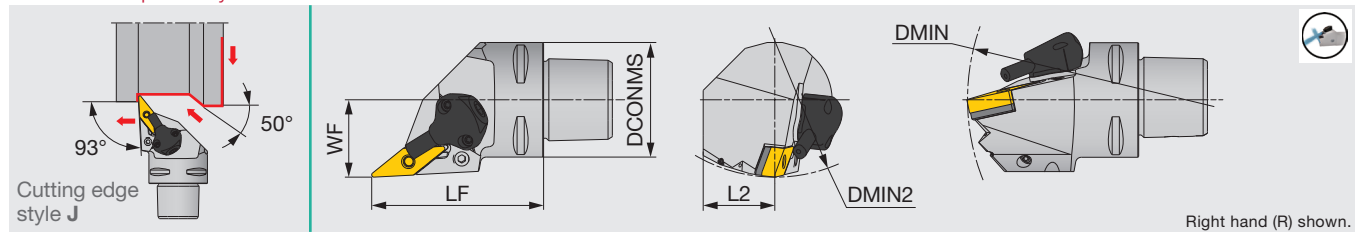

Metric	DCONMS	LF	L2	WF	DMIN	DMIN2	RE	Insert
C4PVJNR/L27060-16-CHP	40	60	25	27	140	110	0.8	VN**1604...
C6PVJNR/L45065-16-CHP	63	65	32	45	190	81	0.8	VN**1604...

Applicable for 14 MPa coolant

SPARE PARTS						
Designation	Shim	Spring pin	Lever	Clamping screw	Wrench	Coolant unit
C*PVJNR/L...16-CHP	LSV317	LSP3	LCL3V	LCS3V	P-2.5	CU-V-CHP

COOLANT SET				
Designation	Coolant unit	Mounting screw	Wrench 2	O-ring
C*PVJNR/L...16-CHP	CU-V-CHP	SRM3	T-8F	OR6.4X0.9N



TUNGCAP

C-SVJCR/L

Screw-on toolholder, with 93° approach angle, for positive 35° rhombic inserts

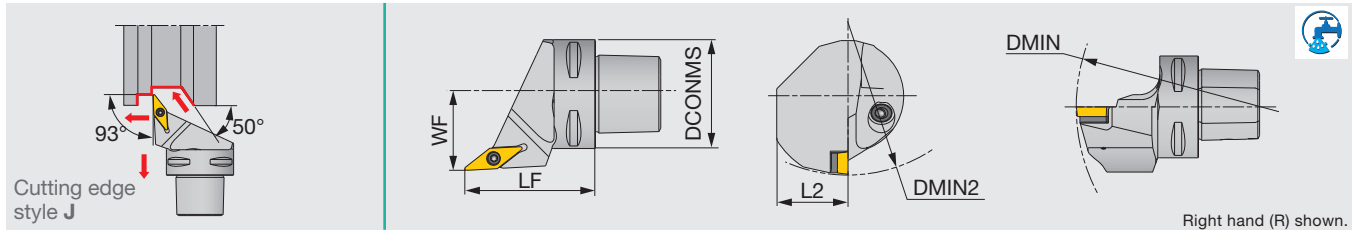

Right hand (R) shown.

Metric	DCONMS	LF	L2	WF	DMIN	DMIN2	RE	Insert
C3SVJCR/L22040-11N ⁽²⁾	32	40	20	22	-	-	0.4	VC**1103...
C5SVJCL35060-16 ⁽¹⁾	50	60	32	35	-	-	0.8	VC**1604...
C5SVJCR/L35060-16N ⁽²⁾	50	60	32	35	170	160	0.8	VC**1604...
C6SVJCR/L45065-16 ⁽¹⁾	63	65	41	45	-	-	0.8	VC**1604...
C6SVJCR/L45065-16N ⁽²⁾	63	65	41	45	170	190	0.8	VC**1604...

The items without DMIN and DMIN2 cannot be used for boring
 (1) Applicable for 3 MPa coolant (2) Applicable for 7 MPa coolant

SPARE PARTS

Designation	Clamping screw	Coolant parts	Shim	Shim screw	Wrench 1	Wrench 2
C3SVJC*22040-11N	CSTB-2.5	SATZ-M8X1-M3	-	-	-	T-8F
C5SVJC*35060-16	CSTB-3.5L	EZ104	SSV32	DTS5-3.5	P-3.5	T-15F
C5SVJC*35060-16N	CSTB-3.5L	SATZ-M10X1-M5	SSV32	DTS5-3.5	P-3.5	T-15F
C6SVJC*45065-16	CSTB-3.5L	EZ104	SSV32	DTS5-3.5	P-3.5	T-15F
C6SVJC*45065-16N	CSTB-3.5L	SATZ-M10X1-M5	SSV32	DTS5-3.5	P-3.5	T-15F

TUNGCAP

C-ADNNN

TURNINGA

Double-clamp toolholder, with 62.5° approach angle, for negative 55° rhombic inserts

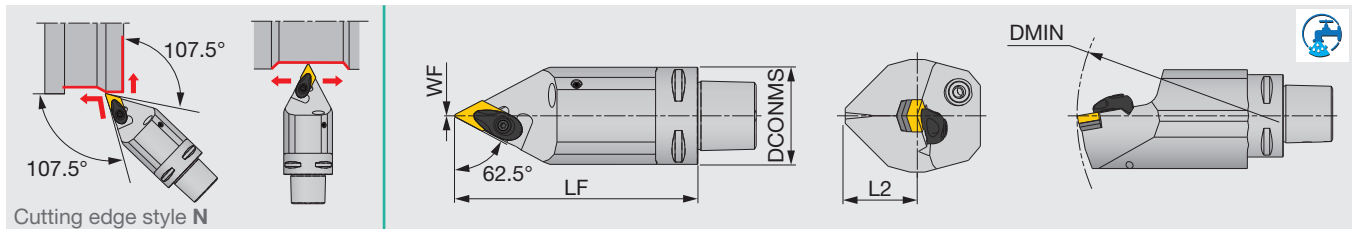

Metric	DCONMS	LF	L2	WF	DMIN	RE	Insert
C5ADNNN00090-15 ⁽¹⁾	50	90	32	0	-	0.8	DN**1504(06)
C5ADNNN00090-15N ⁽²⁾	50	90	32	0	165	0.8	DN**1504(06)
C5ADNNN00125-15 ⁽¹⁾	50	125	32	0	-	0.8	DN**1504(06)
C5ADNNN00125-15N ⁽²⁾	50	125	32	0	165	0.8	DN**1504(06)
C6ADNNN00100-15N ⁽²⁾	63	100	37.5	0	190	0.8	DN**1504(06)
C6ADNNN00140-15N ⁽²⁾	63	140	37.5	0	190	0.8	DN**1504(06)

The items without DMIN cannot be used for boring
 (1) Applicable for 3 MPa coolant (2) Applicable for 7 MPa coolant

SPARE PARTS

Designation	Clamp	Clamp screw	Coolant parts	Shim	Shim screw	Spring	Spring pin	Wrench
C5ADNNN00090-15	ACP4S	ACS-5W	EZ104	ASD432	CSTB-3.5	BP-7	SP-2.5	T-15F
C5ADNNN00090-15N	ACP4S	ACS-5W	SATZ-M10X1-M5	ASD432	CSTB-3.5	BP-7	SP-2.5	T-15F
C5ADNNN00125-15	ACP4S	ACS-5W	EZ104	ASD432	CSTB-3.5	BP-7	SP-2.5	T-15F
C5ADNNN00125-15N	ACP4S	ACS-5W	SATZ-M10X1-M5	ASD432	CSTB-3.5	BP-7	SP-2.5	T-15F
C6ADNNN00100-15N	ACP4S	ACS-5W	SATZ-M10X1-M5	ASD432	CSTB-3.5	BP-7	SP-2.5	T-15F
C6ADNNN00140-15N	ACP4S	ACS-5W	SATZ-M10X1-M5	ASD432	CSTB-3.5	BP-7	SP-2.5	T-15F

Option: ASD423 (Shim for DN**1506**)

C-SVVCN

Screw-on toolholder, with 72.5° approach angle, for positive 35° rhombic inserts

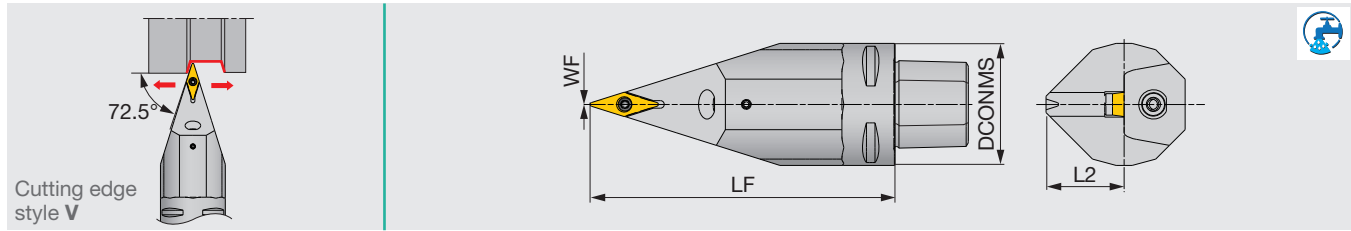

Metric	DCONMS	LF	L2	WF	RE	Insert
C5SVVCN00090-16 ⁽¹⁾	50	90	32	0	0.8	VC**1604...
C5SVVCN00090-16N ⁽²⁾	50	90	32	0	0.8	VC**1604...
C5SVVCN00125-16 ⁽¹⁾	50	125	32	0	0.8	VC**1604...
C5SVVCN00125-16N ⁽²⁾	50	125	32	0	0.8	VC**1604...
C6SVVCN00100-16N ⁽²⁾	63	100	37.5	0	0.8	VC**1604...
C6SVVCN00140-16N ⁽²⁾	63	140	37.5	0	0.8	VC**1604...

(1) Applicable for 3 MPa coolant (2) Applicable for 7 MPa coolant

Designation	Clamping screw	Coolant parts	Shim	Shim screw	Wrench 1	Wrench 2
C5SVVCN00090-16	CSTB-3.5L	EZ104	SSV32	DTS5-3.5	P-3.5	T-15F
C5SVVCN00090-16N	CSTB-3.5L	SATZ-M10X1-M5	SSV32	DTS5-3.5	P-3.5	T-15F
C5SVVCN00125-16	CSTB-3.5L	EZ104	SSV32	DTS5-3.5	P-3.5	T-15F
C5SVVCN00125-16N	CSTB-3.5L	SATZ-M10X1-M5	SSV32	DTS5-3.5	P-3.5	T-15F
C6SVVCN00100-16N	CSTB-3.5L	SATZ-M10X1-M5	SSV32	DTS5-3.5	P-3.5	T-15F
C6SVVCN00140-16N	CSTB-3.5L	SATZ-M10X1-M5	SSV32	DTS5-3.5	P-3.5	T-15F

C-SCLCR

Screw-on internal toolholder, for positive 80° rhombic inserts

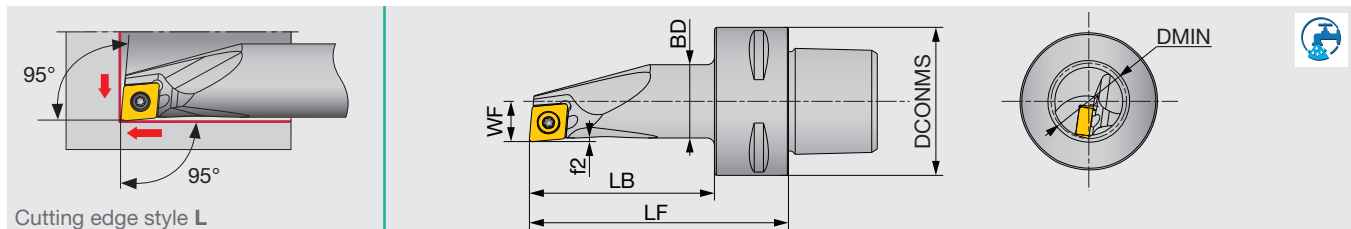

Metric	DMIN	DCONMS	BD	LF	LB	WF	f2	RE	Insert
C3SCLCR11070-09	22	32	19.8	70	52	11	1.0	0.8	CC**09...
C4SCLCR11070-09	22	40	19.8	70	47	11	1.0	0.8	CC**09...

Applicable for 14 MPa coolant
Use right-hand toolholders (R) with left-hand inserts (L).

Designation	Clamping screw	Wrench
C*SCLCR11070-09	CSTB-4S	T-15F

Reference pages: C-SVJCR/L: Inserts → **B155 -**, CBN → **B192**, PCD → **B196 -**
 C-ADNNN: Inserts → **B067 -**, CBN → **B174 -**, PCD → **B194 -**
 C-SVVCN: Inserts → **B155 -**, CBN → **B192**, PCD → **B196 -**
 C-SCLCR: Inserts → **B111 -**, CBN → **B182 -**, PCD → **B196 -**



TUNGCAP

C-PCLNR/L-IN

Lever-lock internal toolholder, for negative 80° rhombic inserts

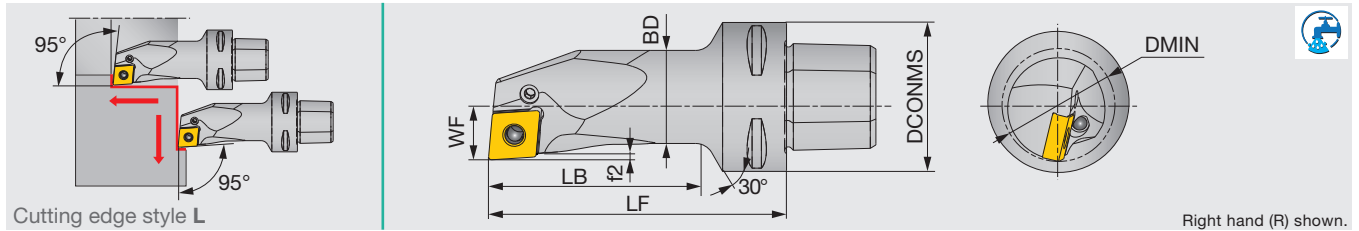

Metric	DMIN	DCONMS	BD	LB	LF	WF	f2	RE	Insert
C3PCLNR17090-12	32	32	25	90	71	17	1.6	0.8	CN**1204...
C4PCLNR17090-0904	32	40	25	90	63	17	1.3	0.8	CN**0904**E
C4PCLNR/L17080-12	32	40	25	80	58.5	17	1.6	0.8	CN**1204...
C4PCLNR22110-0904	40	40	32	110	86.5	22	1.3	0.8	CN**0904**E
C4PCLNR27120-0904	50	40	39.5	120	100	27	1.7	0.8	CN**0904**E

Applicable for 10 MPa coolant

Designation	Shim	Clamping screw	Spring pin	Lever	Wrench 1	Wrench 2
C3PCLNR17090-12	-	LCS43	-	LCL43N	P-2.5	-
C4PCLNR17090-0904	-	LCS33	-	LCL33N	-	P-2F
C4PCLNR/L17080-12	-	LCS43	-	LCL43N	P-2.5	-
C4PCLNR22110-0904	LSC317	LCS3	LSP3	LCL33	-	P-2.5F
C4PCLNR27120-0904	LSC317	LCS3	LSP3	LCL33	-	P-2.5F

C-PCLNR/L-CHP

TUNGTJET

Lever-lock internal toolholder, for negative 80° rhombic inserts

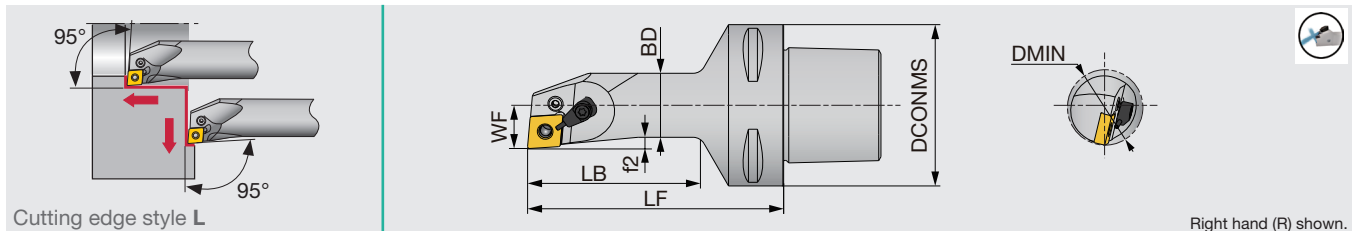

Metric	DMIN	DCONMS	BD	LF	LB	WF	f2	RE	Insert
C6PCLNL17100-12-CHP	32	63	25	100	67.5	17	4.5	0.8	CN**1204...

Designation	Clamping screw	Coolant unit	Wrench	Lever
C6PCLNL17100-12-CHP	LCS43	S-CU-CHP	P-2.5	LCL43N

Reference pages: C-PCLNR/L-IN, C-PCLNR/L-CHP: Inserts → **B056 -**, CBN → **B172 -**, PCD → **B194 -**

C-SWLXR/L

Screw-on internal toolholder, for WXGU inserts

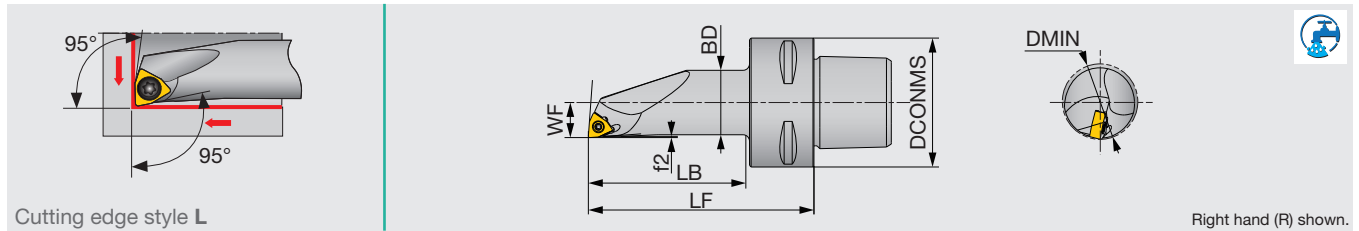

Cutting edge style L Right hand (R) shown.

Metric	DMIN	DCONMS	BD	LF	LB	WF	f2	RE	Insert
C4SWLXR11070-04	22	40	20	70	47	11	0.4	0.4	WXGU0403**L...

Applicable for 14 MPa coolant

SPARE PARTS

Designation	Clamping screw	Wrench
C4SWLXR11070-04	SR34-514	T-7F

TUNGCAP

C-ADUNR/L

Double-clamp internal toolholder, for negative 55° rhombic inserts

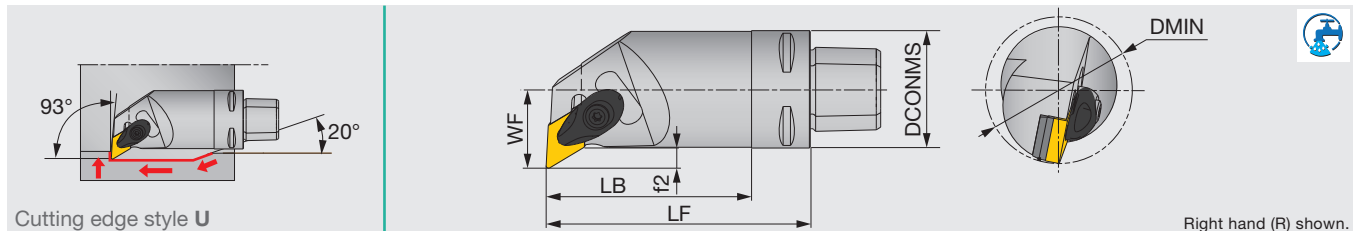

Cutting edge style U Right hand (R) shown.

Metric	DMIN	DCONMS	LF	LB	WF	f2	RE	Insert
C4ADUNR20070-15	38	40	70	50	20	5	0.8	DN**1504...
C4ADUNR27090-15	50	40	90	-	27	7	0.8	DN**1504...

Applicable for 10 MPa coolant

SPARE PARTS

Designation	Clamp	Clamp screw	Shim	Shim screw	Spring	Spring pin	Wrench
C*ADUNR/L...	ACP4S	ACS-5W	ASD423(04)	CSTB-3.5	BP-7	SP-2.5	T-15F

Option: ASD423 (Shim for DN**1506**)

C-PDUNR/L

Lever-lock internal toolholder, for negative 55° rhombic inserts

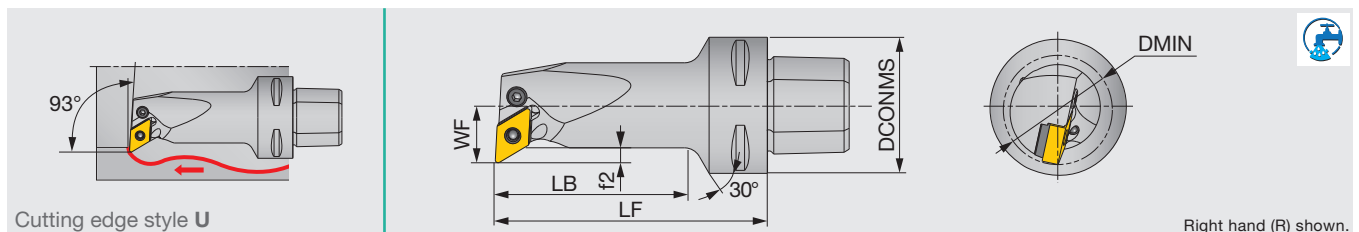

Cutting edge style U Right hand (R) shown.

Metric	DMIN	DCONMS	LF	LB	WF	f2	RE	Insert
C4PDUNR/L17080-11	32	40	80	58.5	17	4.4	0.8	DN**1104...

Applicable for 10 MPa coolant

SPARE PARTS

Designation	Lever	Clamping screw	Shim	Spring pin	Wrench
C4PDUNR17080-11	LCL33L	LCS3	ELSD317BR	LSP3	P-2.5
C4PDUNL17080-11	LCL33L	LCS3	ELSD317BL	LSP3	P-2.5

Reference pages: C-SWLXR/L: Inserts → **B161** -
 C-ADUNR/L: Inserts → **B067** -, CBN → **B174** -, PCD → **B194** -
 C-PDUNR/L: Inserts → **B067** -



Lever-lock internal toolholder, for negative 55° rhombic inserts

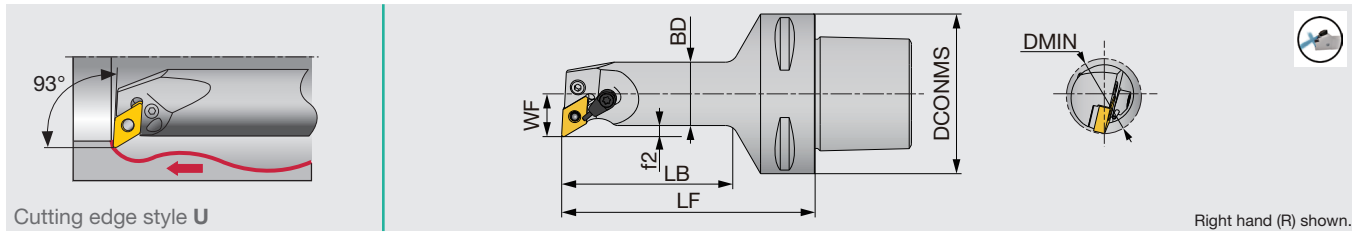

Metric	DMIN	DCONMS	BD	LF	LB	WF	f2	RE	Insert
C6PDUNL17100-1104-CHP	32	63	25	100	67.5	17	4.5	0.8	DN**1104...

Applicable for 14 MPa coolant

SPARE PARTS

Designation	Shim	Clamping screw	Coolant unit	Wrench	Spring pin	Lever
C6PDUNL17100-1104-CHP	ELSD317BL	LCS43	S-CU-CHP	P-2.5	LSP3	LCL33L

TUNGCAP

C-SDXXR

Screw-on internal toolholder, for DXGU inserts

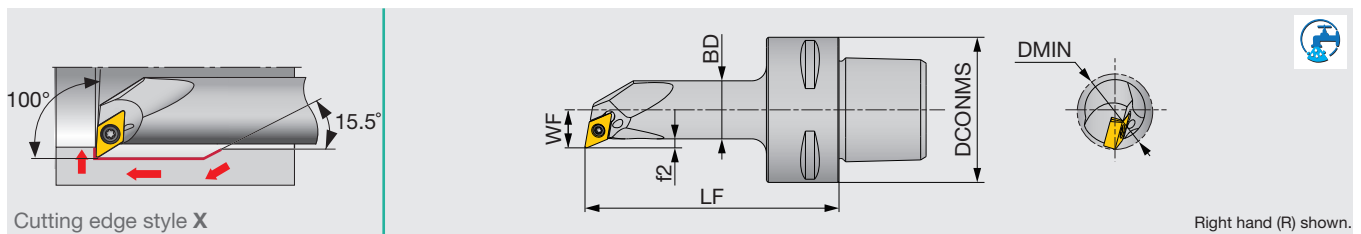

Metric	DMIN	DCONMS	BD	LF	LB	WF	f2	RE	Insert
C3SDXXR11065-07	20	32	16	65	45	10.6	2.5	0.4	DXGU0703**L...
C3SDXXR13080-07	24	32	20	80	62	12.6	2.5	0.4	DXGU0703**L...
C4SDXXR11070-07	20	40	16	70	46	10.6	2.5	0.4	DXGU0703**L...
C4SDXXR13080-07	24	40	20	80	58	12.6	2.5	0.4	DXGU0703**L...

Applicable for 14 MPa coolant

Use right-hand toolholders (R) with left-hand inserts (L).

SPARE PARTS

Designation	Clamping screw	Wrench
C*SDXXR...	SR34-514	T-7F

Reference pages: C-PDUNR/L: Inserts → **B067** -
C-SDXXR: Inserts → **B127** -

C-SVQBR/L

Screw-on internal toolholder, for positive 35° rhombic inserts

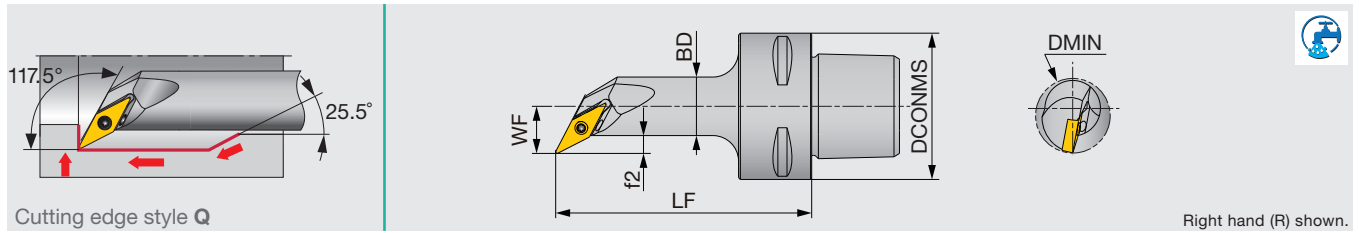

Cutting edge style Q

Right hand (R) shown.

Metric	DMIN	DCONMS	BD	LF	LB	WF	f2	RE	Insert
C3SVQBR13065-11	21.5	32	16	65	45	13	4.9	0.4	VB**11...
C3SVQBR15080-11	25.5	32	20	80	59	15	4.9	0.4	VB**11...
C3SVQBR18090-16	30.5	32	25	90	71	17.5	4.9	0.8	VB**16...
C4SVQBR13070-11	21.5	40	16	70	43	13	4.9	0.4	VB**11...
C4SVQBR15080-11	25.5	40	20	80	52	15	4.9	0.4	VB**11...
C4SVQBR18095-16	30.5	40	25	95	68	17.5	4.9	0.8	VB**16...

Applicable for 14 MPa coolant

SPARE PARTS



Designation	Clamping screw	Wrench
C*SVQBR**11	CSTB-2.5	T-6F
C*SVQBR**16	CSTB-3.5	T-15F

C-CER/L

TUNGTHREAD

External threading toolholder, alternative clamping of screw-on or clamp-on

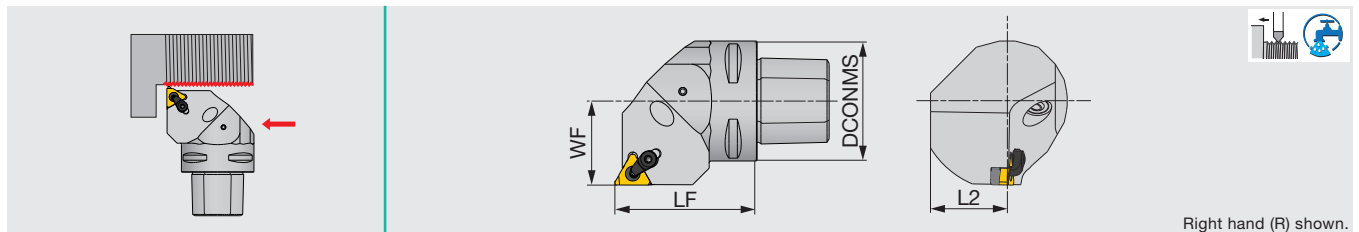

Right hand (R) shown.

Metric	DCONMS	LF	L2	WF	Insert
C3CER/L22040-16ERN ⁽³⁾	32	40	20	22	16ER/L...
C4CER/L27050-16ERN ⁽³⁾	40	50	25	27	16ER/L...
C5CEL35060-16ER ⁽¹⁾	50	60	32	35	16ER/L...
C5CER/L35060-16ERN ⁽²⁾	50	60	32	35	16ER/L...
C6CEL45065-16ER ⁽¹⁾	63	65	41	45	16ER/L...
C6CER/L45065-16ERN ⁽²⁾	63	65	41	45	16ER/L...

(1) Applicable for 3 MPa coolant (2) & (3) Applicable for 7 MPa coolant

SPARE PARTS



Designation	Shim	Shim screw	Clamp screw	Clamping screw	Wrench 1	Wrench 2	Coolant parts
C*CER/L*****16ER...	A16-1DT	DTS5-3.5	CSTB-3.5ST	CSP16	T-15F	P-3.5	EZ104 ⁽¹⁾
C*CER/L*****16ER...	A16-1DT	DTS5-3.5	CSTB-3.5ST	CSP16	T-15F	P-3.5	SATZ-M10X1-M5 ⁽²⁾
C*CER/L*****16ER...	A16-1DT	DTS5-3.5	CSTB-3.5ST	CSP16	T-15F	P-3.5	SATZ-M8X1-M3 ⁽³⁾

(1) Applicable for 3 MPa coolant (2) & (3) Applicable for 7 MPa coolant

Reference pages: C-SVQBR/L: Inserts → **B152 -**, CBN → **B191 -**
C-CER/L: Inserts → **E010 -**

Shank for CAER/L and CAFR/L blades

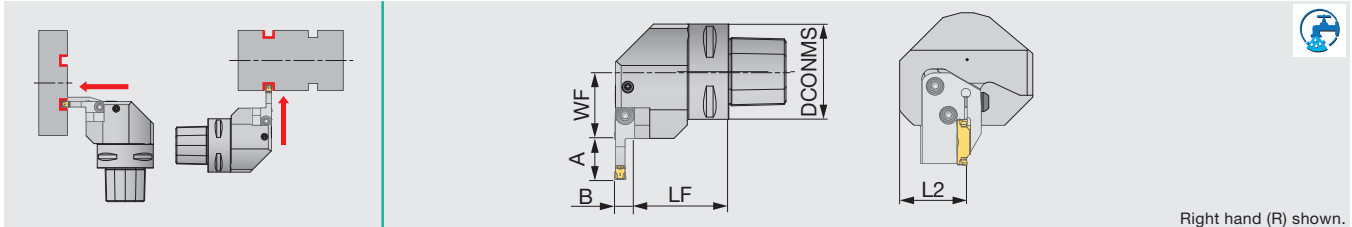

Right hand (R) shown.

Metric	DCONMS	LF	L2	WF	A	B
C3CHFVR/L22040N	32	32.5	35	22	*Table:	*Table:
C4CHFVR/L27050N	40	42.5	36	27	*Table:	*Table:
C5CHFVR/L35060N	50	49.5	36	35	*Table:	*Table:
C6CHFVR/L45065N	63	54.5	41	45	*Table:	*Table:

Applicable for 7 MPa coolant
See the table below for the offset dimensions.

SPARE PARTS

Designation	Coolant parts1	Coolant parts2	Clamping screw	Wrench
C5CHFV*35060N	SATZ-M10X1-M5	-	CSHB-6-A	P-4
C6CHFV*45065	CNZ125	PNZ5	CSHB-6-A	P-4
C6CHFV*45065N	SATZ-M10X1-M5	-	CSHB-6-A	P-4

Combination of blade and toolholder

Toolholder	Blade			
	CAER...	CAEL...	CAFR...	CAFL...
C*CHFVR...	-	●	●	-
C*CHFVL...	●	-	-	●

●: Corresponding

Shank for CAER/L and CAFR/L blades

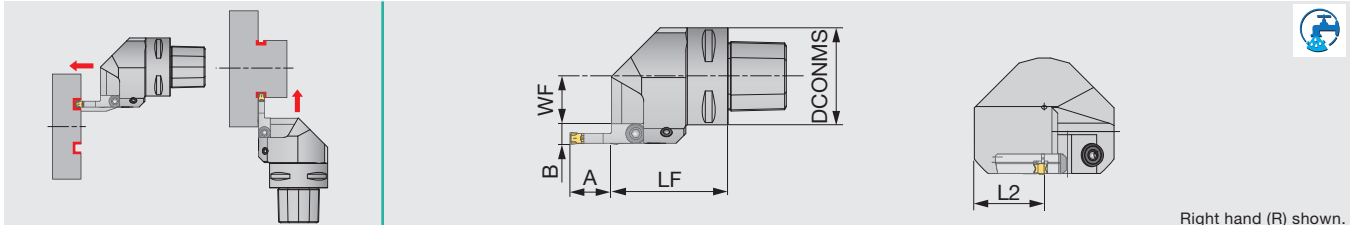

Right hand (R) shown.

Metric	DCONMS	LF	L2	WF	A	B
C3CHSR/L22050N	32	50	35	11.5	*Table:	*Table:
C4CHSR/L27050N	40	50	36	16.5	*Table:	*Table:
C5CHSR/L35060N	50	60	36	24.5	*Table:	*Table:
C6CHSR/L45065N	63	65	41	34.5	*Table:	*Table:

Applicable for 7 MPa coolant
See the table below for the offset dimensions.

SPARE PARTS

Designation	Coolant parts1	Coolant parts2	Clamping screw	Wrench
C4CHS*27050N	SATZ-M8X1-M3	-	CSHB-6-A	P-4
C5CHS*35060	CNZ125	PNZ5	CSHB-6-A	P-4
C*CHS**506*N	SATZ-M10X1-M5	-	CSHB-6-A	P-4

Combination of blade and toolholder

Toolholder	Blade			
	CAER...	CAEL...	CAFR...	CAFL...
C*CHSR...	●	-	-	●
C*CHSL...	-	●	●	-

●: Corresponding

*Table: Off set dimensions for blade

Application	Blade	A	B
For external grooving	CAER/L-3T16	16	10.4
	CAER/L-4T16	16	10.5
	CAER/L-5T20	20	10.5
	CAER/L-6T20	20	10.5
	CAFR/L-3T12-*	12	10.4
For face grooving	CAFR/L-4T16-*	16	10.5
	CAFR/L-5T20-*	20	10.5
	CAFR/L-6T20-*	25	10.5

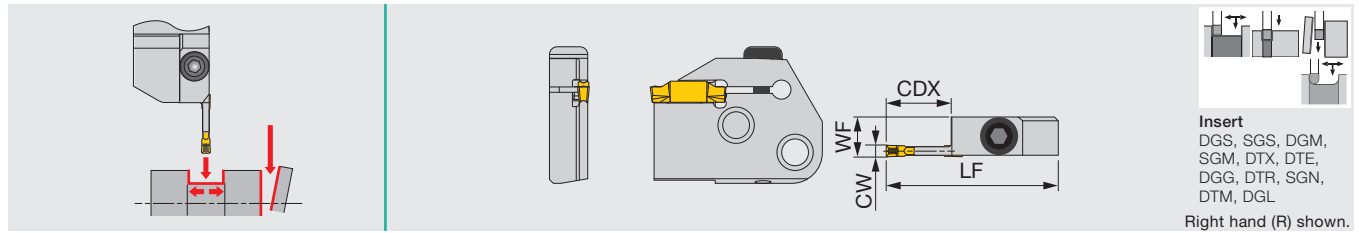

Inch	CW (in)	Seat size	CDX	LF	WF	Shank	Torque
CAER/L-3T16	0.118	3	0.630	1.772	0.409	C*CHSR/L, C*CHFVL/R	3.69
CAER/L-4T16	0.157	4	0.630	1.772	0.413	C*CHSR/L, C*CHFVL/R	3.69
CAER/L-5T20	0.197	5	0.787	1.929	0.413	C*CHSR/L, C*CHFVL/R	3.69
CAER/L-6T20	0.236	6	0.787	1.929	0.413	C*CHSR/L, C*CHFVL/R	3.69

Metric	CW	Seat size	CDX	LF	WF	Shank	Torque*
CAER/L-3T16	3	3	16	45	10.4	C*CHSR/L, C*CHFVL/R	5
CAER/L-4T16	4	4	16	45	10.5	C*CHSR/L, C*CHFVL/R	5
CAER/L-5T20	5	5	20	49	10.5	C*CHSR/L, C*CHFVL/R	5
CAER/L-6T20	6	6	20	49	10.5	C*CHSR/L, C*CHFVL/R	5

Torque: Recommended clamping torque: lbs-ft (*N·m)
 When groove depth is larger than (insert length - 0.059"/1.5 mm), please use 1-cornered insert.
 Not compatible with TungModularSystem

SPARE PARTS



Designation	Clamping screw	Wrench
CAER/L...	BHM6-20-A	P-4

Blade for face grooving and turning

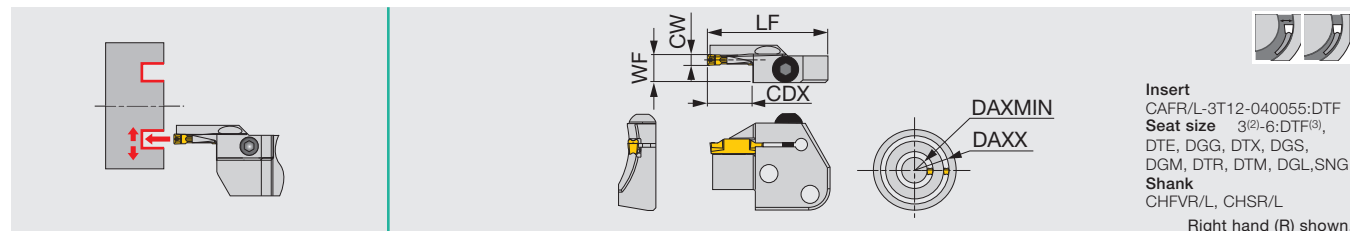

Insert
CAFR/L-3T12-040055:DTF
Seat size 3⁽²⁾-6;DTF⁽³⁾,
DTE, DGG, DTX, DGS,
DGM, DTR, DTM, DGL, SNG
Shank
CHFVR/L, CHSR/L
Right hand (R) shown.

Inch	CW (in)	CW (mm)	DAXMIN	DAXX	Seat size	CDX	LF	WF ⁽¹⁾
CAFR/L-3T12-040055	0.118	3	1.575	2.17	3	0.472	1.772	0.409
CAFR/L-3T12-055075	0.118	3	2.165	2.95	3	0.472	1.772	0.409
CAFR/L-3T12-075100	0.118	3	2.953	3.94	3	0.472	1.772	0.409
CAFR/L-3T12-100140	0.118	3	3.937	5.51	3	0.472	1.772	0.409
CAFR/L-3T12-140200	0.118	3	5.512	7.87	3	0.472	1.772	0.409
CAFR/L-4T16-050070	0.157	4	1.969	2.76	4	0.63	1.772	0.413
CAFR/L-4T16-070100	0.157	4	2.756	3.94	4	0.63	1.772	0.413
CAFR/L-4T16-100150	0.157	4	3.937	5.91	4	0.63	1.772	0.413
CAFR/L-4T16-150250	0.157	4	5.906	9.84	4	0.63	1.772	0.413
CAFR/L-5T20-055080	0.197	5	2.165	3.15	5	0.787	1.929	0.413
CAFR/L-5T20-080120	0.197	5	3.15	4.72	5	0.787	1.929	0.413
CAFR/L-5T20-120180	0.197	5	4.724	7.09	5	0.787	1.929	0.413
CAFR/L-5T20-180300	0.197	5	7.087	11.81	5	0.787	1.929	0.413
CAFR/L-5T20-300000	0.197	5	11.811	0	5	0.787	1.929	0.413
CAFR/L-6T25-060090	0.236	6	2.362	3.54	6	0.984	2.165	0.413
CAFR/L-6T25-090150	0.236	6	3.543	5.91	6	0.984	2.165	0.413
CAFR/L-6T25-150250	0.236	6	5.906	9.84	6	0.984	2.165	0.413
CAFR/L-6T25-250400	0.236	6	9.843	15.75	6	0.984	2.165	0.413

Metric	CW	DAXMIN	DAXX	Seat size	CDX	LF	WF ⁽¹⁾
CAFR/L-3T12-040055	3	40	55	3	12	45	10.4
CAFR/L-3T12-055075	3	55	75	3	12	45	10.4
CAFR/L-3T12-075100	3	75	100	3	12	45	10.4
CAFR/L-3T12-100140	3	100	140	3	12	45	10.4
CAFR/L-3T12-140200	3	140	200	3	12	45	10.4
CAFR/L-4T16-050070	4	50	70	4	16	45	10.5
CAFR/L-4T16-070100	4	70	100	4	16	45	10.5
CAFR/L-4T16-100150	4	100	150	4	16	45	10.5
CAFR/L-4T16-150250	4	150	250	4	16	45	10.5
CAFR/L-5T20-055080	5	55	80	5	20	49	10.5
CAFR/L-5T20-080120	5	80	120	5	20	49	10.5
CAFR/L-5T20-120180	5	120	180	5	20	49	10.5
CAFR/L-5T20-180300	5	180	300	5	20	49	10.5
CAFR/L-5T20-300000	5	300	∞	5	20	49	10.5
CAFR/L-6T25-060090	6	60	90	6	25	55	10.5
CAFR/L-6T25-090150	6	90	150	6	25	55	10.5
CAFR/L-6T25-150250	6	150	250	6	25	55	10.5
CAFR/L-6T25-250400	6	250	400	6	25	55	10.5

When groove depth is larger than (insert length - 1.5 mm), please use 1-cornered insert.

Not compatible with TungModularSystem

(1) WF is calculated with the groove width CW in the above table.

(2) Not applicable to CAFR/L-3T12-040055

(3) Seat sizes of DTF are only 3 and 4.

SPARE PARTS

Designation	Clamping screw	Wrench
CAFR/L...	BHM6-20-A	P-4

Insert	Groove width		Min. dia. for face grooving	
	CW (in)	CW (mm)	DAXMIN (in)	DAXMIN (mm)
DGM / DGS / SGN / DGL	0.118	3	3.622	92
DGM / DGS / SGN / DGL	0.157	4	1.457	37
DGM / DGS / DGL	0.197	5	2.362	60
DGM / DGS / DGL	0.236	6	2.244	57
DTE / DGG / DTM	0.118	3	2.441	62
DTE / DGG / DTM	0.157	4	1.654	42
DTE / DGG / DTM	0.197	5	2.520	64
DTE / DGG / DTM	0.236	6	2.402	61
DTR	0.118	3	1.732	44
DTR	0.157	4	1.260	32
DTR	0.197	5	1.890	48
DTR	0.236	6	1.890	48
DTX	0.118	3	0.748	19
DTX	0.157	4	0.787	20
DTX	0.197	5	0.787	20
DTX	0.236	6	0.906	23
DTF	0.118	3	0.748	19
DTF	0.157	4	0.787	20

Reference pages: CAFR/L: Inserts → **F178 -**

Adapter for blades with high pressure coolant capability

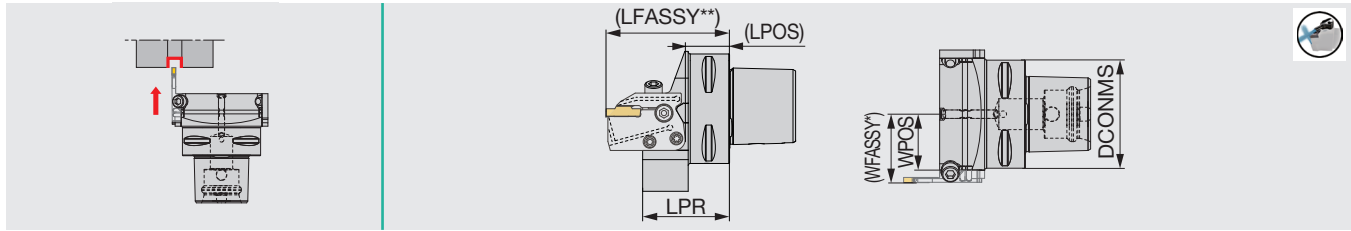

Metric	DCONMS	LPR	LPOS	WPOS	Blade (Option)	Torque
C4CHSN21047-CHP	40	46.5	21.5	21	CAER/L...-CHP	5
C5CHSN26047-CHP	50	47	22.5	26	CAER/L...-CHP	5
C6CHSN33050-CHP	63	50	24.5	32.5	CAER/L...-CHP	5

When groove depth is larger than (insert length - 1.5 mm), please use 1-cornered insert

*WFASSY : Shank (WPOS) + blade (WF) **LFASSY : Shank (LPOS) + blade (LF)

Torque: Recommended clamping torque: N·m

Applicable for 30 MPa coolant

See page L043 for instructions on installing and removing the blade or the insert.

SPARE PARTS

Designation	Clamping screw1	Clamping screw2	Clamping screw3	Wrench 1	Wrench 2	O-ring
C*CHSN...-CHP	SRM5-04451	SRM6X12DIN6912	SRM6X20-XT	T-20/5	HW5.0	OR5X1N

Adapter for blades with high pressure coolant capability

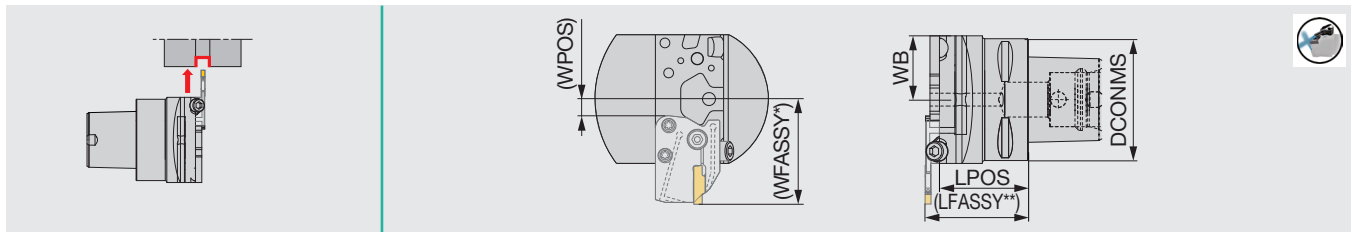

Metric	DCONMS	LPOS	WB	WPOS	Blade (Option)	Torque
C4CHFVN26046-CHP	40	46	26	1.5	CAER/L...-CHP	5
C5CHFVN26046-CHP	50	46	26	1.5	CAER/L...-CHP	5
C6CHFVN33046-CHP	63	46	33	8.5	CAER/L...-CHP	5

When groove depth is larger than (insert length - 1.5 mm), please use 1-cornered insert

*WFASSY : Shank (WPOS) + blade (LF) **LFASSY : Shank (LPOS) + blade (WF)

Torque: Recommended clamping torque: N·m

Applicable for 30 MPa coolant

See page L043 for instructions on installing and removing the blade or the insert.

SPARE PARTS

Designation	Clamping screw1	Clamping screw2	Clamping screw3	Wrench 1	Wrench 2	O-ring
C*CHFVN...-CHP	SRM5-04451	SRM6X12DIN6912	SRM6X20-XT	T-20/5	HW5.0	OR5X1N

Modular-type external grooving and parting blade, with high pressure coolant capability

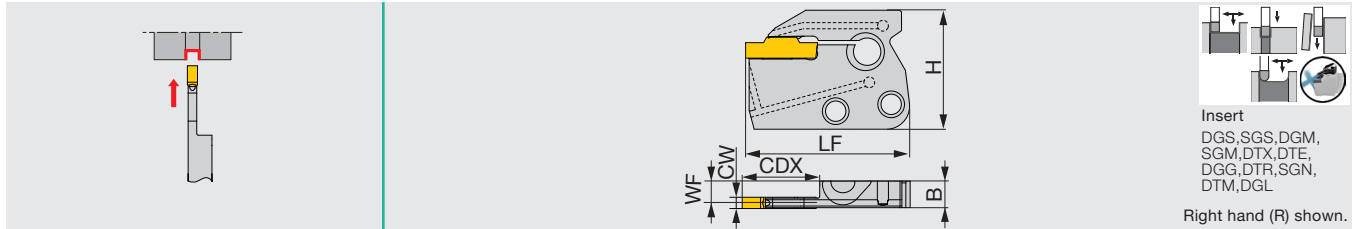

Insert
DGS, SGS, DGM,
SGM, DTX, DTE,
DGG, DTR, SGN,
DTM, DGL
Right hand (R) shown.

Inch	CW (in)	CW (mm)	Seat size	CDX	H	B	LF	WF
CAER/L-2T16-CHP	0.079	2	2	0.63	1.299	0.283	1.634	0.248
CAER/L-2T20-CHP	0.079	2	2	0.787	1.299	0.283	1.791	0.248
CAER/L-3T16-CHP	0.118	3	3	0.63	1.299	0.283	1.634	0.232
CAER/L-3T20-CHP	0.118	3	3	0.787	1.299	0.283	1.791	0.236
CAER/L-4T16-CHP	0.157	4	4	0.63	1.299	0.283	1.634	0.224
CAER/L-4T20-CHP	0.157	4	4	0.787	1.299	0.283	1.791	0.224
CAER/L-5T20-CHP	0.197	5	5	0.787	1.299	0.283	1.823	0.209
CAER/L-6T20-CHP	0.236	6	6	0.787	1.299	0.283	1.823	0.189

Metric	CW	Seat size	CDX	H	B	LF	WF
CAER/L-2T16-CHP	2	2	16	33	7.2	41.5	6.3
CAER/L-2T20-CHP	2	2	20	33	7.2	45.5	6.3
CAER/L-3T16-CHP	3	3	16	33	7.2	41.5	5.9
CAER/L-3T20-CHP	3	3	20	33	7.2	45.5	6
CAER/L-4T16-CHP	4	4	16	33	7.2	41.5	5.7
CAER/L-4T20-CHP	4	4	20	33	7.2	45.5	5.7
CAER/L-5T20-CHP	5	5	20	33	7.2	46.3	5.3
CAER/L-6T20-CHP	6	6	20	33	7.2	46.3	4.8

When groove depth is larger than (insert length - 1.5 mm), please use 1-cornered insert.

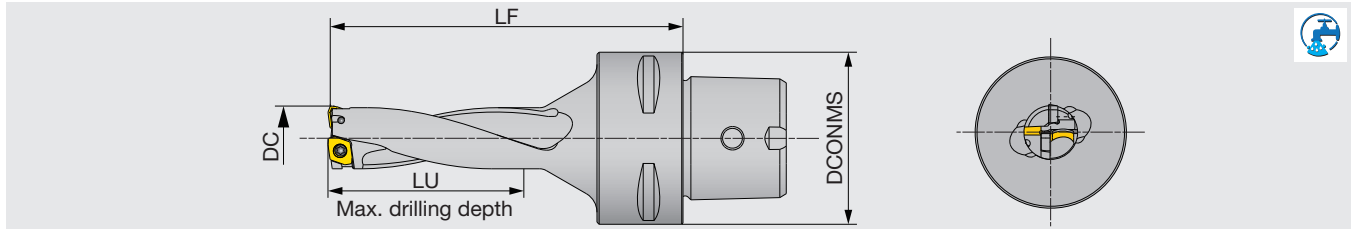

Metric	DC	DCONMS	LF	LU	Max. offset (radial)	Insert
C4TDX150L082-3	15	40	82	45.5	0.9	XPMT050204R-D*
C4TDX200L101-3	20	40	101	60.5	0.5	XPMT06X308R-D*
C4TDX250L125-3	25	40	125	75.6	0.4	XPMT07H308R-D*
C4TDX300L139-3	30	40	139	90.7	0.7	XPMT08T308R-D*
C6TDX200L101-3	20	63	101	60.5	0.5	XPMT06X308R-D*
C6TDX250L121-3	25	63	121	75.6	0.4	XPMT07H308R-D*
C6TDX300L139-3	30	63	139	90.7	0.7	XPMT08T308R-D*
C6TDX350L159-3	35	63	159	106.1	1.8	XPMT110412R-D*
C6TDX400L177-3	40	63	177	121.1	0.5	XPMT110412R-D*

Applicable for 14 MPa coolant

SPARE PARTS



Designation	Clamping screw	Wrench
C4TDX150L082-3	CSTB-2L040	T-6D
C4TDX200L101-3	CSTB-2.2R	T-7D
C4TDX250L125-3	CSTB-2.5	T-8D
C4TDX300L139-3	CSTB-3	T-9D
C6TDX200L101-3	CSTB-2.2R	T-7D
C6TDX250L121-3	CSTB-2.5	T-8D
C6TDX300L139-3	CSTB-3	T-9D
C6TDX350L159-3	CSTB-4	T-15D
C6TDX400L177-3	CSTB-4	T-15D

Square shoulder milling

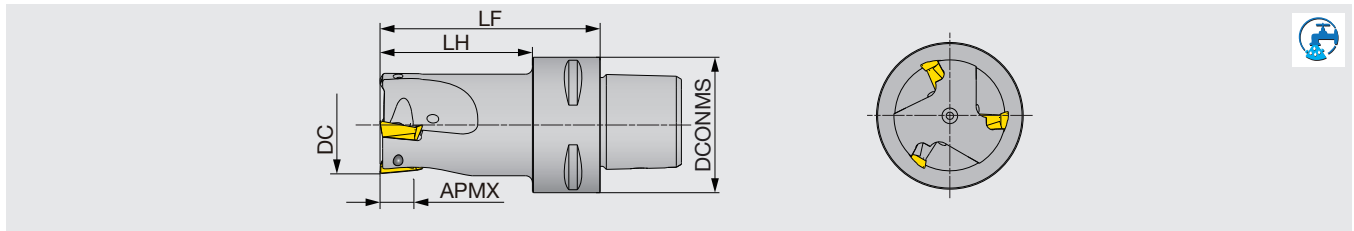

Metric	DC	APMX	DCONMS	CICT	LF	LH	Air hole	Insert
C4EPA10M032R03L065	32	10	40	3	65	45	with	TOMT1004...
C4EPA10M035R03L065	35	10	40	3	65	45	with	TOMT1004...
C6EPA15M040R03L080	40	15	63	3	80	58	with	TOMT1506...
C6EPA15M050R04L080	50	15	63	4	80	58	with	TOMT1506...

Applicable for 14 MPa coolant

SPARE PARTS



Designation	Clamping screw	Torx bit	Grip
C4EPA10M0**R03L065	SR14-562/S	BLDT10/S7	SW6-SD
C6EPA15M0**R0*L080	TS45120I	BT20S	H-TB2W

Square shoulder milling (for large depth of cut)

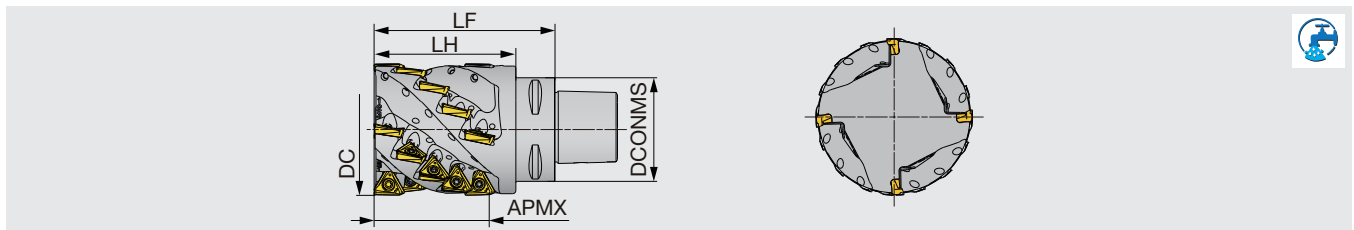

Metric	DC	APMX	DCONMS	CICT	ZEFP	LF	LH	Air hole	Insert
C6TLA15M063R03L100	63	55	63	12	3	100	78	with	TOMT1506...
C6TLA15M080R04L110	80	70	63	20	4	110	86.2	with	TOMT1506...

Applicable for 14 MPa coolant

SPARE PARTS



Designation	Clamping screw	Torx bit	Grip
C6TLA15M0**R0*L1**	TS45120I	BT20S	H-TB2W

Reference pages: C-EPA, C-TLA: Inserts → **H104**

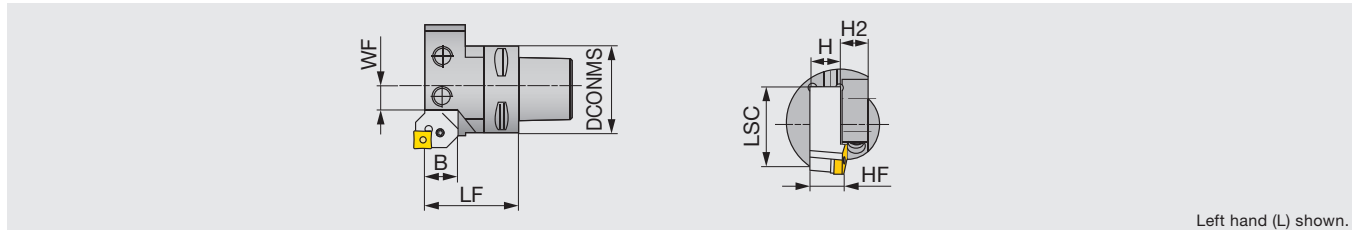

Metric	DCONMS	WF	LF	B	HF	H2	H	LSC
C3ADE-16R/L	32	17	45	16	16	26	16	45
C4ADE-20R/L	40	8	49.2	20	20	26	20	57
C5ADE-20R/L	50	8	55.2	20	20	20	20	57

Regular shank should be shortened.
Applicable for 10 MPa coolant

C-ASHA

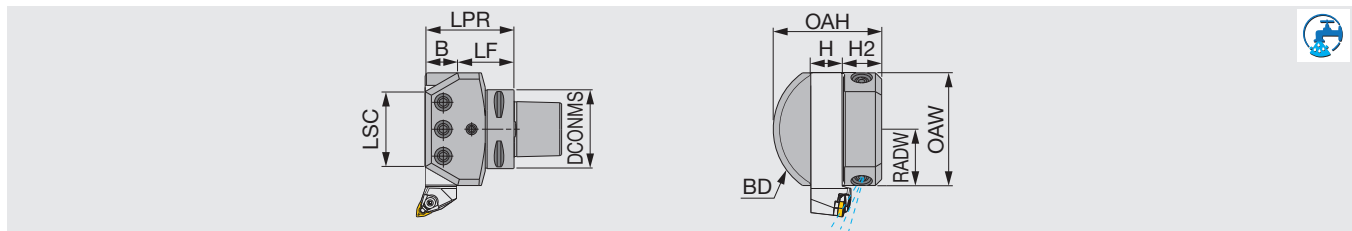

Metric	DCONMS	H	B	LPR	LSC	LF	RADW	OAW	H2	OAH	BD
C5ASHA20	50	20	20	58	46	38	38	76	31.5	76.5	90
C6ASHA20	63	20	20	60	46	40	38	76	31.5	76.5	90
C6ASHA25	63	25	25	71	61	46	45	90	31.6	86.5	110

Applicable for 10 MPa coolant

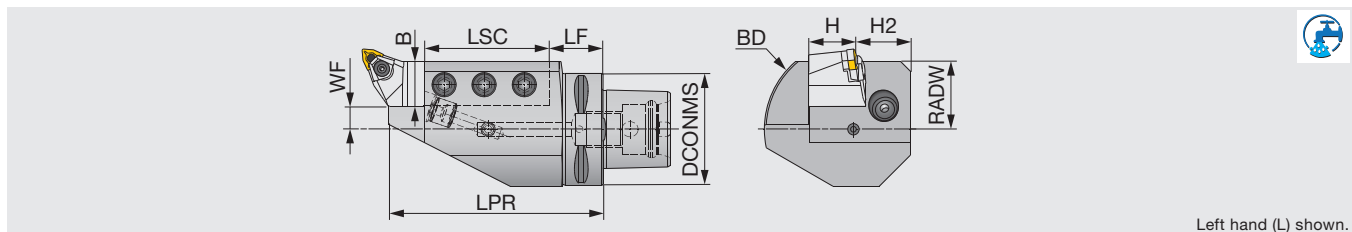

Inch	DCONMS	LPR	LSC	LF	WF	H	B	H2	RADW	BD
C6 ASHR/L 3/4X1	2.480	3.937	2.5	1.044	0.4	0.75	0.8	1	1.181	3.543
C6 ASHR/L 1X1	2.480	4.724	2.8	1.181	0.5	1	1	1	1.496	3.937
C8 ASHR 1 1/4 1	3.150	5.512	3.74	1.378	0.325	1.25	1.25	1.26	1.575	4.331

Regular shank should be shortened.
Applicable for 10 MPa coolant

TUNGCAP

C-ADES

Adapter for square shank toolholders

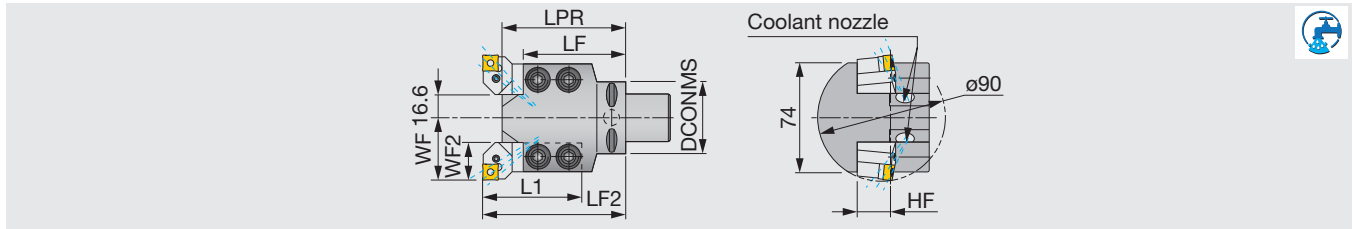

Metric	DCONMS	WF	LF2	LPR	LF	HF	WF2	L1
C4ADES-20	40	41.6	98	85	71	20	25	67
C5ADES-20	50	41.6	98	85	71	20	25	67

Regular shank should be shortened.
Applicable for 10 MPa coolant

C-ASHR/L-45

Adapter for square shank toolholders (with 45° slanted)

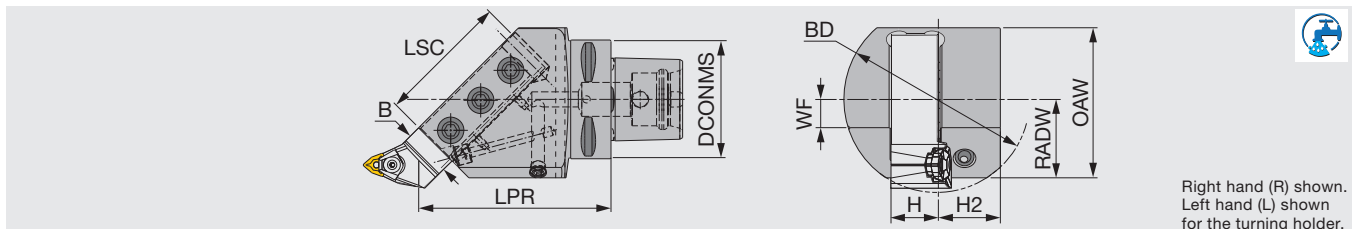

Metric	DCONMS	H	B	LSC	LPR	H2	RADW	OAW	WF	BD
C5ASHR/L20-45	50	20	20	-	96.3	26	36	67.5	15	72
C6ASHR/L20-45	63	20	20	70	98.3	26	36	67.5	15	72
C6ASHR/L25-45	63	25	25	70	101.3	33	41.6	79.6	15	100

Regular shank should be shortened.
Applicable for 10 MPa coolant

Fig. 1

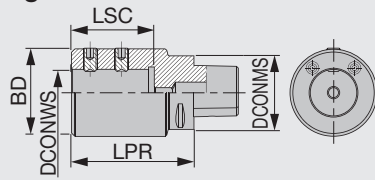
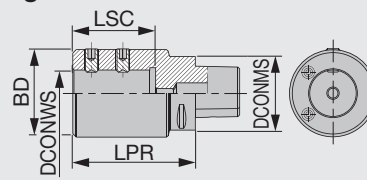

Fig. 2



Inch	DCONMS	DCONWS	BD	LPR	LSC	Fig.
C6ABB1X2.36	2.480	1.000	2.480	3.937	2.362	2
C6ABB1-1/2X2.75	2.480	1.500	2.953	4.134	2.756	1

Use the appropriate outlet screw according to the tool setup.
Applicable for 7 MPa coolant

SPARE PARTS

Designation	Clamp screw		Coolant outlet screw for internal supply	Coolant outlet screw for external supply
	Used on A-type sleeves	Used on B-type sleeves		
C6ABB1X2.36	SCREW1/2-20X.500EM	HSSS3/8-24X0.250CUP.P	SRM10X6DIN913	SRM6X8DIN913
C6ABB11/2X2.75	SCREW1/2-20X.500EM	HSSS1/2-20X1.251/2DOGP	SRM10X6DIN913	SRM6X8DIN913

SC

Sleeve for C-ABB adapter

Fig. A

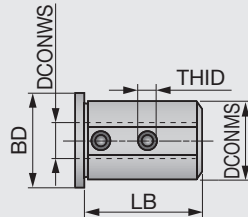
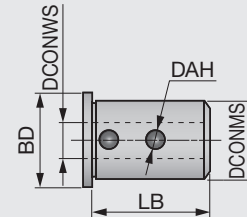

Fig. B



Inch	DCONMS	DCONWS	BD	LB	THID	DAH	Fig.
SC1-1/2T.250A	1.5	0.25	1.811	2.283	M6	-	A
SC1-1/2T.312A	1.5	0.312	1.811	2.283	M6	-	A
SC1-1/2T.375A	1.5	0.375	1.811	2.283	M8	-	A
SC1-1/2T.500A	1.5	0.5	1.811	2.283	M9	-	A
SC1-1/2T.625B	1.5	0.625	1.811	2.283	-	0.591	B
SC1-1/2T.750B	1.5	0.75	1.811	2.283	-	0.591	B
SC1-1/2T1.000B	1.5	1	1.811	2.283	-	0.591	B
SC1-1/2T1.250B	1.5	1.25	1.811	2.283	-	0.591	B

Grade
Insert
Toolholder
Ext. Toolholder
Int. Toolholder
Threading
Grooving
Miniature Tool
Milling Cutter
Endmill
Drilling Tool
Tooling System
User's Guide
Index



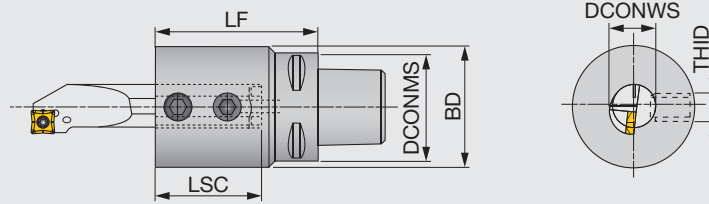

Metric	DCONMS	LF	LSC	DCONWS	BD	THID
C3ADI10	32	50	20	10	36	M6
C3ADI12	32	50	21.5	12	36	M8
C3ADI16	32	50	29.5	16	36	M8
C4ADI10	40	50	20	10	36	M6
C4ADI12	40	50	24	12	36	M8
C4ADI16	40	50	32	16	36	M8
C4ADI20	40	60	35	20	36	M10
C4ADI25	40	70	45	25	54	M12
C5ADI10	50	60	26	10	36	M6
C5ADI12	50	60	26	12	36	M8
C5ADI16	50	60	32	16	36	M8
C5ADI20	50	60	40	20	36	M10
C5ADI25	50	70	50	25	54	M12
C5ADI32	50	100	76	32	68	M12
C6ADI12	63	65	36	12	36	M8
C6ADI16	63	65	36	16	36	M8
C6ADI20	63	65	40	20	36	M10
C6ADI25	63	76	51	25	54	M12
C6ADI32	63	100	76	32	68	M12
C6ADI40	63	100	76	40	98	M12
C6ADI50	63	115	86	50	98	M12
C8ADI12	80	70	36	12	36	M8
C8ADI16	80	70	36	16	36	M8
C8ADI20	80	70	40	20	36	M10
C8ADI25	80	80	51	25	54	M12
C8ADI32	80	110	86	32	68	M12
C8ADI40	80	115	86	40	98	M12
C8ADI50	80	115	86	50	98	M12

Applicable for 7 MPa coolant

C-TBK-R/L

Adapter for parting blades

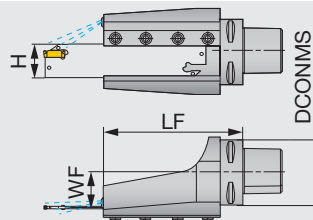

Right hand (R) shown.

Metric	DCONMS	WF	LF	H
C6TBK-32R/L	63	32	138	32

Applicable for 3 MPa coolant

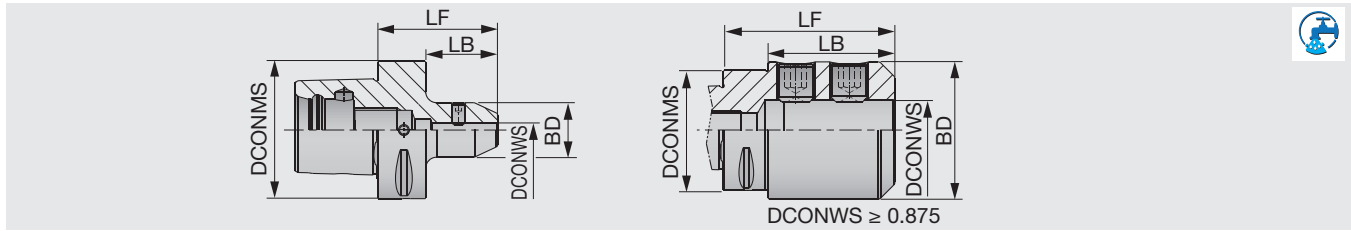

Inch	DCONMS	DCONWS	BD	LF	LB	Inch	DCONMS	DCONWS	BD	LF	LB
C6EM1/4X2.165	2.48	0.250	0.984	2.165	0.866	C6EM7/8X3.189	2.48	0.875	2.047	3.189	2.480
C6EM3/8X2.362	2.48	0.375	1.378	2.362	1.496	C6EM1X3.347	2.48	1.000	2.559	3.347	2.480
C6EM1/2X2.362	2.48	0.500	1.614	2.362	1.496	C6EM1-1/4X3.500	2.48	1.250	2.795	3.500	2.634
C6EM5/8X2.560	2.48	0.625	1.752	2.560	1.693	C6EM1-1/2X3.500	2.48	1.500	2.992	3.500	2.634
C6EM3/4X2.560	2.48	0.750	1.929	2.560	1.693						

Applicable for 7 MPa coolant

TUNGCAP

C-EM-E

Side-lock holder for drills (DIN1835 Form E whistle notch)

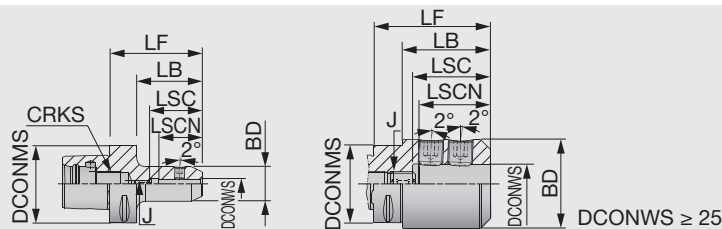

Metric	DCONMS	DCONWS	BD	LF	LSCN	LSC	LB	J	CRKS
C3EM06X70E	32	6	25	70	30	35	50	5	M14
C3EM12X75E	32	12	42	75	44	49	55	10	M14
C4EM06X70E	40	6	25	70	30	35	50	M5	M14
C4EM08X70E	40	8	28	70	35	43	50	M6	M14
C4EM10X70E	40	10	35	70	39	45	50	M8	M14
C4EM12X75E	40	12	42	75	44	49	55	M10	M14
C4EM14X75E	40	14	44	75	44	49	55	M10	M14
C5EM10X70E	50	10	35	70	39	45	50	M8	M16
C5EM12X75E	50	12	42	75	44	49	55	M10	M16
C5EM14X75E	50	14	44	75	44	49	55	M10	M16
C5EM16X80E	50	16	48	80	47	52	60	M12	M16
C5EM18X80E	50	18	50	80	47	52	60	M12	M16
C5EM20X85E	50	20	52	85	49	55	65	M16	M16
C6EM06X75E	63	6	25	75	30	36	53	M5	M20
C6EM08X75E	63	8	28	75	35	43	53	M6	M20
C6EM10X75E	63	10	35	75	39	46	53	M8	M20
C6EM12X80E	63	12	42	80	44	49	58	M10	M20
C6EM14X80E	63	14	44	80	44	49	58	M10	M20
C6EM16X85E	63	16	48	85	47	52	63	M12	M20
C6EM18X85E	63	18	50	85	47	52	63	M12	M20
C6EM20X85E	63	20	52	85	49	55	63	M16	M20
C6EM25X90E	63	25	65	90	54	60	68	M20	M20
C6EM32X95E	63	32	72	95	58	63	73	M20	M20
C8EM08X65E	80	8	28	65	35	43	35	M6	M20
C8EM10X65E	80	10	35	65	39	46	35	M8	M20
C8EM12X70E	80	12	42	70	44	49	40	M10	M20
C8EM14X70E	80	14	44	70	44	49	40	M10	M20
C8EM16X75E	80	16	48	75	47	52	45	M12	M20
C8EM18X75E	80	18	50	75	47	52	45	M12	M20
C8EM20X80E	80	20	52	80	49	57	50	M16	M20
C8EM25X90E	80	25	65	90	54	60	60	M20	M20
C8EM32X95E	80	32	72	95	58	64	65	M20	M20

Applicable for 7 MPa coolant

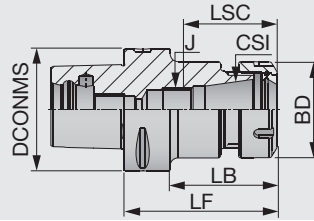

Inch	Range min.	Range max.	DCONMS	CSI	BD	LF	LB	J	LSC	Inch	Range min.	Range max.	DCONMS	CSI	BD	LF	LB	J	LSC
C3ER16X45	0.039	0.394	1.26	ER16	1.102	1.772	0.984	-	1.535	C6ER20X100	0.039	0.512	2.48	ER20	1.339	3.937	3.071	M12	2.067
C3ER20X45	0.039	0.512	1.26	ER20	1.339	1.772	1.181	-	1.567	C6ER20X130	0.039	0.512	2.48	ER20	1.339	5.118	4.252	M12	2.067
C4ER16X70	0.039	0.394	1.575	ER16	1.102	2.756	1.969	M10	1.638	C6ER20X160	0.039	0.512	2.48	ER20	1.339	6.299	5.433	M12	2.067
C4ER20X35*	0.039	0.512	1.575	ER20	1.339	1.378	1.063	-	1.567	C6ER25X060	0.039	0.63	2.48	ER25	1.654	2.362	1.496	-	1.591
C4ER20X52	0.039	0.512	1.575	ER20	1.339	2.047	1.26	-	1.539	C6ER25X100	0.039	0.63	2.48	ER25	1.654	3.937	3.071	M16	2.559
C4ER25X38*	0.039	0.63	1.575	ER25	1.654	1.496	1.181	-	1.705	C6ER25X130	0.039	0.63	2.48	ER25	1.654	5.118	4.252	M16	2.874
C4ER25X52	0.039	0.63	1.575	ER25	1.654	2.047	1.26	-	1.606	C6ER25X160	0.039	0.63	2.48	ER25	1.654	6.299	5.433	M16	2.874
C4ER32X54	0.079	0.787	1.575	ER32	1.969	2.126	1.339	-	1.839	C6ER32X060	0.079	0.787	2.48	ER32	1.969	2.362	1.417	-	1.882
C5ER16X100	0.039	0.394	1.969	ER16	1.102	3.937	3.15	M10	2.425	C6ER32X100	0.079	0.787	2.48	ER32	1.969	3.937	3.071	M22X1.5	2.339
C5ER16X130	0.039	0.394	1.969	ER16	1.102	5.118	4.331	M10	2.819	C6ER32X130	0.079	0.787	2.48	ER32	1.969	5.118	4.252	M22X1.5	2.732
C5ER20X055	0.039	0.512	1.969	ER20	1.339	2.165	1.378	-	1.547	C6ER32X160	0.079	0.787	2.48	ER32	1.969	6.299	5.433	M22X1.5	2.732
C5ER20X100	0.039	0.512	1.969	ER20	1.339	3.937	3.15	M12	2.067	C6ER40X065	0.118	1.024	2.48	ER40	2.48	2.559	1.457	-	2.165
C5ER20X130	0.039	0.512	1.969	ER20	1.339	5.118	4.331	M12	2.067	C6ER40X100	0.118	1.024	2.48	ER40	2.48	3.937	3.071	M28X1.5	2.362
C5ER25X055	0.039	0.63	1.969	ER25	1.654	2.165	1.378	-	1.594	C6ER40X130	0.118	1.024	2.48	ER40	2.48	5.118	4.252	M28X1.5	2.756
C5ER25X100	0.039	0.63	1.969	ER25	1.654	3.937	3.15	M16	2.559	C8ER32X70	0.079	0.787	3.15	ER32	1.969	2.756	1.575	-	1.882
C5ER32X057	0.079	0.787	1.969	ER32	1.969	2.244	1.417	-	1.858	C8ER32X100	0.079	0.787	3.15	ER32	1.969	3.937	2.756	M22X1.5	2.378
C5ER32X100	0.079	0.787	1.969	ER32	1.969	3.937	1.417	M22X1.5	2.339	C8ER32X160	0.079	0.787	3.15	ER32	1.969	6.299	5.118	M22X1.5	2.575
C6ER16X100	0.039	0.394	2.48	ER16	1.102	3.937	3.071	M10	2.425	C8ER40X70	0.118	1.024	3.15	ER40	2.48	2.756	1.575	-	2.157
C6ER16X130	0.039	0.394	2.48	ER16	1.102	5.118	4.252	M10	2.819	C8ER40X100	0.118	1.024	3.15	ER40	2.48	3.937	2.756	M28X1.5	2.362
C6ER16X160	0.039	0.394	2.48	ER16	1.102	6.299	5.433	M10	2.819	C8ER40X160	0.118	1.024	3.15	ER40	2.48	6.299	5.118	M28X1.5	2.795
C6ER20X060	0.039	0.512	2.48	ER20	1.339	2.362	1.496	-	1.555										

* Without V grooves, for manual use only.
Applicable for 10 MPa coolant

Option: Wrench for ER collet

TUNGCAP

C-ER-M

ER Mini collet chuck holder (DIN6499)

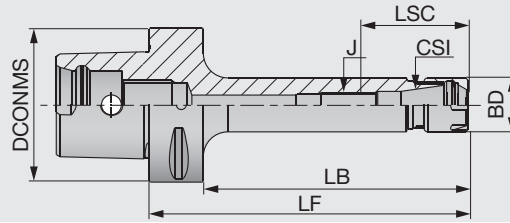

Inch	Range min	Range max	DCONMS	CSI	BD	LF	LB	J	LSC
C4ER16X70M	0.02	0.394	1.575	ER16	0.866	2.756	1.969	M10	1.614
C5ER16X100M	0.02	0.394	1.969	ER16	0.866	3.937	3.15	M10	1.811
C5ER16X130M	0.02	0.394	1.969	ER16	0.866	5.118	4.724	M10	1.811
C6ER16X100M	0.02	0.394	2.48	ER16	0.866	3.937	3.071	M10	1.811
C6ER16X130M	0.02	0.394	2.48	ER16	0.866	5.118	4.252	M10	1.811
C6ER16X160M	0.02	0.394	2.48	ER16	0.866	6.299	5.433	M10	1.811

Applicable for 10 MPa coolant

Option: Wrench for ER collet

TUNGCAP

ADJ C-ER

ER collet chuck with center alignment

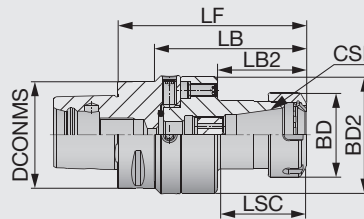

Inch	DCONMS	CSI	Range min	Range max	BD2	BD	LF	LB	LB2	LSC
ADJC5ER32	1.969	ER32	0.079	0.787	2.756	1.969	4.528	3.74	2.067	2.244
ADJC6ER32	2.48	ER32	0.079	0.787	2.756	1.969	4.39	3.524	2.067	2.244

Applicable for 10 MPa coolant

Option: Wrench for ER collet

WRENCH-ER / ER DIN 6499

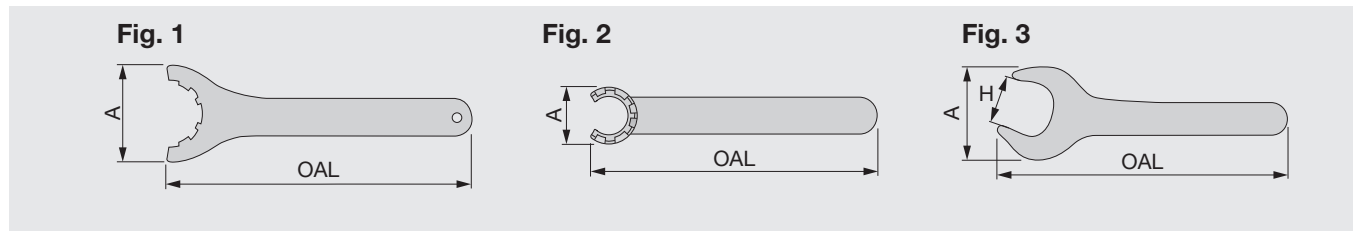

Metric	A	H	OAL	Fig.
WRENCHER11MINI	16.8	-	95	2
WRENCHER11	32	17	95	3
WRENCHER16MINI	22.5	-	117	2
WRENCHER16	42.8	25	143	3
WRENCHER20MINI	28	-	128	2
WRENCHER20	53.5	30	172	3
WRENCHER25MINI	29	-	120	2
WRENCHER25	70	-	207	1
WRENCHER32	78	-	255	1
WRENCHER40	95	-	285	1
WRENCHER50	110	-	350	1
WRENCHER20SHORTRING22	48	22	260	3
WRENCHER32SHORT	75	36	303	3
WRENCHER40SHORT	94	46	378	3

PRESET ER-JET (Preset screw)

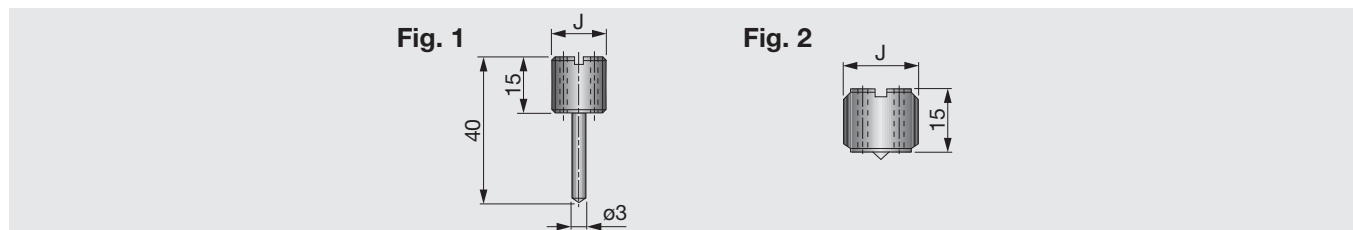

Metric	J	Fig.
PRESETER-JET8X1	M8X1.0	2
PRESETER-JET8X1.25	M8X1.25	2
PRESETER-JET10X1.5	M10X1.5	2
PRESETER-JET12X1	M12X1.0	2
PRESETER-JET12X1.75L	M12X1.75	1
PRESETER-JET12X1.75	M12X1.75	2
PRESETER-JET14X1	M14X1.0	2
PRESETER-JET16X2	M16X2	2
PRESETER-JET16X2L	M16X2	1
PRESETER-JET18X1	M18X1.0	2
PRESETER-JET18X1.5	M18X1.5	2
PRESETER-JET18X1.5L	M18X1.5	1
PRESETER-JET22X1.5	M22X1.5	2
PRESETER-JET22X1.5L	M22X1.5	1
PRESETER-JET28X1.5	M28X1.5	2

Grade
Insert
Toolholder
Ext. Toolholder
Int. Toolholder
Threading
Grooving
Milling Cutter
Miniature Tool
Endmill
Drilling Tool
Tooling System
User's Guide
Index

A
B
C
D
E
F
G
H
I
J
K
L
M

Shell mill holder with coolant nozzle

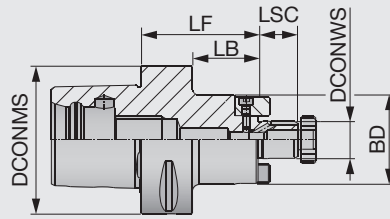

Inch	DCONMS	DCONWS	BD	LF	LSC	LB	Width of key	Height of key	Inch	DCONMS	DCONWS	BD	LF	LSC	LB	Width of key	Height of key
C6SEM3/4X1.377C	2.48	0.75	1.772	1.377	0.669	0.512	8	5	C6SEM1X3.937C	2.48	1.00	2.165	3.937	0.669	3.071	12	6.3
C6SEM3/4X3.937C	2.48	0.75	1.772	3.937	0.669	3.071	8	5	C6SEM1-1/4X2.362C	2.48	1.25	2.519	2.362	0.669	1.496	12.7	6
C6SEM1X1.457C	2.48	1.00	2.165	1.457	0.669	0.59	10	5.4	C6SEM1-1/2X2.362C	2.48	1.50	3.070	2.362	0.937	1.496	14	7
Metric	DCONMS	DCONWS	BD	LF	LSC	LB	Width of key	Height of key	Metric	DCONMS	DCONWS	BD	LF	LSC	LB	Width of key	Height of key
C4SEM16X32C	40	16	38	32	12	17	8	5	C6SEM27X100C	63	27	58	100	21	78	12	6.3
C4SEM16X55C	40	16	38	55	35	17	8	5	C6SEM31.75X60C	63	31.75	64	60	30	-	12.7	6
C4SEM22X40C	40	22	47	40	20	19	10	5.4	C6SEM32X60C	63	32	66	60	24	38	14	7
C4SEM22X55C	40	22	47	55	35	19	10	5.4	C6SEM38.1X60C	63	38.1	78	60	34	-	15.875	8
C5SEM16X35C	50	16	38	35	17	15	8	5	C6SEM40X60C	63	40	82	60	27	38	16	8
C5SEM16X70C	50	16	38	70	17	50	8	5	C8SEM16X50C	80	16	38	50	20	17	8	5
C5SEM22X35C	50	22	47	35	19	15	10	5.4	C8SEM16X100C	80	16	38	100	70	17	8	5
C5SEM22X70C	50	22	47	70	19	50	10	5.4	C8SEM22X50C	80	22	47	50	20	19	10	5.4
C5SEM25.4X37C	50	25.4	55	37	22	-	9.525	4.6	C8SEM22X100C	80	22	47	100	70	19	10	5.4
C5SEM27X40C	50	27	58	40	21	20	12	6.3	C8SEM25.4X50C	80	25.4	50	50	22	20	9.525	4.6
C5SEM31.75X60C	50	31.75	64	60	30	-	12.7	6	C8SEM27X50C	80	27	58	50	20	21	12	6.3
C5SEM32X40C	50	32	63	40	24	20	14	7	C8SEM27X100C	80	27	58	100	70	21	12	6.3
C6SEM16X50C	63	16	38	50	17	28	8	5	C8SEM31.75X50C	80	31.75	60	50	30	20	12.7	7
C6SEM16X100C	63	16	38	100	17	78	8	5	C8SEM32X50C	80	32	66	50	20	24	14	7
C6SEM22X50C	63	22	47	50	19	28	10	5.4	C8SEM32X100C	80	32	66	100	70	24	14	7
C6SEM22X100C	63	22	47	100	19	78	10	5.4	C8SEM38.1X50C	80	38.1	80	50	34	-	15.875	8
C6SEM25.4X37C	63	25.4	55	37	22	15	9.525	4.6	C8SEM40X60C	80	40	82	60	30	27	16	8
C6SEM27X60C	63	27	58	60	21	38	12	6.3									

Applicable for 7 MPa coolant

Option: Wrench for lock screw

WRENCH SEMC / DIN6368

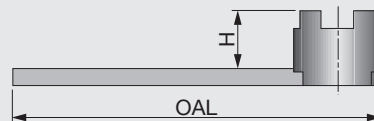

Metric	Arbor diameter of cutter body	Screw size	H	OAL
WRENCHM8SEMC16	16	M8	20	180
WRENCHM10SEMC22	22	M10	25	200
WRENCHM12SEMC27	25.4 / 27	M12	32	225
WRENCHM16SEMC32	31.75 / 32	M16	36	250
WRENCHM20SEMC40	38.1 / 40	M20	40	280
WRENCHM24SEMC50	50	M24	50	315

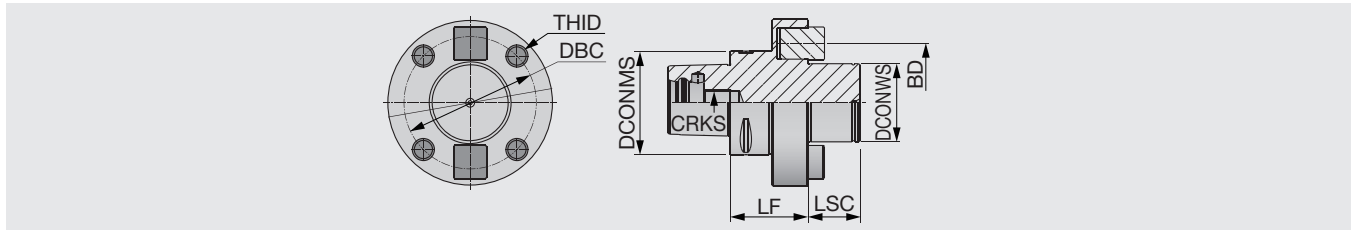

Metric	DCONMS	DCONWS	LSC	LF	BD	DBC	THID	CRKS	Width of key	Height of key
C8FM60X60	80	60	40	60	128	101.6	M16	M20	25.4	12.4

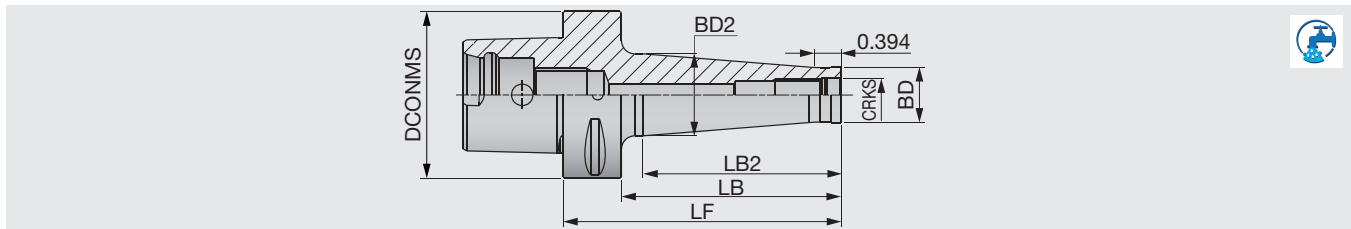

Inch	CRKS	DCONMS	BD	BD2	LF	LB	LB2
C4ODP10X53	M10	1.575	0.709	0.906	2.087	1.299	0.906
C4ODP12X53	M12	1.575	0.827	1.024	2.087	1.299	0.906
C4ODP16X53	M16	1.575	1.142	1.339	2.087	1.299	0.906
C5ODP10X53	M10	1.969	0.709	0.768	2.087	1.299	0.984
C5ODP10X103	M10	1.969	0.709	1.102	4.055	3.268	2.953
C5ODP12X53	M12	1.969	0.827	0.925	2.087	1.299	0.984
C5ODP12X103	M12	1.969	0.827	1.220	4.055	3.268	2.953
C5ODP16X53	M16	1.969	1.142	1.339	2.087	1.299	0.984
C5ODP16X103	M16	1.969	1.142	1.417	4.055	3.268	2.953
C6ODP10X55	M10	2.480	0.709	0.768	2.165	1.299	0.984
C6ODP10X105	M10	2.480	0.709	1.102	4.134	3.268	2.953
C6ODP10X130	M10	2.480	0.709	1.260	5.118	4.252	3.937
C6ODP12X55	M12	2.480	0.827	0.925	2.165	1.299	0.984
C6ODP12X105	M12	2.480	0.827	1.220	4.134	3.268	2.953
C6ODP12X130	M12	2.480	0.827	1.417	5.118	4.252	3.937
C6ODP16X55	M16	2.480	1.142	1.339	2.165	1.299	0.984
C6ODP16X105	M16	2.480	1.142	1.339	4.134	3.268	2.953
C6ODP16X130	M16	2.480	1.142	1.614	5.118	4.252	3.937

Applicable for 10 MPa coolant

Power chuck holder

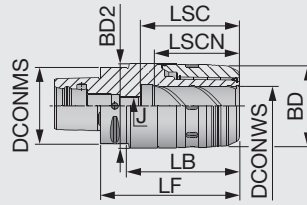

Inch	DCONMS	Range min	Range max	DCONWS	BD	BD2	LF	LB	LSCN	LSC	J
C6MAXIN3/4X3.74	2.48	0.250	0.750	0.750	2.000	2.087	3.780	2.913	2.15	2.64	M16
C6MAXIN1-1/4X4.448	2.48	0.250	1.250	1.250	2.717	2.756	4.528	3.622	2.76	3.23	M16

Applicable for 10 MPa coolant

Option : Wrench for TungMax collet

SC-SEAL

SC sealed straight collet

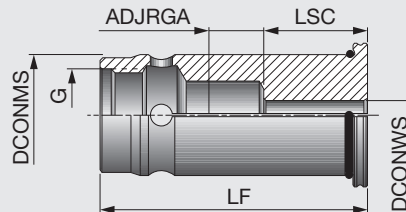

Inch	DCONWS	DCONMS	LF	LSC	ADJRGA	G
SC 3/4 SEAL 1/4	0.250	0.750	2.362	1.102	0.276	M16
SC 3/4 SEAL 5/16	0.313	0.750	2.362	1.102	0.276	M16
SC 3/4 SEAL 3/8	0.375	0.750	2.362	1.378	0.512	M16
SC 3/4 SEAL 7/16	0.438	0.750	2.362	1.575	0.315	M16
SC 3/4 SEAL 1/2	0.500	0.750	2.362	1.575	0.315	M16
SC 3/4 SEAL 5/8	0.625	0.750	2.362	1.543	0.354	M16
SC 1-1/4 SEAL 1/4	0.250	1.250	2.835	1.102	0.689	M2.4X1.5
SC 1-1/4 SEAL 5/16	0.313	1.250	2.835	1.102	0.689	M2.4X1.5
SC 1-1/4 SEAL 3/8	0.375	1.250	2.835	1.378	0.413	M2.4X1.5
SC 1-1/4 SEAL 1/2	0.500	1.250	2.835	1.575	0.217	M2.4X1.5
SC 1-1/4 SEAL 5/8	0.625	1.250	2.835	1.732	0.709	M2.4X1.5
SC 1-1/4 SEAL 3/4	0.750	1.250	2.835	1.811	0.63	M2.4X1.5
SC 1-1/4 SEAL 7/8	0.875	1.250	2.835	1.969	0.453	M2.4X1.5
SC 1-1/4 SEAL 1	1.000	1.250	2.835	2.008	0.453	M2.4X1.5

Applicable for 10 MPa coolant

SC-SPR

SC straight collet

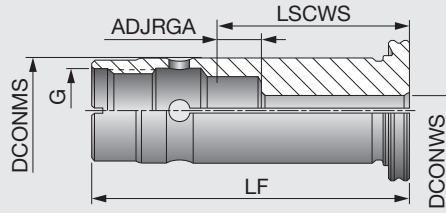

Inch	DCONWS	DCONMS	LF	LSCWS	ADJRGA	G
SC 3/4 SPR 1/4	0.250	0.750	2.362	1.378	0.276	M16
SC 3/4 SPR 5/16	0.313	0.750	2.362	1.378	0.276	M16
SC 3/4 SPR 3/8	0.375	0.750	2.362	1.890	0.512	M16
SC 3/4 SPR 7/16	0.438	0.750	2.362	1.417	0.315	M16
SC 3/4 SPR 1/2	0.500	0.750	2.362	1.378	0.276	M16
SC 3/4 SPR 5/8	0.625	0.750	2.362	1.897	0.354	M16
SC 1-1/4 SPR 1/4	0.250	1.250	2.835	1.791	0.689	M2.4X1.5
SC 1-1/4 SPR 5/16	0.313	1.250	2.835	1.791	0.689	M2.4X1.5
SC 1-1/4 SPR 3/8	0.375	1.250	2.835	1.791	0.413	M2.4X1.5
SC 1-1/4 SPR 1/2	0.500	1.250	2.835	1.792	0.217	M2.4X1.5
SC 1-1/4 SPR 5/8	0.625	1.250	2.835	2.441	0.709	M2.4X1.5
SC 1-1/4 SPR 3/4	0.750	1.250	2.835	2.441	0.630	M2.4X1.5
SC 1-1/4 SPR 7/8	0.875	1.250	2.835	2.422	0.453	M2.4X1.5
SC 1-1/4 SPR 1	1.000	1.250	2.835	2.417	0.409	M2.4X1.5

PRESET SC CAP

Preset screw for SC collets

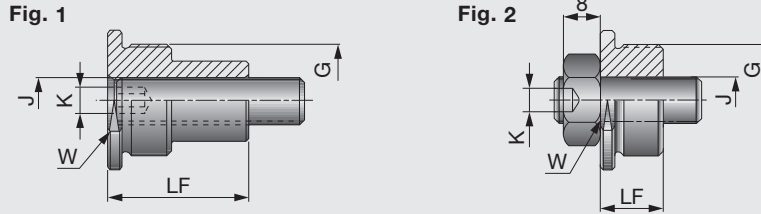

Metric	LF	W	J	G	Range	Key	Collet size	Fig.
PRESETSCCAP8X1.25L	28	16	M8x25	M16	6-8	4	SC20	1
PRESETSCCAP8X1.25	15	16	M8x25	M16	10-16	4	SC20	2
PRESETSCCAP10X1.5L	30	27	M10x30	M24x1.5	6-14	5	SC32	1
PRESETSCCAP10X1.5	13.5	27	M10x30	M24x1.5	16-25	5	SC32	2

Wrench

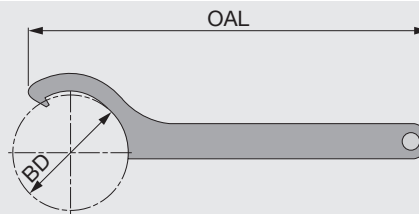

Metric	BD	OAL	Toolholder
WRENCHMAXIN20HOOK	26	205	MAXIN3/4
WRENCHMAXIN32HOOK	68	240	MAXIN11/4



SC collet extracting hook

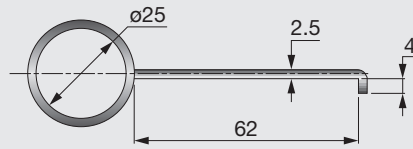

Metric

EXTRACTORSCCOLLETS

Preset screw

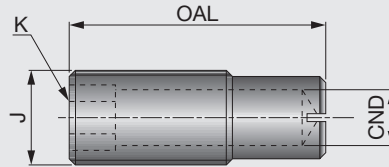

Metric

	J	OAL	CND	K
PRESETMAXIN16X30	M16	30	8	8
PRESETMAXIN16X44	M16	44	8	8
PRESETMAXIN20X55	M20	55	12	12

TUNGCAP

C-SRKIN

TUNGSHRINK

Shrink holder

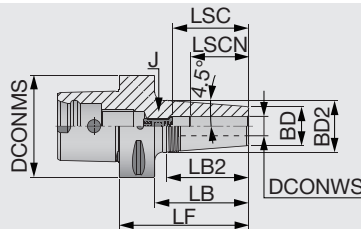

Inch	DCONMS	DCONWS	BD	BD2	LF	LB	LB2	LSCN	LSC	J
C6SRKIN1/4X3.150	2.48	0.25	0.827	1.063	3.15	2.363	1.5	0.98	1.42	M5
C6SRKIN5/16X3.150	2.48	0.312	0.827	1.063	3.15	2.363	1.5	0.98	1.42	M6
C6SRKIN3/8X3.150	2.48	0.375	0.945	1.26	3.15	2.363	2	1.22	1.65	M8
C6SRKIN1/2X3.150	2.48	0.5	0.945	1.26	3.15	2.363	2	1.42	1.85	M10
C6SRKIN5/8X3.35	2.48	0.625	1.063	1.339	3.35	2.563	1.75	1.54	1.97	M12
C6SRKIN3/4X3.35	2.48	0.75	1.299	1.654	3.35	2.563	2.25	1.61	2.05	M16
C6SRKIN1X3.55	2.48	1	1.732	2.087	3.55	2.763	2.25	1.85	2.28	M16
C6SRKIN11/4X3.75	2.48	1.25	1.732	2.087	3.75	2.963	2.25	1.85	2.28	M16

Applicable for 10 MPa coolant

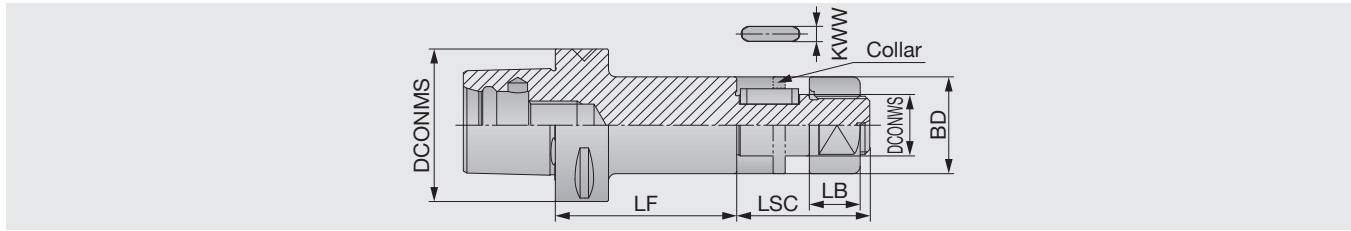

Metric	DCONMS	DCONWS	LF	BD	LSC	LB	Width of key KWM	Height of key
C6SCA25.4-075	63	25.4	75	40	55	21	6.35	2.38
C6SCA31.75-075	63	31.75	75	46	60	26	7.92	3.17
C8SCA25.4-090	80	25.4	90	40	55	21	6.35	2.38
C8SCA31.75-090	80	31.75	90	46	60	26	7.92	3.17

Collars for slot mills are not included

SCA

Collar for slot milling holders

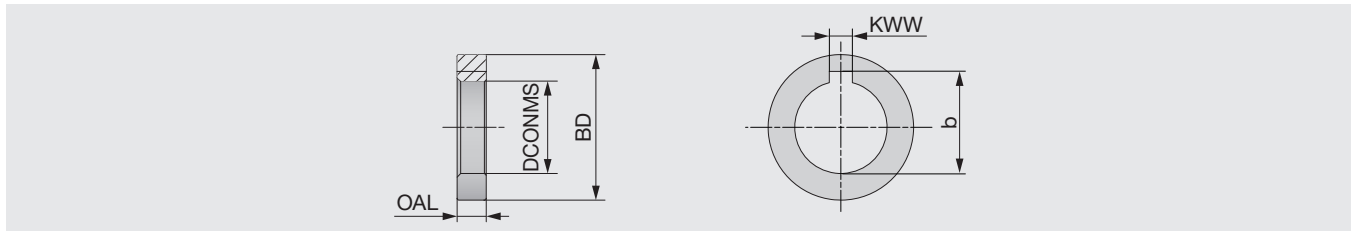

Metric	BD	DCONMS	b	KWW	OAL
SCA25.4-02	40	25.4	28.1	6.35	3, 5, 7, 8, 10, 12, 14
SCA31.75-02	46	31.75	35.2	7.92	3, 5, 7, 8, 10, 12, 14

TUNGCAP

HSK-A-C/-T

Basic holder for HSK to PSC convertor

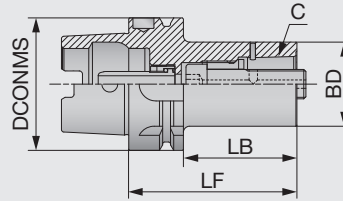

Metric	DCONMS	C	BD	LF	LB	Nm ⁽¹⁾	Wrench size
HSK63A-C4-080T ⁽²⁾	63	C4	40	80	54	55	8
HSK63A-C5-090T ⁽²⁾	63	C5	50	90	64	95	10
HSK63A-C6-110T ⁽²⁾	63	C6	63	110	74	170	14
HSK100A-C6-110	100	C6	63	110	81	170	14
HSK100A-C8-120	100	C8	80	120	91	170	14

Applicable for 7 MPa coolant

Option: Cooling tube wrench

(1) Recommended clamping torque: N·m

(2) For HSK-T standard

TUNGCAP

C-EX

Extension adapter

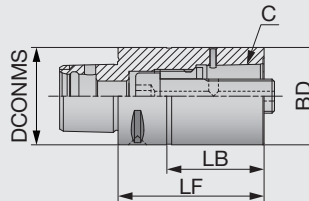

Metric	C	DCONMS	BD	LF	LB	Nm ⁽¹⁾	Wrench size
C4EX-060	C4	40	40	60	80	65	8
C4EX-080	C4	40	40	80	60	65	8
C5EX-080	C5	50	50	80	60	95	10
C5EX-100	C5	50	50	100	80	95	10
C6EX-100	C6	63	63	100	78	170	14
C6EX-140	C6	63	63	140	118	170	14
C8EX-100	C8	80	80	100	70	170	14
C8EX-160	C8	80	80	160	130	170	14

Applicable for 7 MPa coolant

(1) Recommended clamping torque: N·m

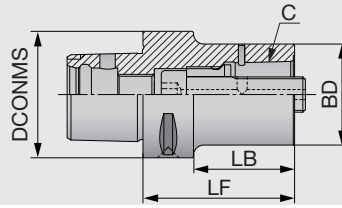

Metric	C	DCONMS	BD	LF	LB	Nm ⁽¹⁾	Wrench size
C5-C4RE-060	C4	50	40	60	40	55	8
C5-C4RE-080	C4	50	40	80	60	55	8
C6-C4RE-080	C4	63	40	80	58	55	8
C6-C5RE-080	C5	63	50	80	58	95	10
C6-C5RE-120	C5	63	50	120	98	95	10
C8-C4RE-070	C4	80	40	70	40	55	8
C8-C5RE-080	C5	80	50	80	50	95	10
C8-C6RE-080	C6	80	63	80	50	170	14
C8-C6RE-120	C6	80	63	120	90	170	14

Applicable for 7 MPa coolant

(1) Recommended clamping torque: N·m

MULTI CLAMP (TungCap)

Multi-clamp fixture for TungCap

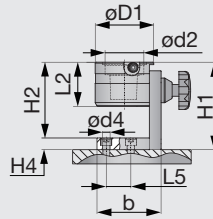

Metric	CSI	ød2	øD1	L2	H1	H2	H4	b	L5	ød4
MULTICLAMPC3	C3	32	70	64	128	109	19	104	40	12.5
MULTICLAMPC4	C4	40	78	67	137	118	19	104	40	12.5
MULTICLAMPC5	C5	50	85	72	142	123	19	104	40	12.5
MULTICLAMPC6	C6	63	95	72	142	123	19	104	40	12.5
MULTICLAMPC8	C8	80	130	90	178	159	19	144	85	12.5

TungCap Test bar

Test bar

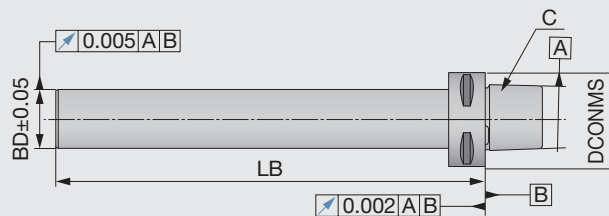

Metric	C	DCONMS	BD	LB
C3-TB-160	C3	32	25	160
C4-TB-160	C4	40	25	160
C5-TB-160	C5	50	30	180
C6-TB-220	C6	63	35	220
C8-TB-250	C8	80	40	250

Grade
Insert
Toolholder
Ext. Toolholder
Int. Toolholder
Threading
Grooving
Milling Cutter
Miniature Tool
Endmill
Drilling Tool
Tooling System
User's Guide
Index



TUNGCAP

SWISS+TOOLS®

Fine boring heads with digital display

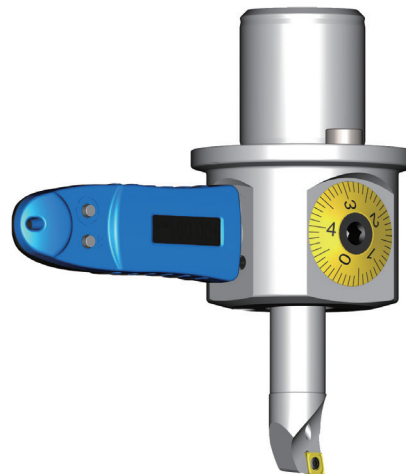

Fine boring head system makes **micron adjustment easy and simple in the machine**

- Easy and accurate adjustment: 1 μm accuracy is possible on the machine
- Digital display: the display unit is docked on the boring head for micron adjustment
- Economy: One digital unit can be used with all fine boring heads
- Internal coolant for smooth chip control
- Also available with TungCap connection, allowing it for use in multi-tasking machines

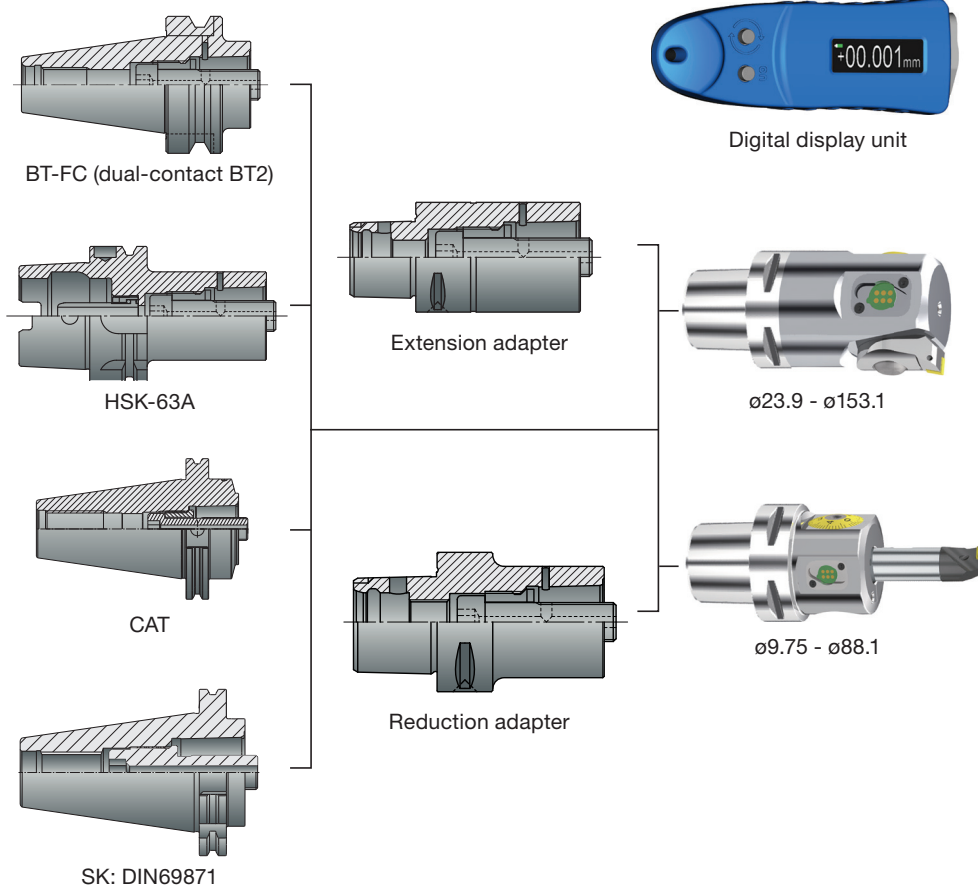

Reference pages: **K047 - K054**

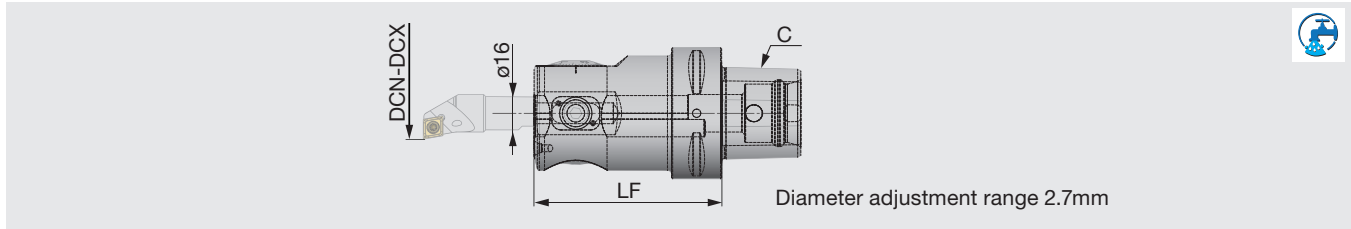

Metric	C	DCN	DCX	LF	Boring bar
BT4-FBHO-DE-1690	BT40	9.75	88.1	90	254.0**.006... / 256...
HA6-FBHO-DE-1695	HSK-A63	9.75	88.1	95	254.0**.006... / 256...
PSC63-FBHO-DE-1690	C6	9.75	88.1	90	254.0**.006... / 256...
PSC50-FBHO-DE-1670	C5	9.75	88.1	70	254.0**.006... / 256...
PSC40-FBHO-DE-1665	C4	9.75	88.1	65	254.0**.006... / 256...

Applicable for 7 MPa coolant

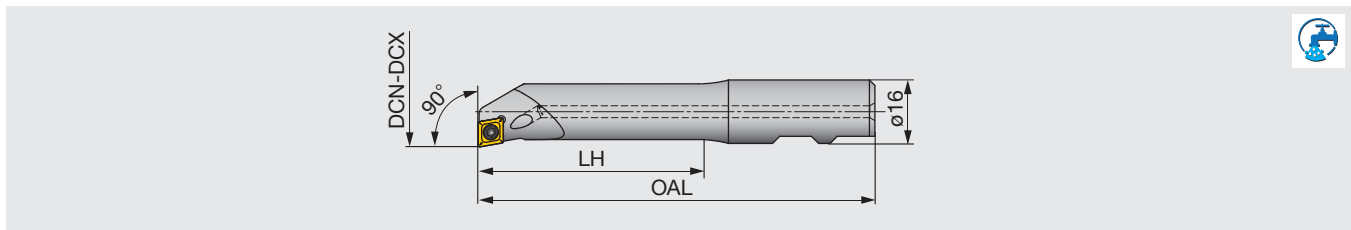

Metric	DCN	DCX	LH	OAL	Insert
254.010.006.075	9.75	15.1	30	75	CC**0602...
254.015.006.090	14.75	20.1	51	90	CC**0602...
254.020.006.105	19.75	25.1	72	105	CC**0602...
254.025.006.115	24.75	30.1	82	115	CC**0602...

Applicable for 7 MPa coolant

SPARE PARTS



Designation	Clamping screw	Wrench
254.0**.006.**	CSTB-2.5S	T-8F

TUNGCAP**TungCap 256.0**.0**.115**

Boring bar

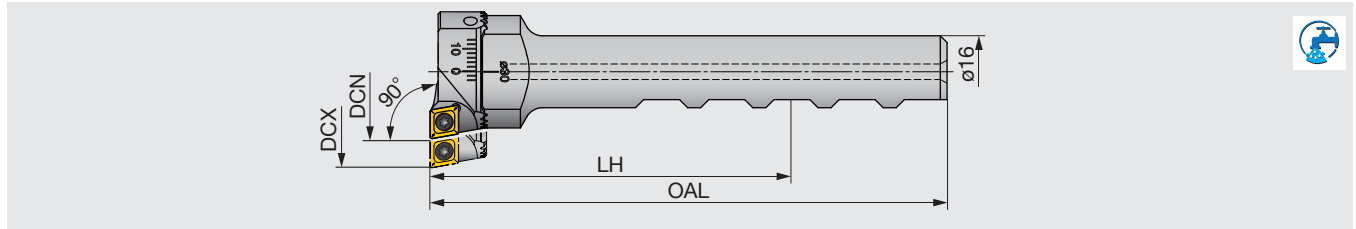

Metric (Shank)	Metric (Insert holder)	DCN	DCX	LH	OAL	Insert
256.030.048.115	256.030.006.012	29.75	48.1	85	115	CC**0602...
256.048.088.115	256.048.006.014	47.75	88.1	85	115	CC**0602...

Applicable for 7 MPa coolant

SPARE PARTS

Designation	Clamping screw	Wrench
256.0**006.0**	CSTB-2.5S	T-8F

TUNGCAP**TungCap FBHS-DE**

Fine boring head for digital display ø23.9 mm - ø153.1 mm

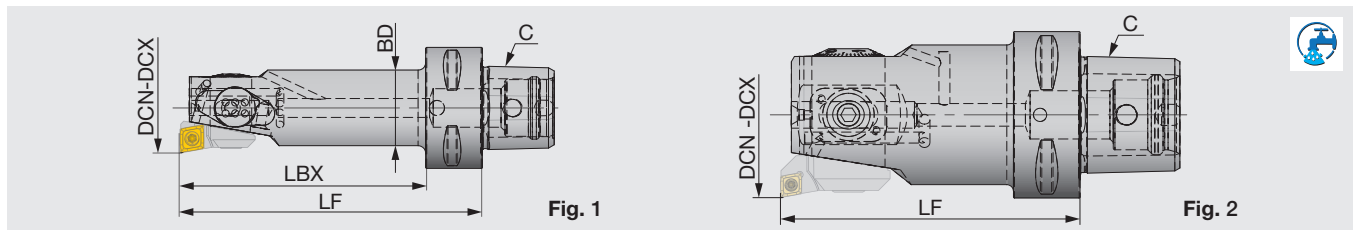

Metric	C	DCN	DCX	LF	LBX	BD	Fig.	Insert holder
PSC32-FBHS-DE-24	C3	23.9	31.1	80	65	20	1	314.011.024.006/007
PSC32-FBHS-DE-24	C3	29.9	37.1	80	65	20	1	314.011.030.006/007
PSC32-FBHS-DE-31	C3	30.9	40.1	90	75	25	1	314.013.031.006/007
PSC32-FBHS-DE-31	C3	37.5	47.1	90	75	25	1	314.013.038.006/007
PSC40-FBHS-DE-40	C4	39.9	51.1	90	70	32	1	314.017.040.006/007
PSC40-FBHS-DE-40	C4	47.5	59.1	90	70	32	1	314.017.048.006/007
PSC50-FBHS-DE-51	C5	50.9	67.1	90	-	-	2	314.022.051.006/007
PSC50-FBHS-DE-51	C5	64.9	81.1	90	-	-	2	314.022.065.006/007
PSC50-FBHS-DE-67	C5	66.9	87.1	100	-	-	2	314.030.067.009/011
PSC50-FBHS-DE-67	C5	84.9	105.1	100	-	-	2	314.030.085.009/011
PSC63-FBHS-DE-87	C6	86.9	116.1	120	-	-	2	314.030.067.009/011
PSC63-FBHS-DE-87	C6	104.9	134.1	120	-	-	2	314.030.085.009/011
PSC63-FBHS-DE-116	C6	115.9	153.1	150	-	-	2	314.030.067.009/011
PSC63-FBHS-DE-116	C6	133.9	171.1	150	-	-	2	314.030.085.009/011

Insert holders are sold separately.
Applicable for 7 MPa coolant

Reference pages: 256.0**0**.115: Inserts → **B111** -

Insert holder of fine boring head for digital display $\varnothing 23.9$ mm - $\varnothing 153.1$ mm

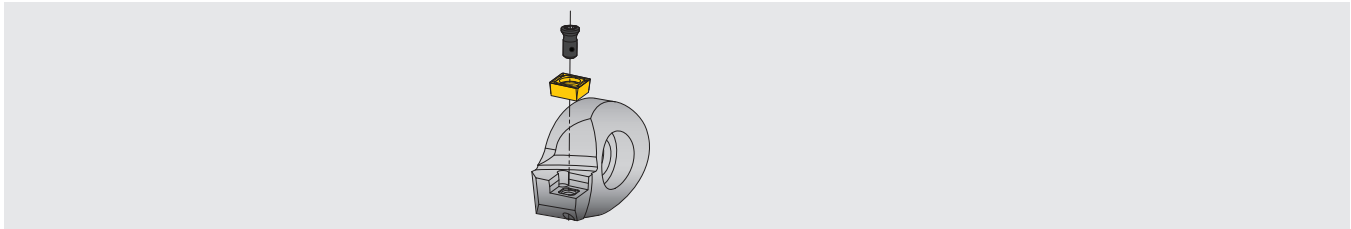

Metric (Insert holder)	Insert
314.011.024.006	CC**0602...
314.013.031.006	CC**0602...
314.017.040.006	CC**0602...
314.022.051.006	CC**0602...
314.030.067.009	CC**08T3..

SPARE PARTS



Designation	Clamping screw	Wrench
314.0**.0**.0**	CSTB-2.5S	T-8F

Digital display unit



Metric
GH1-DA2.BG0.077

Nomenclature for clamping units

Clamping units

Clamping units for non-rotating and rotating tools, designed for turret lathes

- Clamping units for standard square and round shanks
- Clamping units for PSC Bolt-on clamp interface
- Clamping units for Vertical Disc Interface (VDI DIN69880)



Standard interface

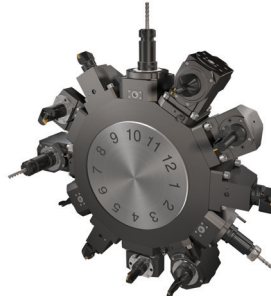

PBI



VDI (DIN69880)

Clamping units

	For external (Tool setting direction cross X)	For internal (Tool setting direction straight Z)
Turning clamping unit	C*-DTO-*C-***-R/L	C*-DTI-*C-****-R/L
Driven clamping unit	C*-DDC-*C-****	C*-DDS-*C-****

Nomenclature for clamping units

Nomenclature for static clamping unit

C4 - DTI - IC - ABC401 - R

1	2	3	4	5	6	7
PSC size	Device	Motion	Application	Coolant	Unit number	Hand
C3	D	T Static (turning tool)	O For external turning	IC Internal	Manufacturer's symbol	R Right
C4			I For internal turning	OC External		L Left
C5			S Others			
C6						
C8						

Nomenclature for driven clamping unit

C5 - DDC - OC - ABC501

1	2	3	4	5	6
PSC size	Device	Motion	Application	Coolant	Unit number
C3	D	D Driven (rotating tool)	S Straight: Z	OC External	Manufacturer's symbol
C4			C Cross: X	WC Internal / External	
C5			X Others		
C6					
C8					

C-DTOSR/L

Manual clamping unit, square shank

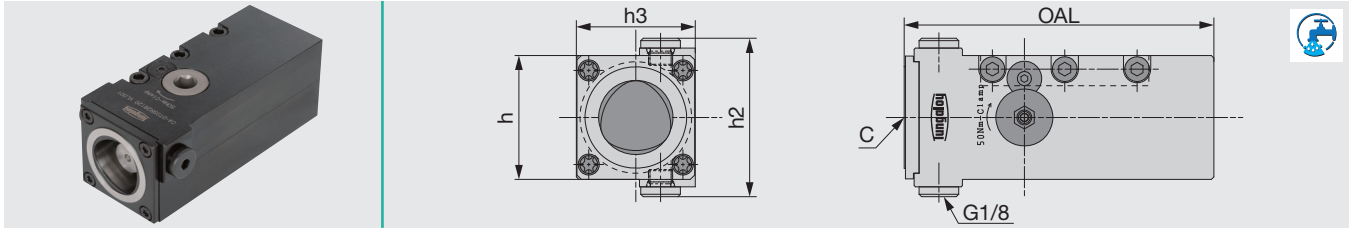

Metric	C	Turret size h	h3	h2	OAL	Torque
C3-DTOS4038R/L	C3	40	38	62	95	35
C4-DTOS5048R/L	C4	50	48	64	125	50
C5-DTOS6464R/L	C5	60	64	68	145	70

Applicable for 7 MPa coolant
Torque: Recommended clamping torque: N·m

C-DTIR

Manual clamping unit, round shank

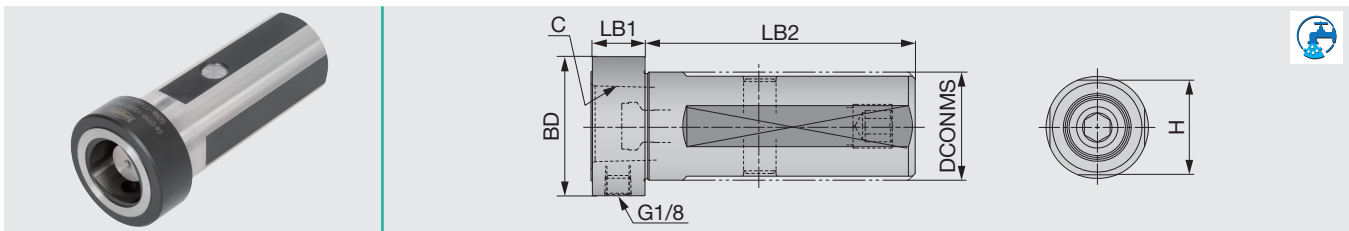

Metric	C	DCONMS	BD	H	LB2	LB1	Torque
C3-DTIR-08018-D32	C3	32	41.5	30	80	18	35
C4-DTIR-10020-D40	C4	40	51.5	37	100	20	50
C4-DTIR-12020-D50	C4	50	51.5	47	120	20	50
C5-DTIR-12024-D50	C5	50	61.5	47	120	24	70

Applicable for 7 MPa coolant
Torque: Recommended clamping torque: N·m

C-DTOFR/L

Manual clamping unit, fixed type

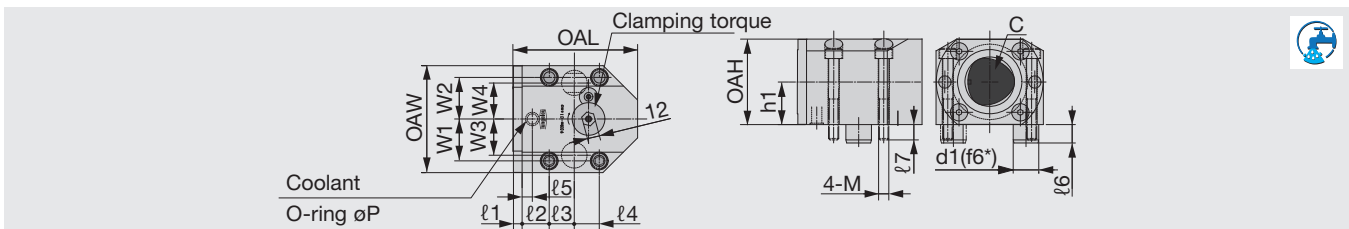

Metric	C	OAH	h1	OAL	OAW	W1	W2	W3	W4	l1	l2	l3	l4	l5	l6	l7	d1(f6*)	P	M	Torque
C5-DTOFR/L32048	C5	64	32	100	92	35	31	8	19	21	7	11	15	20	P8	M10	70			
C6-DTOFR/L42060	C6	84	42	122	105	41	35.5	9	26.5	24.5	10	18	15	25	P10	M10	90			
C8-DTOFR/L50088	C8	100	50	146	133	55	46	12	33	43	13	19	20	32	P11	M12	130			

Applicable for 7 MPa coolant
Torque: Recommended clamping torque: N·m

*f6 tolerance: d20 & 25 = -0.022 / -0.033, d32 = -0.025 / -0.041

Clamping units & tools for CNC lathes

Selection for External turning

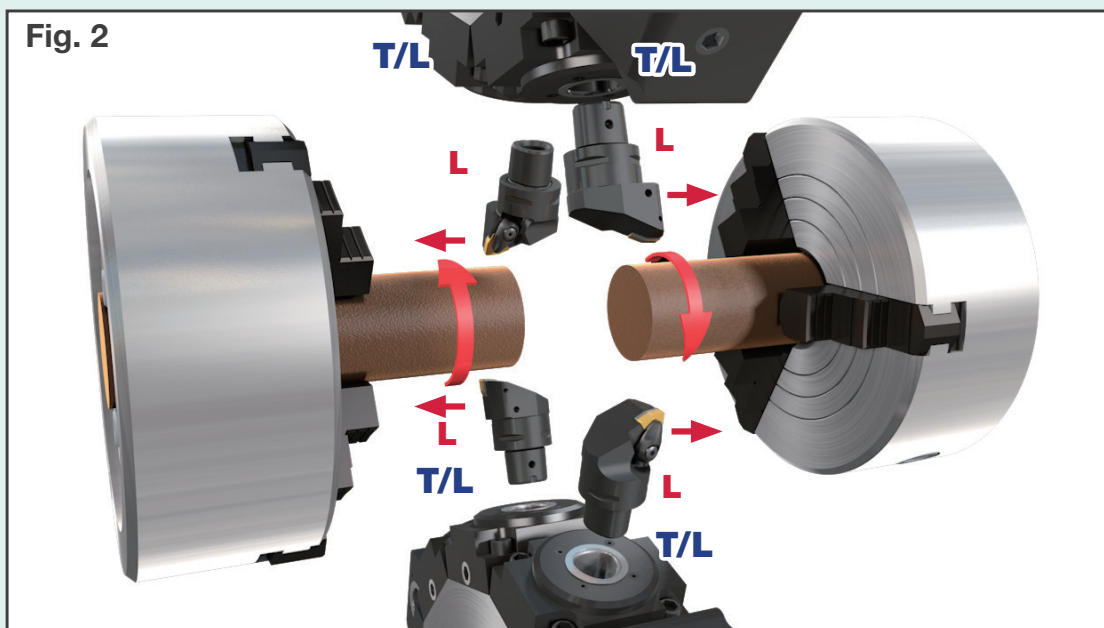
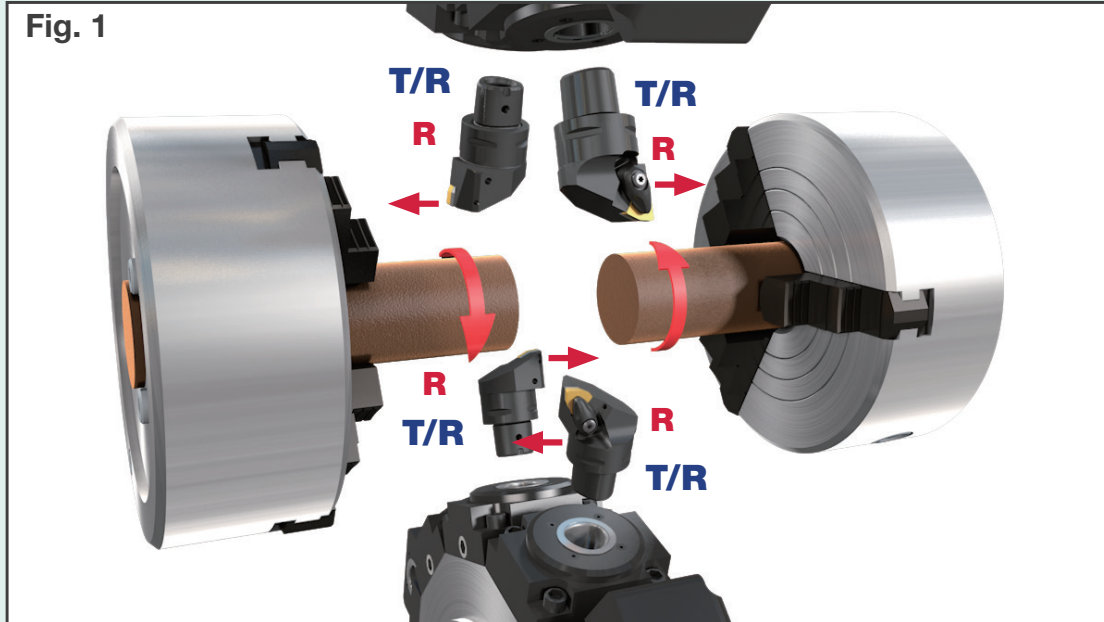

R: Right hand cutting tool **L:** Left hand cutting tool
T/R: Right hand clamping unit **T/L:** Left hand clamping unit

Clamping units & tools for CNC lathes

Selection for Internal turning

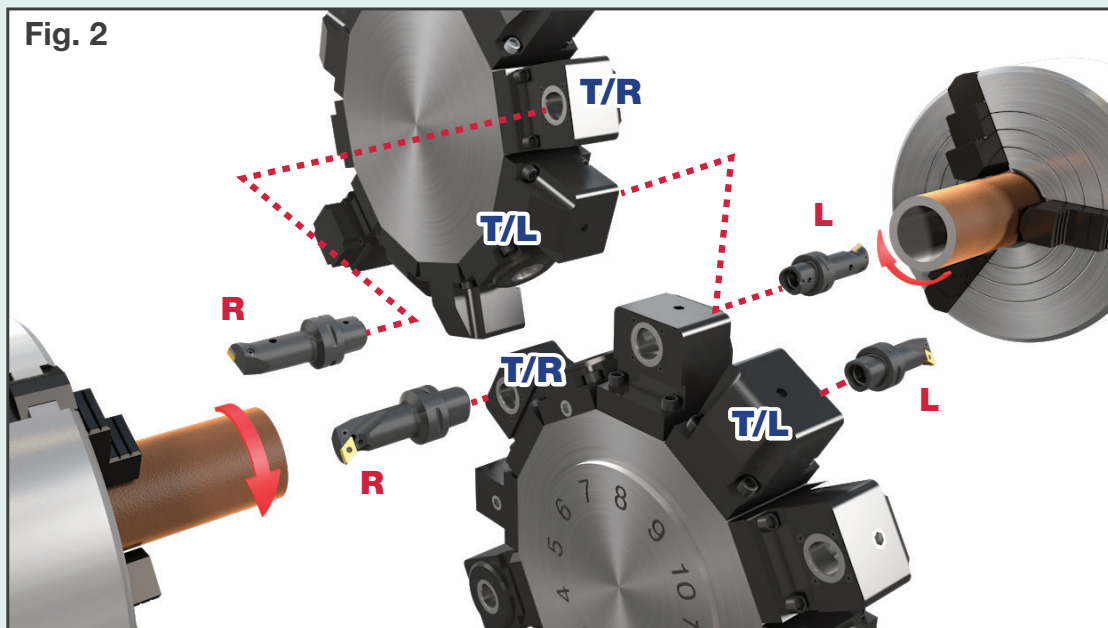
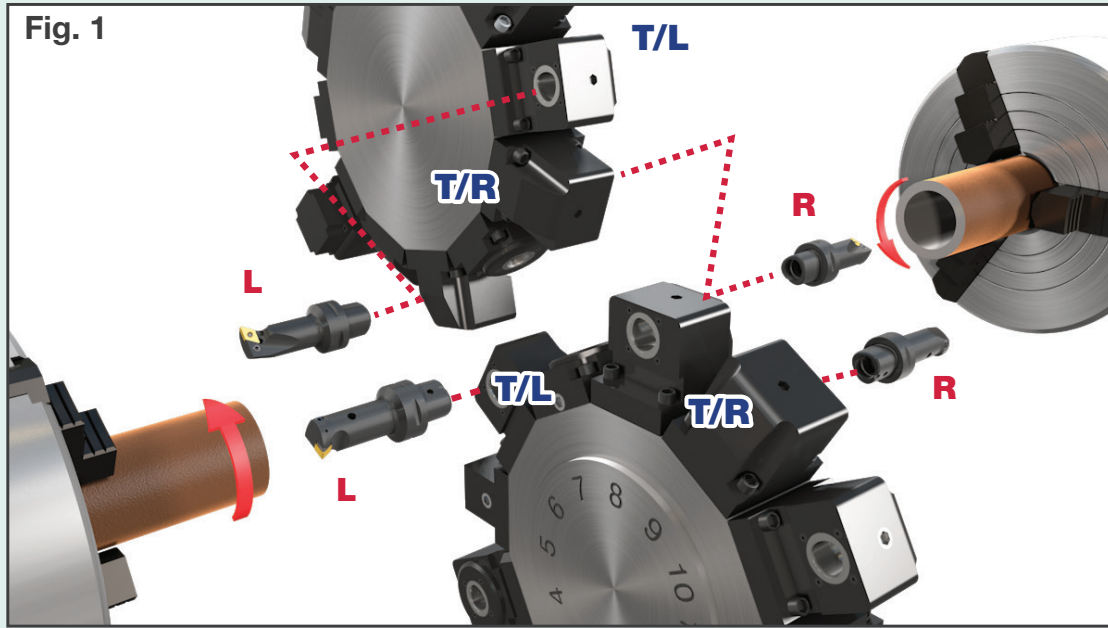

R: Right hand cutting tool **L:** Left hand cutting tool
T/R: Right hand clamping unit **T/L:** Left hand clamping unit

Clamping torque



PSC size	Tightening torque recommendation (N·m)	Clamping force (KN)	Torque wrench size	
			Static tool unit	Driven tool unit
C3	35	15	8	6
C4	50	20	10	8
C5	70 (75*)	25	12	10
C6	90 (110*)	30	12	12
C8	130	40	12	12

* Torque value for driven tool unit

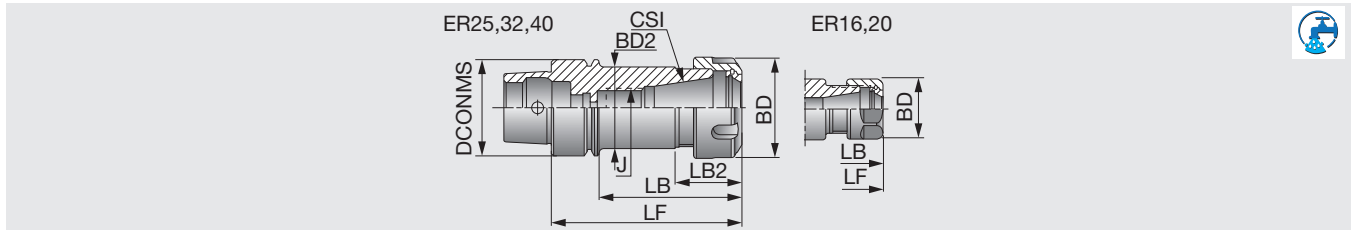

Metric	DCONMS	CSI	Range	LF	LB	LB2	BD	BD2	J
HSKE32ER16X60	32	ER16	0.5-10	60	40	21.5	28	22.4	-
HSKE32ER20X60	32	ER20	1-13	6	40	26	34	25.4	-
HSKE32ER25X65	32	ER25	1-16	65	45	30	42	25.8	-
HSKE40ER16X60	40	ER16	0.5-10	60	40	-	28	-	-
HSKE40ER16X80	40	ER16	0.5-10	80	60	-	28	-	M10
HSKE40ER20X80	40	ER20	1-13	80	60	-	34	-	M12
HSKE40ER25X80	40	ER25	1-16	80	60	28	42	34	M18X1.5
HSKE40ER32X80	40	ER32	2-20	80	60	31	50	40.1	M22X1.5
HSKE50ER16X100 ⁽¹⁾	50	ER16	0.5-10	100	74	-	28	-	M10
HSKE50ER16X100M ⁽¹⁾⁽³⁾	50	ER16	0.5-10	100	74	-	22	-	M10
HSKE50ER16X80 ⁽¹⁾	50	ER16	0.5-10	80	54	-	28	-	M10
HSKE50ER20X80 ⁽¹⁾	50	ER20	1-13	80	54	-	34	-	M10
HSKE50ER25X80 ⁽¹⁾	50	ER25	1-16	80	54	28	42	32.4	-
HSKE50ER32X80 ⁽¹⁾	50	ER32	2-20	80	54	31	50	40.4	-
HSKE50ER32X100 ⁽¹⁾	50	ER32	2-20	100	74	31	50	40.4	M22X1.5
HSKE63ER16X80 ⁽²⁾	63	ER16	0.5-10	80	54	-	28	-	M10
HSKE63ER16X100 ⁽²⁾	63	ER16	0.5-10	100	74	-	28	-	M10
HSKE63ER20X75 ⁽²⁾	63	ER20	1-13	75	49	-	34	-	-
HSKE63ER32X100 ⁽²⁾	63	ER32	2-20	100	75	-	50	-	M22X1.5

Applicable for 10 MPa coolant

Equipped with nut ER 16 MINI

(1) Balanced to G2.5 max.n: 35,000 min⁻¹

(2) Balanced to G2.5 max.n: 35,000 min⁻¹

(3) Balanced to G2.5 max.n: 30,000 min⁻¹

Option: Wrench for ER collet

Reference pages



ER collet

K108



Nut

K128



Preset screw

K131



Wrench

K130, K135



Cooling tube

K134

TUNGHOLD

HSK A-ER M

ER Mini collet chuck holder (HSK-A)

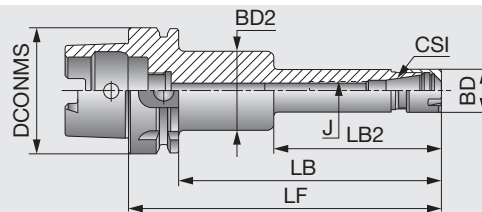

Metric	DCONMS	CSI	Range	LF	LB	LB2	BD	BD2	J
HSKA63ER16X100M	63	ER16	0.5-10	100	74	-	22	-	M10
HSKA63ER16X120M	63	ER16	0.5-10	120	94	78	22	40	M10
HSKA63ER16X160M	63	ER16	0.5-10	160	134	85	22	40	M10
HSKA63ER20X100M	63	ER20	1-13	100	74	-	28	-	M12
HSKA63ER20X120M	63	ER20	1-13	120	94	-	28	-	M12
HSKA63ER20X160M	63	ER20	1-13	160	134	85	28	45	M12
HSKA100ER16X100M ⁽¹⁾	100	ER16	0.5-10	100	71	-	22	-	M10
HSKA100ER16X160M ⁽¹⁾	100	ER16	0.5-10	160	131	85	22	40	M10
HSKA100ER20X100M ⁽¹⁾	100	ER20	1-13	100	71	-	28	-	M12
HSKA100ER20X160M ⁽¹⁾	100	ER20	1-13	160	131	85	28	45	M12

Applicable for 10 MPa coolant
 (1) Balanced to G6.3 max.n: 12,000 min⁻¹

Option: Wrench for ER collet

Reference pages



ER collet

K108



Nut

K128



Preset screw

K131



Wrench

K130, K135



Cooling tube

K134

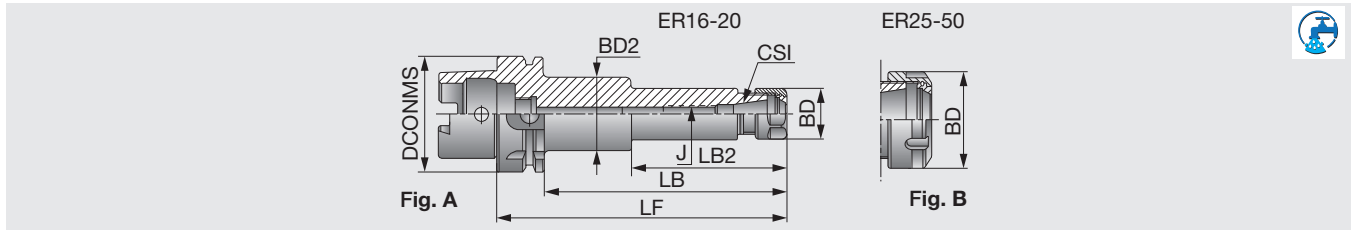

Metric	DCONMS	CSI	Range	LF	LB	LB2	BD	BD2	J	Fig.
HSKA40ER16X60	40	ER16	0.5-10	60	40	-	28	-	M10	A
HSKA40ER16X80	40	ER16	0.5-10	80	60	-	28	-	M10	A
HSKA50ER20X100	50	ER20	1-13	100	74	-	34	-	M12	A
HSKA63ER16X100	63	ER16	0.5-10	100	74	-	28	-	M10	A
HSKA63ER16X120	63	ER16	0.5-10	120	94	-	28	-	M10	A
HSKA63ER16X160	63	ER16	0.5-10	160	134	85.6	28	40	M10	A
HSKA63ER20X100	63	ER20	1-13	100	74	-	34	-	M12	A
HSKA63ER20X120	63	ER20	1-13	120	94	-	34	-	M12	A
HSKA63ER20X160	63	ER20	1-13	160	134	85.0	34	45	M12	A
HSKA100ER16X100 ⁽¹⁾	100	ER16	0.5-10	100	71	-	28	-	M10	A
HSKA100ER16X160 ⁽¹⁾	100	ER16	0.5-10	160	131	85	28	40	M10	A
HSKA100ER20X100 ⁽¹⁾	100	ER20	1-13	100	71	-	34	-	M12	A
HSKA100ER20X160 ⁽¹⁾	100	ER20	1-13	160	131	85	34	45	M12	A
HSKA40ER25X80	40	ER25	1-16	80	60	28	42	32.4	M18x1.5	B
HSKA40ER25X100	40	ER25	1-16	100	80	28	42	32.4	M16	B
HSKA40ER32X100	40	ER32	2-20	100	80	31	50	40.4	M22x1.5	B
HSKA63ER25X80	63	ER25	1-16	80	54	-	42	-	M16	B
HSKA63ER25X100	63	ER25	1-16	100	74	-	42	-	M16	B
HSKA63ER25X120	63	ER25	1-16	120	94	-	42	-	M16	B
HSKA63ER25X160	63	ER25	1-16	160	134	-	42	-	M16	B
HSKA63ER32X80	63	ER32	2-20	80	54	31	50	40.4	M22x1.5	B
HSKA63ER32X100	63	ER32	2-20	100	74	-	50	-	M22x1.5	B
HSKA63ER32X120	63	ER32	2-20	120	94	-	50	-	M22x1.5	B
HSKA63ER32X140	63	ER32	2-20	140	114	-	50	-	M22x1.5	B
HSKA63ER32X160	63	ER32	2-20	160	134	-	50	-	M22x1.5	B
HSKA63ER40X80	63	ER40	3-26	80	54	34	63	50.4	-	B
HSKA63ER40X100	63	ER40	3-26	100	74	34	63	50.4	M28x1.5	B
HSKA63ER40X120	63	ER40	3-26	120	94	34	63	50.4	M28x1.5	B
HSKA100ER25X100	100	ER25	1-16	100	71	-	42	-	M16	B
HSKA100ER25X120	100	ER25	1-16	120	91	-	42	-	M16	B
HSKA100ER25X160	100	ER25	1-16	160	134	-	42	-	M16	B
HSKA100ER32X100	100	ER32	2-20	100	71	-	50	-	M22x1.5	B
HSKA100ER32X120	100	ER32	2-20	120	91	-	50	-	M22x1.5	B
HSKA100ER32X160	100	ER32	2-20	160	131	-	50	-	M22x1.5	B
HSKA100ER40X100	100	ER40	3-26	100	71	-	63	-	M28x1.5	B
HSKA100ER40X120	100	ER40	3-26	120	91	-	63	-	M28x1.5	B
HSKA100ER40X160	100	ER40	3-26	160	131	-	63	-	M28x1.5	B
HSKA100ER50X100	100	ER50	10-34	100	71	-	78	-	-	B

Applicable for 10 MPa coolant
 (1) Balanced to G6.3 max.n: 12,000 min⁻¹

Option: Wrench for ER collet

Reference pages

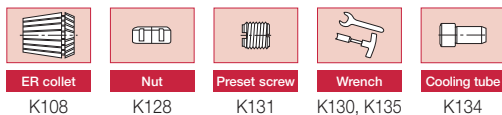

Grade
Insert
Toolholder
Ext. Toolholder
Int. Toolholder
Threading
Grooving
Milling Cutter
Miniature Tool
Endmill
Drilling Tool
Tooling System
User's Guide
Index

A
B
C
D
E
F
G
H
I
J
K
L
M

TUNGHOLD

HSK FM-ER

ER collet chuck holder (HSK-FM)

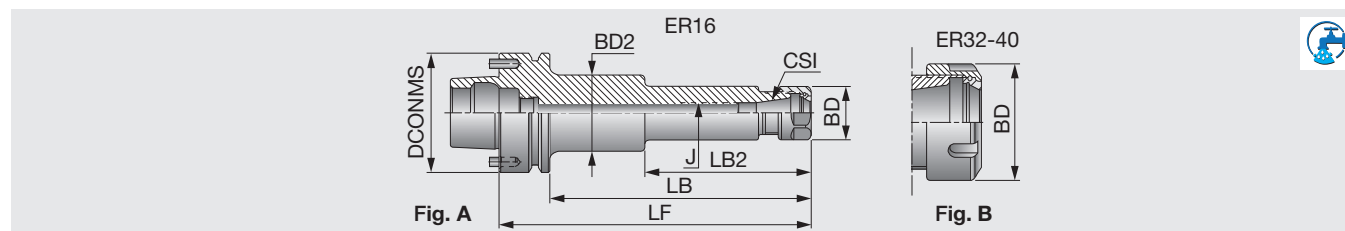

Metric	DCONMS	CSI	Range	LF	LB	LB2	BD	BD2	J	Fig.
HSKFM63ER16X80	63	ER16	0.5-10	80	54	-	28	-	M10	A
HSKFM63ER16X100	63	ER16	0.5-10	100	74	-	28	-	M10	A
HSKFM63ER16X120	63	ER16	0.5-10	120	94	-	28	-	M10	A
HSKFM63ER16X160	63	ER16	0.5-10	160	134	85.6	28	40	M10	A
HSKFM63ER32X80	63	ER32	2-20	80	54	-	50	-	-	B
HSKFM63ER32X100	63	ER32	2-20	100	74	-	50	-	M22x1.5	B
HSKFM63ER40X80	63	ER40	3-26	80	54	32	63	50	-	B
HSKFM63ER40X100	63	ER40	3-26	100	74	32	63	50	M28x1.5	B

Applicable for 10 MPa coolant

The driving pins can be removed, turning the toolholder into a standard HSK F63 type.

Option: Wrench for ER collet

TUNGBALANCE

HSK A-ER BIN

ER collet chuck holder with adjustable dynamic balance (HSK-A)

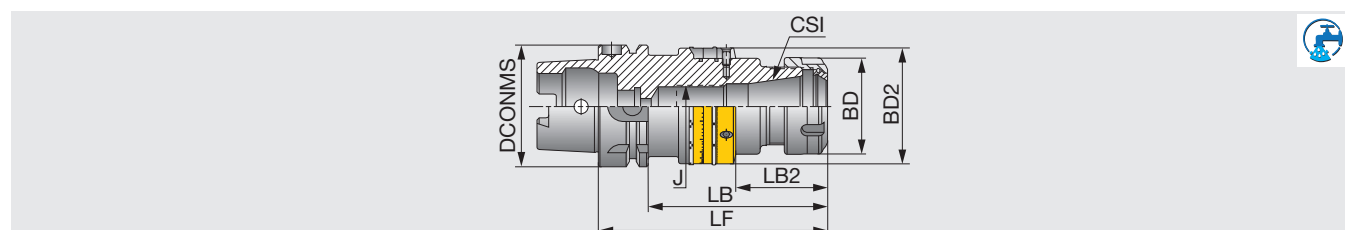

Metric	DCONMS	CSI	Range	LF	LB	LB2	BD	BD2	J
HSKA63ER16X100BIN	63	ER16	0.5-10	100	74	45	28	44	M10
HSKA63ER25X100BIN	63	ER25	1-16	100	74	45.2	42	44	M16
HSKA63ER32X120BIN	63	ER32	2-20	120	94	48	50	60	M22x1.5

Applicable for 10 MPa coolant

(1) Balanced to G2.5 max.n: 20,000 min⁻¹

Option: Wrench for ER collet

Reference pages

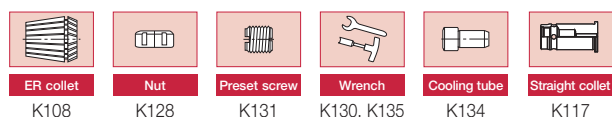

TUNGSHORT

HSK A-SHORT

ER collet chuck holder, short type (HSK-A)

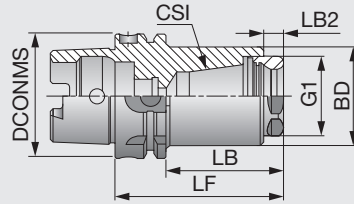

Metric	DCONMS	CSI	Range	LF	LB	LB2	BD	G1
HSKA63ER32SHORT	63	ER32	2-20	84.5	56.1	9.5	50	M40x1.5
HSKA100ER32SHORT	100	ER32	2-20	89.5	60.5	9.5	50	M40x1.5
HSKA100ER40SHORT	100	ER40	3-26	104.5	75.5	9.5	70	M50x1.5

Applicable for 10 MPa coolant
Balanced to G6.3 max.n: 8,000 min⁻¹

Option: Wrench for ER collet

TUNGMAX

HSK A-TUNGMAX

Power chuck holder (HSK-A)

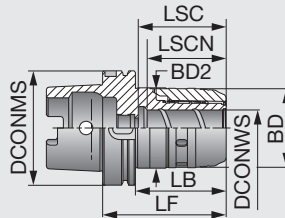

Metric	DCONMS	DCONWS	Range	LF	LB	LSCN	LSC	BD	BD2
HSKA63MAXIN20X95	63	20	6-20	95	69	56	66	51	53
HSKA63MAXIN32X113	63	32	6-32	113	87	70	85	69	70
HSKA100MAXIN20X115 ⁽¹⁾	100	20	6-20	115	86	56	69	51	53
HSKA100MAXIN32X135 ⁽¹⁾	100	32	6-32	135	106	71	87	69	70

Applicable for 10 MPa coolant
⁽¹⁾ Balanced to G6.3 max.n: 8,000 min⁻¹

Option: Wrench for TungMax collet

TUNGBALANCE

HSK A-TUNGMAX BIN

Power chuck holder with adjustable dynamic balance (HSK-A)

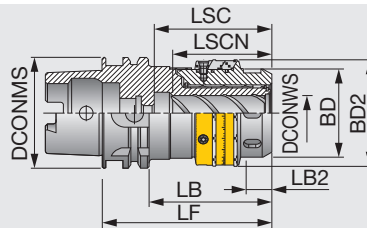

Metric	DCONMS	DCONWS	Range	LF	LB	LB2	LSCN	LSC	BD	BD2
HSKA63MAXIN20X95BIN ⁽¹⁾	63	20	6-20	95	69	17.5	56	66	51	61
HSKA63MAXIN32X113BIN ⁽¹⁾	63	32	6-32	113	87	24.9	70	85	69	80

Applicable for 10 MPa coolant

⁽¹⁾ Chucks with taper size HSK A63 can be balanced by the balancing ring up to G2.5 at 20,000 min⁻¹.
⁽²⁾ Chucks with taper size HSK A100 can be balanced by the balancing ring up to G2.5 at 18,000 min⁻¹.

Option: Wrench for TungMax collet

Reference pages

ER collet	Nut	Preset screw	Wrench	Cooling tube	Straight collet
K108	K128	K131	K130, K135	K134	K117

TUNGHYDRO

HSK A-HYDRO

Hydraulic endmill chuck holder (HSK-A)

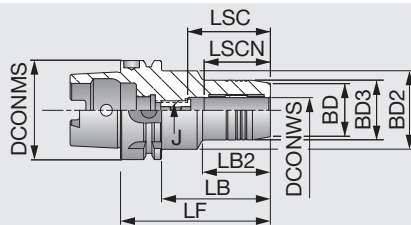

Metric	DCONMS	DCONWS	BD3	BD	BD2	LF	LB	LB2	LSCN	LSC	J
HSKA50HYDRO6X80	50	6	26	23	42	80	54	35	27	37	M5
HSKA50HYDRO8X80	50	8	28	25	42	80	54	36	27	37	M6
HSKA50HYDRO16X95	50	16	38	34	42	95	69	52	42	52	M12x1
HSKA50HYDRO20X100	50	20	42	38	42	100	74	74	42	52	M16x1
HSKA63HYDRO6X80	63	6	26	23	50	80	54	33	27	37	M5
HSKA63HYDRO8X80	63	8	28	25	50	80	54	33	27	37	M6
HSKA63HYDRO10X85	63	10	30	27	50	85	59	39	32	42	M8x1
HSKA63HYDRO12X90	63	12	32	29	50	90	64	44	37	47	M10x1
HSKA63HYDRO14X90	63	14	34	30	50	90	64	46	37	47	M10x1
HSKA63HYDRO16X95	63	16	38	34	50	95	69	52	42	52	M12x1
HSKA63HYDRO18X95	63	18	40	36	50	95	69	52	42	52	M12x1
HSKA63HYDRO20X100	63	20	42	38	50	100	74	58	42	52	M16x1
HSKA63HYDRO25X120	63	25	50	46	50	120	94	94	48	58	M16x1
HSKA63HYDRO32X125	63	32	60	56	53	125	99	83	52	62	M16x1
HSKA80HYDRO6X85	80	6	26	23	50	85	59	37	27	37	M5
HSKA80HYDRO14X95	80	14	34	30	50	95	69	47	37	47	M10x1
HSKA80HYDRO16X100	80	16	38	34	50	100	74	52	42	52	M12x1
HSKA80HYDRO18X100	80	18	40	36	50	100	74	52	42	52	M12x1
HSKA80HYDRO20X105	80	20	42	38	50	105	79	52	42	52	M16x1
HSKA80HYDRO25X115	80	25	50	46	50	115	89	58	48	58	M16x1
HSKA100HYDRO6X85	100	6	26	23	63	85	56	29	27	37	M5
HSKA100HYDRO8X85	100	8	28	25	63	85	56	29	27	37	M6
HSKA100HYDRO10X90	100	10	30	27	63	90	61	35	32	42	M8x1
HSKA100HYDRO12X95	100	12	32	29	63	95	66	40	37	47	M10x1
HSKA100HYDRO14X95	100	14	34	30	63	95	66	42	37	47	M10x1
HSKA100HYDRO16X100	100	16	38	34	63	100	71	47	42	52	M12x1
HSKA100HYDRO18X100	100	18	40	36	63	100	71	48	42	52	M12x1
HSKA100HYDRO20X105	100	20	42	38	63	105	76	54	42	52	M16x1
HSKA100HYDRO25X115	100	25	50	46	63	115	86	51	48	58	M16x1
HSKA100HYDRO32X120	100	32	60	56	63	120	91	59	52	62	M16x1

Applicable for 10 MPa coolant

Reduction sleeves are available for d = 12, 20, 25, and 32mm.

Chucking force will reduce when using a reduction sleeve.

Option: Clamping wrench

Reference pages



Straight collet

K120



Cooling tube

K134



Wrench

K135

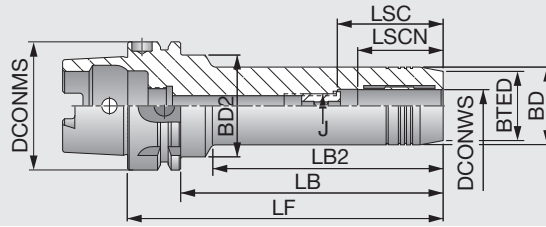

Metric	DCONMS	DCONWS	BD	BTED	BF2	LF	LB	LB2	LSCN	LSC	J
HSKA63HYDRO6X150	63	6	26	23	50	150	124	103	27	37	M5
HSKA63HYDRO6X200	63	6	26	23	50	200	174	153	27	37	M5
HSKA63HYDRO8X150	63	8	28	25	50	150	124	104	27	37	M6
HSKA63HYDRO10X150	63	10	30	27	50	150	124	104	32	42	M8x1
HSKA63HYDRO10X200	63	10	30	27	50	200	174	154	32	42	M8x1
HSKA63HYDRO12X150	63	12	32	29	50	150	124	105	37	47	M10x1
HSKA63HYDRO12X200	63	12	32	29	50	200	174	155	37	47	M10x1
HSKA63HYDRO14X150	63	14	34	30	50	150	124	105	37	47	M10x1
HSKA63HYDRO16X150	63	16	38	34	50	150	124	106.5	42	52	M12x1
HSKA63HYDRO16X200	63	16	38	34	50	200	174	156.5	42	52	M12x1
HSKA63HYDRO20X150	63	20	42	38	50	150	124	108	42	52	M12x1
HSKA63HYDRO20X200	63	20	42	38	50	200	174	158	42	52	M12x1
HSKA63HYDRO25X150	63	25	50	46	50	150	124	-	48	58	M16x1
HSKA63HYDRO25X200	63	25	50	46	50	200	174	-	48	58	M16x1
HSKA100HYDRO6X150	100	6	26	23	50	150	124	94	27	37	M6
HSKA100HYDRO6X200	100	6	26	23	50	200	174	144	27	37	M6
HSKA100HYDRO8X150	100	8	28	25	50	150	124	94.5	27	37	M6
HSKA100HYDRO8X200	100	8	28	25	50	200	174	144.5	27	37	M6
HSKA100HYDRO10X150	100	10	30	27	50	150	124	95	32	42	M8x1
HSKA100HYDRO10X200	100	10	30	27	50	200	174	145	32	42	M8x1
HSKA100HYDRO12X150	100	12	32	29	50	150	124	95.5	37	47	M10x1
HSKA100HYDRO12X200	100	12	32	29	50	200	174	145.5	37	47	M10x1
HSKA100HYDRO14X150	100	14	34	30	50	150	124	97	37	47	M10x1
HSKA100HYDRO14X200	100	14	34	30	50	200	174	147	37	47	M10x1
HSKA100HYDRO16X150	100	16	38	34	50	150	124	97.5	42	52	M12x1
HSKA100HYDRO16X200	100	16	38	34	50	200	174	147.5	42	52	M12x1
HSKA100HYDRO18X150	100	18	40	36	50	150	124	98	42	52	M12x1
HSKA100HYDRO18X200	100	18	40	36	50	200	174	148	42	52	M12x1
HSKA100HYDRO20X150	100	20	42	38	50	150	124	99	42	52	M12x1
HSKA100HYDRO20X200	100	20	42	38	50	200	174	149	42	52	M12x1
HSKA100HYDRO25X200	100	25	50	46	50	200	174	-	48	58	M16x1
HSKA100HYDRO32X200	100	32	60	56	60	200	174	-	52	62	M16x1

Applicable for 10 MPa coolant
Reduction sleeves are available for d = 12, 20, 25, and 32mm.
Chucking force will reduce when using a reduction sleeve.

Option: Clamping wrench

Reference pages

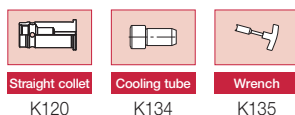

Straight collet

Cooling tube

Wrench

K120

K134

K135



TUNGHOLD

HSK A-EM

Side lock holder for weldon endmills (HSK-A)

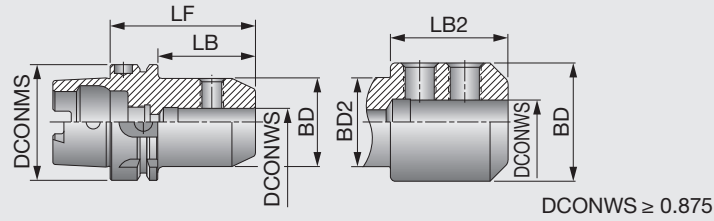

Inch	DCONMS (mm)	DCONWS	BD	BD2	LF	LB	LB2
HSKA50EM3/8X2.562	50	0.375	1.380	-	2.562	1.530	-
HSKA50EM1/2X3.125	50	0.500	1.610	-	3.125	2.100	-
HSKA50EM5/8X3.125	50	0.625	1.752	-	3.125	2.101	-
HSKA50EM3/4X3.125	50	0.750	1.937	-	3.125	2.101	-
HSKA50EM7/8X4.000	50	0.875	2.205	-	4.000	2.976	-
HSKA50EM1X4.250	50	1.000	2.563	-	4.250	3.226	-
HSKA63EM3/16X2.562	63	0.188	0.870	-	2.562	1.530	-
HSKA63EM1/4X2.562	63	0.250	1.000	-	2.562	1.530	-
HSKA63EM3/8X2.562	63	0.375	1.380	-	2.562	1.530	-
HSKA63EM1/2X3.125	63	0.500	1.610	-	3.125	2.100	-
HSKA63EM5/8X3.125	63	0.625	1.750	-	3.125	2.100	-
HSKA63EM3/4X3.150	63	0.750	1.940	-	3.150	2.100	-
HSKA63EM1X4.250	63	1.000	2.560	2.080	4.250	3.220	2.590
HSKA63EM1-1/4X4.250	63	1.250	2.810	2.080	4.250	3.220	2.590
HSKA100EM1/4X3.125	100	0.250	1.100	-	3.125	1.250	-
HSKA100EM3/8X3.125	100	0.375	1.380	-	3.125	1.980	-
HSKA100EM1/2X3.125	100	0.500	1.630	-	3.125	1.980	-
HSKA100EM5/8X4.000	100	0.625	1.750	-	4.000	2.850	-
HSKA100EM3/4X4.000	100	0.750	1.940	-	4.000	2.850	-
HSKA100EM7/8X4.000	100	0.875	2.210	-	4.000	2.850	-
HSKA100EM1X4.000	100	1.000	2.560	-	4.000	2.850	-
HSKA100EM1-1/4X4.000	100	1.250	2.810	-	4.000	2.850	-
HSKA100EM1-1/2X4.000	100	1.500	3.000	-	4.000	2.850	-

A cooling tube must be used with all coolant through HSK spindles (should be ordered separately).
Applicable for 7 MPa pressure coolant.

Reference pages



Wrench
K135



Cooling tube
K134



Clamping screw
K133

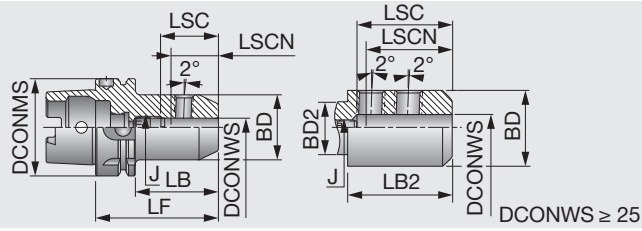

Metric	DCONMS	DCONWS	BD	BD2	LF	LB	LB2	LSCN	LSC	J	Wrench
HSKA63EM6X80E	63	6	25	-	80	54	-	32	40	M5	2
HSKA63EM8X80E	63	8	28	-	80	54	-	35	40	M6	3
HSKA63EM10X80E	63	10	35	-	80	54	-	39	44	M8	4
HSKA63EM12X90E	63	12	42	-	90	64	-	44	49	M10	5
HSKA63EM14X90E	63	14	44	-	90	64	-	44	49	M10	5
HSKA63EM16X100E	63	16	48	-	100	74	-	47	52	M12	6
HSKA63EM18X100E	63	18	50	-	100	74	-	47	55	M12	6
HSKA63EM20X100E	63	20	52	-	100	74	-	49	54	M16	8
HSKA63EM25X110E	63	25	65	52	110	84	65.5	54	61	M16	8
HSKA63EM32X110E	63	32	72	52	110	84	65.5	58	63	M20X1.5	10
HSKA100EM8X90E	100	8	28	-	90	61	-	35	40	M6	3
HSKA100EM12X100E	100	12	42	-	100	71	-	44	54	M10	5
HSKA100EM14X100E	100	14	44	-	100	71	-	44	54	M10	5
HSKA100EM16X100E	100	16	48	-	100	71	-	47	52	M12	6
HSKA100EM18X100E	100	18	50	-	100	71	-	47	52	M12	6
HSKA100EM20X110E	100	20	52	-	110	81	-	49	54	M16	8
HSKA100EM25X120E	100	25	65	-	120	91	-	54	61	M20X1.5	10
HSKA100EM32X120E	100	32	72	-	120	91	-	58	63	M20X1.5	10

Applicable for 7 MPa coolant
The adjustment screw has an internal coolant hole.

Reference pages



Wrench
K135



Cooling tube
K134



Clamping screw
K133

TUNGSHRINK

HSK A-SRKIN

Thermal shrinking holder for carbide and HSS shanks (HSK-A)

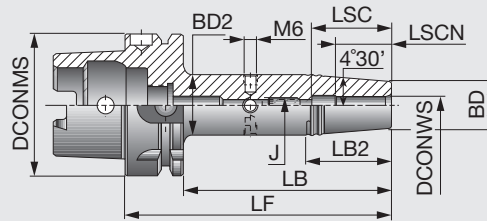

Inch	DCONMS (mm)	DCONWS	BD	BD2	LF	LB	LB2	LSCN	LSC	J	Wrench*
HSKA63SRKIN1/4X3.150	63	0.250	0.827	1.060	3.150	2.126	1.500	0.980	1.420	M5	2.5
HSKA63SRKIN1/4X6.30	63	0.250	0.827	1.060	6.300	5.276	1.500	0.980	1.420	M5	2.5
HSKA63SRKIN5/16X3.150	63	0.313	0.827	1.060	3.150	2.217	1.500	0.980	1.420	M6	3
HSKA63SRKIN3/8X3.346	63	0.375	0.940	1.260	3.346	2.320	2.000	1.220	1.650	M8	4
HSKA63SRKIN3/8X6.30	63	0.375	0.940	1.260	6.300	5.276	2.000	1.220	1.650	M8	4
HSKA63SRKIN7/16X3.543	63	0.437	0.940	1.260	3.543	2.519	2.000	1.420	1.850	M10	5
HSKA63SRKIN1/2X3.543	63	0.500	0.940	1.260	3.543	2.519	2.000	1.420	1.850	M10	5
HSKA63SRKIN5/8X3.740	63	0.625	1.060	1.340	3.740	2.716	1.750	1.540	1.970	M12	6
HSKA63SRKIN5/8X6.30	63	0.625	1.060	1.340	6.300	5.276	1.750	1.540	1.970	M12	6
HSKA63SRKIN3/4X3.937	63	0.750	1.300	1.650	3.937	2.913	2.250	1.610	2.050	M16	8
HSKA63SRKIN3/4X6.30	63	0.750	1.300	1.650	6.300	5.276	2.250	1.610	2.050	M16	8
HSKA63SRKIN7/8X3.937	63	0.875	1.730	2.074	3.937	2.913	2.170	1.610	2.050	M16	8
HSKA63SRKIN1X4.528	63	1.000	1.730	2.074	4.528	3.504	2.170	1.850	2.280	M16	8
HSKA63SRKIN1-1/4X4.72	63	1.250	1.730	2.074	4.725	3.700	2.170	1.850	2.280	M16	8
HSKA100SRKIN1/4X3.500	100	0.250	0.827	1.060	3.500	2.358	1.500	0.980	1.420	M5	2.5
HSKA100SRKIN1/4X6.250	100	0.250	0.827	1.060	6.250	5.108	1.500	0.980	1.420	M5	2.5
HSKA100SRKIN5/16X3.500	100	0.313	0.827	1.060	3.500	2.358	1.500	0.980	1.420	M6	3
HSKA100SRKIN5/16X4.750	100	0.313	0.827	1.060	4.750	3.608	1.500	0.980	1.420	M6	3
HSKA100SRKIN5/16X6.250	100	0.313	0.827	1.060	6.250	5.108	1.500	0.980	1.420	M6	3
HSKA100SRKIN3/8X3.625	100	0.375	0.940	1.260	3.625	2.483	2.000	1.220	1.650	M8	4
HSKA100SRKIN3/8X6.250	100	0.375	0.940	1.260	6.250	5.108	2.000	1.220	1.650	M8	4
HSKA100SRKIN7/16X3.750	100	0.437	0.940	1.260	3.750	2.608	2.000	1.420	1.850	M10	5
HSKA100SRKIN7/16X6.250	100	0.437	0.940	1.260	6.250	5.108	2.000	1.420	1.850	M10	5
HSKA100SRKIN1/2X3.750	100	0.500	0.940	1.260	3.750	2.608	2.000	1.420	1.850	M10	5
HSKA100SRKIN1/2X5.000	100	0.500	0.940	1.260	5.000	3.858	2.000	1.420	1.850	M10	5
HSKA100SRKIN5/8X4.000	100	0.625	1.060	1.340	4.000	2.858	1.750	1.540	1.970	M12	6
HSKA100SRKIN5/8X5.000	100	0.625	1.060	1.340	5.000	3.858	1.750	1.540	1.970	M12	6
HSKA100SRKIN3/4X4.125	100	0.750	1.300	1.654	4.125	3.102	2.250	1.610	2.050	M12	6
HSKA100SRKIN3/4X6.250	100	0.750	1.300	1.650	6.250	5.108	2.250	1.610	2.050	M16	8
HSKA100SRKIN7/8X4.125	100	0.875	1.730	2.090	4.125	2.983	2.250	1.610	2.050	M12	6
HSKA100SRKIN1X4.500	100	1.000	1.730	2.090	4.500	3.358	2.250	1.850	2.280	M12	6
HSKA100SRKIN1-1/4X4.75	100	1.250	1.730	2.090	4.750	3.608	2.250	1.850	2.280	M12	6

* Wrench (metric size) for the rear stopper screw.

When using an HSK type holder with the capability of internal coolant supply, be sure to use a cooling tube (sold separately).

Please use an induction heating unit for SRKIN holder

Applicable for 10 MPa coolant

Reference pages



Induction heating unit
K125



Heating unit
K125



Preset screw
K133



Wrench
K135



Cooling tube
K134

Metric	DCONMS	DCONWS	BD	BD2	LF	LB	LB2	LSCN	LSC	J	Wrench
HSKA63SRKIN6X80	63	6	21	27	80	54	38	25	36	M5	2.5
HSKA63SRKIN6X120	63	6	21	27	120	94	38	25	36	M5	2.5
HSKA63SRKIN6X160	63	6	21	27	160	134	38	25	36	M5	2.5
HSKA63SRKIN8X80	63	8	21	27	80	54	38	25	36	M6	3
HSKA63SRKIN8X120	63	8	21	27	120	94	38	25	36	M6	3
HSKA63SRKIN8X160	63	8	21	27	160	134	38	25	36	M6	3
HSKA63SRKIN10X85	63	10	24	32	85	59	51	31	42	M8	4
HSKA63SRKIN10X120	63	10	24	32	120	94	51	31	42	M8	4
HSKA63SRKIN10X160	63	10	24	32	160	134	51	31	42	M8	4
HSKA63SRKIN12X90	63	12	24	32	90	64	51	36	42	M8	4
HSKA63SRKIN12X120	63	12	24	32	120	94	51	36	47	M10	5
HSKA63SRKIN12X160	63	12	24	32	160	134	51	36	47	M10	5
HSKA63SRKIN14X90	63	14	27	34	90	64	45	36	47	M10	5
HSKA63SRKIN14X120	63	14	27	34	120	94	45	36	47	M10	5
HSKA63SRKIN14X160	63	14	27	34	160	134	45	36	47	M10	5
HSKA63SRKIN16X75	63	16	27	34	75	49	-	39	50	-	-
HSKA63SRKIN16X95	63	16	27	34	95	69	44	39	50	M12	6
HSKA63SRKIN16X120	63	16	27	34	120	94	44	39	50	M12	6
HSKA63SRKIN16X160	63	16	27	34	160	134	44	39	50	M12	6
HSKA63SRKIN18X95	63	18	33	42	95	69	57	39	50	M12	6
HSKA63SRKIN18X120	63	18	33	42	120	94	57	39	50	M12	6
HSKA63SRKIN18X160	63	18	33	42	160	134	57	39	50	M12	6
HSKA63SRKIN20X75	63	20	33	41	75	49	-	41	50	-	-
HSKA63SRKIN20X100	63	20	33	42	100	74	57	41	52	M16	8
HSKA63SRKIN20X120	63	20	33	42	120	94	57	41	52	M16	8
HSKA63SRKIN20X160	63	20	33	42	160	134	57	41	52	M16	8
HSKA63SRKIN25X85	63	25	44	53	85	59	-	47	58	-	-
HSKA63SRKIN25X115	63	25	44	53	115	89	55	47	58	M16	8
HSKA63SRKIN32X85	63	32	44	53	85	59	-	47	58	-	-
HSKA63SRKIN32X120	63	32	44	53	120	94	55	47	58	M16	8
HSKA100SRKIN6X85	100	6	21	27	85	56	38	25	36	M5	2.5
HSKA100SRKIN6X120	100	6	21	27	120	91	38	25	36	M5	2.5
HSKA100SRKIN6X160	100	6	21	27	160	131	38	25	36	M6	3
HSKA100SRKIN8X85	100	8	21	27	85	56	38	25	36	M6	3
HSKA100SRKIN8X120	100	8	21	27	120	91	38	25	36	M6	3
HSKA100SRKIN8X160	100	8	21	27	160	131	38	25	36	M6	3
HSKA100SRKIN10X90	100	10	24	32	90	61	51	31	42	M8	4
HSKA100SRKIN10X120	100	10	24	32	120	91	51	31	42	M8	4
HSKA100SRKIN10X160	100	10	24	32	160	131	51	31	42	M8	4
HSKA100SRKIN12X95	100	12	24	32	95	66	51	36	47	M10	5
HSKA100SRKIN12X120	100	12	24	32	120	91	51	36	47	M10	5
HSKA100SRKIN12X160	100	12	24	32	160	131	51	36	47	M10	5
HSKA100SRKIN14X95	100	14	27	34	95	66	45	36	47	M10	5
HSKA100SRKIN14X120	100	14	27	34	120	91	45	36	47	M10	5
HSKA100SRKIN14X160	100	14	27	34	160	131	45	36	47	M10	5
HSKA100SRKIN16X100	100	16	27	34	100	71	45	39	50	M12	6
HSKA100SRKIN16X120	100	16	27	34	120	91	45	39	50	M12	6
HSKA100SRKIN16X160	100	16	27	34	160	131	45	39	50	M12	6
HSKA100SRKIN18X100	100	18	33	42	100	71	57	39	50	M12	6
HSKA100SRKIN18X160	100	18	33	42	160	131	57	39	50	M12	6
HSKA100SRKIN20X105	100	20	33	42	105	76	57	41	52	M16	8
HSKA100SRKIN20X160	100	20	33	42	160	131	57	41	52	M16	8
HSKA100SRKIN25X115	100	25	44	53	115	86	57	47	58	M16	8
HSKA100SRKIN32X120	100	32	44	53	120	91	57	47	58	M16	8

When using an HSK type holder with the capability of internal coolant supply, be sure to use a cooling tube (sold separately). Please use an induction heating unit for SRKIN holder
 Applicable for 10 MPa coolant

Reference pages

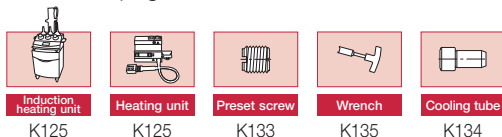

TUNGSHRINK

HSK FM-SRKIN

Thermal shrinking holder for carbide and HSS shanks (DIN69871)

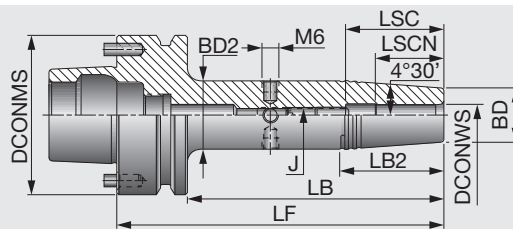

Inch	DCONMS (mm)	DCONWS	BD	BD2	LF	LB	LB2	LSCN	LSC	J	Wrench*
HSKFM63SRKIN1/4X3.13	63	0.250	0.827	1.063	3.130	2.106	1.500	0.980	1.420	M5	2.5
HSKFM63SRKIN5/16X3.13	63	0.313	0.827	1.063	3.130	2.106	1.500	0.980	1.420	M6	3
HSKFM63SRKIN3/8X3.50	63	0.375	0.945	1.260	3.500	2.476	2.000	1.220	1.650	M8	4
HSKFM63SRKIN1/2X3.50	63	0.500	0.945	1.260	3.500	2.476	2.000	1.420	1.850	M8	4
HSKFM63SRKIN5/8X3.50	63	0.625	1.063	1.339	3.500	2.476	1.752	1.540	1.970	M8	4
HSKFM63SRKIN3/4X3.00	63	0.750	1.299	1.610	3.000	2.976	-	1.610	2.050	-	-
HSKFM63SRKIN3/4X3.75	63	0.750	1.299	1.654	3.750	2.726	2.250	1.610	2.050	M12	6
HSKFM63SRKIN1X3.00	63	1.000	1.732	2.075	3.000	2.976	-	1.850	2.130	-	-
HSKFM63SRKIN1X4.00	63	1.000	1.732	2.075	4.000	2.976	2.252	1.850	2.280	M16	8
HSKFM80SRKIN1/4X3.25	80	0.250	0.827	1.063	3.250	2.226	1.500	0.960	1.420	M5	2.5
HSKFM80SRKIN3/8X3.25	80	0.375	0.945	1.260	3.250	2.226	2.000	1.200	1.650	M8	4
HSKFM80SRKIN1/2X3.25	80	0.500	0.945	1.260	3.250	2.226	2.000	1.400	1.850	M10	5
HSKFM80SRKIN5/8X3.25	80	0.625	1.063	1.340	3.250	2.266	1.752	1.510	1.970	M12	6
HSKFM80SRKIN1X3.50	80	1.000	1.732	2.075	3.500	2.476	2.252	1.830	2.280	M16	8

* Wrench (metric size) for the rear stopper screw.

When using an HSK type holder with the capability of internal coolant supply, be sure to use a cooling tube (sold separately)

Please use an induction heating unit for SRKIN holder

The driving pins can be removed, turning the toolholder into a standard HSK F63 type.

Applicable for 10 MPa coolant

Metric	DCONMS	DCONWS	BD	BD2	LF	LB	LB2	LSCN	LSC	J	Wrench
HSKFM63SRKIN25X115	63	25	44	52.7	115	89	55	47	58	M16	8

When using an HSK type holder with the capability of internal coolant supply, be sure to use a cooling tube (sold separately)

Please use an induction heating unit for SRKIN holder

The driving pins can be removed, turning the toolholder into a standard HSK F63 type.

Applicable for 10 MPa coolant

Reference pages



Induction heating unit
K125



Heating unit
K125



Preset screw
K133



Wrench
K135



Cooling tube
K134

MEMO

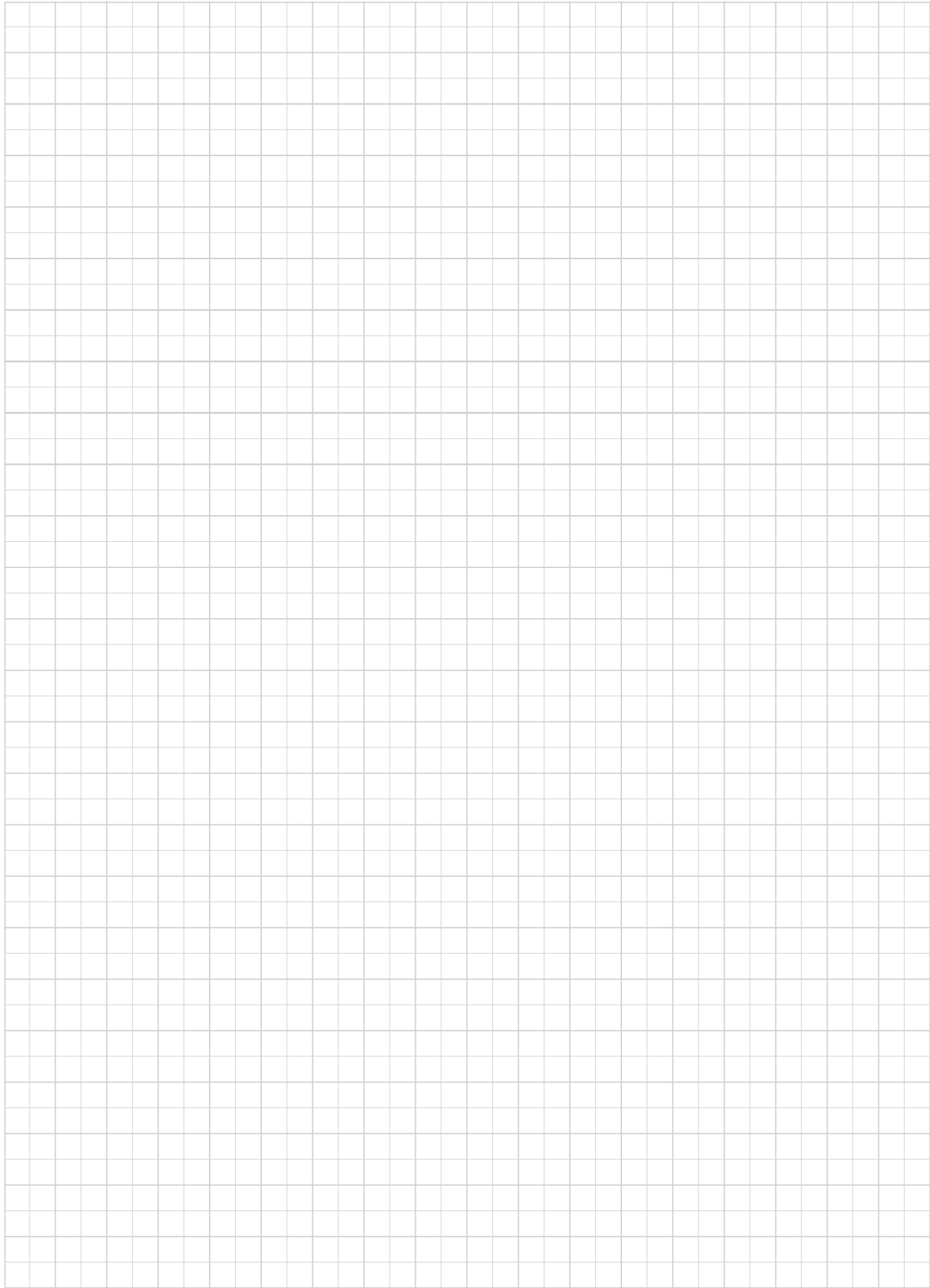

Grade	A
Insert	B
Ext. Toolholder	C
Int. Toolholder	D
Threading	E
Grooving	F
Miniature Tool	G
Milling Cutter	H
Endmill	I
Drilling Tool	J
Tooling System	K
User's Guide	L
Index	M

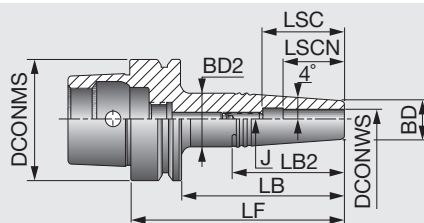

Inch	DCONMS (mm)	DCONWS	BD	BD2	LF	LB	LB2	LSCN	LSC	J	Wrench*
HSKE32SRK1/8X2.000	32	0.125	0.394	0.591	2.787	2.000	1.407	0.390	0.790	M4	2
HSKE32SRK3/16X2.000	32	0.187	0.394	0.591	2.787	2.000	1.407	0.590	0.980	M4	2
HSKE32SRK1/4X2.000	32	0.250	0.433	0.630	2.787	2.000	1.406	0.710	1.100	M4	2
HSKE32SRK5/16X2.000	32	0.312	0.551	0.787	2.787	2.000	1.406	0.980	1.380	M4	2
HSKE32SRK3/8X2.000	32	0.375	0.630	0.866	2.787	2.000	1.677	1.180	1.580	M4	2
HSKE32SRK1/2X2.000	32	0.500	0.787	0.984	2.787	2.000	1.392	1.260	1.580	M4	2
HSKE40SRK1/8X1.750	40	0.125	0.390	0.590	2.537	1.750	1.400	0.390	0.630	M5	2.5
HSKE40SRK1/8X3.000	40	0.125	0.390	0.748	3.787	3.000	2.526	0.390	0.630	M5	2.5
HSKE40SRK3/16X1.750	40	0.187	0.390	0.590	2.537	1.750	1.400	0.590	0.980	M4	2
HSKE40SRK3/16X3.000	40	0.187	0.390	0.748	3.787	3.000	2.526	0.590	0.980	M4	2
HSKE40SRK1/4X1.750	40	0.250	0.430	0.630	2.537	1.750	1.400	0.710	1.100	M5	2.5
HSKE40SRK1/4X3.000	40	0.250	0.430	0.787	3.787	3.000	2.524	0.710	1.100	M5	2.5
HSKE40SRK5/16X1.750	40	0.312	0.550	0.550	2.537	1.750	1.637	0.980	1.380	M5	2.5
HSKE40SRK5/16X3.000	40	0.312	0.550	0.905	3.787	3.000	2.518	0.980	1.380	M6	3
HSKE40SRK3/8X1.750	40	0.375	0.630	0.866	2.537	1.750	1.670	1.180	1.580	M5	2.5
HSKE40SRK3/8X3.000	40	0.375	0.630	0.965	3.787	3.000	2.373	1.180	1.580	M8	4
HSKE40SRK7/16X1.750	40	0.437	0.790	1.024	2.537	1.750	1.665	1.220	1.610	M5	2.5
HSKE40SRK7/16X3.000	40	0.437	0.790	1.102	3.787	3.000	2.229	1.220	1.610	M10	3
HSKE40SRK1/2X1.750	40	0.500	0.790	1.024	2.537	1.750	1.665	1.260	1.650	M5	2.5
HSKE40SRK1/2X3.000	40	0.500	0.790	1.102	3.787	3.000	2.229	1.260	1.650	M10	5
HSKE50SRK1/8X1.750	50	0.125	0.390	0.590	2.774	1.750	1.400	0.390	0.630	M5	2.5
HSKE50SRK1/8X3.000	50	0.125	0.390	0.748	4.024	3.000	2.526	0.390	0.630	M5	2.5
HSKE50SRK3/16X1.750	50	0.187	0.390	0.590	2.774	1.750	1.400	0.590	0.830	M6	3
HSKE50SRK3/16X3.000	50	0.187	0.390	0.748	4.024	3.000	2.526	0.590	0.830	M6	3
HSKE50SRK1/4X1.750	50	0.250	0.430	0.630	2.774	1.750	1.400	0.710	1.100	M5	2.5
HSKE50SRK1/4X3.000	50	0.250	0.430	0.787	4.024	3.000	2.524	0.710	1.100	M5	2.5
HSKE50SRK5/16X1.750	50	0.312	0.550	0.787	2.774	1.750	1.673	0.980	1.380	M6	3
HSKE50SRK5/16X3.000	50	0.312	0.550	0.905	4.024	3.000	2.518	0.980	1.380	M6	3
HSKE50SRK3/8X1.750	50	0.375	0.630	0.866	2.774	1.750	1.670	1.180	1.580	M6	3
HSKE50SRK3/8X3.000	50	0.375	0.630	0.965	4.024	3.000	2.373	1.180	1.580	M8	4
HSKE50SRK7/16X1.750	50	0.437	0.790	1.024	2.774	1.750	1.665	1.220	1.610	M6	3
HSKE50SRK1/2X1.750	50	0.500	0.790	1.024	2.774	1.750	1.665	1.260	1.650	M6	3
HSKE50SRK1/2X3.000	50	0.500	0.790	1.102	4.024	3.000	2.229	1.260	1.650	M10	5
HSKE63SRK1/8X2.000	63	0.125	0.390	0.669	3.024	2.000	1.927	0.390	0.630	M6	3
HSKE63SRK3/16X2.000	63	0.187	0.390	0.669	3.024	2.000	1.927	0.590	0.830	M6	3
HSKE63SRK3/16X3.000	63	0.187	0.390	0.748	4.024	3.000	2.526	0.590	0.830	M6	3
HSKE63SRK1/4X2.000	63	0.250	0.430	0.709	3.024	2.000	1.927	0.710	0.950	M8	4
HSKE63SRK1/4X3.000	63	0.250	0.430	0.787	4.024	3.000	2.524	0.710	0.950	M8	4
HSKE63SRK5/16X2.000	63	0.312	0.550	0.827	3.024	2.000	1.927	0.980	1.380	M6	3
HSKE63SRK5/16X3.000	63	0.312	0.550	0.905	4.024	3.000	2.518	0.980	1.380	M6	3
HSKE63SRK3/8X2.000	63	0.375	0.630	0.906	3.024	2.000	1.927	1.180	1.580	M8	4
HSKE63SRK3/8X3.000	63	0.375	0.630	1.000	4.024	3.000	2.373	1.180	1.580	M8	4
HSKE63SRK7/16X2.000	63	0.437	0.790	1.063	3.024	2.000	1.927	1.220	1.610	M8	4
HSKE63SRK7/16X3.000	63	0.437	0.790	1.102	4.024	3.000	2.229	1.220	1.610	M10	5
HSKE63SRK1/2X2.000	63	0.500	0.790	1.063	3.024	2.000	1.927	1.260	1.650	M8	4

* Wrench (metric size) for the rear stopper screw.

(1) Balanced to G2.5 max.n.: 35,000 min⁻¹

When using an HSK type holder with the capability of internal coolant supply, be sure to use a cooling tube (sold separately).

Applicable for 10 MPa coolant

Reference pages



Induction heating unit
K125



Heating unit
K125



Preset screw
K133



Wrench
K135



Cooling tube
K134

Metric	DCONMS	DCONWS	BD	BD2	LF	LB	LB2	LSCN	LSC	J	Wrench
HSKE32SRK3X45	32	3	10	13	65	45	30	10	16	M4	2
HSKE32SRK4X45	32	4	10	15	65	45	35	12	18	M4	2
HSKE32SRK6X45	32	6	11	16	65	45	35	18	28	M4	2
HSKE32SRK10X45	32	10	16	22	65	45	42	30	40	M4	2
HSKE40SRK3X45	40	3	10	13	65	45	30	10	16	M5	2.5
HSKE40SRK3X80	40	3	10	19	100	80	64	10	16	M5	2.5
HSKE40SRK4X45	40	4	10	15	65	45	35	12	18	M5	2.5
HSKE40SRK4X80	40	4	10	19	100	80	64	12	18	M5	2.5
HSKE40SRK5X45	40	5	10	15	65	45	35	15	25	M4	2
HSKE40SRK5X80	40	5	10	19	100	80	64	15	25	M4	2
HSKE40SRK6X45	40	6	11	16	65	45	35	18	28	M5	2.5
HSKE40SRK6X80	40	6	11	20	100	80	64	18	28	M5	2.5
HSKE40SRK8X45	40	8	14	20	65	45	42	25	35	M5	2.5
HSKE40SRK8X80	40	8	14	23	100	80	64	25	35	M6	3
HSKE40SRK10X45	40	10	16	22	65	45	42	30	40	M5	2.5
HSKE40SRK10X80	40	10	16	24.5	100	80	60	30	40	M8	4
HSKE40SRK12X45	40	12	20	26	65	45	42	32	42	M5	2.5
HSKE40SRK12X80	40	12	20	28	100	80	56	32	42	M10	5
HSKE50SRK3X45 ⁽¹⁾	50	3	10	15	71	45	36	10	16	M5	2.5
HSKE50SRK3X80 ⁽¹⁾	50	3	10	19	106	80	64	10	16	M5	2.5
HSKE50SRK4X45 ⁽¹⁾	50	4	10	15	71	45	36	12	18	M5	2.5
HSKE50SRK4X80 ⁽¹⁾	50	4	10	19	106	80	64	12	18	M5	2.5
HSKE50SRK6X45 ⁽¹⁾	50	6	11	16	71	45	36	18	28	M5	2.5
HSKE50SRK6X80 ⁽¹⁾	50	6	11	20	106	80	64	18	28	M5	2.5
HSKE50SRK8X45 ⁽¹⁾	50	8	14	20	71	45	43	25	35	M6	3
HSKE50SRK8X80 ⁽¹⁾	50	8	14	23	106	80	64	25	35	M6	3
HSKE50SRK10X45 ⁽¹⁾	50	10	16	22	71	45	42	30	37	M6	3
HSKE50SRK10X80 ⁽¹⁾	50	10	16	24.5	106	80	60	30	40	M8	4
HSKE50SRK12X45 ⁽¹⁾	50	12	20	26	71	45	42	32	39	M6	3

(1) Balanced to G2.5 max.n: 35,000 min⁻¹
 When using an HSK type holder with the capability of internal coolant supply, be sure to use a cooling tube (sold separately).
 Applicable for 10 MPa coolant

Reference pages

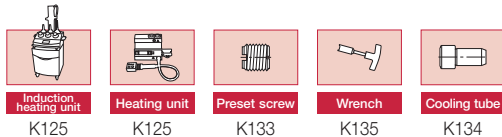

TUNGSHRINK

HSK A-SRK

Thermal shrinking holder for carbide shank (HSK-A)

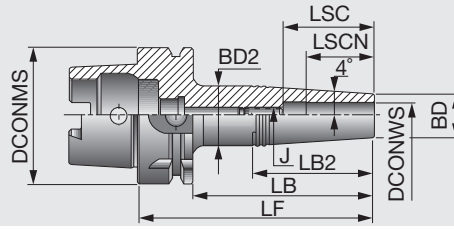

Inch	DCONMS (mm)	DCONWS	BD	BD2	LF	LB	LB2	LSCN	LSC	J	Wrench*
HSKA63SRK1/8X2.000	63	0.125	0.390	0.699	3.024	2.000	-	0.390	0.630	M6	3
HSKA63SRK1/8X3.250	63	0.125	0.390	0.823	4.274	3.250	3.098	0.390	0.630	M6	3
HSKA63SRK3/16X2.000	63	0.187	0.390	0.699	3.024	2.000	-	0.590	0.830	M6	3
HSKA63SRK3/16X3.250	63	0.187	0.390	0.823	4.274	3.250	3.098	0.590	0.830	M6	3
HSKA63SRK1/4X2.000	63	0.250	0.430	0.699	3.024	2.000	-	0.590	0.950	M8	4
HSKA63SRK1/4X3.250	63	0.250	0.430	0.866	4.274	3.250	3.098	0.710	0.950	M8	4
HSKA63SRK5/16X3.250	63	0.312	0.550	0.906	4.274	3.250	3.098	0.980	1.420	M6	3
HSKA63SRK3/8X2.000	63	0.375	0.630	0.787	3.024	2.000	1.693	1.180	1.610	M8	4
HSKA63SRK3/8X3.250	63	0.375	0.630	1.024	4.274	3.250	2.535	1.180	1.610	M8	4
HSKA63SRK7/16X2.000	63	0.437	0.790	1.067	3.024	2.000	-	1.220	1.650	M8	4
HSKA63SRK7/16X3.250	63	0.437	0.790	1.181	4.274	3.250	2.815	1.220	1.650	M10	5
HSKA63SRK1/2X2.000	63	0.500	0.790	1.063	3.024	2.000	-	1.260	1.690	M8	4
HSKA63SRK1/2X3.250	63	0.500	0.790	1.181	4.274	3.250	2.815	1.260	1.690	M10	5

* Wrench (metric size) for the rear stopper screw.

Applicable for 10 MPa coolant

When using an HSK type holder with the capability of internal coolant supply, be sure to use a cooling tube (sold separately).

Metric	DCONMS	DCONWS	BD	BD2	LF	LB	LB2	LSCN	LSC	J	Wrench
HSKA63SRK3X50	63	3	10	17	76	50	-	10	16	M6	3
HSKA63SRK3X85	63	3	10	21	111	85	79	10	16	M6	3
HSKA63SRK4X50	63	4	10	17	76	50	-	12	18	M6	3
HSKA63SRK4X85	63	4	10	21	111	85	79	12	18	M6	3
HSKA63SRK5X50	63	5	10	17	76	50	-	15	21	M6	3
HSKA63SRK5X85	63	5	10	21	111	85	79	15	21	M6	3
HSKA63SRK6X50	63	6	11	18	76	50	-	18	24	M8	4
HSKA63SRK6X85	63	6	11	22	111	85	79	18	24	M8	4
HSKA63SRK8X50	63	8	14	20	76	50	43	25	36	M6	3
HSKA63SRK8X85	63	8	14	23	111	85	64	25	36	M6	3
HSKA63SRK10X50	63	10	16	23	76	50	-	30	41	M8	4
HSKA63SRK10X85	63	10	16	26	111	85	72	30	41	M8	4
HSKA63SRK12X50	63	12	20	27	76	50	-	32	43	M8	4
HSKA63SRK12X85	63	12	20	30	111	85	72	32	43	M8	4

Applicable for 10 MPa coolant

When using an HSK type holder with the capability of internal coolant supply, be sure to use a cooling tube (sold separately).

Reference pages

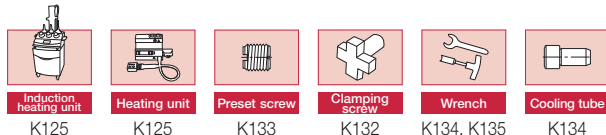

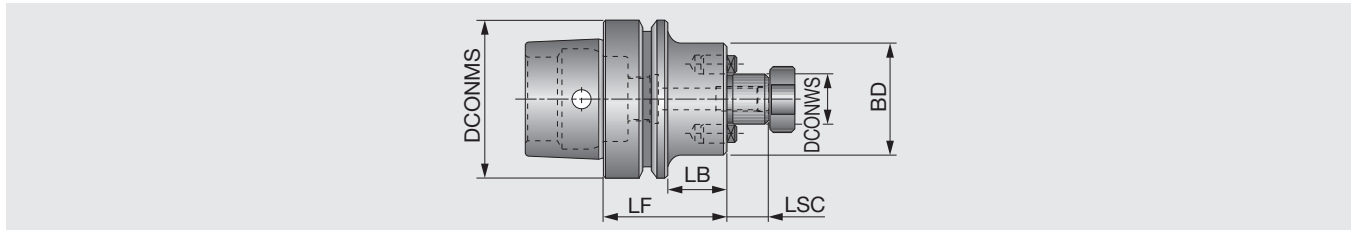





Inch	DCONMS (mm)	DCONWS	LSC	BD	LF	LB
HSKE40SEM3/4X2.000	40	0.750	0.669	1.771	2.000	1.213
HSKE63SEM1X2.375	63	1.000	0.669	2.079	2.375	1.351

Applicable for 7 MPa coolant

When using an HSK type holder with the capability of internal coolant supply, be sure to use a cooling tube (sold separately).

Option: Wrench for center bolt

Reference pages

			
Preset screw	Clamping screw	Wrench	Cooling tube
K133	K132	K134, K135	K134

Grade
Insert
Toolholder
Ext. Toolholder
Int. Toolholder
Threading
Grooving
Miniature Tool
Milling Cutter
Endmill
Drilling Tool
Tooling System
User's Guide
Index



TUNGHOLD

HSK A-SEM

Shell mill holder (HSK-A)

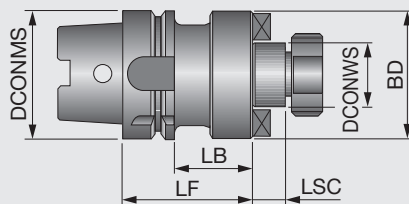

Inch	DCONMS (mm)	DCONWS	LSC	BD	LF	LB
HSKA50SEM3/4X2.375*	50	0.750	0.669	1.770	2.375	1.351
HSKA63SEM3/4X2.375	63	0.750	0.669	1.770	2.375	1.351
HSKA63SEM1X1.750	63	1.000	0.669	2.086	1.750	0.726
HSKA63SEM1X4.000	63	1.000	0.669	2.086	4.000	2.984
HSKA63SEM1-1/4X2.375	63	1.250	0.669	2.510	2.375	1.351
HSKA63SEM1-1/2X2.375	63	1.500	0.940	3.070	2.375	1.351
HSKA100SEM3/4X3.000	100	0.750	0.669	1.770	3.000	1.858
HSKA100SEM1X2.375	100	1.000	0.669	2.165	2.375	1.233
HSKA100SEM1-1/4X1.875	100	1.250	0.669	2.500	1.875	0.733
HSKA100SEM1-1/2X1.875	100	1.500	0.940	3.071	1.875	0.733
HSKA100SEM2X2.375	100	2.000	0.940	3.881	2.375	1.233

* Requires a price and delivery time quotation.

Applicable for 7 MPa coolant

When using an HSK type holder with the capability of internal coolant supply, be sure to use a cooling tube (sold separately)

Option: Wrench for lock screw

Metric	DCONMS	DCONWS	LSC	BD	LF	LB
HSKA63SEM16X50	63	16	24	38	50	17
HSKA63SEM22X50	63	22	24	47	50	19
HSKA63SEM27X60	63	27	34	58	60	21
HSKA63SEM32X60	63	32	34	66	60	24
HSKA63SEM40X60	63	40	34	82	60	27
HSKA100SEM22X50 ⁽¹⁾	100	22	21	47	50	19
HSKA100SEM27X50 ⁽¹⁾	100	27	21	58	50	21
HSKA100SEM32X50 ⁽¹⁾	100	32	21	66	50	24
HSKA100SEM40X60 ⁽¹⁾	100	40	31	82	60	27
HSKA100SEM50X70 ⁽¹⁾	100	50	41	95	70	30

(1) Balanced to G6.3 max.n: 12,000 min⁻¹

Applicable for 7 MPa coolant

When using an HSK type holder with the capability of internal coolant supply, be sure to use a cooling tube (sold separately)

Option: Wrench for lock screw

Reference pages



Clamping screw

K132



Wrench

K134



Wrench

K135



Cooling tube

K134

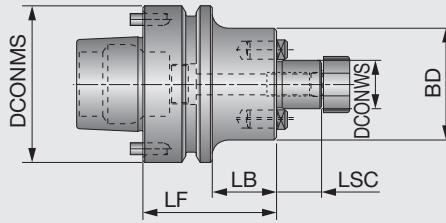

Inch	DCONMS (mm)	DCONWS	LSC	BD	LF	LB
HSKFM63SEM3/4X3.00	63	0.750	0.669	1.772	3.000	1.976
HSKFM63SEM3/4X4.50	63	0.750	0.669	1.772	4.500	3.476
HSKFM63SEM1X2.375	63	1.000	0.669	2.079	2.375	1.351
HSKFM80SEM3/4X2.00	80	0.750	0.669	1.772	2.000	0.976
HSKFM80SEM3/4X4.00	80	0.750	0.669	1.772	4.000	2.976
HSKFM80SEM1X2.00	80	1.000	0.669	2.165	2.000	0.976
HSKFM80SEM1X4.00	80	1.000	0.669	2.165	4.000	2.976

Applicable for 7 MPa coolant

The specification is based on HSK63F type.

This item improves torque transmission with two drive pins.

When using an HSK type holder with the capability of internal coolant supply, be sure to use a cooling tube (sold separately).

Option: Wrench for lock screw

Metric	DCONMS	DCONWS	LSC	BD	LF	LB
HSKFM63SEM22X60	63	22	19	47	60	34
HSKFM63SEM32X60	63	32	24	66	60	34
HSKFM63SEM3/4X3.00	63	19.05	17	45	76.2	50.2
HSKFM63SEM3/4X4.50	63	19.05	17	45	114.3	88.3
HSKFM63SEM1X2.375	63	25.4	17	52.8	60.3	34.3

Applicable for 7 MPa coolant

The specification is based on HSK63F type.

This item improves torque transmission with two drive pins.

When using an HSK type holder with the capability of internal coolant supply, be sure to use a cooling tube (sold separately).

Option: Wrench for lock screw

Reference pages

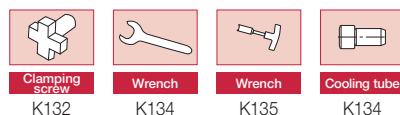

TUNGHOLD**HSK A-FM**

Face mill holder (HSK-A)

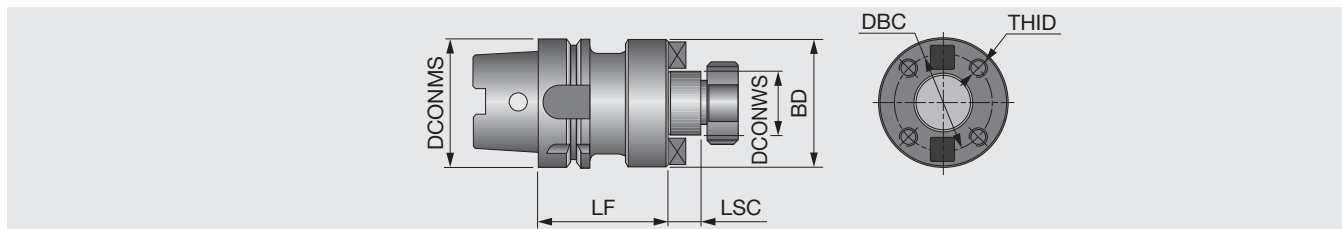

Inch	DCONMS (mm)	DCONWS	LSC	BD	LF	DBC	THID
HSKA100FM2-1/2X2.875	100	2.500	1.122	4.881	2.875	4.000	5/8-11

Option: Wrench for lock screw

TUNGHOLD**HSK A-SEMC**

Combination holder for slot mill and shell mill (HSK-A)

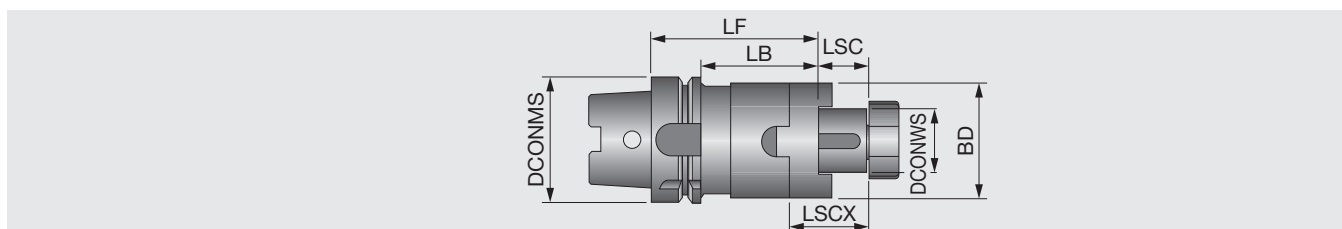

Metric	DCONMS	DCONWS	LSC	BD	LF	LB	LSCX
HSKA63SEMC16X60	63	16	17	32	60	34	21
HSKA63SEMC22X60	63	22	19	40	60	34	31
HSKA63SEMC27X60	63	27	21	48	60	34	33
HSKA63SEMC32X60	63	32	24	58	60	34	38
HSKA63SEMC40X70	63	40	27	70	70	44	41
HSKA100SEMC16X60	100	16	17	32	60	31	27
HSKA100SEMC22X60	100	22	19	40	60	31	31
HSKA100SEMC27X60	100	27	21	48	60	31	33
HSKA100SEMC32X60	100	32	24	58	60	31	38
HSKA100SEMC40X70	100	40	27	70	70	41	41
HSKA100SEMC50X80	100	50	30	90	80	51	46

Applicable for 7 MPa coolant

Option: Wrench for lock screw

Reference pages

Clamping
screw

K132



Wrench

K134



Wrench

K135



Cooling tube

K134

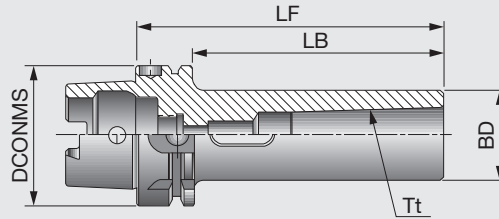

Metric	DCONMS	Tt	LF	BD	LB
HSKA63MT1X110	63	MT1	110	25	84
HSKA63MT2X120	63	MT2	120	32	94
HSKA63MT3X140	63	MT3	140	40	114
HSKA63MT4X160	63	MT4	160	48	134
HSKA100MT1X110	100	MT1	110	25	81
HSKA100MT2X120	100	MT2	120	32	91
HSKA100MT3X150	100	MT3	150	40	121
HSKA100MT4X170	100	MT4	170	48	141
HSKA100MT5X200	100	MT5	200	63	171

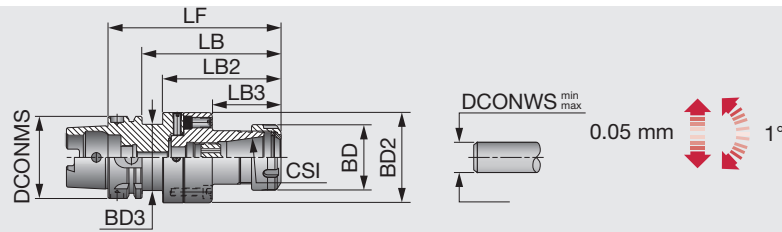

Metric	DCONMS	CSI	Range	LF	LB	LB2	LB3	BD	BD2	BD3
ADJHSKA63D70ER32	63	ER32	2-20	134.5	108.5	82.5	52.5	50	70	46
ADJHSKA100D70ER32	100	ER32	2-20	129.5	108.5	-	52.5	50	70	-

Applicable for 10 MPa coolant

Option: Wrench for ER collet

Reference pages



TUNGCLICK**HSK A-CLICKIN**

Quick change holder (HSK-A)

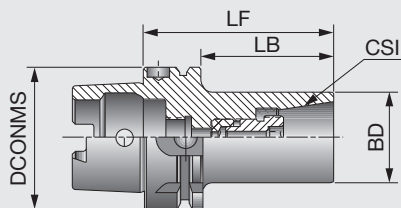

Metric	DCONMS	CSI	BD	LF	LB
HSKA63ER32CLICK-IN	63	32SRF	41	85	59

Applicable for 10 MPa coolant
Clamping torque: 235 N·m

TUNGFIT**HSK A-CF**

Quick change holder (HSK-A)

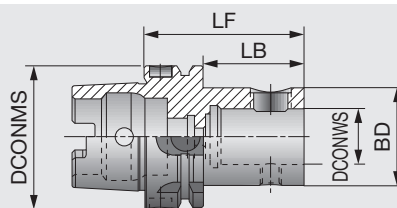

Metric	DCONMS	DCONWS	BD	LF	LB
HSKA63CF4-S	63	25	44.5	70	44
HSKA80CF4-S	80	25	44.5	73	47
HSKA100CF4-S	100	25	44.5	76	47

Applicable for 7 MPa coolant
Clamping torque: 58.8 N·m

Reference pages



Wrench

K135



Cooling tube

K134

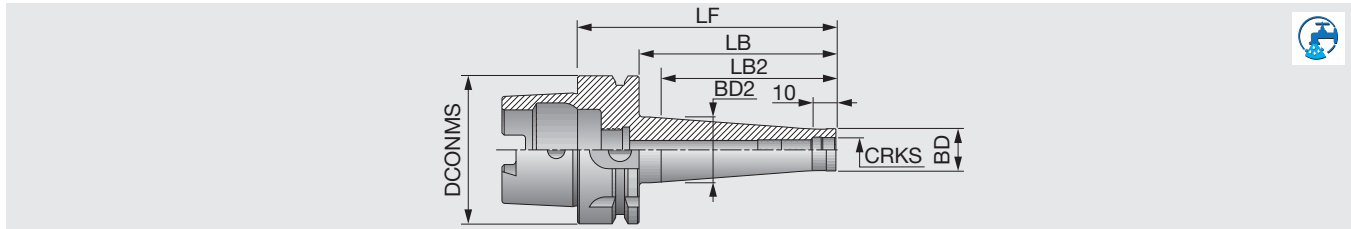

Metric	DCONMS	CRKS	BD	BD2	LF	LB	LB2
HSKA63ODP6X59	63	M6	9.7	10	59	33	25
HSKA63ODP6X109	63	M6	9.8	23	109	83	75
HSKA63ODP8X59	63	M8	13.1	15	59	33	25
HSKA63ODP8X109	63	M8	13.1	23	109	83	75
HSKA63ODP10X59	63	M10	18	20	59	33	25
HSKA63ODP10X109	63	M10	18	28	109	83	75
HSKA63ODP12X59	63	M12	21	24	59	33	25
HSKA63ODP12X109	63	M12	21	31	109	83	75
HSKA63ODP16X59	63	M16	29	34	59	33	25
HSKA63ODP16X109	63	M16	29	34	109	83	75
HSKA100ODP12X87 ⁽¹⁾	100	M12	23	30	87	58	50
HSKA100ODP12X137 ⁽¹⁾	100	M12	23	30	137	108	100
HSKA100ODP12X187 ⁽¹⁾	100	M12	23	40	187	158	150
HSKA100ODP12X237 ⁽¹⁾	100	M12	23	46	237	208	200
HSKA100ODP16X87 ⁽¹⁾	100	M16	29	31.5	87	58	50
HSKA100ODP16X137 ⁽¹⁾	100	M16	29	41.5	137	108	100
HSKA100ODP16X187 ⁽¹⁾	100	M16	29	55	187	158	150
HSKA100ODP16X237 ⁽¹⁾	100	M16	29	55	237	208	200

Applicable for 10 MPa coolant (1) Balanced to G6.5 max.n:12,000 min⁻¹

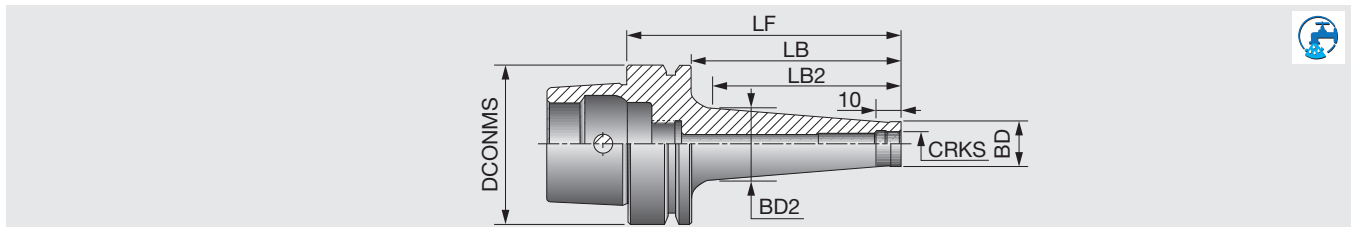

Metric	DCONMS	CRKS	BD	BD2	LF	LB	LB2
HSKE40ODP10X53	40	M10	18	20	53	33	25
HSKE40ODP10X103	40	M10	18	28	103	83	75
HSKE40ODP12X53	40	M12	21	24	53	33	25
HSKE40ODP12X103	40	M12	21	31	103	83	75
HSKE50ODP10X59 ⁽¹⁾	50	M10	18	20	59	33	25
HSKE50ODP10X109 ⁽¹⁾	50	M10	18	28	109	83	75
HSKE50ODP12X59 ⁽¹⁾	50	M12	21	24	59	33	25
HSKE50ODP16X59 ⁽¹⁾	50	M16	29	34	59	33	25
HSKE50ODP16X109 ⁽¹⁾	50	M16	29	34	109	83	75
HSKE63ODP10X59 ⁽²⁾	63	M10	18	20	59	33	25
HSKE63ODP10X109 ⁽²⁾	63	M10	18	28	109	83	75
HSKE63ODP12X59 ⁽²⁾	63	M12	21	24	59	33	25
HSKE63ODP12X109 ⁽²⁾	63	M12	21	31	109	83	75

Applicable for 10 MPa coolant (1) Balanced to G2.5 max.n: 35,000 min⁻¹. (2) Balanced to G2.5 max.n: 30,000 min⁻¹.

Reference pages



Wrench

K135



Cooling tube

K134

TUNGHOLD

HSK Blanks

Blank for holders (HSK)

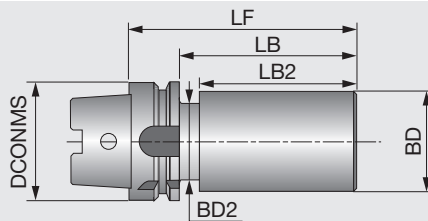

Metric	DCONMS	BD	BD2	LF	LB	LB2
HSKA63B16MN100	63	63	52.8	100	74	55.5
HSKA63B16MN200	63	63	52.8	200	174	155.5
HSKA100B16MN100	100	102	85	100	71	54.8
HSKA100B16MN200	100	102	85	200	171	154.8

Material: Case hardened alloy steel
 Shank hardness: 58 HRC minimum
 Nose hardness: 35-37 HRC

Reference pages



Wrench

K135



Cooling tube

K134

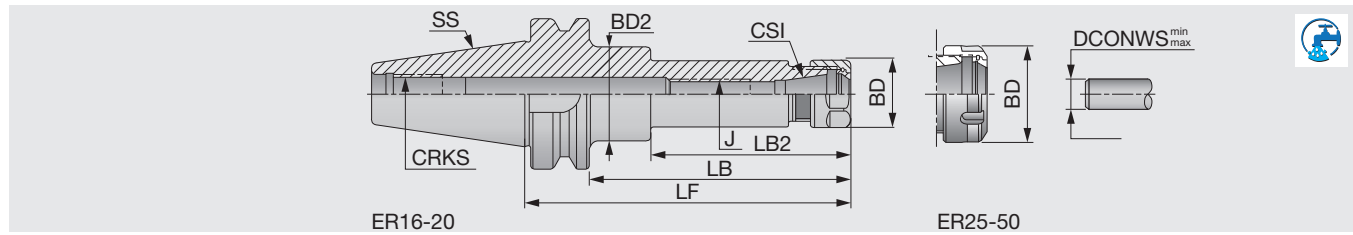

Inch	SS	CSI	Range	LF	LB	LB2	BD	BD2	J	CRKS
CAT30ER16X2.750 ⁽¹⁾	30	ER16	0.022 - 0.396	2.75	1.37	-	1.102	1.248	M10	1/2-13
CAT30ER20X2.562 ⁽¹⁾	30	ER20	0.041 - 0.514	2.562	1.102	-	1.248	1.248	M12	1/2-13
CAT30ER32X3.268 ⁽¹⁾	30	ER32	0.08 - 0.789	3.268	1.89	-	1.968	1.248	M18X1.5	1/2-13
CAT40ER16X3.937	40	ER16	0.022 - 0.396	3.937	1.37	-	1.102	1.752	M12	5/8-11
CAT40ER16X5.906	40	ER16	0.022 - 0.396	5.906	3.35	-	1.102	1.752	M12	5/8-11
CAT40ER20X3.937	40	ER20	0.041 - 0.514	3.937	2.56	-	1.339	1.752	M12	5/8-11
CAT40ER20X5.906	40	ER20	0.041 - 0.514	5.906	3.78	110	1.339	1.752	M12	5/8-11
CAT40ER25X2.562	40	ER25	0.041 - 0.632	2.562	1.18	-	1.654	1.752	M16	5/8-11
CAT40ER25X4.000	40	ER25	0.041 - 0.632	4	2.62	-	1.654	1.752	M16	5/8-11
CAT40ER25X6.000	40	ER25	0.041 - 0.632	6	4.62	-	1.654	1.752	M16	5/8-11
CAT40ER32X2.562	40	ER25	0.08 - 0.789	2.562	-	85	1.968	1.752	M22X1.5	5/8-11
CAT40ER32X4.000	40	ER25	0.08 - 0.789	4	-	-	1.968	1.752	M22X1.5	5/8-11
CAT40ER32X6.000	40	ER25	0.08 - 0.789	6	-	-	1.968	1.752	M22X1.5	5/8-11
CAT40ER40X3.359	40	ER40	0.12 - 1.025	3.359	-	-	2.48	1.752	M28X1.5	5/8-11
CAT40ER40X4.000	40	ER40	0.12 - 1.025	4	-	85	2.48	1.752	M28X1.5	5/8-11
CAT50ER16X3.937 ⁽¹⁾	50	ER16	0.022 - 0.396	3.937	2.56	85	1.102	2.752	M12	1-8
CAT50ER16X5.906 ⁽¹⁾	50	ER16	0.022 - 0.396	5.906	3.49	-	1.102	2.752	M12	1-8
CAT50ER16X8.000 ⁽¹⁾	50	ER16	0.022 - 0.396	8	2.98	-	1.102	2.752	M12	1-8
CAT50ER20X3.937 ⁽¹⁾	50	ER20	0.041 - 0.514	3.937	2.56	-	1.349	2.752	M16	1-8
CAT50ER20X5.906 ⁽¹⁾	50	ER20	0.041 - 0.514	5.906	4.53	-	1.349	2.752	M16	1-8
CAT50ER20X8.000 ⁽¹⁾	50	ER20	0.041 - 0.514	8	4.62	-	1.349	2.752	M16	1-8
CAT50ER25X4.000 ⁽¹⁾	50	ER25	0.041 - 0.632	4	2.58	-	1.654	2.752	M16	1-8
CAT50ER25X6.000 ⁽¹⁾	50	ER25	0.041 - 0.632	6	4.62	-	1.654	2.752	M16	1-8
CAT50ER25X8.000 ⁽¹⁾	50	ER25	0.041 - 0.632	8	6.58	-	1.654	2.752	M16	1-8
CAT50ER32X4.000 ⁽¹⁾	50	ER32	0.08 - 0.789	4	2.54	-	1.968	2.752	M22X1.5	1-8
CAT50ER32X6.000 ⁽¹⁾	50	ER32	0.08 - 0.789	6	4.58	-	1.968	2.752	M22X1.5	1-8
CAT50ER32X8.000 ⁽¹⁾	50	ER32	0.08 - 0.789	8	6.58	-	1.968	2.752	M22X1.5	1-8
CAT50ER40X4.000 ⁽¹⁾	50	ER40	0.12 - 1.025	4	2.62	-	2.48	2.752	M28X1.5	1-8
CAT50ER40X6.000 ⁽¹⁾	50	ER40	0.12 - 1.025	6	4.62	-	2.48	2.752	M28X1.5	1-8
CAT50ER40X8.000 ⁽¹⁾	50	ER40	0.12 - 1.025	8	6.58	-	2.48	2.752	M28X1.5	1-8
CAT50ER50X4.000 ⁽¹⁾	50	ER50	0.396 - 1.338	4	-	-	3.07	2.752	M36X1.5	1-8
CAT50ER50X6.000 ⁽¹⁾	50	ER50	0.396 - 1.338	6	-	-	3.07	2.752	M36X1.5	1-8

(1) Balanced to G6.3 at 12,000 min⁻¹.

(2) ER11 MINI Collet Chuck Spec.

Add B for coolant through the flange.

Wrench is not included.

Applicable for 10 MPa pressure coolant.

Option: Wrench for ER Collet

Reference pages

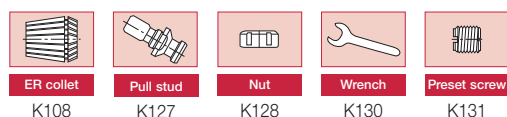

TUNGSHORT

CAT-ER collet

TungShort collet chucks with CAT shank

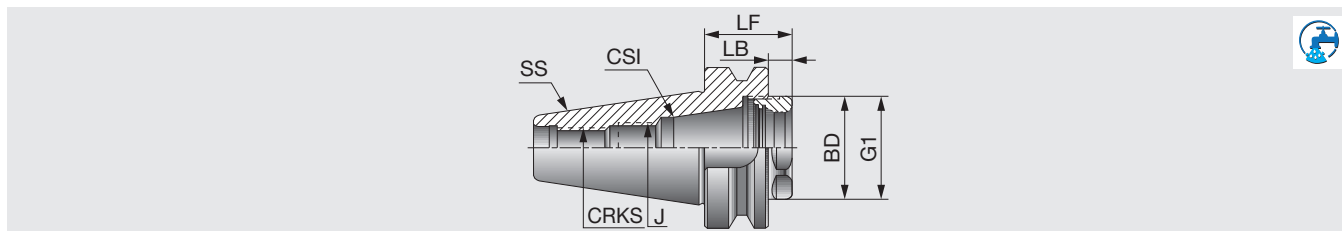

Inch	SS	CSI	Range	LF	LB	BD	J	CRKS	G1
CAT40ER32SHORT	40	ER20	0.08 - 0.789	1.124	0.374	1.575	5/8X1 1	5/8X11	M40X1.5
CAT40ER32SHORTM	40	ER32	0.08 - 0.789	1.754	1	1.575	5/8X11	5/8X11	M40X1.5
CAT40ER40SHORT	40	ER32	0.12 - 1.025	2.124	1.37	1.969	5/8X11	5/8X11	M50X1.5
CAT50ER32SHORT	50	ER32	0.08 - 0.789	1.124	0.374	1.575	M22X1.5	1-8	M40X1.5
CAT50ER32SHORTM	50	ER32	0.08 - 0.789	1.754	1	1.575	M22X1.5	1-8	M40X1.5
CAT50ER40SHORT	50	ER40	0.12 - 1.025	1.124	0.374	1.969	M28X1.5	1-8	M50X1.5
CAT50ER40SHORTM	50	ER40	0.12 - 1.025	1.754	1	1.969	M28X1.5	1-8	M50X1.5

Add B for coolant through the flange.
Applicable for 10 MPa pressure coolant.

Option: Wrench for ER Collet

Reference pages



ER collet

K108



Pull stud

K127



Nut

K128



Wrench

K130



Preset screw

K131

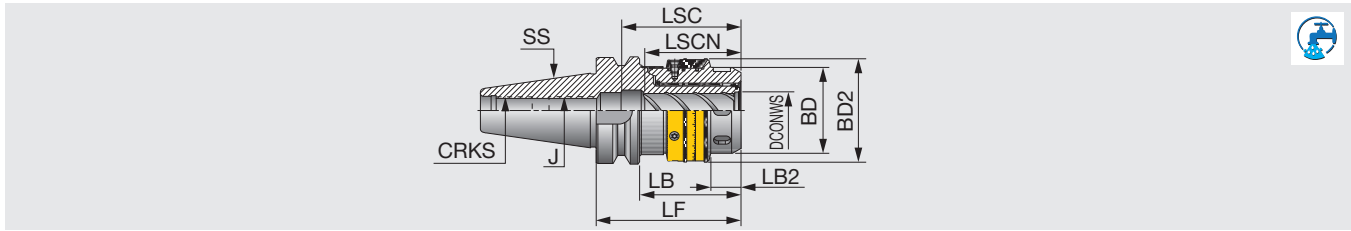

Inch	SS	DCONWS	Range	LF	LB	LB2	BD	BD2	LSCN	LSC	J	CRKS
CAT50TUNGMAX3/4X4.13BIN ⁽¹⁾	50	0.75	0.25 - 0.75	4.138	3.386	0.689	1.988	2.394	2.19	2.72	M16	1-8

(1) Balanced to G6.3 at 8,000 min⁻¹.
Applicable for 10 MPa pressure coolant.

Option: Wrench for TungMax collet

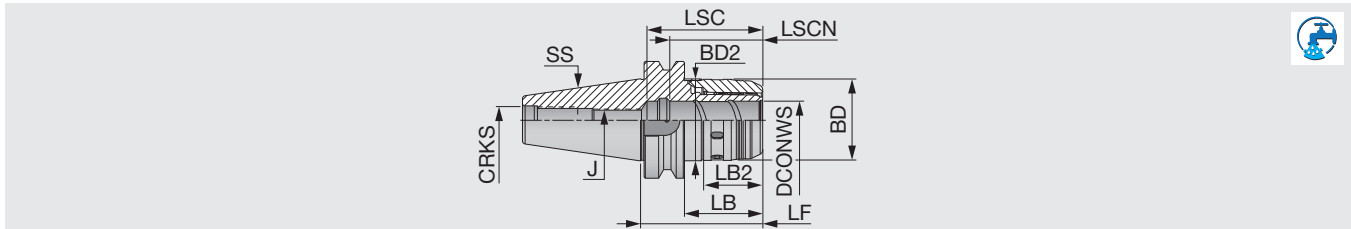

Inch	SS	DCONWS	Range	BD	BD2	LF	LB	LB2	LSCN	LSC	J	CRKS
CAT40MAXIN1-1/4X4.16	40	1.25	0.25 - 1.25	2.717	2.756	4.16	3.41	-	2.76	3.23	M16	5/8-11
CAT40MAXIN3/4X3.75	40	0.75	0.25 - 0.75	2	2.087	3.744	2.992	2.362	2.19	2.72	M16	5/8-11
CAT50MAXIN1-1/4X4.05	50	1.25	0.25 - 1.25	2.717	2.752	4.05	3.3	-	2.76	3.31	M20X2	1-8
CAT50MAXIN1-1/4X5.314	50	1.25	0.25 - 1.25	2.717	2.752	5.315	4.565	-	2.78	3.34	M20X2	1-8
CAT50MAXIN3/4X4.13	50	0.75	0.25 - 0.75	2	2.087	4.138	3.386	2.244	2.19	2.72	M16	1-8

(1) Chucks with taper size 40 can be balanced by the balancing ring up to G2.5 at 20,000 min⁻¹.
(2) Chucks with taper size 50 can be balanced by the balancing ring up to G2.5 at 18,000 min⁻¹.
Applicable for 10 MPa pressure coolant.

Option: Wrench for TungMax collet

Reference pages

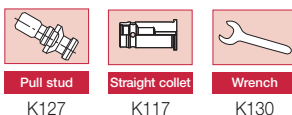

Pull stud K127
Straight collet K117
Wrench K130

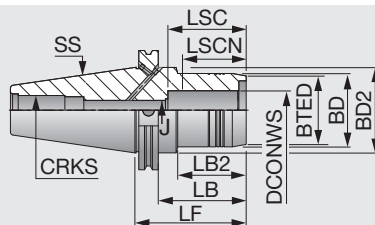

Inch	SS	DCONWS	BTED	BD	BD2	LF	LB	LB2	LSCN	LSC	J	CRKS
CAT40HYDRO1/4X2.677	40	0.25	0.906	1.023	1.75	2.677	1.927	1.299	1.06	1.46	M5	5/8"-11UNC
CAT40HYDRO3/8X2.835	40	0.375	1.063	1.181	1.75	2.834	2.083	1.456	1.26	1.65	M6	5/8"-11UNC
CAT40HYDRO1/2X3.031	40	0.5	1.142	1.259	1.75	3.031	2.279	1.653	1.46	1.85	M8X1	5/8"-11UNC
CAT40HYDRO5/8X3.149	40	0.625	1.339	1.496	1.75	3.149	2.397	1.692	1.65	2.05	M8X1	5/8"-11UNC
CAT40HYDRO3/4X3.228	40	0.75	1.496	1.653	1.75	3.228	2.476	1.85	1.65	2.05	M12X1	5/8"-11UNC
CAT40HYDRO1X3.228	40	1	1.811	1.968	1.75	3.228	2.476	2.007	1.89	2.28	M16X1	5/8"-11UNC
CAT40HYDRO1-1/4X4.331	40	1.25	2.205	2.559	1.75	4.331	2.832	2.204	2.05	2.44	M16X1	5/8"-11UNC
CAT50HYDRO1/4X2.677	50	0.25	0.906	1.023	2.75	2.667	1.925	1.299	1.06	1.46	M5	1"-8 UNC
CAT50HYDRO3/8X2.834	50	0.375	1.063	1.181	2.75	2.834	2.083	1.456	1.26	1.65	M6	1"-8 UNC
CAT50HYDRO1/2X3.228	50	0.5	1.142	1.259	2.75	3.228	2.476	1.653	1.46	1.85	M10	1"-8 UNC
CAT50HYDRO5/8X3.149	50	0.625	1.339	1.496	2.75	3.149	2.397	1.574	1.65	2.05	M8X1	1"-8 UNC
CAT50HYDRO3/4X3.228	50	0.75	1.496	1.653	2.75	3.228	2.476	1.79	1.65	2.05	M12X1	1"-8 UNC
CAT50HYDRO1X3.228	50	1	1.811	1.968	2.75	3.228	2.476	1.771	1.65	2.28	M16X1	1"-8 UNC
CAT50HYDRO1-1/4X3.583	50	1.25	2.205	2.362	2.75	3.583	2.83	2.204	2.05	2.52	M16X1	1"-8 UNC

Chucking forces will be reduced by 25% if reduction sleeves are used.

Reduction sleeves are available for 3/4 and 1-1/4 " bore diameters (ordered separately).

The coolant passages in the B type flange are blocked with screws which can be removed when required.

Clamping wrench (WRENCH HYDRO HEX 4) and test bar should be ordered separately.

Applicable for 10 MPa pressure coolant.

Reference pages



Pull stud

K127



Straight collet

K120

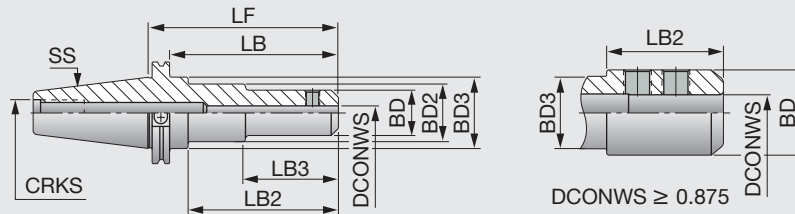

Inch	SS	DCONWS	BD	BD2	BD3	LF	LB	LB2	LB3	CRKS
CAT40EM3/16X2.500	40	0.187	0.866	-	1.752	2.5	1.75	1.121	-	5/8-11
CAT40EM1/4X2.500	40	0.25	1	-	1.752	2.5	1.75	1.121	-	5/8-11
CAT40EM3/8X1.750 ⁽¹⁾	40	0.375	1.5	-	1.752	1.75	1	-	-	5/8-11
CAT40EM3/8X2.500	40	0.375	1.248	-	1.752	2.5	1.75	1.121	-	5/8-11
CAT40EM3/8X2.500B ⁽¹⁾	40	0.375	1.248	-	1.752	2.5	1.75	1.121	-	5/8-11
CAT40EM1/2X1.750 ⁽¹⁾	40	0.5	1.5	-	1.752	1.75	1	-	-	5/8-11
CAT40EM1/2X2.625	40	0.5	1.752	-	1.752	2.625	1.875	-	-	5/8-11
CAT40EM1/2X2.625B ⁽¹⁾	40	0.5	1.752	-	1.752	2.625	1.875	-	-	5/8-11
CAT40EM5/8X1.750 ⁽¹⁾	40	0.625	1.5	-	1.752	1.75	1	-	-	5/8-11
CAT40EM5/8X3.750	40	0.625	1.752	-	1.752	3.75	3	-	-	5/8-11
CAT40EM5/8X3.750B ⁽¹⁾	40	0.625	1.752	-	1.752	3.75	3	-	-	5/8-11
CAT40EM3/4X1.750	40	0.75	1.75	-	1.752	1.75	1	-	-	5/8-11
CAT40EM3/4X3.750	40	0.75	1.752	-	1.752	3.75	3	-	-	5/8-11
CAT40EM3/4X3.750B ⁽¹⁾	40	0.75	1.752	-	1.752	3.75	3	-	-	5/8-11
CAT40EM7/8X4.000	40	0.875	2.047	-	1.752	4	3.25	2.62	-	5/8-11
CAT40EM1X1.750 ⁽¹⁾	40	1	2	-	1.752	1.75	1	-	-	5/8-11
CAT40EM1X1.750B ⁽¹⁾	40	1	2	-	1.752	1.75	1	-	-	5/8-11
CAT40EM1X4.000	40	1	2.559	-	1.752	4	3.25	2.62	-	5/8-11
CAT40EM1X4.000B ⁽¹⁾	40	1	2.559	-	1.752	4	3.25	2.62	-	5/8-11
CAT40EM1-1/4X2.000 ⁽¹⁾	40	1.25	2.25	-	1.752	2	1.25	-	-	5/8-11
CAT40EM1-1/4X4.250	40	1.25	2.752	-	1.752	4.25	3.5	2.87	-	5/8-11
CAT40EM1-1/4X4.250B ⁽¹⁾	40	1.25	2.752	-	1.752	4.25	3.5	2.87	-	5/8-11
CAT40EM1-1/2X4.625	40	1.5	3.15	-	1.752	4.625	3.875	3.245	-	5/8-11
CAT40EM1-1/2X4.625B ⁽¹⁾	40	1.5	3.15	-	1.752	4.625	3.875	3.245	-	5/8-11
CAT50EM1/4X2.500	50	0.25	1	-	2.752	2.5	1.75	1.12	-	1-8
CAT50EM1/4X4.500	50	0.25	1	-	2.752	4.5	3.75	3.15	-	1-8
CAT50EM1/4X6.250	50	0.25	1	1.969	2.752	6.25	5.5	4.87	2.756	1-8
CAT50EM3/8X2.500	50	0.375	1.248	-	2.752	2.5	1.75	1.12	-	1-8
CAT50EM3/8X2.500B ⁽¹⁾	50	0.375	1.248	-	2.752	2.5	1.75	1.12	-	1-8
CAT50EM3/8X4.500	50	0.375	1.248	-	2.752	4.5	3.75	3.12	-	1-8
CAT50EM3/8X6.500	50	0.375	1.248	1.969	2.753	6.5	5.5	5.12	3.13	1-8
CAT50EM3/8X6.500B ⁽¹⁾	50	0.375	1.248	1.969	2.753	6.5	5.5	5.12	3.13	1-8
CAT50EM1/2X2.625	50	0.5	1.752	-	2.752	2.625	1.875	1.245	-	1-8
CAT50EM1/2X2.625B ⁽¹⁾	50	0.5	1.752	-	2.752	2.625	1.875	1.245	-	1-8
CAT50EM1/2X4.625	50	0.5	1.752	-	2.752	4.625	3.875	3.245	-	1-8
CAT50EM1/2X4.625B ⁽¹⁾	50	0.5	1.752	-	2.752	4.625	3.875	3.245	-	1-8
CAT50EM1/2X6.625	50	0.5	1.752	2.205	2.752	6.625	5.875	5.245	3.248	1-8
CAT50EM1/2X6.625B ⁽¹⁾	50	0.5	1.752	2.205	2.752	6.625	5.875	5.245	3.248	1-8
CAT50EM5/8X3.750	50	0.625	1.752	-	2.752	3.75	3	2.37	-	1-8
CAT50EM5/8X3.750B ⁽¹⁾	50	0.625	1.752	-	2.752	3.75	3	2.37	-	1-8
CAT50EM5/8X5.750	50	0.625	1.752	-	2.752	5.75	5	4.37	-	1-8
CAT50EM5/8X5.750B ⁽¹⁾	50	0.625	1.752	-	2.752	5.75	5	4.37	-	1-8
CAT50EM5/8X7.750	50	0.625	1.752	2.165	2.753	7.75	7	6.37	4.39	1-8

Add B for coolant through the flange.

These tool holders can be used only on vertical machines with an umbrella type ATC. (They cannot be used with arm type ATC.)

Applicable for 7 MPa pressure coolant.

Reference pages



Pull stud

K127



Clamping screw

K133

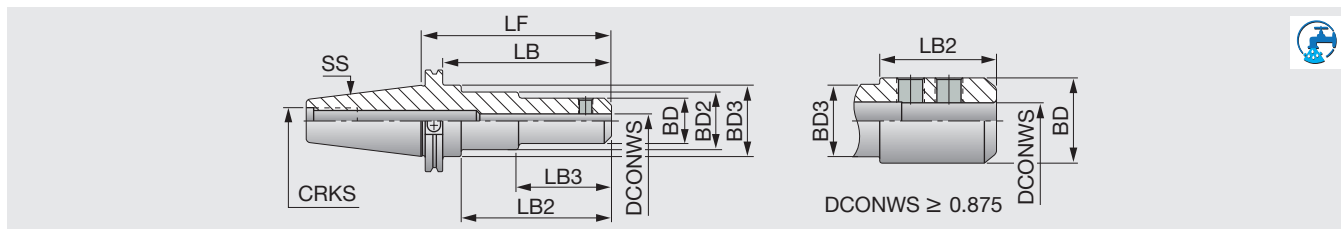

Inch	SS	DCONWS	BD	BD2	BD3	LF	LB	LB2	LB3	CRKS
CAT50EM3/4X3.750	50	0.75	1.772	-	2.752	3.75	3	2.37	-	1-8
CAT50EM3/4X3.750B ⁽¹⁾	50	0.75	1.772	-	2.752	3.75	3	2.37	-	1-8
CAT50EM3/4X5.750	50	0.75	1.772	-	2.752	5.75	5	3.15	-	1-8
CAT50EM3/4X5.750B ⁽¹⁾	50	0.75	1.772	-	2.752	5.75	5	3.15	-	1-8
CAT50EM3/4X7.750	50	0.75	1.772	2.264	2.753	7.75	7	6.37	3.15	1-8
CAT50EM3/4X7.750B ⁽¹⁾	50	0.75	1.772	2.264	2.753	7.75	7	6.37	3.15	1-8
CAT50EM7/8X7.750	50	0.75	2.047	-	2.752	7.75	7	3.15	-	1-8
CAT50EM7/8X3.750	50	0.875	2.047	-	2.752	3.75	3	2.37	-	1-8
CAT50EM1X4.000	50	1	2.559	-	2.753	4	3.25	2.62	-	1-8
CAT50EM1X4.000B ⁽¹⁾	50	1	2.559	-	2.753	4	3.25	2.62	-	1-8
CAT50EM1X6.000	50	1	2.559	-	2.752	6	5.25	4.62	-	1-8
CAT50EM1X6.000B ⁽¹⁾	50	1	2.559	-	2.752	6	5.25	4.62	-	1-8
CAT50EM1X8.000	50	1	2.559	-	2.752	8	7.25	4.625	-	1-8
CAT50EM1-1/4X4.000	50	1.25	2.752	-	2.752	4	3.25	-	-	1-8
CAT50EM1-1/4X4.000B ⁽¹⁾	50	1.25	2.752	-	2.752	4	3.25	-	-	1-8
CAT50EM1-1/4X6.000	50	1.25	2.752	-	2.752	6	5.25	-	-	1-8
CAT50EM1-1/4X8.000	50	1.25	2.752	-	2.752	8	7.25	-	-	1-8
CAT50EM1-1/2X4.000	50	1.5	3.15	-	2.752	4	3.25	2.62	-	1-8
CAT50EM1-1/2X4.000B ⁽¹⁾	50	1.5	3.15	-	2.752	4	3.25	2.62	-	1-8
CAT50EM1-1/2X6.000	50	1.5	3.15	-	2.752	6	5.25	4.62	-	1-8
CAT50EM1-1/2X8.000	50	1.5	3.15	-	2.752	8	7.25	6.62	-	1-8
CAT50EM2X5.625	50	2	3.74	-	2.752	5.625	4.875	4.245	-	1-8

(1) Add B for coolant through the flange.

These tool holders can be used only on vertical machines with an umbrella type ATC. (They cannot be used with arm type ATC.)

Applicable for 7 MPa pressure coolant.

Reference pages



Pull stud

K127



Clamping screw

K133

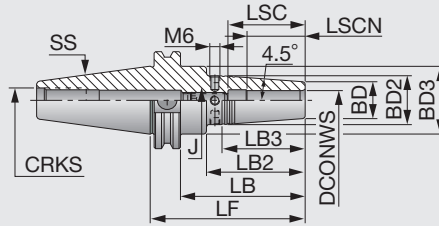

Inch	SS	DCONWS	BD	BD2	BD3	LF	LB	LB2	LB3	LSCN	LSC	J	CRKS	Wrench
CAT40SRKIN1/4X3.500	40	0.25	0.827	1.063	1.752	3.5	2.75	2.12	1.501	0.98	1.42	M5	5/8-11	0.098
CAT40SRKIN5/16X3.500	40	0.313	0.827	1.063	1.752	3.5	2.75	2.12	1.501	0.98	1.42	M6	5/8-11	0.118
CAT40SRKIN3/8X3.750	40	0.375	0.945	1.26	1.752	3.75	3	2.37	2	1.22	1.65	M8	5/8-11	0.157
CAT40SRKIN7/16X3.750	40	0.438	0.945	1.26	1.752	3.75	3	2.37	2.001	1.42	1.85	M10	5/8-11	0.197
CAT40SRKIN1/2X3.750	40	0.5	0.945	1.26	1.752	3.75	3	2.37	2.001	1.42	1.85	M10	5/8-11	0.197
CAT40SRKIN5/8X3.750	40	0.625	1.063	1.339	1.752	3.75	3	2.37	1.751	1.54	1.97	M12	5/8-11	0.236
CAT40SRKIN3/4X4.000	40	0.75	1.299	1.654	1.752	4	3.25	2.62	2.251	1.61	2.05	M16	5/8-11	0.315
CAT40SRKIN7/8X4.000	40	0.875	1.732	2.087	1.752	4	3.25	2.62	2.251	1.61	2.05	M16	5/8-11	0.315
CAT40SRKIN1X4.000	40	1	1.732	2.087	1.752	4	3.25	2.62	2.251	1.85	2.28	M16	5/8-11	0.315
CAT40SRKIN1-1/4X4.000	40	1.25	1.732	2.087	1.752	4	3.25	2.62	2.251	1.85	2.28	M16	5/8-11	0.315
CAT50SRKIN1/4X3.500 ⁽¹⁾	50	0.25	0.827	1.063	2.752	3.5	2.75	2.12	1.501	0.98	1.42	M5	1-8	0.098
CAT50SRKIN5/16X3.500 ⁽¹⁾	50	0.313	0.827	1.063	2.752	3.5	2.7	2.12	1.501	0.98	1.42	M6	1-8	0.118
CAT50SRKIN3/8X3.750 ⁽¹⁾	50	0.375	0.945	1.26	2.752	3.75	3	2.37	2	1.22	1.65	M8	1-8	0.157
CAT50SRKIN7/16X3.750 ⁽¹⁾	50	0.438	0.945	1.26	2.752	3.75	3	2.37	2.001	1.42	1.85	M10	1-8	0.197
CAT50SRKIN1/2X3.750 ⁽¹⁾	50	0.5	0.945	1.26	2.752	3.75	3	2.37	2.001	1.42	1.85	M10	1-8	0.197
CAT50SRKIN5/8X3.750 ⁽¹⁾	50	0.625	1.063	1.339	2.752	3.75	3	2.62	1.751	1.54	1.97	M12	1-8	0.236
CAT50SRKIN3/4X4.000 ⁽¹⁾	50	0.75	1.299	1.654	2.752	4	3.25	2.62	2.251	1.61	2.05	M16	1-8	0.315
CAT50SRKIN7/8X4.000 ⁽¹⁾	50	0.875	1.732	2.087	2.752	4	3.25	2.62	2.251	1.61	2.05	M16	1-8	0.315
CAT50SRKIN1X4.000 ⁽¹⁾	50	1	1.732	2.087	2.752	4	3.25	2.62	2.251	1.85	2.28	M16	1-8	0.315
CAT50SRKIN1-1/4X4.000 ⁽¹⁾	50	1.25	1.732	2.087	2.752	4	3.25	2.62	2.251	1.85	2.28	M16	1-8	0.315

(1) Balanced to G2.5 20.000 min⁻¹
 Use only inductive heating device for SRKIN holders.
 Add B for coolant through the flange.
 Applicable for 10 MPa pressure coolant.

Reference pages

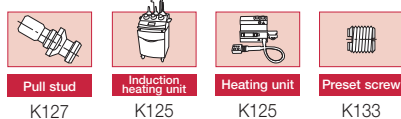

Grade
 Insert
 Toolholder
 Ext. Toolholder
 Int. Toolholder
 Threading
 Grooving
 Milling Cutter
 Miniature Tool
 Endmill
 Drilling Tool
 Tooling System
 User's Guide
 Index

A
 B
 C
 D
 E
 F
 G
 H
 I
 J
 K
 L
 M

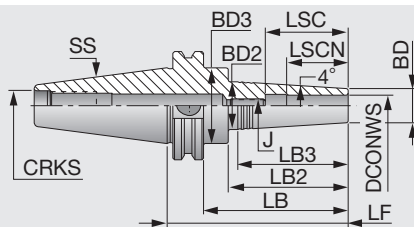

Inch	SS	DCONWS	BD	BD2	BD3	LF	LB	LB2	LB3	LSCN	LSC	J	CRKS	Wrench
CAT40SRK1/8X2.000	40	0.125	0.394	0.591	1.752	3.38	2.63	2	1.4	0.39	0.63	M6	5/8-11	0.118
CAT40SRK1/8X3.250	40	0.125	0.394	0.748	1.752	4.63	2.88	3.25	2.526	0.39	0.63	M6	5/8-11	0.118
CAT40SRK3/16X2.000	40	0.188	0.394	0.591	1.752	3.38	2.63	2	1.4	0.59	0.83	M6	5/8-11	0.118
CAT40SRK3/16X3.250	40	0.188	0.394	0.748	1.752	4.963	2.88	3.25	2.526	0.59	0.83	M6	5/8-11	0.118
CAT40SRK1/4X2.000	40	0.25	0.433	0.63	1.752	3.38	2.63	2	1.398	0.71	0.95	M8	5/8-11	0.157
CAT40SRK1/4X3.250	40	0.25	0.433	0.787	1.752	4.63	2.88	3.25	2.524	0.71	0.95	M8	5/8-11	0.157
CAT40SRK5/16X2.000	40	0.313	0.551	0.787	1.752	3.38	2.63	2	1.673	0.98	1.22	M10	5/8-11	0.197
CAT40SRK5/16X3.250	40	0.313	0.551	0.906	1.752	4.63	2.88	3.25	2.518	0.98	1.22	M10	5/8-11	0.197
CAT40SRK3/8X2.000	40	0.375	0.63	0.866	1.752	3.38	2.63	2	1.669	1.18	1.42	M12	5/8-11	0.236
CAT40SRK3/8X3.250	40	0.375	0.63	0.965	1.752	4.63	2.88	3.25	2.373	1.18	1.42	M12	5/8-11	0.236
CAT40SRK7/16X2.000	40	0.438	0.787	1.024	1.752	3.38	2.63	2	1.665	1.22	1.61	M10	5/8-11	0.197
CAT40SRK7/16X3.250	40	0.438	0.787	1.102	1.752	4.63	2.88	3.25	2.228	1.22	1.61	M10	5/8-11	0.197
CAT40SRK1/2X2.000	40	0.5	0.787	1.024	1.752	3.38	2.63	2	1.665	1.26	1.65	M10	5/8-11	0.197
CAT40SRK1/2X3.250	40	0.5	0.787	1.102	1.752	4.63	3.25	3.25	2.228	1.26	1.65	M10	5/8-11	0.197

Applicable for 10 MPa pressure coolant.

Reference pages



Pull stud

K127



Induction heating unit

K125



Heating unit

K125



Preset screw

K133

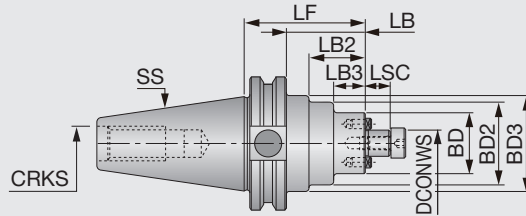

Inch	SS	DCONWS	BD	BD2	BD3	LF	LB	LB2	LB3	LSC	CRKS
CAT40SEM1/2X1.500	40	0.5	-	1.378	1.75	1.5	0.75	0.102	-	0.57	5/8-11
CAT40SEM3/4X1.375	40	0.75	-	-	1.752	1.375	0.625	-	-	0.669	5/8-11
CAT40SEM1X2.062	40	1	-	2.165	1.752	2.062	1.312	0.682	-	0.669	5/8-11
CAT40SEM1-1/4X2.125	40	1.25	-	2.752	1.752	2.125	1.375	0.745	-	0.669	5/8-11
CAT40SEM1-1/2X2.406	40	1.5	-	3.071	1.752	2.406	1.656	1.026	-	0.938	5/8-11
CAT50SEM3/4X1.500	50	0.75	-	1.772	2.752	1.5	0.75	0.12	-	0.669	1-8
CAT50SEM3/4X1.920X8.00	50	0.75	-	1.92	2.752	8	7.25	6.583	-	0.669	1-8
CAT50SEM3/4X3.500	50	0.75	-	1.772	2.752	3.5	0.75	2.102	-	0.669	1-8
CAT50SEM3/4X5.500	50	0.75	1.772	2.362	2.752	5.5	4.75	4.13	2.48	0.669	1-8
CAT50SEM1X2.000	50	1	-	2.165	2.752	2	1.25	0.62	-	0.669	1-8
CAT50SEM1X2.42X12.00	50	1	-	2.42	2.752	12	11.25	10.583	-	0.669	1-8
CAT50SEM1X4.000	50	1	-	2.165	2.752	4	3.25	0.728	-	0.669	1-8
CAT50SEM1X6.000	50	1	-	2.165	2.752	6	5.25	2.657	-	0.669	1-8
CAT50SEM1-1/4X1.500	50	1.25	-	-	1.752	1.5	0.75	-	-	0.669	1-8
CAT50SEM1-1/4X2.92X13.0	50	1.25	-	2.921	2.752	13	12.25	11.62	-	0.669	1-8
CAT50SEM1-1/4X3.500	50	1.25	-	-	2.752	3.5	2.75	-	-	0.669	1-8
CAT50SEM1-1/4X4.000	50	1.25	-	-	2.752	4	-	-	-	0.669	1-8
CAT50SEM1-1/4X6.000	50	1.25	-	-	2.752	6	-	-	-	0.669	1-8
CAT50SEM1-1/2X2.406	50	1.5	-	3.071	2.752	2.406	1.656	1.026	-	0.938	1-8
CAT50SEM1-1/2X4.000	50	1.5	-	3.071	2.752	4	3.25	2.62	-	0.938	1-8
CAT50SEM1-1/2X6.000	50	1.5	-	3.071	2.752	6	5.25	4.62	-	0.938	1-8
CAT50SEM2X2.406	50	2	-	3.858	2.752	2.406	1.656	1.026	-	0.938	1-8
CAT50SEM2X4.000	50	2	-	3.858	2.752	4	3.25	2.62	-	0.938	1-8

CAT40 = Balanced to G2.5 20,000 min⁻¹
 CAT50 = Balanced to G2.5 15,000 min⁻¹

Reference pages

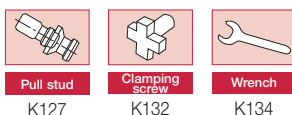

TUNGHOLD**CAT-SEM-C**

Shell mill holder with coolant hole for CAT shank

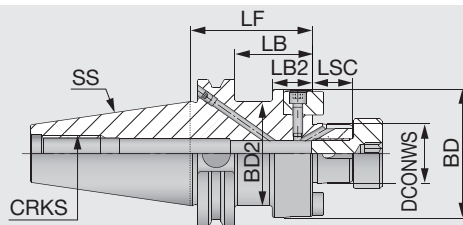

Inch	SS	DCONWS	BD	BD2	LF	LB	LB2	LSC	CRKS
CAT40SEM1/2X2.000C	40	0.5	1.475	1.752	2	1.25	-	0.57	5/8-11
CAT40SEM3/4X1.375C	40	0.75	-	1.752	1.375	0.625	-	0.669	5/8-11
CAT40SEM1X2.062C	40	1	2.165	1.752	2.062	1.312	0.682	0.669	5/8-11
CAT40SEM1-1/4X2.125C	40	1.25	2.752	1.752	2.125	1.375	0.745	0.669	5/8-11
CAT40SEM1-1/2X2.406C	40	1.5	3.071	1.752	2.406	1.656	1.026	0.937	5/8-11
CAT50SEM1/2X3.500C	50	0.5	1.475	2.752	3.5	2.75	-	0.57	1-8
CAT50SEM3/4X2.000C	50	0.75	1.772	2.752	2	1.25	0.62	0.669	1-8
CAT50SEM3/4X3.500C	50	0.75	1.772	2.752	3.5	2.75	2.12	0.669	1-8
CAT50SEM3/4X5.500C	50	0.75	1.772	2.752	5.5	4.75	4.12	0.669	1-8
CAT50SEM1X2.000C	50	1	2.165	2.752	2	1.25	0.62	0.669	1-8
CAT50SEM1X4.000C	50	1	2.165	2.752	4	3.25	2.62	0.669	1-8
CAT50SEM1-1/4X2.000C	50	1.25	-	2.752	2	1.25	0.62	0.669	1-8
CAT50SEM1-1/4X3.500C	50	1.25	-	2.752	3.5	2.75	2.12	0.669	1-8
CAT50SEM1-1/2X2.500C	50	1.5	3.071	2.752	2.5	1.75	1.12	0.937	1-8
CAT50SEM1-1/2X4.000C	50	1.5	3.071	2.752	4	3.25	2.62	0.937	1-8

CAT40 = Balanced to G2.5 20,000 min⁻¹CAT50 = Balanced to G2.5 15,000 min⁻¹

Applicable for 7 MPa pressure coolant.

TUNGHOLD**CAT-FM**

Face mill holder with CAT shank

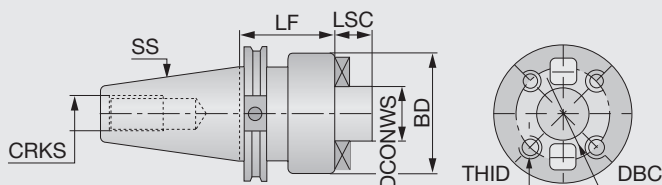

Inch	SS	DCONWS	BD	DBC	LF	LSC	CRKS	THID
CAT50FM2-1/2X2.875	50	2.500	4.881	4	2.875	1.125	1-8	5/8-11

Reference pages



Pull stud

K127



Clamping screw

K132



Wrench

K134

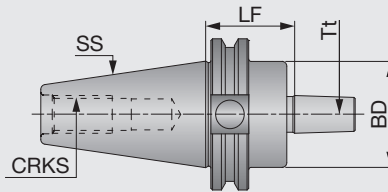

Inch	SS	Tt	LF	BD	CRKS
CAT40DCJ2X1.500	40	J2	1.5	1.752	5/8-11
CAT40DCJ3X1.500	40	J3	1.5	1.75	5/8-11
CAT40DCJ4X1.500	40	J4	1.5	1.752	5/8-11
CAT40DCJ6X1.500	40	J6	1.5	1.752	5/8-11
CAT40DCJ33X1.500	40	J33	1.5	1.752	5/8-11
CAT50DCJ3X1.656	50	J3	1.656	2.752	1-8
CAT50DCJ4X1.500	50	J4	1.5	2.752	1-8
CAT50DCJ5X1.625	50	J5	1.625	2.752	1-8
CAT50DCJ6X1.500	50	J6	1.5	2.752	1-8
CAT50D.CHKJ33X1.500	50	J33	1.5	2.752	1-8

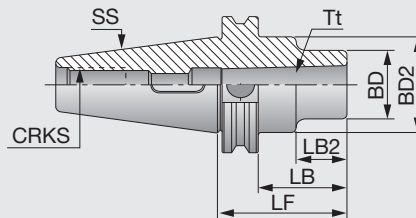

Inch	SS	Tt	LF	LB	LB2	BD	BD2	CRKS
CAT40MT1X1.750	40	MT1	1.75	1	0.37	1	1.752	5/8-11
CAT40MT2X2.250	40	MT2	2.25	1.5	0.87	1.26	1.752	5/8-11
CAT40MT3X2.765	40	MT3	2.765	2.015	-	-	1.752	5/8-11
CAT40MT4X3.625	40	MT4	3.625	2.875	2.245	2.008	1.752	5/8-11
CAT50MT1X1.500	50	MT1	1.5	0.75	0.12	1	2.752	1-8
CAT50MT2X2.000	50	MT2	2	1.25	0.62	1.26	2.752	1-8
CAT50MT3X2.500	50	MT3	2.5	1.75	1.12	1.575	2.752	1-8
CAT50MT4X3.375	50	MT4	3.375	2.625	1.995	1.969	2.752	1-8
CAT50MT5X3.750	50	MT5	3.75	3	-	-	2.752	1-8

Reference pages



Pull stud

K127

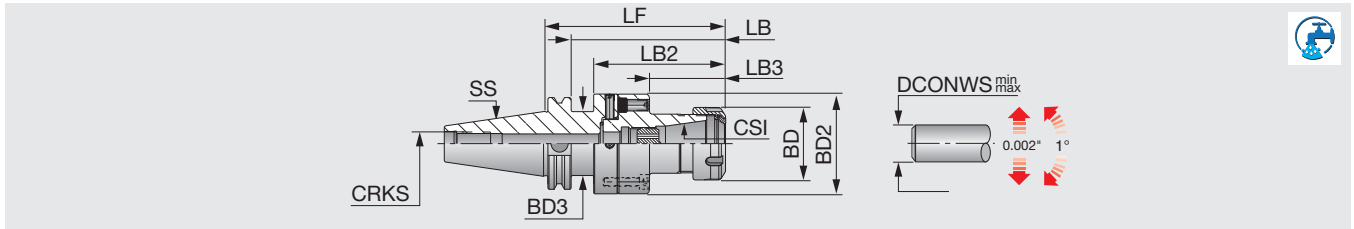

Inch	SS	CSI	Range	LF	LB	LB2	LB3	BD	BD2	BD3	CRKS
ADJCAT40D2.756ER32	40	ER32	0.08 - 0.789	4.902	4.152	3.522	2.067	1.969	2.756	1.752	5/8-11
ADJCAT50D2.756ER32	50	ER32	0.08 - 0.789	4.902	4.152	-	2.067	1.969	2.756	-	1-8

Applicable for 10 MPa pressure coolant.

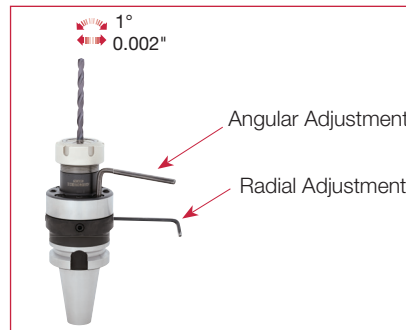

Reference pages



Pull stud

K127



ER collet

K108



Nut

K128



Wrench

K130



Preset screw

K131

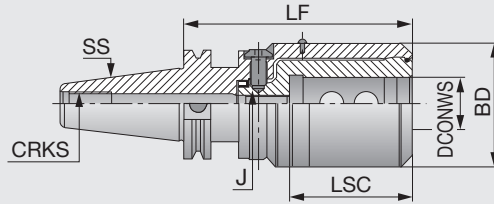

Inch	SS	BD	DCONWS	LF	LSC	J	CRKS
TUNGBORE-CAT40EM1ADB	40	2.835	1	5.338	2.795	M10	5/8-11
TUNGBORE-CAT40EM1-1/4ADB	40	2.835	1.25	5.338	2.795	M10	5/8-11
TUNGBORE-CAT40EM1-1/2ADB	40	2.835	1.5	5.338	2.795	M10	5/8-11
TUNGBORE-CAT50EM3/4ADB	50	2.835	0.75	5.177	2.795	M10	1-8
TUNGBORE-CAT50EM1ADB	50	2.835	1	5.177	2.795	M10	1-8
TUNGBORE-CAT50EM1-1/4ADB	50	2.835	1.25	5.177	2.795	M10	1-8
TUNGBORE-CAT50EM1-1/2ADB	50	2.835	1.5	5.177	2.795	M10	1-8

Applicable for 10 MPa pressure coolant.

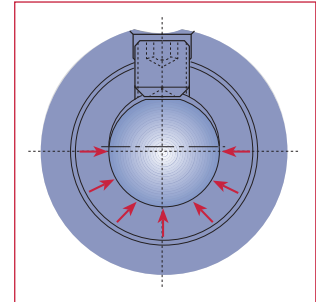
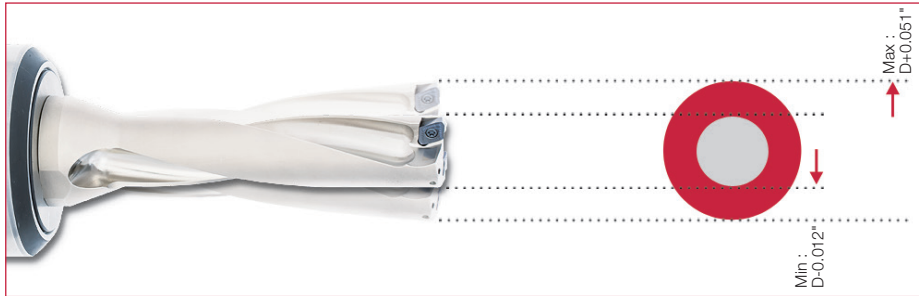

The bore's section is actually made from two shifted circular sections. The clamping screw pushes the drill shank through a narrowed opening, forcing elastic deformation of the holder. Contact is made around more than 180°, providing a high clamping force.



Pull stud

K127

TUNG^{GTI}

GTI-CAT

TungGTI tapping attachment with CAT shank

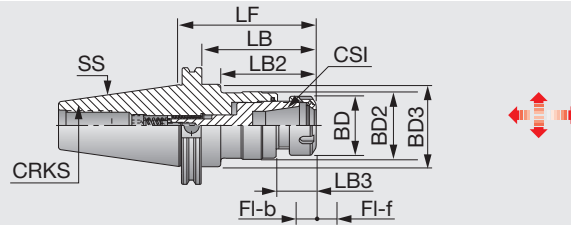

Inch	SS	CSI	Tap min	Tap max	LF	LB	LB2	LB3	BD	BD2	BD3	FI-f	FI-b	CRKS
GTICAT40ER16	40	ER16	#6	3/8	3.203	2.453	1.823	0.969	1.102	1.161	1.752	0.32	0.12	5/8-11
GTICAT40ER32	40	ER32	1/4	3/4	4.439	3.689	3.059	1.299	1.969	2.224	1.752	0.36	0.16	5/8-11
GTICAT40ER40	40	ER40	1/4	1-1/8	5.148	4.398	3.768	2.008	2.480	2.224	1.752	0.36	0.16	5/8-11
GTICAT50ER16	50	ER16	#6	3/8	4.213	3.463	2.833	0.969	1.102	1.161	2.752	0.32	0.12	1-8
GTICAT50ER32	50	ER32	1/4	3/4	4.543	3.793	3.163	1.299	1.969	2.224	2.752	0.36	0.16	1-8
GTICAT50ER40	50	ER40	1/4	1-1/8	5.252	4.502	3.872	2.008	2.480	2.224	2.752	0.36	0.16	1-8

Applicable for 10 MPa pressure coolant.

TUNG^{FIT}

CAT-CF

TungFit quick change style modular tooling system with CAT shank

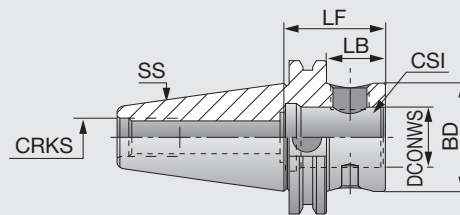

Inch	SS	CSI	LF	LB	DCONWS	BD	CRKS
CAT40CF4-L	40	CF4	4.000	3.252	0.984	1.752	5/8-11
CAT40CF4-S	40	CF4	1.750	1.000	0.984	1.752	5/8-11
CAT50CF4-L	50	CF4	4.000	3.252	0.984	1.752	1-8
CAT50CF4-S	50	CF4	1.750	1.000	0.984	1.752	1-8

Tightening torque: 43.4 lb-ft
Add B for coolant through the flange.
Applicable for 10 MPa pressure coolant.

Reference pages



Pull stud

K127



ER collet

K108



Nut

K128



Wrench

K130



Preset screw

K131

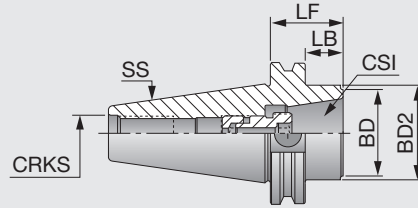

Inch	SS	CSI	LF	LB	BD	BD2	CRKS
CAT40ER32CLICK-IN	40	32SRF	0.789	-	1.614	-	5/8X11
CAT50ER32CLICK-INM	50	32SRF	1.419	0.669	1.614	2.752	1-8

Tightening torque: 235 N·m
Applicable for 10 MPa pressure coolant.

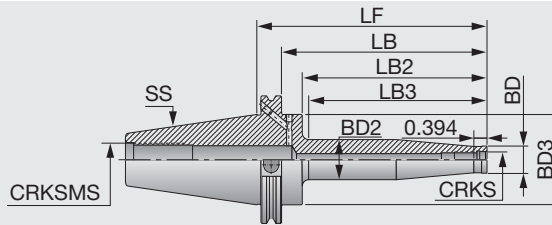

Inch	SS	CRKS	BD	BD2	BD3	LF	LB	LB2	LB3	CRKSMS
CAT40ODPM6X2.000	40	M6	0.380	0.511	-	2.000	0.935	-	0.935	5/8-11
CAT40ODPM6X4.000	40	M6	0.380	0.725	-	4.000	2.935	-	2.935	5/8-11
CAT40ODPM8X2.000	40	M8	0.510	0.580	-	2.000	0.944	-	0.944	5/8-11
CAT40ODPM8X4.000	40	M8	0.510	0.790	-	4.000	2.913	-	2.913	5/8-11
CAT40ODPM10X2.000	40	M10	0.710	0.780	-	2.000	1.062	-	1.062	5/8-11
CAT40ODPM10X4.000	40	M10	0.710	0.990	-	4.000	3.149	-	3.149	5/8-11
CAT40ODPM12X4.000	40	M12	0.830	1.110	-	4.000	3.149	-	3.149	5/8-11
CAT40ODPM12X6.000	40	M12	0.830	1.310	-	6.000	5.118	-	5.118	5/8-11
CAT40ODPM16X4.000	40	M16	1.140	1.420	-	4.000	3.149	-	3.149	5/8-11
CAT40ODPM16X6.000	40	M16	1.140	1.620	-	6.000	5.118	-	5.118	5/8-11
CAT50ODPM8X5.000 ⁽¹⁾	50	M8	0.516	0.906	2.752	5.000	4.232	3.602	3.405	1-8
CAT50ODPM10X3.000 ⁽¹⁾	50	M10	0.709	0.693	2.752	3.000	2.232	1.602	1.405	1-8
CAT50ODPM10X7.000 ⁽¹⁾	50	M10	0.709	1.102	2.752	7.000	6.232	5.602	5.405	1-8
CAT50ODPM12X3.000 ⁽¹⁾	50	M12	0.827	0.811	2.752	3.000	2.232	1.602	1.405	1-8
CAT50ODPM12X7.000 ⁽¹⁾	50	M12	0.827	1.220	2.752	7.000	6.232	5.602	5.405	1-8
CAT50ODPM16X3.000 ⁽¹⁾	50	M16	1.142	1.126	2.752	3.000	2.232	1.602	1.405	1-8
CAT50ODPM16X7.000 ⁽¹⁾	50	M16	1.142	1.339	2.752	7.000	6.232	5.602	5.405	1-8

(1) Balanced to G2.5 12,000 min⁻¹
Applicable for 10 MPa pressure coolant.

Reference pages



Pull stud

K127



ER 32 ODP

K122

TUNGHOLD

R-8 ER

ER collet chuck holder (R-8 Bridgeport)

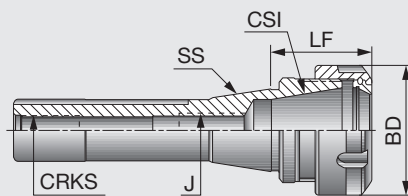

Metric	SS	CSI	Range	LF	BD	J	CRKS
R-8ER16X38	R-8	ER16	0.5-10	38	28	M10	7/16-20
R-8ER32X40	R-8	ER32	2-20	40	50	M12	7/16-20
R-8ER40X72	R-8	ER40	3-26	72	63	M12	7/16-20

Applicable for 10 MPa coolant

Option: Wrench for ER collet

TUNGHOLD

ST-ER-M

ER Mini collet chuck holder (straight shank)

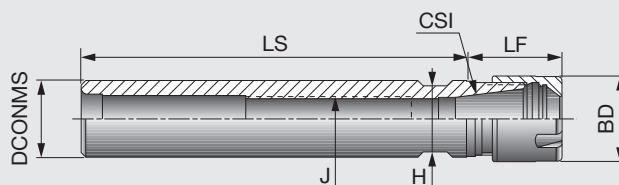

Metric	DCONMS	CSI	Range	LS	LF	J	BD	H
ST12X80ER11M	12	ER11	0.5-7	80	26.5	-	16	11
ST16X50ER11MF	16	ER11	0.5-7	50	18.5	M8	16	13
ST16X100ER11M	16	ER11	0.5-7	100	18.5	M8	16	13
ST16X150ER11M	16	ER11	0.5-7	150	18.5	M8	16	13
ST12X80ER16M	12	ER16	0.5-10	80	36.5	-	22	17
ST20X100ER16M	20	ER16	0.5-10	100	25	M12	22	17
ST20X150ER16M	20	ER16	0.5-10	150	25	M12	22	17
ST20X100ER20M	20	ER20	1-13	100	40	M12	28	21
ST20X150ER20M	20	ER20	1-13	150	40	M12	28	21

Applicable for 10 MPa coolant
F indicates a flat on the shank.

Option: Wrench for ER collet

Reference pages



ER collet

K108



Nut

K128



Wrench

K130



Preset screw

K131

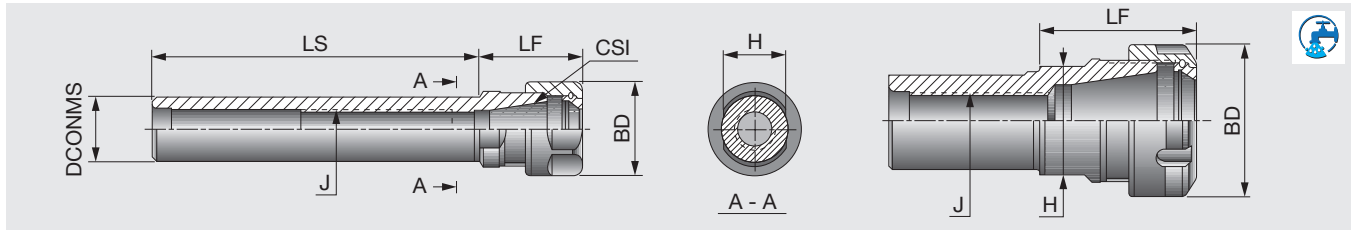

Metric	DCONMS	CSI	Range	LS	LF	J	BD	H
ST16X50ER11F	16	ER11	0.5-7	50	18.5	M8	19	13
ST20X50ER11F	20	ER11	0.5-7	50	18.5	M10	19	17
ST20X100ER11	20	ER11	0.5-7	100	18.5	M10	19	17
ST20X150ER11	20	ER11	0.5-7	150	18.5	M10	19	17
ST20X50ER16F	20	ER16	0.5-10	50	32.3	M12	28	19
ST20X100ER16	20	ER16	0.5-10	100	30	M12	28	19
ST20X150ER16	20	ER16	0.5-10	150	30	M12	28	19
ST20X50ER20F	20	ER20	1-13	50	42.5	M12	34	22
ST25X100ER20	25	ER20	1-13	100	36	M16	34	22
ST25X150ER20	25	ER20	1-13	150	36	M16	34	22
ST20X50ER25F	20	ER25	1-16	50	46	M12	42	28
ST20X100ER25	20	ER25	1-16	100	46	M12	42	28
ST20X50ER32F	20	ER32	2-20	50	54	M12	50	36
ST20X100ER32	20	ER32	2-20	100	54	M12	50	36
ST25X50ER25F	25	ER25	1-16	50	46	M16	42	28
ST25X100ER25	25	ER25	1-16	100	46	M16	42	28
ST25X50ER32F	25	ER32	2-20	50	52	M16x2	50	36
ST25X50ER40F	25	ER40	3-26	50	60	M16x2	63	45
ST30X50ER32F	30	ER32	2-20	50	52	M18x1.5	50	36
ST30X50ER40F	30	ER40	3-26	50	60	M18x1.5	63	45
ST32X50ER32F	32	ER32	2-20	50	52	M18x1.5	50	36
ST32X150ER32	32	ER32	2-20	150	52	M18x1.5	50	36
ST32X50ER40F	32	ER40	3-26	50	60	M18x1.5	63	45
ST40X75ER32F	40	ER32	2-20	75	46	M22x1.5	50	44
ST40X75ER40F	40	ER40	3-26	75	55	M22x1.5	63	45
ST50X80ER40F	50	ER40	3-26	80	60	M28x1.5	63	54
ST50X80ER50F	50	ER50	10-34	80	77	M36x1.5	78	58

Applicable for 10 MPa coolant
F indicates a flat on the shank.

Option: Wrench for ER collet

Reference pages

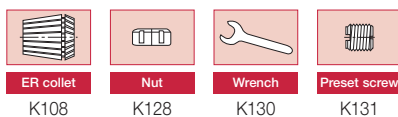

Grade
Insert
Toolholder
Ext. Toolholder
Int. Toolholder
Threading
Grooving
Miniature Tool
Milling Cutter
Endmill
Drilling Tool
Tooling System
User's Guide
Index

A
B
C
D
E
F
G
H
I
J
K
L
M

TUNGHOLD

ST-ER-MF

ER Mini collet chuck holder, with flat, for Swiss machines

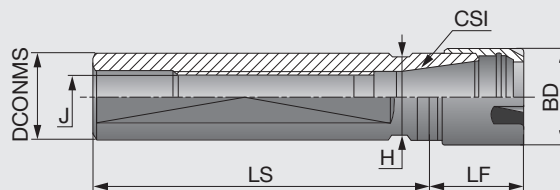

Metric	DCONMS	CSI	Range	LS	LF	J	BD	H	Machine
ST16X35ER16MF	16	ER16	0.5-10	35	36	M8X1	22	17	Tsugami
ST16X38ER11MF	16	ER11	0.5-7	38	18.5	M8X1	16	14	Tsugami
ST16X140ER11MF	16	ER11	0.5-7	140	18.5	M8X1	16	14	-
ST20X70ER16MF	20	ER16	0.5-10	70	26	M12X1	22	17	Tsugami, Citizen
ST20X120ER16MF	20	ER16	0.5-10	120	26	M12X1	22	17	Tsugami, Citizen
ST20X140ER16MF	20	ER16	0.5-10	140	26	M12X1	22	17	Tsugami, Citizen
ST22X38ER16MF	22	ER16	0.5-10	38	26	M12X1	22	19	Star
ST22X70ER16MF	22	ER16	0.5-10	70	26	M12X1	22	19	Star
ST22X70ER25MF	22	ER25	0.5-16	70	47	M12X1	35	27	Star
ST22X80ER20MF	22	ER20	1-13	80	39	M12X1	28	21	Star
ST22X100ER16MF	22	ER16	1-16	100	28	M12X1	22	19	Star
ST25X65ER16MF	25	ER16	0.5-10	65	28	M12X1	22	22	Citizen
ST25X75ER25MF	25	ER25	1-16	75	48	M14X1	35	27	Manurhin
ST25X100ER20MF	25	ER20	1-13	100	28	M14X1	28	22	Tornos
ST25X145ER25MF	25	ER25	1-16	145	36	M14X1	35	27	Tornos
ST25X154ER20MF	25	ER20	1-13	154	28	M14X1	28	22	Tornos
ST32X70ER25MF	32	ER25	1-16	70	30	M18X1	35	27	Schuette

Applicable for 10 MPa coolant

Option: Wrench for ER collet

TUNGHOLD

ST-ER-MF-D

ER Mini collet chuck holder, double end type

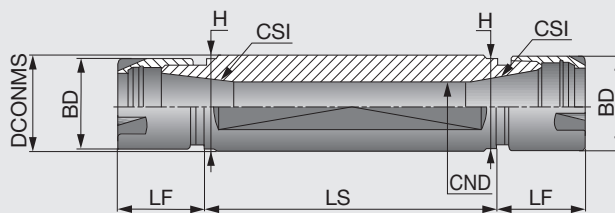

Metric	DCONMS	CSI	Range	LS	LF	BD	CND	H	Machine
ST16X50ER11MFD	16	ER11	0.5-7	50	18.5	16	7.5	14	-
ST20X30ER11MFD	20	ER11	0.5-7	30	18.5	16	7.5	17	Tsugami
ST20X50ER11MFD	20	ER11	0.5-7	50	18.5	16	7.5	17	Tsugami
ST20X55ER16MFD	20	ER16	0.5-10	55	25	22	10.5	17	Tsugami
ST22X55ER16MFD	22	ER16	0.5-10	55	28	22	10.5	19	Star
ST22X75ER16MFD	22	ER16	0.5-10	75	28	22	10.5	19	Star
ST25X62ER16MFD	25	ER16	0.5-10	62	28	22	10.5	22	-
ST32X55ER20MFD	32	ER20	1-13	55	28	28	13.5	27	Star
ST32X75ER20MFD	32	ER20	1-13	75	28	28	13.5	27	Star

Applicable for 10 MPa coolant

Option: Wrench for ER collet

Reference pages



ER collet

K108



Nut

K128



Wrench

K130



Preset screw

K131

ER collet chuck holder, with the capability of internal coolant supply

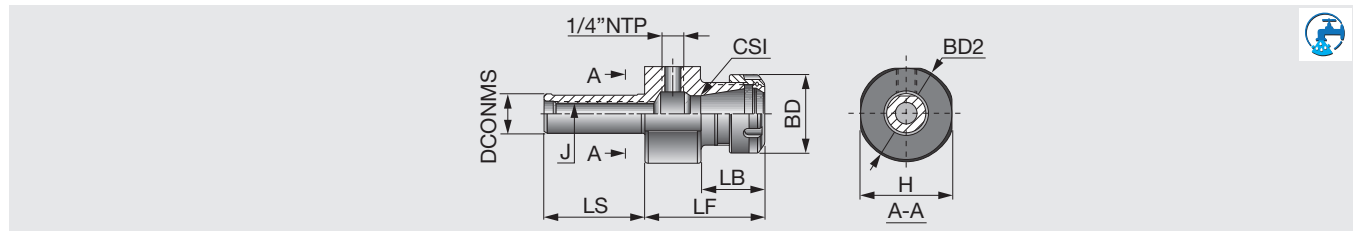

Metric	DCONMS	CSI	Range	LS	LF	LB	J	BD	BD2	H
ST20X65ER20S	20	ER20	1-13	65	63	31	M12	34	40	34
ST20X65ER25S	20	ER25	1-16	65	72	32	M12	42	54	51
ST20X65ER32S	20	ER32	2-20	65	77	41	M12	50	63	59
ST32X65ER32S	32	ER32	2-20	65	77	41	M18x1.5	50	63	59
ST40X75ER32S	40	ER32	2-20	75	77	41	M22x1.5	50	63	59

Applicable for 10 MPa coolant

Option: Wrench for ER collet

TUNGSHRINK

ST-SRK

Thermal shrinking holder for carbide shank (straight shank)

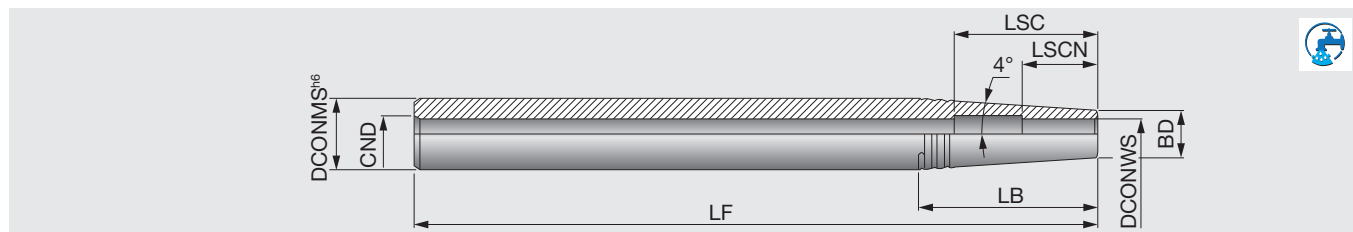

Metric	DCONMS	DCONWS	BD	CND	LF	LB	LSCN	LSC
ST12X160SRK3	12	3	10	4	160	14.3	10	-
ST12X160SRK4	12	4	10	4	160	14.3	12	27
ST16X160SRK3	16	3	10	6	160	43	10	-
ST16X160SRK4	16	4	10	6	160	43	12	-
ST16X160SRK5	16	5	10	6	160	43	15	-
ST16X160SRK6	16	6	11	6	160	35.5	18	35
ST20X200SRK5	20	5	10	6	200	71.5	15	-
ST20X200SRK6	20	6	11	6	200	64.5	18	40
ST20X200SRK8	20	8	14	6	200	43	25	40
ST25X200SRK6	25	6	11	8	200	100	18	35
ST25X200SRK8	25	8	14	8	200	78.6	25	40
ST25X200SRK10	25	10	16	8	200	64.3	30	50
ST25X200SRK12	25	12	20	8	200	35.7	32	52

Applicable for 10 MPa coolant

Option: Wrench for ER collet

Reference pages



ER collet K108
Nut K128
Wrench K130
Preset screw K131

TUNGSTI

GTI-ER-ST

Tapping holder (straight shank)

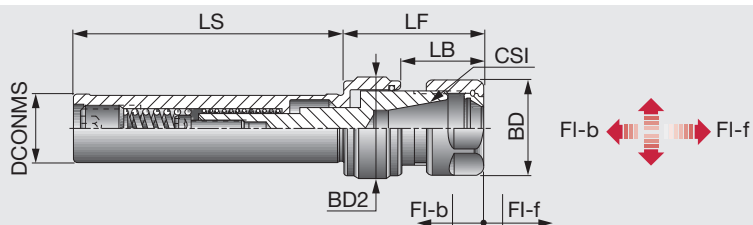

Metric	DCONMS	CSI	Tap min	Tap max	Range	BD	BD2	LB	LF	LS	FI-f	FI-b
GTIER11ST16X150M	16	ER11	M2	M7	0.5-7	16	-	19	-	150	6	3
GTIER16ST20X80	20	ER16	M3	M10	0.5-10	28	29.5	24.6	41.6	80	8	3
GTIER20ST20X80	20	ER20	M4	M14	1-13	34	33.5	28	49	80	8	3
GTIER25ST25X80	25	ER25	M5	M16	1-16	42	40.5	32	53	80	9	4
GTIER32ST25X80	25	ER32	M6	M20	1-16	50	56.5	32	77.2	80	9	4
GTIER40ST32X80	32	ER40	M6	M27	2-20	63	56.5	51	95.2	80	9	4

Option: Wrench for ER collet

KIT GTI-ER-ST

ER tapping holder and spring collets (straight shank)



Metric	Collet size	DCONMS	Qty	Range
KITGTIER16ST20X804	ER16	20	4	4,5,6,7
KITGTIER20ST20X804	ER20	20	4	5,6,7,8
KITGTIER25ST25X805	ER25	25	5	6,7,9,11,12
KITGTIER32ST25X806	ER32	25	6	6,7,9,11,12,16
KITGTIER40ST32X806	ER40	32	6	9,11,14,16,18,20

Includes GTI collets and wrench

Reference pages



ER collet

K108



Nut

K128



Wrench

K130



Preset screw

K131

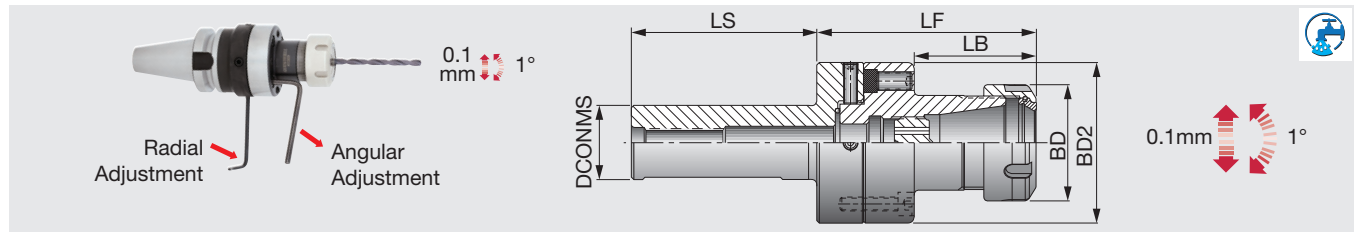

Metric	Range	LF	LB	LS	BD	BD2	DCONMS
ADJST25D70ER32	2-20	94.5	52.5	80	50	70	25
ADJST32D70ER32	2-20	94.5	52.5	80	50	70	32

Applicable for 10 MPa coolant

Option: Wrench for ER collet

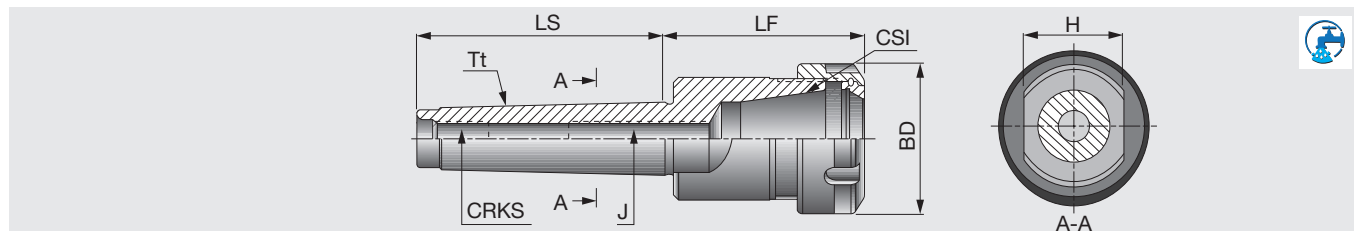

Metric	Tt	CSI	Range	LF	LS	BD	J	CRKS	H
MT2ER20X48.5	MT 2	ER20	1-13	48.5	64	34	M10	M10	22
MT2ER25X52	MT 2	ER25	1-16	52	64	42	M10	M10	28
MT3ER32X69	MT 3	ER32	2-20	69	81	50	M12	M12	24
MT3ER40X79	MT 3	ER40	3-26	79	81	63	M12	M12	24
MT4ER32X61	MT 4	ER32	2-20	60.5	102.5	50	M16	M16	32
MT4ER40X82	MT 4	ER40	3-26	81.5	102.5	63	M16	M16	32
MT4ER50X108	MT 4	ER50	10-34	107.5	102.5	78	M16	M16	32
MT5ER40X82	MT 5	ER40	3-26	82	129.5	63	M28x1.5	M20	45
MT5ER50X85	MT 5	ER50	10-34	85	129.5	78	M28x1.5	M20	45

Applicable for 3 MPa coolant

Option: Wrench for ER collet

Reference pages



TUNGGYRO

GYRO ST-ER TungGYRO

Collet chuck holder with center alignment, for lathes

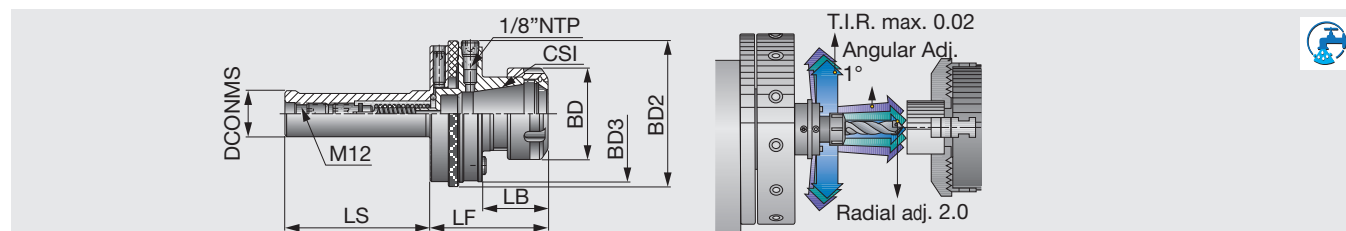

Metric	DCONMS	CSI	Range	LF	LB	LS	BD	BD3	BD2
GYROST25ER25	25	ER25	1-16	65.65	35.5	80	42	74	79
GYROST40ER32	40	ER32	2-20	66.65	36.5	80	50	74	79

Applicable for 3 MPa coolant

For the alignment, first-time users should purchase a TungGyro kit which includes a test bar and a bushing.

Option: Wrench for ER collet

TUNGGYRO

KIT GYRO-ST-ER

Kit for holders with center alignment (straight shank)

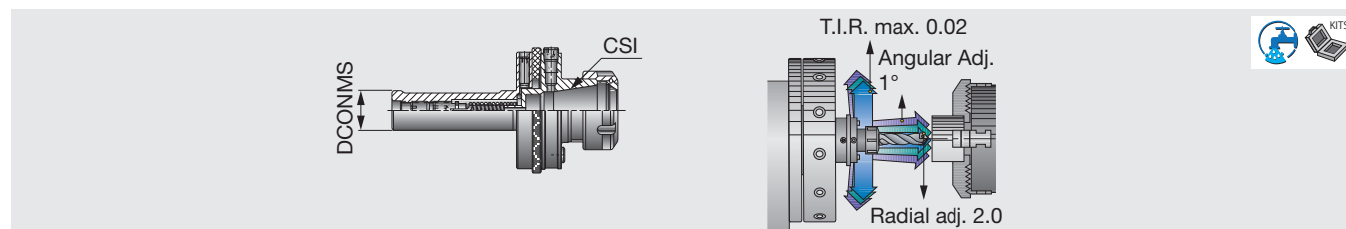

Inch	DCONMS	CSI	Range
KITGYROST1-1/4XER32	1.25	ER32	0.080 - 0.789

Metric	DCONMS	CSI	Range
KITGYROST20ER25	20	ER25	1-16
KITGYROST25ER25	25	ER25	1-16
KITGYROST40ER32	40	ER32	2-20

Applicable for 3 MPa coolant

Kit includes TungGyro holder, test bar, and bushing.

Option: Wrench for ER collet

Reference pages



ER collet

K108



Nut

K128



Wrench

K130



Preset screw

K131

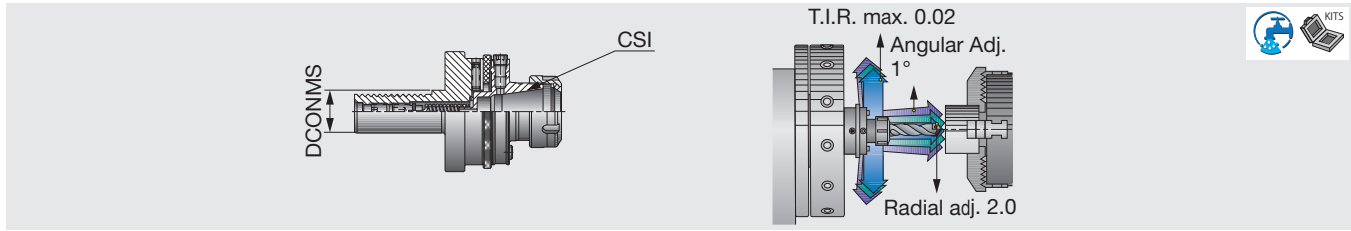





Metric	DCONMS	CSI	Range
KITGYRO30D69880ER25	30	ER25	1-16
KITGYRO30D69880ER32	30	ER32	2-20
KITGYRO40D69880ER32	40	ER32	2-20
KITGYRO50D69880ER32	50	ER32	2-20

Applicable for 3 MPa coolant
Kit includes TungGyro holder, test bar, and bushing.

Option: Wrench for ER collet

Reference pages

			
ER collet	Nut	Wrench	Preset screw
K108	K128	K130	K131

TUNGSKI

GFI-MT-ER

Floating reamer collet chuck

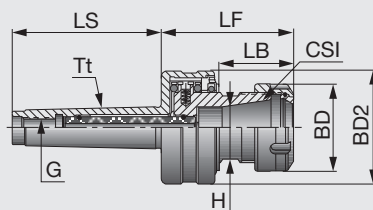

Metric	Tt	CSI	Range	LS	LF	LB	BD	BD2	Radial float	H	G
GFIMT2ER20	MT 2	ER20	1-13	64	60.5	34.5	34	50	1	22	M10
GFIMT3ER32	MT 3	ER32	2-20	81	81.9	45.9	50	65	1.6	36	M12

Applicable for 3 MPa coolant
Maximum 2000 min⁻¹

Option: Wrench for ER collet

TUNGSKI

GFI-ST-ER

Floating reamer collet chuck

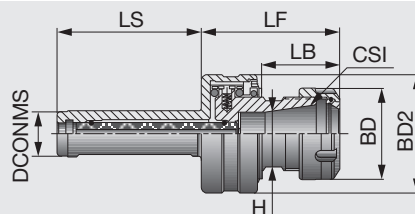

Metric	DCONMS	CSI	Range	LS	LF	LB	BD	BD2	Radial float	H
GFIST20ER20	20	ER20	1-13	65	55.5	34.5	34	50	1	22
GFIST25ER32	25	ER32	2-20	80	76.9	45.9	50	65	1.6	36

Applicable for 3 MPa coolant
Maximum 2000 min⁻¹

Option: Wrench for ER collet

Reference pages



ER collet

K108



Nut

K128



Wrench

K130



Preset screw

K131

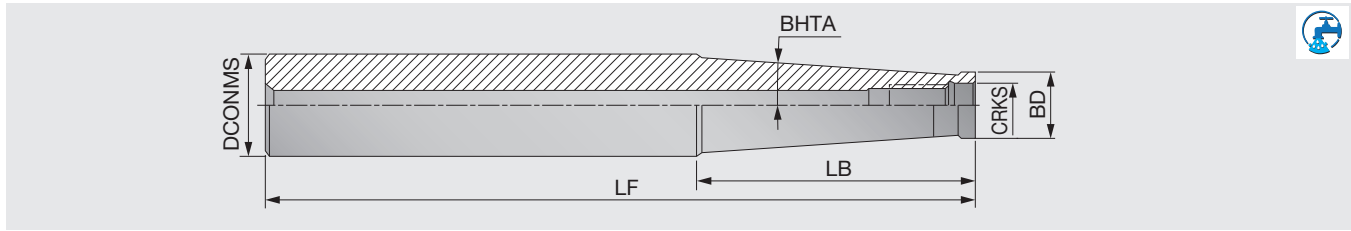

Metric	DCONMS	BD	LF	LB	BHTA	CRKS
SM06-L60C10	10	9.7	60	20	0°	M6
SM06-L105-C12	12	9.7	105	60	1.2°	M6
SM06-L125-C16	16	9.7	125	60	3.3°	M6
SM08-L73C16	16	13	73	25	0°	M8
SM08-L128-C16	16	13	128	80	0.9°	M8
SM08-L170-C20	20	13	170	66.8	3.3°	M8
SM10-L80C20	20	18	80	30	0°	M10
SM10-L130-C20	20	18	130	80	0.6°	M10
SM10-L200-C25	25	19	200	57.2	3.3°	M10
SM12-L86-C25	25	21	86	30	5.1°	M12
SM12-L200-C32	32	21	200	78	4.4°	M12
SM16-L95-C32	32	29	95	35	1.7°	M16
SM16-L230-C32	32	29	230	50	1.8°	M16

Applicable for 10 MPa coolant
A coolant hole with all types of shanks

TUNGFIT TUNGFLEX

S M-CF4 TungFit adapter

TungFlex - TungFit conversion adapter

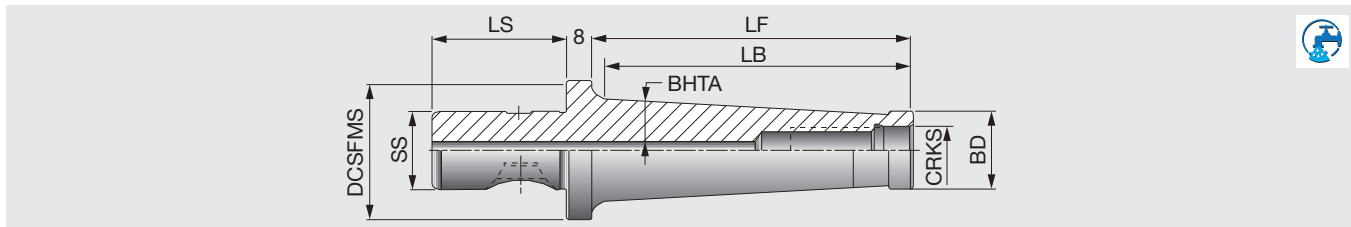

Metric	BD	LF	LB	BHTA	SS	DCSFMS	LS	CRKS
SM12-L85/3.30-CF4	21	93	81.3	4.4°	CF4	44	42	M12
SM16-L130/5.11-CF4	29	138	126.8	2.6°	CF4	44	42	M16
SM12-L140/5.50-CF4	21	148	139.1	4.4°	CF4	44	42	M12
SM16-L170/6.70-CF4	29	178	168.6	2°	CF4	44	42	M16

Applicable for 10 MPa coolant

TUNGFLEX

CAB M-M

Reducer and extension

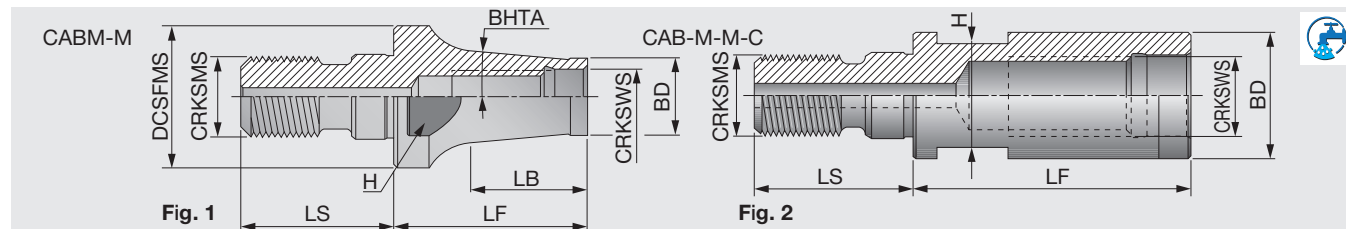

Metric	CRKSMS	BHTA	BD	LF	LB	DCSFMS	LS	H	CRKSWS	Fig.
CABM06M08	M8	5.7°	9.7	30	24.8	13	17.5	9.5	M6	1
CABM08M08-C ⁽¹⁾	M8	0°	13	30	-	-	17.5	9.6	M8	2
CABM08M10	M10	5.2°	13	40	33.4	18	20	15	M8	1
CABM10M10-C ⁽¹⁾	M10	0°	18	35	-	-	20	15	M10	2
CABM10M12	M12	2.5°	18	45	36.4	21	22	17	M10	1
CABM12M12-C ⁽¹⁾	M12	0°	21	40	-	-	22	17	M12	2
CABM12M16	M16	6.3°	21	50	42.5	29	25	25	M12	1
CABM16M16-C ⁽¹⁾	M16	0°	29	40	-	-	25	25	M16	2

Applicable for 10 MPa coolant

(1) With coolant hole

TUNGFLEX

VAD**-M...

TungFlex - TungMeister connection adapter

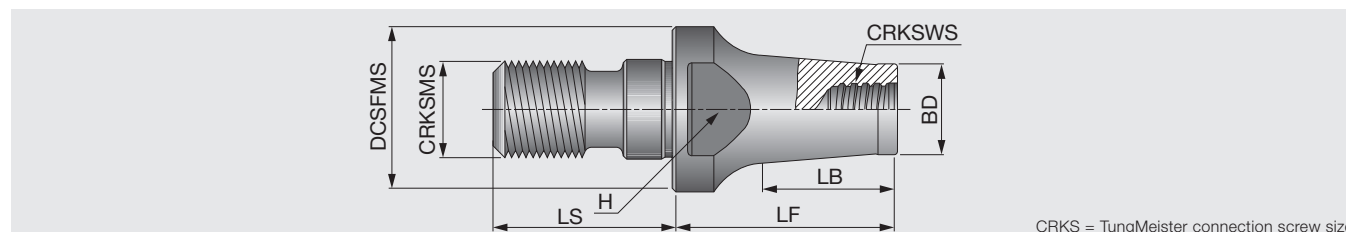

Metric	BD	DCSFMS	LF	LS	LB	CRKSWS	CRKSMS	H
VAD130L016S08-S-M8	11.7	13	16	17.5	6	S08	M8	11
VAD130L025S08-S-M8	11.7	13	25	17.5	20	S08	M8	11
VAD180L020S08-S-M10	11.7	18	20	20	12	S08	M10	13
VAD180L025S08-S-M10	11.7	18	25	20	15	S08	M10	11
VAD210L020S08-S-M12	11.7	21	20	20	10	S08	M12	12.75
VAD210L025S08-S-M12	11.7	21	25	20	13	S08	M12	12.75

Wrenches are sold separately.

Do not apply lubricant to the threaded connection.

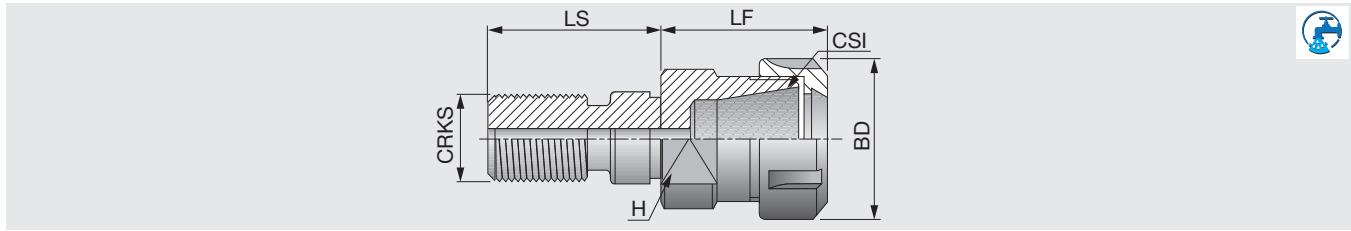

Metric	CRKS	CSI	Range	LF	LS	BD	H
CDPER11M10M	M10	ER11	0.5-7	27	20	16	15
CDPER16M10M	M10	ER16	0.5-10	38.1	20	22	17
CDPER11M12M	M12	ER11	0.5-7	27	22	16	17
CDPER16M12M	M12	ER16	0.5-10	37.1	22	22	17
CDPER16M16	M16	ER16	0.5-10	36.6	25	28	25
CDPER20M16	M16	ER20	1-13	45.5	25	34	25
CDPER25M16	M16	ER25	1-16	44.5	25	42	28

Applicable for 10 MPa coolant

Option: Wrench for ER collet

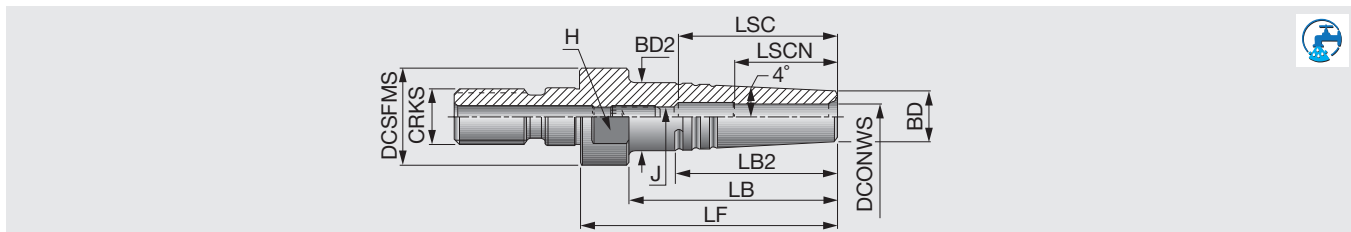

Metric	CRKS	DCSEFMS	DCONWS	BD	BD2	LF	LB	LB2	LSCN	LSC	J	H	Wrench
CDPM10SRK3X40	M10	18	3	10	14	40	31.5	28.4	10	16	M4	15	2
CDPM10SRK4X40	M10	18	4	10	14	40	31.5	28.4	12	19	M4	15	2
CDPM10SRK5X40	M10	18	5	10	14	40	31.5	28.4	15	25	M4	15	2
CDPM12SRK3X45	M12	21	3	10	14	45	36.5	28.8	10	16	M5	18	2.5
CDPM12SRK4X45	M12	21	4	10	14	45	36.5	28.8	12	18	M5	18	2.5
CDPM12SRK5X45	M12	21	5	10	14	45	36.5	28.8	15	25	M5	18	2.5
CDPM12SRK6X45	M12	21	6	11	15	45	36.5	28.4	18	28	M5	18	2.5
CDPM12SRK8X45	M12	21	8	14	18	45	36.5	28.8	25	35	M5	18	2.5
CDPM12SRK10X45	M12	21	10	16	21	45	-	35.6	30	40	M5	18	2.5
CDPM12SRK12X45	M12	21	12	20	25	45	-	36.0	32	42	M5	18	2.5

Applicable for 10 MPa coolant

Reference pages

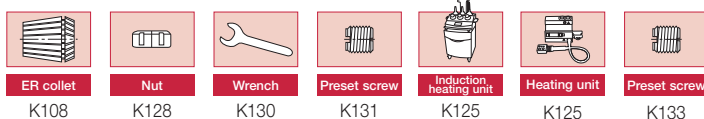

TUNGFIT**EX-CF**

Extension adapter

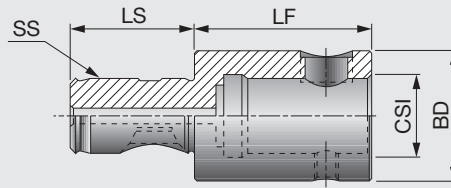

Metric	SS	LS	LF	CSI	BD
EXCF4-S	CF4	42	60	CF4	44
EXCF4-L	CF4	42	100	CF4	44

Applicable for 10 MPa coolant
Tightening torque: 58.8 N·m

TUNGFIT**SEM-CF**

Shell mill adapter

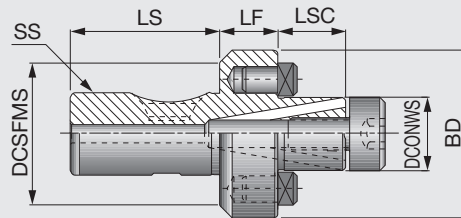

Metric	SS	DCONWS	DCSFMS	BD	LF	LSC	LS
SEM22CF4C	CF4	22	44	47	16	19	42

Applicable for 10 MPa coolant
Tightening torque: 58.8 N·m

Option: Wrench for Lock Screw

TUNGFIT**ER-CF**

ER collet chuck adapter

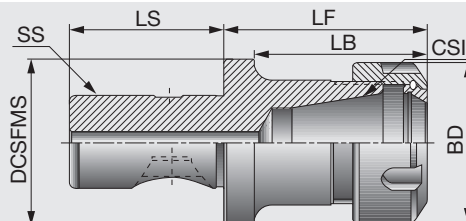

Metric	SS	CSI	Range	LF	LB	LS	BD	DCSFMS
ER11CF4-S	CF4	ER11	0.5-7	55	47	42	19	44
ER16CF4-L	CF4	ER16	0.5-10	100	92	42	28	44
ER16CF4-S	CF4	ER16	0.5-10	55	47	42	28	44
ER20CF4-S	CF4	ER20	1-13	55	92	42	34	44
ER32CF4-L	CF4	ER32	2-20	100	92	42	50	44
ER32CF4-S	CF4	ER32	2-20	55	47	42	50	44

Applicable for 10 MPa coolant
Tightening torque: 58.8 N·m

Option: Wrench for Lock Screw

Reference pages



ER collet

K108



Nut

K128



Wrench

K130

Shanks

CAT MAS-403, DIN69871



ST Straight Shank

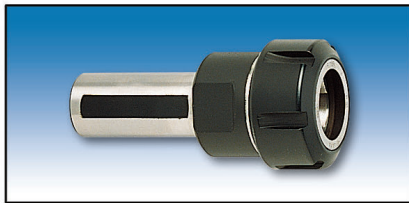

MT Morse Taper

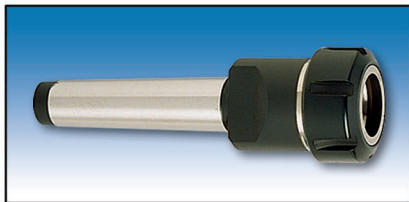

Collet Options

ER-SPR (ER Spring Collet)



**ER-SEAL
(ER SEAL Collet for Internal coolant)**

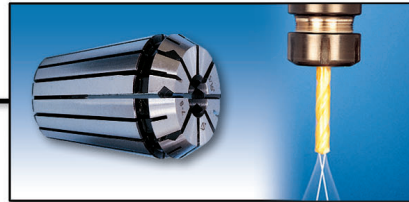

**ER-SEAL JET2
(ER SEAL Collet for External coolant)**



**ER-SRK
(ER Collet with SHRINK Holder)**

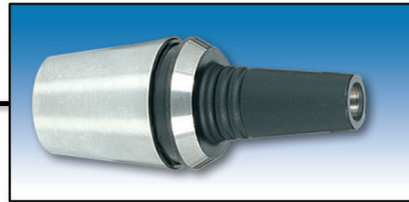

**ER GTI
(ER Collet with Tapping Holder)**

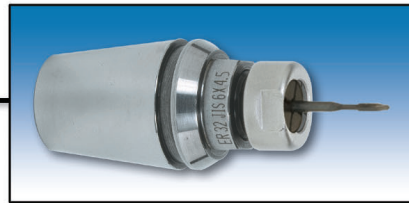

**ER-ODP
(ER Collet with Indexable Modular System)**



TUNG HOLD ER Collet

ER Collet standard DIN6499

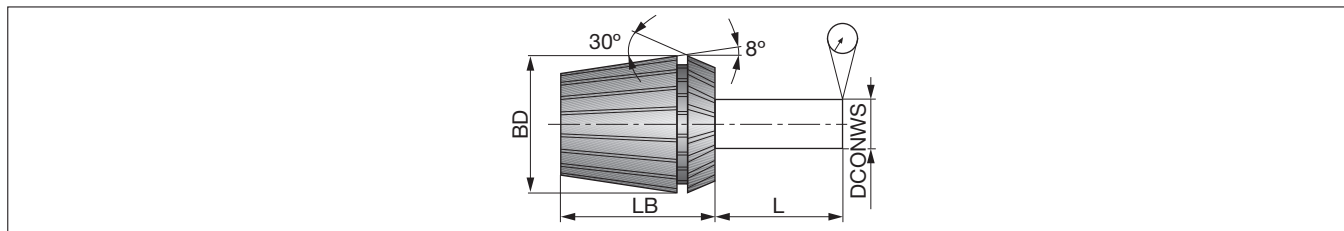

Collet size	BD	LB	L	DCONWS	T.I.R. Precision		DIN6499
					Standard type	AA ultra precision type	
ER11	11.5	18	6	1-1.6	0.01	0.005	-
ER16	17	27	10	1.6-3	0.01	0.005	0.015
ER20	21	31	16	3-6	0.01	0.005	0.015
ER25	26	35	25	6-10	0.01	0.005	0.015
ER32	33	40	40	10-18	0.01	0.005	0.020
ER40	41	46	50	18-26	0.01	0.005	0.020
ER50	52	60	60	26-34	0.01	-	0.025

ER - Coolit Sealed Collet



For internal coolant holders Sealed Collet - JET

For straight shank cutting tools with internal coolant supply.



For External coolant holders Sealed Collet - JET2

With angular double nozzles. Coolant flow is direct to the cutting edge - for use with standard straight shank cutting tools (without coolant hole)

Standard Shank which can be used in Sealed Collets

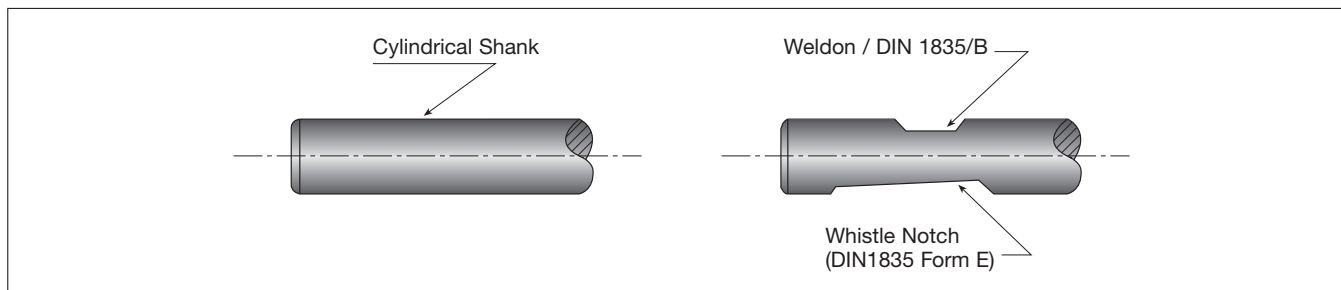

Note: The front end of the sealed collet should be located beyond Weldon or the whistle notch.

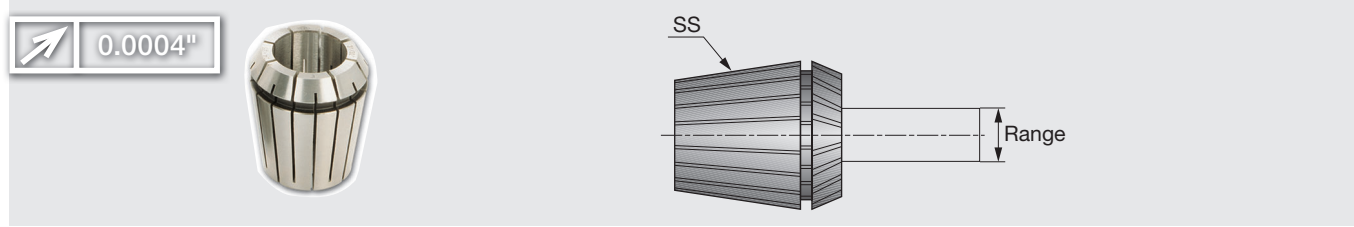

Metric	SS	Range
ER11SPR0.5-1	ER11	0.5-1
ER11SPR1-2	ER11	1-2
ER11SPR2-3	ER11	2-3
ER11SPR3-4	ER11	3-4
ER11SPR4-5	ER11	4-5
ER11SPR5-6	ER11	5-6
ER11SPR6-7	ER11	6-7
ER16SPR0.5-1	ER16	0.5-1
ER16SPR1-2	ER16	1-2
ER16SPR2-3	ER16	2-3
ER16SPR3-4	ER16	3-4
ER16SPR4-5	ER16	4-5
ER16SPR5-6	ER16	5-6
ER16SPR6-7	ER16	6-7
ER16SPR7-8	ER16	7-8
ER16SPR8-9	ER16	8-9
ER16SPR9-10	ER16	9-10
ER20SPR1-2	ER20	1-2
ER20SPR2-3	ER20	2-3
ER20SPR3-4	ER20	3-4
ER20SPR4-5	ER20	4-5
ER20SPR5-6	ER20	5-6
ER20SPR6-7	ER20	6-7
ER20SPR7-8	ER20	7-8
ER20SPR8-9	ER20	8-9
ER20SPR9-10	ER20	9-10
ER20SPR10-11	ER20	10-11
ER20SPR11-12	ER20	11-12
ER20SPR12-13	ER20	12-13
ER25SPR1-2	ER25	1-2
ER25SPR2-3	ER25	2-3
ER25SPR3-4	ER25	3-4
ER25SPR4-5	ER25	4-5
ER25SPR5-6	ER25	5-6
ER25SPR6-7	ER25	6-7
ER25SPR7-8	ER25	7-8
ER25SPR8-9	ER25	8-9
ER25SPR9-10	ER25	9-10
ER25SPR10-11	ER25	10-11
ER25SPR11-12	ER25	11-12
ER25SPR12-13	ER25	12-13
ER25SPR13-14	ER25	13-14
ER25SPR14-15	ER25	14-15
ER25SPR15-16	ER25	15-16
ER32SPR2-3	ER32	2-3
ER32SPR3-4	ER32	3-4
ER32SPR4-5	ER32	4-5
ER32SPR5-6	ER32	5-6
ER32SPR6-7	ER32	6-7
ER32SPR7-8	ER32	7-8

Metric	SS	Range
ER32SPR8-9	ER32	8-9
ER32SPR9-10	ER32	9-10
ER32SPR10-11	ER32	10-11
ER32SPR11-12	ER32	11-12
ER32SPR12-13	ER32	12-13
ER32SPR13-14	ER32	13-14
ER32SPR14-15	ER32	14-15
ER32SPR15-16	ER32	15-16
ER32SPR16-17	ER32	16-17
ER32SPR17-18	ER32	17-18
ER32SPR18-19	ER32	18-19
ER32SPR19-20	ER32	19-20
ER40SPR3-4	ER40	3-4
ER40SPR4-5	ER40	4-5
ER40SPR5-6	ER40	5-6
ER40SPR6-7	ER40	6-7
ER40SPR7-8	ER40	7-8
ER40SPR8-9	ER40	8-9
ER40SPR9-10	ER40	9-10
ER40SPR10-11	ER40	10-11
ER40SPR11-12	ER40	11-12
ER40SPR12-13	ER40	12-13
ER40SPR13-14	ER40	13-14
ER40SPR14-15	ER40	14-15
ER40SPR15-16	ER40	15-16
ER40SPR16-17	ER40	16-17
ER40SPR17-18	ER40	17-18
ER40SPR18-19	ER40	18-19
ER40SPR19-20	ER40	19-20
ER40SPR20-21	ER40	20-21
ER40SPR21-22	ER40	21-22
ER40SPR22-23	ER40	22-23
ER40SPR23-24	ER40	23-24
ER40SPR24-25	ER40	24-25
ER40SPR25-26	ER40	25-26
ER50SPR10-12	ER50	10-12
ER50SPR12-14	ER50	12-14
ER50SPR14-16	ER50	14-16
ER50SPR16-18	ER50	16-18
ER50SPR18-20	ER50	18-20
ER50SPR20-22	ER50	20-22
ER50SPR22-24	ER50	22-24
ER50SPR24-26	ER50	24-26
ER50SPR26-28	ER50	26-28
ER50SPR28-30	ER50	28-30
ER50SPR30-32	ER50	30-32
ER50SPR32-34	ER50	32-34



TUNGHOLD

ER-SPR-AA

AA ultra precision ER spring collet (DIN6499)



ULTRA PRECISION AA

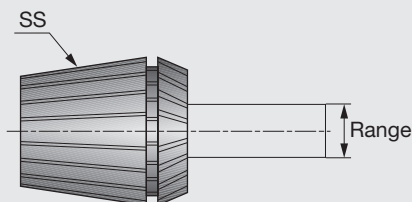

Metric	SS	Range
ER11SPR0.5-1AA	ER11	0.5-1
ER11SPR1-2AA	ER11	1-2
ER11SPR2-3AA	ER11	2-3
ER11SPR3-4AA	ER11	3-4
ER11SPR4-5AA	ER11	4-5
ER11SPR5-6AA	ER11	5-6
ER11SPR6-7AA	ER11	6-7
ER16SPR0.5-1AA	ER16	0.5-1
ER16SPR1-2AA	ER16	1-2
ER16SPR2-3AA	ER16	2-3
ER16SPR3-4AA	ER16	3-4
ER16SPR4-5AA	ER16	4-5
ER16SPR5-6AA	ER16	5-6
ER16SPR6-7AA	ER16	6-7
ER16SPR7-8AA	ER16	7-8
ER16SPR8-9AA	ER16	8-9
ER16SPR9-10AA	ER16	9-10
ER20SPR2-3AA	ER20	2-3
ER20SPR3-4AA	ER20	3-4
ER20SPR4-5AA	ER20	4-5
ER20SPR5-6AA	ER20	5-6
ER20SPR6-7AA	ER20	6-7
ER20SPR7-8AA	ER20	7-8
ER20SPR8-9AA	ER20	8-9
ER20SPR9-10AA	ER20	9-10
ER20SPR1-2AA	ER20	1-2
ER20SPR10-11AA	ER20	10-11
ER20SPR11-12AA	ER20	11-12
ER20SPR12-13AA	ER20	12-13
ER25SPR1-2AA	ER25	1-2
ER25SPR2-3AA	ER25	2-3
ER25SPR3-4AA	ER25	3-4
ER25SPR4-5AA	ER25	4-5
ER25SPR5-6AA	ER25	5-6
ER25SPR6-7AA	ER25	6-7
ER25SPR7-8AA	ER25	7-8
ER25SPR8-9AA	ER25	8-9
ER25SPR9-10AA	ER25	9-10
ER25SPR10-11AA	ER25	10-11
ER25SPR11-12AA	ER25	11-12
ER25SPR12-13AA	ER25	12-13
ER25SPR13-14AA	ER25	13-14
ER25SPR14-15AA	ER25	14-15
ER25SPR15-16AA	ER25	15-16
ER32SPR2-3AA	ER32	2-3
ER32SPR3-4AA	ER32	3-4
ER32SPR4-5AA	ER32	4-5
ER32SPR5-6AA	ER32	5-6
ER32SPR6-7AA	ER32	6-7
ER32SPR7-8AA	ER32	7-8

Metric	SS	Range
ER32SPR8-9AA	ER32	8-9
ER32SPR9-10AA	ER32	9-10
ER32SPR10-11AA	ER32	10-11
ER32SPR11-12AA	ER32	11-12
ER32SPR12-13AA	ER32	12-13
ER32SPR13-14AA	ER32	13-14
ER32SPR14-15AA	ER32	14-15
ER32SPR15-16AA	ER32	15-16
ER32SPR16-17AA	ER32	16-17
ER32SPR17-18AA	ER32	17-18
ER32SPR18-19AA	ER32	18-19
ER32SPR19-20AA	ER32	19-20
ER40SPR3-4AA	ER40	3-4
ER40SPR4-5AA	ER40	4-5
ER40SPR5-6AA	ER40	5-6
ER40SPR6-7AA	ER40	6-7
ER40SPR7-8AA	ER40	7-8
ER40SPR8-9AA	ER40	8-9
ER40SPR9-10AA	ER40	9-10
ER40SPR10-11AA	ER40	10-11
ER40SPR11-12AA	ER40	11-12
ER40SPR12-13AA	ER40	12-13
ER40SPR13-14AA	ER40	13-14
ER40SPR14-15AA	ER40	14-15
ER40SPR15-16AA	ER40	15-16
ER40SPR16-17AA	ER40	16-17
ER40SPR17-18AA	ER40	17-18
ER40SPR18-19AA	ER40	18-19
ER40SPR19-20AA	ER40	19-20
ER40SPR20-21AA	ER40	20-21
ER40SPR21-22AA	ER40	21-22
ER40SPR22-23AA	ER40	22-23
ER40SPR23-24AA	ER40	23-24
ER40SPR24-25AA	ER40	24-25
ER40SPR25-26AA	ER40	25-26

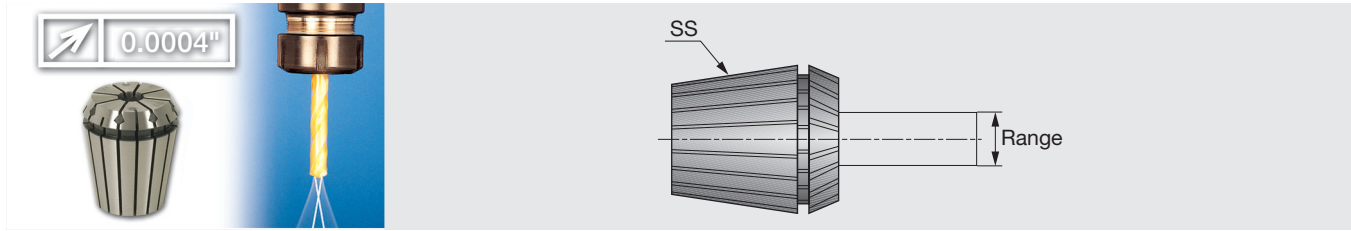

Metric	SS	Range
ER16SEAL3-4	ER16	3-4
ER16SEAL4-5	ER16	4-5
ER16SEAL5-6	ER16	5-6
ER16SEAL6-7	ER16	6-7
ER16SEAL7-8	ER16	7-8
ER16SEAL8-9	ER16	8-9
ER16SEAL9-10	ER16	9-10
ER20SEAL3-4	ER20	3-4
ER20SEAL4-5	ER20	4-5
ER20SEAL5-6	ER20	5-6
ER20SEAL6-7	ER20	6-7
ER20SEAL7-8	ER20	7-8
ER20SEAL8-9	ER20	8-9
ER20SEAL9-10	ER20	9-10
ER20SEAL10-11	ER20	10-11
ER20SEAL11-12	ER20	11-12
ER20SEAL12-13	ER20	12-13
ER25SEAL3-4	ER25	3-4
ER25SEAL4-5	ER25	4-5
ER25SEAL5-6	ER25	5-6
ER25SEAL6-7	ER25	6-7
ER25SEAL7-8	ER25	7-8
ER25SEAL8-9	ER25	8-9
ER25SEAL9-10	ER25	9-10
ER25SEAL10-11	ER25	10-11
ER25SEAL11-12	ER25	11-12
ER25SEAL12-13	ER25	12-13
ER25SEAL13-14	ER25	13-14
ER25SEAL14-15	ER25	14-15
ER25SEAL15-16	ER25	15-16
ER32SEAL3-4	ER32	3-4
ER32SEAL4-5	ER32	4-5
ER32SEAL5-6	ER32	5-6
ER32SEAL6-7	ER32	6-7
ER32SEAL7-8	ER32	7-8
ER32SEAL8-9	ER32	8-9
ER32SEAL9-10	ER32	9-10
ER32SEAL10-11	ER32	10-11
ER32SEAL11-12	ER32	11-12
ER32SEAL12-13	ER32	12-13
ER32SEAL13-14	ER32	13-14
ER32SEAL14-15	ER32	14-15
ER32SEAL15-16	ER32	15-16
ER32SEAL16-17	ER32	16-17
ER32SEAL17-18	ER32	17-18
ER32SEAL18-19	ER32	18-19
ER32SEAL19-20	ER32	19-20
ER40SEAL3-4	ER40	3-4
ER40SEAL4-5	ER40	4-5
ER40SEAL5-6	ER40	5-6

Metric	SS	Range
ER40SEAL6-7	ER40	6-7
ER40SEAL7-8	ER40	7-8
ER40SEAL8-9	ER40	8-9
ER40SEAL9-10	ER40	9-10
ER40SEAL10-11	ER40	10-11
ER40SEAL11-12	ER40	11-12
ER40SEAL12-13	ER40	12-13
ER40SEAL13-14	ER40	13-14
ER40SEAL14-15	ER40	14-15
ER40SEAL15-16	ER40	15-16
ER40SEAL16-17	ER40	16-17
ER40SEAL17-18	ER40	17-18
ER40SEAL18-19	ER40	18-19
ER40SEAL19-20	ER40	19-20
ER40SEAL20-21	ER40	20-21
ER40SEAL21-22	ER40	21-22
ER40SEAL22-23	ER40	22-23
ER40SEAL23-24	ER40	23-24
ER40SEAL24-25	ER40	24-25
ER40SEAL25-26	ER40	25-26



TUNGHOLD

ER-SEAL-JET2

ER COOLIT, sealed spring collet, external coolant supply (DIN6499)

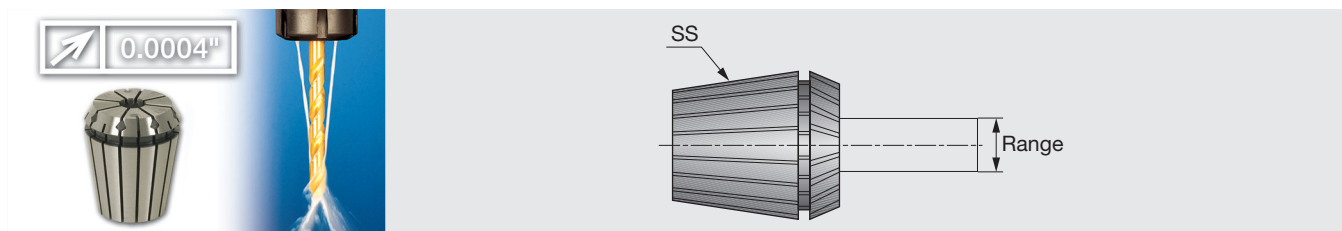

Metric	SS	Range
ER16SEAL3-4JET2	ER16	3-4
ER16SEAL4-5JET2	ER16	4-5
ER16SEAL5-6JET2	ER16	5-6
ER16SEAL6-7JET2	ER16	6-7
ER16SEAL7-8JET2	ER16	7-8
ER16SEAL8-9JET2	ER16	8-9
ER16SEAL9-10JET2	ER16	9-10
ER20SEAL3-4JET2	ER20	3-4
ER20SEAL4-5JET2	ER20	4-5
ER20SEAL5-6JET2	ER20	5-6
ER20SEAL6-7JET2	ER20	6-7
ER20SEAL7-8JET2	ER20	7-8
ER20SEAL8-9JET2	ER20	8-9
ER20SEAL9-10JET2	ER20	9-10
ER20SEAL10-11JET2	ER20	10-11
ER20SEAL11-12JET2	ER20	11-12
ER20SEAL12-13JET2	ER20	12-13
ER25SEAL3-4JET2	ER25	3-4
ER25SEAL4-5JET2	ER25	4-5
ER25SEAL5-6JET2	ER25	5-6
ER25SEAL6-7JET2	ER25	6-7
ER25SEAL7-8JET2	ER25	7-8
ER25SEAL8-9JET2	ER25	8-9
ER25SEAL9-10JET2	ER25	9-10
ER25SEAL10-11JET2	ER25	10-11
ER25SEAL11-12JET2	ER25	11-12
ER25SEAL12-13JET2	ER25	12-13
ER25SEAL13-14JET2	ER25	13-14
ER25SEAL14-15JET2	ER25	14-15
ER25SEAL15-16JET2	ER25	15-16
ER32SEAL3-4JET2	ER32	3-4
ER32SEAL4-5JET2	ER32	4-5
ER32SEAL5-6JET2	ER32	5-6
ER32SEAL6-7JET2	ER32	6-7
ER32SEAL7-8JET2	ER32	7-8
ER32SEAL8-9JET2	ER32	8-9
ER32SEAL9-10JET2	ER32	9-10
ER32SEAL10-11JET2	ER32	10-11
ER32SEAL11-12JET2	ER32	11-12
ER32SEAL12-13JET2	ER32	12-13
ER32SEAL13-14JET2	ER32	13-14
ER32SEAL14-15JET2	ER32	14-15
ER32SEAL15-16JET2	ER32	15-16
ER32SEAL16-17JET2	ER32	16-17
ER32SEAL17-18JET2	ER32	17-18
ER32SEAL18-19JET2	ER32	18-19
ER32SEAL19-20JET2	ER32	19-20
ER40SEAL3-4JET2	ER40	3-4
ER40SEAL4-5JET2	ER40	4-5
ER40SEAL5-6JET2	ER40	5-6

Metric	SS	Range
ER40SEAL6-7JET2	ER40	6-7
ER40SEAL7-8JET2	ER40	7-8
ER40SEAL8-9JET2	ER40	8-9
ER40SEAL9-10JET2	ER40	9-10
ER40SEAL10-11JET2	ER40	10-11
ER40SEAL11-12JET2	ER40	11-12
ER40SEAL12-13JET2	ER40	12-13
ER40SEAL13-14JET2	ER40	13-14
ER40SEAL14-15JET2	ER40	14-15
ER40SEAL15-16JET2	ER40	15-16
ER40SEAL16-17JET2	ER40	16-17
ER40SEAL17-18JET2	ER40	17-18
ER40SEAL18-19JET2	ER40	18-19
ER40SEAL19-20JET2	ER40	19-20
ER40SEAL20-21JET2	ER40	20-21
ER40SEAL21-22JET2	ER40	21-22
ER40SEAL22-23JET2	ER40	22-23
ER40SEAL23-24JET2	ER40	23-24
ER40SEAL24-25JET2	ER40	24-25
ER40SEAL25-26JET2	ER40	25-26

TUNGHOLD

SET ER-SPR

Set of ER spring collets (DIN6499)



Metric	Collet size	Qty	Range
SETER11SPR7	ER11	7	0.5-7
SETER16SPR10	ER16	10	0.5-10
SETER20SPR12	ER20	12	1-13
SETER25SPR15	ER25	15	1-16
SETER32SPR18	ER32	18	2-20
SETER40SPR23	ER40	23	3-26
SETER50SPR12	ER50	12	10-34

TUNGHOLD

SET ER-SPR-AA

Set of AA ultra precision ER spring collets (DIN6499)



Metric	Collet size	Qty	Range
SETER11SPR7AA	ER11	7	0.5-7
SETER16SPR10AA	ER16	10	0.5-10
SETER20SPR12AA	ER20	12	1-13
SETER25SPR15AA	ER25	15	1-16
SETER32SPR18AA	ER32	18	2-20
SETER40SPR23AA	ER40	23	3-26

TUNGHOLD

SET ER-SEAL

Set of ER spring collets, for internal coolant supply (DIN6499)

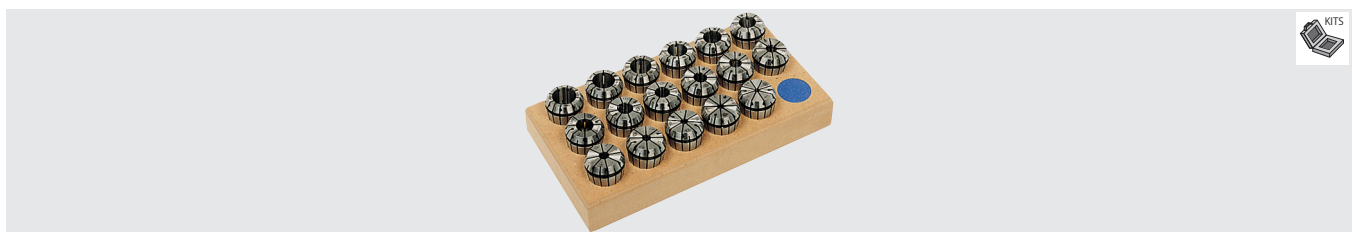

Metric	Collet size	Qty	Range
SETER16SEAL7	ER16	7	3-10
SETER20SEAL10	ER20	10	3-13
SETER25SEAL13	ER25	13	3-16
SETER32SEAL17	ER32	17	3-20
SETER40SEAL23	ER40	23	3-26

Grade

Insert

Ext. Toolholder

Int. Toolholder

Threading

Grooving

Miniature Tool

Milling Cutter

Endmill

Drilling Tool

Tooling System

User's Guide

Index



TUNGHOLD**SET ER-SEAL-JET2**

Set of ER spring collets, for external coolant supply (DIN6499)

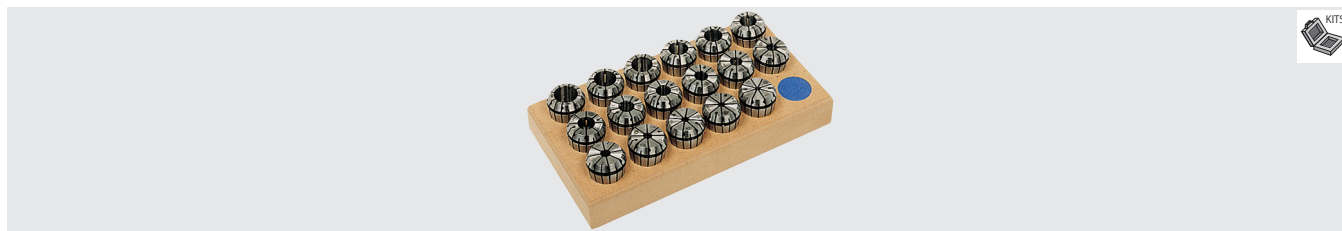

Metric	Collet size	Qty	Range
SETER16SEAL7JET2	ER16	7	3-13
SETER25SEAL13JET2	ER25	13	3-20
SETER32SEAL17JET2	ER32	17	3-26
SETER40SEAL23JET2	ER40	23	3-26

TUNGHOLD**SET ER SPR-EM**

Set of ER spring collets, for endmills (DIN6499)



Metric	Collet size	Qty	Range
SETER16SPR8EM	ER16	8	3,4,5,6,7,8,9,10
SETER20SPR5EM	ER20	5	4,6,8,10,12
SETER25SPR6EM	ER25	6	4,6,8,10,12,16
SETER32SPR6EM	ER32	6	6,8,10,12,16,20
SETER40SPR7EM	ER40	7	6,8,10,12,16,20,25

Contains popular endmill sizes only.

TUNGHOLD**SET-ER SEAL-EM**

Set of ER spring collets, for internal coolant supply, for endmills (DIN6499)

Metric	Collet size	Qty	Range
SETER16SEAL5EM	ER16	5	4,5,6,8,10
SETER20SEAL5EM	ER20	5	4,6,8,10,12
SETER25SEAL6EM	ER25	6	4,6,8,10,12,16
SETER32SEAL6EM	ER32	6	6,8,10,12,16,20
SETER40SEAL7EM	ER40	7	6,8,10,12,16,20,25

Contains popular endmill sizes only.

TUNGHOLD

SET ER-SEAL-EM JET2

Set of ER spring collets, for external coolant supply, for endmills (DIN6499)

Metric	Collet size	Qty	Range
SETER25SEAL6EMJET2	ER25	6	4,6,8,10,12,16
SETER32SEAL6EMJET2	ER32	6	6,8,10,12,16,20
SETER40SEAL7EMJET2	ER40	7	6,8,10,12,16,20,25

Contains popular endmill sizes only.

TUNGHOLD

KIT R-8-ER

Kit for ER collet chuck and spring collets (R-8 Bridgeport)



Metric	Collet size	Qty	Range
KITR-810ER16	ER16	10	0.5-10
KITR-818ER32	ER32	18	2-20

Each kit has one collet chuck, a full set of ER collets, and a wrench.

TUNGHOLD

KIT DIN2080-ER

Kit for ER collet chuck and spring collets (DIN2080)



Metric	Collet size	Qty	Range
KITDIN20803018ER32	ER32	18	2-20
KITDIN20804018ER32	ER32	18	2-20
KITDIN20804023ER40	ER40	23	3-26
KITDIN20805023ER40	ER40	23	3-26

Each kit has one collet chuck, a full set of ER collets, and a wrench.

Grade

Insert

Ext. Toolholder

Int. Toolholder

Threading

Grooving

Miniature Tool

Milling Cutter

Endmill

Drilling Tool

Tooling System

User's Guide

Index

A
B
C
D
E
F
G
H
I
J
K
L
M

TUNGHOLD

KIT MT-ER

Kit for ER collet chuck and spring collets (Morse taper)



Metric	Collet size	Qty	Range
KITMT318ER32	ER32	18	2-20
KITMT423ER40	ER40	23	3-26

Each kit has one collet chuck, a full set of ER collets, and a wrench.

TUNGHOLD

KIT ST-ER-Mini

Kit for ER Mini collet chuck and spring collets (cylindrical shank)



Metric	Collet size	Qty	Range
KITST12X807ER11M	ER11	7	0.5-7
KITST12X8010ER16M	ER16	10	0.5-10
KITST16X507ER11MF	ER11	7	0.5-7
KITST16X1007ER11M	ER11	7	0.5-7
KITST16X1507ER11M	ER11	7	0.5-7
KITST20X10010ER16M	ER16	10	0.5-10
KITST20X15010ER16M	ER16	10	0.5-10
KITST20X10012ER20M	ER20	12	1-12
KITST20X15012ER20M	ER20	12	1-12

Each kit contains one collet chuck, a full set of ER collets and a wrench. F indicates a flat on the shank.

TUNGHOLD

KIT ST-ER

Kit for ER collet chuck and spring collets (cylindrical shank)



Metric	Collet size	Qty	Range
KITST16X507ER11F	ER11	7	0.5-7
KITST20X1007ER11	ER11	7	0.5-7
KITST20X1507ER11	ER11	7	0.5-7
KITST20X5010ER16F	ER16	10	0.5-10
KITST20X10010ER16	ER16	10	0.5-10
KITST20X15010ER16	ER16	10	0.5-10
KITST20X5012ER20F	ER20	12	1-12
KITST25X10012ER20	ER20	12	1-12

Each kit contains one collet chuck, a full set of ER collets and a wrench. F indicates a flat on the shank.

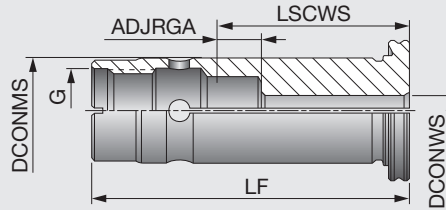

Inch	DCONWS	DCONMS	LF	LSCWS	ADJRGA	G
SC3/4SPR1/4	0.250	0.750	2.362	1.378	0.276	M16
SC3/4SPR5/16	0.313	0.750	2.362	1.378	0.276	M16
SC3/4SPR3/8	0.375	0.750	2.362	1.890	0.512	M16
SC3/4SPR7/16	0.438	0.750	2.362	1.417	0.315	M16
SC3/4SPR1/2	0.500	0.750	2.362	1.378	0.276	M16
SC3/4SPR5/8	0.625	0.750	2.362	1.897	0.354	M16
SC1-1/4SPR1/4	0.250	1.250	2.835	1.791	0.689	M2.4X1.5
SC1-1/4SPR5/16	0.313	1.250	2.835	1.791	0.689	M2.4X1.5
SC1-1/4SPR3/8	0.375	1.250	2.835	1.791	0.413	M2.4X1.5
SC1-1/4SPR1/2	0.500	1.250	2.835	1.792	0.217	M2.4X1.5
SC1-1/4SPR5/8	0.625	1.250	2.835	2.441	0.709	M2.4X1.5
SC1-1/4SPR3/4	0.750	1.250	2.835	2.441	0.630	M2.4X1.5
SC1-1/4SPR7/8	0.875	1.250	2.835	2.422	0.453	M2.4X1.5
SC1-1/4SPR1	1.000	1.250	2.835	2.417	0.409	M2.4X1.5

Metric	DCONWS	DCONMS	LF	LSCWS	ADJRGA	G
SC20SPR6	6	20	60	35	7	M16
SC20SPR8	8	20	60	35	7	M16
SC20SPR10	10	20	60	48	13	M16
SC20SPR12	12	20	60	48	8	M16
SC20SPR14	14	20	60	48	8	M16
SC20SPR15	15	20	60	48	8	M16
SC20SPR16	16	20	60	48	9	M16
SC32SPR6	6	32	72	45	17	M24X1.5
SC32SPR8	8	32	72	45	17	M24X1.5
SC32SPR10	10	32	72	48	13	M24X1.5
SC32SPR12	12	32	72	45	5	M24X1.5
SC32SPR14	14	32	72	45	5	M24X1.5
SC32SPR15	15	32	72	59.5	19.5	M24X1.5
SC32SPR16	16	32	72	61.5	17.5	M24X1.5
SC32SPR18	18	32	72	61.5	17.5	M24X1.5
SC32SPR19	19	32	72	61.5	17.5	M24X1.5
SC32SPR20	20	32	72	61.5	15.5	M24X1.5
SC32SPR24	24	32	72	55.5	10.5	M24X1.5
SC32SPR25	25	32	72	61.5	10.5	M24X1.5

Grade
Insert
Toolholder
Ext. Toolholder
Int. Toolholder
Threading
Grooving
Miniature Tool
Milling Cutter
Endmill
Drilling Tool
Tooling System
User's Guide
Index



TUNGMAX

SC-SEAL

Sealed collet

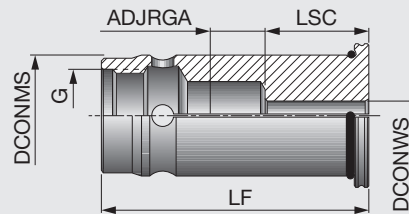

Inch	DCONWS	DCONMS	LF	LSC	ADJRGA	G
SC3/4SEAL1/4	0.250	0.750	2.362	1.102	0.276	M16
SC3/4SEAL5/16	0.313	0.750	2.362	1.102	0.276	M16
SC3/4SEAL3/8	0.375	0.750	2.362	1.378	0.512	M16
SC3/4SEAL7/16	0.438	0.750	2.362	1.575	0.315	M16
SC3/4SEAL1/2	0.500	0.750	2.362	1.575	0.315	M16
SC3/4SEAL5/8	0.625	0.750	2.362	1.543	0.354	M16
SC1-1/4SEAL1/4	0.250	1.250	2.835	1.102	0.689	M2.4X1.5
SC1-1/4SEAL5/16	0.313	1.250	2.835	1.102	0.689	M2.4X1.5
SC1-1/4SEAL3/8	0.375	1.250	2.835	1.378	0.413	M2.4X1.5
SC1-1/4SEAL1/2	0.500	1.250	2.835	1.575	0.217	M2.4X1.5
SC1-1/4SEAL5/8	0.625	1.250	2.835	1.732	0.709	M2.4X1.5
SC1-1/4SEAL3/4	0.750	1.250	2.835	1.811	0.63	M2.4X1.5
SC1-1/4SEAL7/8	0.875	1.250	2.835	1.969	0.453	M2.4X1.5
SC1-1/4SEAL1	1.000	1.250	2.835	2.008	0.453	M2.4X1.5

Metric	DCONWS	DCONMS	LF	LSC	ADJRGA	G
SC20SEAL6	6	20	60	28	7	M16
SC20SEAL8	8	20	60	28	7	M16
SC20SEAL10	10	20	60	35	13	M16
SC20SEAL12	12	20	60	40	8	M16
SC20SEAL14	14	20	60	40	8	M16
SC20SEAL15	15	20	60	40	8	M16
SC20SEAL16	16	20	60	39	9	M16
SC32SEAL6	6	32	72	28	17	M24X1.5
SC32SEAL8	8	32	72	28	17	M24X1.5
SC32SEAL10	10	32	72	35	13	M24X1.5
SC32SEAL12	12	32	72	40	5	M24X1.5
SC32SEAL14	14	32	72	40	5	M24X1.5
SC32SEAL15	15	32	72	40	5	M24X1.5
SC32SEAL16	16	32	72	44	17.5	M24X1.5
SC32SEAL18	18	32	72	44	17.5	M24X1.5
SC32SEAL19	19	32	72	44	17.5	M24X1.5
SC32SEAL20	20	32	72	46	15.5	M24X1.5
SC32SEAL24	24	32	72	46	15.5	M24X1.5
SC32SEAL25	25	32	72	51	10.5	M24X1.5

TUNGMAX

PRESET SC-CAP

Preset screw housing for SC-SPR collets

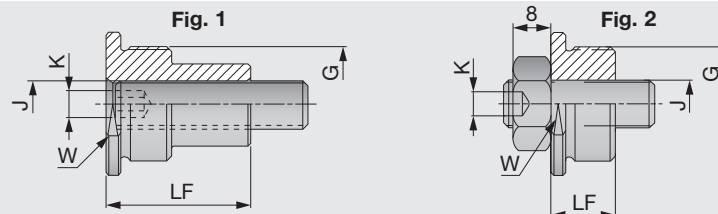

Metric	LF	W	J	G	Fig.	Range	Key size K	Collet size
PRESETSCCAP8X1.25L	28	16	M8X25	M16	1	6-8	4	SC20
PRESETSCCAP8X1.25	15	16	M8X25	M16	2	10-16	4	SC20
PRESETSCCAP10X1.5L	30	27	M10X30	M24X1.5	1	6-14	5	SC32
PRESETSCCAP10X1.5	13.5	27	M10X30	M24X1.5	2	16-25	5	SC32

TUNGHYDRO

KIT CAT-HYDRO

Kit for hydraulic chucks (MAS-CAT Form A/B)



Inch	CAT size	DCONWS	Qty	Range
KITCAT40HYDRO20X73	40	20	5	8,10,12,14,16
KITCAT40HYDRO32X110	40	32	7	6,8,10,12,16,20,25

Each kit has one HYDROFIT chuck, a set of SC...HYDRO sealed reducers and a clamping wrench.

(Unit: mm)

TUNGHYDRO

KIT DIN69871-HYDRO

Kit for hydraulic chucks (DIN69871)



Metric	SK size	DCONWS	Qty	Range
KITDIN6987140HYDRO20X65	40	20	5	8,10,12,14,16
KITDIN6987140HYDRO32X117	40	32	7	6,8,10,12,16,20,25

Each kit has one HYDROFIT chuck, a set of SC...HYDRO sealed reducers and a clamping wrench.

TUNGHYDRO

KIT HSK A-HYDRO

Kit for hydraulic chucks (HSK)



Metric	HSK size	DCONWS	Qty	Range
KITHSKA63HYDRO20X100	63	20	5	8,10,12,14,16
KITHSKA63HYDRO32X125	63	32	7	6,8,10,12,16,20,25

Each kit has one HYDROFIT chuck, a set of SC...HYDRO sealed reducers and a clamping wrench.

Grade

Insert

Ext. Toolholder

Int. Toolholder

Threading

Grooving

Miniature Tool

Milling Cutter

Endmill

Drilling Tool

Tooling System

User's Guide

Index

TUNGHYDRO

SC-HYDRO

Sealed reduction sleeve for hydraulic chucks

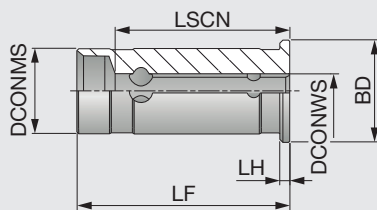

Inch	DCONMS	DCONWS	LSCN	LF	BD	LH
SC3/4SHYDRO1/8	0.750	0.125	1.180	1.965	0.945	0.080
SC3/4SHYDRO1/4	0.750	0.250	1.180	1.965	0.945	0.080
SC3/4SHYDRO5/16	0.750	0.313	1.180	1.965	0.945	0.080
SC3/4SHYDRO3/8	0.750	0.375	1.180	1.965	0.945	0.080
SC3/4SHYDRO1/2	0.750	0.500	1.450	1.965	0.945	0.080
SC3/4SHYDRO5/8	0.750	0.625	1.450	1.965	0.945	0.080
SC1-1/4SHYDRO1/4	1.250	0.250	0.980	2.598	1.400	0.160
SC1-1/4SHYDRO5/16	1.250	0.313	0.980	2.598	1.400	0.160
SC1-1/4SHYDRO3/8	1.250	0.375	0.980	2.598	1.400	0.160
SC1-1/4SHYDRO1/2	1.250	0.500	1.380	2.598	1.400	0.160
SC1-1/4SHYDRO5/8	1.250	0.625	1.380	2.598	1.400	0.160
SC1-1/4SHYDRO3/4	1.250	0.750	1.970	2.598	1.400	0.160
SC1-1/4SHYDRO1"	1.250	1.000	2.600	2.598	1.400	0.160

Metric	DCONMS	DCONWS	LSCN	LF	BD	LH
SC12SHYDRO3	12	3	19	46.5	16	2
SC12SHYDRO4	12	4	24	46.5	16	2
SC12SHYDRO5	12	5	28	46.5	16	2
SC12SHYDRO6	12	6	33	46.5	16	2
SC12SHYDRO8	12	8	39	46.5	16	2
SC20SHYDRO3	20	3	20	53	24	2
SC20SHYDRO4	20	4	25	53	24	2
SC20SHYDRO5	20	5	27	53	24	2
SC20SHYDRO6	20	6	34	53	24	2
SC20SHYDRO8	20	8	39	53	24	2
SC20SHYDRO10	20	10	40	53	24	2
SC20SHYDRO12	20	12	41	53	24	2
SC20SHYDRO14	20	14	44	53	24	2
SC20SHYDRO16	20	16	44	53	24	2
SC25SHYDRO6	25	6	37	60	30	4
SC25SHYDRO8	25	8	37	60	30	4
SC25SHYDRO10	25	10	40	60	30	4
SC25SHYDRO12	25	12	44	60	30	4
SC25SHYDRO14	25	14	46	60	30	4
SC25SHYDRO16	25	16	48	60	30	4
SC25SHYDRO18	25	18	50	60	30	4
SC25SHYDRO20	25	20	50	60	30	4
SC32SHYDRO6	32	6	33	66	40	4
SC32SHYDRO8	32	8	38	66	40	4
SC32SHYDRO10	32	10	39	66	40	4
SC32SHYDRO12	32	12	42	66	40	4
SC32SHYDRO14	32	14	44	66	40	4
SC32SHYDRO16	32	16	44	66	40	4
SC32SHYDRO18	32	18	44	66	40	4
SC32SHYDRO20	32	20	49	66	40	4
SC32SHYDRO25	32	25	66	66	40	4

TUNGHYDRO

PRESET SCREW HYDRO

Preset screw for hydraulic collet chucks

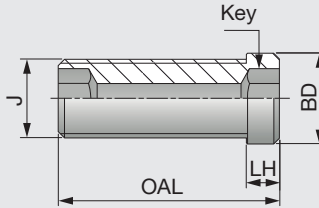

Metric	BD	J	OAL	LH	Wrench
PRESETSCREWHYDROM5	5	M5	14	1	2.5
PRESETSCREWHYDROM6	6	M6	14	1.5	3
PRESETSCREWHYDROM8	8	M8X1	14	2	4
PRESETSCREWHYDROM10	10	M10X1	17	2	5
PRESETSCREWHYDROM16	14	M16X1	20	2	8

TUNGHYDRO

TEST BAR HYDRO

Torque test bar for hydraulic chucks

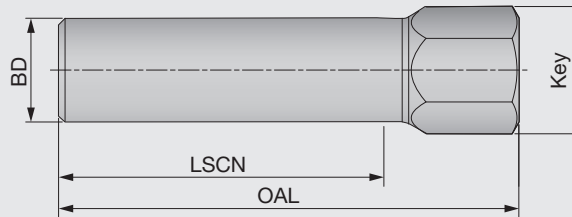

Metric	BD	OAL	Wrench	LSCN ⁽¹⁾	Torque
TESTBARHYDRO6	6	53	10	27	15
TESTBARHYDRO8	8	53	10	27	25
TESTBARHYDRO10	10	56	10	32	50
TESTBARHYDRO12	12	62	10	37	110
TESTBARHYDRO14	14	62	10	37	120
TESTBARHYDRO16	16	71	17	37	180
TESTBARHYDRO18	18	71	17	42	230
TESTBARHYDRO20	20	71	17	42	250
TESTBARHYDRO25	25	79	17	48	310
TESTBARHYDRO32	32	87	17	52	450

(1) Minimum holding length
Torque: Recommended clamping torque: N·m

Grade
Insert
Toolholder
Ext. Toolholder
Int. Toolholder
Threading
Grooving
Miniature Tool
Milling Cutter
Endmill
Drilling Tool
Tooling System
User's Guide
Index



TUNGMAX**SET SC-SPR**

Set of SC collets



Metric	Collet size	Qty	Range
SETSC20SPR6	20	6	6,8,10,12,14,16
SETSC32SPR9	32	9	6,8,10,12,14,16,18,20,25

TUNGMAX**SET SC-SEAL**

Set of SC collets with coolant hole



Metric	Collet size	Qty	Range
SETSC20SEAL6	20	6	6,8,10,12,14,16
SETSC32SEAL9	32	9	6,8,10,12,14,16,18,20,25

TUNGFLEX**ER-ODP**

Threaded connector for ER collet chucks

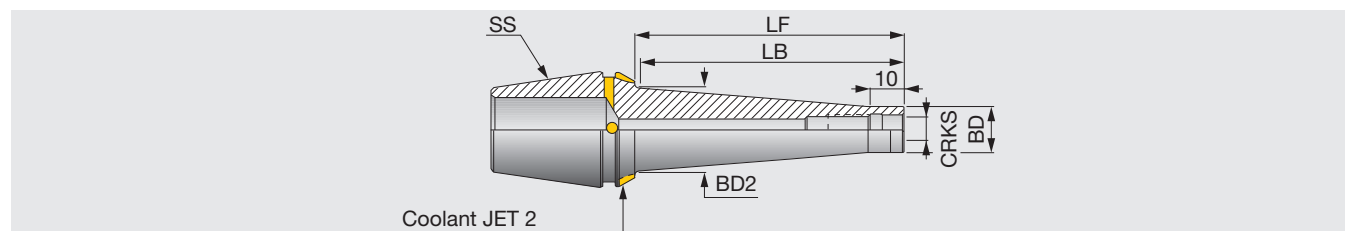

Metric	CRKS	SS	BD	BD2	LF	LB
ER32ODPM6X25	M6	ER32	9.8	14	25	22
ER32ODPM6X50	M6	ER32	9.8	20	50	48
ER32ODPM6X75	M6	ER32	9.8	23	75	74
ER32ODPM8X25	M8	ER32	13.1	15	25	22
ER32ODPM8X50	M8	ER32	13.1	23	50	49
ER32ODPM8X75	M8	ER32	13.1	23	75	74
ER32ODPM10X25	M10	ER32	18	20	25	23
ER32ODPM10X50	M10	ER32	18	24	50	49
ER32ODPM12X25	M12	ER32	21	24	25	24
ER32ODPM12X50	M12	ER32	21	24	50	49

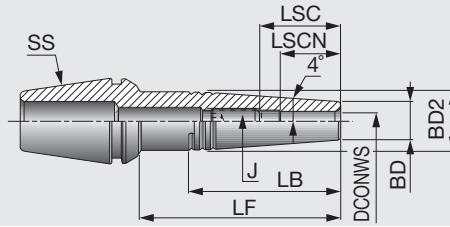

Inch	SS	DCONWS	BD	BD2	LF	LB	LSCN	LSC	J	Wrench
ER20SRK1/8X1.500	ER20	0.125	0.394	0.53	1.5	0.97	0.39	0.63	M6	0.118
ER20SRK1/8X2.500	ER20	0.125	0.394	0.53	2.5	0.97	0.39	0.63	M6	0.118
ER25SRK1/8X1.500	ER25	0.125	0.394	0.55	1.5	1.11	0.39	0.63	M6	0.118
ER25SRK1/8X2.500	ER25	0.125	0.394	0.63	2.5	1.71	0.39	0.63	M6	0.118
ER32SRK1/8X1.500	ER32	0.125	0.394	0.55	1.5	1.1	0.39	0.63	M6	0.118
ER32SRK1/8X2.500	ER32	0.125	0.394	0.68	2.5	2.0	0.39	0.63	M6	0.118
ER32SRK1/8X3.500	ER32	0.125	0.394	0.82	3.5	3.0	0.39	0.63	M6	0.118
ER20SRK3/16X2.500	ER20	0.187	0.394	0.53	2.5	0.97	0.59	0.83	M6	0.118
ER20SRK3/16X1.500	ER20	0.187	0.394	0.53	1.5	0.97	0.59	0.83	M6	0.118
ER25SRK3/16X1.500	ER25	0.187	0.394	0.55	1.5	1.11	0.59	0.83	M6	0.118
ER25SRK3/16X2.500	ER25	0.187	0.394	0.63	2.5	1.71	0.59	0.83	M6	0.118
ER32SRK3/16X1.500	ER32	0.187	0.394	0.55	1.5	1.11	0.59	0.83	M6	0.118
ER32SRK3/16X2.500	ER32	0.187	0.394	0.66	2.5	1.9	0.59	0.83	M6	0.118
ER32SRK3/16X3.500	ER32	0.187	0.394	0.80	3.5	2.9	0.59	0.83	M6	0.118
ER20SRK1/4X1.500	ER20	0.25	0.433	0.59	1.5	1.14	0.71	0.95	M8	0.157
ER20SRK1/4X2.500	ER20	0.25	0.433	0.62	2.5	1.31	0.71	0.95	M8	0.157
ER25SRK1/4X1.500	ER25	0.25	0.433	0.59	1.5	1.14	0.71	0.95	M8	0.157
ER25SRK1/4X2.500	ER25	0.25	0.433	0.70	2.5	1.9	0.71	0.95	M8	0.157
ER32SRK1/4X1.500	ER32	0.25	0.433	0.59	1.5	1.14	0.71	0.95	M8	0.157
ER32SRK1/4X2.500	ER32	0.25	0.433	0.7	2.5	1.91	0.71	0.97	M8	0.157
ER32SRK1/4X3.500	ER32	0.25	0.433	0.84	3.5	2.9	0.71	1.02	M8	0.157
ER32SRK5/16X1.500	ER32	0.313	0.551	0.76	1.5	1.44	0.98	1.22	M10	0.197
ER32SRK5/16X2.500	ER32	0.313	0.551	0.82	2.5	1.91	0.98	1.22	M10	0.197
ER32SRK5/16X3.500	ER32	0.313	0.551	0.93	3.5	2.71	0.98	1.22	M10	0.197
ER25SRK5/16X1.500	ER25	0.313	0.551	0.71	1.5	1.08	0.98	1.22	M10	0.197
ER25SRK5/16X2.500	ER25	0.313	0.551	0.79	2.5	1.71	0.98	1.22	M10	0.197
ER32SRK3/8X1.500	ER32	0.375	0.629	0.84	1.5	1.46	1.18	1.38	M12	0.236
ER32SRK3/8X2.500	ER32	0.375	0.629	0.90	2.5	1.9	1.18	1.42	M12	0.236
ER32SRK3/8X3.500	ER32	0.375	0.629	0.93	3.5	2.12	1.18	1.42	M12	0.236
ER32SRK7/16X1.500	ER32	0.437	0.787	0.94	1.5	1.11	1.22	1.42	M14	0.236
ER32SRK7/16X2.500	ER32	0.437	0.787	0.94	2.5	1.11	1.22	1.46	M14	0.236
ER32SRK7/16X3.500	ER32	0.437	0.787	0.94	3.5	1.11	1.22	1.46	M14	0.236
ER32SRK1/2X1.500	ER32	0.500	0.787	0.94	1.5	1.1	1.26	1.46	M14	0.236
ER32SRK1/2X2.500	ER32	0.500	0.787	0.94	2.5	1.1	1.26	1.5	M14	0.236
ER32SRK1/2X3.500	ER32	0.500	0.787	0.94	3.5	1.41	1.26	1.5	M14	0.236

TUNGSHRINK**ER-SRK JET2**

TungShrink, ER collet type, for external coolant supply

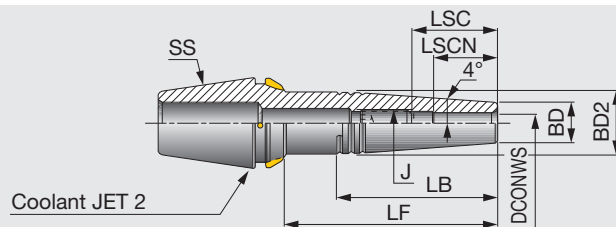

Metric	SS	DCONWS	BD	BD2	LF	LB	LSCN	LSC	J	Wrench
ER20SRK3X35JET2	ER20	3	10	13.5	35	24.5	10	16	M6	3
ER20SRK5X35JET2	ER20	5	10	13.5	35	24.5	15	21	M6	3
ER20SRK6X35JET2	ER20	6	11	14.7	35	25.5	18	24	M8	4
ER25SRK3X35JET2	ER25	3	10	13.5	35	24.5	10	16	M6	3
ER25SRK3X60JET2	ER25	3	10	16.3	60	44.5	10	16	M6	3
ER25SRK4X35JET2	ER25	4	10	13.5	35	24.5	12	18	M6	3
ER25SRK4X60JET2	ER25	4	10	16.3	60	44.5	12	18	M6	3
ER25SRK5X35JET2	ER25	5	10	13.5	35	24.5	15	21	M6	3
ER25SRK5X60JET2	ER25	5	10	16.3	60	44.5	15	21	M6	3
ER25SRK6X35JET2	ER25	6	11	14.7	35	26	18	24	M8	4
ER25SRK6X60JET2	ER25	6	11	17.3	60	44.5	18	24	M8	4
ER25SRK8X35JET2	ER25	8	14	17.8	35	26.5	25	30	M10	5
ER25SRK8X60JET2	ER25	8	14	19.7	60	39.5	25	31	M10	5
ER32SRK3X35JET2	ER32	3	10	13.2	35	22.5	10	16	M6	3
ER32SRK3X60JET2	ER32	3	10	16.3	60	44.5	10	16	M6	3
ER32SRK3X85JET2	ER32	3	10	19.8	85	70	10	16	M6	3
ER32SRK4X35JET2	ER32	4	10	13.4	35	23.5	12	18	M6	3
ER32SRK4X60JET2	ER32	4	10	16.3	60	44.5	12	18	M6	3
ER32SRK4X85JET2	ER32	4	10	19.8	85	70	12	18	M6	3
ER32SRK5X35JET2	ER32	5	10	13.5	35	24.5	15	21	M6	3
ER32SRK5X60JET2	ER32	5	10	16.3	60	44.5	15	21	M6	3
ER32SRK5X85JET2	ER32	5	10	19.8	85	70	15	21	M6	3
ER32SRK6X35JET2	ER32	6	11	14.7	35	25.5	18	24	M8	4
ER32SRK6X60JET2	ER32	6	11	17.3	60	45	18	24	M8	4
ER32SRK6X85JET2	ER32	6	11	20.8	85	69.5	18	26	M8	4
ER32SRK8X35JET2	ER32	8	14	18.8	35	33	25	31	M10	5
ER32SRK8X60JET2	ER32	8	14	20.4	60	45	25	31	M10	5
ER32SRK8X85JET2	ER32	8	14	23.2	85	65	25	31	M10	5
ER32SRK10X35JET2	ER32	10	16	20.8	35	34	30	35	M12	6
ER32SRK10X60JET2	ER32	10	16	22.4	60	44.5	30	36	M12	6
ER32SRK10X85JET2	ER32	10	16	23	85	49.5	30	36	M12	6
ER32SRK12X35JET2	ER32	12	20	24	35	28	32	-	-	-
ER32SRK12X60JET2	ER32	12	20	24	60	28	32	38	M14	6
ER32SRK12X85JET2	ER32	12	20	24	85	28	32	38	M14	6

TUNGSHRINK

IND SHRINKIN UNIT

SHRINKIN Induction heating unit for shrink tool chucking



Inch

IND SHRINK IN UNIT USA

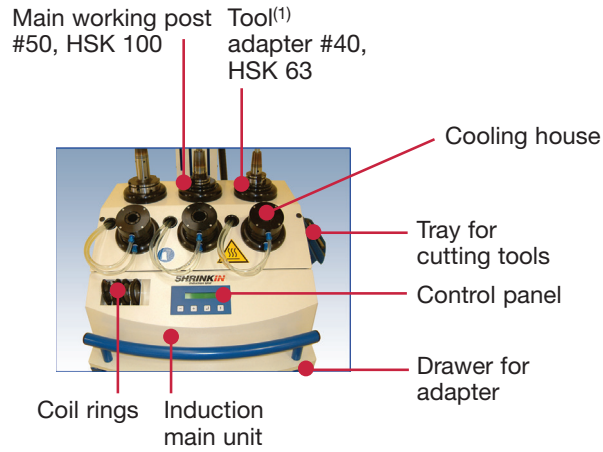

Machine

3-380-500V 50/60HZ

TUNGSHRINK

IND SHRINK START UNIT

SHRINKIN Induction heating unit for shrink tool chucking



Inch

IND SHRINK START UNIT USA

Machine

3-380-500V 50/60HZ

TUNGSHRINK

SHRINKIN UNIT V2

SHRINKIN Induction heating unit for shrink tool chucking

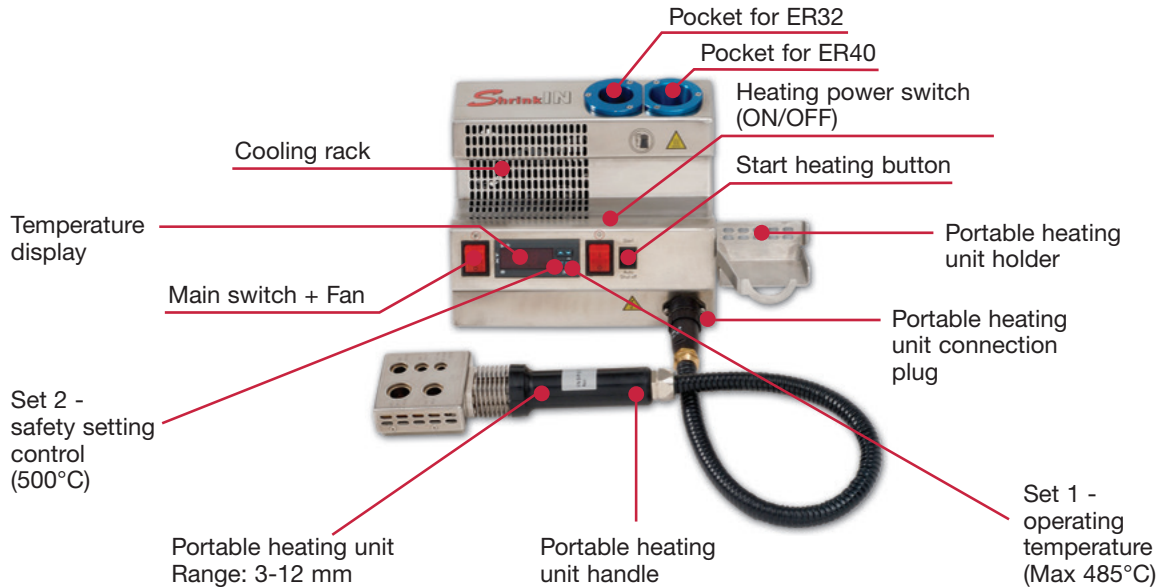

Inch

SHRINKIN UNIT V2 USA

Machine

220V 50/60HZ

Grade
Insert
Toolholder
Ext. Toolholder
Int. Toolholder
Threading
Grooving
Tool
Miniature Tool
Milling Cutter
Endmill
Drilling Tool
Tooling System
User's Guide
Index



TUNGSHRINK

SET ER-SRK

Set of ER collets with thermal shrink chucks



Inch	Collet size	Qty	Range
SETER32SRKS6USA	32	6	0.187, 0.25, 0.312, 0.375, 0.437, 0.5
SETER32SRKM6USA	32	6	0.187, 0.25, 0.312, 0.375, 0.437, 0.5
SETER32SRKL6USA	32	6	0.187, 0.25, 0.312, 0.375, 0.437, 0.5

SC

Sleeve for C-ABB adapter

Fig. A

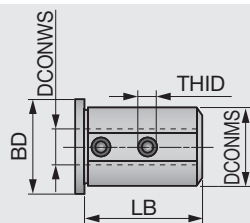
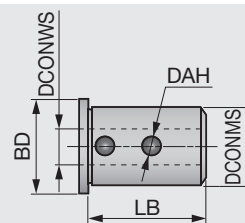
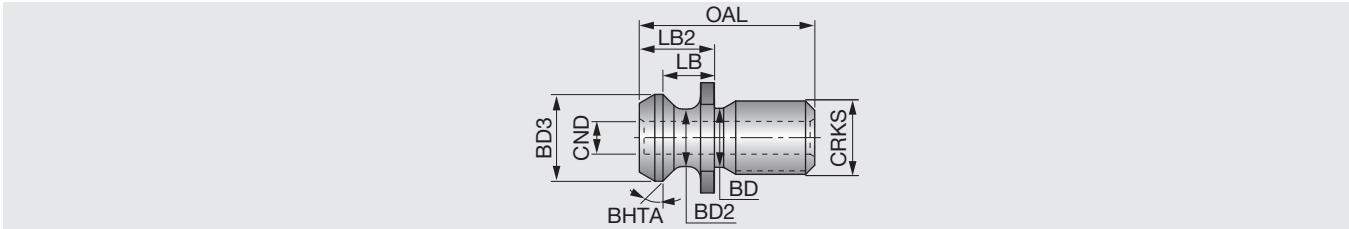

Fig. B



Inch	DCONMS	DCONWS	BD	LB	THID	DAH	Fig.
SC1-1/2T.250A	1.5	0.25	1.811	2.283	M6	-	A
SC1-1/2T.375A	1.5	0.375	1.811	2.283	M8	-	A
SC1-1/2T.500A	1.5	0.5	1.811	2.283	M9	-	A
SC1-1/2T.625B	1.5	0.625	1.811	2.283	-	0.591	B
SC1-1/2T.750B	1.5	0.75	1.811	2.283	-	0.591	B
SC1-1/2T1.000B	1.5	1	1.811	2.283	-	0.591	B



Inch	CRKS	BD3	BD2	BD	CND	LB	OAL	LB2	BHTA
PSCAT40455/8ANSI	5/8-11	0.74	0.49	0.49	-	0.439	1.5	0.64	45°
PSCAT40455/8ANSIB	5/8-11	0.74	0.49	0.49	0.28	0.439	1.5	0.64	45°
PSCAT50451ANSIB	1-8	1.14	0.82	0.82	0.315	0.703	2.3	1	45°
PSCAT50451ANSI	1-8	1.14	0.82	0.82	-	0.703	2.3	1	45°

Coolant holes only in items with a "B" suffix.

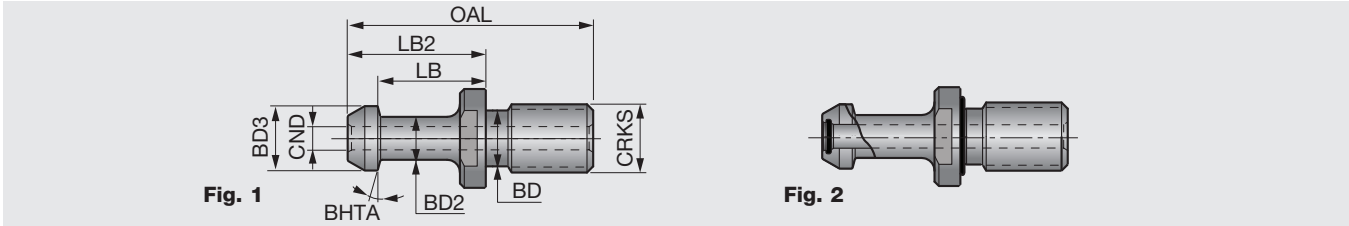

Inch	CRKS	BD3	BD2	BD	CND	LB	OAL	LB2	BHTA	Fig
PSCAT4045M16MAS1	M16	0.606	0.394	0.512	0.217	0.995	2.25	1.274	45°	1
PSCAT4045M16MAS1B	M16	0.606	0.394	0.512	0.217	0.995	2.25	1.274	45°	1
PSCAT40455/8MAS1	5/8-11	0.59	0.39	0.512	-	0.99	2.25	1.266	45°	1
PSCAT40455/8MAS1B	5/8-11	0.59	0.39	0.512	0.217	0.99	2.25	1.266	45°	1
PSCAT40605/8MAS2	5/8-11	0.59	0.39	0.512	-	0.99	2.25	1.266	60°	1
PSCAT40605/8MAS2B	5/8-11	0.59	0.39	0.512	0.217	0.99	2.25	1.266	60°	1
PSCAT40905/8MAS3	5/8-11	0.59	0.39	0.512	-	0.99	2.25	1.266	90°	1
PSCAT40905/8MAS3B	5/8-11	0.59	0.39	0.512	0.217	0.99	2.25	1.266	90°	1
PSCAT50451"MAS1	1-8	0.906	0.67	0.827	-	1.378	3.346	1.772	45°	1
PSCAT50451"MAS1B	1-8	0.906	0.67	0.827	0.236	1.378	3.346	1.772	45°	1
PSCAT50451"MAS1OBO	1-8	0.906	0.67	0.827	0.236	1.378	3.346	1.772	45°	2
PSCAT50601"MAS2	1-8	0.906	0.67	0.827	-	1.378	3.346	1.772	60°	1
PSCAT50601"MAS2B	1-8	0.906	0.67	0.827	0.236	1.378	3.346	1.772	60°	1
PSCAT50901"MAS3	1-8	0.906	0.67	0.827	-	1.378	3.346	1.772	90°	1
PSCAT50901"MAS3B	1-8	0.906	0.67	0.827	0.236	1.378	3.346	1.772	90°	1

Fig 1: Coolant holes only in items with a "B" suffix.

Fig 2: With external and internal O-rings.

TUNGHOLD

NUT ER-TOP

Nut for ER collet chucks (DIN6499)

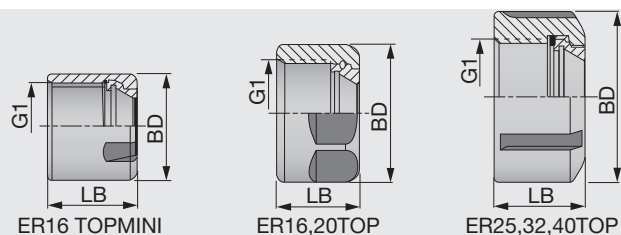

Metric	BD	LB	G1	Torque
NUTER16TOP	28	17	M22X1.5	68.7
NUTER20TOP	34	19	M25X1.5	117.7
NUTER25TOP	42	20	M32X1.5	196.1
NUTER32TOP	50	22	M40X1.5	215.7
NUTER40TOP	63	25	M50X1.5	245.1

Torque: Recommended clamping torque: N·m

TUNGHOLD

NUT ER-UM/MINI

UM/Mini nut for ER collet chucks (DIN6499)

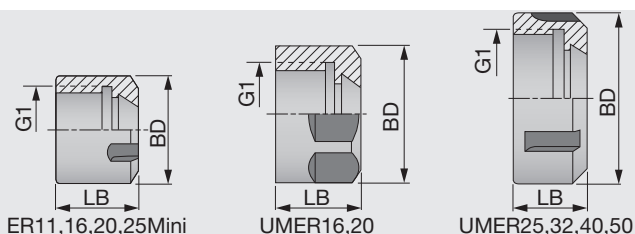

Metric	BD	LB	G1	Torque
NUTER11GHS ⁽¹⁾	16	11.5	M13X0.75	-
NUTER11MINI	16	10.8	M13X0.75	29.4
NUTER11UM	19	11.3	M14X0.75	49
NUTER16MINI	22	18	M19X1.0	39.2
NUTER16UM	28	17	M22X1.5	68.7
NUTER20MINI	28	19	M24X1.0	78.5
NUTER20UM	34	19	M25X1.5	117.7
NUTER25MINI	35	20	M30X1.0	98
NUTER25UM	42	20	M32X1.5	196.1
NUTER32UM	50	22	M40X1.5	215.7
NUTER40UM	63	25	M50X1.5	245.1
NUTER50UM	78	35	M64X2.0	343.2

(1) To be used only for SpinJet spindles

Torque: Recommended clamping torque: N·m

TUNGBALANCE

NUT ER-BALANCE

Balanceable nut for ER collet chucks (DIN6499)

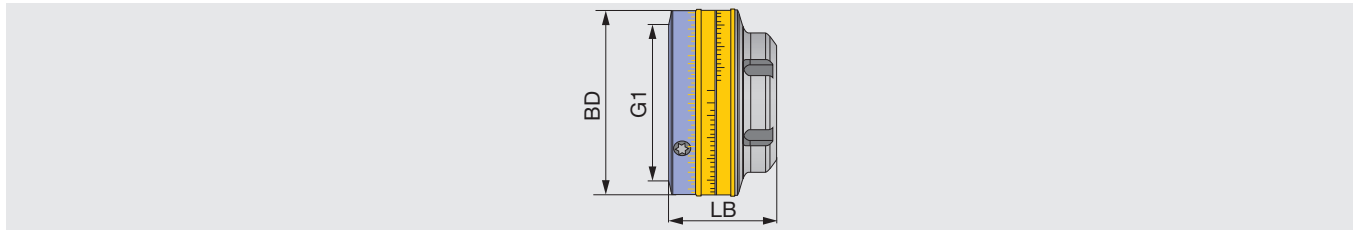

Metric	BD	LB	G1	Torque
NUTER16TOPBIN	36	44	M22X1.5	68.7
NUTER25TOPBIN	37.5	58	M32X1.5	196.1

Torque: Recommended clamping torque: N·m

TUNGSHORT

NUT ER-SHORT

Nut for ER collet chucks (TungShort)

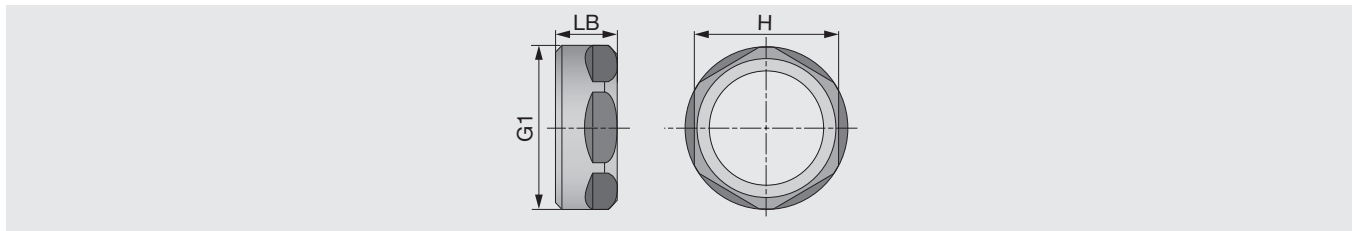

Metric	H	LB	G1	Torque
NUTER20SHORT	22	10.7	M25X1.5	117.7
NUTER32SHORT	36	15	M40X1.5	215.7
NUTER40SHORT	46	16	M50X1.5	245.1

Torque: Recommended clamping torque: N·m

Grade
Insert
Ext. Toolholder
Int. Toolholder
Threading
Grooving
Miniature Tool
Milling Cutter
Endmill
Drilling Tool
Tooling System
User's Guide
Index



TUNGHOLD

WRENCH ER

Wrench for ER nut (DIN6499)

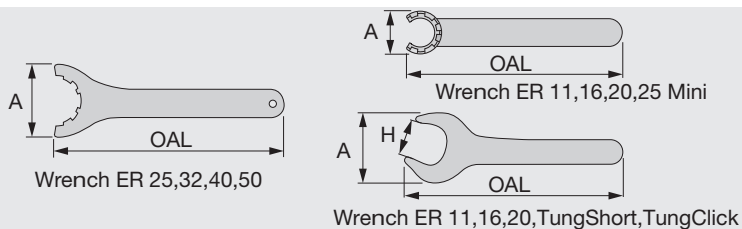

Metric	A	H	OAL
WRENCHER11SMS ⁽¹⁾	16	-	95
WRENCHER11MINI	16.8	-	95
WRENCHER11	32	17	95
WRENCHER16MINI	22.5	-	117
WRENCHER16	42.5	25	143
WRENCHER20MINI	28	-	128
WRENCHER20	53.5	30	172
WRENCHER25MINI	29	-	120
WRENCHER25	70	-	207
WRENCHER32	78	-	255
WRENCHER40	95	-	285
WRENCHER50	110	-	350
WRENCHER20SHORTRING22	48	22	260
WRENCHER32SHORT	75	36	303
WRENCHER40SHORT	94	46	378
WRENCHER32CLICKIN27	57	27	239
WRENCHER32CLICKIN32	67	32	273

(1) Use SpinJet spindle only.

TUNGMAX

WRENCH

Wrench for TungMax collets

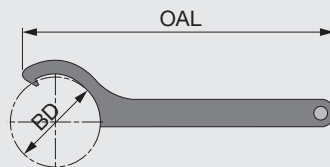

Metric	BD	OAL
WRENCHMAXIN20HOOK	26	205
WRENCHMAXIN32HOOK	68	240

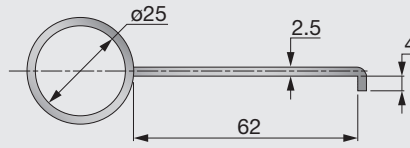

Metric

EXTRACTOR SC COLLETS

TUNG HOLD

PRESET ER-JET

Preset screw for ER collet chucks

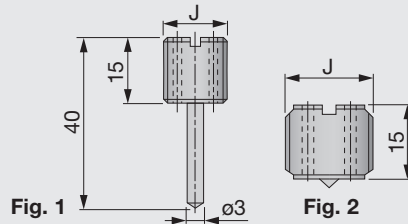

Metric	J	Fig.
PRESETER-JET8X1	M8X1.0	2
PRESETER-JET8X1.25	M8X1.25	2
PRESETER-JET10X1.5	M10X1.5	2
PRESETER-JET12X1	M12X1.0	2
PRESETER-JET12X1.75L	M12X1.75	1
PRESETER-JET12X1.75	M12X1.75	2
PRESETER-JET14X1	M14X1.0	2
PRESETER-JET16X2	M16X2	2
PRESETER-JET16X2L	M16X2	1
PRESETER-JET18X1	M18X1.0	2
PRESETER-JET18X1.5	M18X1.5	2
PRESETER-JET18X1.5L	M18X1.5	1
PRESETER-JET22X1.5	M22X1.5	2
PRESETER-JET22X1.5L	M22X1.5	1
PRESETER-JET28X1.5	M28X1.5	2

TUNGMAX**Preset Screw**

Preset screw for SC-SPR

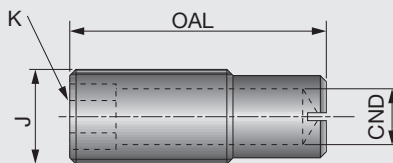

Metric	J	OAL	CND	K
PRESETMAXIN16X30	M16	30	8	8
PRESETMAXIN16X44	M16	44	8	8
PRESETMAXIN20X55	M20	55	12	12

TUNGHOLD**SCREW-SEM**

Lock screw for shell mill holders

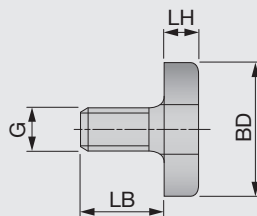

Metric	G	BD	LH	LB
M8CLAMPSCREWSEM16	M8	20	6	16
M10CLAMPSCREWSEM22	M10	28	7	18
M12CLAMPSCREWSEM27	M12	35	8	22
M16CLAMPSCREWSEM32	M16	42	9	26
M20CLAMPSCREWSEM40	M20	52	10	30
M24CLAMPSCREWSEM50	M24	63	12	36

STANDARD CENTER BOLT

Inch	G	BD	LH	LB	Torque
SCREW1/4-28SEM1/2	1/4-28 UNF-2A	0.65	0.315	0.709	6
SCREW3/8-24SEM3/4	3/8-24 UNF-2A	0.886	0.394	0.709	25
SCREW1/2-20SEM1	1/2-20 UNF-2A	1.181	0.472	0.874	50
SCREW5/8-18SEM1-1/4	5/8-18 UNF-2A	1.496	0.512	1.000	75
SCREW3/4-16SEM1-1/2	3/4-16 UNF-2A	1.87	0.512	1.161	100
SCREW1-14SEM2	1-14 UNS-2A	2.48	0.512	1.25	110

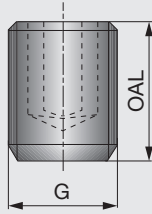

Metric	G	OAL	Applicable shank diameter
SRM6X10DIN1835B	M6	10	6
SRM8X10DIN1835-B	M8	10	8
SRM10X12DIN1835-B	M10	12	10
SRM12X16DIN1835-B	M12	16	12,14
SRM14X16DIN1835-B	M14	16	14,16
SRM16X16DIN1835-B	M16	16	20
SRM18X2X20DIN1835-B	M18X2	20	25,32
SRM20X2X20DIN1835-B	M20X2	20	40
SRM24X2X25DIN1835-B	M24X2	25	50
SRM16X10.3EMSHORT	M16	10.3	20
SRM18X2X10EMSHORT	M18X2	10	2

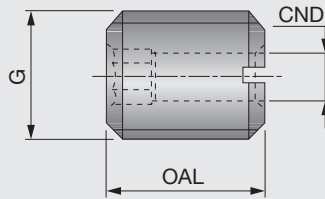

Metric	G	OAL	CND	Applicable shank	Wrench
PRESETSCREWM6X20B	M6X1	20	2.5	EME/SRKIN	3
PRESETSCREWM8X20B	M8X1.25	20	3.5	EME/SRKIN	4
PRESETSCREWM10X18B	M10X1.5	18	4.5	EME/SRKIN	5
PRESETSCREWM12X18B	M12X1.75	18	5.5	EME/SRKIN	6
PRESETSCREWM16X20B	M16X2	20	7.5	EME/SRKIN	6
PRESETSCREWM16X25B	M16X2	25	7.5	SRKIN	6

TUNGHOLD

WRENCH SEMC

Wrench for face mill and shell mill combination type holders (DIN6368)

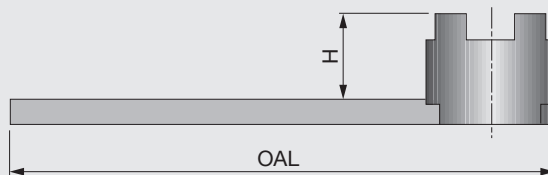

Metric	Clamping bore dia.	G	H	OAL
WRENCHM8SEMC16	16	M8	20	180
WRENCHM10SEMC22	22	M10	25	200
WRENCHM12SEMC27	25.4,27	M12	32	225
WRENCHM16SEMC32	31.75,32	M16	36	250
WRENCHM20SEMC40	38.1,40	M20	40	280
WRENCHM24SEMC50	50,50.8	M24	50	315

TUNGHOLD

DRIVING RING SEMC

Driving ring for face mill and shell mill combination type holders (DIN6366/1)

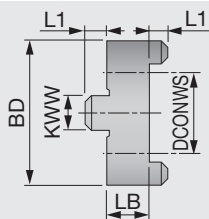

Metric	DCONWS	BD	LB	L1	KWW
16D.RINGSEMC	16	32	10	8	5
22D.RINGSEMC	22	40	12	10	6
27D.RINGSEMC	27	48	12	12	6.3
32D.RINGSEMC	32	58	14	14	7
40D.RINGSEMC	40	70	14	16	8
50D.RINGSEMC	50	90	16	18	9

Should be used with WRENCH SEMC.

TUNGHOLD

COOLING TUBE-HSK

Cooling tube for HSK shank

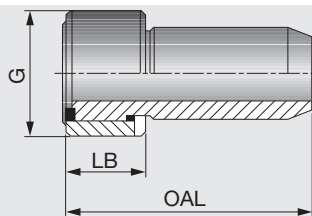

Metric	HSK size	OAL	LB	G
COOLINGTUBEHSKA40	40	29.1	7.5	M12X1
COOLINGTUBEHSKA50	50	32.7	9.5	M16X1
COOLINGTUBEHSKA63	63	36	11.5	M18X1
COOLINGTUBEHSKA80	80	36.6	13.5	M20X1.5
COOLINGTUBEHSKA100	100	43.6	15.5	M24X1.5

TUNGHOLD

WRENCH

Wrench for HSK cooling tube

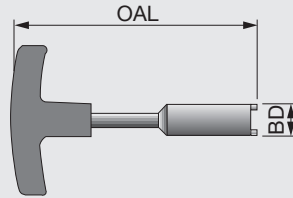

Metric	HSK size	BD	OAL
WRENCHCOOLTUBEHSK40	40	11	120
WRENCHCOOLTUBEHSK50	50	15	120
WRENCHCOOLTUBEHSK63	63	17	122
WRENCHCOOLTUBEHSK80	80	18.5	186
WRENCHCOOLTUBEHSK100	100	22	141

TUNGHOLD

TOOL CLAMP

Tool clamp fixture for ISO, DIN69871, and BT MAS-403 BT shanks

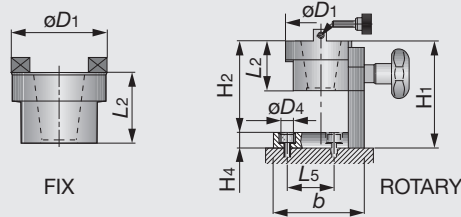

Metric	CSI	ϕD_1	L_2	H_1	H_2	H_4	b	L_5	ϕD_4
TOOLCLAMP30ROTARY	ROTARY	70	56	128	109	19	104	40	12.5
TOOLCLAMP40ROTARY	ROTARY	82	56	128	109	19	104	40	12.5
TOOLCLAMP50ROTARY	ROTARY	103	71	170	151	19	144	85	12.5
TOOLCLAMP30FIX	FIX	82	58	-	-	-	-	-	-
TOOLCLAMP40FIX	FIX	82	58	-	-	-	-	-	-
TOOLCLAMP50FIX	FIX	103	71	-	-	-	-	-	-

TUNGHOLD

MULTI CLAMP (HSK)

Multi-clamp rotary fixture for HSK shank

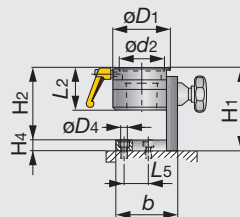

Metric	CSI	ϕd_2	ϕD_1	L_2	H_1	H_2	H_4	b	L_5	ϕD_4
MULTICLAMP32E/F	HSK A/C50	32	113.2	70	133	114	19	144	40	12.5
MULTICLAMP40E/F	HSK A/C63	40	113.2	70	133	114	19	144	40	12.5
MULTICLAMP63E/F	HSK E/F32	63	113.2	70	133	114	19	144	40	12.5
MULTICLAMP50A/C	HSK E/F40	50	82	72	142	123	19	104	40	12.5
MULTICLAMP63A/C	HSK E/F50	63	95	72	142	123	19	104	40	12.5
MULTICLAMP100A/C	HSK E/F63	100	130	90	178	159	19	144	85	12.5

Grade
Insert
Ext. Toolholder
Int. Toolholder
Threading
Grooving
Miniature Tool
Milling Cutter
Endmill
Drilling Tool
Tooling System
User's Guide
Index



SPINJET

TJS-ER32

Coolant driven high speed compact spindle for ER32 collet chuck

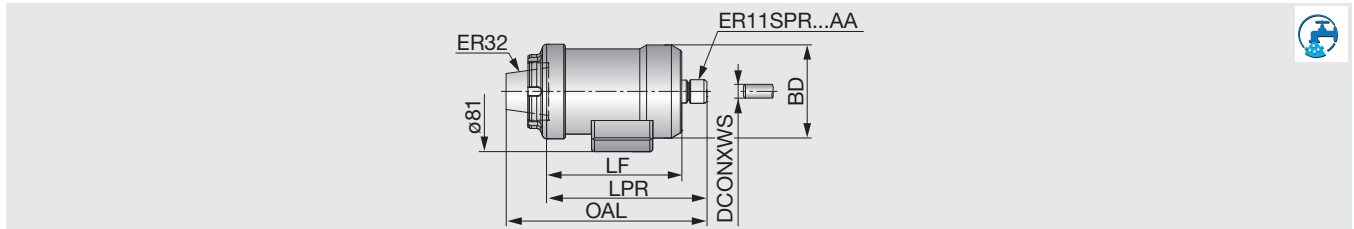

Metric	LF	LPR	OAL	BD	DCONXWS ⁽¹⁾	WT(kg)
TJSGJETER32	92	109	136	63	7	1.3

Coolant pressure through machine spindle: Min. 2 MPa / Max. 4 MPa

Min. flow rate: 12 l/min

(1) Max. tool shank diameter: ø7 mm

SPARE PARTS



Designation	Nut	Wrench for nut	Shaft lock key	Display (Optional)
TJSGJETER32	NUTER11GHS	WRENCHER11SMS	TJSSHAFTLOCKKEYGJET	TJSTSDDISPLAY***

SPINJET

TJS-HSK A63

Coolant driven high speed compact spindle with HSK A63 shank

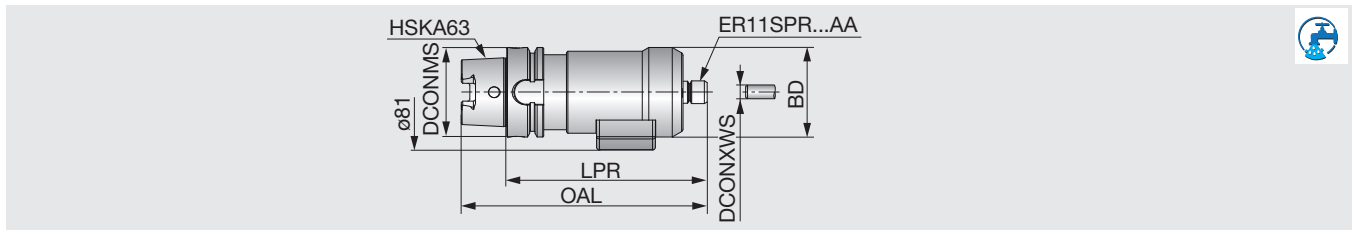

Metric	DCONMS	LPR	OAL	BD	DCONXWS ⁽¹⁾	WT(kg)
TJSGJETHSKA63	63	141	173	63	7	1.8

Coolant pressure through machine spindle: Min. 2 MPa / Max. 4 MPa

Min. flow rate: 12 l/min

(1) Max. tool shank diameter: ø7 mm

SPARE PARTS



Designation	Nut	Wrench for nut	Shaft lock key	Display (Optional)
TJSGJETHSKA63	NUTER11GHS	WRENCHER11SMS	TJSSHAFTLOCKKEYGJET	TJSTSDDISPLAY***

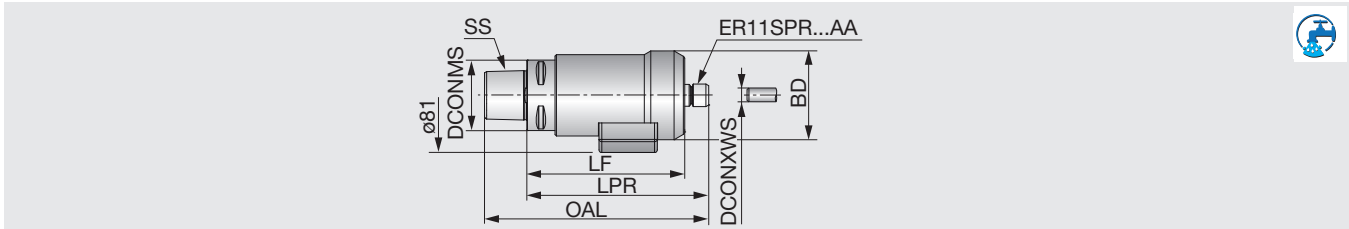

Metric	SS	DCONMS	LF	LPR	OAL	BD	DCONXWS ⁽¹⁾	WT(kg)
TJSGJETC5	C5	50	112	129	159	63	7	1.5
TJSGJETC6	C6	63	102	119	157	63	7	1.6

Coolant pressure through machine spindle: Min. 2 MPa / Max. 4 MPa
 Min. flow rate: 12 l/min
 (1) Max. tool shank diameter: ø7 mm

SPARE PARTS

Designation	Nut	Wrench for nut	Shaft lock key	Display (Optional)
TJSGJETC...	NUTER11GHS	WRENCHER11SMS	TJSSHAFTLOCKKEYGJET	TJSTSDDISPLAY***

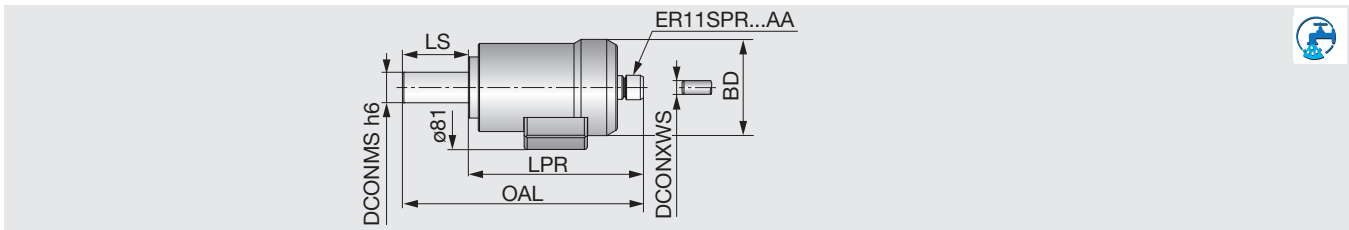

Metric	DCONMS	LS	LPR	OAL	BD	DCONXWS ⁽¹⁾	WT(kg)
TJSGJETST20	20	43	115	158	63	7	1.2

Coolant pressure through machine spindle: Min. 2 MPa / Max. 4 MPa
 Min. flow rate: 12 l/min
 (1) Max. tool shank diameter: ø7 mm

SPARE PARTS

Designation	Nut	Wrench for nut	Shaft lock key	Display (Optional)
TJSGJETST20	NUTER11GHS	WRENCHER11SMS	TJSSHAFTLOCKKEYGJET	TJSTSDDISPLAY***



SPINJET

TJS-CAT

Coolant driven high speed compact spindle with CAT shank

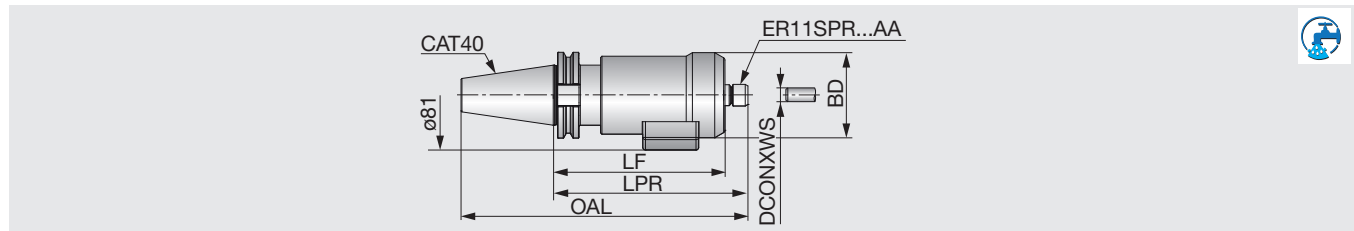

Metric	LF	LPR	OAL	BD	DCONXWS ⁽¹⁾	WT(kg)
TJSGJETCAT40	127	144	212	63	7	2

Coolant pressure through machine spindle: Min. 2 MPa / Max. 4 MPa

Min. flow rate: 12 l/min

(1) Max. tool shank diameter: ø7 mm

SPARE PARTS

Designation	Nut	Wrench for nut	Shaft lock key	Display (Optional)
TJSGJETCAT40	NUTER11GHS	WRENCHER11SMS	TJSSHAFTLOCKKEYGJET	TJSTSDDISPLAY***

SPINJET

Wireless RPM speed display

RPM speed display (SpinJet)

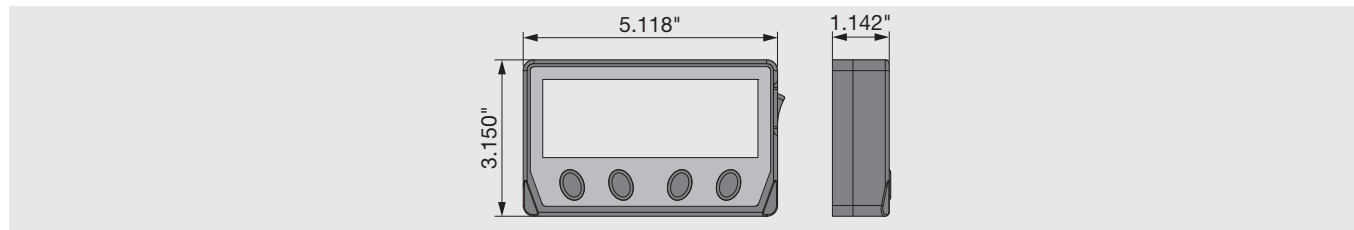

Inch	Adaptive product
TJSTSDDISPLAYUSA (for the United States and Japan)	TJS spindles

Including plug adapter

- Plug adapter for wireless RPM speed display

Type	TJSTSDDISPLAYUSA
Designation	TJSDISP.POWERSUPP-USA
Appearance	 <p>Plug adapter for the United States and Japan</p>

Plug adapter is also sold separately.

New and old product comparison table

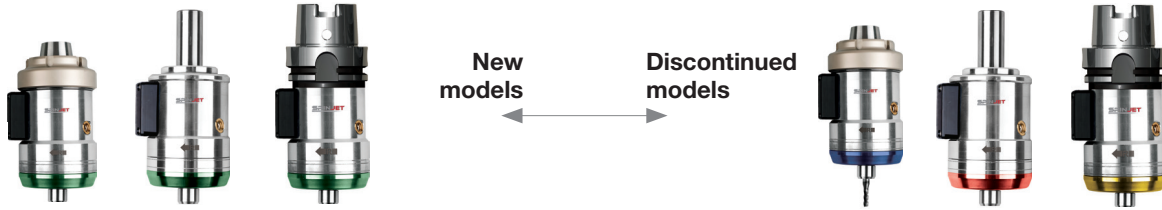

Alternative designation	Discontinued designation	Alternative designation	Discontinued designation
-	TJS20KBT30L	-	TJS40KC6L
TJSGJETBT30	TJS20KBT30R	TJSGJETC6	TJS40KC6R
-	TJS30KBT30L	-	TJS20KER32L
TJSGJETBT30	TJS30KBT30R	TJSGJETER32	TJS20KER32R
-	TJS40KBT30L	-	TJS30KER32L
TJSGJETBT30	TJS40KBT30R	TJSGJETER32	TJS30KER32R
-	TJS20KBT40L	-	TJS40KER32L
TJSGJETBT40	TJS20KBT40R	TJSGJETER32	TJS40KER32R
-	TJS30KBT40L	-	TJS20KHSKA63L
TJSGJETBT40	TJS30KBT40R	TJSGJETHSKA63	TJS20KHSKA63R
-	TJS40KBT40L	-	TJS30KHSKA63L
TJSGJETBT40	TJS40KBT40R	TJSGJETHSKA63	TJS30KHSKA63R
-	TJS20KCAT40L	-	TJS40KHSKA63L
TJSGJETCAT40	TJS20KCAT40R	TJSGJETHSKA63	TJS40KHSKA63R
-	TJS30KCAT40L	-	TJS20KDIN698714
TJSGJETCAT40	TJS30KCAT40R	-	TJS20KDIN6987140R
-	TJS40KCAT40L	-	TJS30KDIN698714
TJSGJETCAT40	TJS40KCAT40R	-	TJS30KDIN6987140R
-	TJS20KC5L	-	TJS40KDIN698714
TJSGJETC5	TJS20KC5R	-	TJS40KDIN6987140R
-	TJS30KC5L	-	TJS20KST20L
TJSGJETC5	TJS30KC5R	TJSGJETST20	TJS20KST20R
-	TJS40KC5L	-	TJS30KST20L
TJSGJETC5	TJS40KC5R	TJSGJETST20	TJS30KST20R
-	TJS20KC6L	-	TJS40KST20L
TJSGJETC6	TJS20KC6R	TJSGJETST20	TJS40KST20R
-	TJS30KC6L	-	-
TJSGJETC6	TJS30KC6R	-	-

As of December 28, 2018, all orders for discontinued models are not accepted. As of December 31, 2020, all services and support including repairs and spare part sales will end.

Grade
Insert
Toolholder
Ext. Toolholder
Int. Toolholder
Threading
Grooving
Tool
Miniature Tool
Milling Cutter
Endmill
Drilling Tool
Tooling System
User's Guide
Index



ER-SRK Shrink collet adapter

ER11 shrink collet adapter for induction heating device

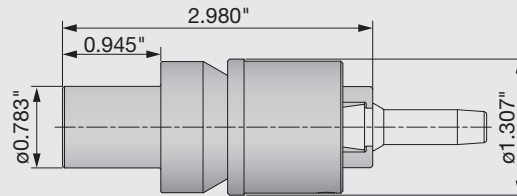

Inch

INDER11TOOLADAPTER

Adaptive product

TJS spindles

SPINJET

ER-SRK Shrink collet

ER11 shrink collet for induction heating device

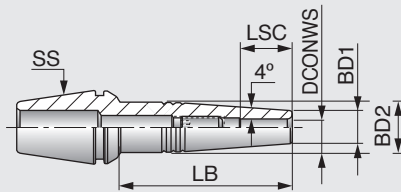

Metric	SS	DCONWS	LB	LSC	BD2	BD1
ER11SRK3X10	ER11	3	10	9.5	8.5	7.6
ER11SRK3X25	ER11	3	25	11.5	8.5	7.6
ER11SRK4X10	ER11	4	10	9.5	8.5	7.6
ER11SRK4X25	ER11	4	25	11.5	8.5	7.6

For carbide tools only

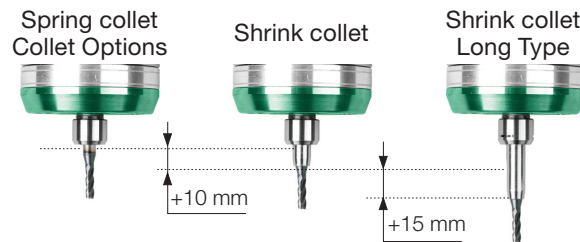

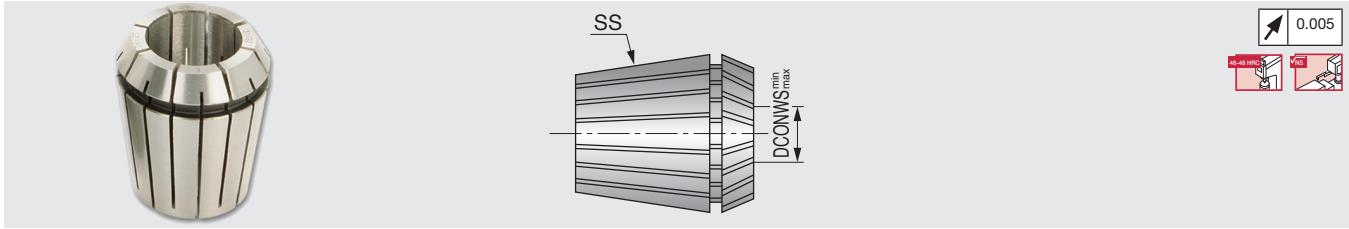

Metric	SS	DCONWS min	DCONWS max
ER11SPR0.5-1AA	ER11	0.5	1
ER11SPR1-2AA	ER11	1	2
ER11SPR2-3AA	ER11	2	3
ER11SPR3-4AA	ER11	3	4
ER11SPR4-5AA	ER11	4	5
ER11SPR5-6AA	ER11	5	6
ER11SPR6-7AA	ER11	6	7

AA collet run-out: 0.005 mm

Nut and wrench for collets

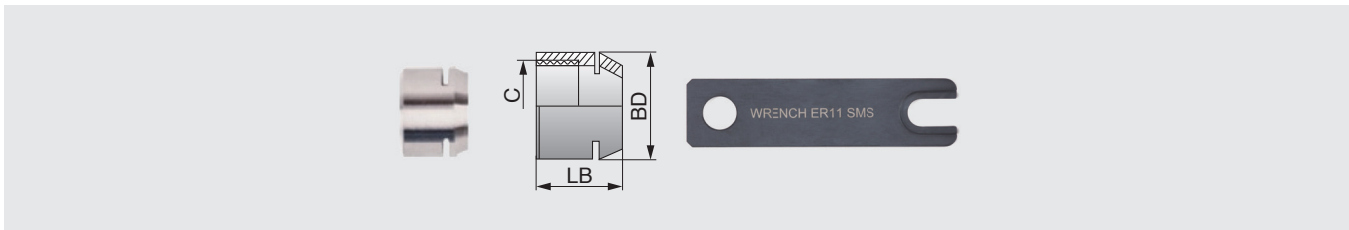

Metric	BD	LB	C	Wrench for nut
NUTER11GHS	16	11.5	M13X0.75	WRENCHER11SMS

Shaft lock key



Metric
TJSSHAFTLOCKKEYGJET

Wide range of variation quick change system

DIN69871A/D

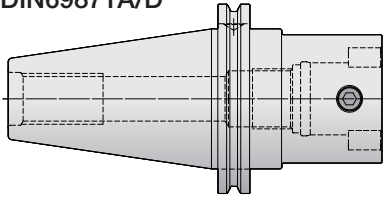

ANSI B5.50(CAT)

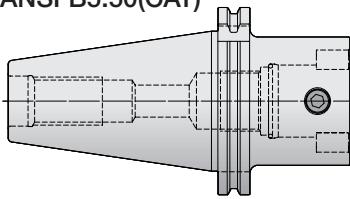

MAS-BT

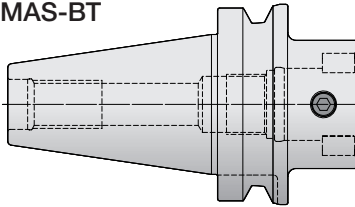

DIN69893(HSK A)

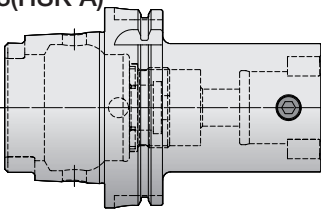

ISO26623-1(PSC)

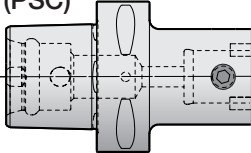

SK50 BT50

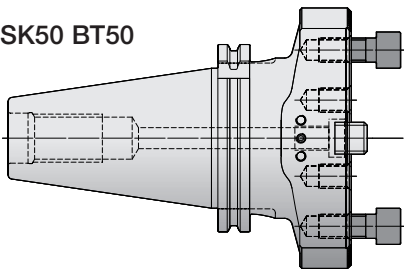

HSK-A100

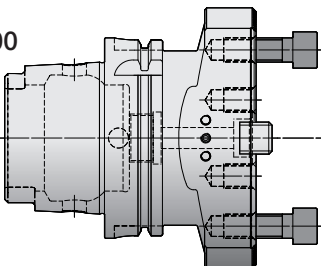

Reduction

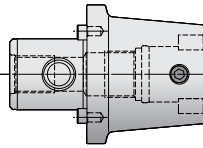

Extension

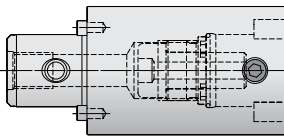

Bridge adapter

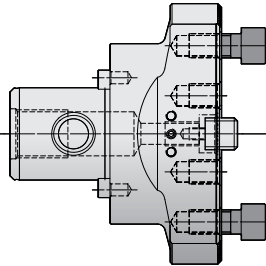

Twin cutter
Boring head 444

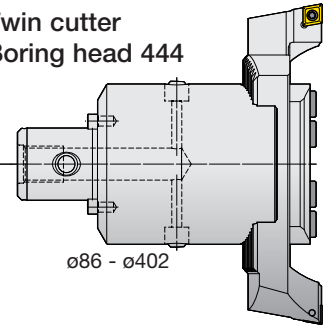

ø86 - ø402

Twin cutter
Boring head 404

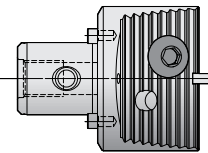

ø23.5 - ø153

Extension
Bridge

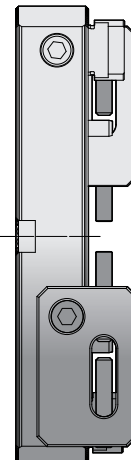

ø150 - ø2205

Boring head
570, 575, 580

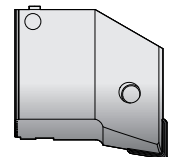
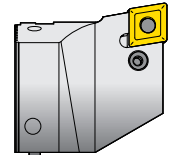

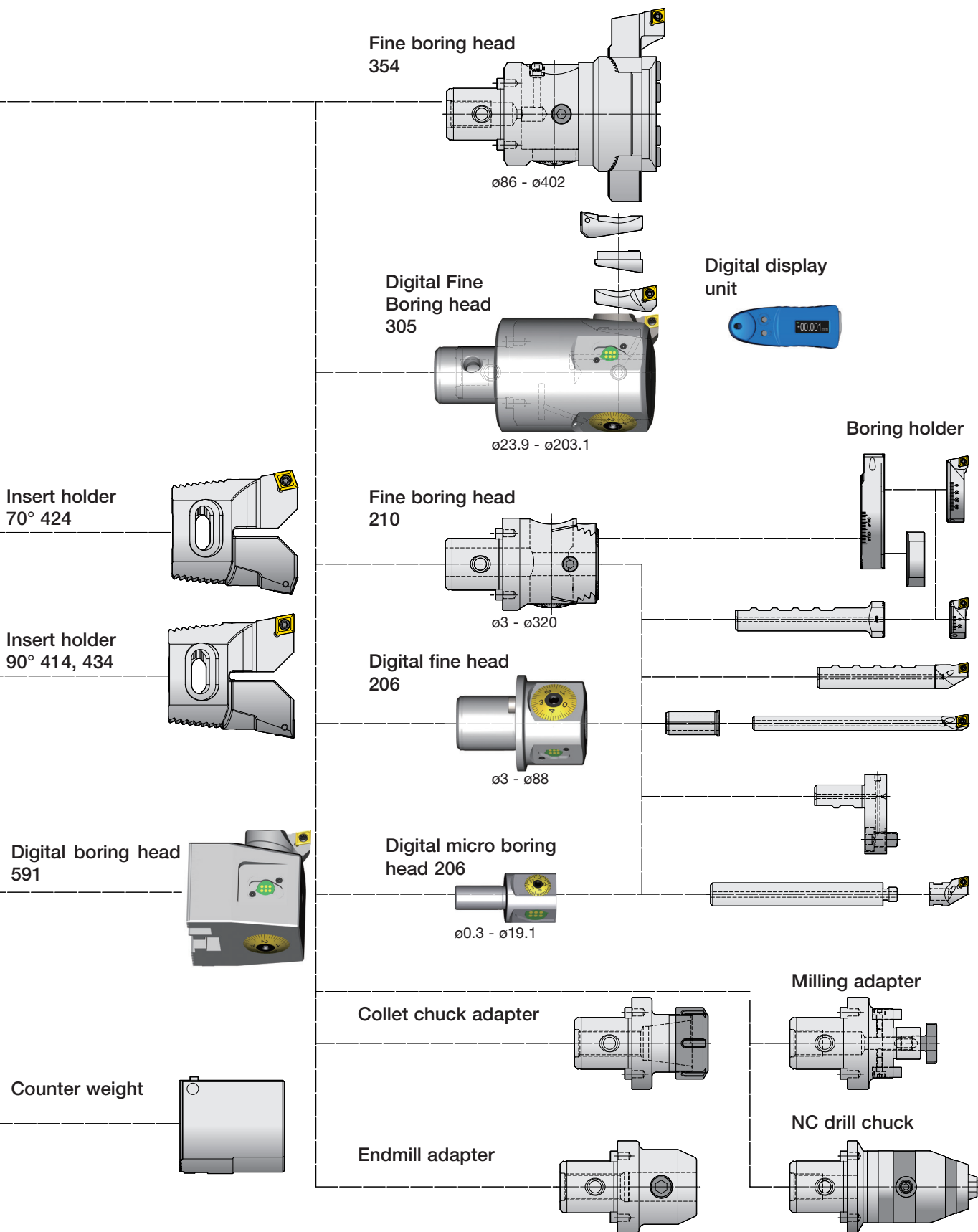

SWISSBORE

GH1-DA

Digital display unit



Metric

GH1-DA2.BG0.077

- High precision display unit with accuracy of 0.001 mm in diameter.
- Display unit features direct measurement system with no backlash.
- The illuminated display can be rotated 180 degrees to apply any measuring situation.
- Option: mm or inch
- Standard AAA battery installed.
- Magnet attachment

SPARE PARTS



Designation	Clamping screw ①	Screw wrench	Battery ②
GH1-DA2.BG0.077	900.309.022.008	900.308.011.045	AAA

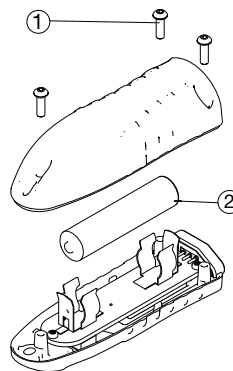

SWISSBORE

SwissBore206

Digital fine boring head $\varnothing 9.75 - \varnothing 88.1$

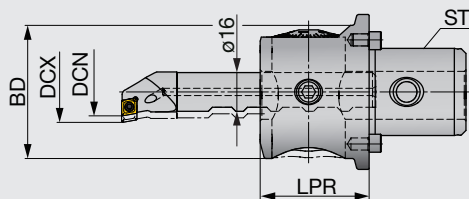

Radius adjustment range: 2.7 mm

Metric

Designation	ST	BD	DCN	DCX	LPR
206.064.025.045	ST6	55	9.75	88.1	45

SPARE PARTS



Designation	Drive pin ①	Clamping screw ②	Fastening screw ③
206.***.025.***	900.102.064.000	900.204.010.008	900.204.010.008

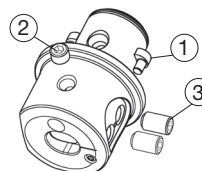

Boring bars 254,256
Option :Display unit GH1-DA2.BG0.077

SWISSBORE

SwissBore256

Boring bar $\varnothing 29.75 - \varnothing 88.1$

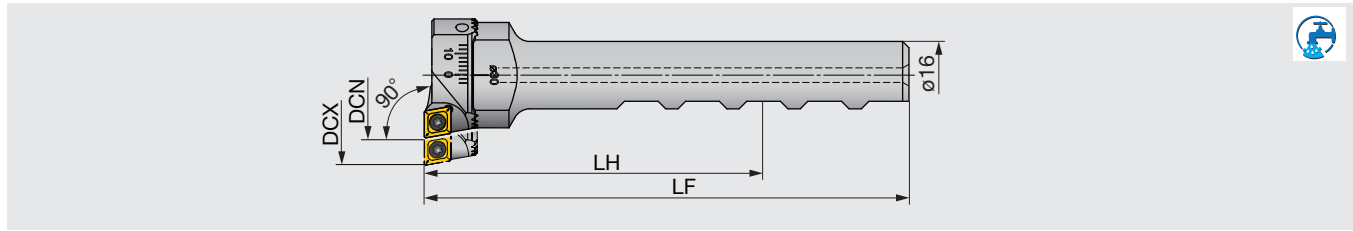

Metric (Shank)	Metric (Insert holder)	DCN	DCX	LH	LF	Insert
256.030.048.115	256.030.006.012	29.75	48.1	85	115	CC**0602...
256.048.088.115	256.048.006.014	47.75	88.1	85	115	CC**0602...

Applicable for 7 MPa pressure coolant

SPARE PARTS

Designation	Clamping screw ①	Clamping screw ②	Wrench
256.0**.0**.***	900.256.005.016	CSTB-2.5S	T-8F

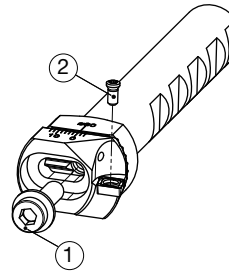

SWISSBORE

SwissBore254

Boring bar $\varnothing 9.75 - \varnothing 30.1$

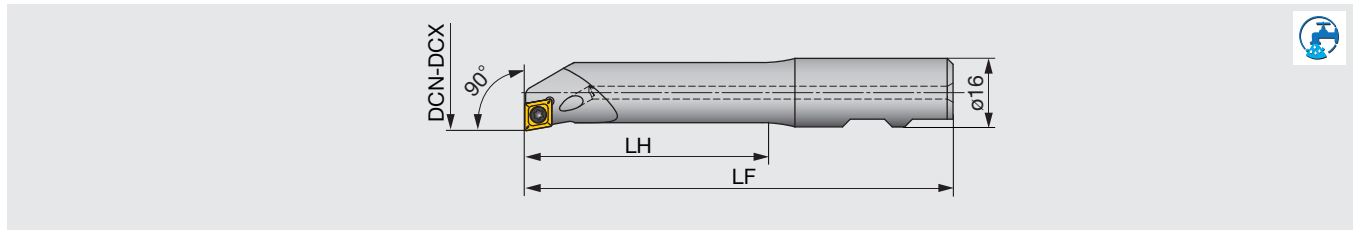

Metric	DCN	DCX	LH	LF	Insert
254.010.006.075	9.75	15.1	30	75	CC**0602...
254.015.006.090	14.75	20.1	51	90	CC**0602...
254.020.006.105	19.75	25.1	72	105	CC**0602...
254.025.006.115	24.75	30.1	82	115	CC**0602...

Applicable for 7 MPa pressure coolant

SPARE PARTS

Designation	Clamping screw	Screw wrench
254.0**.006.***	CSTB-2.5S	T-8F

Reference pages: Inserts → **B111** -, CBN → **B182** -, PCD → **B196** -

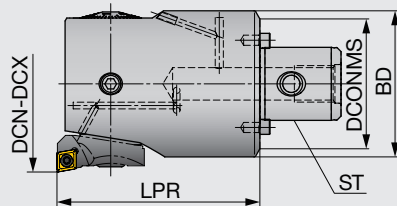

Metric	ST	DCN	DCX	DCONMS	BD	LPR	Insert holder
305.020.024.035	ST1	23.9	31.1	19.6	22.5	35.5	314.011.024.006/007
305.020.024.035	ST1	29.9	37.1	19.6	22.5	35.5	314.011.030.006/007
305.025.031.040	ST2	30.9	40.1	25	29	40	314.013.031.006/007
305.025.031.040	ST2	37.9	47.1	25	29	40	314.013.038.006/007
305.032.040.047	ST3	39.9	51.1	31.4	37	47	314.017.040.006/007
305.032.040.047	ST3	47.9	59.1	31.4	37	47	314.017.048.006/007
305.039.051.057	ST4	50.9	67.1	39	47	57	314.022.051.006/007
305.039.051.057	ST4	64.9	81.1	39	47	57	314.022.065.006/007
305.050.067.080	ST5	66.9	87.1	50	59	80	314.030.067.009/011
305.050.067.080	ST5	84.9	105.1	50	59	80	314.030.085.009/011
305.064.087.100	ST6+	86.9	116.1	64	72	100	314.030.067.009/011
305.064.087.100	ST6+	104.9	134.1	64	72	100	314.030.085.009/011
305.090.116.130	ST7+	115.9	153.1	90	94	130	314.030.067.009/011
305.090.116.130	ST7+	133.9	171.1	90	94	130	314.030.085.009/011
305.090.116.130	ST7+	153.9	191.1	90	94	130	314.726.003.009/011
305.090.116.130	ST7+	165.9*	203.1*	90	94	130	-

*Option : insert holder (314.726.003.009 or 314.726.003.011) & adapter (900.803.001.006)
Applicable for 7 MPa pressure coolant

SPARE PARTS

Designation	Drive pin ①	Clamping screw ②	Fastening screw ③
305.020.024.035	900.102.020.000	900.304.004.003	900.314.004.006
305.025.031.040	900.102.025.000	900.304.005.004	900.314.005.008
305.032.040.047	900.102.032.000	900.304.006.005	900.314.006.010
305.039.051.057	900.102.039.000	900.304.008.006	900.314.008.012
305.050.067.080	900.102.050.000	900.304.010.010	900.314.010.016
305.064.087.100	900.102.064.000	900.304.010.018	900.314.010.016
305.090.116.130	900.102.090.000	900.304.010.030	900.314.010.016

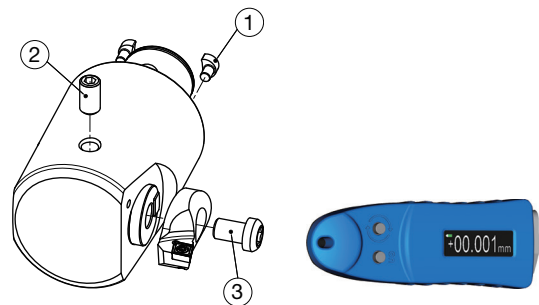

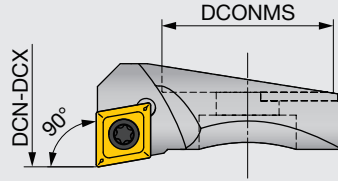

Metric	DCN	DCX	DCONMS	Insert	Boring head
314.011.024.006	23.9	31.1	11	CC**0602**	305.020.024.035
314.011.030.006	29.9	37.1	11	CC**0602**	305.020.024.035
314.013.031.006	30.9	40.1	13	CC**0602**	305.025.031.040
314.013.038.006	37.9	47.1	13	CC**0602**	305.025.031.040
314.017.040.006	39.9	51.1	17	CC**0602**	305.032.040.047
314.017.048.006	47.9	59.1	17	CC**0602**	305.032.040.047
314.022.051.006	50.9	67.1	22	CC**0602**	305.039.051.057
314.022.065.006	64.9	81.1	22	CC**0602**	305.039.051.057
314.030.067.009	66.9	87.1	30	CC**09T3**	305.050.067.080
314.030.085.009	84.9	105.1	30	CC**09T3**	305.050.067.080
314.030.067.009	86.9	116.1	30	CC**09T3**	305.064.087.100
314.030.085.009	104.9	134.1	30	CC**09T3**	305.064.087.100
314.030.067.009	115.9	153.1	30	CC**09T3**	305.090.116.130
314.030.085.009	133.9	171.1	30	CC**09T3**	305.090.116.130
314.726.003.009	153.9	191.1	30	CC**09T3**	305.090.116.130

SPARE PARTS

Designation	Clamping screw ①	Wrench ②
314.***.***006	CSTB-2.5S	T-8F
314.***.***009	CSTB-4S	T-15F

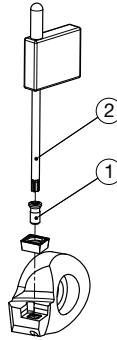

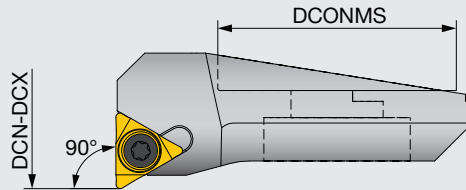

Metric	DCN	DCX	DCONMS	Insert	Boring head
314.011.024.007	23.9	31.1	11	TP**0701**	305.020.024.035
314.011.030.007	29.9	37.1	11	TP**0701**	305.020.024.035
314.013.031.007	30.9	40.1	13	TP**0701**	305.025.031.040
314.013.038.007	37.9	47.1	13	TP**0701**	305.025.031.040
314.017.040.007	39.9	51.1	17	TP**0701**	305.032.040.047
314.017.048.007	47.9	59.1	17	TP**0701**	305.032.040.047
314.022.051.007	50.9	67.1	22	TP**0701**	305.039.051.057
314.022.065.007	64.9	81.1	22	TP**0701**	305.039.051.057
314.030.067.011	66.9	87.1	30	TP**1102**	305.050.067.080
314.030.085.011	84.9	105.1	30	TP**1102**	305.050.067.080
314.030.067.011	86.9	116.1	30	TP**1102**	305.064.087.100
314.030.085.011	104.9	134.1	30	TP**1102**	305.064.087.100
314.030.067.011	115.9	153.1	30	TP**1102**	305.090.116.130
314.030.085.011	133.9	171.1	30	TP**1102**	305.090.116.130
314.726.003.011	153.9	191.1	30	TP**1102**	305.090.116.130

SPARE PARTS

Designation	Clamping screw ①	Wrench ②
314.***,**007	CSTB-2.2L038	T-7F
314.***,**011	CSTB-2.5S	T-8F

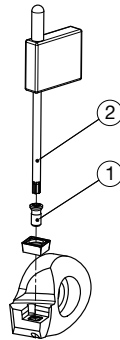

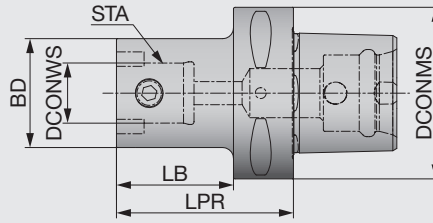

Inch	DCONMS	STA	BD	DCONWS	LPR	LB
154.806.020.065	2.480	ST1	0.787	0.433	2.559	1.693
154.806.025.065	2.480	ST2	0.984	0.551	2.559	1.693
154.806.032.065	2.480	ST3	1.260	0.709	2.559	1.693
154.806.039.058	2.480	ST4	1.535	0.866	2.283	1.417
154.806.050.048	2.480	ST5	1.969	1.102	1.890	1.024
154.806.064.059	2.480	ST6	2.520	1.417	2.323	1.457
154.806.064.094	2.480	ST6+	2.520	1.417	3.701	2.835

SPARE PARTS



Clamping size	Clamping screw ①	O-ring ②	Tension screw ③	Threaded ring ④
ST1	900.100.004.005	900.101.008.002	-	-
ST2	900.100.005.006	900.101.011.002	-	-
ST3	900.100.006.008	900.101.015.002	-	-
ST4	900.100.008.011	900.101.019.002	-	-
ST5	900.100.010.012	900.101.025.002	-	-
ST6	900.100.012.018	900.101.032.002	-	-
ST6+	900.100.012.018	900.101.032.002	900.102.018.040	900.103.030.020

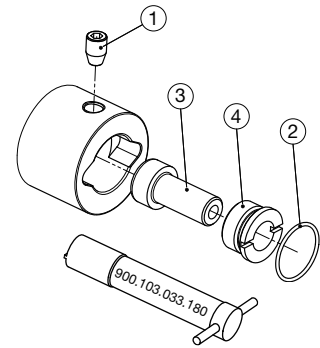

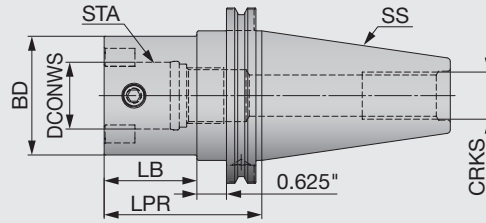

Inch	SS	STA	BD	DCONWS	LPR	LB	CRKS
104.340.020.051	CAT40	ST1	0.787	0.433	2.008	0.630	5/8"-11
104.340.025.056	CAT40	ST2	0.984	0.551	2.205	0.827	5/8"-11
104.340.032.056	CAT40	ST3	1.260	0.709	2.205	0.827	5/8"-11
104.340.039.059	CAT40	ST4	1.535	0.866	2.323	0.945	5/8"-11
104.340.050.059	CAT40	ST5	1.969	1.102	2.323	0.945	5/8"-11
104.340.064.075	CAT40	ST6+	2.520	1.417	2.953	1.575	5/8"-11
104.350.020.061	CAT50	ST1	0.787	0.433	2.402	1.024	1"-8
104.350.025.066	CAT50	ST2	0.984	0.551	2.598	1.220	1"-8
104.350.032.066	CAT50	ST3	1.260	0.709	2.598	1.220	1"-8
104.350.039.069	CAT50	ST4	1.535	0.866	2.717	1.339	1"-8
104.350.050.069	CAT50	ST5	1.969	1.102	2.717	1.339	1"-8
104.350.064.085	CAT50	ST6+	2.520	1.417	3.346	1.969	1"-8
104.350.090.085	CAT50	ST7+	3.543	1.811	3.346	1.969	1"-8

SPARE PARTS



Clamping size	Clamping screw ①	O-ring ②	Tension screw ③	Threaded ring ④
ST1	900.100.004.005	900.101.008.002	-	-
ST2	900.100.005.006	900.101.011.002	-	-
ST3	900.100.006.008	900.101.015.002	-	-
ST4	900.100.008.011	900.101.019.002	-	-
ST5	900.100.010.012	900.101.025.002	-	-
ST6	900.100.012.018	900.101.032.002	-	-
ST6+	900.100.012.018	900.101.032.002	900.102.018.040	900.103.030.020
ST7+	900.100.020.029	900.101.043.002	900.102.024.045	900.103.040.020

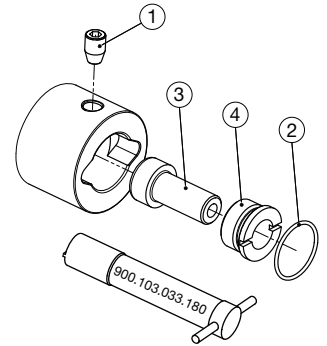

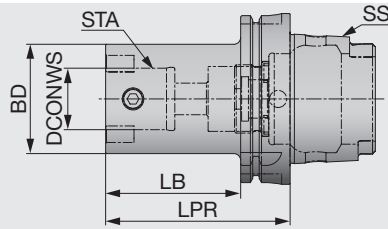

Inch	SS	STA	BD	DCONWS	LPR	LB
144.806.020.042	HSK A 63	ST1	0.787	0.433	1.654	0.630
144.806.025.042	HSK A 63	ST2	0.984	0.551	1.654	0.630
144.806.032.044	HSK A 63	ST3	1.260	0.709	1.732	0.709
144.806.039.048	HSK A 63	ST4	1.535	0.866	1.890	0.866
144.806.050.059	HSK A 63	ST5	1.969	1.102	2.323	1.299
144.806.064.070	HSK A 63	ST6	2.520	1.417	2.756	1.732
144.806.064.100	HSK A 63	ST6+	2.520	1.417	3.937	2.913
144.810.020.055	HSK A 100	ST1	0.787	0.433	2.165	1.024
144.810.025.055	HSK A 100	ST2	0.984	0.551	2.165	1.024
144.810.032.057	HSK A 100	ST3	1.260	0.709	2.244	1.102
144.810.039.061	HSK A 100	ST4	1.535	0.866	2.402	1.260
144.810.050.072	HSK A 100	ST5	1.969	1.102	2.835	1.693
144.810.064.078	HSK A 100	ST6	2.520	1.417	3.071	1.929
144.810.064.108	HSK A 100	ST6+	2.520	1.417	4.252	3.110
144.810.090.127	HSK A 100	ST7+	3.543	1.811	5.000	3.858

Option : Tension screw & Threading ring of ST+ type

SPARE PARTS

Clamping size	Clamping screw ①	O-ring ②	Tension screw ③	Threaded ring ④
ST1	900.100.004.005	900.101.008.002	-	-
ST2	900.100.005.006	900.101.011.002	-	-
ST3	900.100.006.008	900.101.015.002	-	-
ST4	900.100.008.011	900.101.019.002	-	-
ST5	900.100.010.012	900.101.025.002	-	-
ST6	900.100.012.018	900.101.032.002	-	-
ST6+	900.100.012.018	900.101.032.002	900.102.018.040	-
ST7+	900.100.020.029	900.101.043.002	900.102.024.045	-
HSK A 63	-	-	-	900.104.030.014
HSK A 100	-	-	-	900.104.040.020

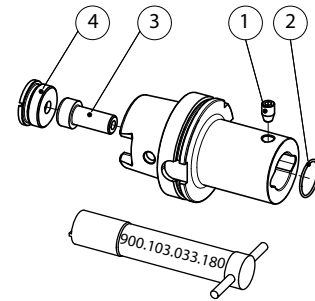

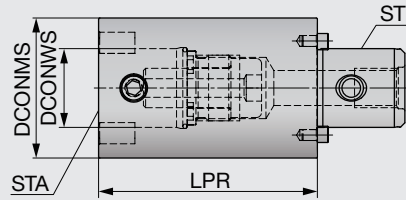

Metric	ST	STA	DCONMS	DCONWS	LPR
164.020.020.020	ST1	ST1	20	11	20
164.020.020.030	ST1	ST1	20	11	30
164.025.025.030	ST2	ST2	25	14	30
164.025.025.045	ST2	ST2	25	14	45
164.032.032.030	ST3	ST3	32	18	30
164.032.032.045	ST3	ST3	32	18	45
164.039.039.040	ST4	ST4	39	22	40
164.039.039.060	ST4	ST4	39	22	60
164.050.050.060	ST5	ST5	50	28	60
164.050.050.090	ST5	ST5	50	28	90
164.064.064.060	ST6+	ST6+	64	36	60
164.064.064.100	ST6+	ST6+	64	36	100
164.090.090.100	ST7+	ST7+	90	46	100
164.090.090.160	ST7+	ST7+	90	46	160

Option : Tension screw & Threading ring of ST+ type

SPARE PARTS



Clamping size	Clamping screw ①	O-ring ②	Tension screw ③	Threaded ring ④	Drive pin ⑤
ST1	900.100.004.005	900.101.008.002	-	-	900.102.020.000
ST2	900.100.005.006	900.101.011.002	-	-	900.102.025.000
ST3	900.100.006.008	900.101.015.002	-	-	900.102.032.000
ST4	900.100.008.011	900.101.019.002	-	-	900.102.039.000
ST5	900.100.010.012	900.101.025.002	-	-	900.102.050.000
ST6	900.100.012.018	900.101.032.002	-	-	900.102.064.000
ST6+	900.100.012.018	900.101.032.002	900.102.018.040	900.103.030.020	900.102.064.000
ST7+	900.100.020.029	900.101.043.002	900.102.024.045	900.103.040.020	900.102.090.000

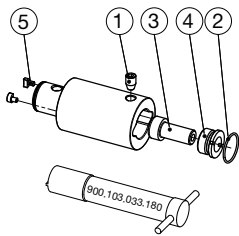

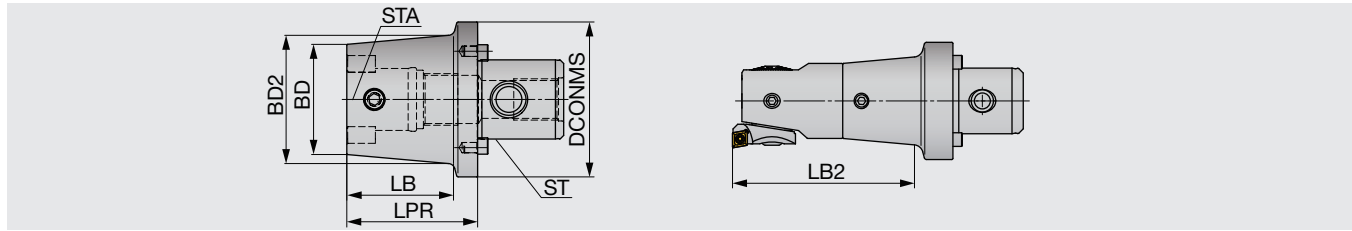

Metric	ST	STA	DCONMS	BD	BD2	LPR	LB	LB2
184.025.020.036	ST2	ST1	25	20	23	36	25	60.5
184.032.025.034	ST3	ST2	32	25	29	34.5	20	60
184.039.032.047	ST4	ST3	39	32	38	47	35	82
184.050.039.040	ST5	ST4	50	39	48	40	25.5	82.5
184.064.050.039	ST6+	ST5	64	50	60	39	24	104

LB2 : Max boring depth with twin cutter or fine boring head
 Option : Tension screw & Threading ring of ST+ type

SPARE PARTS



Clamping size	Clamping screw ①	O-ring ②	Tension screw ③	Threaded ring ④	Drive pin ⑤
ST1	900.100.004.005	900.101.008.002	-	-	900.102.020.000
ST2	900.100.005.006	900.101.011.002	-	-	900.102.025.000
ST3	900.100.006.008	900.101.015.002	-	-	900.102.032.000
ST4	900.100.008.011	900.101.019.002	-	-	900.102.039.000
ST5	900.100.010.012	900.101.025.002	-	-	900.102.050.000
ST6	900.100.012.018	900.101.032.002	-	-	900.102.064.000
ST6+	900.100.012.018	900.101.032.002	900.102.018.040	900.103.030.020	900.102.090.000

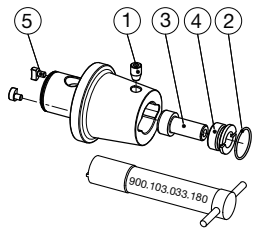

A person wearing a red high-visibility work jacket with reflective silver stripes and the brand name 'Tungaloy' on the chest is seated at a table. They are looking at several sheets of technical drawings or blueprints. On the table, there is a cylindrical metal part and a rectangular metal tool or component. The scene is brightly lit, and the overall tone is professional and technical.

User's Guide

Parts for Tools

L002

Technical Reference

L030

User's Guide - Parts for Tools

Screws

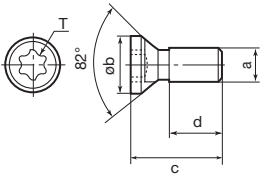
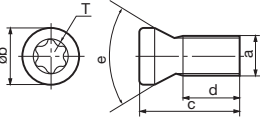
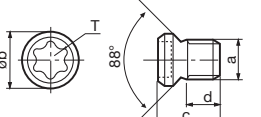
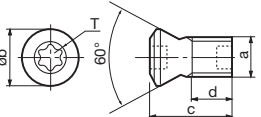
Shape	Designation	Dimension (in)					T / f	Torque (lbs-ft)				
		a	øb	c	d	e						
 <p>(Steel)</p>	CSTA-NO2	#2-56UNC	0.157	0.236	0.157	82°	T8	0.96				
	CSTA-NO2S			0.197	0.118							
	CSTA-NO2L			0.315	0.236							
	CSTA-NO3	#3-48UNC	0.169	0.276	0.157		T9	1.70				
	CSTA-NO5	#5-40UNC	0.197	0.315	0.197							
	CSTA-1.6	M1.6x0.35	0.098	0.122	0.035				T6	0.44		
	CSTA-4	M4x0.7	0.276	0.394	0.303		M5x0.8	T15	2.58			
	CSTA-5	0.283	0.591	0.433								
	CSTA-5S		0.472	0.315								
	CSTA-5SS		0.374	0.217								
	CSTA-5ST25	0.472	0.315	0.280	0.591					0.433	T25	3.69
	CSPA-5IP15	0.472	0.315		15IP					2.58		
	CSPA-5SIP15	0.591	0.433		20IP					3.69		
	CSPA-5IP20	0.472	0.315									
	CSPA-5SIP20											
 <p>CSP-2L033 type shown</p>  <p>CSTB-4SD type shown</p>  <p>CSTC-4L type shown</p> <p>(Steel)</p>	CSP-2L033	M2x0.4	0.102	0.130	0.075	88°				6IP	0.52	
	CSTB-2		0.106	0.130	0.055							
	CSTB-2L	0.205		0.130								
	CSTB-2L040	0.157		0.083								
	CSTB-2.2	M2.2x0.45	0.138	0.240	0.138		T7	0.74				
	CSTB-2.2L038			0.150	0.087							
	CSTB-2.2S			0.181	0.079							
	CSTB-2.2R	0.122	0.240	0.146	M2.5x0.45		0.138	T8	0.96			
	CSTB-2.5	0.236	0.134									
	CSTB-2.5L080	0.315	0.213									
	CSTB-2.5B	0.217	0.102									
	CSTB-2.5S	0.189	0.087	M3x0.5	0.161		0.315	0.177	T9	1.70		
	CSTB-3	0.165	0.177									
	CSTB-3L042	0.165	0.028									
	CSTB-3L050	0.161	0.319	0.185	T8		0.96					
	CSTB-3L081		0.161	0.098								
	CSTB-3S		0.236	0.098								
	CSTB-3.5ST	M3.5x0.6	0.256	0.209	0.492		0.157	T15	2.58			
	CSTB-3.5H			0.205	0.256		0.122					
	CSTB-3.5			0.217	0.331		0.169					
	CSTB-3.5T			0.394	0.217							
	CSTB-3.5TS			0.335	0.157							
	CSTB-3.5D			0.185	0.331		0.193			T9	1.70	
	CSTB-3.5L110			0.217	0.433		0.295					
	CSTB-3.5L115			0.189	0.453		0.276			T10	1.84	
	CSTB-3.5L115-S											0.256
	CSTB-3.5L			0.209	0.492		0.331			M4x0.7	0.217	T15
	CSTB-4	0.449	0.291									
	CSTB-4L060	0.236	0.079									
	CSTB-4L085	0.334	0.137									
	CSTB-4L090	0.224	0.354	0.217								
	CSTB-4L115-S	0.217	0.453	0.256								
	CSTB-4S	0.217	0.315	0.157	4.06							
	CSTB-4ST	0.252	0.579									
	CSTB-4SD	M4x0.5	0.252	0.315	2.58							
	CSTB-4M			0.374			0.217					
	CSTB-4F	M4x0.5	0.276	0.579	0.343		T8	0.96				
	CSTB-4TS	M4x0.7	0.256	0.354	0.177							
	CSTB-5	M5x0.8	0.276	0.472	0.295		T20	3.69				
	CSTB-5S			0.374	0.197							
	CSTB-5L105			0.413	0.240							
	CSTB-5L120			0.472	0.256							
CSTB-5L159	0.283			0.626	0.441							
CSTB-5L163-S	0.272			0.642	0.445	4.43						

User's Guide - Parts for Tools

Screws

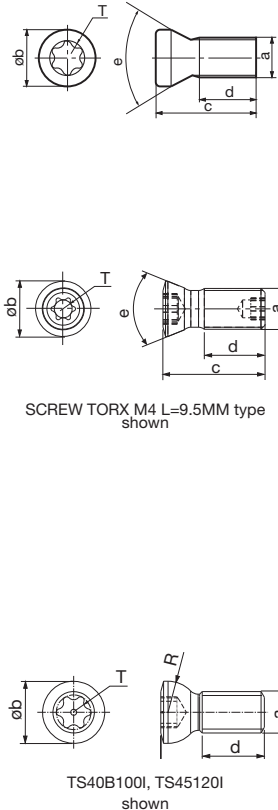
Shape	Designation	Dimension (in)					T / f	Torque (lbs-ft)			
		a	øb	c	d	e / R					
 <p>SCREW TORX M4 L=9.5MM type shown</p> <p>TS40B100I, TS45120I shown</p> <p>(Steel)</p>	CSTC-4L055DR	M4x0.5	0.213	0.217	0.079	44°	T8/T10	0.96/1.84			
	CSTC-4L055DL	M4x0.5	0.213	0.217	0.079		T8/T10	0.96/1.84			
	CSTC-4L100DR	M4x0.7	0.213	0.394	0.234		T8/T10	0.96/1.84			
	CSTC-4L100DL	M4x0.7	0.213	0.394	0.234		T8/T10	0.96/1.84			
	CSPB-2L043	M2x0.4	0.106	0.169	0.098	60°	6IP	0.52			
	CSPB-2H								0.102	0.134	0.063
	CSPB-2.2	M2.2x0.45	0.118	0.236	0.154		7IP	0.74			
	CSPB-2.2SH			0.157	0.079				0.81		
	CSPB-2.5	M2.5x0.45	0.138	0.236	0.138		8IP	0.96			
	CSPB-2.5S			0.165	0.067						
	CSPB-2.5SH			0.130	0.205				0.130	7IP	0.81
	CSPB-3.5			M3.5x0.6	0.205				0.354	0.220	15IP
	CSPB-3.5S	M3.5x0.6	0.205	0.256	0.122		60°	15IP	2.58		
	CSPB-4	M4x0.7	0.217	0.457	0.291						
	CSPB-4S			0.323	0.157						
	CSPB-5	M5x0.8	0.276	0.472	0.295					20IP	3.69
	VX040024A	M4	0.215	0.354	0.236	44°	T15	3.32			
	VX040028A	M4	0.205	0.382	0.185		T15	3.32			
	SR14-500/L5.1	M4	0.217	0.201	0.091	60°	T15	2.58			
	SR14-500-L7.0	M4	0.217	0.276	0.165		T15	2.58			
	SR14-562	M3.5	0.189	0.344	0.219		T10	2.58			
	SR14-562/S	M3.5	0.189	0.256	0.130		T10	2.58			
	SR14-591	M5x0.8	0.260	0.531	0.299		T20	3.69			
	SR34-508	M2.2x0.45	0.124	0.181	0.105		T7	0.66			
	SR34-514	M2.5x0.45	0.130	0.205	0.126		T7	0.66			
	SR76-943	M6	0.378	0.787	0.394		90°	T20	3.69		
	SR76-961	M5	0.260	0.531	0.289		61°	T15	2.58		
	SR76-963	M5	0.339	0.787	0.378		91°	T15	2.58		
	SR-10503833-S	M2.5X0.45	0.128	0.150	0.069		60°	T7	-		
	SR 114-018-L3.40	M2.5	0.142	0.132	0.079		56°	T6	0.52		
	SM40-143-H0	M4X0.7	0.220	0.563	0.331	61°	T15	2.58			
	TS25F080A	M2.25X0.35	0.146	0.272	0.083	60°	T8	0.96			
	TS25064I	M2.5X0.45	0.138	0.252	0.150	50°	T8	0.96			
TS30F100A	M3X0.35	0.181	0.327	0.087	60°	T10	1.84				
TS30085I/HG	M3X0.5	0.169	0.335	0.220		T9	1.70				
TS30C72I	M3X0.5	0.165	0.283	0.177		T9	1.70				
TS40085I/HG	M4	0.224	0.335	0.177		T15	2.58				
TS35085I/HG	M3X0.6	0.209	0.335	0.169		T15	2.58				
TS40093I/HG	M4	0.224	0.366	0.169		T15	2.58				
TS40B100I	M4	0.236	0.394	0.236		R = 3.0	T15	2.58			
TS40F120A	M4X0.5	0.236	0.417	0.118		60°	T15	2.58			
TS45120I	M4.5	0.272	0.472	0.295		R = 3.5	T20	3.69			
TS50115I	M5	0.276	0.447	0.252		60°	T20	3.69			
TS50230D3	M5X0.8	0.276	0.906	0.531			T20	-			
TS50250D35	M5X0.8	0.295	0.984	0.571			T25	-			
TS50F160A	M5X0.5	0.276	0.547	0.138	T20		3.69				
TS60265D4	M6X1.0	0.315	1.043	0.610	T25		-				
TS60285D42	M6X1.0	0.335	1.122	0.657	T25		-				
TS60320D5	M6X1.0	0.374	1.220	0.709	T25		-				
TS60F200A	M6X0.75	0.323	0.657	0.177	T20		5.16				
TS70F250A	M7X0.75	0.394	0.827	0.220	T25		5.16				
TS80340D6	M8X1.25	0.394	1.339	0.787	T25		-				
TS80F300A	M8X1.0	0.472	0.984	0.287	T30		7.38				

Grade
Insert
Toolholder
Ext. Toolholder
Int. Toolholder
Threading
Grooving
Miniature Tool
Milling Cutter
Endmill
Drilling Tool
Tooling System
Index



User's Guide - Parts for Tools

Screws

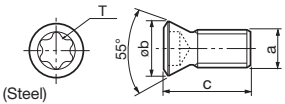
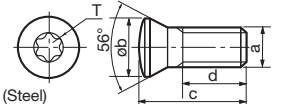
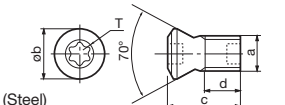
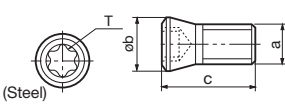
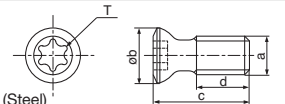
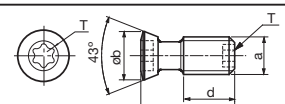
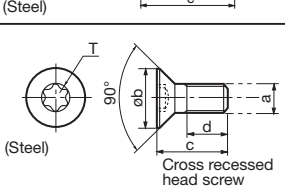
Shape	Designation	Dimension (in)						Torque (lbs-ft)
		a	øb	c	d	e	T / f	
 (Steel)	CSPD-1.8S	M1.8x0.35	0.094	0.130	0.055	55°	6IP	0.52
	CSTD-3T	M3x0.5	0.169	0.276	0.177		T10	1.84
	CSPD-3				0.165		10IP	1.84
 (Steel)	CSTB-4.5L110P	M4.5X0.75	0.260	0.461	0.276	56°	T15	2.58
	 (Steel)	SRM5X0.8IP20X+ACROLYTE	M5X0.8	0.362	0.591	0.386	70°	20IP
 (Steel)		CSTC-2	M2x0.4	0.122	0.201	-	-	T6
	 (Steel)	CSTR-4L100	M4x0.7	0.224	0.394	0.217	-	T15
 (Steel)		SR16-212-01397 SR16-212-01397L	M5x0.8	0.252	0.492	0.268	43°	T20/T10
	 (Steel)	CST-3.5	M3.5X0.6	0.236	0.189	-	90°	T9
CST-3.5S		0.138			-			
CST-5		M5x0.8	0.394	0.709	0.512	T25		3.69
CST-5S				0.472	0.276			
CSTF-2L055-S		M2x0.4	0.106	0.217	0.150	T6		0.52

Screws

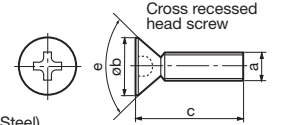
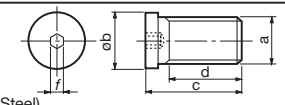
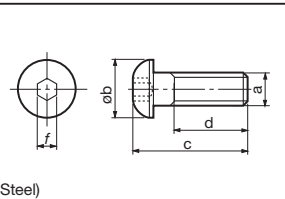
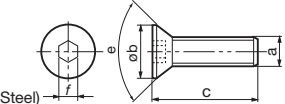
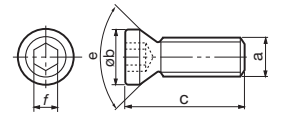
Shape	Designation	Dimension (in)						Torque (lbs-ft)
		a	øb	c	d	T / f	e	
 (Steel)	SM2.5x0.45x8	M2.5x0.45	0.197	0.315	-	-	90°	-
	SM2.5x0.5x8	M2.5x0.5	0.197	0.315	-	-	90°	-
	SM3x0.5x6	M3x0.5	0.236	0.236	-	-	90°	-
	SM3x0.5x8			0.315	-	-	90°	-
	SM3x0.5x10			0.394	-	-	90°	-
 (Steel)	MSP-5	M5x0.8	0.240	0.311	0.193	0.079		1.11
	MSP-6.3	M6.3x1	0.303	0.500	0.390	0.098		2.21
 (Steel)	BHM3-8	M3x0.5	0.217	0.394	0.315	0.079		1.11
	BHM4-8	M4x0.7	0.276	0.417				
	BHM4-10			0.496	0.394	0.098	1.62	
	BHM5-14	M5x0.8	0.354	0.693	0.551	0.118		2.21
	BHM6-20-A	M6x1.0	0.413	0.945	0.787	0.157		3.69
	BHM8-25U	M8	0.551	1.154	0.984	0.197		6.27
BHM8-30U	1.350			1.181				
 (Steel)	CSHM-3-8	M3	0.236	0.315	-	0.079	90°	1.11
 (Steel)	CSHB-4-A	M4	0.217	0.433	-	T15	60°	1.48
	CSHB-6	M6	0.335	0.748	-	0.157	60°	3.69
	CSHB-6-A	M6	0.335	0.748	3.69			

User's Guide - Parts for Tools

Screws

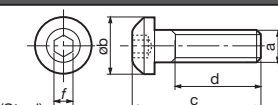
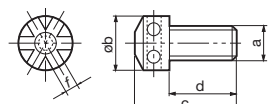
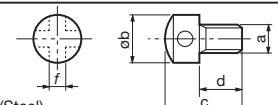
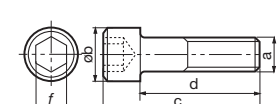
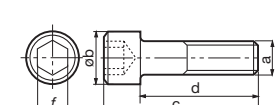
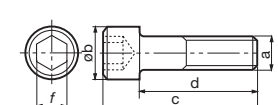
Shape	Designation	Dimension (in)						Torque (lbs-ft)
		a	øb	c	d	T / f		
 (Steel)	RT-1	M6	0.394	0.886	0.551	0.157	3.69	
	RT-2	M8	0.512	1.220	0.787	0.197	6.27	
 (Steel)	ASM6	M6	0.394	0.709	0.472	0.118	-	
	AJM5F	M5x0.5	0.354	0.512	0.315	0.079	-	
	AJM5	M5x0.8	0.354	0.512	0.315	0.079	-	
 (Steel)	ASM34S	M3	0.189	0.315	0.197	0.079	-	
	ASM34L			0.433	0.315		-	
	ASM54	M5x0.8	0.354	0.551	0.354	0.118	-	
 (Steel)	CHHM3.5-10	M3.5x0.6	0.236	0.531	0.394	0.118	2.21	
	CHHM4-10	M4x0.7	0.276	0.551				
	CHHM5-14	M5x0.8	0.335	0.748	0.551	0.157	3.69	
	CHHM5-18			0.906	0.709			
	CHHM6-15	M6	0.394	0.827	0.591	0.197	6.27	
	CHHM6-20			-	0.787			
	CHHM6-25			1.220	0.984			
 Hex. socket head screw (JISB1176) (Steel)	CM3X0.5X6	M3x0.5	0.217	0.354	0.236	0.098	1.62	
	CM3X0.5X10			0.512	0.394			
	CM4X0.7X10	M4x0.7	0.276	0.630	0.472	0.118	2.21	
	CM4X0.7X12			0.709	0.551			
	CM4X0.7X14			0.748	0.591			
	CM4X0.7X15			0.945	0.787			
	CM4X0.7X20	M5x0.8	0.335	0.945	0.787	0.157	3.69	
	CM4X0.7X20-M0-A			0.512	0.315			
	CM5X0.8X8			0.591	0.394			
	CM5X0.8X10-A			0.669	0.472			
	CM5X0.8X12			0.669	0.472			
	CM5X0.8X12-A			0.709	0.551			
	CM5X0.8X14			0.827	0.630			
	CM5X0.8X16-A			0.827	0.630			
	CM5X0.8X18			0.906	0.709			
	CM5X0.8X20-A			0.984	0.787			
	CM5X0.8X25-A	1.181	0.984					
	CM5X15	M5		0.787	0.591			
	 Hex. socket head screw (JISB1176) (Steel)	CM6X1X16-A	M6x1.0	0.394	0.866	0.630	0.197	6.27
		CM6X1X20-A			1.024	0.787		
CM6X1X25-A		1.220			0.984			
CM6X1.0X40-A		1.811			1.575			
CM6X10		M6		0.630	0.394	0.236	18.44	
CM6X15				0.827	0.591			
CM6X16				0.866	0.630			
CM6X20				1.024	0.787			
CM6X25				1.220	0.984			
CM6X30-S		M6x1.0	0.394	1.406	1.102	0.197		
CM8X1.25X20-A		M8x1.25	0.512	1.102	0.787	0.236	18.44	
CM8X1.25X25-A				1.299	0.984			
CM8X30H				1.417	1.181	0.197		
CM10X30		M10x1.5		0.630	1.181	0.787	0.315	29.50
CM10X30H				0.630	1.496	1.181	0.236	29.50
CM12X30H		M12x1.75		0.709	1.575	0.315	51.63	
CM16X40H		M16x2		0.945	2.126	1.575	0.394	73.75
CM16x75	M16		0.945	2.953	2.008	0.551	73.75	
CM16x120	M16		0.945	4.724	3.780	0.551	73.75	
CM16x140	M16		0.945	5.512	4.567	0.551	73.75	

Grade
Insert
Ext. Toolholder
Int. Toolholder
Threading
Grooving
Miniature Tool
Milling Cutter
Endmill
Drilling Tool
Tooling System
Index



User's Guide - Parts for Tools

Screws

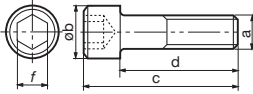
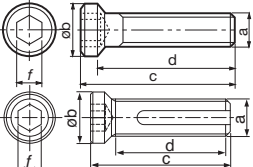
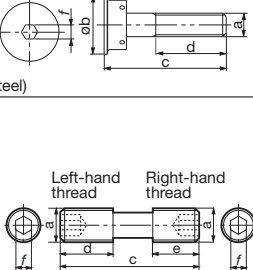
Shape	Designation	Dimension (in)							Torque (lbs-ft)
		a	øb	c	d	e	T / f		
 <p>Hex. socket head screw (JISB1176)</p>	CM20x80	M20	1.181	3.150	1.969		0.669		110.63
	CM20x120	M20	1.181	4.724	3.543		0.669		110.63
	CM20x150	M20	1.181	5.906	4.724		0.669		110.63
	CAP-CM12x1.75x50	M12	0.709	1.969	1.496		0.394		51.63
	CAP-CM16x2.0x55	M16	0.945	2.165	1.535		0.551		29.50
	CAP-CM20x2.5x50	M20	1.181	1.969	1.181		0.669		73.75
	C0.375X1.125H	3/8-24UNF	0.562	1.500	1.125		0.219		25.81
	C0.500X1.375H	1/2-20UNF	0.750	1.875	1.375		0.313		51.63
	SD06-A3	M10x1.5	0.630	2.756	2.362		0.315		29.50
	SRM6X16DIN912-12.9	M6x1	0.394	0.866	0.555		0.197		
	VC00TEDI12040F	M12	1.024	2.008	1.575		0.315		44.25
	VC00TEDI20040F	M20	1.929	1.969	1.358		0.472		110.63
	VC00TANG16040F	M16	1.811	1.831	1.299		0.394		44.25
	SD08-98	M12x1.75	0.709	3.031	2.559		0.394		51.63
	LHM12x1.75x30-C	M12	0.709	1.453	1.181		0.315		51.63
	VC004762110035F	M10	0.630	1.772	1.358		0.315		44.25
(Steel)	FCS3	M3x0.5	0.217	0.630	0.472		0.098		
	FCS6	M6x1	0.394	1.024	0.787		0.197		
 <p>FSHM*-*H</p>	FSHM8-30	M8x1.25	0.433	1.181	1.063		0.197		18.44
	FSHM8-30H								18.44
	FSHM10-40	M10	0.551	1.575	1.437		0.236		29.50
	FSHM10-40H								29.50
(Steel)	SHCM4-10	M4x0.7	0.236	0.551	0.394		0.118		2.21
	SHCM4-12			0.630	0.472				
	SHCM4-16			0.787	0.630				
(Steel)	CTS-M6	M6x1	0.394	0.984	0.646		0.157		3.69
	(Steel)	RSFTS-050M	M10	0.984	2.047	1.673	0.827	0.236	
 <p>Left-hand thread Right-hand thread</p>		MCS520-2.5	M5x0.8		0.787	0.276	0.236	0.098	
	MCS620-3	M6x1				0.276	0.118		4.43
	MCS625-3			0.984	0.394	0.315			
	MCS825-4	M8x1			0.492	0.256	0.157		5.90
	MCS828-4			1.122	0.472	0.413			
	NDS-8A			1.181	0.453	0.453			
	NDS-8S	M8x1.25		0.787	0.315	0.315			
	RSRGR5M40	M4		0.354	0.144	0.164	T8		
	SR PS 118-0273	M10		1.575	0.650	0.591	0.197		29.50
	SR 5/16-32UNEF_3/8-24UNF	5/16-32UNEF-2A		1.260	0.394	0.453	0.156		
(Steel)	DS-5T	M5x0.8		0.472	0.197	0.197	T10		2.58
	DS-6T	M6		0.591	0.236	0.236	T15		2.58
	DS-6P	M6x1		0.827	0.276	0.276	15IP		4.43
	FDS-8ST	M8x1		0.787		0.315	0.315	T27	7.38
	FDS-8ST-18			0.709		0.236			
	DS-6	M6x1		0.591	0.236	0.236	0.118		4.43
(Steel)	DS-8	M8x1.25		0.630	0.276	0.276	0.157		5.90
	DS-8S			0.512	0.217	0.217			
	DS-10	M10x1.5		1.024		0.472	0.197		5.90
	FDS-6Z	M6x0.75		0.807	0.394	0.217	0.118		4.43
	FDS-8	M8x1		1.024		0.394	0.157		5.90
	FDS-8S			0.787		0.315			
	FDS-8SS			0.728		0.256			

User's Guide - Parts for Tools

Screws

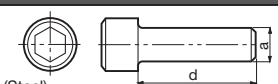
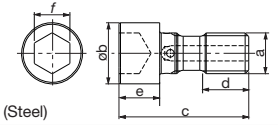
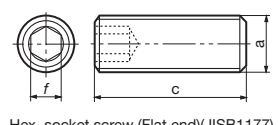
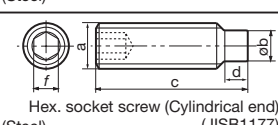
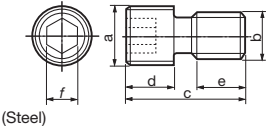
Shape	Designation	Dimension (in)						T / f	Torque (lbs-ft)
		a	øb	c	d	e			
 (Steel)	SS100	1/4-20UNC			0.750				
	S-412	10-32UNF			0.750				
 (Steel)	SHM8x1.25x35-C	M8	0.512	1.693	0.906	0.315	0.236	18.44	
	SHM10x1.5x30-C	M10	0.630	1.575	0.669	0.394	0.315	29.50	
	SHM16x2x35-C	M16	0.945	2.008	0.709	0.630	0.551	73.75	
	SHM20x2.5x40-C	M20	1.181	2.283	0.787	0.709	0.669	110.63	
 Hex. socket screw (Flat end)(JISB1177) (Steel)	SSHM2.5-3	M2.5		0.118			0.059	0.74	
	SSHM3-3	M3		0.118					
	SSHM3-4			0.157					
	SSHM3-6			0.236					
	SSHM4-4	M4		0.157			0.079	1.11	
	SSHM4-5			0.197					
	SSHM4-6			0.236					
	SSHM4-8			0.315					
	SSHM4-10			0.394					
	SSHM4-14	M5		0.551			0.098	1.48	
	SSHM5-6			0.236					
	SSHM5-10			0.394					
	SSHM5-16	M6		0.630			0.118	2.21	
	SSHM6-12			0.472					
	SSHM6-16			0.630					
	SSHM6-18			0.709					
	SSHM6-20	M8		0.787			0.157	3.69	
	SSHM8-8			0.315					
SSHM8-10			0.394						
SSHM8-12			0.472						
SSHM8-14			0.551						
SSHM8-16		0.630							
SSHM8-18		0.709							
 Hex. socket screw (Cylindrical end) (Steel) (JISB1177)	M5x7	M5	0.138	0.276	0.049		0.098	1.48	
	M5x8			0.315					
	M5x10			0.394					
	M6x30	M6	0.157	1.181	0.059	-	0.118	2.21	
 (Steel)	JDS-3525	M3.5x0.35	M2.5 x0.45	0.295	0.118	0.098	0.079	0.74	
	JDS-5040	M5x0.5	M4 x0.7	0.394	0.157	0.157	0.098	0.74	

Screws

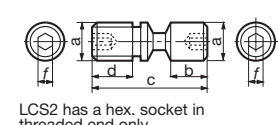
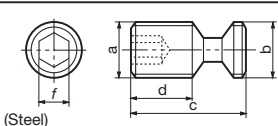
Shape	Designation	Dimension (in)					T / f	Torque (lbs-ft)
		a	b	c	d	e		
 LCS2 has a hex. socket in threaded end only. (Steel)	LCS2	M5	0.197	0.551	0.256		0.079	1.11
	LCS3	M6	0.236	0.591				0.098
	LCS3B							
	LCS4	M8	0.315	0.827	0.378	0.118	2.21	
	LCS4K							
	LCS4CA							
	LCS5							
	LCS5CA	M10	0.386	1.071	0.390	0.157	3.69	
	LCS6							
	LCS8							
LCS8C	M10	0.386	1.189	0.524	0.157	3.69		
 (Steel)	LCS22	M5	M5	0.394	0.185	0.079	1.11	
	LCS22A	M6	M6	0.421				
	LCS23A	M5	M5	0.516	0.201	0.098	1.48	
	LCS33	M5	M5	0.472	0.244	0.079	1.11	
	LCS43	M6	M6	0.531	0.287	0.098	1.48	



User's Guide - Parts for Tools

Screws

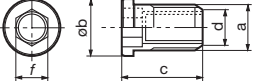
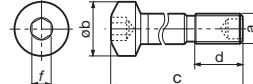
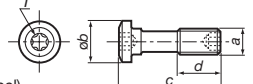
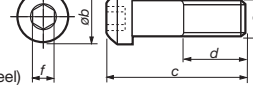
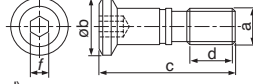
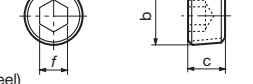
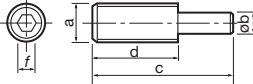
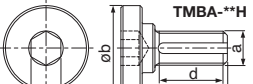
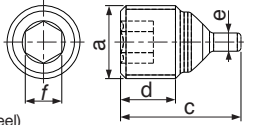
Shape	Designation	Dimension (in)					T / f	Torque (lbs-ft)
		a	b	c	d	e		
 (Steel)	DTS5-3.5	M5	0.248	0.341	M3.5	0.138	2.95	
	DTS5-3.5SS			0.268				
	DTS5-3.5S			0.276				
	DTS6-4	M6	0.303	0.402	M4	0.157	3.69	
	DTS6-4.5		0.295	0.394	M4.5	0.177	3.69	
 (Steel)	DLCS33	M5	0.354	1.240	0.394	0.118	2.21	
	DLCS43	M6	0.472	1.339	0.374		0.157	3.69
	DLCS54	M8x1	0.551	1.614	0.433	5.16		
	DLCS64	M10x1	0.630	1.969	0.591	0.197	5.90	
 (Steel)	ACS-5W	M5	0.315	0.787	0.335	T15	2.95	
	ACS-6W	M6	0.394	1.024	0.476	T20	4.72	
 (Steel)	ACS3	M5x0.8	0.295	1.010	12-15 (mm)	0.118	2.95	
	ACS4	M6x1	0.354	1.090	14-17 (mm)	0.157	5.16	
 (Steel)	WCS3	M6	0.374	0.886	0.315	0.118	2.21	
 (Steel)	PT1/4GN		0.519	0.394	-	0.236	7.01	
	1/8-28		0.383	0.276	-	0.197	5.90	
 (Steel)	LS-8	M8	0.236	1.299	0.787	0.157	3.69	
 (Steel)	TMBA-M10	M10x1.5	1.063	1.181	0.827	0.315	29.50	
	TMBA-M12	M12x1.75	1.299	1.417	1.024	0.394	51.63	
	TMBA-M12H	M12x1.75		1.358		0.315		
	TMBA-M16	M16x2	1.575	1.969	1.575	0.551	73.75	
	TMBA-M16H	M16x2						
	TMBA-M20	M20x2.5	1.969	2.205	1.654	0.669	110.63	
	TMBA-M20H	M20x2.5						
	TMBA-M24	M24x3	2.559	2.717	2.165	0.748	110.63	
	TMBA-M24H	M24x3						
	TMBA-0.500H	1/2-20UNF	1.299	1.335	1.000	0.313	51.63	
	TMBA-0.750H	3/4-16UNF	1.969	2.294	1.861	0.500	110.63	
TMBA-0.750S.375H	3/4-16UNF	1.875	1.700	1.310	0.375	75.00		
 (Steel)	SR-10400611	M4X0.5		0.260	0.118	0.039	0.079	

User's Guide - Parts for Tools

Shims

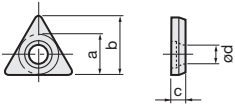
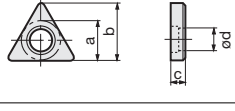
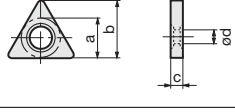
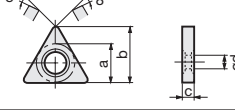
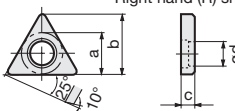
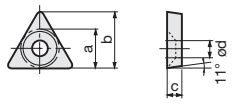
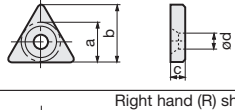
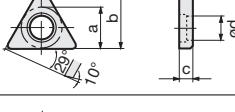
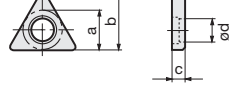
Shape	Designation	Dimension (in)				
		a	b	c	ød	
	AST322	0.366	0.520	0.126	0.173	
	AST422	0.492	0.709			
	MST-322	0.358	0.508	0.128	0.228	
	MST-432	0.492	0.705	0.189	0.287	
	MST-533	0.614	0.874		0.382	
	MST-644	0.740	1.047	0.252	0.445	
	LST317	0.366	0.520	0.106	0.197	
	LST42	0.492	0.709	0.126	0.264	
	LST53	0.618	0.878	0.189	0.303	
	LST42K	0.429	0.614	0.126	0.264	
	LST317CA	0.366	0.520	0.106	0.197	
	LST42CA	0.492	0.709	0.126	0.264	
	ELST42	0.453	0.650	0.126	0.256	
	ELST317					
	ELST317BR	0.335	0.472	0.106	0.193	
	ELST317BL					
	PAT-32	0.323	0.461	0.126	0.138	
	*PAT-53	0.528	0.780	0.189	0.197	
	NAT-32	0.374	0.528	0.126	0.138	
	NAT-42E	0.488	0.701		0.122	
	LST317BR	0.366	0.520	0.106	0.197	
	LST317BL					
	SST32	0.335	0.469	0.126	0.213	

Note: * marked shims are made of steel.

User's Guide - Parts for Tools

Shims

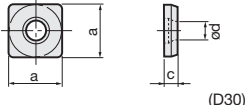
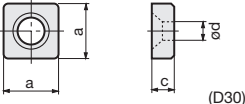
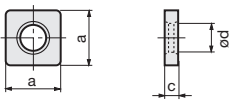
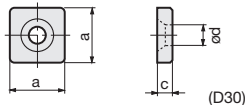
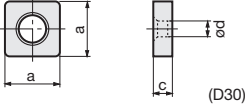
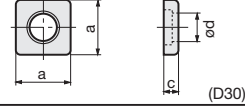
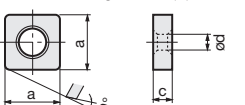
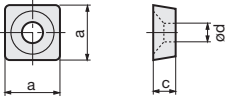
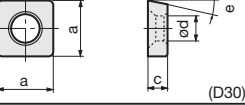
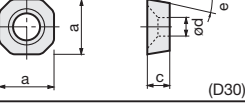
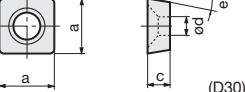
Shape	Designation	Dimension (in)				
		a	b	c	ød	e
	ASS422	0.492		0.126	0.173	
	CS44-A			0.185		
	ASS533	0.618		0.189	0.217	
	ASS634	0.744				
	ELSS32	0.335		0.126	0.193	
	LSS33	0.366		0.169	0.197	
	ELSS42	0.461		0.126	0.256	
	LSS42	0.492			0.264	
	ELSS53	0.579		0.189	0.315	
	LSS53	0.618			0.303	
	ELSS63	0.705			0.382	
	LSS63	0.744		0.252	0.508	
	ELSS84	0.953			0.516	
	LSS84	0.992				
	NAS-42	0.500		0.126	0.138	
	NAS-04	1.240		0.252	0.358	
	MSS-432	0.492		0.189	0.287	
	MSS-442			0.252		
	SSS32	0.335		0.126	0.213	
	LSS42BR	0.492		0.126	0.264	
	LSS42BL					
	PAS-32	0.323		0.126	0.118	
	PAS-42	0.449			0.138	
	*PAS-63	0.669		0.189	0.197	
	LSS42CA	0.492		0.126	0.264	8°
	LSS53CA	0.618		0.189	0.303	10°
	FSSA1102	0.457		0.079	0.217	13°
	FSSP1102	0.433		0.079	0.217	17°

Note: * marked shims are made of steel.

User's Guide - Parts for Tools

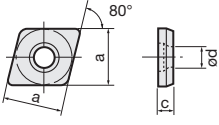
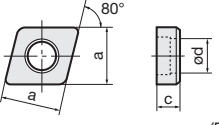
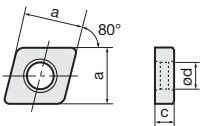
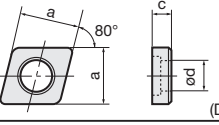
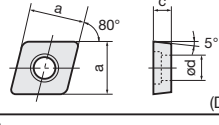
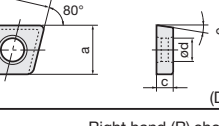
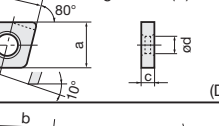
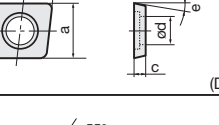
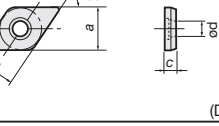
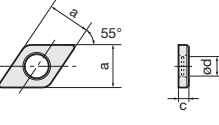
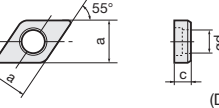
Shape	Designation	Dimension (in)				
		a	b	c	ød	e
 (D30)	ASC322	0.366		0.126	0.173	
	ASC422	0.492				
	ASC533	0.618		0.189	0.217	
	ASC634	0.744				
	CC44-A	0.492		0.185		
 (D30)	MSC-432	0.492		0.189	0.287	
	MSC-442			0.252		
	MSC-533	0.614		0.189	0.382	
	MSC-543					
	MSC-634	0.740		0.252	0.445	
 (D30)	ELSC32	0.335		0.126	0.244	
	LSC42	0.492				
	ELSC42	0.461		0.189	0.256	
	LSC53	0.618				
	ELSC53	0.579				
	ELSC63	0.705				
	LSC63	0.744			0.382	
	LSC317	0.366		0.106	0.197	
 (D30)	SSC32	0.335		0.126	0.213	
	SSC4T3	0.449		0.157	0.260	
 (D30)	SSC4T3-P	0.449		0.157	0.260	5°
	SSC54-P	0.528				
 (D30)	LSC42CA	0.492		0.126	0.264	8°
	LSC53CA	0.618		0.189	0.303	10°
 (D30)	LSC42BR	0.492		0.126	0.264	
	LSC42BL					
 (D30)	ZSA1102	0.413	0.433	0.079	0.216	11°
	ZSA1502	0.614	0.488			
 (D30)	ASD322	0.366		0.126	0.173	
	ASD423	0.492		0.126	0.173	
	ASD432	0.492		0.189	0.173	
	CD44-A	0.492		0.185		
 (D30)	ELSD32	0.335		0.126	0.193	
	ELSD42	0.461				
	LSD42	0.492		0.189	0.264	
	LSD42A					
	LSD43					
	LSD43A					
 (D30)	MSD-322	0.366		0.126	0.228	
	MSD-432	0.492		0.189	0.287	
	MSD-442			0.252		

Index | User's Guide | Tooling System | Drilling Tool | Endmill | Milling Cutter | Miniature Tool | Grooving | Threading | Int. Toolholder | Ext. Toolholder | Insert | Grade



User's Guide - Parts for Tools

Shims

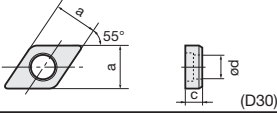
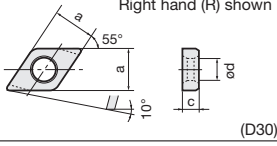
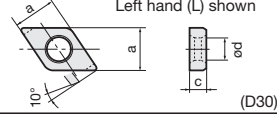
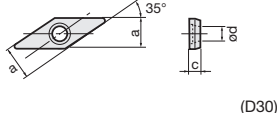
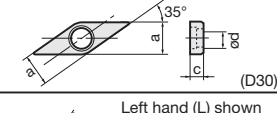
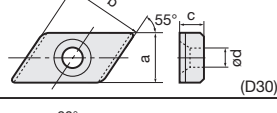
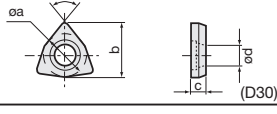
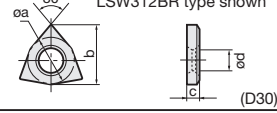
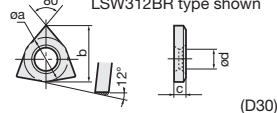
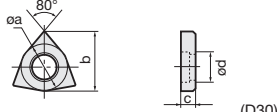
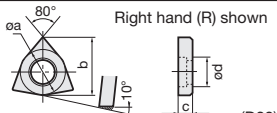
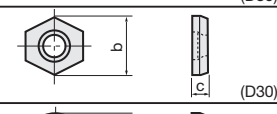
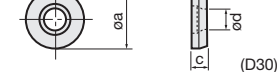
Shape	Designation	Dimension (in)				
		a	b	c	ød	
	SSD32	0.335		0.126	0.213	
	ELSD317BR	0.335		0.106	0.193	
	ELSD317BL					
	LSD42BR	0.492		0.126	0.264	
	LSD42BL					
	LSZ42BR	0.492		0.126	0.264	
	LSZ42BL					
	ASV222	0.274		0.125	0.130	
	ASV322	0.366		0.126	0.173	
	CV34-A	0.366		0.185		
	LSV212	0.281		0.087	0.195	
	MSV-322	0.365		0.126	0.228	
	SSV32	0.331			0.213	
	SSV42	0.433			0.248	
	CSK54R	0.370	0.583	0.189	0.138	
	CSK54L					
	ASW322	0.367	0.453	0.126	0.173	
	ASW422	0.492	0.598			
	LSW312	0.367	0.453	0.106	0.197	
	LSW42	0.492	0.610	0.126	0.264	
	LSW312BR	0.367	0.453	0.106	0.197	
	LSW312BL					
	MSW-432	0.504	0.622	0.189	0.287	
	MSW-533	0.630	0.776		0.382	
	MSW-633	0.756	0.933		0.445	
	MSW-432BR	0.504	0.622	0.189	0.287	
	MSW-432BL					
	CH44-A		0.492	0.185		
	ASR420	0.492		0.126	0.173	

User's Guide - Parts for Tools

Shims

Shape	Designation	Dimension (in)					
		ϕa	b	c	ϕd		
 (D30)	LSR32	0.350		0.126	0.197		
	LSR32C	0.331					
	LSR42	0.476					
	LSR42C	0.390			0.197		
	LSR53C	0.551		0.189	0.264		
	LSR63C	0.677			0.323		
	LSR84C	0.862			0.382		
 (D30)	MSR-43	0.492		0.189	0.287		
	MSR-44			0.252			
 (D30)	SSR32	0.343		0.125	0.205		
 Right hand (R) shown (D30)	G16EL/IR	0.374		0.126	0.157		
	G16ER/IL			0.126			
	G16EL/IR-DT			0.156	0.213		
	G16ER/IL-DT			0.156			

Shims

Shape	Designation	Dimension (in)		
		ϕa	l	Lead angle
 (D30)	AE16-4DT	0.374	0.213	4°
	AE16-3DT		0.213	3°
	AE16-2DT		0.213	2°
	A16-1DT		0.213	1°
	AE16-0DT		0.213	0°
	AE16-99DT		0.213	-1°
	AE16-98DT		0.213	-2°
	AE16-4		0.157	4°
	AE16-3		0.157	3°
	AE16-2		0.157	2°
	A16-1		0.169	1°
	AE16-0		0.157	0°
	AE16-99		0.157	-1°
	AE16-98		0.157	-2°
	AN16-4DT	0.374	0.213	4°
	AN16-3DT		0.213	3°
	AN16-2DT		0.213	2°
	AN16-0DT		0.213	0°
	AN16-99DT		0.213	-1°
	AN16-98DT		0.213	-2°
	AN16-4		0.157	4°
	AN16-3		0.157	3°
	AN16-2		0.157	2°
	AN16-0		0.157	0°
	AN16-99		0.157	-1°
	AN16-98		0.157	-2°

Grade
 Insert
 Toolholder
 Ext. Toolholder
 Int. Toolholder
 Threading
 Grooving
 Miniature Tool
 Milling Cutter
 Endmill
 Drilling Tool
 Tooling System
 Index



User's Guide - Parts for Tools

Shims

Shape	Designation	Dimension (in)		
		ϕa	l	Lead angle
	GXE16-98	0.374	0.157	-2°
	GXE16-98DT		0.213	-2°
	GXE16-99		0.157	-1°
	GXE16-99DT		0.213	-1°
	GXE16-0		0.157	0°
	GXE16-0DT		0.213	0°
	GXE16-1		0.169	1°
	GX16-1DT		0.213	1°
	GXE16-2		0.157	2°
	GXE16-2DT		0.213	2°
	GXE16-3		0.157	3°
	GXE16-3DT		0.213	3°
	GXE16-4		0.157	4°
	GXE16-4DT		0.213	4°
	GXE22-98DT	0.500	0.260	-2°
	GXE22-99DT			-1°
	GXE22-0DT			0°
	GX22-1DT			1°
	GXE22-2DT			2°
	GXE22-3DT			3°
	GXE22-4DT	4°		
	GXN16-98	0.374	0.157	-2°
	GXN16-98DT		0.213	-2°
	GXN16-99		0.157	-1°
	GXN16-99DT		0.213	-1°
	GXN16-0		0.157	0°
	GXN16-0DT		0.213	0°
	GXN16-1		0.169	1°
	GXN16-2		0.157	2°
	GXN16-2DT		0.213	2°
	GXN16-3		0.157	3°
	GXN16-3DT		0.213	3°
	GXN16-4		0.157	4°
	GXN16-4DT		0.213	4°
	GXN22-98DT		0.500	0.260
	GXN22-99DT	-1°		
	GXN22-0DT	0°		
	GXN22-2DT	2°		
	GXN22-3DT	3°		
	GXN22-4DT	4°		

User's Guide - Parts for Tools

Shims

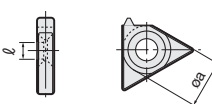
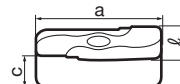
Shape	Designation	Dimension (in)								
		a	øa	ℓ	c	Lead angle				
	NXE22-98	0.500	0.500	0.157	0.177	-2°				
	NXE22-99					-1°				
	NXE22-0					0°				
	NXE22-1					1°				
	NXE22-2					2°				
	NXE22-3					3°				
	NXE22-4					4°				
	NXE27-98					0.626	0.626	0.157	0.177	-2°
	NXE27-99									-1°
	NXE27-0									0°
	NXE27-1	1°								
	NXE27-2	2°								
	NXE27-3	3°								
	NXE27-4	4°								
	NXN22-98	0.500	0.500	0.157	0.177	-2°				
	NXN22-99					-1°				
	NXN22-0					0°				
	NXN22-1					1°				
	NXN22-2					2°				
	NXN22-3					3°				
NXN22-4	4°									
NXN27-98	0.626					0.626	0.157	0.177	-2°	
NXN27-99		-1°								
NXN27-0		0°								
NXN27-1		1°								
NXN27-2		2°								
NXN27-3		3°								
NXN27-4	4°									
(D30)										
	TSL12R	0.472		0.185	0.177	4.5°				
	TSL12L	0.472		0.185	0.177	4.5°				
	TSL16R	0.626		0.252	0.197	5°				
	TSL16L	0.626		0.252	0.197	5°				
	TSL24R	0.937		0.370	0.280	7°				
	TSL24L	0.937		0.370	0.280	7°				
	TSL12RI	0.421		0.185	0.177	4.5°				
	TSL12LI	0.421		0.185	0.177	4.5°				
	TSL16RI	0.740		0.252	0.197	5°				
	TSL16LI	0.740		0.252	0.197	5°				
(D30)										

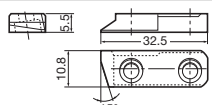
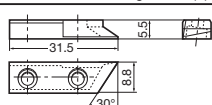
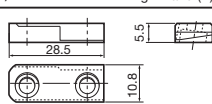
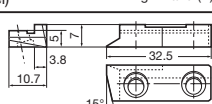
Shape	Designation
	SL-1R
	SL-1L
(Steel) Right hand (R) shown	
	SL-2R
	SL-2L
(Steel) Right hand (R) shown	
	SL-3R
	SL-3L
(Steel) Right hand (R) shown	
	SL-6R
	SL-6L
(Steel) Right hand (R) shown	
(Unit: mm)	

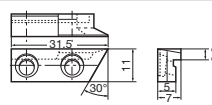
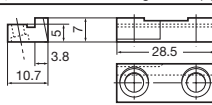
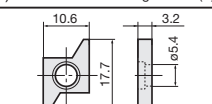
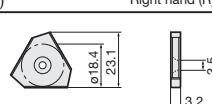
Shape	Designation
	SL-7R
	SL-7L
(Steel) Right hand (R) shown	
	SL-8R
	SL-8L
(Steel) Right hand (R) shown	
	SGSR151
	SGSL151
(D30) Right hand (R) shown	
	STN62R
	STN62L
(D30) Right hand (R) shown	
(Unit: mm)	

Grade
Insert
Toolholder
Ext. Toolholder
Int. Toolholder
Threading
Grooving
Miniature Tool
Milling Cutter
Endmill
Drilling Tool
Tooling System
Index



User's Guide - Parts for Tools

Clamps

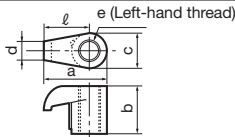
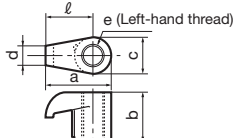
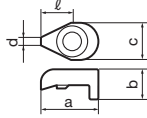
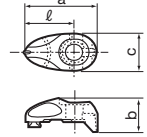
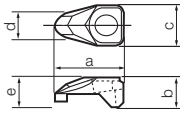
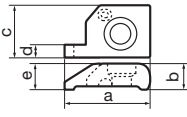
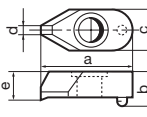
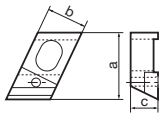
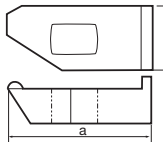
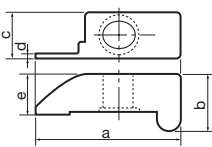
Shape	Designation	Dimension (in)					
		a	b	c	d	e	ℓ
 (Steel)	MCL-5M	0.579	0.433	0.307	0.157	M5	0.425
	MCL-6	0.732	0.453	0.374		M6	0.543
	MCL-8S	0.752	0.531	0.429	0.197	M8	0.535
	MCL-8M	0.886					0.669
	MCL-8L	1.004	0.571	0.157	0.787		
 (Steel)	MCPM-6	0.579	0.441	0.311	0.157	M5	0.425
	MCPM-9	0.752	0.661	0.429	0.197	M8×1	0.535
	MCPM-12	0.886					0.669
	MCPM-20	0.732	0.374	0.374	0.157	M6	0.543
	MCPM-21		0.480				
	MCPM-22	0.846	0.520	0.657			
	MCPM-30	1.004	0.661	0.429	0.197	M8×1	0.787
 (Steel)	DCPM-33	0.630	0.366	0.413	0.094		0.335
	DCPM-43	0.835	0.453	0.531	0.118		0.520
	DCPM-54	1.016	0.600	0.551	0.138		
	DCPM-64	1.118	0.610	0.630	0.157		
 (Steel)	ACP3S	0.898	0.374	0.394			0.591
	ACP3S-E	0.854	0.374	0.394			0.547
	ACP3L-3	1.038	0.472	0.512			0.723
	ACP4S	1.012	0.472	0.512			0.697
	ACP5S	1.185	0.508	0.591	-	-	0.815
	ACP6S	1.315	0.504	0.650	-	-	0.945
 (Steel)	ACP3	0.705	0.394	0.394	0.256	0.248	
	ACP4	1.020	0.547	0.472	0.276	0.425	
 (Steel) Right hand (R) shown	CTC-3R	1.142	0.346	0.630	0.087	0.315	
	CTC-3L						
	CTC-4R			0.669	0.126		
	CTC-4L						
	CTC-5R			0.709	0.165		
CTC-5L							
 (Steel)	CP81A	1.102	0.413	0.472	0.138	0.315	
	CP81B						
 (Steel) TC-3 type shown, TC-4 : Left-hand thread	TC-3	0.748	0.492	0.327			
	TC-4	0.850		0.315			
 (Steel)	TF-72	0.866	0.445				
	TF-73	0.866	0.445				
	TF-184	0.866	0.445				
	TF-185	0.866	0.445				
 (Steel)	CCR2	1.366	0.587	0.421	0.047	0.413	
	CCL2						
	CCR3				0.087		
	CCL3						
	CCR4				0.110		
	CCL4						
	CCR5				0.126		
	CCL5						
	CCR6				0.154		
	CCL6						
	CCR8				0.193		
CCL8							

User's Guide - Parts for Tools

Clamps

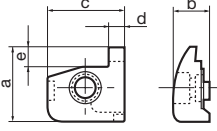
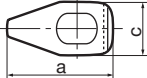
Shape	Designation	Dimension (in)							
		a	b	c	d	e			
 <p>Right hand (R) shown</p>	CFG-3SR	0.866	0.433	0.909	0.079	0.236			
	CFG-3SL								
	CFG-4SR								
	CFG-4SL								
	CFG-4DR	1.260				0.118		0.630	
	CFG-4DL								
	CFG-5SR	0.866				0.157		0.236	
	CFG-5SL								
	CFG-5DR	1.260					0.630		
	CFG-5DL								
	CFG-6SR	0.906			0.197		0.276		
	CFG-6SL								
	CFG-6DR	1.299				0.669			
	CFG-6DL								
	CFG-8SR	1.102			1.067	0.276	0.315		
	CFG-8SL								
CFG-8DR	1.496			0.709					
CFG-8DL									
(Steel)									
	CCP4-A	1.146		0.551					
	(Steel)								

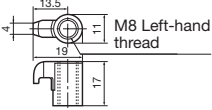
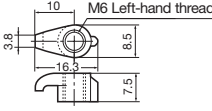
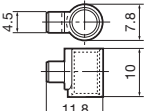
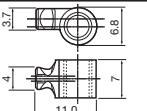
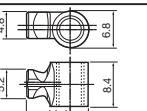
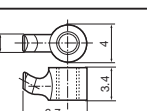
Shape	Designation
 <p>M8 Left-hand thread</p>	NF-84A
(Steel)	
 <p>M6 Left-hand thread</p>	CP536
(Steel)	
	CP91
(Steel)	
	CP900
(Steel)	
	CP910
(Steel)	
	JCP-1
(Steel)	
(Unit: mm)	

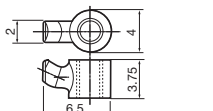
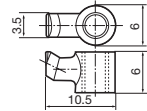
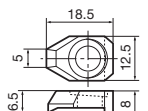
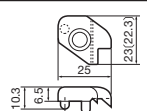
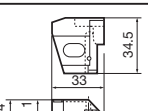
Shape	Designation
	JCP-2
(Steel)	
	JCP-3 JCP-3N
(Steel)	
	CQ-1
(Steel)	
 <p>Right hand (R) shown (Steel)</p>	CPK5R CPK5L
(Steel)	
 <p>Right hand (R) shown (Steel)</p>	C11R-5 C11L-5
(Steel)	
(Unit: mm)	

User's Guide - Parts for Tools

Clamp Sets

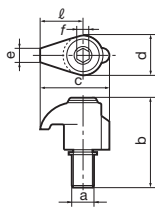
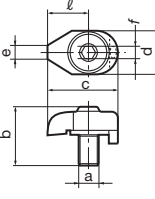
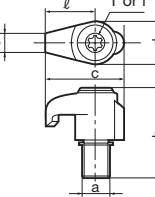
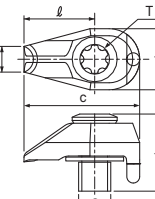
Shape	Designation	Dimension (in)						
		a	b	c	d	e	ℓ	T / f
 (Steel)	CSG-5S	M5×0.8	0.531	0.543	0.276	0.071	0.335	0.098
	CSG-5		0.610					
	CSG-6S	M6×1	0.709	0.642	0.335	0.098	0.394	0.118
	CSG-6L		0.846					
	CSG-8S	M8×1	0.827	0.807	0.433	0.138	0.492	0.157
	CSG-8		0.925					
 (Steel)	CSW-00	M4×0.7	0.453	0.472	0.315	0.079	0.295	0.098
	CSW-1	M5×0.8	0.650	0.650	0.374	0.157	0.394	0.118
	CSW-0	M4×0.7	0.453	0.543	0.335	0.098	0.315	0.098
	CSW-2	M6×1	0.787	0.807	0.433	0.236	0.512	0.157
	CSW-40	M4×0.7	0.472	0.520	0.315	0.079	0.295	0.098
	CSW-50	M5×0.8	0.591	0.665	0.394		0.374	0.118
 (Steel)	CSP16	M5×0.8	0.610	0.567	0.272	0.126	0.358	T15
	CSP22	M6×1	0.787	0.713	0.350	0.165	0.453	T20
	CSP27	M8×1.25	0.925	0.961	0.469	0.154	0.614	0.157
 (Steel)	CSY-15	M4×0.7	0.457	0.453	0.276	0.118	0.236	15IP
	CSY-20	M5×0.8	0.472	0.709	0.374	0.157	0.433	20IP

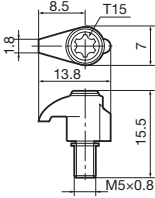
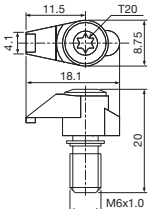
Shape	Designation
 (Steel)	CSG-5T
 (Steel)	CSX20

(Unit: mm)

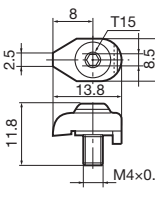
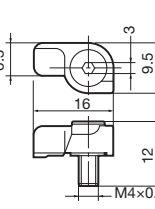
Shape	Designation
 (Steel)	CSW-0T
 (Steel)	CSL-4

(Unit: mm)

User's Guide - Parts for Tools

Levers

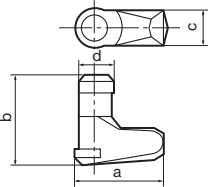
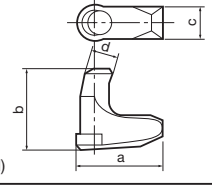
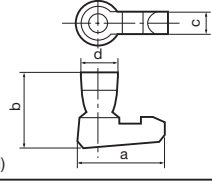
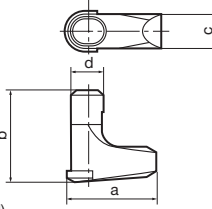
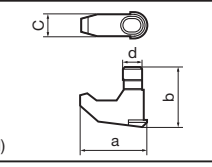
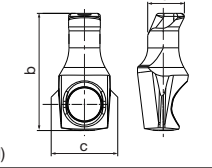
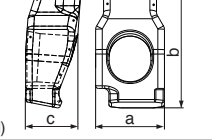
Shape	Designation	Dimension (in)			
		a	b	c	d
 (Steel)	LCL3	0.394	0.472	0.146	0.142
	LCL4	0.575	0.551	0.185	0.185
	LCL5	0.673	0.669	0.236	0.236
	LCL6	0.807	0.827	0.295	0.295
	LCL8	1.000	1.000	0.339	0.339
 (Steel)	LCL3C	0.425	0.465	0.134	0.118
	LCL4C	0.512	0.528	0.146	0.134
	LCL5C	0.732	0.697	0.185	0.177
	LCL6C	0.807	0.748	0.236	0.224
	LCL8C	0.953	0.925	0.295	0.244
 (Steel)	LCL22N	0.295	0.256	0.102	0.081
	LCL32N	0.394	0.307	0.126	0.126
	LCL33NL	0.453	0.374	0.122	0.142
	LCL33N	0.394	0.370	0.126	0.126
	LCL43N	0.528	0.394	0.185	0.185
 (Steel)	LCL23	0.307	0.335	0.102	0.083
	LCL33	0.398	0.476	0.142	0.146
	LCL33L	0.472	0.453	0.122	0.142
	LCL43S	0.531	0.520	0.185	0.185
	LCL43M				
	LCL44	0.634	0.575	0.185	0.185
	LCL54	0.650	0.677	0.240	0.236
 (Steel)	DLCL43	0.612	0.551	0.197	0.185
	DLCL54	0.752	0.752	0.240	0.236
	DLCL64	0.846	0.827	0.295	0.295
 (Steel)	SLLV-1		0.305	0.134	0.096
	SLLV-2		0.305	0.134	0.108
 (Steel)	FCL4	0.197	0.306	0.150	
	FCL8	0.394	0.563	0.212	

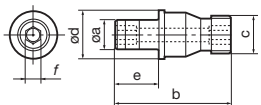
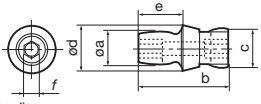
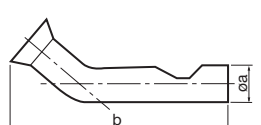

User's Guide - Parts for Tools

Pins

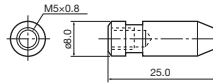
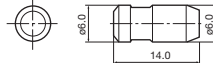
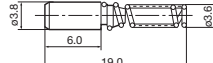
Shape	Designation	Dimension (in)					
		ϕa	b	ϕc	ϕd	e	f
 (Steel)	MLP32L	0.154	0.346	M5x0.8	0.220	0.138	0.079
	MLP33	0.146					
	MLP34L	0.146	0.516	0.244	0.197		
	MLP46	0.197	0.677	M6.3x1	0.307	0.217	0.098
	MLP46L		0.732				
	MLP58	0.244	0.862	M8x1	0.406	0.272	0.118
	MLP68	0.307		M10x1	0.469		0.358
	MLP68L						
 (Steel)	MLP44	0.197	0.520	M6.3x1	0.280	0.217	0.098
	MLP33L	0.146	0.409	M5x0.8	0.220	0.201	0.079
 (Steel)	SW99	0.315	1.870				

Shape	Designation
 (Steel)	SP-8
 (Steel)	SP-6
 (Steel)	BP-3

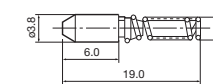
(Unit: mm)

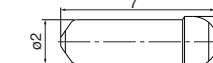
Shape	Designation
 (Steel)	BP-360
 (Steel)	BP-490
 (Steel)	SL-PI-2

(Unit: mm)

User's Guide - Parts for Tools

Chipbreaker Pieces

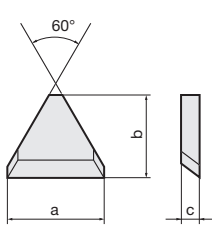
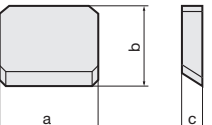
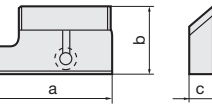
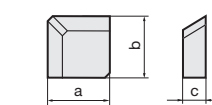
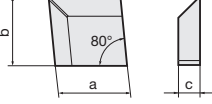
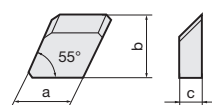
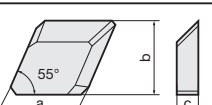
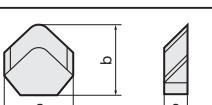
Shape	Designation	Dimension (in)			
		a	b	c	
 (TX30)	CBT-2S	0.346	0.299	0.079	
	CBT-2M	0.291	0.260		
	CBT-3S	0.524	0.476	0.098	
	CBT-3M	0.484	0.437		
	CBT-3L	0.445	0.398		
	CBT-4S	0.740	0.665		
	CBT-4M	0.701	0.626		
	CBT-4L	0.661	0.567		
	NCT-2S	0.559	0.465		
	NCT-2M	0.512	0.425		
	NCT-2L	0.469	0.386		
 (TX30)	CBS-3S	0.374	0.327	0.079	
	CBS-3M		0.287		
	CBS-4S	0.500	0.457	0.098	
	CBS-4SN				
	CBS-4M		0.417		
	CBS-4L		0.358		
	NCS-3S		0.441		
	NCS-3M		0.402		
	NCS-3L	0.343			
 Right hand (R) shown (TX30)	B11 R-5	0.945	0.512	0.197	
	B11 L-5				
 (TX30)	CBS-4SN	0.453	0.453	0.098	
	CBS-4MN	0.413	0.413		
	CBS-4LN	0.354	0.354		
	NCS-3SN	0.441	0.441		
	NCS-3MN	0.402	0.402		
	NCS-3LN	0.343	0.343		
 (TX30)	CBC-4SN	0.453	0.453	0.098	
	CBC-4MN	0.413	0.413		
	CBC-4LN	0.374	0.374		
 Right hand (R) shown (TX30)	CBD-4SR	0.500	0.453	0.098	
	CBD-4MR		0.413		
	CBD-4ML				
	CBD-4LR		0.374		
 (TX30)	CBD-4SN	0.453	0.453	0.098	
	CBD-4MN	0.413	0.413		
 (TX30)	CBR-4SN	0.500	0.469	0.098	
	CBR-4MN		0.429		

Grade

Insert

Toolholder

Ext. Toolholder

Int. Toolholder

Threading

Grooving

Miniature Tool

Milling Cutter

Endmill

Drilling Tool

Tooling System

Index

User's Guide



User's Guide - Parts for Tools

Springs (Springs for Shims)

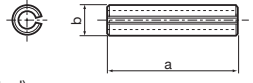
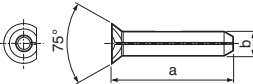
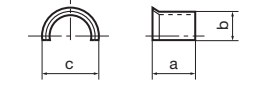
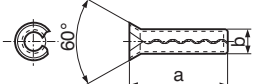
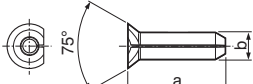
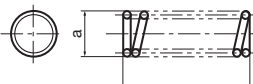
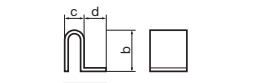
Shape	Designation	Dimension (in)					
		a	b	c	d		
 (Steel)	SP-2.5	0.472	0.106				
 (Steel)	SP-16-L14	0.535	0.112				
 (Steel)	LSP3	0.217	0.118	0.232			
	LSP3L	0.276					
	LSP4		0.157	0.299			
	LSP4S						
	LSP5	0.335	0.177	0.346			
	LSP6	0.433	0.232	0.429			
	LSP6C	0.335	0.189	0.366			
	LSP8	0.472	0.394	0.606			
 (Steel)	PSP-2.5	0.394	0.106				
	PSP-4.0	0.630	0.165				
	PSP301	0.299	0.118				
 (Steel)	PSP-16	0.384	0.112				
 (Steel)	BP-0	0.142	0.512				
	BP-5-A						
	BP-7	0.276	0.433				
	BP-8.8	0.346	0.394				
	BP-9	0.327					
	BP-10	0.358					
	SP913	0.354	0.512				
 (Steel)	BSP-1	0.307	0.295	0.189	0.236		

Coolant Supply Attachment

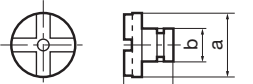
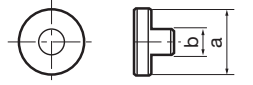
Shape	Designation	Dimension (in)					
		a	b	c	Thread		
 (Plastic)	EA-20	0.787	0.394	0.591			
	EA-25	0.984					
	EA-32	1.260	0.630				
 (Plastic)	CA-16	0.630	0.315		M6		
	CA-20	0.787	0.335		M6		
	CA-25	0.984	0.453		R1/8		
	CA-32	1.260	0.453		R1/8		
	CA-40	1.575	0.453		R1/8		

User's Guide - Parts for Tools

Pistons

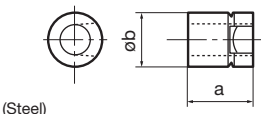
Shape	Designation	Dimension (in)			
		a	øb		
 (Steel)	DPIS33	0.496	0.354		
	DPIS43	0.465	0.394		
	DPIS44	0.528	0.394		
	DPIS54	0.630	0.512		
	DPIS64			0.591	

Nuts

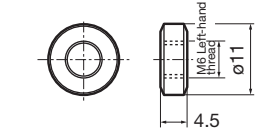
Shape	Designation
 (Unit: mm)	SRW11

Coolant Pipe & Nozzle

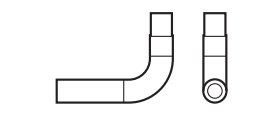
Shape	Designation
	PNZ5

Coolant Nozzle

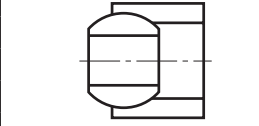
Shape	Designation
	CNZ125
	SATZ-M8X1-M3
	SATZ-M10X1-M5
	EZ104
	EZ83

Coolant unit

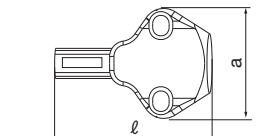
Shape	Designation	Dimension (in)	
		a	ℓ
	CU-CW-CHP	0.819	1.169
	CU-D-CHP	0.819	1.165
	CU-V-CHP	0.819	1.181

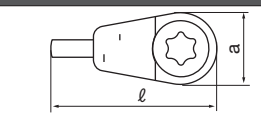
Shape	Designation	Dimension (in)	
		a	ℓ
	S-CU-CHP	0.276	0.638

O-ring for TungTurn-Jet

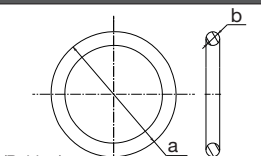
Shape	Designation	Dimension (in)			
		a	øb		
 (Rubber)	OR6.4X0.9N	0.323	0.035		
	OR14X2.5NN	0.748	0.098		

User's Guide - Parts for Tools

Coolant screw for TungTurn-Jet

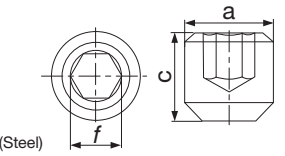
Shape	Designation	Dimension (in)			
		a	c		T / f
 (Steel)	SRM4X4 TL360	M4	0.157		0.079

Mounting screw for TungTurn-Jet

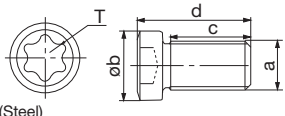
Shape	Designation	Dimension (in)				
		a	øb	c	d	T / f
 (Steel)	SRM3	M3X0.5	0.165	0.276	0.193	T8

Sizing Plates

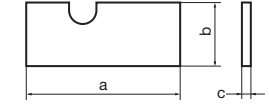
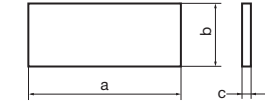
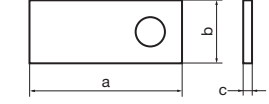
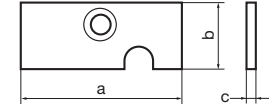
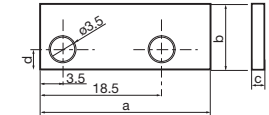
Shape	Designation	Dimension (in)			
		a	b	c	d
 (Steel)	S0816A	2.165	0.610	0.031	
	S1016A			0.039	
	S0816B	1.969		0.031	
	S1016B			0.039	
	S0816C	1.772	0.031		
	S1016C		0.039		
	S0820A	2.402	0.768	0.031	
	S1020A			0.039	
	S0820B	2.146		0.031	
	S1020B			0.039	
SM-00	0.709	0.315	0.039		
 (Steel)	SW04	1.004	0.228	0.010	
	SW05	1.457	0.327	0.020	
	SW06	1.417	0.425	0.039	
	SW08	1.398	0.484	0.079	
 (Steel)	S0810	1.575	0.433	0.031	
	S1010			0.039	
 Attached with fix screw and wrench. (Steel)	PSTR08	0.945	0.433	0.059	
	PSTL08				
	PSTR10	1.654	0.650	0.079	
	PSTL10				
	PSTR12	1.850	0.748	0.079	
PSTL12					
 (Steel)	AP0801	1.024	0.374	0.020	0.118
	AP0802			0.039	
	AP0803			0.059	
	AP0804			0.079	
	AP0805			0.098	
	AP1101			1.181	
	AP1102	0.039			
	AP1103	0.059			
	AP1104	0.079			
	AP1105	0.098			
	AP1106	0.118			

SW04 is composed of three plates and SW05 to SW08 are composed of four plates.

Note on fixing screws: PSTR/L08 is attached with CSSM2-4 and other types are attached with CSHM3-8.

User's Guide - Parts for Tools

Washers

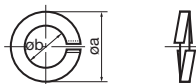
Shape	Designation	Dimension (in)					
		øa	øb				
	VA4	0.299	0.161				
	VA5	0.362	0.201				
	VA6	0.413	0.240				

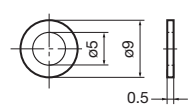
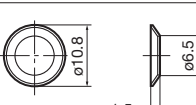
Shape	Designation
	CPW5
	CDW6

(Unit: mm)

Wrenches and Drivers

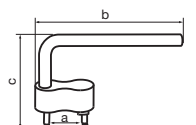
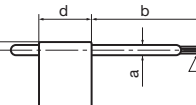
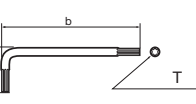
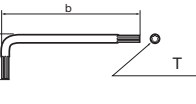
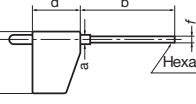
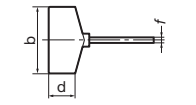
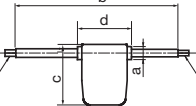
Shape	Designation	Dimension (in)					
		a	b	c	d	f	T
	CRW23	0.382	3.091	2.165			
	CRW33	0.366					
	T-6F	0.079	1.378	0.571	0.591	T6	
	T-7F			0.748	0.748	T7	
	T-8F			0.098	1.575	0.748	0.748
	T-9F	0.118	0.925	0.787		T9	
	T-15F	0.138	1.772	1.102	0.827		T15
	T-20F	0.157					T20
	IP-6F	0.079				1.378	0.583
	SET T-15/5	0.138	1.772	1.102	0.827		T15
	T-20TORX	0.154	1.929	1.181	0.866		T20
	T-6L		1.890	0.630		T6	
	T-8L					T8	
	T-9L					T9	
	T-15L		2.323	0.866		T15	
	T-25TORX		2.598	0.917		T25	
	KEYV-T20		2.362	0.866		T20	
	KEYV-T25		2.559	0.906		T25	
	KEYV-T30L		7.480	1.457		T30	
	KEYV-T40L		8.189	1.693		T40	
	KEYV-T50L		9.134	1.890		T50	
	P-2F	0.157	1.732	0.787	0.492	0.079	
	P-2.5F	0.197	1.772	0.984	0.787	0.098	
	HW2.0/5RED	0.118	1.496	0.591	0.591	0.079	
	P-2.5T		1.654		0.591	0.098	
	T-1008/5	0.256	3.346	1.102	0.984	T10/T8	
	T-2010/5					T10/T20	



User's Guide - Parts for Tools

Wrenches, Drivers and Lubricant

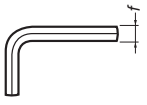
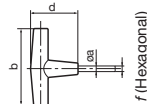
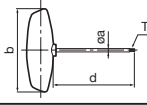
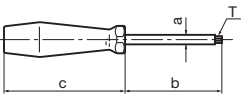
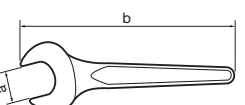
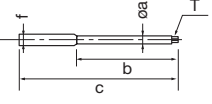
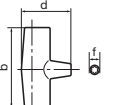
Shape	Designation	Dimension (in)					
		a	b	c	d	f	T
	1/4HEX					0.250	
	5/32HEX					0.156	
	1/8HEX					0.125	
	3/32HEX					0.094	
	P-1.5					0.059	
	P-2					0.079	
	P-2.5					0.098	
	P-3					0.118	
	P-3.5					0.138	
	P-4					0.157	
	P-4.5					0.177	
	P-5					0.197	
P-6					0.236		
	TP-3A		2.756		1.791	0.118	
	TP-4					0.157	
	TP-5		3.346		2.087	0.197	
	T-27T	0.197	3.346		1.654		T27
	T-15T						T15
	T-20T	0.157	3.937		3.937		T20
	IP-20T						20IP
 <p>Handle shape somewhat varies depending on the type number from the above figure.</p>	T-6D	0.098					T6
	T-7D	0.079	1.772	2.756			T7
	T-8D	0.102	2.402	2.657			T8
	T-9D	0.118	2.559	3.150			T9
	T-10D	0.130	2.756	3.543			T10
	T-15D	0.144	2.795				T15
	T-20D	0.181	3.543	3.937			T20
	T-25D	0.173	3.425	3.386			T25
	IP-6DB		1.772	2.756			6IP
	IP-7D	0.098	1.772	2.953			7IP
	IP-8D	0.118	2.165	3.150			8IP
	IP-10D	0.130	2.795	3.504			10IP
	IP-15D	0.157	3.150	3.937			15IP
	IP-20D	0.157	3.543	3.937			20IP
	KS-21	0.827	7.677				
	KS-24	0.945	8.465				
	KS-27	1.063	9.252				
	KS-32	1.260	10.827				
	KS-36	1.417	12.008				
	M-1000						
	BT15S	0.154	1.969	3.543		0.236	T15
	BT15M	0.154	1.969	4.646		0.236	T15
	BT20S	0.181	1.969	3.543		0.236	T20
	BT20M	0.181	1.969	4.646		0.236	T20
	BLD IP15/S7	0.154	1.969	3.543		0.236	15IP
	BLD IP15/M7	0.154	1.969	4.646		0.236	15IP
	BLD IP20/S7	0.181	1.969	3.543		0.236	20IP
	BLD IP20/M7	0.181	1.969	4.646		0.236	20IP
	BLD T10/S7	0.154	2.244	2.953		0.236	T10
	BLD T10/S7-A	0.154	2.244	2.953		0.236	T10
	H-TB		3.937		1.457	0.236	
	H-TBS		2.953		1.457	0.236	

User's Guide - Parts for Tools

Wrenches and Drivers

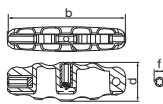
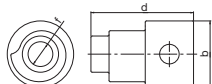
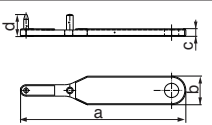
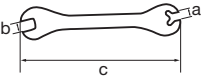
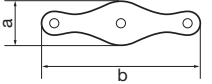
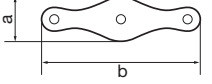
Shape	Designation	Dimension (in)					
		a	b	c	d	f	
	H-TB2W		3.740		1.236	0.236	
	AJC08		0.433		0.669	0.161	
	ECW-456EF	3.425	0.591	0.157	0.453		
	ECW-456I	3.169	0.866	0.157	0.413		
	KEYV-S05	0.157	0.217	3.937			
	KEYV-S06	0.213	0.315	4.921			
	KEYV-S08	0.260	0.394	5.906			
	KEYV-S10	0.303	0.512	6.890			
	KEYV-S12	0.370	0.630	9.843			
	KEYV-W20						
	KEYV-177	1.142	4.331				
	KEYV-217	1.142	4.331				
	KGDT-100	1.260	4.272				
	KGDT-110	1.260	4.272				
	KGDT-120	1.260	4.272				
	KGDT-130	1.260	4.272				
	KGDT-140	1.260	4.272				
	KGDT-150	1.260	4.272				

Grade
 Insert
 Ext. Toolholder
 Int. Toolholder
 Threading
 Grooving
 Miniature Tool
 Milling Cutter
 Endmill
 Drilling Tool
 Tooling System
 User's Guide
 Index



User's Guide - Parts for Tools

Locators

Designation	Applicable Tool
LD150R	TXD15125R ~ TXD15315R
LD440R/L	TMD44 TGD4400R/L-A TFD44
LD442R/L	EGD4400R
LD540R/L	TMD54
LE302R	ESE3050R (RS**) ~ 3063R (RS**)
LE303R/L	TSE3003R/LIA ~ 3006R/LIA
LE402AR	ESE4050RA ESE4063RA
LE403R/L	TSE4003R/LIA TSE4004R/LIA ESE4003RIA-S32
LE405R/L	TSE4005R/LIA ~ 4012R/LIA
LE413R/L	THE40
LE444R/L	TME4403R/LI ~ 4405R/LI TME4403R/LB ~ 4405R/LB EME4405R ~ 4404RI
LE446R/L	TME4406R/LI ~ 4412R/LI TME4406R/LB ~ 4412R/LB
LE540R/L	TME54
LF440R/L	THF44
LF540R/L	THF54
LF602R	ERF6050R ~ ERF6063R
LF602R/L	TRF6003R/LI ~ TRF6006R/LI TRF6008R/LI ~ TRF6012R/LI
LMS56R/L	MS08R/L ~ MS12R/L
LN423R/L	TGN42
LN645R/L	TPN64
LP403R/L	TSP4003R/LIA ~ TSP4004R/LIA TFP4004R/LIA
LP405R/L	TSP4005R/LIA ~ TSP4012R/LIA TFP4005R/LIA ~ TFP4012R/LIA
LP413R/L	TGP41 TGP42
LP514R/L	TGP51
LPP16R	TPP16
LR602R/L	ERD6050RA ~ ERD6063RA
LR603R/L	TRD6003R/L TRD6004R/L ~ TRD6008R/L
LV525R/L	VSN 1
LV530R/L	VSN 2
LV556R/L	VSN60
LW400R	EFP4063R
LW400R/L	TFD44 TFP4000 SFP4000
LW402R	EFP4050R

Insert locking wedges

Designation	Applicable Tool
FDS-8SST	EDPD09063R EDPD09063RB
FDS-8ST-18	EDP09080R EDPD09080RB DPD09100R~DPD09160R DPD09100RB~DPD09160RB
FW-242R	DPD24063R
FW-243R	DPD24080R, DPD24100R
FW-245R	DPD24125R, DPD24160R
FW304R/L-D	DAD15 DPD15 EDPD15 QPP15
LE302R	ESE3050R (RS**) ~ 3063R (RS**)
WF150R	TXD15125R ~ TXD15315R
WF310R/L	TGP4100BA TGP4103R/LIA
WF330N	TSE4003R/LIA TSE4004R/LIA ESE4003RIA-S32 TSP4003R/LIA ~ TSP4004R/LIA TFP4004R/LIA
WF330R/L	TSE3003R/LIA ~ 3006R/LIA
WF444R/L	TME4403R/LI ~ 4405R/LI TME4403R/LB ~ 4405R/LB EME4405R ~ 4404RI TME4406R/LI ~ 4412R/LI TME4406R/LB ~ 4412R/LB
WF500R	TSE4005R/LIA ~ 4012R/LIA TSP4005R/LIA ~ TSP4012R/LIA TFP4005R/LIA ~ TFP4012R/LIA
WF500R/L	TMD54 TGP51 THF54
WF50R/L	TME54
WF602R	ERF6050R ~ ERF6063R
WF603R/L	TRF6003R/LI ~ TRF6008R/LI
WF608R/L	TRF6008R/LI ~ TRF6012R/LI
WF875N	TPYD06 EPYD06
WN645R/L	TPN64
WP193TR/L	EGD4400R
WP440R/L	TMD44 TGD4400R/L-A TFD44 TGP4100IA ~ TGP4112R/LIA TGP42 THF44 THE40
WR602R/LW	ERD6050RA ~ ERD6063RA
WR603R/L	TRD6003R/L TRD6004R/L ~ TRD6008R/L
WT402R	ESE4050RA ESE4063RA
WT402R/L	EME4450RB ~ 4404RB

User's Guide - Parts for Tools

Locator adjusting wedges

Designation	Applicable Tool
FW-305	TFD44 TFP40 SFP4000 EFP4063
FW325R/L-D	DAD15 QPP15 DPD15 EDPD15
RSFTC1008	TPYP12...
RSFTC1009	EPYP12M032C25.0R05
RSFTC1011	EPYP12M025C25.0R03

Fine adjusting screws

Designation	Applicable Tool
AJM5	DPD09 EDPD09
ASM34L	DPD24

Cover

Designation	Applicable Tool
RSFTS6063M	TPYP12M063B22.0R10
RSFTS6080	TPYP12*080B**R12
RSFTS6100	TPYP12*100B**R16
RSFTS6125	TPYP12*125B**R20

User's Guide - Technical Reference

Turning Tools

Name of tool parts

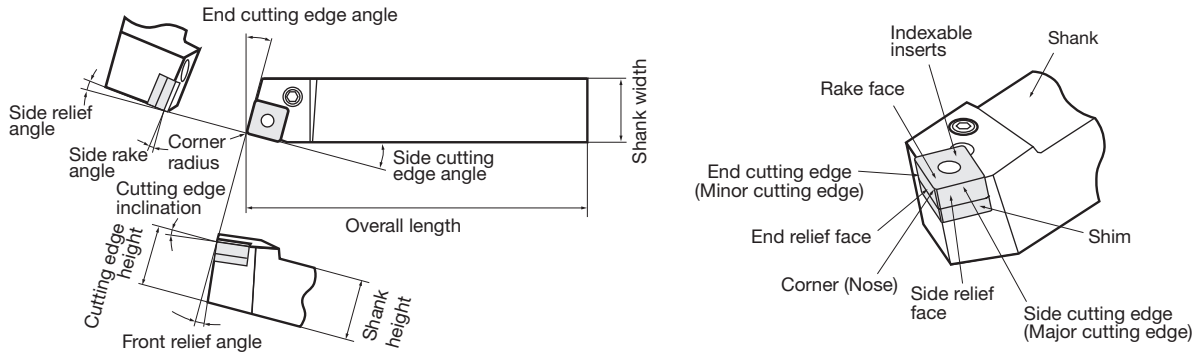

Relating angles between tool and workpiece

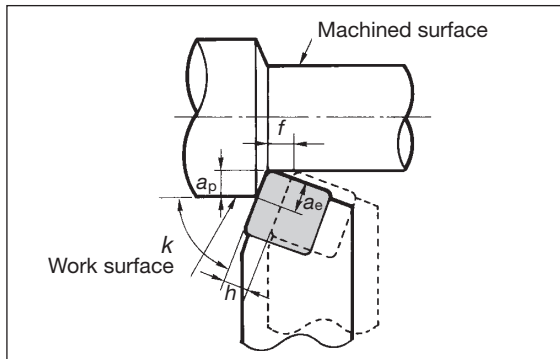

- a_p ... Depth of cut (Distance between work surface and machined surface)
- a_e ... Length of cutting edge engaging in cutting.
- k ... Cutting edge angle (Angle to be made by cutting edge and work surface)
- f ... Feed per revolution
- h ... Thickness to be cut per revolution
- Machined surface ... Workpiece surface after having machined.
- Work surface ... Workpiece surface to be cut.

Effect of side cutting edge angle

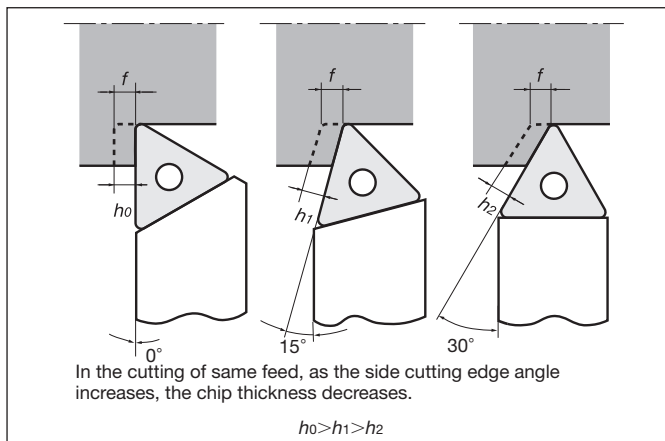

Honing

TAC indexable inserts of steel cutting grades are honed. Honing specifications are shown in the following table.

Edge condition	Shape
Sharp edge	
Round honing	
Chamfered honing	

Effects of tool geometry on cutting phenomena

Increasing	Phenomena	Flank wear	Crater wear	Edge strength	Cutting force	Surface finish	Chattering	Cutting edge temperature	Chip shape and flow
Cutting edge inclination	-	Decrease	Lower	Radial force decrease	-	Less tendency	Lower	Effect on flow direction	
Side rake angle	-	Decrease	Lower	Decrease	-	-	Lower	Effect on shape	
Relief angle	Decrease	-	Lower	Decrease	-	Likely to occur	Lower	-	
End cutting edge angle	Decrease	-	Lower	Radial force decrease	Roughen	Less tendency	Lower	-	
Side cutting edge angle	Decrease	Decrease	Increase	Radial force decrease	-	Likely to occur	Increase	Decrease thickness	
Nose radius	Decrease to some level	Increase	Increase	Improve	Likely to occur	Increase	Effect on flow direction	-	
Honing width	Increase	-	Increase	Increase	-	Likely to occur	Increase	-	

User's Guide - Technical Reference

Turning Tools

Relations between cutting force and cutting conditions or cutting phenomena

Condition	Grey cast iron (HB130)	Stainless steel (HB145)	Carbon steel (HB230)
Cutting speed and cutting force $f = 0.008$ ipr $a_p = 0.079$ " Side cutting edge angle 0° Corner radius $RE = 0.016$ "			
Depth of cut and cutting force $V_c = 330$ SFM $f = 0.008$ ipr Side cutting edge angle 0° Corner radius $RE = 0.016$ "			
Feed and cutting force $V_c = 330$ SFM $a_p = 0.079$ " Side cutting edge angle 0° Corner radius $RE = 0.016$ "			
Corner radius and cutting force $V_c = 330$ SFM $f = 0.008$ ipr $a_p = 0.047$ " Side cutting edge angle 0°			
Side cutting edge angle and cutting force $V_c = 330$ SFM $f = 0.008$ ipr $a_p = 0.079$ " Corner radius $RE = 0.016$ "			
Side rake angle and cutting force $V_c = 330$ SFM $f = 0.008$ ipr $a_p = 0.079$ " Side cutting edge angle 0° Corner radius $RE = 0.008$ "			

Grade
 Insert
 Toolholder
 Ext. Toolholder
 Int. Toolholder
 Threading
 Grooving
 Miniature Tool
 Milling Cutter
 Endmill
 Drilling Tool
 Tooling System
 Index



User's Guide - Technical Reference

Turning Tools

Calculation formulas for turning

●Cutting speed

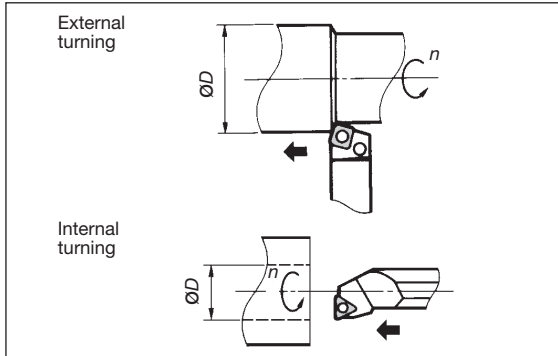

When calculating cutting speed from number of revolutions:

$$V_c = \frac{\phi D \times n}{3.82}$$

V_c : Cutting speed (sfm)
 n : Number of revolution (rpm)
 ϕD : Diameter of workpiece (in)
 π : 3.14

When calculating required number of revolutions from cutting speed:

$$n = \frac{V_c \times 3.82}{\phi D}$$

Example : Calculating the cutting speed when turning a $\phi 6''$ - diameter workpiece at 250 rpm

$$V_c = \frac{6 \times 250}{3.82} = 392 \text{ sfm}$$

●Cutting time on external and internal turning

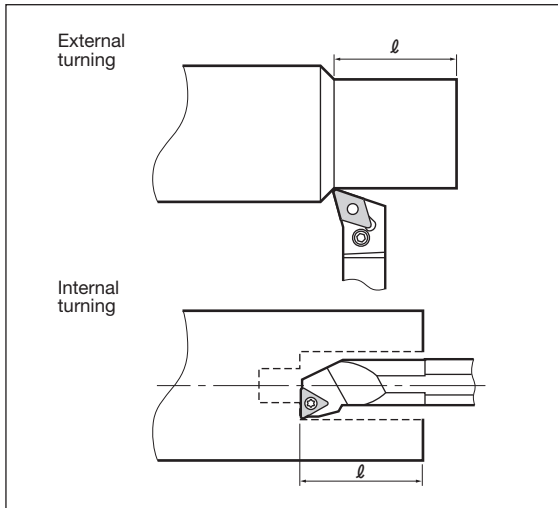

$$T = \frac{l}{f \times n}$$

(min)

T : Cutting time (min)
 l : Cutting length (in)
 f : Feed (ipr)
 n : RPM

●Cutting time on face turning

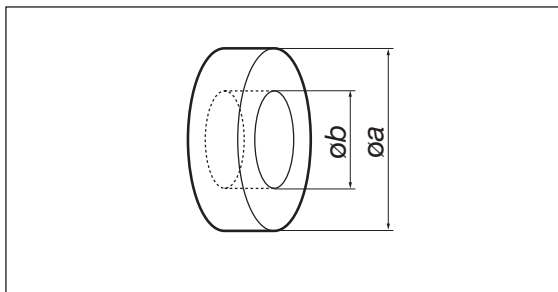

$$T = \frac{\pi \times (a^2 - b^2)}{48 \times V_c \times f}$$

(min)

V_c : Cutting speed (sfm)
 f : Feed (ipr)
 T : Cutting Time (min)

●Theoretical surface roughness

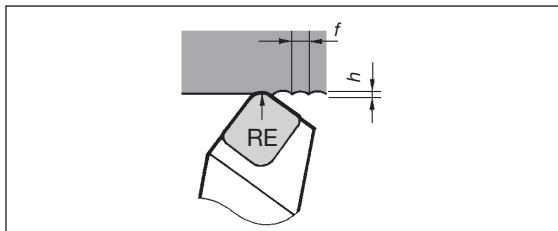

$$h = \frac{f^2}{8 \times r} \times 1000$$

(μm)

h : Surface roughness (μm)
 f : Feed (ipr)
 r : Nose radius (in) (RE)

() The notation in the brackets is the one used in the catalog (ISO compliant)

●Calculation of power consumption (kW)

$$P_c = \frac{F \times V_c}{33000}$$

(HP)

P_c : Power requirement (kW)
 F : Cutting force (N)
 V_c : Cutting speed (sfm)

User's Guide - Technical Reference

Turning Tools

Cutting forces

- (1) Finding from the diagram based on experimental data.
- (2) In case determining by simplified equation:

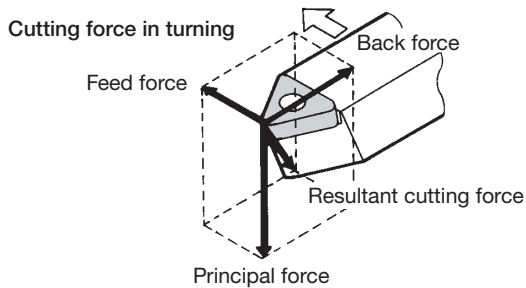

$$F = k_c \times a_p \times f \times 1000 \text{ (lb-force)}$$

F : Cutting force (lb-force)
 k_c : Specific cutting force (KPI (Kilo pound force))
 a_p : Depth of cut (in)
 f : Feed (ipr)

Example :

Calculating the cutting force when cutting a high carbon steel (1055) at $f = 0.007$ ipr and $a_p = 0.118$ ".
 $F = 499 \times 0.118 \times 0.0078 \times 1000 = 460$ lb-force

Calculating power requirement

$$P_c = \frac{k_c \times a_p \times v_c \times f}{33} \text{ (kW)}$$

P_c : Net power requirement (H)
 k_c : Specific cutting force (KPI)
 [Refer to the Table below]
 v_c : Cutting speed (sfm)
 a_p : Depth of cutting (in)
 f : Feed (ipr)

Value of specific cutting force (k_c)

Workpiece material (JIS)	Tensile strength lb/in ² (PSI)	Hardness (HB)	Value of specific cutting force on feed k_c (KPI)				
			0.0016 (ipr)	0.004 (ipr)	0.008 (ipr)	0.016 (ipr)	0.039 (ipr)
SS400, S15C	56,565	100	497	412	355	302	247
S35C, S40C	85,572	170	612	506	426	363	302
S50C, SCr430	113,855	230	711	583	497	426	348
SCM440, SNCM439	142,137	300	782	640	548	470	384
SDK	225,992 (56HRC)	56HRC	1,217	996	853	725	598
FC200	(160HB)	160	370	284	236	194	149
FCD600	(200HB)	200	483	370	306	254	194
Aluminum alloy	(89HB)	89	196	164	138	117	97
Aluminum			152	126	107	93	75
Magnesium alloy			57	57	57	57	57
Brass			157	157	157	157	157

Bending stress and tool deflection

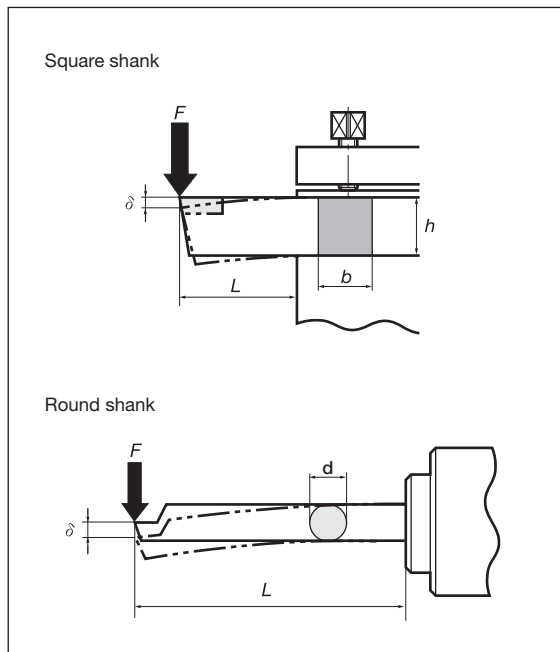

Bending stress

(1) Square shank

$$S = \frac{6 \times F \times L \times 145}{b \times h^2} \text{ (PSI)}$$

(2) Round shank

$$S = \frac{32 \times F \times L \times 145}{\pi \times d^3} \text{ (PSI)}$$

S : Bending stress in shank (PSI)
 F : Cutting force (lb)
 L : Overhang length of tool (in)
 b : Shank width (in) : (B)
 h : Shank height (in) : (H)
 d : Shank diameter (in) : (D)CONMS)
 E : Modulus of elasticity of shank material (lb/in²)

Tool deflection (in)

(1) Square shank

$$\delta = \frac{4 \times F \times L^3}{E \times b \times h^3} \text{ (in)}$$

(2) Round shank

$$\delta = \frac{64 \times F \times L^3}{3 \times \pi \times E \times d^4} \text{ (in)}$$

() The notation in the brackets is the one used in the catalog (ISO compliant)

(Ref.) Values of E

Material	MPa (SPI)	{kgf/mm ² }
Steel	30,457,980	30,457,980
Cemented Carbide	81,221,280 ~ 89,923,560	81,221,280 ~ 89,923,560

User's Guide - Technical Reference

Turning Tools

Machining program compensation for wiper -SW / -FW insert

The nose radius on a wiper insert has a different configuration from that on standard ISO insert's. Machining program adjustments are, therefore, required to generate a correct offset for the wiper insert to machine the correct workpiece dimension. No compensation is needed, however, for the positive, CCMT-SW wiper insert.

Wiper effectiveness (surface finish quality improvement) by applications

CNMG or WNMG insert

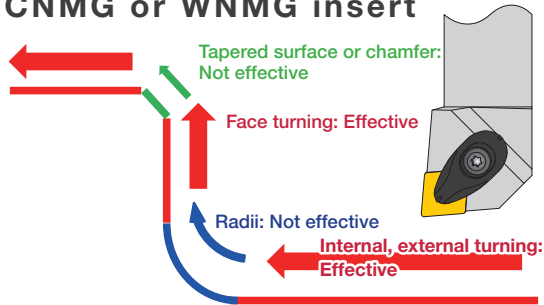

DNMG or TNMG insert

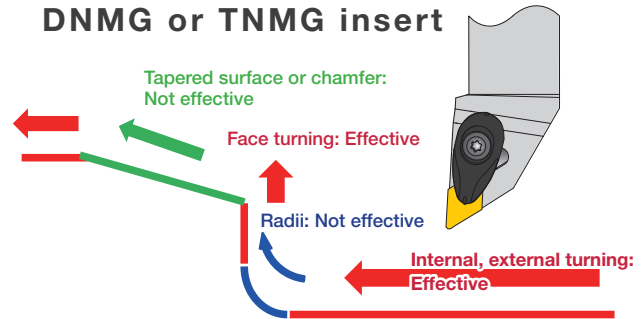

Program compensations by insert shapes and applications

Match your insert shape and application to find the proper compensation method.

Application	Insert shape	CNMG/WNMG -SW/FW	DNMG/TNMG -SW/FW	CCMT-SW
		Type L	Type J, G, F	Type L
Internal, External and Face turning 		Proceed to Compensation ① (See Page L035)	Proceed to Compensation ④ (See Page L036)	No compensation needed
Including tapered surface 		Proceed to Compensation ①, ② (See Page L035)	Proceed to Compensation ④, ⑤ (See Page L036 - L037)	↑
Including corner radius 		Proceed to Compensation ①, ③ (See Page L035)	Proceed to Compensation ④ (See Page L036) Proceed to Compensation ⑥ (See Page L037)	↑
Including tapered surface and corner radius 		Proceed to Compensation ①, ②, ③ (See Page L035)	Proceed to Compensation ④, ⑤, ⑥ (See Page L036 - L037)	↑

Turning Tools

Compensations for CNMG/WNMG -SW / -FW

Compensations ① Tool offsets (Compensations for X- and Z-axis)

Match the insert approach angle and the insert style to find the value and compensate the machining program for the insert radius.
*This compensation procedure will not be necessary if the insert is compensated with the built-in tool presetter after insert replacement.

CNMG/WNMG-SW/-FW (Type L)

Nose Radius	X-axis direction	Z-axis direction
R0.016	0.001	0.001
R0.031	0.002	0.002
R0.047	0.002	0.002

(Unit: in)

Compensations ② Program compensations for tapered surface (proceed after ①)

To machine tapered surfaces, compensate the nose radius position in the x-axis position to obtain the correct workpiece dimension.

Compensations for x-axis when using CNMG or WNMG-SW/-FW (Tool approach angle: L) insert

Match the insert nose radius and the angle of the surface taper to find the value in Table 1 below to compensate the x-axis position.

For CNMG/WNMG-SW/-FW (Type L)

Compensation values for x-axis (in)

Nose radius (in)	Taper angle α (θ)																		
	0	0.197	0.394	0.591	0.787	0.984	1.181	1.378	1.575	1.772	1.969	2.165	2.362	2.559	2.756	2.953	3.150	3.346	3.543
R0.016	0	0.001	0.001	0.002	0.002	0.002	0.002	0.002	0.003	0.003	0.003	0.004	0.004	0.004	0.004	0.004	0.004	0.004	0
R0.031	0	0.001	0.002	0.002	0.003	0.003	0.004	0.004	0.004	0.005	0.006	0.006	0.007	0.007	0.007	0.007	0.005	0.005	0
R0.047	0	0.001	0.002	0.002	0.003	0.003	0.004	0.004	0.004	0.005	0.006	0.006	0.007	0.007	0.007	0.007	0.006	0.006	0

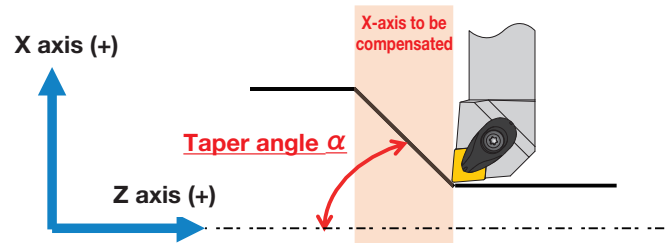

Compensations ③ Program compensation for corner radii (proceed after ①)

To achieve the correct corner radius dimension on the workpiece, compensate the tool position, using the values listed below for respective insert styles.

CNMG/WNMG-SW/-FW (Type L)

Nose Radius	Deviation on the corner radius	Compensate radius by
R0.016	0.002	+0.005
R0.031	0.003	+0.007
R0.047	0.003	+0.007

(Unit: in)

User's Guide - Technical Reference

Turning Tools

Compensations for CNMG/WNMG -SW / -FW

Compensations ④ Tool offsets (Compensations for X- and Z-axis)

Match the insert approach angle and the insert style to find the value and compensate the machining program for the insert radius.
*This compensation procedure will not be necessary if the insert is compensated with the built-in tool presetter after insert replacement.

DNMG-SW/-FW (Type J)

Nose Radius	X-axis direction	Z-axis direction
R0.016	0.009	0.001
R0.031	0.009	0.002
R0.047	0.005	0.001

(Unit: in)

TNMG-SW/-FW (Type J)

Nose Radius	X-axis direction	Z-axis direction
R0.016	0.009	0.002
R0.031	0.008	0.002
R0.047	0.006	0.002

(Unit: in)

TNMG-SW/-FW (Type G)

Nose Radius	X-axis direction	Z-axis direction
R0.016	0.009	0.001
R0.031	0.008	0.001
R0.047	0.006	0.001

(Unit: in)

TNMG-SW/-FW (Type F)

Nose Radius	X-axis direction	Z-axis direction
R0.016	0.001	0.009
R0.031	0.001	0.008
R0.047	0.001	0.006

(Unit: in)

Compensations ⑤ Program compensations for tapered surface (proceed after ④)

To machine tapered surfaces with DNMG or TNMG-SW/-FW insert, compensate both the x-axis and z-axis positions. Since these inserts are commonly used for profiling, to machine a tapered surface with a gradual reduction in diameter, the z-axis position has to be compensated in the negative direction.

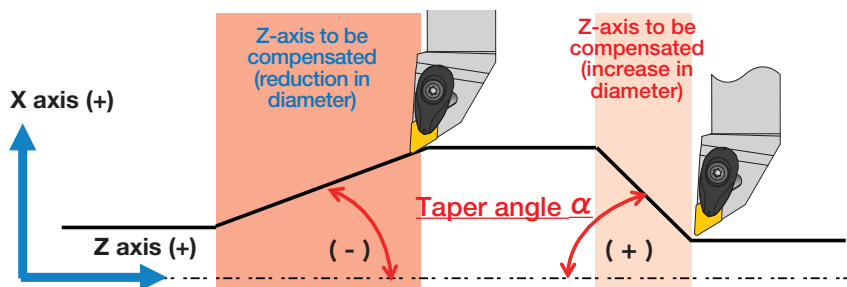

Compensations for x- and z-axis when using DNMG or TNMG-SW/-FW

Match the insert nose radius and the angle of the surface taper to find the value in below to compensate the x-axis and/or z-axis positions.

For DNMG-SW/-FW (Type J)

X-axis compensation values for plus-tapered surface (increase in diameter)

(Unit: in)

Nose radius (in)	Taper angle α (θ)																			
	0	0.197	0.394	0.591	0.787	0.984	1.181	1.378	1.575	1.772	1.969	2.165	2.362	2.559	2.756	2.953	3.150	3.346	3.543	
R0.016	0	-0.0004	-0.0004	-0.0004	-0.0004	-0.0008	-0.0012	-0.0016	-0.0024	-0.0031	-0.0039	-0.0055	-0.0075	-0.0079	-0.0079	-0.0075	-0.0075	-0.0075	-0.0075	0
R0.031	0	0.0004	0.0008	0.0008	0.0012	0.0012	0.0008	0.0004	0.0000	-0.0008	-0.0020	-0.0035	-0.0059	-0.0067	-0.0059	-0.0051	-0.0047	-0.0043	-0.0043	0
R0.047	0	0.0008	0.0016	0.0020	0.0024	0.0028	0.0028	0.0024	0.0016	0.0008	-0.0008	-0.0035	-0.0067	-0.0075	-0.0063	-0.0055	-0.0051	-0.0059	-0.0059	0

Z-axis compensation values for minus-tapered surface (reduction in diameter)

Nose radius (in)	Taper angle α (θ)				
	-0.984	-0.787	-0.591	-0.394	-0.197
R0.016	0.013	0.013	0.013	0.013	0.013
R0.031	0.012	0.013	0.013	0.013	0.013
R0.047	0.013	0.014	0.015	0.016	0.016

(Unit: in)

* Match the taper angle and insert nose radius to find the value in Table 2 and compensate the NC program by either adding or deducting the value.

Example:

Tapering a surface of +45° (increase in diameter) with a R0.031" insert.

Current NC program: X3.937"

Compensation value: -0.001"

Parameter after compensation: X3.936"

User's Guide - Technical Reference

Turning Tools

Compensations for DNMG / TNMG -SW / -FW

Compensations ⑤ Program compensations for tapered surface (proceed after ④)

For TNMG-SW/-FW (Type J)



X-axis compensation values for plus-tapered surface (increase in diameter)

Nose radius (mm)	Taper angle α (θ)																		
	0	0.197	0.394	0.591	0.787	0.984	1.181	1.378	1.575	1.772	1.969	2.165	2.362	2.559	2.756	2.953	3.150	3.346	3.543
R0.016	0	0	0	-0.0004	-0.0004	-0.0008	-0.0012	-0.0016	-0.0020	-0.0028	-0.0039	-0.0055	-0.0071	-0.0098	-0.0110	-0.0110	-0.0106	-0.0106	0
R0.031	0	0.0004	0.0008	0.0012	0.0016	0.0016	0.0016	0.0012	0.0008	0	-0.0008	-0.0024	-0.0043	-0.0075	-0.0087	-0.0079	-0.0075	-0.0083	0
R0.047	0	0.0008	0.0020	0.0028	0.0031	0.0035	0.0039	0.0035	0.0031	0.0024	0.0012	-0.0008	-0.0039	-0.0087	-0.0102	-0.0098	-0.0098	-0.0122	0

(Unit: in)

Z-axis compensation value for minus-tapered surface (reduction in diameter)

Nose radius (mm)	Taper angle α (θ)				
	-0.984	-0.787	-0.591	-0.394	-0.197
R0.016	0.0165	0.0165	0.0165	0.0161	0.0157
R0.031	0.0138	0.0126	0.0130	0.0134	0.0130
R0.047	0.0165	0.0142	0.0150	0.0154	0.0146

(Unit: in)

For TNMG-SW/-FW (Type G)



X-axis compensation values for plus-tapered surface (increase in diameter)

Nose radius (mm)	Taper angle α (θ)																		
	0	0.197	0.394	0.591	0.787	0.984	1.181	1.378	1.575	1.772	1.969	2.165	2.362	2.559	2.756	2.953	3.150	3.346	3.543
R0.016	0	0	-0.0004	-0.0004	-0.0008	-0.0012	-0.0016	-0.0020	-0.0028	-0.0035	-0.0047	-0.0063	-0.0087	-0.0110	-0.0114	-0.0114	-0.0114	-0.0126	0
R0.031	0	0.0004	0.0008	0.0008	0.0012	0.0008	0.0008	0.0004	-0.0004	-0.0012	-0.0024	-0.0039	-0.0067	-0.0098	-0.0098	-0.0098	-0.0110	-0.0157	0
R0.047	0	0.0012	0.0024	0.0031	0.0035	0.0039	0.0043	0.0039	0.0035	0.0028	0.0016	-0.0004	-0.0035	-0.0071	-0.0071	-0.0071	-0.0079	-0.0134	0

(Unit: in)

For TNMG-SW/-FW (Type F)

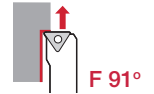

X-axis compensation values for plus-tapered surface (increase in diameter)

Nose radius (mm)	Taper angle α (θ)																		
	0	0.197	0.394	0.591	0.787	0.984	1.181	1.378	1.575	1.772	1.969	2.165	2.362	2.559	2.756	2.953	3.150	3.346	3.543
R0.016	0	-0.0012	-0.0020	-0.0031	-0.0039	-0.0051	-0.0051	-0.0043	-0.0039	-0.0035	-0.0031	-0.0028	-0.0024	-0.0020	-0.0020	-0.0016	-0.0012	-0.0008	0
R0.031	0	-0.0016	-0.0020	-0.0028	-0.0035	-0.0047	-0.0039	-0.0028	-0.0020	-0.0012	-0.0004	0.0004	0.0012	0.0020	0.0028	0.0035	0.0043	0.0051	0
R0.047	0	-0.0012	-0.0016	-0.0020	-0.0028	-0.0035	-0.0020	-0.0004	0.0012	0.0028	0.0043	0.0059	0.0071	0.0087	0.0098	0.0110	0.0126	0.0138	0

Compensations ⑥ Program compensation for corner radii (proceed after ④)

To achieve the correct corner radius dimension on the workpiece, compensate the tool position, using the values listed below for respective insert styles.

DNMG-SW/-FW (Type J)

Nose Radius	Deviation on the corner radius	Compensate radius by
R0.016	0	0
R0.031	0.0008	+0.0079
R0.047	0.0039	+0.0134

(Unit: in)

TNMG-SW/-FW (Type J)

Nose Radius	Deviation on the corner radius	Compensate radius by
R0.016	0	0
R0.031	0.0012	+0.0051
R0.047	0.0043	+0.0142

(Unit: in)

TNMG-SW/-FW (Type G, Type F)

Nose Radius	Deviation on the corner radius	Compensate radius by
R0.016	0	0
R0.031	0.0008	+0.0059
R0.047	0.0035	+0.0150

(Unit: in)

User's Guide - Technical Reference

Turning Tools

Additional information on offsetting -SW / -FW wiper inserts

Compensations ①, ④ Tool offsets (Compensations for X- and Z-axis)

Why need to offset ?

Ex. When using DNMG 433

The wiper insert does not provide the exact corner radius. A deviation from the standard nose radius shape as shown below will always occur when going into a corner. An additional program adjustment is, therefore, required to achieve the correct corner radius or tapered surface dimension on the workpiece.

Before offset

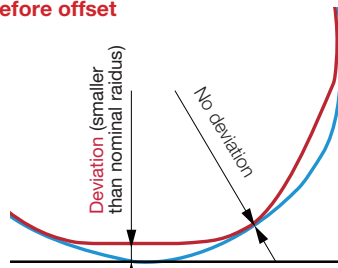

Wiper nose radius' contour is slightly smaller than the nominal radius.
 → The nose radius profile deviates from the required corner radius, thus the actual corner profile will be **incorrect**.

After offset

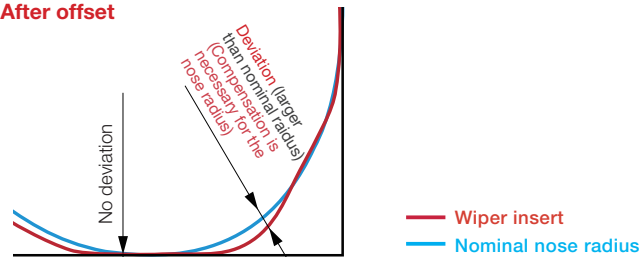

Wiper nose radius' contour is partially larger than the nominal radius.
 → No compensations necessary for ID, OD, or face turning.
 Meanwhile, **due to these deviations, compensations to the NC program are necessary when turning corners and tapered surfaces** for the correct workpiece dimensions.

Compensations ③, ⑥ Program compensation for corner radii (proceed after ①, ④)

Compensation for corner radius

Ex. When using DNMG 433

Example: to machine a corner radius = R0.079", using insert nose radius = R0.047".

For standard ISO insert: DNMG 433 **

Input R0.031" for G2 or G3 (circular interpolation) to compensate the nose radius deviation.

Wiper insert

For wiper insert: DNMG150412-SW/-FW



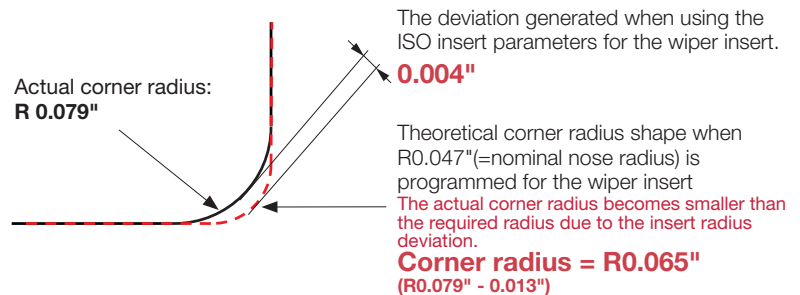



Input **R0.055"**(= R0.031" + 0.013" from the list) for the nose radius, instead of R0.031", to compensate the nose radius deviation.

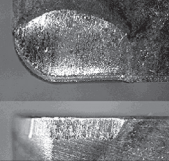

User's Guide - Technical Reference

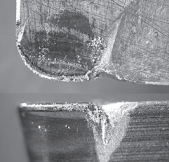
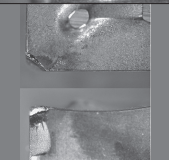
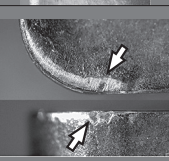
Turning Tools

Troubleshooting in turning

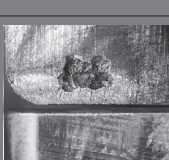
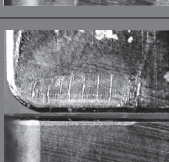
Typical tool failure	Countermeasure		
	Tool grade	Cutting conditions	Tool geometry
Flank wear 	<ul style="list-style-type: none"> Change to more wear resistant grades P, M, K30 → 20 → 10 	<ul style="list-style-type: none"> Reduce cutting speed Change to appropriate feed Change to wet cutting 	<ul style="list-style-type: none"> Decrease honing width Increase relief angle Increase end cutting edge angle Increase corner radius Select free-cutting chipbreaker Increase rake angle
Crater wear 	<ul style="list-style-type: none"> Change to more wear resistant grades P, M, K30 → 20 → 10 	<ul style="list-style-type: none"> Reduce cutting speed Reduce feed Reduce depth of cut Change to wet cutting 	<ul style="list-style-type: none"> Increase rake angle Select an appropriate chipbreaker Increase side cutting edge angle Increase corner radius
Notch wear 	<ul style="list-style-type: none"> Change to more wear resistant grades P, M, K30 → 20 → 10 	<ul style="list-style-type: none"> Reduce cutting speed Reduce feed 	<ul style="list-style-type: none"> Increase rake angle Increase side cutting edge angle
Fracture 	<ul style="list-style-type: none"> Change to tougher grades Change to thermal-shock resistant grades P, M, K10 → 20 → 30 	<ul style="list-style-type: none"> Reduce feed Reduce depth of cut Improve holding rigidity of work and tool Reduce overhang length of toolholder Improve rigidity of machine 	<ul style="list-style-type: none"> Reduce rake angle Select a chipbreaker with high edge strength Increase honing width Increase side cutting edge angle Select larger shank size Increase corner radius
Chipping 	<ul style="list-style-type: none"> Change to tougher grades P, M, K10 → 20 → 30 	<ul style="list-style-type: none"> Reduce cutting speed Reduce feed Reduce depth of cut Improve holding rigidity of work and tool Reduce overhang length of toolholder Improve rigidity of machine 	<ul style="list-style-type: none"> Reduce rake angle Select a chipbreaker with high edge strength Increase honing width Increase side cutting edge angle Select larger shank size
Flaking 	<ul style="list-style-type: none"> Change to tougher grades P, M, K10 → 20 → 30 	<ul style="list-style-type: none"> Reduce cutting speed Reduce feed 	<ul style="list-style-type: none"> Reduce rake angle Increase corner radius Increase honing width
Plastic deformation 	<ul style="list-style-type: none"> Change to more wear resistant grade P, M, K30 → 20 → 10 	<ul style="list-style-type: none"> Reduce cutting speed Change to appropriate feed Reduce depth of cut Supply cutting fluid in adequate volume 	<ul style="list-style-type: none"> Increase relief angle Increase rake angle Reduce corner radius Reduce side cutting edge angle Select a free-cutting chipbreaker
Chip welding 	<ul style="list-style-type: none"> Use a grade which has a low tendency to adhere to workpiece material Cemented carbide → Coated carbide or cermet 	<ul style="list-style-type: none"> Increase cutting speed Increase feed Change to water-insoluble cutting fluid Change to wet cutting 	<ul style="list-style-type: none"> Increase rake angle Select a free-cutting chipbreaker Decrease honing width
Built-up edge 			
Thermal cracking 	<ul style="list-style-type: none"> Change to tougher grades Change to thermal-shock resistant grades P, M, K10 → 20 → 30 	<ul style="list-style-type: none"> Reduce cutting speed Reduce feed Change to dry cutting Supply cutting fluid in adequate volume Reduce depth of cut Change to water-insoluble cutting fluid 	<ul style="list-style-type: none"> Increase rake angle Select a free-cutting chipbreaker Decrease honing width

Grade
 Insert
 Toolholder
 Ext. Toolholder
 Int. Toolholder
 Threading
 Grooving
 Miniature Tool
 Milling Cutter
 Endmill
 Drilling Tool
 Tooling System
 User's Guide
 Index



User's Guide - Technical Reference

Turning Tools

Problem	Cause	Countermeasure	
		Tool	Cutting conditions and others
Deteriorated surface roughness	<ul style="list-style-type: none"> Increased tool wear 	<ul style="list-style-type: none"> Select a more wear resistant grade Use an insert with a larger rake angle Select a freer-cutting chipbreaker type Use an insert with a larger nose radius Use a more lightly honed insert Use an insert of closer tolerance (from M class to G class) 	<ul style="list-style-type: none"> Select a proper feed Decrease the cutting speed Use a cutting fluid
	<ul style="list-style-type: none"> Edge chipping 	<ul style="list-style-type: none"> Use a tougher grade Select a chipbreaker with strong cutting edges Use a largely honed insert Increase the side cutting edge angle Use a larger shank size 	<ul style="list-style-type: none"> Decrease the depth of cut Decrease the feed Use a more rigid machine Improve the holding rigidity of the tool and workpiece Shorten the overhang of the toolholder Improve the machine looseness
	<ul style="list-style-type: none"> Chip welding Built-up-edge 	<ul style="list-style-type: none"> Select a grade with less affinity with the Workpiece material Use an insert with a larger rake angle Select a freer-cutting chipbreaker type Use a more lightly honed insert Use an insert of closer tolerance (from M class to G class) 	<ul style="list-style-type: none"> Increase the cutting speed Increase the feed Use a water-insoluble cutting fluid Use a cutting fluid
	<ul style="list-style-type: none"> Vibration and chatter 	<ul style="list-style-type: none"> Use a tougher grade Use an insert with a larger rake angle Select a freer-cutting chipbreaker type Use an insert with a smaller nose radius Decrease the side cutting edge angle Use a more lightly honed insert Use a larger shank size 	<ul style="list-style-type: none"> Use a proper cutting speed Decrease the feed Decrease the depth of cut Improve the holding rigidity of the tool and workpiece Shorten the overhang of the toolholder Improve the machine looseness
Deteriorated dimensional accuracy	<ul style="list-style-type: none"> Improper insert accuracy 	<ul style="list-style-type: none"> Use an insert of closer tolerance (from M class to G class) 	
	<ul style="list-style-type: none"> Incomplete engagement of tool and workpiece 	<ul style="list-style-type: none"> Use an insert with a larger rake angle Select a freer-cutting chipbreaker type Use an insert with a smaller nose radius Use a more lightly honed insert 	<ul style="list-style-type: none"> Improve the holding rigidity of the tool and workpiece Shorten the overhang of the toolholder Improve the machine looseness
Burr occurrence	<ul style="list-style-type: none"> Unsuitable cutting speed 		<ul style="list-style-type: none"> Decrease the cutting speed Increase the feed Use a cutting fluid
	<ul style="list-style-type: none"> Worn tool or improper cutting edge geometry 	<ul style="list-style-type: none"> Use a harder grade Use an insert with a larger rake angle Select a freer-cutting chipbreaker type Increase the relief angle Use an insert with a smaller nose radius Decrease the side cutting edge angle Use a more lightly honed insert 	
Edge breakout	<ul style="list-style-type: none"> Improper cutting speed 		<ul style="list-style-type: none"> Decrease the feed Decrease the depth of cut
	<ul style="list-style-type: none"> Worn tool or improper cutting edge geometry 	<ul style="list-style-type: none"> Use a harder grade Use an insert with a larger rake angle Select a freer-cutting chipbreaker type Increase the side cutting edge angle Use an insert with a larger nose radius Use a more lightly honed insert Use a larger shank size 	<ul style="list-style-type: none"> Improve the holding rigidity of the tool and workpiece Shorten the overhang of the toolholder Improve the machine looseness
Fuzzy surface finish	<ul style="list-style-type: none"> Improper cutting conditions 		<ul style="list-style-type: none"> Increase the cutting speed Select a proper feed Use a water-insoluble cutting fluid Use a cutting fluid
	<ul style="list-style-type: none"> Worn tool or improper cutting edge geometry 	<ul style="list-style-type: none"> Use a harder grade. Select a grade with less affinity with the Workpiece material Use an insert with a larger rake angle Select a freer-cutting chipbreaker type Use a more lightly honed insert 	

User's Guide - Technical Reference

Chipbreakers

Chip controllability

Necessity of chip control



- ① Why is chip control needed?
- ② Effect of improper chip control

① Why is chip control needed?

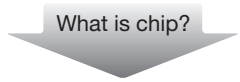

For making a product from a workpiece, removed objects produced by a tool which is set to cut to a specified depth with the relative motion of the tool and the workpiece.

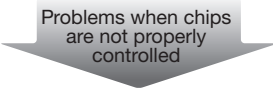

Necessity of chip control (Problems and effects)

Problems	Effects
1. Scattering of chips and coolant. 2. Wrapping around the workpiece and the tool. 3. Accumulation on the tool, jig, and machining facilities.	1. Disturbs unmanned and automated machining. 2. Disturbs high-speed and high-efficiency machining. 3. Degrades finished surface. 4. Threatens operator's safety. 5. Reduced operation rate.

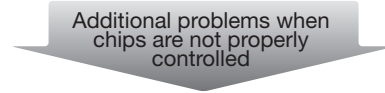

② Effect of improper chip control

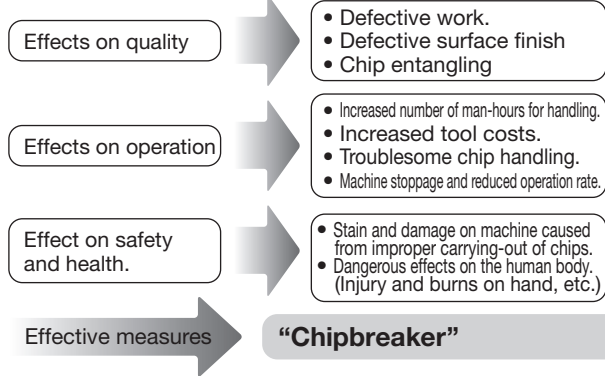

Classification	Chip shape		Description of chip shape	Acceptability	Effect	
	Depth of cut: small	Depth of cut: large				
Shape A			Chips irregularly entangled	Not acceptable	<ul style="list-style-type: none"> • Wrapping around the tool or workpiece or accumulation around the cutting point, hindering cutting • Possible damage to the machined surface 	
Shape B			Long continuous spiral chips $l > 2"$		<ul style="list-style-type: none"> • Bulky during transport in the automatic line • May be preferred when one operator handles one machine 	
Shape C			Short spiral chips $l < 2"$		<ul style="list-style-type: none"> • Smooth chip flow • Difficult to scatter • Favorable shape 	
Shape D			"C" or "9" shaped chips (Around one coiling)		<ul style="list-style-type: none"> • Favorable shape if not scattering • Not bulky and easy to transport 	
Shape E			Excessively broken chips. Thin pieces or connected in a form of wave as shown in the figure left		Not acceptable	<ul style="list-style-type: none"> • Readily scattering. If scattering is the only trouble, it may be acceptable because the chip cover, etc. may be used. • Tend to cause chatter, causing harm on the finished surface roughness or tool life.

Grade
Insert
Toolholder
Ext. Toolholder
Int. Toolholder
Threading
Grooving
Miniature Tool
Endmill
Drilling Tool
Tooling System
User's Guide
Index



User's Guide - Technical Reference

Chipbreakers

Factors affecting chip control

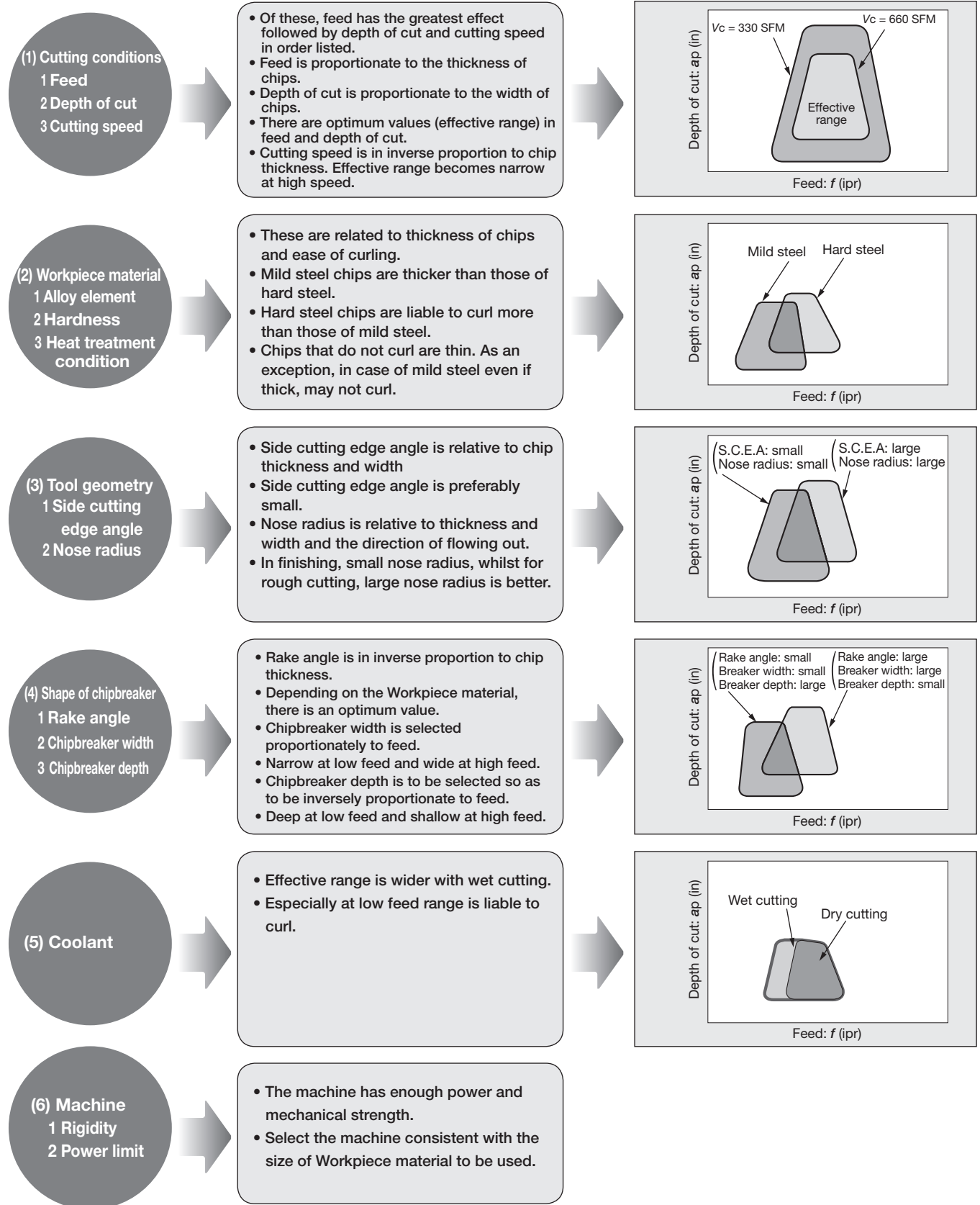

User's Guide - Technical Reference

Grooving and Parting Tools

How to install and remove the blade and insert **TUNGALLOY SYSTEM**

● Assembly

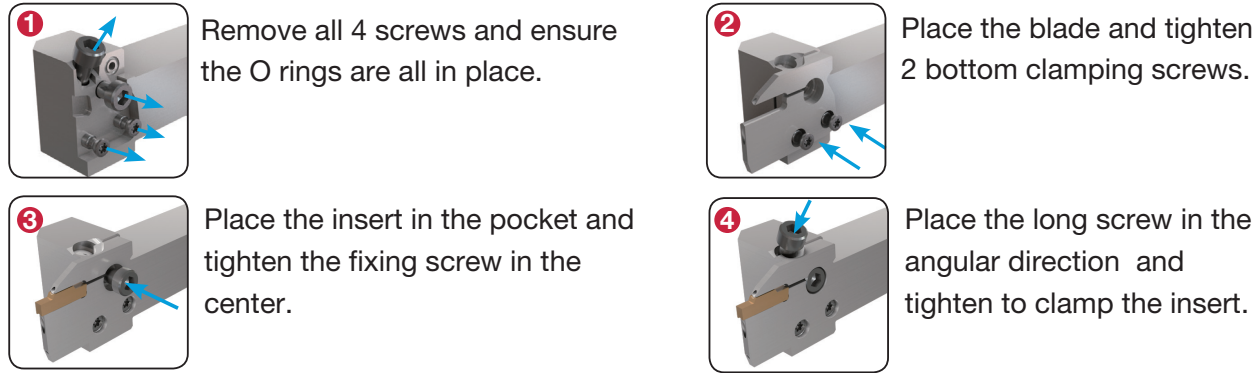

Please follow the installation order as shown above. When the screws are tightened in the 4 → 3 order, the insert clamping may be insufficient and unstable.

● Disassembly



Loosing the long screw alone may not release the insert.

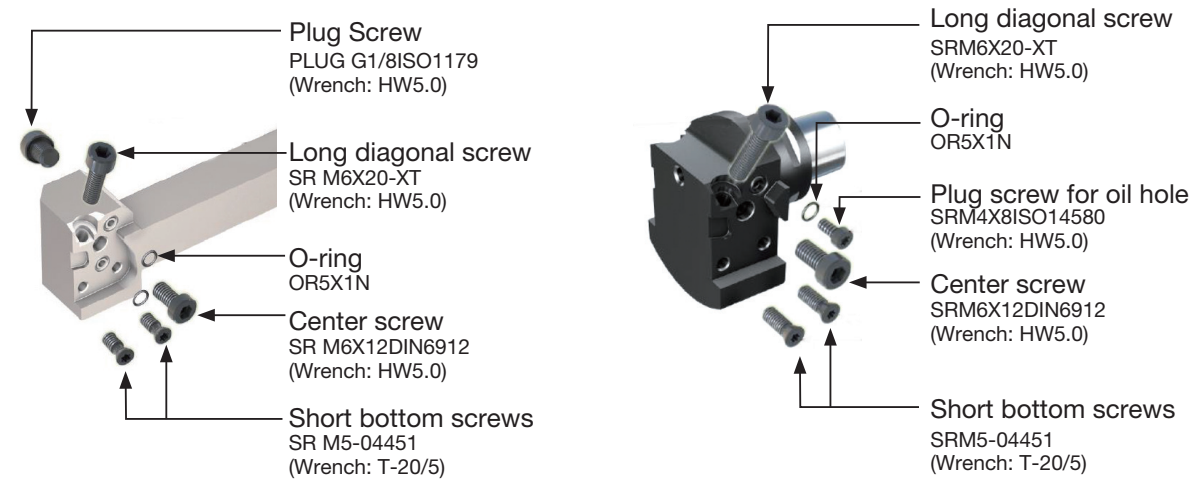

※ All parts listed here are included in the tool holder.

PROCEDURE TO CLAMP AND UNCLAMP INSERT **EASYMCUT^{ULTI}**

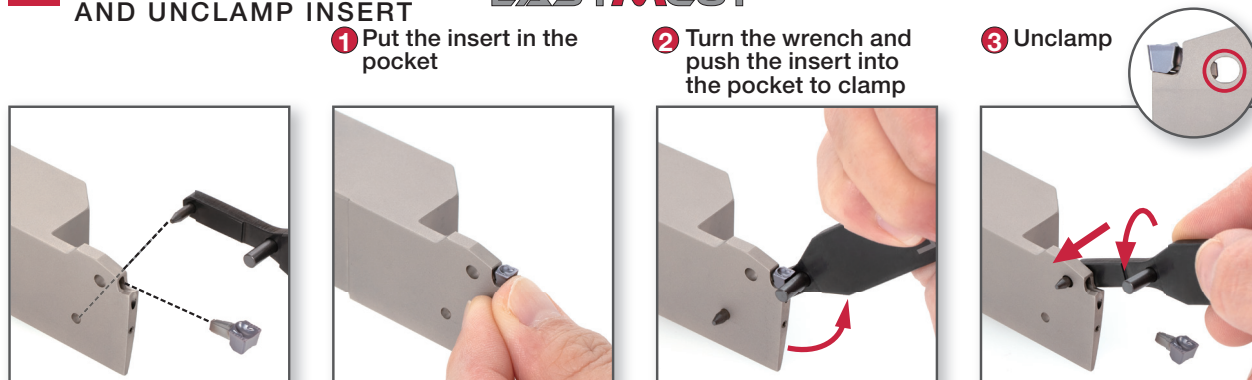

User's Guide - Technical Reference

Fundamentals of screw threads

● Relationship between lead, lead angle and pitch

1. Lead is the axial distance a screw advances in one rotation. In single start screw, the lead is equal to the pitch.
2. The inclination angle of a threaded groove is called lead angle. In screws of the same diameter, the lead angle increases as the pitch increases.
3. The side face of a completed thread groove is called flank. The distance between the crest and the root is called thread height.

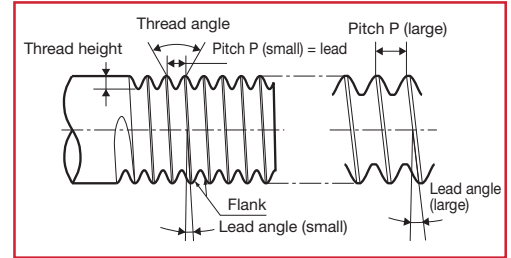

● Single and multi start thread

1. The single start thread has a single groove. Two start thread or three start thread has two grooves or three grooves respectively.
2. The pitch of multi start thread is the distance of adjoining groove.
3. When viewing the section of the multi start thread, the pitch is same as that of the single start thread. The lead of the two or three start thread is twice or three times the pitch. The multi start thread is mainly used for trapezoidal threads.

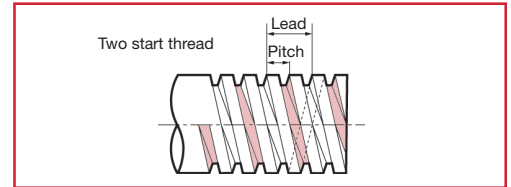

● Tolerance class of threads

Tolerance classes of screw threads are expressed as follows:

Metric coarse external thread: 6h, 6g Metric coarse internal thread: 5H, 6H

These classes are ranked with tolerances of thread diameter, pitch, thread angle, etc. For fastening applications, 6H- and 6g-class (former JIS second class) threads, manufactured by cutting or rolling,

are generally used. 5H- and 4h-class threads (former JIS first class) are generally finished by grinding.

For example, M8-6g means metric coarse external thread of 6g tolerance class.

TAC threading insert

● Difference between full-profile and partial-profile insert

● Full-profile insert

In the full-profile insert, the major diameter of the thread is finished by the profiled finishing edge as shown in Figure below. Therefore, about 0.1 mm of finishing stock must be left on the outer surface of the workpiece before threading. In trapezoidal threads, since slants of 15°

to 30° are left on the crest of the thread as shown in Figure below, these portions must be finished by another tool later.

Full-profile insert could produce no burr and good thread by the profiled finishing edge.

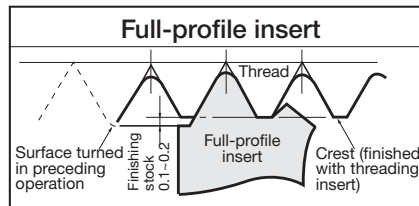
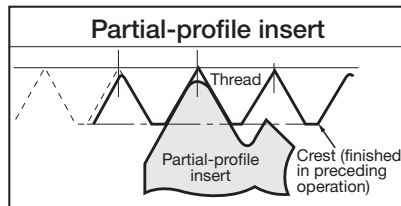

● When machining trapezoidal threads:

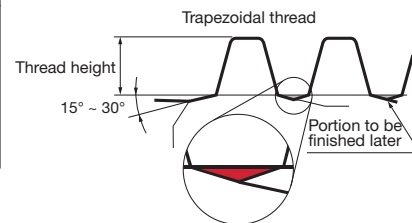

● Partial-profile insert

Partial-profile inserts can not be used for finishing of the crest, but can be applied to a wide range of pitches.

For example

Designation	Pitch (mm)	TPI	Insert radius RE (mm)
16ERA60	0.5 ~ 1.5	48 ~ 16	0.06
16ERG60	1.75 ~ 3	14 ~ 8	0.22

Corner radii of inserts are fitted to the thread of the smallest pitch.

● Difference between external and internal use inserts

In full-profile inserts for metric and unified threads, the corner radius and thread height differ from those for the external and internal use insert respectively. Therefore, the right hand insert for external use and the left hand insert for internal use are not the same tool.

Since the rake angles of toolholders are -10° for external toolholders and -15° for internal toolholders, the external / internal toolholders can not be used for machining internal / external thread.

In Whitworth thread, though the external thread and internal thread have the same thread form, the external and internal toolholders are incompatible because of the different rake angle.

For example

Designation	Applicable inserts	Insert radius R RE (mm)	Thread height (mm)	Rake angle of holders
16ER20ISO	External	0.25	1.52	-10°
16IL20ISO	Internal	0.14	1.3	-15°

Shim replacement method of ST-type tools

Compensation for the lead angle and tool relief angle

When the pitch is large or the screw diameter is small, the lead angle becomes large and the effective relief angle on the advance flank side β_2 becomes small. In particular, this will cause shorter life of the insert in the case of trapezoidal screw with small flank angle. It is ideal without any interference for the thread cutting insert to have an equal relief angle on both right and left. Replace the shim so that the rake face of insert faces the thread groove direction (that is, $\beta = \beta_3$).

Calculating the lead angle

The lead angle is calculated as follows:

$$\beta = \tan^{-1}(\ell / \pi d) = \tan^{-1}(nP / \pi d)$$

β : Lead angle
 ℓ : Lead
 n : No. of threads
 P : Pitch
 d : Pitch diameter

Calculating the relief angle

The relief angle β_1 is calculated as follows:

$$\beta_1 = \tan^{-1}(\tan\theta \cdot \tan\alpha)$$

The α of a standard toolholder is 10° for external threading and 15° for internal threading.

Included angle 2θ	θ	β_1	
		External threading tool	Internal threading tool
60°	30°	5.8°	8.8°
55°	27.5°	5.2°	7.9°
30°	15°	2.7°	4.1°
29°	14.5°	2.6°	4°

Accordingly, the effective relief angle is calculated as follows:

$$\beta_2 = \beta_1 + \beta_3 - \beta$$

β : Lead angle
 β_2 : Effective relief angle
 β_3 : Lead angle compensation value

In other words, $\beta_1 = \beta_2$ when the thread lead angle is equal to the compensation value. Namely, the relief angle of the tool itself is equal to the effective relief angle. If the wrong compensation value is used, $\beta_1 > \beta_2$. The effective relief angle becomes smaller and cause the interference between the flank side of insert and the thread groove. Therefore, carry out compensation of the lead angle so that the following range is obtained:

- $\pm 1^\circ$ when the thread angle is 60° and 55°
- $\pm 3^\circ$ when the thread angle is 30° and 29°

Compensation of lead angle for shim less internal toolholders

When using internal threading toolholders without shim, the above-mentioned method can not be applied for lead angle compensation. Therefore, special toolholders for large lead angles are available as

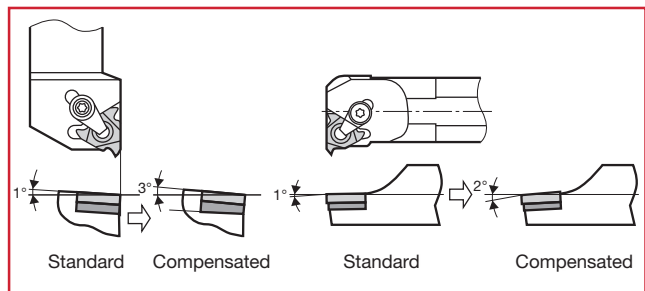
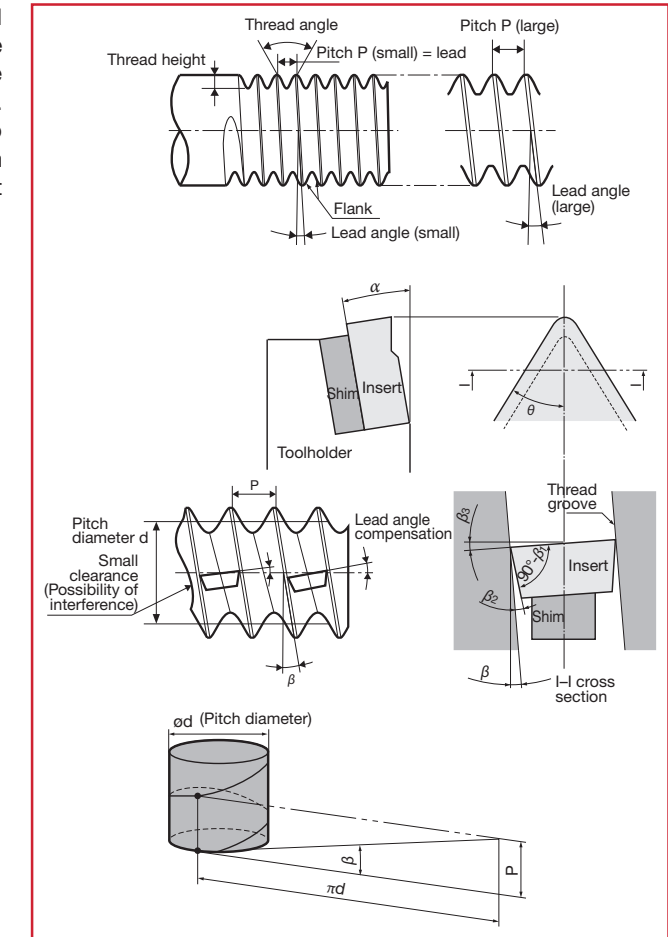

shown below. The final figure of the designation (-2 or -3) indicates 2° or 3° lead angle to be used respectively. The toolholders without these figures are for 1° lead angle.

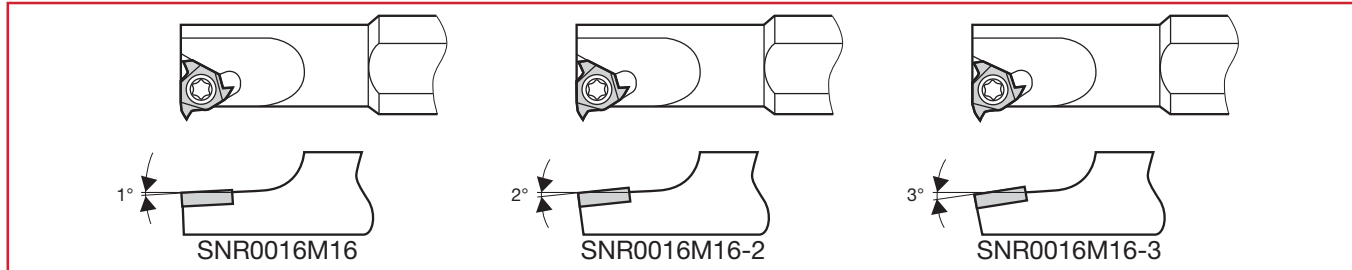

User's Guide - Technical Reference

Shim replacement method of ST-type tools

Type of shim and the compensation value of lead angle

The designation of the shim and compensated lead angles are shown in the table.

Compensated lead angles	-2°	-1°	0°	1°	2°	3°	4°
Shim	□□□-98	□□□-99	□□□-0	□□□-1	□□□-2	□□□-3	□□□-4

Note: The last numeral of the shim designation is the compensated lead angle.

Toolholders and applicable shims

Screw-on / clamp-on dual toolholders

Toolholder designation	Shim	
	R	L
CER/L□□□□□16DT	AE16-□DT	AN16-□DT
CER/L□□□□□22DT	GXE22-□DT	GXN22-□DT
TCNR/L□□□□□16DT	AN16-□DT	AE16-□DT
TCNR/L□□□□□22DT	GXN22-□DT	GXE22-□DT

Note: Standard shim is AE16-1DT or GX22-1DT. Other types are optional.

Clamp-on type toolholders

Toolholder designation	Shim	
	R	L
CER/L□□□□□16-T	AE16-□	AN16-□
CER/L□□□□□22-T	NXE22-□	NXN22-□
CER/L□□□□□27-T	NXE27-□	NXN27-□
CNR/L□□□□□16	AN16-□	AE16-□
CNR/L□□□□□22	NXN22-□	NXE22-□
CNR/L□□□□□27	NXN27-□	NXE27-□
B-CER/L□□□□□16	AE16-□	AN16-□

Note: Standard shim is □□□□□-1. Other types are optional.

Shim selection guide for screw-on / clamp-on dual ST-type tools

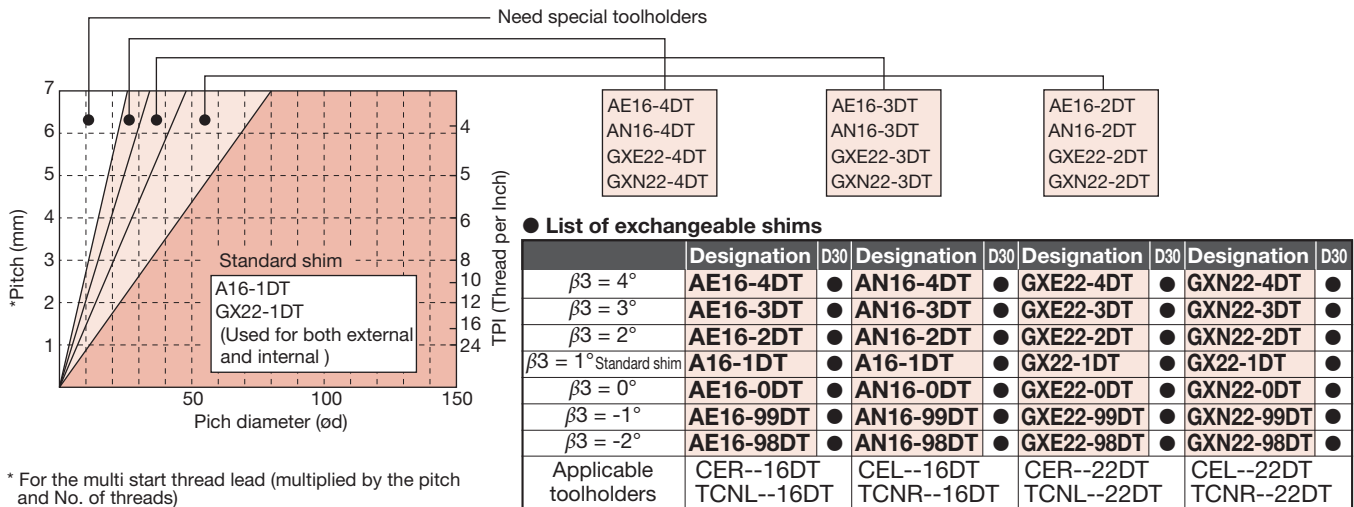

* For the multi start thread lead (multiplied by the pitch and No. of threads)

Shim selection guide for clamp-on type ST-tools

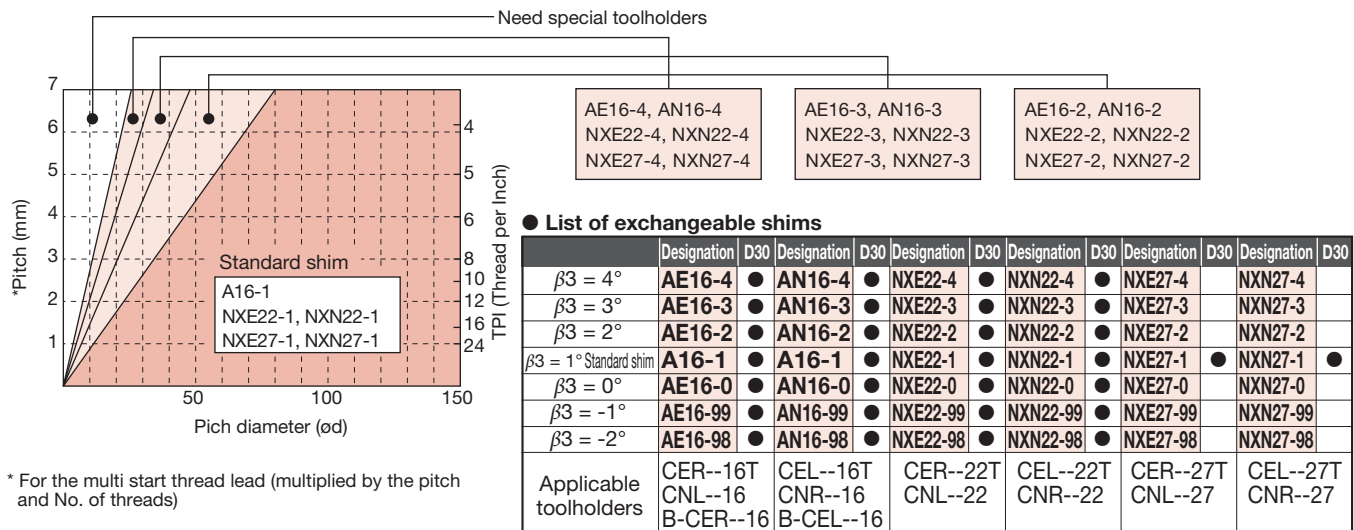

* For the multi start thread lead (multiplied by the pitch and No. of threads)

Threading Methods and Combinations

External threading			
Right hand thread		Left hand thread	
Work rotation	Regular	Work rotation	Reverse
Feed direction	Push	Feed direction	Push
Hand of toolholder	Right	Hand of toolholder	Left
Hand of insert	Right	Hand of insert	Left
Standard shim	①	Standard shim	②
Work rotation	Regular	Work rotation	Reverse
Feed direction	Pull	Feed direction	Pull
Hand of toolholder	Left	Hand of toolholder	Right
Hand of insert	Left	Hand of insert	Right
Standard shim	④	Standard shim	③
Work rotation	Reverse	Work rotation	Regular
Feed direction	Push	Feed direction	Push
Hand of toolholder	Right	Hand of toolholder	Left
Hand of insert	Right	Hand of insert	Left
Standard shim	①	Standard shim	②
Work rotation	Reverse	Work rotation	Regular
Feed direction	Pull	Feed direction	Pull
Hand of toolholder	Left	Hand of toolholder	Right
Hand of insert	Left	Hand of insert	Right
Standard shim	④	Standard shim	③

Internal threading			
Right hand thread		Left hand thread	
Work rotation	Regular	Work rotation	Reverse
Feed direction	Push	Feed direction	Push
Hand of toolholder	Right	Hand of toolholder	Left
Hand of insert	Right	Hand of insert	Left
Standard shim	②	Standard shim	①
Work rotation	Reverse	Work rotation	Regular
Feed direction	Pull	Feed direction	Pull
Hand of toolholder	Left	Hand of toolholder	Right
Hand of insert	Left	Hand of insert	Right
Standard shim	③	Standard shim	④

Standard shim			
No.	New	No.	New
①	A16-1DT	②	A16-1DT
	A16-1		A16-1
	GX22-1DT		GX22-1DT
	NXE22-1		NXN22-1
③	NXE27-1	④	NXN27-1
	AE16-99DT		AN16-99DT
	AE16-99		AN16-99
	GXE22-99DT		GXN22-99DT
	NXE22-99		NXN22-99
	NXE27-99		NXN27-99

User's Guide - Technical Reference

Infeed per Pass and Number of Passes

ISO metric full-profile inserts (for external)

Pitch	0.5	0.75	1	1.25	1.5	1.75	2	2.5	3	3.5	4	4.5	5	5.5	6	
Height of thread	0.32	0.47	0.63	0.79	0.95	1.11	1.27	1.58	1.9	2.21	2.53	2.85	3.16	3.48	3.8	
Total depth of cut	0.42	0.57	0.73	0.89	1.05	1.21	1.37	1.68	2	2.31	2.63	2.95	3.26	3.58	3.9	
Number of passes	1	0.15	0.18	0.25	0.25	0.3	0.3	0.3	0.3	0.35	0.35	0.4	0.4	0.45	0.5	0.5
	2	0.12	0.12	0.2	0.2	0.25	0.25	0.25	0.3	0.3	0.35	0.35	0.35	0.35	0.4	
	3	0.1	0.12	0.13	0.15	0.2	0.2	0.2	0.25	0.25	0.3	0.3	0.3	0.3	0.3	0.3
	4	0.05	0.1	0.1	0.14	0.15	0.16	0.2	0.23	0.2	0.25	0.25	0.25	0.25	0.25	0.25
	5		0.05	0.05	0.1	0.1	0.15	0.15	0.2	0.2	0.21	0.2	0.2	0.25	0.23	0.25
	6				0.05	0.05	0.1	0.12	0.15	0.15	0.2	0.2	0.2	0.2	0.2	0.2
	7						0.05	0.1	0.15	0.15	0.15	0.15	0.2	0.2	0.2	0.2
	8							0.05	0.1	0.15	0.15	0.15	0.15	0.18	0.15	0.15
	9								0.05	0.1	0.15	0.15	0.15	0.15	0.15	0.15
	10									0.1	0.1	0.13	0.15	0.15	0.15	0.15
	11									0.05	0.1	0.1	0.15	0.13	0.15	0.15
	12										0.05	0.1	0.1	0.1	0.15	0.15
	13											0.1	0.1	0.1	0.15	0.15
	14											0.05	0.1	0.1	0.1	0.15
	15												0.1	0.1	0.1	0.1
	16												0.05	0.1	0.1	0.1
	17													0.1	0.1	0.1
	18													0.05	0.1	0.1
	19														0.1	0.1
	20														0.05	0.1
	21															0.1
	22															0.05
	23															
	24															

(Unit: mm)

ISO metric full-profile inserts (for internal)

Pitch	0.5	0.75	1	1.25	1.5	1.75	2	2.5	3	3.5	4	4.5	5	5.5	6		
Height of thread	0.29	0.43	0.58	0.72	0.87	1.01	1.16	1.45	1.74	2.03	2.32	2.61	2.9	3.19	3.48		
Total depth of cut	0.39	0.53	0.68	0.82	0.97	1.11	1.26	1.55	1.84	2.13	2.42	2.71	3	3.29	3.58		
Number of passes	1	0.08	0.1	0.14	0.15	0.2	0.2	0.2	0.25	0.25	0.3	0.3	0.35	0.35	0.4	0.4	
	2	0.07	0.09	0.13	0.13	0.16	0.18	0.18	0.22	0.22	0.25	0.25	0.25	0.25	0.25	0.25	
	3	0.07	0.08	0.11	0.12	0.14	0.16	0.17	0.2	0.2	0.22	0.22	0.22	0.22	0.22	0.22	
	4	0.06	0.08	0.1	0.11	0.12	0.14	0.16	0.18	0.18	0.2	0.2	0.2	0.2	0.2	0.2	
	5	0.06	0.07	0.08	0.1	0.12	0.12	0.14	0.16	0.16	0.18	0.18	0.18	0.18	0.2	0.2	0.19
	6	0.05	0.06	0.07	0.09	0.1	0.1	0.12	0.15	0.15	0.16	0.18	0.18	0.18	0.18	0.18	
	7		0.05	0.05	0.07	0.08	0.09	0.1	0.1	0.14	0.14	0.16	0.16	0.16	0.16	0.17	
	8				0.05	0.05	0.07	0.08	0.1	0.13	0.13	0.14	0.14	0.14	0.14	0.16	
	9						0.05	0.06	0.08	0.12	0.12	0.14	0.14	0.14	0.14	0.15	
	10							0.05	0.06	0.1	0.11	0.12	0.12	0.13	0.13	0.14	
	11								0.05	0.08	0.1	0.12	0.12	0.13	0.13	0.14	
	12									0.06	0.1	0.1	0.12	0.12	0.13	0.13	
	13									0.05	0.07	0.1	0.11	0.12	0.12	0.13	
	14										0.05	0.09	0.1	0.12	0.12	0.13	
	15											0.07	0.1	0.11	0.12	0.12	
	16											0.05	0.09	0.1	0.12	0.12	
	17												0.08	0.1	0.1	0.12	
	18												0.05	0.1	0.1	0.1	
	19													0.08	0.1	0.1	
	20													0.05	0.1	0.1	
	21														0.08	0.1	
	22														0.05	0.1	
	23															0.08	
	24															0.05	

(Unit: mm)

Unified full-profile inserts

	For external								For internal							
	TPI	24	20	18	16	14	12	8	24	20	18	16	14	12	8	
Height of thread	0.67	0.8	0.89	1.01	1.15	1.34	2.01	0.61	0.74	0.82	0.92	1.05	1.23	1.84		
Total depth of cut	0.77	0.9	0.99	1.11	1.25	1.44	2.11	0.71	0.84	0.92	1.02	1.15	1.33	1.94		
Number of passes	1	0.25	0.25	0.28	0.3	0.3	0.3	0.35	0.2	0.2	0.2	0.2	0.25	0.25	0.3	
	2	0.22	0.2	0.23	0.25	0.25	0.25	0.3	0.16	0.16	0.18	0.18	0.2	0.2	0.25	
	3	0.15	0.16	0.18	0.18	0.23	0.21	0.25	0.12	0.13	0.15	0.16	0.18	0.18	0.22	
	4	0.1	0.14	0.15	0.15	0.18	0.18	0.22	0.1	0.12	0.14	0.14	0.16	0.16	0.2	
	5	0.05	0.1	0.1	0.1	0.14	0.15	0.2	0.08	0.1	0.1	0.11	0.13	0.13	0.18	
	6		0.05	0.05	0.08	0.1	0.12	0.2	0.05	0.08	0.1	0.1	0.1	0.1	0.16	
	7				0.05	0.05	0.1	0.16		0.05	0.05	0.08	0.08	0.1	0.14	
	8						0.08	0.16				0.05	0.05	0.08	0.12	
	9						0.05	0.12						0.08	0.12	
	10								0.1					0.05	0.1	
	11								0.05						0.1	
	12														0.05	
	13															
	14															

(Unit: mm)

Whitworth full-profile inserts

	For external								For internal										
	TPI	20	19	18	16	14	12	11	10	8	20	19	18	16	14	12	11	10	8
Height of thread	0.83	0.88	0.92	1.04	1.19	1.39	1.51	1.66	2.08	0.83	0.88	0.92	1.04	1.19	1.39	1.51	1.66	2.08	
Total depth of cut	0.93	0.98	1.02	1.14	1.29	1.49	1.61	1.76	2.18	0.93	0.98	1.02	1.14	1.29	1.49	1.61	1.76	2.18	
Number of passes	1	0.25	0.28	0.3	0.3	0.3	0.3	0.35	0.35	0.2	0.2	0.22	0.22	0.25	0.25	0.25	0.3	0.35	
	2	0.2	0.22	0.24	0.25	0.25	0.25	0.25	0.3	0.3	0.18	0.18	0.18	0.18	0.21	0.21	0.21	0.25	0.3
	3	0.18	0.18	0.18	0.18	0.23	0.2	0.2	0.23	0.25	0.16	0.16	0.17	0.17	0.2	0.2	0.2	0.22	0.25
	4	0.15	0.15	0.15	0.14	0.2	0.18	0.18	0.2	0.23	0.14	0.16	0.16	0.16	0.18	0.18	0.2	0.22	
	5	0.1	0.1	0.1	0.12	0.16	0.15	0.15	0.15	0.22	0.12	0.13	0.14	0.14	0.16	0.16	0.16	0.16	0.2
	6	0.05	0.05	0.05	0.1	0.1	0.14	0.14	0.14	0.2	0.08	0.1	0.1	0.12	0.14	0.14	0.14	0.14	0.18
	7				0.05	0.05	0.12	0.12	0.12	0.18	0.05	0.05	0.05	0.1	0.1	0.1	0.12	0.12	0.16
	8						0.1	0.12	0.12	0.16				0.05	0.05	0.1	0.1	0.12	0.14
	9						0.05	0.1	0.1	0.14					0.1	0.1	0.1	0.12	
	10							0.05	0.05	0.1					0.05	0.1	0.1	0.11	
	11									0.05							0.05	0.05	0.1
	12																		0.05
	13																		
	14																		
	15																		

(Unit: mm)

User's Guide - Technical Reference

Infeed per Pass and Number of Passes

■ 30° Trapezoidal (TR) inserts

		For external					For internal				
Pitch		2	3	4	5	6	2	3	4	5	6
Height of thread		1.25	1.75	2.25	2.75	3.5	1.25	1.75	2.25	2.75	3.5
Total depth of cut		1.35	1.85	2.35	2.85	3.6	1.35	1.85	2.35	2.85	3.6
Number of passes	1	0.25	0.25	0.3	0.3	0.3	0.2	0.22	0.25	0.25	0.25
	2	0.2	0.22	0.25	0.25	0.25	0.18	0.2	0.22	0.22	0.22
	3	0.2	0.2	0.22	0.2	0.23	0.18	0.18	0.2	0.2	0.21
	4	0.18	0.18	0.2	0.2	0.2	0.16	0.16	0.2	0.18	0.2
	5	0.15	0.17	0.18	0.18	0.18	0.15	0.16	0.17	0.18	0.18
	6	0.12	0.16	0.16	0.16	0.18	0.13	0.16	0.16	0.16	0.18
	7	0.1	0.14	0.15	0.16	0.16	0.1	0.14	0.16	0.16	0.16
	8	0.1	0.14	0.14	0.15	0.16	0.1	0.14	0.14	0.15	0.16
	9	0.05	0.12	0.14	0.14	0.16	0.1	0.12	0.14	0.14	0.16
	10		0.12	0.12	0.14	0.16	0.05	0.12	0.12	0.14	0.16
	11		0.1	0.12	0.14	0.16		0.1	0.12	0.14	0.16
	12		0.05	0.12	0.12	0.15		0.1	0.12	0.12	0.15
	13			0.1	0.12	0.15		0.05	0.1	0.12	0.15
	14			0.1	0.12	0.15			0.1	0.12	0.15
	15			0.05	0.12	0.14			0.1	0.12	0.14
	16				0.1	0.14			0.05	0.1	0.14
	17				0.1	0.12				0.1	0.12
	18				0.1	0.12				0.1	0.12
	19				0.05	0.12				0.1	0.12
	20					0.12				0.05	0.12
	21					0.1					0.1
	22					0.1					0.1
	23					0.05					0.1
	24										0.05
	25										
	26										

(Unit: mm)

■ 29° Trapezoidal (TR) inserts

		For external			For internal		
TPI		8	6	5	8	6	5
Height of thread		1.88	2.41	2.92	1.88	2.41	2.92
Total depth of cut		1.98	2.51	3.02	1.98	2.51	3.02
Number of passes	1	0.25	0.25	0.25	0.22	0.22	0.22
	2	0.22	0.22	0.22	0.2	0.2	0.2
	3	0.2	0.2	0.2	0.18	0.18	0.18
	4	0.18	0.18	0.18	0.16	0.18	0.18
	5	0.16	0.17	0.18	0.16	0.16	0.16
	6	0.16	0.16	0.16	0.16	0.15	0.16
	7	0.16	0.16	0.16	0.15	0.15	0.15
	8	0.14	0.14	0.14	0.14	0.14	0.14
	9	0.14	0.14	0.14	0.14	0.14	0.14
	10	0.12	0.14	0.14	0.12	0.14	0.14
	11	0.1	0.14	0.14	0.1	0.14	0.14
	12	0.1	0.12	0.14	0.1	0.12	0.14
	13	0.05	0.12	0.12	0.1	0.12	0.12
	14		0.12	0.12	0.05	0.12	0.12
	15		0.1	0.12		0.1	0.12
	16		0.1	0.12		0.1	0.12
	17		0.05	0.12		0.1	0.12
	18			0.12		0.05	0.12
	19			0.1			0.1
	20			0.1			0.1
	21			0.05			0.1
	22						0.05
	23						
	24						
	25						
	26						

(Unit: mm)

■ PT full-profile inserts

		For external				For internal		
TPI		28	19	14	11	19	14	11
Height of thread		0.6	0.86	1.16	1.48	0.86	1.16	1.48
Total depth of cut		0.7	0.96	1.26	1.58	0.96	1.26	1.58
Number of passes	1	0.25	0.28	0.3	0.3	0.22	0.25	0.25
	2	0.2	0.2	0.25	0.25	0.2	0.22	0.22
	3	0.1	0.18	0.2	0.22	0.18	0.18	0.18
	4	0.1	0.15	0.15	0.18	0.16	0.14	0.18
	5	0.05	0.1	0.11	0.15	0.1	0.12	0.15
	6		0.05	0.1	0.12	0.05	0.1	0.13
	7			0.1	0.11	0.05	0.1	0.12
	8			0.05	0.1		0.1	0.1
	9				0.1		0.05	0.1
	10				0.05			0.1
	11							0.05
	12							
	13							
	14							
	15							
	16							
	17							
	18							
	19							
	20							
	21							
	22							
	23							
	24							
	25							
	26							

(Unit: mm)

■ NPT full-profile inserts

		For external				For internal		
TPI		18	14	11.5	8	14	11.5	8
Height of thread		1.14	1.47	1.79	2.58	1.47	1.79	2.58
Total depth of cut		1.24	1.57	1.89	2.68	1.57	1.89	2.68
Number of passes	1	0.2	0.25	0.25	0.3	0.22	0.22	0.25
	2	0.18	0.22	0.22	0.25	0.2	0.2	0.2
	3	0.17	0.2	0.2	0.2	0.18	0.18	0.2
	4	0.16	0.18	0.18	0.2	0.18	0.18	0.2
	5	0.14	0.17	0.18	0.2	0.16	0.16	0.2
	6	0.12	0.16	0.17	0.2	0.14	0.16	0.2
	7	0.12	0.12	0.16	0.18	0.12	0.16	0.18
	8	0.1	0.12	0.14	0.18	0.12	0.14	0.18
	9	0.05	0.1	0.12	0.16	0.1	0.12	0.16
	10		0.05	0.12	0.16	0.1	0.12	0.16
	11			0.1	0.14	0.05	0.1	0.14
	12			0.05	0.14		0.1	0.14
	13				0.12		0.05	0.12
	14				0.1			0.1
	15				0.1			0.1
	16				0.05			0.1
	17							0.05
	18							
	19							
	20							
	21							
	22							
	23							
	24							
	25							
	26							

(Unit: mm)



User's Guide - Technical Reference

Standard Cutting Conditions and Infeed Methods

Threading guidelines





Determine the infeed per pass and number of threads whilst referring to the table and description below.

Pitch (mm)	0.5	0.75	1	1.25	1.5	1.75	2	2.5	3	3.5	4	4.5	5 ~
TPI	48	32	24	20	16	14	12	10	8	7	6	5.5	5 ~
No. of passes	4 ~ 6	4 ~ 7	4 ~ 8	5 ~ 9	6 ~ 10	7 ~ 12	7 ~ 12	8 ~ 14	10 ~ 16	11 ~ 18	11 ~ 18	11 ~ 19	12 ~ 24

Note:

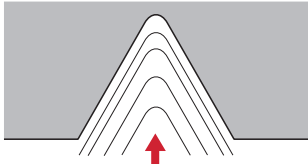
- When using the full-profile insert, set the total infeed amount by taking the finish stock of 0.1mm into account.
- Set the first infeed to 150 ~ 200% of nose R and do not allow it to exceed 0.5 mm.
- The infeed amount during the final pass must be a minimum of 0.05 mm. No zero cuts should be made. (Extra small infeed or zero cutting of work hardened surfaces will reduce tool life.)
- The partial-profile insert or inside diameter insert has small nose R. Reduce the infeed per pass and increase the no. of passes.
- Regarding standard infeed per passes and no. of passes, please refer to our catalogue.

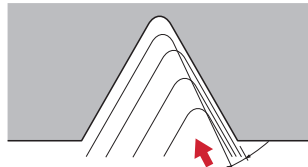
Infeed methods for threading tools

Infeed method	Features
 <p>Straight infeed (radial infeed)</p>	<ul style="list-style-type: none"> • Most simple and usual method • Suitable for relatively small pitch threads of easily machinable material. • Chip contact length on right and left is longer, causing chattering, with increased load on the nose end. • When the half included angle is not symmetrical to the right and left, infeeding in the direction of 1/2 of the included angle will ensure equal machining with right and left cutting edges.
 <p>Single edge infeed (flank infeed)</p>	<ul style="list-style-type: none"> • Suitable for large pitch threads or easy to tear materials. Effectively prevents chattering. • Chips are discharged in one direction only. Satisfactory chip control. • Edge on the right (with zero infeed) tends to be worn heavily.
 <p>Modified single-edge infeed (flank infeed)</p>	<ul style="list-style-type: none"> • Edge on the right performs some cutting, therefore wear of this edge can thus be suppressed. • Suitable for large pitch threads or easy to tear materials. Effectively prevents chattering. • Chips are discharged in one direction only. Satisfactory chip control.
 <p>Alternating flank infeed</p>	<ul style="list-style-type: none"> • Suitable for large pitch threads or easy to tear material. Effectively prevents chattering. • Chips are discharged alternately in right and left directions, resulting possibly in entanglement. • Right and left edges are used alternately, ensuring uniform wear and extending tool life.

Selection of ST-type Toolholders

Selection of internal threading toolholders

Relation between internal toolholders and machinable threads

In the tables starting from next page, the relationships between toolholders, inserts, threads to be machined, and shims to be replaced are shown. In these tables, the criteria are set as follows.

- The minimum machining diameter.
- The L/D ratio of the toolholder.
- The lead angle of the thread.
- Cutting conditions.

Especially when machining near the minimum machining diameter, the compensation for the lead angle should be done carefully. Moreover, in threading, because chips generally can not be broken into small pieces, the shank size should be selected in consideration of adequate clearance (C₁).

Symbols

- Recommended
- Usable
- Needs replacing of the shim. "2" indicates "Change to the shim for 2° lead angle".
- Unusable

Clearance C ₁		$C_1 \geq 3 \text{ mm}$ (1 mm for 6IR insert holders)			
		<table border="1"> <tr> <td>Steel shank</td> <td>$L/D \leq 2 \rightarrow \text{○}$</td> </tr> <tr> <td>Carbide shank</td> <td>$L/D \leq 3 \rightarrow \text{○}$</td> </tr> </table>	Steel shank	$L/D \leq 2 \rightarrow \text{○}$	Carbide shank
Steel shank	$L/D \leq 2 \rightarrow \text{○}$				
Carbide shank	$L/D \leq 3 \rightarrow \text{○}$				

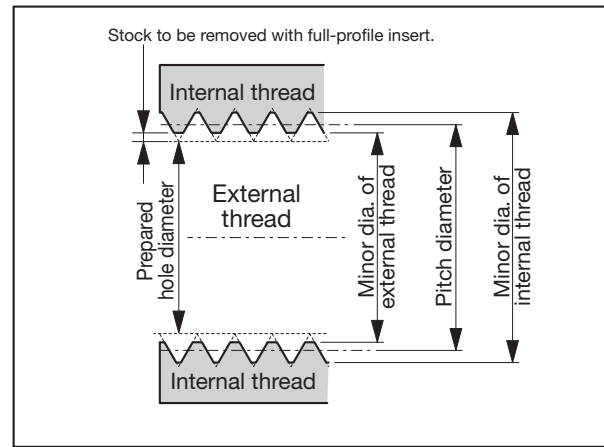

How to use the tables

- ① Firstly, find the nominal thread diameter. Example: M35 X 1.5
- ② The table indicates that the lead angle is 0°48'.
- ③ The Cat. No. of the insert to be used corresponds with IR15ISO.
- ④ By following the row to the right, and marks are found. The mark indicates the optimum toolholder type. The toolholders of mark are usable, but less rigid because the shank diameter against the threading diameter is smaller than those of marked toolholder. In this example, CNR0025R16 and TCNR0020R16DT are the optimum toolholders. The insert Cat.No. is 16IR15ISO.
- ⑤ In the case of M33 X 3 thread, the lead angle is 1°46'. By following the row to the right, mark is found. This indicates that the shim should be replaced to 2° type. For calculation of the lead angle, refer to page L045.

Metric fine screw thread (ISO)

(For full size of this table, see page L053.)

Nominal size	Pitch	Effective diameter	Lead angle	Shank material	Steel shank										Carbide shank					"Tsuppari-Ichiban"							
				Holder Cat. No.	6IR		11IR		16IR		22IR		6IR		11IR	16IR	16IR		22IR								
					Insert size	Insert Cat. No.	Insert size	Insert Cat. No.	Insert size	Insert Cat. No.	Insert size	Insert Cat. No.	Insert size	Insert Cat. No.	Insert size	Insert Cat. No.	Insert size	Insert Cat. No.	Insert size	Insert Cat. No.							
M33×1.5	1.5	32.03	0°51'	IR15ISO																							
M33×2	2	31.7	1°09'	IR20ISO																							
M33×3	3	31.05	1°46'	IR30ISO																							
M35×1.5	1.5	34.03	0°48'	IR15ISO																							
M36×1.5	1.5	35.03	0°47'	IR15ISO																							
M36×2	2	34.7	1°03'	IR20ISO																							
M36×3	3	34.05	1°20'	IR30ISO																							
M38×1.5	1.5	37.03	0°45'	IR15ISO																							

User's Guide - Technical Reference

Selection of ST-type Toolholders

Selection of Internal Toolholders—Relationship between thread sizes, toolholders, and inserts—Part 1

■ Metric coarse screw thread (ISO)

Nominal size	Pitch	Pitch diameter	Lead angle	Shank material Insert size Holder Cat. No. Insert Cat. No.	Steel shank												Carbide shank					*Suppari-Ichiban*							
					6IR				11IR				22IR				6IR		11IR		16IR	22IR							
					SNR0006H06-2	SNR0006H06-3	SNR0008H06-2	SNR0008H06-3	SNR0010K11-2	SNR0010K11-3	SNR0013L11-2	SNR0013L11-3	SNR0016M16-2	SNR0016M16-3	SNR0020Q22-2	SNR0020Q22-3	CNR0025R22	CNR0032S22	(CNR0040T22)	CNR0040T27	(CNR0050U27)	SNR0006K06SC-2	SNR0006K06SC-3	SNR0008K06SC-2	SNR0008K06SC-3	SNR0010M11SC-2	SNR0010M11SC-3	SNR0016R16SC-2	(SNR0016R16SC-3)
M10	1.5	9.03	3°02'	IR15ISO																									
M11	1.5	10.03	2°44'	IR15ISO																		○							
M12	1.75	10.86	2°56'	IR175ISO		○																○							
M14	2	12.7	2°52'	IR20ISO				○																					
M16	2	14.7	2°29'	IR20ISO	•		○																•		○				
M18	2.5	16.38	2°47'	IR25ISO																									
M20	2.5	18.38	2°29'	IR25ISO																									
M22	2.5	20.38	2°14'	IR25ISO																									
M24	3	22.05	2°29'	IR30ISO																									
M27	3	25.05	2°11'	IR30ISO									○													○			
M30	3.5	27.73	2°18'	IR35ISO																									
M33	3.5	30.73	2°05'	IR35ISO																									
M36	4	33.4	2°11'	IR40ISO																									
M39	4	36.4	2°00'	IR40ISO																									
M42	4.5	39.08	2°06'	IR45ISO																									
M45	4.5	42.08	1°57'	IR45ISO																									
M48	5	44.75	2°02'	IR50ISO																									
M52	5	48.75	1°52'	IR50ISO																									
M56	5.5	52.43	1°55'	IR55ISO																									
M60	5.5	56.43	1°47'	IR55ISO																									
M64	6	60.1	1°49'	IR60ISO																									
M68	6	64.1	1°42'	IR60ISO																									

② : Change the shim to NXN22-2 ←

② : Change the shim to NXN27-2 ←

② : Change the shim to GXN22-2DT ←

■ Metric fine screw thread (ISO)

1/4

Nominal size	Pitch	Pitch diameter	Lead angle	Shank material Insert size Holder Cat. No. Insert Cat. No.	Steel shank							Carbide shank																	
					6IR				11IR			6IR			11IR														
					SNR0006H06-2	SNR0006H06-3	SNR0008H06-2	SNR0008H06-3	SNR0010K11	SNR0010K11-2	SNR0010K11-3	SNR0013L11	SNR0013L11-2	SNR0013L11-3	SNR0006K06SC-2	SNR0006K06SC-3	SNR0008K06SC-2	SNR0008K06SC-3	SNR0010M11SC	SNR0010M11SC-2	SNR0010M11SC-3	SNR0012P11SC	SNR0012P11SC-2	SNR0012P11SC-3					
M9×0.75	0.75	8.51	1°36'	IR075ISO																									
M9×1	1	8.32	2°11'	IR10ISO																									
M10×0.75	0.75	9.51	1°26'	IR075ISO																									
M10×1	1	9.35	1°57'	IR10ISO	○																								
M10×1.25	1.25	9.19	2°29'	IR125ISO																									
M11×0.75	0.75	10.51	1°18'	IR075ISO																									
M11×1	1	10.35	1°46'	IR10ISO	○																								
M12×1	1	11.35	1°36'	IR10ISO	•		○																						
M12×1.25	1.25	11.19	2°02'	IR125ISO	○																								
M12×1.5	1.5	11.03	2°29'	IR15ISO	○																								
M14×1	1	13.35	1°22'	IR10ISO																									
M14×1.25	1.25	13.19	1°44'	IR125ISO	•		○																						
M14×1.5	1.5	13.03	2°06'	IR15ISO	•		○																						
M15×1	1	14.35	1°16'	IR10ISO																									
M15×1.5	1.5	14.03	1°57'	IR15ISO	•		○																						
M16×1	1	15.35	1°11'	IR10ISO						○																			
M16×1.5	1.5	15.03	1°49'	IR15ISO	•		○																						
M17×1	1	16.35	1°07'	IR10ISO							○																		
M17×1.5	1.5	16.03	1°42'	IR15ISO	•		•				○																		
M18×1	1	17.35	1°03'	IR10ISO						○																			
M18×1.5	1.5	17.03	1°36'	IR15ISO	•		•				○																		
M18×2	2	16.7	2°11'	IR20ISO	•		•				○																		
M20×1	1	19.35	0°57'	IR10ISO						•																			
M20×1.5	1.5	19.03	1°26'	IR15ISO						•																			
M20×2	2	18.7	1°57'	IR20ISO	•		•				○																		

Note : The above tables show correspondence of internal toolholders at the time of setting clearance between thread and toolholder to 3 mm (1 mm in case of SN type) and the finishing stock to 0.1 mm.

Unified fine screw thread (UNF)

Nominal size	TPI	Pitch diameter	Lead angle	Shank material	Steel shank									Carbide shank						"Tsuppari-Ichiban"						
				Insert size	6IR			11IR			16IR			6IR		11IR		16IR		16IR						
				Holder Cat. No.	SNR0006H06-2	SNR0008H06-3	SNR0008H06-2	SNR0008H06-3	SNR0010K11-2	SNR0013L11-2	SNR0016M16	SNR0016M16-2	CNR0020P16	CNR0025R16	SNR0006K06SC-2	SNR0006K06SC-3	SNR0008K06SC-2	SNR0008K06SC-3	SNR0010M11SC	SNR0010M11SC-2	SNR0012P11SC	SNR0012P11SC-2	SNR0016R16SC	SNR0016R16SC-2	TSNR0016Q16	TCNR0020R16DT
3/8-24UNF	24	8.84	2°11'	(IR24UN)																						
				IRA60																						
7/16-20UNF	20	10.29	2°15'	(IR20UN)																						
				IRA60	○									○												
1/2-20UNF	20	11.87	1°57'	(IR20UN)																						
				IRA60	•		○							•		○										
9/16-18UNF	18	13.37	1°55'	(IR18UN)																						
				IRA60	•		○							•		○										
5/8-18UNF	18	14.96	1°43'	(IR18UN)																						
				IRA60	•		○							•		○										
3/4-16UNF	16	18.02	1°36'	IR16UN					○									○								
7/8-14UNF	14	21.05	1°34'	IR14UN					•	○								•		○						
1-12UNF	12	24.03	1°36'	IR12UN									○									○				
1 1/8-12UNF	12	27.2	1°25'	IR12UN								○										○		○		
1 1/4-12UNF	12	30.38	1°16'	IR12UN								•		○								○		•	○	
1 3/8-12UNF	12	33.55	1°09'	IR12UN								•		•	○							○		•	•	
1 1/2-12UNF	12	36.73	1°03'	IR12UN								•		•	○							○		•	•	

Unified extra fine screw thread (UNEF)

Nominal size	TPI	Pitch diameter	Lead angle	Shank material	Steel shank									Carbide shank						"Tsuppari-Ichiban"					
				Insert size	6IR			11IR			16IR			6IR		11IR		16IR		16IR					
				Holder Cat. No.	SNR0006H06-2	SNR0008H06-2	SNR0010K11	SNR0010K11-2	SNR0013L11	SNR0013L11-2	SNR0016M16	SNR0016M16-2	CNR0020P16	CNR0025R16	CNR0032S16	SNR0006H06SC-2	SNR0008H06SC-2	SNR0010K11	SNR0010K11-2	SNR0012L11	SNR0012L11-2	SNR0016M16	SNR0016M16-2	TSNR0016Q16	TCNR0020R16DT
3/8	32	9.01	1°61'	IR32UN																					
7/16	28	10.52	1°57'	IR28UN	○									○											
1/2	28	12.11	1°37'	IR28UN																					
9/16	24	13.6	1°42'	IR24UN																					
5/8	24	15.19	1°27'	IR24UN																					
11/16	24	16.77	1°15'	IR24UN				○									○								
3/4	20	18.22	1°27'	IR20UN				○								○									
13/16	20	19.81	1°17'	IR20UN				•		○						•									
7/8	20	21.4	1°08'	IR20UN				•		○					•										
15/16	20	22.99	1°01'	IR20UN				•		•					•										
1	20	24.57	0°94'	IR20UN				•		•		○			•								○		
1 1/16	18	26.07	0°99'	IR18UN				•		•		○			•							○		○	
1 1/8	18	27.66	0°93'	IR18UN				•		•		○			•							○		○	
1 3/16	18	29.25	0°88'	IR18UN				•		•		•			•							○		•	○
1 1/4	18	30.83	0°84'	IR18UN				•		•		•			•							○		•	○
1 5/16	18	32.42	0°79'	IR18UN				•		•		•			•							○		•	○
1 3/8	18	34.01	0°76'	IR18UN				•		•		•			•							○		•	○
1 7/16	18	35.6	0°72'	IR18UN				•		•		•			•							○		•	○
1 1/2	18	37.18	0°69'	IR18UN				•		•		•			•							○		•	○
1 9/16	18	38.77	0°66'	IR18UN				•		•		•			•							○		•	○
1 5/8	18	40.36	0°64'	IR18UN				•		•		•			•							○		•	○
1 11/16	18	41.95	0°61'	IR18UN				•		•		•			•							○		•	○

Note : The above tables show correspondence of internal toolholders at the time of setting clearance between thread and toolholder to 3 mm (1 mm in case of SN type) and the finishing stock to 0.1 mm.

User's Guide - Technical Reference

Selection of ST-type Toolholders

Whitworth British Standard (BSW) (for pipe)

Nominal size	TPI	Pitch diameter	Lead angle	Shank material		Steel shank										Carbide shank		"Tsuppari-Ichiban"					
				Insert size Holder Cat. No.	16IR					22IR					16IR		16IR		22IR				
					Insert Cat. No.	SNR0016M16	SNR0016M16-2	SNR0016M16-3	CNR0020P16	CNR0025R16	CNR0032S16	SNR0020Q22	SNR0020Q22-2	SNR0020Q22-3	CNR0025R22	CNR0032S22	SNR0016M16	SNR0016M16-2	TSNR0016Q16	TCNR0020R16DT	TCNR0025S16DT	TSNR0020R22	TCNR0025S22DT
7/16	14	9.95	3°32'	IR14W																			
1/2	12	11.34	3°40'	IR12W																			
9/16	12	12.93	2°98'	IR12W																			
5/8	11	14.4	2°92'	IR11W																			
11/16	11	15.98	2°63'	IR11W																			
3/4	10	17.42	2°66'	IR10W																			
7/8	9	20.42	2°52'	IR9W																			
1	8	23.37	2°48'	IR8W																			
1 1/8	7	26.25	2°52'	IR7W																			
1 1/4	7	29.43	2°25'	IR7W										○									
1 1/2	6	35.39	2°18'	IR6W										○									
1 3/4	5	41.2	2°25'	IR5W											②							②	

② : Change the shim to NXN22-2 ←

② : Change the shim to GXN22-2DT ←

Whitworth British Standard Fine (BSF) (for pipe)

Nominal size	TPI	Pitch diameter	Lead angle	Shank material		Steel shank										Carbide shank		"Tsuppari-Ichiban"											
				Insert size Holder Cat. No.	6IR					11IR					16IR					22IR		6IR		16IR		16IR		22IR	
					Insert Cat. No.	SNR0006H06-2	SNR0008H06-2	SNR0010K11	SNR0010K11-2	SNR0016M16	SNR0016M16-2	SNR0016M16-3	CNR0020P16	CNR0025R16	SNR0020Q22	SNR0020Q22-2	SNR0020Q22-3	CNR0025R22	CNR0032S22	SNR0006H06SC-2	SNR0008H06SC-2	SNR0016M16	SNR0016M16-2	TSNR0016Q16	TCNR0020R16DT	TCNR0025S16DT	TSNR0020R22	TCNR0025S22DT	
7/16	18	10.21	2°52'	IR18W																									
1/2	16	11.68	2°48'	IR16W	○											○													
9/16	16	13.27	2°18'	IR16W	•	○										•	○												
5/8	14	14.71	2°25'	IR14W																									
11/16	14	16.3	2°03'	IR14W				○																					
3/4	12	17.69	2°18'	IR12W																									
7/8	11	20.75	2°03'	IR11W																									
1	10	23.77	1°95'	IR10W							○																		
1 1/8	9	26.77	1°92'	IR9W							○								○										
1 1/4	9	29.94	1°72'	IR9W							•	②							○			②							
1 3/8	8	32.89	1°76'	IR8W							•	②							○			②							
1 1/2	8	36.07	1°61'	IR8W							•	②							○			•	②						
1 5/8	8	39.24	1°48'	IR8W				•			•	○							○			•	•	○					
1 3/4	7	42.13	1°57'	IR7W								○		②											②				
2	7	48.48	1°37'	IR7W								•				•	○							•	○				
2 1/4	6	54.44	1°42'	IR6W								•				•	○							•	○				
2 1/2	6	60.79	1°27'	IR6W								•				•	○							•	○				
2 3/4	6	67.14	1°15'	IR6W								•				•	○							•	○				
3	5	72.95	1°27'	IR5W								•				•	○							•	○				
3 1/4	5	79.3	1°17'	IR5W								•				•	○							•	○				

② : Change the shim to AN16-2 ←

② : Change the shim to NXN22-2 ←

② : Change the shim to AN16-2DT ←

② : Change the shim to GXN22-2DT ←

Note : The above tables show correspondence of internal toolholders at the time of setting clearance between thread and toolholder to 3 mm (1 mm in case of SN type) and the finishing stock to 0.1 mm.

■ 30° trapezoidal thread (TR) (for machine parts)

Nominal size	Pitch	Pitch diameter	Lead angle	Shank material		Steel shank										Carbide shank			“Tsugari-Ichiban”																							
				Insert size	Holder Cat. No.	16IR					22IR					27IR					16IR			16IR		22IR																
				Insert Cat. No.	SNR0016M16	SNR0016M16-2	SNR0016M16-3	CNR0020P16	CNR0025R16	CNR0032S16	CNR0040T16	CNR0050U16	SNR0020Q22	SNR0020Q22-2	SNR0020Q22-3	CNR0025R22	CNR0032S22	CNR0040T27	(CNR0050U27)	SNR0016R16SC	SNR0016R16SC-2	(SNR0016R16SC-3)	TSNR0016Q16	TCNR0020R16DT	TCNR0025S16DT	(TCNR0032T16DT)	TSNR0020R22	TCNR0025S22DT	(TCNR0032T22DT)													
TR22×3	3	20.5	2°40′	IR30TR																																						
TR24×5	5	21.5	4°14′	IR50TR																																						
TR24×3	3	22.5	2°26′	IR30TR																																						
TR26×5	5	23.5	3°52′	IR50TR																																						
TR26×3	3	24.5	2°14′	IR30TR		○																																				
TR28×5	5	25.5	3°34′	IR50TR																																						
TR28×3	3	26.5	2°04′	IR30TR		•																																				
TR30×6	6	27	4°03′	IR60TR																																						
TR30×3	3	28.5	1°55′	IR30TR		•																																				
TR32×6	6	29	3°46′	IR60TR																																						
TR32×3	3	30.5	1°48′	IR30TR		•		[2]																																		
TR34×6	6	31	3°32′	IR60TR																																						
TR34×3	3	32.5	1°41′	IR30TR		•		[2]																																		
TR36×6	6	33	3°19′	IR60TR																																						
TR36×3	3	34.5	1°35′	IR30TR		•		2	[2]																																	
TR38×3	3	36.5	1°30′	IR30TR		•		2	[2]																																	
TR40×3	3	38.5	1°25′	IR30TR	•		•		○																																	
TR42×3	3	40.5	1°21′	IR30TR	•		•		○																																	
TR44×3	3	42.5	1°17′	IR30TR	•		•		○																																	
TR46×3	3	44.5	1°14′	IR30TR	•		•		○																																	
TR48×3	3	46.5	1°11′	IR30TR	•		•		○																																	
TR50×3	3	48.5	1°08′	IR30TR	•		•		○																																	
TR52×3	3	50.5	1°05′	IR30TR	•		•		○																																	
TR55×3	3	53.5	1°01′	IR30TR	•		•		○																																	
TR60×3	3	58.5	0°56′	IR30TR	•		•		○																																	

[2]: Change the shim to AN16-2 ←

[2]: Change the shim to AN16-2DT ←

■ 30° trapezoidal thread (TR) (for machine parts)

Nominal size	Pitch	Pitch diameter	Lead angle	Shank material		Steel shank										Carbide shank			“Tsugari-Ichiban”																						
				Insert size	Holder Cat. No.	16IR					22IR					27IR					16IR			16IR		22IR															
				Insert Cat. No.	SNR0016M16	SNR0016M16-2	SNR0016M16-3	CNR0020P16	CNR0025R16	CNR0032S16	SNR0020Q22	SNR0020Q22-2	SNR0020Q22-3	CNR0025R22	CNR0032S22	(CNR0040T22)	(CNR0050U22)	(CNR0063V22)	CNR0040T27	(CNR0050U27)	(CNR0063V27)	SNR0016R16SC	SNR0016R16SC-2	(SNR0016R16SC-3)	TSNR0016Q16	TCNR0020R16DT	TCNR0025S16DT	(TCNR0032T16DT)	TSNR0020R22	TCNR0025S22DT	(TCNR0032T22DT)										
TR65×4	4	63	1°09′	IR40TR						•				•	•	•		○																							
TR70×4	4	68	1°04′	IR40TR						•				•	•	•		○																							
TR75×4	4	73	1°00′	IR40TR						•				•	•	•		○																							
TR80×4	4	78	0°56′	IR40TR						•				•	•	•		○																							
TR85×4	4	83	0°53′	IR40TR						•				•	•	•		○																							
TR90×4	4	88	0°50′	IR40TR						•				•	•	•		○																							
TR95×4	4	93	0°47′	IR40TR						•				•	•	•		○																							
TR100×4	4	98	0°45′	IR40TR						•				•	•	•		○																							
TR105×4	4	103	0°42′	IR40TR						•				•	•	•		○																							
TR110×4	4	108	0°41′	IR40TR						•				•	•	•		○																							
TR115×6	6	112	0°59′	IR60TR																•	•	○																			
TR120×6	6	117	0°56′	IR60TR																•	•	○																			
TR125×6	6	122	0°54′	IR60TR																•	•	○																			
TR130×6	6	127	0°52′	IR60TR																•	•	○																			
TR135×6	6	132	0°50′	IR60TR																•	•	○																			
TR140×6	6	137	0°48′	IR60TR																•	•	○																			
TR145×6	6	142	0°46′	IR60TR																•	•	○																			
TR150×6	6	147	0°45′	IR60TR																•	•	○																			
TR155×6	6	152	0°43′	IR60TR																•	•	○																			
TR160×6	6	157	0°42′	IR60TR																•	•	○																			
TR165×6	6	162	0°41′	IR60TR																•	•	○																			
TR170×6	6	167	0°39′	IR60TR																•	•	○																			

Note: The above tables show correspondence of internal toolholders at the time of setting clearance between thread and toolholder to 3 mm (1 mm in case of SN type) and the finishing stock to 0.1 mm.

User's Guide - Technical Reference

Selection of ST-type Toolholders

Parallel pipe thread (G) (for pipe) This table is also applied to PF, Rp, and PS type threads.

Nominal size	TPI	Pitch	Pitch diameter	Lead angle	Shank material Insert size Holder Cat. No. Insert Cat. No.	Steel shank										Carbide shank						"Tsuppari-Ichiban"													
						6IR		11IR			16IR					6IR		11IR		16IR		16IR													
						SNR0006H06-2	SNR0008H06-2	SNR0010K11	SNR0010K11-2	SNR0013L11	SNR0013L11-2	SNR0016M16	SNR0016M16-2	CNR0020P16	CNR0025R16	CNR0032S16	(CNR0040T16)	(CNR0050U16)	SNR0006K06SC-2	SNR0006K06SC-3	SNR0008K06SC-2	SNR0008K06SC-3	SNR0010M11SC	SNR0010M11SC-2	SNR0012P11SC	SNR0012P11SC-2	SNR0016R16SC	SNR0016R16SC-2	TSNR0016Q16	TCNR0020R16DT	TCNR0025S16DT	TCNR0032T16DT			
G1/4	19	1.34	12.30	1°59'	IR19W	•	○											•	○																
G3/8	19	1.34	15.81	1°33'	IR19W	•	•		○										•	○															
G1/2	14	1.81	19.79	1°40'	IR14W				•			○									•				○										
G5/8	14	1.81	21.75	1°31'	IR14W				•			○									•				○										
G3/4	14	1.81	25.28	1°18'	IR14W			•		•		○									•				○			○							
G7/8	14	1.81	29.04	1°08'	IR14W			•		•		○									•				○			○							
G1	11	2.31	31.77	1°20'	IR11W							•			○									○			○								
G1-1/8	11	2.31	36.42	1°09'	IR11W							•			○									○			○								
G1-1/4	11	2.31	40.43	1°02'	IR11W							•			○									○			○								
G1-1/2	11	2.31	46.32	0°55'	IR11W							•			○									○			○								
G1-3/4	11	2.31	52.27	0°48'	IR11W							•			○									○			○								
G2	11	2.31	58.14	0°43'	IR11W							•			○									○			○								
G2-1/4	11	2.31	64.23	0°39'	IR11W							•			○									○			○								
G2-1/2	11	2.31	73.71	0°34'	IR11W							•			○									○			○								
G2-3/4	11	2.31	80.06	0°32'	IR11W							•			○									○			○								
G3	11	2.31	86.41	0°29'	IR11W										○																				
G3-1/2	11	2.31	98.85	0°26'	IR11W										○																				
G4	11	2.31	111.55	0°23'	IR11W										○																				
G4-1/2	11	2.31	124.25	0°20'	IR11W										○																				
G5	11	2.31	136.95	0°18'	IR11W										○																				
G6	11	2.31	162.35	0°16'	IR11W										○																				

○ : Change the shim to AN16-0 ←

○ : Change the shim to AN16-0DT ←

Taper pipe thread (PT) (for pipe) This table is also applied to Rc type pipe thread.

Nominal size	TPI	Pitch	Pitch diameter	Lead angle	Shank material Insert size Holder Cat. No. Insert Cat. No.	Steel shank										Carbide shank						"Tsuppari-Ichiban"													
						6IR		11IR			16IR					6IR		11IR		16IR		16IR													
						SNR0006H06-2	SNR0006H06-3	SNR0008H06-2	SNR0008H06-3	SNR0010K11	SNR0010K11-2	SNR0013L11	SNR0013L11-2	SNR0016M16	SNR0016M16-2	CNR0020P16	CNR0025R16	CNR0032S16	(CNR0040T16)	(CNR0050U16)	SNR0006K06SC-2	SNR0006K06SC-3	SNR0008K06SC-2	SNR0008K06SC-3	SNR0010M11SC	SNR0010M11SC-2	SNR0012P11SC	SNR0012P11SC-2	SNR0016R16SC	SNR0016R16SC-2	TSNR0016Q16	TCNR0020R16DT	TCNR0025S16DT	TCNR0032T16DT	
PT1/4	19	1.34	12.30	1°59'	IR19PT	○																													
PT3/8	19	1.34	15.81	1°33'	IR19PT	•	○														•	○													
PT1/2	14	1.81	19.79	1°40'	IR14PT					○													•			○									
PT3/4	14	1.81	25.28	1°19'	IR14PT								○										•			○									
PT1	11	2.31	31.77	1°20'	IR11PT								•			○										○									
PT1 1/4	11	2.31	40.43	1°02'	IR11PT								•			○									○										
PT1 1/2	11	2.31	46.32	0°55'	IR11PT								•			○									○										
PT2	11	2.31	58.14	0°43'	IR11PT								•			○									○										
PT2 1/2	11	2.31	73.71	0°34'	IR11PT								•			○									○										
PT3	11	2.31	86.41	0°29'	IR11PT											○																			
PT3 1/2	11	2.31	98.85	0°26'	IR11PT											○																			
PT4	11	2.31	111.55	0°23'	IR11PT											○																			
PT5	11	2.31	136.95	0°18'	IR11PT											○																			
PT6	11	2.31	162.35	0°16'	IR11PT											○																			
PT7	11	2.31	187.75	0°13'	IR11PT											○																			
PT8	11	2.31	213.15	0°12'	IR11PT											○																			
PT9	11	2.31	238.55	0°11'	IR11PT											○																			
PT10	11	2.31	263.95	0°10'	IR11PT											○																			
PT12	11	2.31	314.75	0°08'	IR11PT											○																			

○ : Change the shim to AN16-0 ←

○ : Change the shim to AN16-0DT ←

Note : The above tables show correspondence of internal toolholders at the time of setting clearance between thread and toolholder to 3 mm (1 mm in case of SN type) and the finishing stock to 0.1 mm.

National taper pipe thread (NPT) (for pipe)

Nominal size	TPI	Pitch	Lead angle	Shank material	Steel shank								Carbide shank				"Tsuppari-Ichiban"											
				Insert size	6IR			16IR					6IR		16IR		16IR											
				Holder Cat. No.	SNR0006H06-2	SNR0006H06-3	SNR0008H06-2	SNR0008H06-3	SNR0016M16	SNR0016M16-2	SNR0016M16-3	CNR0020P16	CNR0025R16	CNR0032S16	(CNR0040T16)	(CNR0050U16)	SNR0006K06SC-2	SNR0006K06SC-3	SNR0008K06SC-2	SNR0008K06SC-3	SNR0016R16SC	SNR0016R16SC-2	(SNR0016R16SC-3)	TSNR0016Q16	TCNR0020R16DT	TCNR0025S16DT	(TCNR0032T16DT)	
3/8NPT	18	1.41	1°37'	IR18NPT	•		○								•		○											
1/2NPT	14	1.81	1°40'	IR14NPT																								
3/4NPT	14	1.81	1°19'	IR14NPT																								
1NPT	11.5	2.21	1°17'	IR115NPT																								
1 1/4NPT	11.5	2.21	1°00'	IR115NPT																								
1 1/2NPT	11.5	2.21	0°52'	IR115NPT																								
2NPT	11.5	2.21	0°41'	IR115NPT																								
2 1/2NPT	8	3.175	0°50'	IR8NPT																								
3NPT	8	3.175	0°40'	IR8NPT																								
3 1/2NPT	8	3.175	0°35'	IR8NPT																								
4NPT	8	3.175	0°31'	IR8NPT																								
5NPT	8	3.175	0°25'	IR8NPT											○	○	○	○	○							○	○	○
6NPT	8	3.175	0°21'	IR8NPT											○	○	○	○	○							○	○	○
8NPT	8	3.175	0°16'	IR8NPT											○	○	○	○	○							○	○	○
10NPT	8	3.175	0°13'	IR8NPT											○	○	○	○	○							○	○	○
12NPT	8	3.175	0°11'	IR8NPT											○	○	○	○	○							○	○	○
14NPT	8	3.175	0°10'	IR8NPT											○	○	○	○	○							○	○	○
16NPT	8	3.175	0°09'	IR8NPT											○	○	○	○	○							○	○	○
18NPT	8	3.175	0°08'	IR8NPT											○	○	○	○	○							○	○	○
20NPT	8	3.175	0°07'	IR8NPT											○	○	○	○	○							○	○	○
24NPT	8	3.175	0°06'	IR8NPT											○	○	○	○	○							○	○	○

○ : Change the shim to AN16-0 ←

○ : Change the shim to AN16-0DT ←

29° trapezoidal thread (ACME) (for machine parts, pipe)

Nominal size	TPI	Pitch	Pitch diameter	Lead angle	Shank material	Steel shank										Carbide shank			"Tsuppari-Ichiban"										
					Insert size	16IR					22IR			27IR		16IR			16IR			22IR							
					Holder Cat. No.	SNR0016M16	SNR0016M16-2	SNR0016M16-3	CNR0020P16	CNR0025R16	CNR0032S16	SNR0020Q22	SNR0020Q22-2	SNR0020Q22-3	CNR0025R22	CNR0032S22	CNR0040T27	(CNR0050U27)	SNR0016R16SC	SNR0016R16SC-2	SNR0016R16SC-3	TSNR0016Q16	TCNR0020R16DT	TCNR0025S22DT	(TCNR0032T22DT)				
3/8	12	2.12	8.465	4°33'	IR12ACME																								
7/16	12	2.12	10.053	3°50'	IR12ACME																								
1/2	10	2.54	11.43	4°03'	IR10ACME																								
5/8	8	3.18	14.274	4°03'	IR8ACME																								
3/4	6	4.23	16.934	4°33'	IR6ACME																								
7/8	6	4.23	20.109	3°50'	IR6ACME																								
1	5	5.08	22.86	4°03'	IR5ACME																								
1-1/8	5	5.08	26.035	3°33'	IR5ACME																								
1-1/4	5	5.08	29.21	3°10'	IR5ACME																								
1-3/8	4	6.35	31.75	3°39'	IR4ACME																								
1-1/2	4	6.35	34.925	3°19'	IR4ACME																								
1-3/4	4	6.35	41.275	2°48'	IR4ACME																								
2	4	6.35	47.625	2°26'	IR4ACME																								

Because this thread standard is characterized with large pitch and small diameter, (that is a large lead angle) the standard inserts and toolholders can not be used for machining this thread type. The application is limited to outside of the standard.

Note : The above tables show correspondence of internal toolholders at the time of setting clearance between thread and toolholder to 3 mm (1 mm in case of SN type) and the finishing stock to 0.1 mm.

User's Guide - Technical Reference

THREADMILLING

Thread Milling CNC Program for Internal Thread

Right-hand thread (climb milling) from bottom up. Program is based on tool center.

This method of programming needs no tool radius compensation value, other than an offset for wear.

$$A = \frac{D_o - D}{2}$$

A = Radius of tool path
 D_o = Major thread diameter
 D = Cutting diameter

General Program

```

G90 G00 G54 G43 H1X0 Y0 Z10 S (n : Number of revolutions)
G00 Z-(to thread depth)
G01 G91 G41 D1 X (A/2) Y-(A/2) Z0 F (Center of tool)
G03 X(A/2) Y(A/2) R (A/2) Z(1/8 pitch) F (Cutting edge)
G03 X0 Y0 I-(A) J0 Z (pitch)
G03 X-(A/2) Y(A/2) R (A/2) Z(1/8 pitch)
G01 G40 X -(A/2) Y-(A/2) Z0
G90 X0 Y0 Z0
    
```

Internal Thread

Example: M20x2.0 IN-RH (Thread depth 20 mm)

Tool : MTEC1010C27 2.0ISO

(Cutting dia. 10 mm)

$A = (D_o - D) / 2 = (20 - 10) / 2 = 5$

$A/2 = 2.5$

(Tool compensation of radius=0)

```

G90 G0 G54 G43 G17 H1X0 Y0 Z10 S4000
G0 Z-20
G01 G91 G41 D1X 2.5 Y-2.5 Z0 F840
G03 X2.5 Y2.5 R2.5 Z0.25 F420
G03 X0 Y0 I-5.0 J0 Z2.0
G03 X-2.5 Y2.5 R2.5 Z0.25
G01 G40 X-2.5 Y-2.5 Z0
G90 G0 X0 Y0 Z0
M30
%
    
```

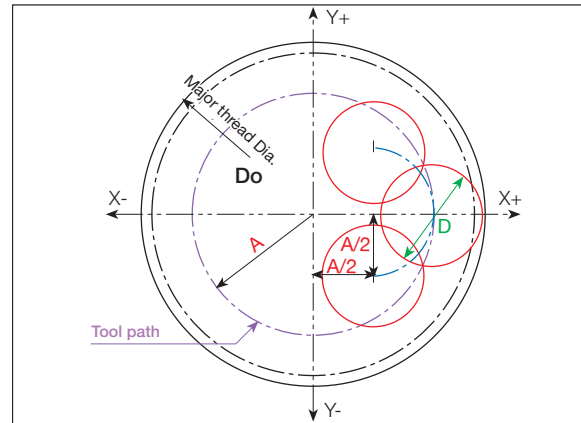

$$F \text{ (Center of tool)} = n \times f \times z$$

$$F \text{ (Cutting edge)} = \frac{D_o - D}{D_o} \times n \times f \times z$$

n : Number of revolutions
 f : rev / tooth
 z : Number of edge

Internal Thread

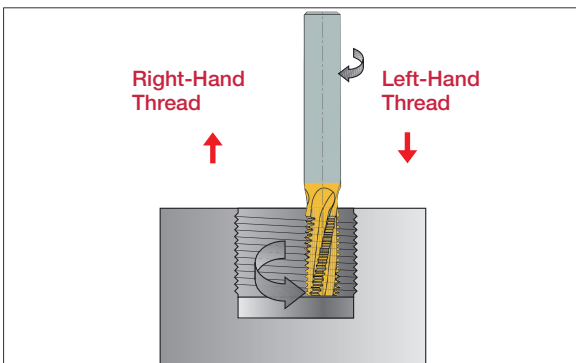

A thread milling operation is applicable for thread cutting in non-symmetrical parts utilizing the advantage of helical interpolation programs on modern machining centers.

External Thread

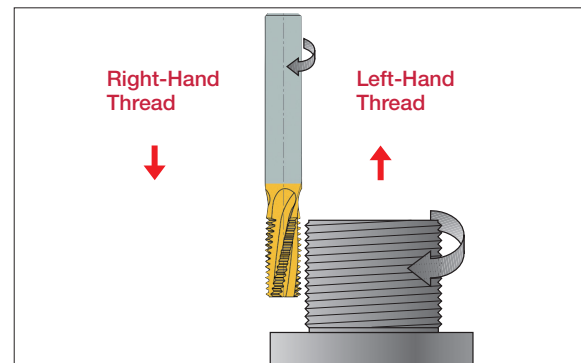

For more details, please check ThreadMilling advisor.

User's Guide - Technical Reference

Milling tools

Nomenclature for face milling cutter

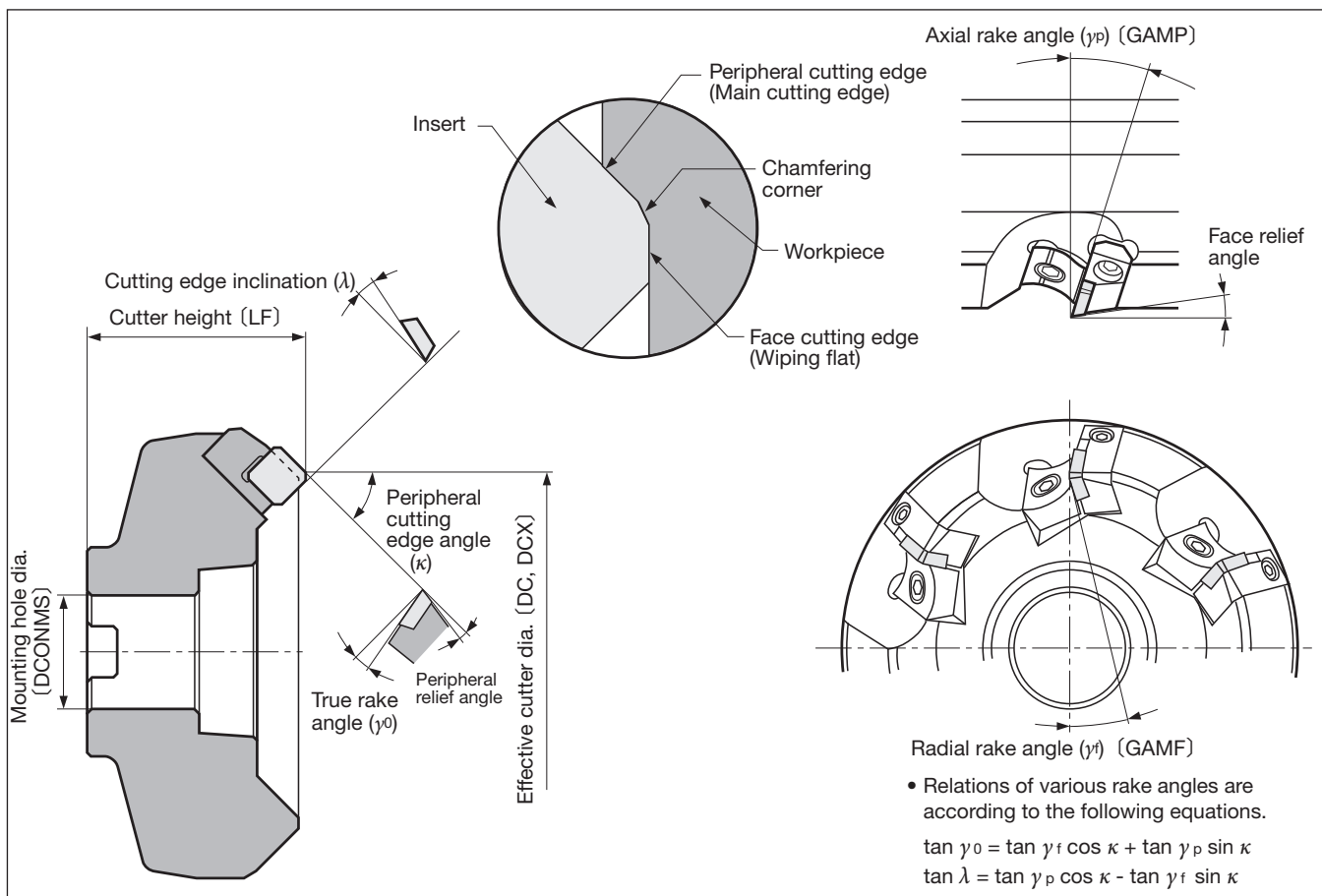

() The notation in the brackets is the one used in the catalog (ISO compliant)

Cutter geometry and applications

Condition		Rake angle combination and applicability		
		Negative-Negative	Negative-Positive	Positive-Positive
Shapes of cutting edge	γ_p (GAMP)	-	+	+
	γ_r (GAMF)	-	-	+
	γ_0	-	+	+
Workpiece material	Carbon steels, alloy steels (< 300HB)	△	⊙	⊙
	Stainless steels (< 300HB)	×	⊙	○
	Die steels (< 300HB)	△	⊙	○
	Cast irons Ductile cast irons	⊙	○	○
	Aluminum alloys	×	○	⊙
	Copper and its alloys	×	○	⊙
	Titanium and its alloys	×	○	○
	Hardened steels (40 ~ 55HRC)	○	○	×
Features		· Higher cutting edge strength · Many usable corners of inserts	· Excellent chip removal · Higher cutting edge strength and Freer cutting action	· Most excellent cutting action
Typical examples of mills		DoPent	TungMill DoTripleMill	TFE12 DPD09

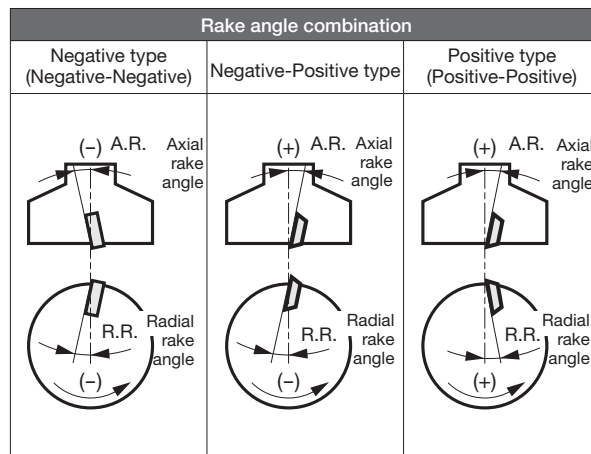

() The notation in the brackets is the one used in the catalog (ISO compliant)

User's Guide - Technical Reference

Milling tools

Calculation formulas for milling

●Cutting speed

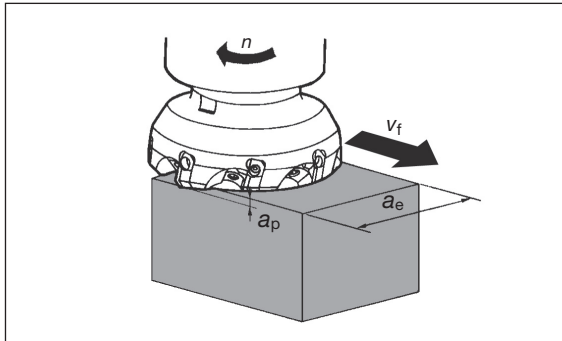

●Cutting speed (Calculated from number of revolutions)

$$SFM = \frac{RPM \times D}{3.82}$$

SFM : Cutting speed (m/min)

D : Effective diameter (mm) (DC, DCX)

RPM : Number of revolutions (min⁻¹)

●Number of revolution (Calculated from cutting speed)

$$RPM = \frac{SFM \times 3.82}{D}$$

●Feed speed and feed per tooth

$$V_f = f_z \times z \times n$$

V_f : Feed speed (in/min)

f_z : Feed per tooth (ipt)

z : No. of teeth of the cutter

n : Number of revolutions (min⁻¹)

Feed speed is relative speed of cutter and workpiece material and in the normal milling machine, it is the table speed.

In milling, the feed per tooth is very important. The recommended cutting condition is expressed by v_c and f_z and using the above equation calculate n and v_f and input in the machine.

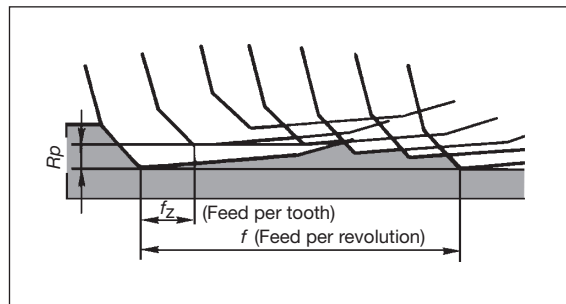

●Cutting time on face milling

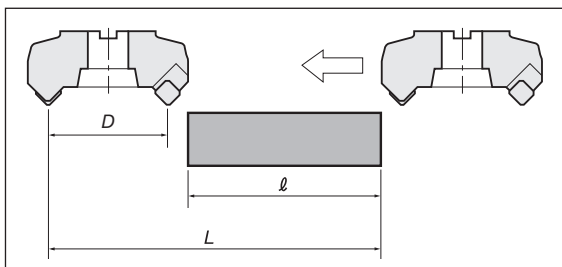

$$T = \frac{L}{V_f}$$

(min)

T : Cutting time (min)

L : Total table feed length.

(l : Workpieces length (in) + ϕD_c :

Effective cutter diameter (in)

(DC, DCX))

V_f : Feed speed (in/min)

() The notation in the brackets is the one used in the catalog (ISO compliant)

Depth of cut and width of cut

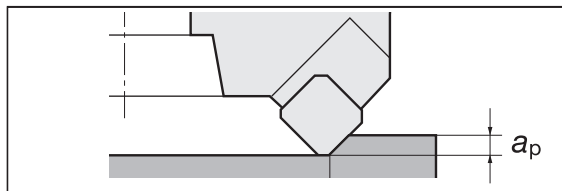

●Depth of cut

Determine by required allowance for machining and capacity of the machine. In case of mill, there are cutting limits according to shape and size of the insert. Please see spec in the catalog.

a_p : Depth of cut (in)

●Width of cut and engagement angle

There is an appropriate engage angle depending on the cutter diameter, cutting position, workpiece material, etc., and ordinarily the values in the table below are used as a guide.

D : Cutter diameter (in)
(DC, DCX)

E : Engage angle

a_e : Width of cut (in)

() The notation in the brackets is the one used in the catalog (ISO compliant)

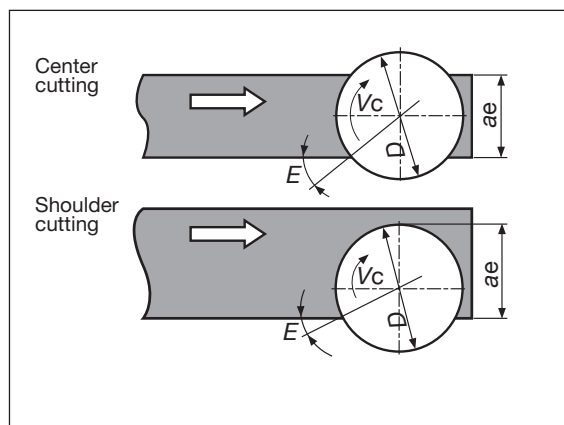

Center cutting

Workpiece material	Appropriate E	Cutter dia. and a_e
Steel	~ 42°	$a_e \cong \frac{2}{3} D$
Cast iron	~ 53°	$a_e \cong \frac{4}{5} D$

Shoulder cutting

Workpiece material	Appropriate E	Cutter dia. and a_e
Steel	~ 30°	$a_e \cong \frac{3}{5} D$
Cast iron	~ 40°	$a_e \cong \frac{3}{4} D$

Milling tools

Roughness of finished surface

(1) Theoretical surface roughness

Theoretical roughness as shown below, is the same as for single point turning

● With corner radius RE

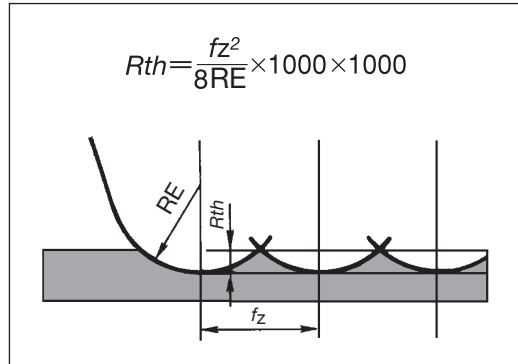

● Without corner radius RE

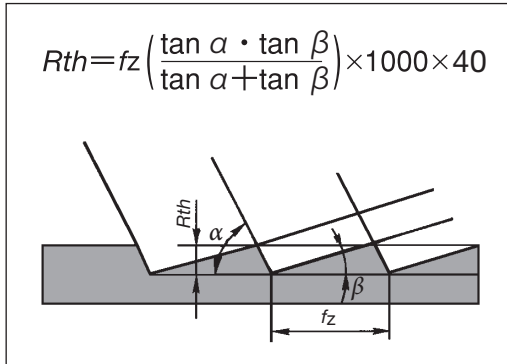

R_{th} : Theoretical roughness (μm)
 f_z : Feed per tooth (ipt)
 RE : Corner radius (in)
 α : Corner angle
 β : Face cutting edge angle

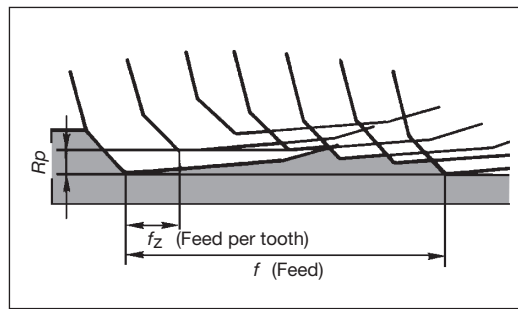

(2) Actual surface roughness

A facemill cutter in practice is composed of multiple point cutting edges and is prone to create uneven peaks, or an axial runout error (R_p) on cutting edges. One or two cutting edges being non-coplanar to the rest invariably create the dominant mark on a face-milled surface, producing periodic patterns corresponding to the feed per revolution f (ipr) superimposing on the feed per tooth f_z (ipt).

Improving surface roughness

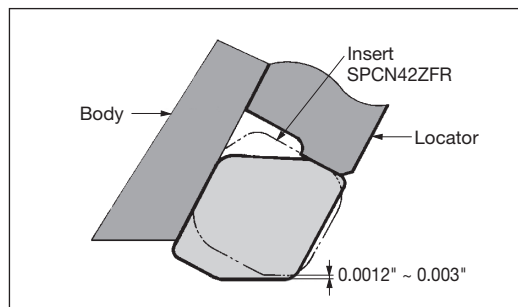

Face run out must be minimized and a low feed and high speed should be used. Also, in order to attain good finished surface at high efficiency, there are the following methods:

- (1) In case of ordinary mill
Use wiper insert as shown in the figure at left.
- (2) Use of super finish mill for finishing.
 - Use of combination mills with finishing insert such as TFD4400-A and TFP4000IA ($a_p < 0.039$ ").
 - Use of super finish mill for finishing such as NMS cutters and SFP4000 etc.

User's Guide - Technical Reference

Milling tools

Calculating power requirement

$$P_c = \frac{k_c \times a_p \times a_e \times v_f}{330}$$

(HP)

P_c : Net power requirement (HP)

k_c : Specific cutting force (KPI)

[Refer to the Table below]

a_p : Depth of cut (in)

a_e : Width of cut (in)

v_f : Feed speed (in/min)

Because practical power requirements depend on the type of mill (proportional to the true rake angle) and the motor efficiency of the machine used, the result calculated from the above formula should be considered as a rough guide.

Values of specific cutting force (k_c)

Workpiece material (JIS)	Tensile strength	Value of specific cutting force on feed per tooth k_c (N/mm ²)				
	MPa	0.004 (ipt)	0.006 (ipt)	0.008 (ipt)	0.012 (ipt)	0.016 (ipt)
SS400	75,420	312	290	276	254	239
S55C	111,679	286	270	261	255	235
SCM435	105,878	355	341	319	287	248
SKT4	(HB352)	294	292	263	244	231
SC450	75,420	393	367	350	325	307
FC250	(HB200)	241	210	191	167	149
Al (Si)	29,008	96	84	76	67	59
Brass	72,519	158	139	127	110	99

Values of cutting force (k_c)

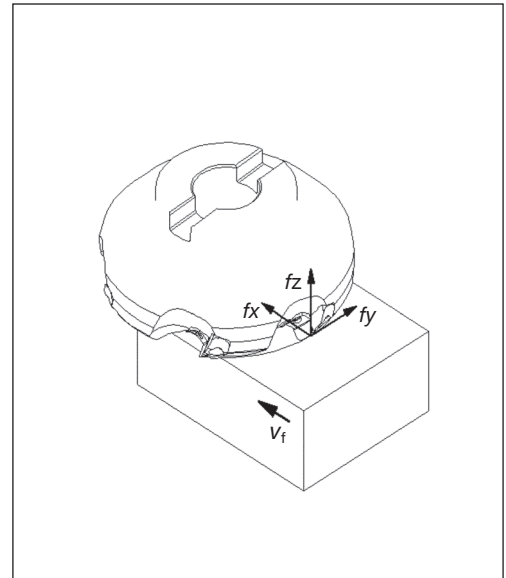
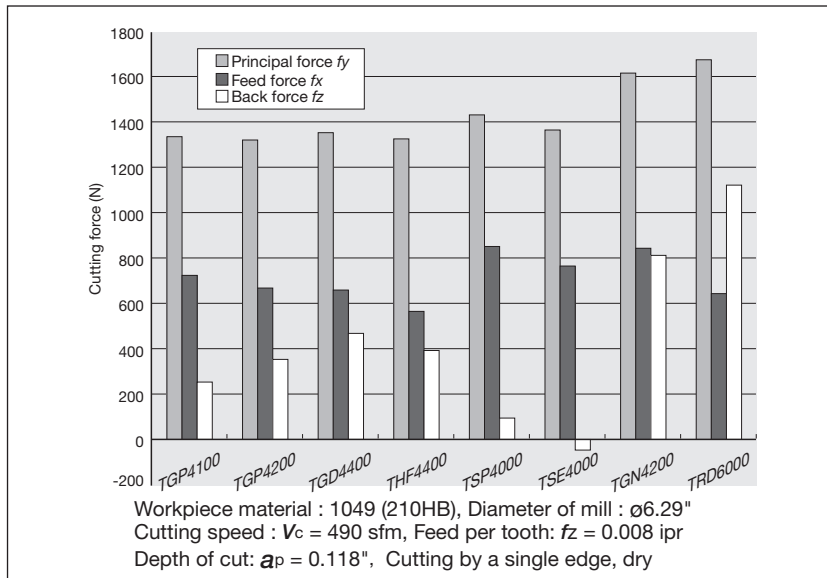

Conversion from cutting speed to number of revolutions

(unit : min⁻¹)

Cutter diameter DC, DCX (in)	Cutting speed : V_c (sfm)												
	33	98	164	328	410	492	656	984	1640	2625	3281	6562	13123
0.394	318	955	1,592	3,184	3,980	4,777	6,369	9,554	15,923	25,477	31,847	63,694	127,388
0.472	265	796	1,326	2,653	3,317	3,980	5,307	7,961	13,269	21,231	26,539	53,078	106,157
0.630	199	597	995	1,990	2,488	2,985	3,980	5,971	9,952	15,923	19,904	39,808	79,617
0.787	159	477	796	1,592	1,990	2,388	3,184	4,777	7,961	12,738	15,923	31,847	63,694
0.984	127	382	636	1,273	1,592	1,910	2,547	3,821	6,369	10,191	12,738	25,477	50,955
1.181	106	318	530	1,061	1,326	1,592	2,123	3,184	5,307	8,492	10,615	21,231	42,462
1.260	99	298	497	995	1,244	1,492	1,990	2,985	4,976	7,961	9,952	19,904	39,808
1.378	90	272	454	909	1,137	1,364	1,819	2,729	4,549	7,279	9,099	18,198	36,396
1.575	79	238	398	796	995	1,194	1,592	2,388	3,980	6,369	7,961	15,923	31,847
1.969	63	191	318	636	796	955	1,273	1,910	3,184	5,095	6,369	12,738	25,477
2.480	50	151	252	505	631	758	1,011	1,516	2,527	4,044	5,055	10,110	20,220
3.150	39	119	199	398	497	597	796	1,194	1,990	3,184	3,980	7,961	15,923
3.937	31	95	159	318	398	477	636	955	1,592	2,547	3,184	6,369	12,738
4.921	25	76	127	254	318	382	509	764	1,273	2,038	2,547	5,095	10,191
6.299	19	59	99	199	248	298	398	597	995	1,592	1,990	3,980	7,961
7.874	15	47	79	159	199	238	318	477	796	1,273	1,592	3,184	6,369
9.843	12	38	63	127	159	191	254	382	636	1,019	1,273	2,547	5,095
12.402	10	30	50	101	126	151	202	303	505	808	1,011	2,022	4,044

Note: In this table, the effects of centrifugal force on the rotating balance of the tool and the toolholder, flying risk of cutter parts, and limited value of toolholder destruction are not considered. Therefore, when using the tool at high speeds, be sure to observe the specified condition range.

User's Guide - Technical Reference

Milling tools

■ Trouble shooting in face milling

Trouble	Possible causes	Countermeasures
Rapid wear of cutting edge	• Improper insert grade selection (Insufficient wear resistance)	• Use a grade with high wear resistance P30 → P20
	• Excessive cutting speed	• Select cutting speed suited for Workpiece material and insert grade
	• Inadequate feed	• Use standard cutting condition in catalog as guide
Rapid chipping of cutting edge	• Improper Insert grade selection (Insufficient toughness)	• Use a grade with high fracture resistance P10 → P20
	• Cutting hard material and unfavorable surface condition	• Decrease cutting speed • Use cutter with strong cutting edge
	• Excessive feed	• Proper selection of feed conditions, using recommended cutting conditions in catalog as guide
	• Excessive pressure applied on cutting edge	• Proper selection of engaging angle
Fracturing	• Machining superalloys	• Use a negative-positive type cutter with large corner angle
	• Cracking due to thermal shock	• Select insert grade of stronger thermal shock resistance • Decrease cutting speed
	• Continuous use of excessively worn insert	• Shorten replacement standard time of insert
	• Cutting hard material	• Use cutter with stronger cutting edge • Use cutter of larger corner angle
	• Obstruction to chip flow • Recutting of chips after chip welding	• Use cutter with better chip expulsion • Select insert grades difficult for chips to adhere Cemented carbides → cermets, coated grades • Use air blow
Excessive chip welding or build-up on cutting edge	• Excessively slow cutting, too fine feed	• Select cutting speed and feed optimized for insert grade and Workpiece material
	• Cutting soft material such as aluminum, copper, mild steel	• Use cutter with large rake angle
	• Cutting stainless steel	• Coated grades (AH130, AH3135)
Rough finish	• Use of cutter with negative rake or too small rake angle	• Use cutter with large rake angle
	• Effect of built-up edge	• Increase cutting speed • Appropriate cutting depth (finish allowance) • Change insert grade For steels : P → coated → cermet For cast irons : K → coated
	• Effect of face cutting edge run out	• Proper installing of inserts • Use insert of high dimensional accuracy • Cleaning of insert pocket
	• Continuous use of excessively worn insert • Remarkable feed marks	• Shorten replacement standard time of insert • Feed per revolution to be set within flatland width • Use wiper insert type cutter such as T/EAW13 • Use cutter exclusively for finishing
Chattering	• Unstable clamping of workpiece	• Check clamping method of workpiece
	• Cutting of welded construction of thin steel plate	• Use cutter of large rake angle and small corner angle
	• Excessive cutting condition	• Re-examine allowable chip removal rate according to motor HP
	• Face milling of narrow width workpiece • Too many simultaneous cutting teeth engagement	• Use cutter of small cutter diameter and with many teeth • Reduce No. of teeth

User's Guide - Technical Reference

Solid Carbide Endmills

Part details

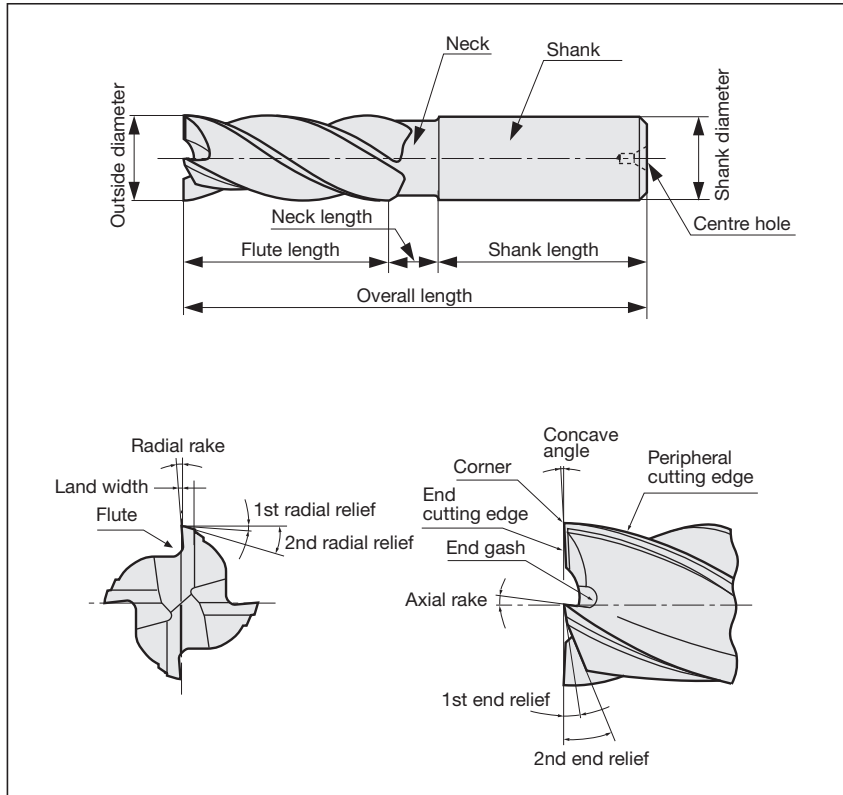

Types

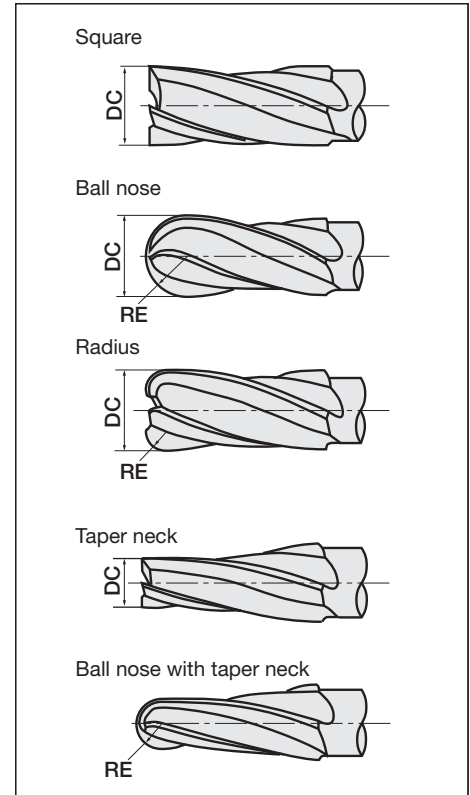

Cutting condition of Endmills

● Cutting speed

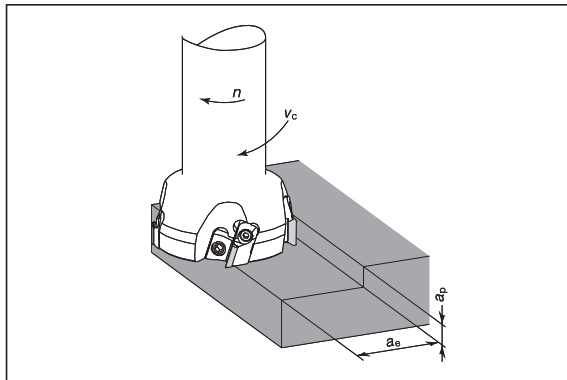

● Cutting speed (Calculated from number of revolutions)

$$SFM = \frac{RPM \times D}{3.82}$$

SFM: Cutting speed

D : Effective diameter (in) (DC)

RPM: Number of revolutions (min⁻¹)

● Number of revolution (Calculated from cutting speed)

$$RPM = \frac{SFM \times 3.82}{D}$$

● Feed speed and feed per tooth

$$V_f = f_z \times z \times n$$

V_f : Feed speed (in/min)

f_z : Feed per tooth (ipt)

z : No. of teeth of the endmills

n : Number of revolutions (min⁻¹)

() The notation in the brackets is the one used in the catalog (ISO compliant)

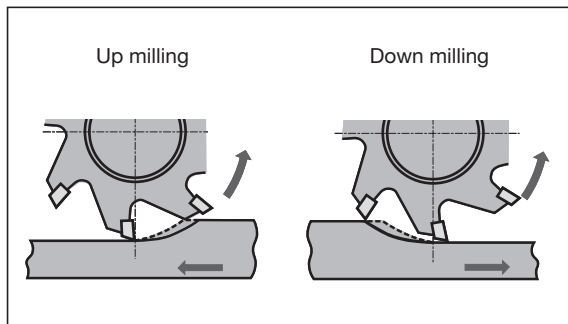

● Cutting

The necessary capacity of the machine is limited by the length of cut edge of the endmill.

● Up milling and down milling

Down milling generally produces better tool life and surface roughness.

In case of cast iron sand inclusion or welding surface, up milling is recommended.

User's Guide - Technical Reference

Grade

Insert

Toolholder

Ext. Toolholder

Int. Toolholder

Threading

Grooving

Milling Cutter

Miniature Tool

Endmill

Drilling Tool

Tooling System

User's Guide

Index



Solid Carbide Endmills

Regrinding procedures of solid carbide endmill

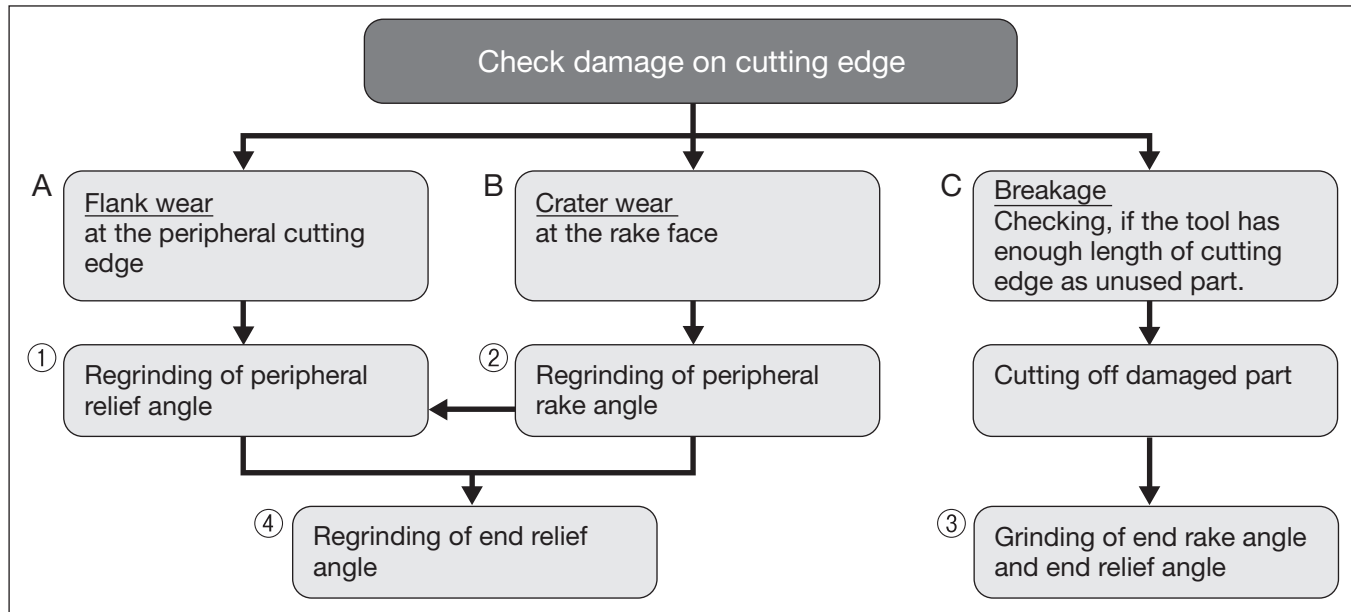

1. Regrinding of end relief angle

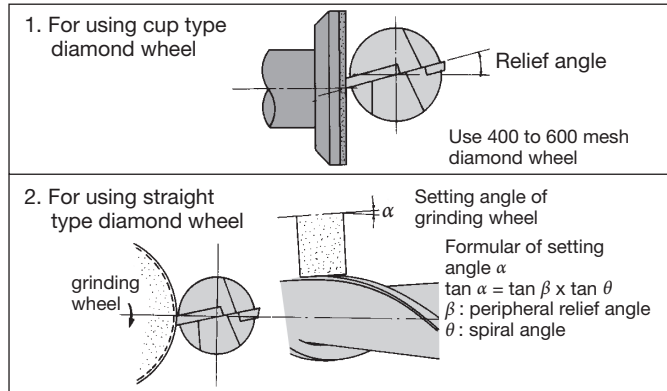

Notice of regrinding

- (1) If, after checking the damage of the cutting edge, the damage is as case "A" or "B" of the flow chart, the tool must be reground. Too much damage of the cutting edge requires too much stock removal and thus reduces tool life.
- (2) Please use diamond grinding wheel.
- (3) Peripheral relief angle must be ground between 18° and 10° . Relief angle of small diameter cutters for aluminum machining must be a large degree.
- (4) First check if "C" in flow chart can be adapted for the case of coated endmill or not. If procedure "C" can be adapted for regrinding, tool life after the grinding would be more improved than new one. The reason is remaining coated layer of cutting edge and shorter tool length will keep much higher rigidity of the tool than before regrinding.
- (5) Please check run out of peripheral cutting edge, face cutting edge, with Vee block after regrinding. The value of the run out must be controlled within $0.0004"$.

2. Regrinding of peripheral rake angle

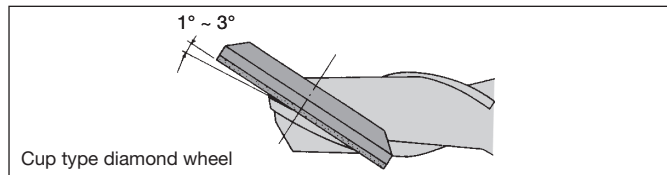

3. Regrinding of end rake angle (End gash)

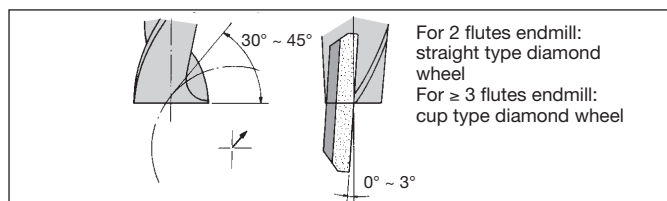

Notice for regrinding of ball nose endmill

- Regrinding of relief angle only is available. The dimension of nose radius will be smaller after grinding.
- Honing of cutting edge is necessary after regrinding.

4. Regrinding of end relief angle

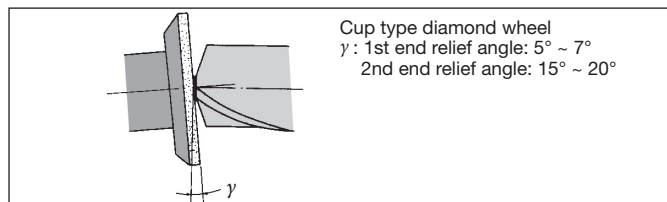

User's Guide - Technical Reference

Solid Carbide Endmills

■ Trouble shooting in Endmilling

Trouble	Possible causes	Countermeasures
Breakage	<ul style="list-style-type: none"> ● At the start of machining ● At the end of machining 	<ul style="list-style-type: none"> ● Reduce feed. ● Reduce tool overhang length. ● Exchange to short cutting edge tool.
	When usual machining	<ul style="list-style-type: none"> ● Reduce feed. ● Managing tool life → Exchange in shorter time. ● Replace chuck or collet to new one. ● Reduce tool overhang length. ● Make optimum honing on the edge. ● Reduce flutes. E.g. 4 flutes → 3flutes, or 2flutes. ● Use enough coolant. Change direction of supplying coolant.
	When change the direction of feed	<ul style="list-style-type: none"> ● Use the circular interpolation in NC machine. Stop feed shortly before changing. ● Lower feed around changing part. ● Replace chuck or collet to new one.
Fracture on cutting edge	Chipping on corner edge	<ul style="list-style-type: none"> ● Chamfer the corner with hand-stick grinder. ● Down cutting ⇒ Upward milling.
	Chipping on boundary part	<ul style="list-style-type: none"> ● Change cutting direction, Down cutting → Upward milling. ● Reduce cutting speed.
	Chipping on central part or all edges.	<ul style="list-style-type: none"> ● Make slight honing on the edge. Or make honing bigger. ● Change spindle revolution number. ● Increase cutting speed. ● If chattering, increase feed. ● Use coolant or air blast. ● Replace chuck or collet to new one. ● Decrease cutting speed.
	Fracture on cutting edge	<ul style="list-style-type: none"> ● Decrease feed. ● Reduce flutes. E.g. 4 flutes → 3 flutes, or 2 flutes. ● Make slight honing on the edge. Or make honing bigger. ● Replace chuck or collet to new one. <p>[For Solid carbide endmill]</p> <ul style="list-style-type: none"> ● Decrease cutting speed. ● Use enough coolant. Change direction of supplying coolant.
Large wear in short time		<ul style="list-style-type: none"> ● Decrease cutting speed. ● Change cutting direction, Upward milling → down cutting. ● Increase feed. ● Use coolant or air blast. ● In reground tool, grind flank face with FINER wheel.

(Continued on next page)

Solid Carbide Endmills

Trouble	Possible causes	Countermeasures
Poor surface finish	Bright, but Wavy surface	<ul style="list-style-type: none"> ● Reduce feed per tooth. ● Increase flutes; E.g. 2 flutes → 3flutes, or 4flutes.
	Small chips are welded on surface.	<ul style="list-style-type: none"> ● Increase cutting speed. ● Use coolant or air blast, or increase coolant. ● Make slight honing on the edge. ● Upward milling → Down cutting. ● Increase feed per tooth. Increase Depth of Cut.
	Scratches on the surface	<ul style="list-style-type: none"> ● Make slight honing on the edge. ● Use non-water soluble coolant. ● Down cutting → Upward milling.
	Poor surface by over cutting	<ul style="list-style-type: none"> ● Reduce depth of cut. ● Increase cutting speed. ● Reduce feed per tooth.
Poor accuracy	Finish size becomes a minus tendency.	<ul style="list-style-type: none"> ● Upward milling → Down cutting. ● Reduce depth of cut. ● Replace chuck or collet to new one. ● Reduce overhang length. ● Increase cutting speed.
	Poor straightness	<ul style="list-style-type: none"> ● Reduce depth of cut. ● Replace chuck or collet to new one. ● Reduce overhang length. ● Increase cutting speed. ● Increase flutes; E.g. 2 flutes → 4flutes. ● Reduce feed per tooth. ● Check the edge. Change tool, when needed.
Chattering		<ul style="list-style-type: none"> ● Increase feed per tooth. Reduce feed per tooth, when current feed is more than 0.003 ipt. ● Change cutting speed. ● Replace chuck or collet to new one. ● Reduce overhang length. ● Use 2 flutes tool in roughing. Use 4 flutes tool in finishing. ● Down cutting → Upward milling.



User's Guide - Technical Reference

Drilling Tools

Nomenclature for solid carbide drills

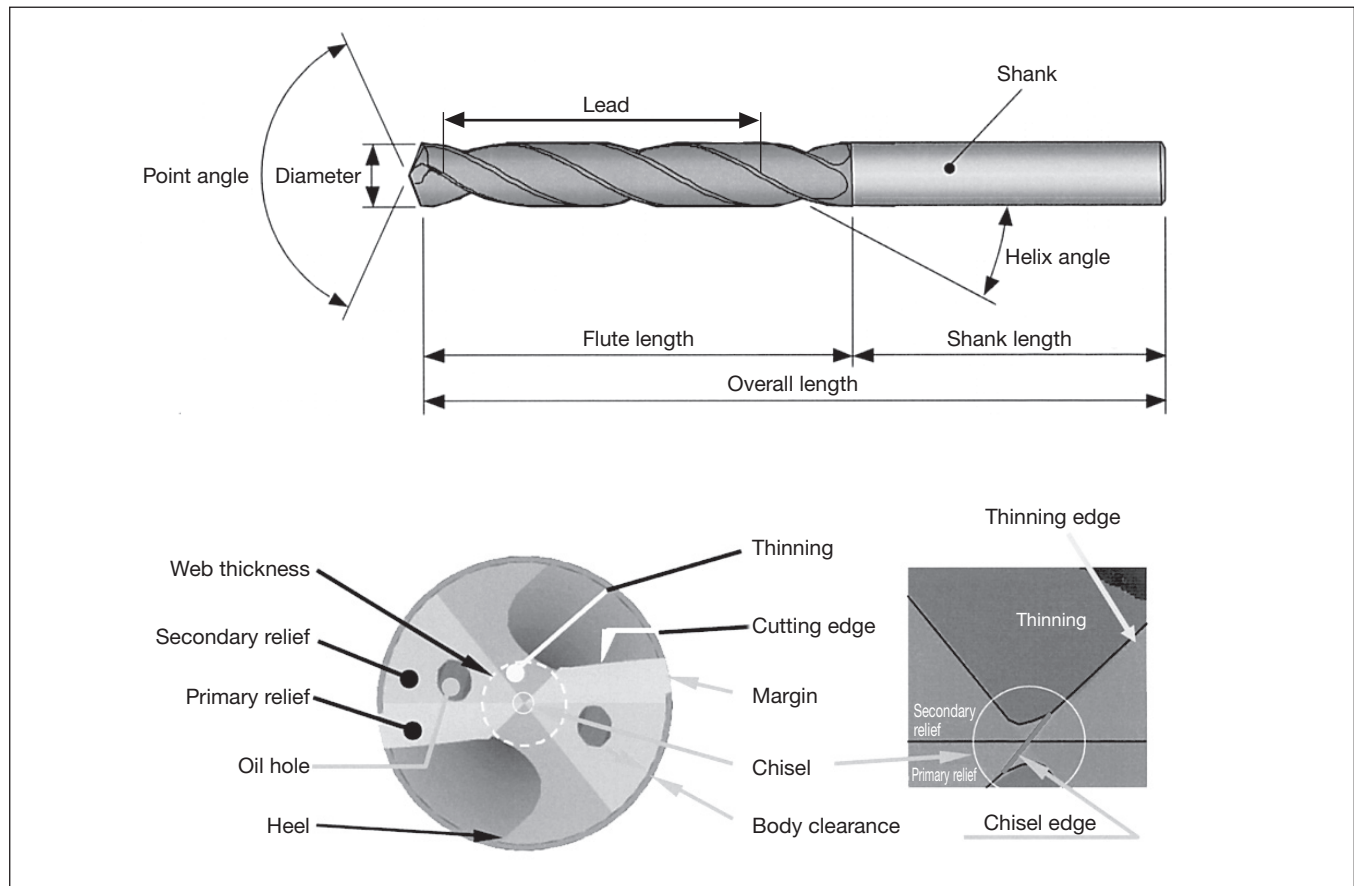

Cutting forces and power requirement

● Twist drill

Power requirement
$P_C = KD^2 n (0.647 + 17.29f) \times 10^{-6}$ (kW) 1kw = 1.34 HP

Thrust force
$T_C = 570KDf^{0.85}$ (N)

Torque
$M_C = \frac{KD^2 (0.630 + 16.84f)}{100}$ (N·m)

- P_C : Power requirement (kW)
 T_C : Thrust force (N)
 M_C : Torque (N·m)
 D : Drill diameter (mm) {DC}
 f : Feed (mm/rev)
 n : No. of revolutions (min⁻¹)
 K : Material constant... Refer to the Table at right
 () The notation in the brackets is the one used in the catalog (ISO compliant)

● Material constant compensating for power requirement and thrust force

Workpiece material	Tensile strength		Brinell hardness (HB)	Material constant (K)
	MPa(N/mm ²)	{Kgf/mm ² }		
Cast iron	210	21	177	1.00
Cast iron	280	28	198	1.39
Cast iron	350	35	224	1.88
Aluminum	250	25	100	1.01
Low carbon steel (JIS S20C)	550	55	160	2.22
Free cutting steel (JIS SUM32)	620	62	183	1.42
Manganese steel (JIS SMn438)	630	63	197	1.45
Nickel chromium steel (JIS SNC236)	690	69	174	2.02
4115 steel Cr0.5, Mo0.11, Mn0.8	630	63	167	1.62
Chromium molybdenum steel (JIS SCM430)	770	77	229	2.10
Chromium molybdenum steel (JIS SCM440)	940	94	269	2.41
Nickel chromium molybdenum steel (JIS SNCM420)	750	75	212	2.12
Nickel chromium molybdenum steel (JIS SNCM625)	1,400	140	390	3.44
Chromium vanadium steel				
Cr0.6, Mn0.6, V0.12	580	58	174	2.08
Cr0.8, Mn0.8, V0.1	800	80	255	2.22

User's Guide - Technical Reference

Drilling Tools

Guidelines for correct usage of carbide drills

● Holders for solid carbide drills:

A collet chuck holder is recommended for use with carbide drills. When using a milling chuck holder, a collet chuck with a straight shank or straight collet should be used.

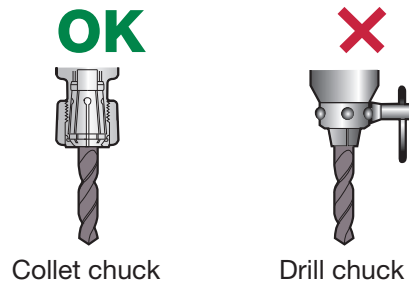

● Chucking drills:

Radial run out and lip height should be less than 0.001". If run out or lip height is larger (close to 0.002"), machining is possible. However, less accurate holes or short tool life may be a result.

Overhang length should be as short as possible.

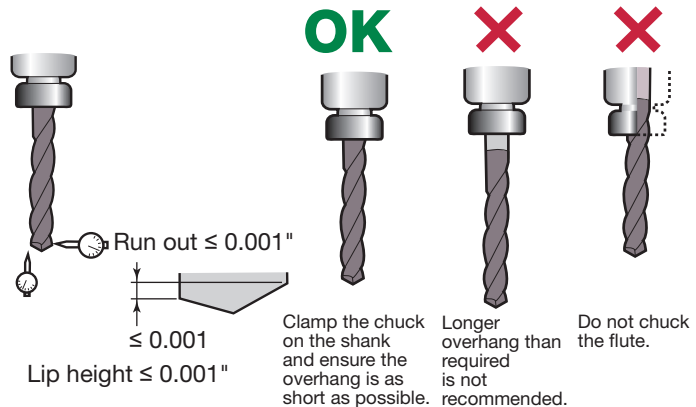

● Coolant Supply:

When using a drill without a coolant hole, such as the DSW-DE type, coolant should always be directed to the entrance of the hole. Maintaining this supplying is very important for stable drilling performance.

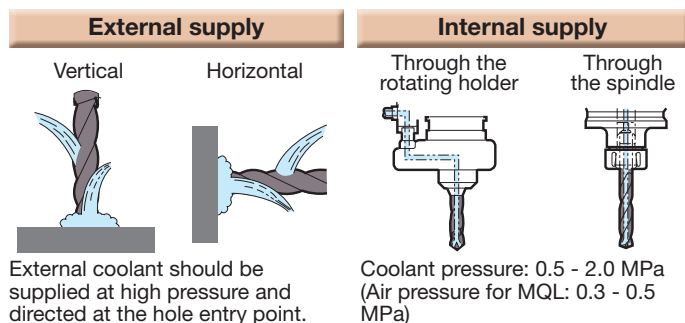

● Clamping workpieces:

As solid carbide drills have a higher thrust force, machining with low rigidity or inadequate support can cause fractures or breakages through vibration. It is important the workpiece is rigidly clamped and has adequate support.

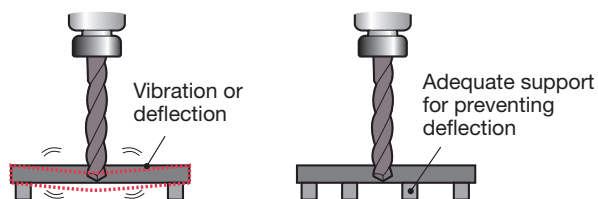

● The criteria of tool life:

- Corner wear width: equal to margin width
- Feed mark: 1 - 2 feed marks on the margin
- Spindle load increase: 30% higher than starting level
- Irregular situation: worse chip control, hole diameter change, worse surface finish, larger burrs, bigger sound.

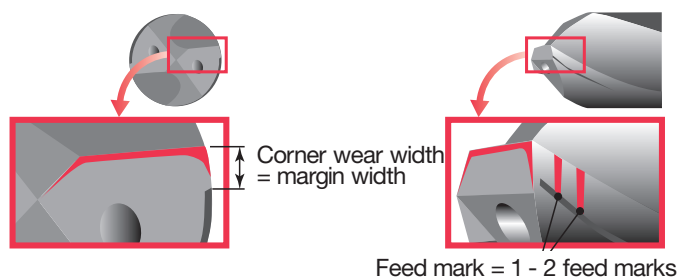

User's Guide - Technical Reference

Drilling Tools

■ Regrinding method [Applied to DSW]

Please refer to the following instructions prior to regrinding DSW type drills.

Before regrinding

Check the cutting edge for damage and wear. If any large fracture is found, remove with a silicon carbide wheel.

(1) Grinding the flank

- Use a 280 to 400 grit diamond cup type wheel of 3.937" - 7.874" in diameter.
- 1) Grind the relief surface so that primary relief angle (θ) of 2° can be formed as shown in Fig.1. After grinding the other side likewise, do sparkout grinding so that the difference of the lip height will be kept within 0.02 mm.
- 2) In the cases of DSW types: After grinding the primary relief angle (θ) 2°, without rotating the drill, grind the secondary relief surface so that the relief angle (θ) of 3° can be formed. In the same way as 2), take care to bring the ridge line formed between the primary and secondary relief surfaces to the drill center. (Values (θ) of 1° ~ 3° are shown in Table 1)

● Fig. 1 Grinding relief angle

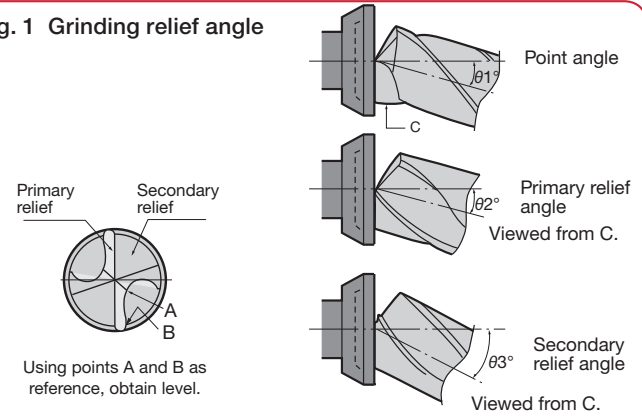

(2) Thinning

- Use a 280 ~ 400 grit diamond straight-type wheel of 3.937" - 7.874" in diameter.
- Conduct thinning in the same manner as cross thinning (X-type).
- Values of β_1 to β_3 written in the figures are given in the Table 2.

Table 1	θ_1 (Point angle)	θ_2 (Primary relief angle)	θ_3 (Secondary relief angle)
DSW	-20°	-6° ~ -12°	-23° ~ -27°

Table 2	β_1	β_2	β_3
DSW	147° ~ 153°	30° ~ 42°	95° ~ 110°

● Fig. 2

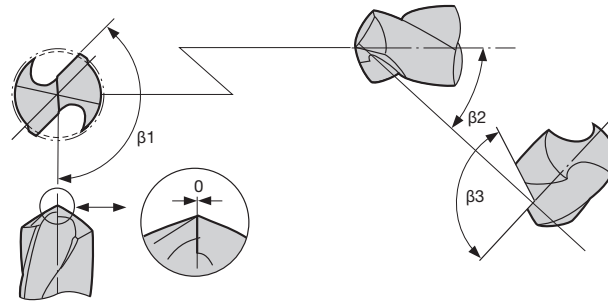

(3) Honing

- The honing angle θ and width H should be varied depending on the drill type, diameter, and work material. Recommended honing specifications are given in the Table below.
- Honing procedures (refer to Fig.3)
 - (1) Round the R portion shown in Fig.3 in large.
 - (2) Then, roughly hone the cutting edge lines by using an electro-deposited diamond file of around 170 grit.
 - (3) Carry out finish honing by using a diamond hand stick of 400 to 600 grit.
- The honing width should be changed depending on the drill diameter. For smaller side of diameters, the width should be in smaller side of values given in the Table.

● Angle honing

	~ $\phi 0.236$ "	$\phi 0.236$ " ~ $\phi 0.394$ "	$\phi 0.394$ " ~ $\phi 0.630$ "
θ	- 20°	- 20°	- 20°
H	0.001" ~ 0.002"	0.002" ~ 0.003"	0.003" ~ 0.004"

● R Honing

Dimensions (in)	R Honing R (in)
DC ≤ $\phi 0.236$ "	0.0008" ~ 0.0016"
$\phi 0.236$ " < DC ≤ $\phi 0.630$ "	0.0012" ~ 0.0020"

● Fig.3

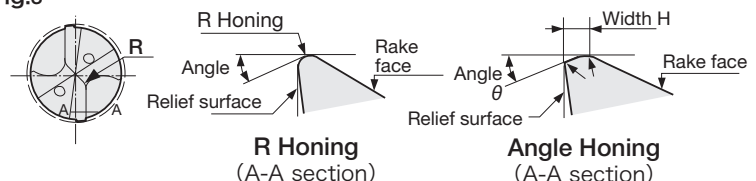

Notes:

- For more details on regrinding, consult the nearest Tungaloy sales office.

After regrinding, check the following before use.

- The difference of the lip height is kept within 0.0008".
- Any damaged portion on the cutting edges is not left.
- Cutting edges are properly honed.
- Any grinding burr is not left.

Drilling Tools



Technical guidelines

When to change drill heads (Criteria for the end of tool life)

The criteria to identify the time for tool change are as follows:

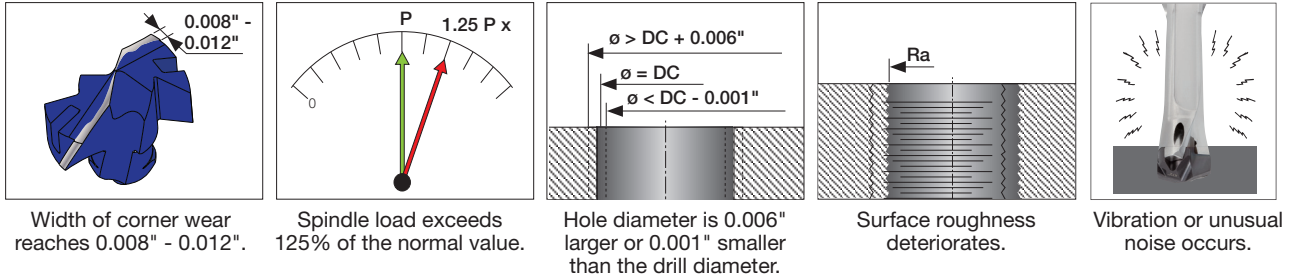

How to clamp the drill head

① Clean and lubricate the pocket.

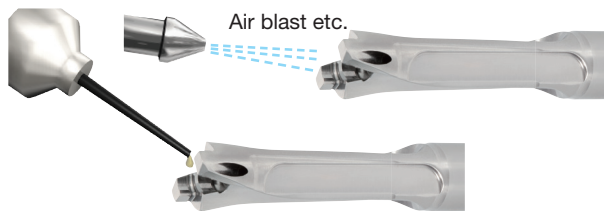

② Set the drill head into the pocket.



③ Set the clamping key on the drill head

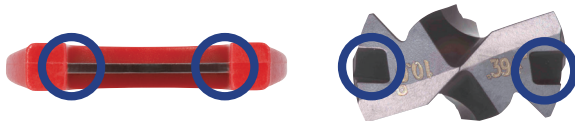

④ Clamp



Coolant supply

Internal coolant supply is recommended.



The required coolant flow and pressure

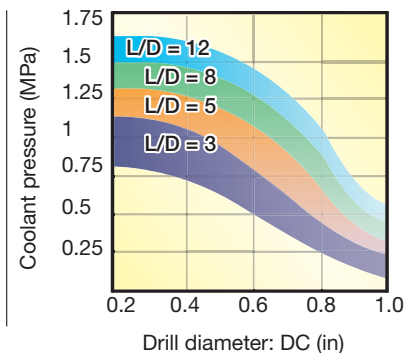
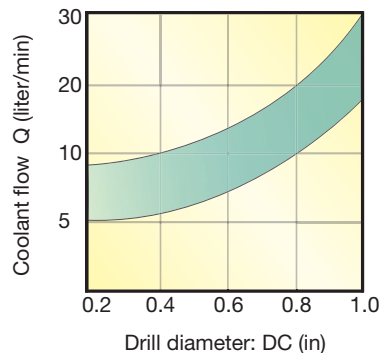

User's Guide - Technical Reference

Drilling Tools

● Applications that are not recommended

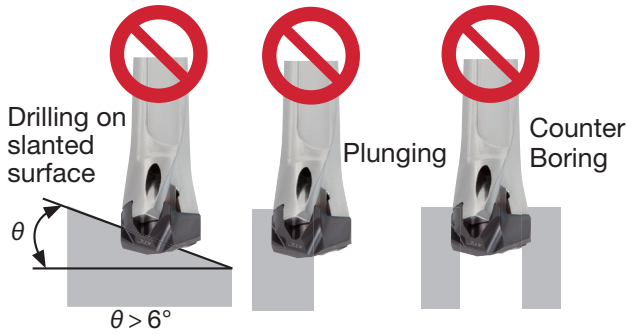

● Run-out

Run-out should be less than 0.001".

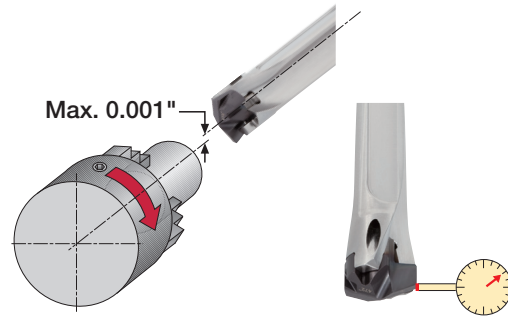

Ideal : $\leq 0.001''$
 Acceptable : $\leq 0.002''$
 Not acceptable : $> 0.002''$

■ Instruction of clamping head

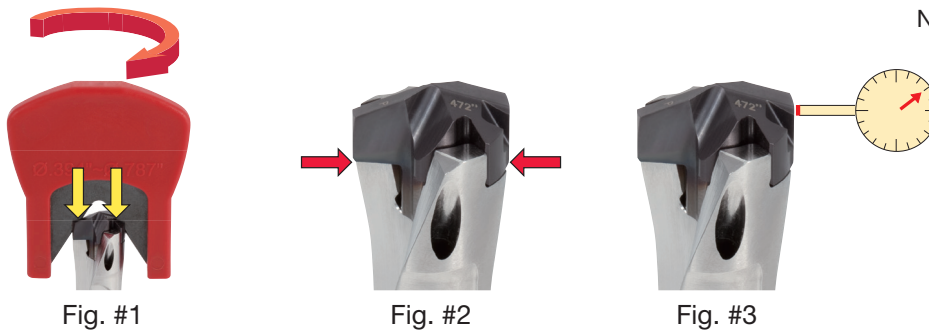

Procedure

- ① Clean the clamping areas on the drill body and the head with an air blast, lubricate them, and put the drill head in the pocket.
- ② Set the clamping key in the groove on the drill head. Push the head toward the pocket with equal torque on the right and the left sides, and turn the clamping key to clamp the head completely. (Fig. #1)
- ③ Be sure that there is no gap between the bottom of the head and the drill body. A shim in the thickness of around 0.004" is useful to check the gap. (Fig. #2)
- ④ If there is a gap thicker than 0.004", unclamp the head and return to procedure No. ①
- ⑤ Check the run-out at the margin of the drill head. Run-out must be less than 0.002". (Fig. #3) (Recommended value: less than 0.001")
 If the run-out exceeds 0.002", unclamp the head and return to procedure No. ①.

Note #1: If the clamping torque is not equally applied on the right and the left sides of the drill head, there may be a gap between the head and the body, which increases the run-out of the head.

Note #2: Low accuracy in holding the drill body may affect the run-out. If the run-out is large, check the accuracy in holding the drill body.

■ KEY FOR MEASURING HEAD RELEASE TORQUE

The release torque in unclamping a head is measured with a torque driver to determine the body's tool life. Please refer to the below for the standard release torque value which indicates the end of tool life (The value less than the standard should be judged as the end of tool life).

Dedicated key designation :
 KHS-TID10-19.99



*Can be connected with a commercially available torque driver.



Head designation	Release torque value to indicate tool replacement		
	(N·m)	(lbs·ft)	(cN·M)
DMP100-109	0.2	0.15	20
DMP110-119	0.2	0.15	20
DMP120-129	0.25	0.18	25
DMP130-139	0.25	0.18	25
DMP140-149	0.3	0.22	30
DMP150-159	0.3	0.22	30
DMP160-169	0.35	0.26	35
DMP170-179	0.35	0.26	35
DMP180-189	0.4	0.3	40
DMP190-199	0.4	0.3	40

(Unit: mm)

User's Guide - Technical Reference

Drilling Tools

■ Cutting edge failure of solid carbide drills

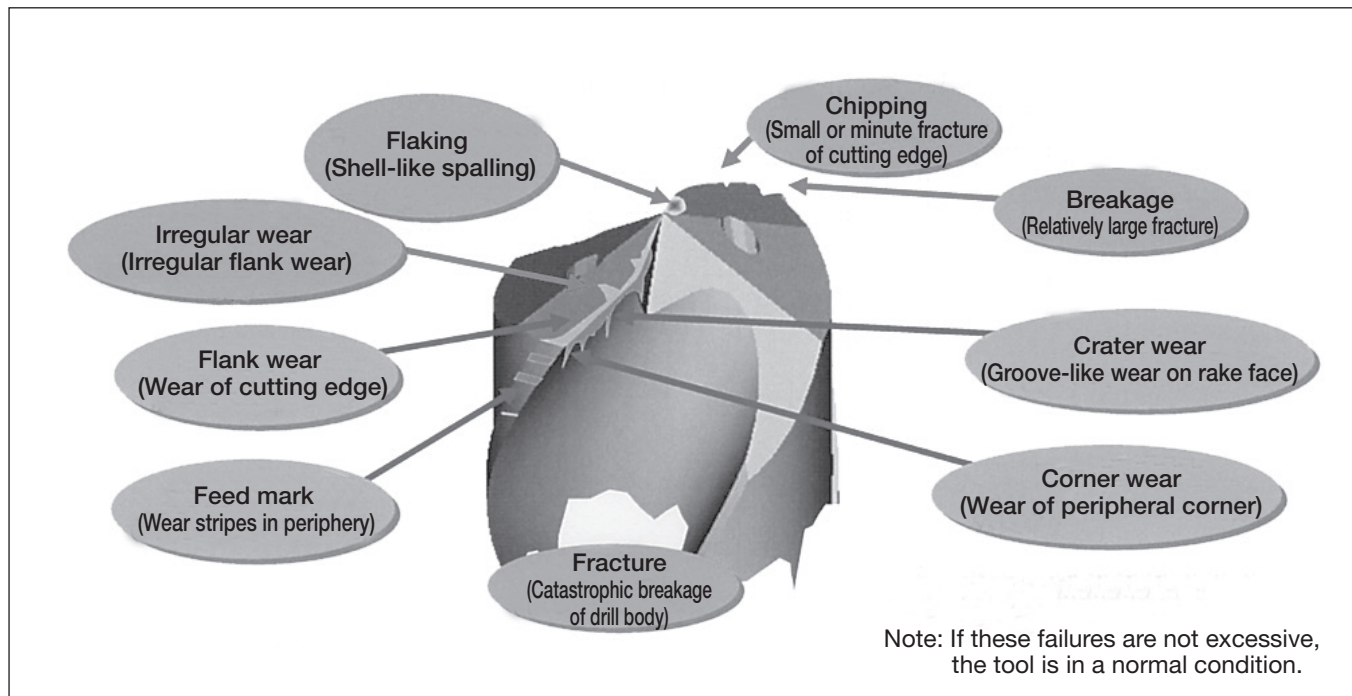

■ Change of chip shapes in drilling

● Change of chip shapes relating to cutting conditions

Photographs below show the change of chip shapes relating to change of the feed and the cutting speed. These chip shapes are all well controlled in a proper condition range.

When the speed and feed are low, the chip shows whitish color and the tail of the chip tends to lengthen gradually. In contrast, as the speed or the feed increases, the chip tends to increase in brightness and becomes a compact shape with a short tail. These changes in the shape depend on the cutting temperature. As the temperature increases, chips tend to be broken.

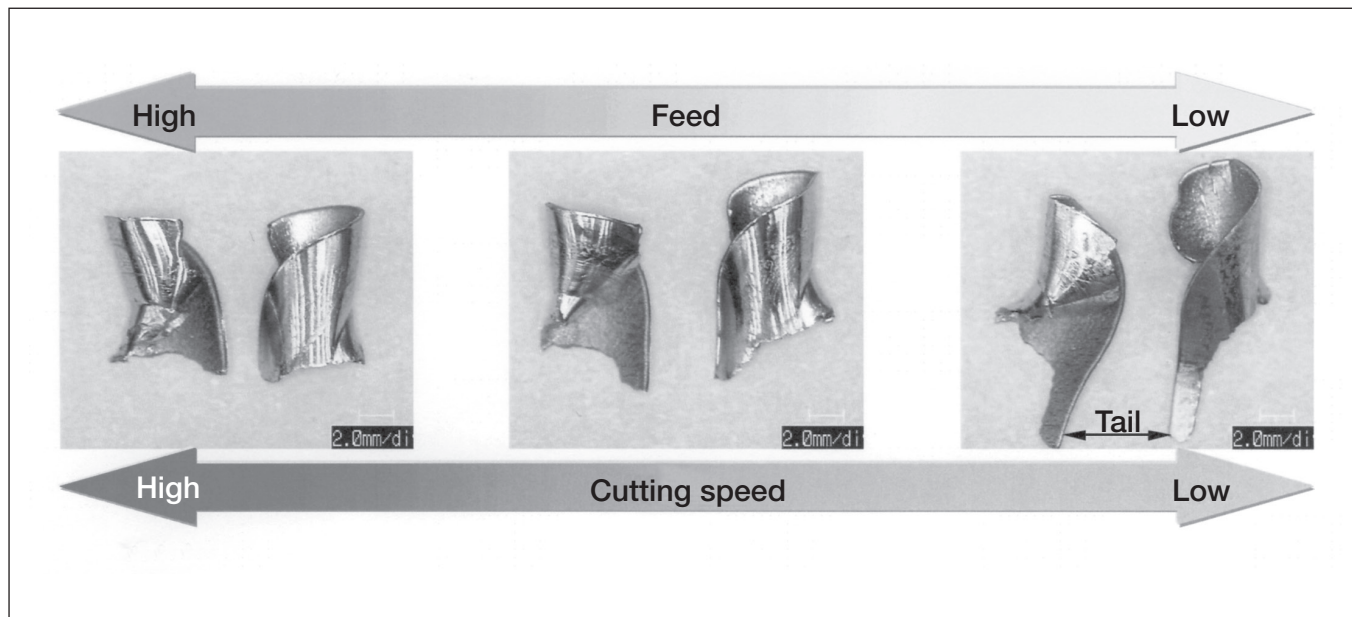

User's Guide - Technical Reference

Drilling Tools

Troubleshooting for solid carbide drills

Problem		Cause	Countermeasure	
Abnormal wear	Relief surface	Inappropriate cutting speed	<ul style="list-style-type: none"> •Increase the cutting speed by 10% within standard conditions if abnormal wear is around center. •Lower the cutting speed by 10% within standard conditions if abnormal wear is on the periphery. 	
		Inappropriate cutting fluid	<ul style="list-style-type: none"> •Check the filter. •Use the cutting fluid superior in lubricity. (Increase the dilution rate) 	
	Margin	Inappropriate cutting speed	<ul style="list-style-type: none"> •Lower the cutting speed by 10%. 	
		Regrinding timing, insufficient reground amount	<ul style="list-style-type: none"> •Shorten the regrinding timing. 	
		Insufficient rigidity of the machine and workpiece	<ul style="list-style-type: none"> •Change the clamp method to the one with rigidity. 	
		Insufficient drill rigidity	<ul style="list-style-type: none"> •Use smallest possible overhang. 	
Inappropriate cutting fluid	<ul style="list-style-type: none"> •Check the filter. •Use the cutting fluid superior in lubricity. (increase the dilution rate) 			
Intermittent cutting when entering	<ul style="list-style-type: none"> •Avoid interruption at entry and exit. •Lower the feed by about 50% during entering into and leaving from the workpiece. 			
Chipping and fracture	Chisel section (center of drill cutting edge)	Insufficient rigidity of the drill	<ul style="list-style-type: none"> •Reduce the drill overhang as much as possible. •Increase the feed at entry when the low speed feed is selected in standard cutting condition range. •Use a bushing or a center drill. 	
		Insufficient rigidity of the machine and workpiece	<ul style="list-style-type: none"> •Change the clamp method to the one with rigidity. 	
		Inappropriate entry into the workpiece	<ul style="list-style-type: none"> •Avoid interruption at entry into the workpiece. •Lower the feed by 10% at entry. 	
		High workpiece hardness	<ul style="list-style-type: none"> •Lower the feed by 10%. 	
	Peripheral cutting edge	Inappropriate honing	<ul style="list-style-type: none"> •Check if honing has been made to the center of cutting edge. 	
		Insufficient drill rigidity	Insufficient drill rigidity	<ul style="list-style-type: none"> •Lower the cutting speed by 10%. •Increase the feed at entry when the low speed feed is selected in standard cutting condition range.
			Inappropriate drill mounting accuracy	<ul style="list-style-type: none"> •Check the run out accuracy after drill installation. (0.0012" or less)
			Insufficient machinery and workpiece rigidity	<ul style="list-style-type: none"> •Change the clamp method to the one with rigidity. •Lower the feed during entering and leaving from the workpiece.
	Margin	Inappropriate honing	<ul style="list-style-type: none"> •Check if honing has been made to the cutting edge periphery. 	
		Insufficient machine and workpiece rigidity	<ul style="list-style-type: none"> •Change the clamp method to the one with rigidity. 	
		Insufficient drill rigidity	<ul style="list-style-type: none"> •Use smallest possible overhang. •Use a bushing or center drill. 	
		Regrinding timing and insufficient amount of reground stock	<ul style="list-style-type: none"> •Shorten the regrinding timing. 	
Intermittent cutting when entering or exiting the cut	Intermittent cutting when entering or exiting the cut	<ul style="list-style-type: none"> •Avoid interruption at entry and exit. •Lower the feed by about 50% during entering into and leaving from the workpiece. 		
	Tendency to cause chipping or develop abnormal wear	<ul style="list-style-type: none"> •Check the failure mode condition before breakage and find out the wear and chip countermeasures. 		
	Chip packing in the drill flutes	<ul style="list-style-type: none"> •Review the cutting conditions. •For internal coolant supply, raise the supply pressure of cutting fluid. •Use peck feed for deep holes. 		
Breakage	Insufficient machine output	<ul style="list-style-type: none"> •Review the cutting conditions. •Use the machine with high power. 		
	Insufficient hole accuracy	Insufficient rigidity of the machinery and workpiece	<ul style="list-style-type: none"> •Change to the clamp method with rigidity 	
		Inappropriate drill installation accuracy	<ul style="list-style-type: none"> •Check the run out accuracy of drill mounting. (0.0012" or less) 	
Chip packing in the flutes.		<ul style="list-style-type: none"> •Review the cutting conditions. •Raise the cutting oil supply pressure. •Use peck-feed for deep holes. 		
Prolonged chips	Inappropriate edge sharpening accuracy	<ul style="list-style-type: none"> •Check the edge shape accuracy. 		
	Inappropriate cutting conditions	<ul style="list-style-type: none"> •Increase the feed by 10% within standard conditions. 		
	Inappropriate honing	<ul style="list-style-type: none"> •Provide the appropriate honing. 		
Cutting edge with chipping or breakage	<ul style="list-style-type: none"> •Lower the cutting speed by 10%. 			

User's Guide - Technical Reference

Drilling Tools

Nomenclature for Indexable drill

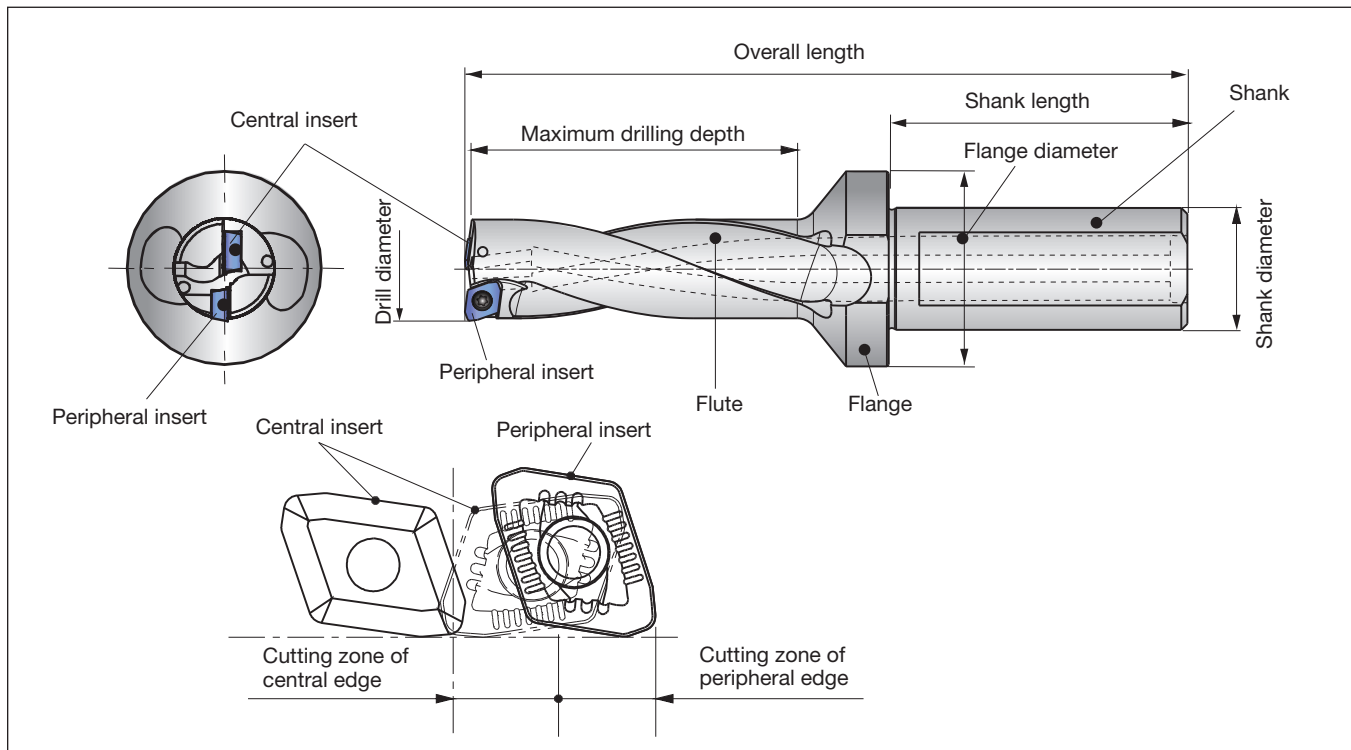

Calculation formulas for Indexable drill

●Cutting speed

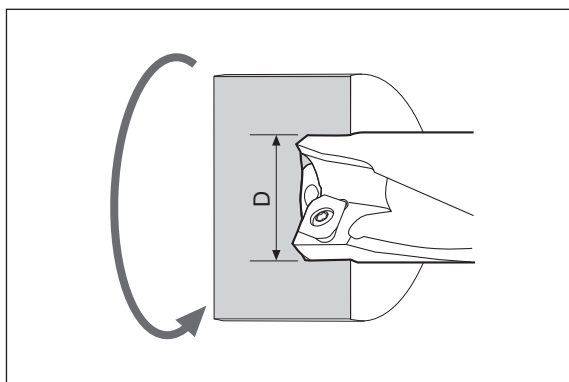
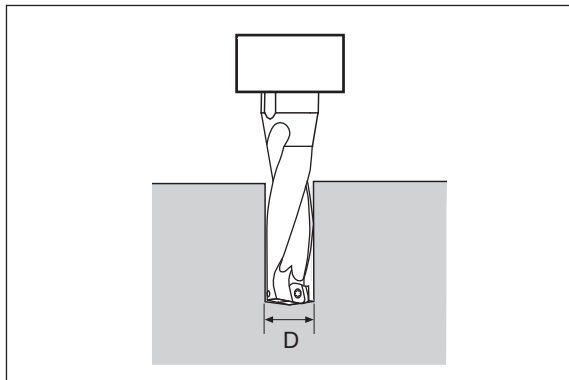

●When calculating cutting speed from number of revolutions: (Drilling formulas)

$$SFM = \frac{RPM \times D}{3.82}$$

SFM: Cutting speed
D : Drill diameter (in) (DC)
RPM: Number of revolution (min⁻¹)

●When calculating required number of revolutions from cutting speed: (Drilling formulas)

$$RPM = \frac{SFM \times 3.82}{D}$$

●When calculating cutting speed from number of revolutions: (Where the workpiece rotates.)

$$v_c = \frac{\pi \times D \times n}{1000}$$

v_c : Cutting speed (sfm)
D : Drilling diameter (in) (DC)
 n : Number of revolution (min⁻¹)
 $\pi \approx 3.14$

●When calculating required number of revolutions from cutting speed: (Where the workpiece rotates.)

$$n = \frac{1000 \times v_c}{\pi \times D}$$

(min⁻¹)

●Calculation of feed speed

$$v_f = f \times n$$

(in/min)

v_f : Feed speed (in/min)
 f : Feed (ipr)
 n : Number of revolution (min⁻¹)

() The notation in the brackets is the one used in the catalog (ISO compliant)

User's Guide - Technical Reference

Drilling Tools

Chip shapes

● Chip shape produced with central insert

- A conical coil shape whose apex point coincides with the rotating center of the drill is the basic shape. The chips are broken into small sections with increases in feed. However, excessively high feed causes the chip to increase in thickness and develops vibration which disturbs stable machining.
- In TDX drills, ○ marked chips shown below are the most preferable shapes. This type of chip is broken into adequate lengths by centrifugal forces when used in tool-rotating condition. On the other hand, when used in work-rotating condition such as on a lathe, a continuously long chip is often produced without entangling.

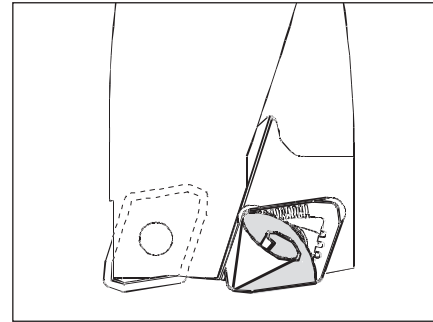

● Relation between chip shapes and feeds (In the case of central insert)

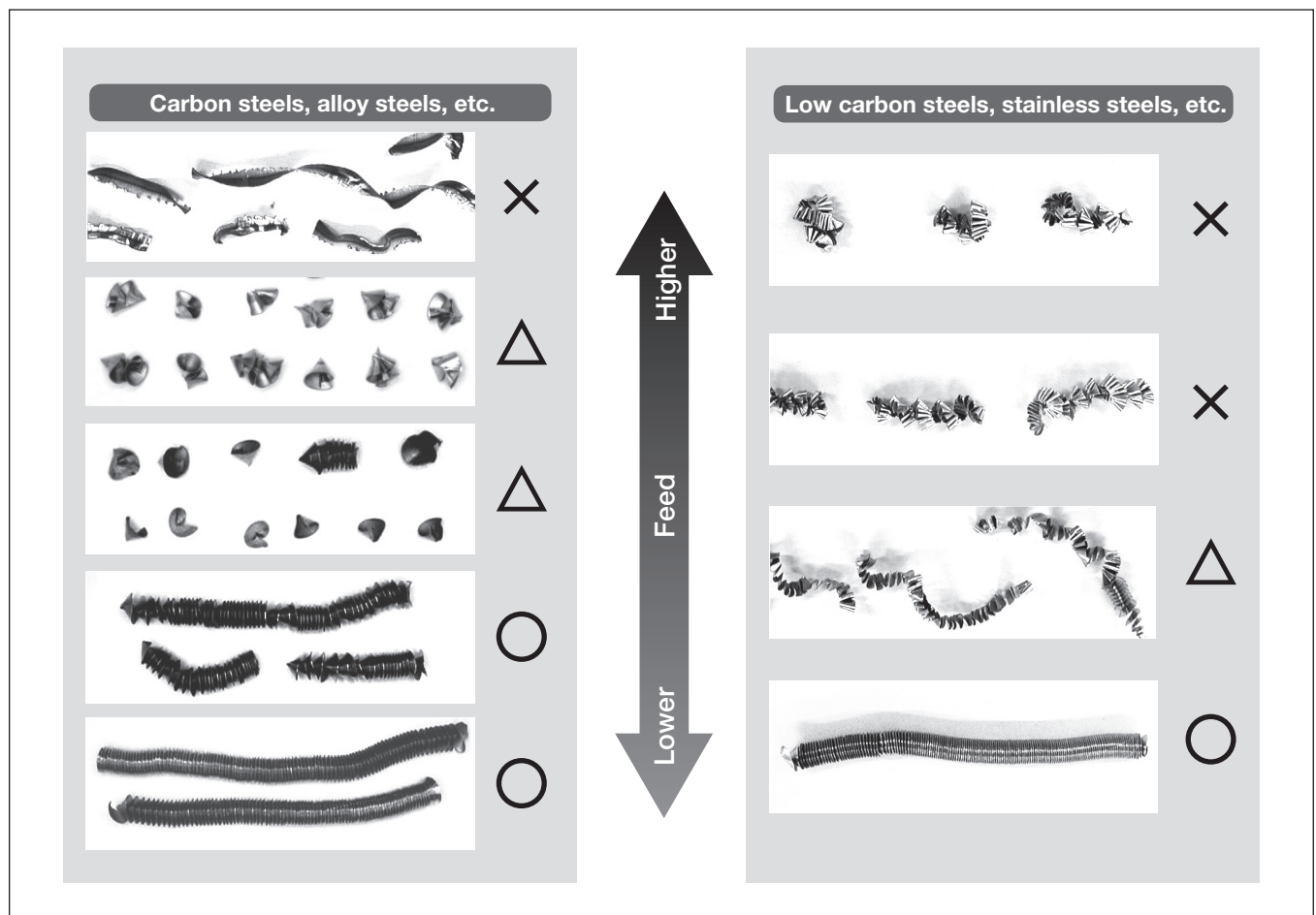

● Example of chip shape in work-rotating applications (In the case of central insert)

($\phi 1.024''$, 1045, $V_c = 330$ sfm, $f = 0.004$ ipr)

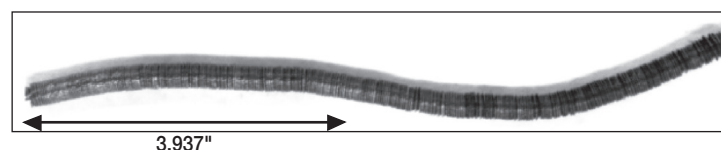

User's Guide - Technical Reference

Drilling Tools

● Chip shape produced with peripheral insert

- Chip problems such as entangling are mainly caused by chips produced with the peripheral insert. These problems are dependent on the types of Workpiece material and the cutting conditions.
- As shown below, when the feed is extremely low, the chips jump over the chipbreaker groove and the continuously long chips may wrap around the drill body.
- When the feed is too high, the chips increase in thickness and can not be curled.
- Therefore, it is important to select proper cutting conditions to suit the machining so that well controlled chips will be formed.

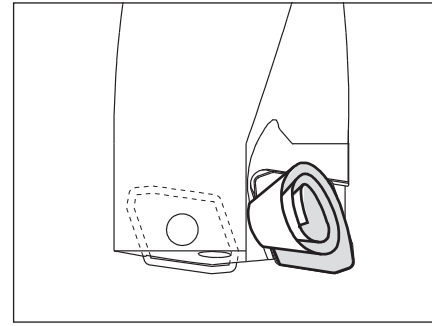

Medium to high carbon steels, alloy steels, etc.

As shown below, several turns of coil are an ideal shape.
As the feed increases, the curl radius and the number of turns tend to decrease.

● Typical chip shapes of general steels

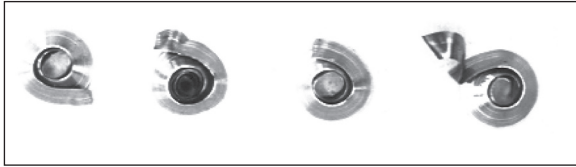

● Variation of chip shapes relating to feeds

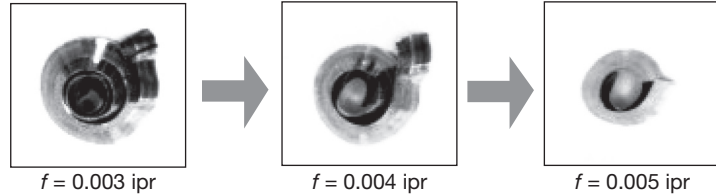

Stainless steels, low-carbon steels, low-alloy steels, etc.

- When machining long-chip materials such as stainless steels and mild steels, the wrong selection of cutting conditions results in chip entangling and tool breakage at worst. Therefore, cutting conditions should be carefully selected.
- “C” shaped, continuous coils of several to ten turns having adequately divided lengths are the ideal shape.

● Ideal chip shapes

	Stainless steel (JIS SUS 304) ($\phi 0.866''$, $V_c = 330$ sfm, $f = 0.004$ ipr)	Mild steel (JIS SS400) ($\phi 0.866''$, $V_c = 530$ sfm, $f = 0.003$ ipr)
DS chipbreaker		
DJ chipbreaker		

For machining stainless steels or low carbon steels, DS chipbreaker is recommended.
When using a TDX drill in tool-rotating condition, DS chipbreaker produces compact chips and allows more stable machining than DJ chipbreaker. When using it in work-rotating condition, DS chipbreaker provides outstanding affect on chip control.

User's Guide - Technical Reference

Drilling Tools

● Chip shapes which tend to entangle and remedies against them

① Apple-peel-like chips

These chips are often produced in machining mild steels or low-carbon steels at low-speeds and low-feeds.

Remedies

Increase the cutting speed in stages by 20% within the range of standard cutting conditions. If there is no effect, increase the feed by about 10% as the cutting speed is raised by 20%.

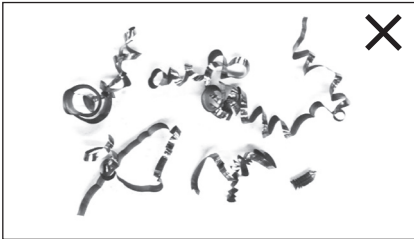

Apple-peel-like chips (Without curling)

② Short-lead chips

These chips are often produced in machining stainless steels at low-feeds and tend to entangle to the tool in spite of short length.

Remedies

Increase the feed by about 10%. If there is no effect, increase the cutting speed in stages by 10% within the range of standard cutting conditions.

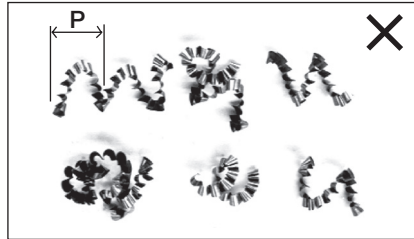

Continuously curled "C" shape chips with short lead (P).

③ Very long chips

Often produced in machining mild steels or low-carbon steels under improper cutting conditions.

Remedies

Increase the cutting speed in stages by 20% within the range of standard cutting conditions. If there is no effect, decrease the feed by about 10% as the cutting speed is raised by 20%.



Continuously coiled long chips

■ Cutting forces

The charts below show a guideline for cutting forces. Use TDX drills on a machine with ample power and sufficient rigidity.

● Guidelines for cutting forces

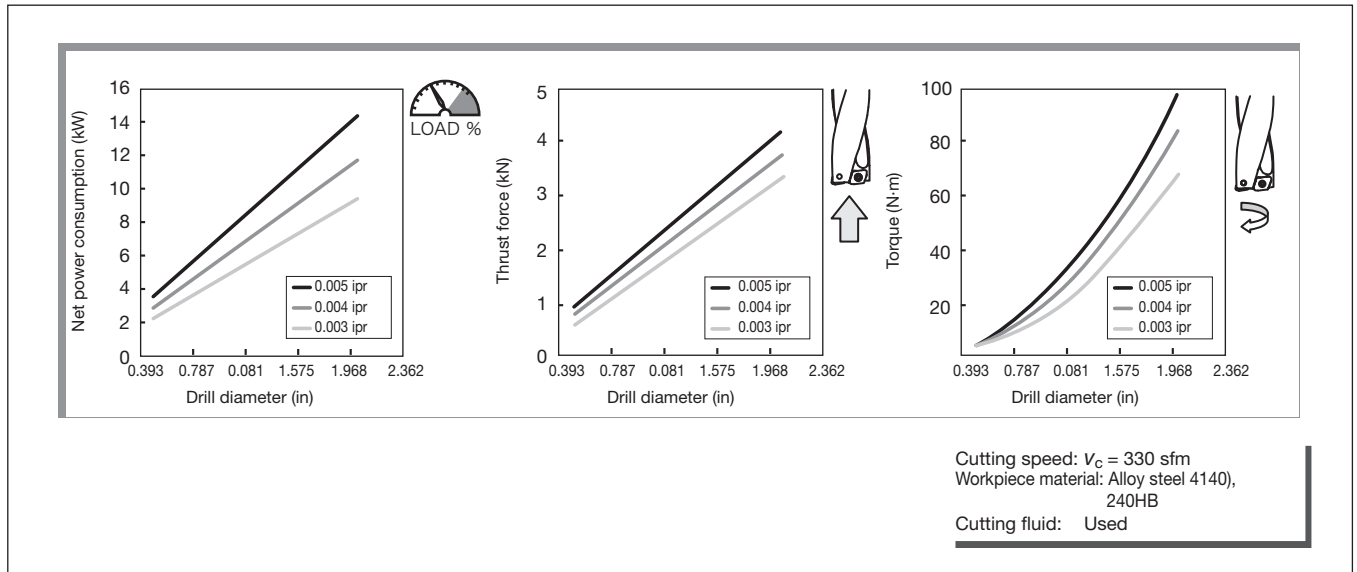

User's Guide - Technical Reference

Drilling Tools

Troubleshooting for indexable drills

Problem		Cause	Countermeasure		
Abnormal wear	Central cutting edge	Relief surface	Inappropriate cutting conditions		
	Peripheral cutting edge	Relief surface	Inappropriate cutting conditions		
	Common	Relief surface	Varieties and supply of cutting fluid	<ul style="list-style-type: none"> ● Increase the cutting speed by 10% within standard conditions. ● Lower the feed by 10%. 	
			Vibration in drilling	<ul style="list-style-type: none"> ● Increase the cutting speed by 10% within standard conditions. ● When the feed is extremely low or high, set up it within standard conditions. 	
		Crater	Unsuitable for selection of grade	<ul style="list-style-type: none"> ● Confirm that the cutting fluid flow is higher than 7 liter/min. ● The concentration of cutting fluid must be higher than 5%. ● Use the cutting fluid superior in lubricity. ● Change to internal cutting fluid supply from external one. 	
			Looseness of screws	<ul style="list-style-type: none"> ● Change to the machine with higher torque. ● Change to the clamp method with rigidity. ● Change the drill setting method. 	
	Chipbreaker	Cutting heat is too high	<ul style="list-style-type: none"> ● Change the grade to high wear resistant. ● Tighten the screw. 		
		Excessive chip welding	<ul style="list-style-type: none"> ● Change to internal cutting fluid supply from external one. ● Increase the supply rate of the cutting fluid. (Higher than 10 liter/min.) ● Lower the feed by 20% within standard conditions. ● Lower the cutting speed by 20% within standard conditions. 		
	Chipping and fracture	Central cutting edge	Chip packing	<ul style="list-style-type: none"> ● Lower the feed by 20% within standard conditions. ● Lower the cutting speed by 20% within standard conditions. 	
			The rotation center of drill	Misalignment for workpiece rotation	<ul style="list-style-type: none"> ● Increase the cutting speed by 20% and lower the feed by 20% within standard conditions. ● Raise the fluid pressure (for higher than 1.5 MPa).
				Large offset	<ul style="list-style-type: none"> ● Set the misalignment to 0 ~ 0.008".
				No flatness of machined surface	<ul style="list-style-type: none"> ● Check the manual and use the tool in the allowable offset range.
High feed				<ul style="list-style-type: none"> ● Flatten the entry surface in pre-machining. ● Set the feed for lower than 0.002 ipr in rough surface area. 	
Using a chipping corner		<ul style="list-style-type: none"> ● Lower the feed by 20 ~ 50% within standard conditions. 			
Peripheral cutting edge		Peripheral corner area	Using inserts in excess of tool-life	<ul style="list-style-type: none"> ● Confirm the corner when exchanging inserts. 	
			No flatness of machined surface	<ul style="list-style-type: none"> ● Exchange the corner or the insert before the nose wear reaches 0.012". 	
			The existence of interrupted area	<ul style="list-style-type: none"> ● Flatten the entry surface in pre-machining. ● Set the feed for lower than 0.002 ipr at rough surface area. 	
			Using a chipped corner	<ul style="list-style-type: none"> ● Set the feed for lower than 0.002 ipr in interrupted area. ● Confirm the corner when exchanging inserts. 	
Common		The unused corner area and cutting edge	High hardness of workpiece	<ul style="list-style-type: none"> ● Increase the cutting speed by 20% and lower the feed by 20% within standard conditions. ● Raise the fluid pressure (for higher than 1.5 MPa). 	
			Chip packing	<ul style="list-style-type: none"> ● Lower the feed by 20% within standard conditions. 	
	Machinery impact		<ul style="list-style-type: none"> ● Change to continuous feed in case of pick feeding. 		
	Contact boundary	Using inserts in excess of tool-life	<ul style="list-style-type: none"> ● Exchange the corner or the insert before the nose wear reaches 0.012". 		
		Vibration in drilling	<ul style="list-style-type: none"> ● Change to the machine with higher rigidity. ● Change to the clamp method with rigidity. ● Change the drill setting method. 		
	Flaking	High hardness of workpiece	<ul style="list-style-type: none"> ● Change to the machine with higher rigidity. ● Change to the clamp method with rigidity. ● Change the drill setting method. 		
		Thermal impact	<ul style="list-style-type: none"> ● Set the feed for lower than 0.002 ipr. 		
	Common	Unsuitable for selection of grade	<ul style="list-style-type: none"> ● Change to internal cutting fluid supply from external one. ● Lower the feed by 20% within standard conditions. 		
Looseness of screws		<ul style="list-style-type: none"> ● Change the grade to toughness. ● Tighten the screw. 			

Grade
Insert
Toolholder
Ext. Toolholder
Int. Toolholder
Threading
Grooving
Miniature Tool
Endmill
Drilling Tool
Tooling System
Index



User's Guide - Technical Reference

Drilling Tools

Troubleshooting for indexable drills

Problem		Cause	Countermeasure	
Scratch marks on the tool	The tool periphery	Misalignment of workpiece rotation	● Set the misalignment to 0 ~ 0.008".	
		Offset machining in excess of allowable range	● Use the tool in the allowable offset range.	
		Offset direction reduced diameter of workpiece	● Set offset direction extended diameter of workpiece	
		No flatness of the entry surface	● Flatten the entry surface in pre-machining. ● Set the feed for lower than 0.002 ipr in rough surface area.	
		Chipping of peripheral cutting edge	● Exchange the insert.	
		Bend of workpiece	● Change to the clamp method with rigidity.	
		Chip packing	● Increase the cutting speed by 20% and lower the feed by 20% within standard conditions. ● Raise the fluid pressure (for higher than 1.5 MPa).	
Inappropriate hole accuracy	Hole diameter	Misalignment for workpiece rotation	● Set the misalignment to 0 ~ 0.008".	
		Inappropriate offset contents	● Adjust offset contents.	
		No flatness of the entry surface	● Flatten the entry surface in pre-machining. ● Set the feed for lower than 0.002 ipr at rough surface area.	
	Roughness	Bend of workpiece	● Change to the clamp method with rigidity.	
		Varieties and supply of cutting fluid	● The concentration of cutting fluid must be higher than 5%. ● Use the cutting fluid superior in lubricity. ● Change to internal cutting fluid supply from external one.	
		Inappropriate cutting conditions	● Increase the cutting speed by 20% within standard conditions. ● Lower the feed by 20% within standard conditions.	
	Common	Failures of inserts	● Exchange the insert.	
		Chip packing	● Increase the cutting speed by 20% and lower the feed by 20% within standard conditions. ● Raise the fluid pressure (for higher than 1.5 MPa).	
		Looseness of screws	● Tighten the screw.	
Chip control	Prolonged and twisted of chips	Inappropriate cutting conditions	● Work within standard conditions. ● Increase the cutting speed by 10% within standard conditions. ● Increase the feed by 10% within standard conditions.	
		Failures of inserts	● Exchange inserts.	
		Machining by external fluid supply	● Change to internal cutting fluid supply from external one. ● Work by step feed. ● Use dwell function for 0.1 sec approximately.	
		Chips around the central cutting edge	● There is a tendency to shorten the chips when shifting to higher speed and feed.	
	Chip packing	Fluid supply	● Change to internal cutting fluid supply from external one. ● Raise the fluid pressure (for higher than 1.5 MPa).	
		Inappropriate cutting conditions	● Increase the cutting speed by 20% and lower the feed by 20% within standard conditions. ● Raise the fluid pressure (for higher than 1.5 MPa).	
	Common	Large failure of drill holders	● Exchange the drill holder.	
		Looseness of screws	● Tighten the screw.	
	Others	Chatter	Inappropriate cutting conditions	● Lower the cutting speed by 20% within standard conditions. ● Increase the feed by 10% within standard conditions.
			Large wear of inserts	● Exchange the insert.
Vibration in drilling			● Change to the machine with higher torque rigidity. ● Change to the clamp method with rigidity. ● Change the drill setting method.	
Looseness of screws			● Tighten the screw.	
Machine stop		Insufficient machine power and torque	● Use the range of number of revolutions suited machine spec. Lower the feed by 20 ~ 50%.	
		Burned inserts	● Exchange inserts before the failure becomes larger. ● Check the oil-hole plug screw is tightly screwed in place. ● Check that the fluid flows powerfully from the drill. ● Lower the cutting speed and the feed by 20% within standard conditions.	
Large burr		Failures of inserts	● Exchange the insert.	
		Inappropriate cutting conditions	● Lower the feed by 20 ~ 50% just before leaving from the workpiece.	

User's Guide - Technical Reference

Drilling Tools

Nomenclature for gun drill

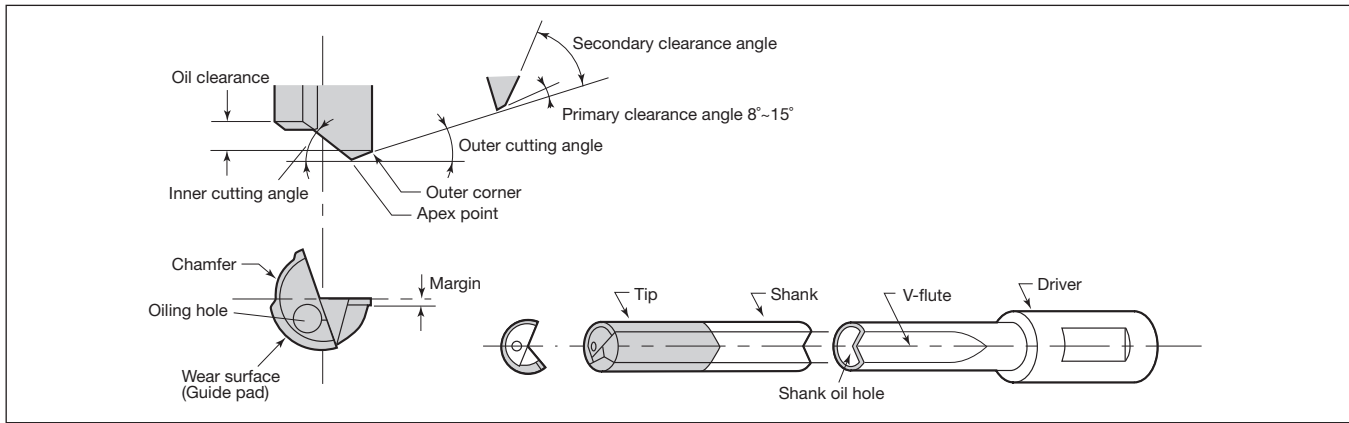

Troubleshooting in gun drilling

Problem		Cause	Trigger	Countermeasure	
Breaking of drill	At entry into workpiece	Machine	Clamping the workpiece is unstable.	Clamp the workpiece firmly.	
			The guide bush is apart from the workpiece surface at the entry.	Contact the guide bush closely with the workpiece.	
			The machine's rapid feed is used.	Use cutting feed.	
			Whipping effect occurs.	Place a whip guide at the appropriate position.	
			The shape of the guide bush is not suitable.	Use the guide bush in the shape suitable for the workpiece.	
		Drill	The drill is not set properly.	Set the drill with an appropriate torque, hydraulic pressure, etc.	
			Regrinding is in poor quality.	Make sure no damage is left on the drill and that the cutting edge geometry is not changed.	
		Cutting condition	The feed (f) is too high.	Use low feed.	
		Workpiece	The workpiece surface is slanted.	Use low feed.	
	During drilling	Machine	Clamping the workpiece is unstable.	Clamp the workpiece firmly.	
			The shape of the guide bush is not suitable.	Modify the shape of the guide bush. See "Chip packing" for the details.	
			The feed speed (V_f) varies.	Use mechanical feed.	
				The number of revolutions varies (decreases).	Increase the machine power or adjust the cutting conditions.
		Drill	Abnormal damage occurs.	See "Short tool life" for the details.	
		Cutting condition	The feed (f) is not suitable.	Use an appropriate feed.	
		Workpiece	Interrupted or cross drilling is required.	Change the tool to a standard gundrill.	
	Others	Chip packing occurs.	See "Chip packing" for the details.		
	At exit from workpiece	Drill	The tip is too long.	Make the tip length short.	
The selection of the guide pads is not suitable.			Use 2 guide pads instead of 3.		
The clearance of the coolant hole is too large.			Reduce the clearance of the coolant hole.		
Cutting condition		The feed (f) is too high.	Use low feed.		
Workpiece		The workpiece surface is slanted.	Use low feed.		
During retracting	Machine	Clamping the workpiece is unstable.	Clamp the workpiece firmly.		
	Cutting condition	Burnishing torque (cutting power) is increased due to reduced hole diameter.	Reduce cutting speed (V_c).		



User's Guide - Technical Reference

Drilling Tools

Troubleshooting in gun drilling

Problem		Cause	Trigger	Countermeasure
Hole accuracy	Rough surface finish	Machine	Clamping the workpiece is unstable.	Clamp the workpiece firmly.
			The type of coolant is not appropriate.	Use water-insoluble coolant.
			Foreign material is in the coolant.	Thoroughly filtrate the coolant (Use a filter with the filtration accuracy in 10 μ m or less).
			The run-out of the spindle is too large.	Minimize the run-out of the spindle.
			The clearance between the guide bush and the drill is not appropriate.	Replace the guide bush (The clearance should be between +0.00012" and +0.00031").
			The feed speed (V_f) varies.	Use mechanical feed.
			The number of revolutions varies (decreases).	Increase the machine power or adjust the cutting conditions.
		Drill	Abnormal damage occurs.	See "Short tool life" for the details.
			Regrinding is in poor quality.	Make sure no damage is left on the drill and that the cutting edge geometry is not changed.
		Cutting condition	The feed (f) is too high.	Reduce the feed.
	Others	Chip packing occurs.	See "Chip packing" for the details.	
	Unacceptable circularity, cylindricity, and oversize	Machine	The clearance between the guide bush and the drill is not appropriate.	Replace the guide bush (The clearance should be between +0.00012" and +0.00031").
			The guide bush is apart from the workpiece surface at the entry.	Contact the guide bush closely with the workpiece.
			The type of coolant is not appropriate.	Use water-insoluble coolant.
		Drill	The concentricity of the guide bush and the spindle is too large.	Decrease the concentricity of the guide bush and the spindle.
			Abnormal damage occurs.	See "Short tool life" for the details.
		Cutting condition	Regrinding is in poor quality.	Make sure no damage is left on the drill and that the cutting edge geometry is not changed.
		Workpiece	The feed (f) is not suitable.	Use an appropriate feed.
		Others	Interrupted or cross drilling is required.	Change the tool to a standard gundrill.
	Others	Chip packing occurs.	See "Chip packing" for the details.	
	Bending of hole	Machine	Clamping the workpiece is unstable.	Clamp the workpiece firmly.
			The guide bush is apart from the workpiece surface at the entry.	Contact the guide bush closely with the workpiece.
			The concentricity of the guide bush and the spindle is too large.	Decrease the concentricity of the guide bush and the spindle.
			The clearance between the guide bush and the drill is not appropriate.	Replace the guide bush (The clearance should be between +0.00012" and +0.00031").
		Drill	The selection of the guide pads is not suitable.	Use 2 guide pads instead of 3.
			Regrinding is in poor quality.	Make sure no damage is left on the drill and that the cutting edge geometry is not changed.
		Cutting condition	The feed (f) is too high.	Reduce the feed.
Workpiece		The workpiece has blow holes or unevenness.	Use the workpiece without defect.	
		The workpiece surface is slanted at the entry.	Use low feed.	
	Interrupted or cross drilling is required.	Change the tool to a standard gundrill.		

User's Guide - Technical Reference

Drilling Tools

Troubleshooting in gun drilling

Problem		Cause	Trigger	Countermeasure
Short tool life	Abnormal wear	Machine	The type of coolant is not appropriate.	Use water-insoluble coolant.
			Foreign material is in the coolant.	Thoroughly filtrate the coolant (Use a filter with the filtration accuracy in 10µm or less).
			The clearance between the guide bush and the drill is not appropriate.	Replace the guide bush (The clearance should be between +0.003 mm and +0.008 mm).
			Whipping effect occurs.	Place a whip guide at the appropriate position.
			The concentricity of the guide bush and the spindle is too large.	Decrease the concentricity of the guide bush and the spindle.
			The coolant temperature is too high.	Increase the capacity of the tank.
		Drill	The selection of the guide pads is not suitable.	Use 2 guide pads instead of 3.
			Regrinding is in poor quality.	Make sure no damage is left on the drill and that the cutting edge geometry is not changed.
			The drill's overall length is excessive.	Reduce the drill's overall length.
			Excessive wear occurs and the chip shape changes.	Regrind the gundrill (ease the tool life criteria).
		Cutting condition	The cutting speed (Vc) is too high.	Reduce the cutting speed.
			The feed (f) is too high.	Reduce the feed.
			The coolant pressure is not high enough.	Increase the coolant pressure.
		Workpiece	The material quality varies.	Reduce the cutting speed (Vc).
		Chip control	Chip packing	Machine
The number of revolutions varies (decreases).	Increase the machine power or adjust the cutting conditions.			
The chip box is too small for smooth chip evacuation.	Enlarge the chip box.			
Cutting condition	The feed (f) is not suitable.			Use an appropriate feed.
	The coolant pressure is not high enough.			Increase the coolant pressure.
Workpiece	Interrupted or cross drilling is required.			Change the tool to a standard gundrill.
	The operation is for stacked plates.			Change the cutting edge shape so that the cores become small.
	The material quality varies.			Increase the feed.
Chip entanglement	Drill			The cutting edge is fractured or chipped.
			Wear on the outer corner is excessive.	Regrind the gundrill (ease the tool life criteria).
	Cutting condition		The feed (f) is too low.	Increase the feed.
	Workpiece		Drilling a center hole is required.	Make the center hole as small as the drill diameter and increase the coolant pressure.



User's Guide - Technical Reference

Drilling Tools

Drilling procedure on machining centers and lathes

DEEPT^{RI}DRILL

Proceed as instructed below in order to maximize the tool performance.

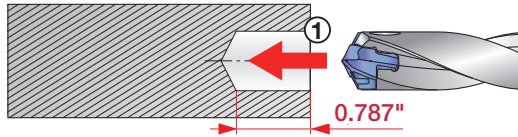

① Drill a pilot hole

Hole diameter tolerance: $+0.0004'' - +0.004''$

Hole depth: $H = 0.787''$

Please use DrillMeister or DrillForce-Meister for a pilot hole

Use a drill with $3xD$ or smaller

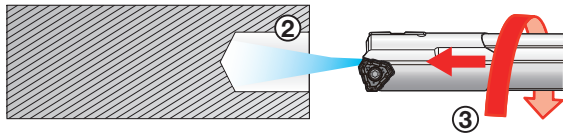

② Start coolant

③ Slowly insert DeepTri-Drill into the pilot hole

No. of revolution: $n = 1.969 - 3.937 \text{ rpm}$

Feed speed: $V_f = 4 - 12 \text{ ipm}$

Caution: Do not rotate the drill at a full machining speed before engaging the pilot hole.

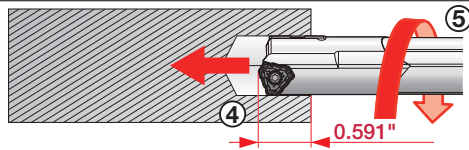

④ Stop the drill at $0.591''$ depth

⑤ Start rotating at full machining speed

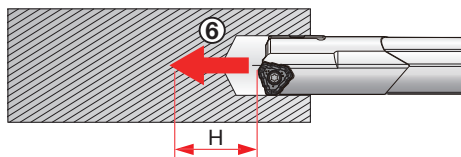

⑥ Start feeding

At the entry ($H = 0.591'' - 0.984''$):

→ Feed: $f = 80\%$ of programmed feed

Hole depth:

$H \geq 0.984'' \rightarrow$ Feed: $f = 100\%$

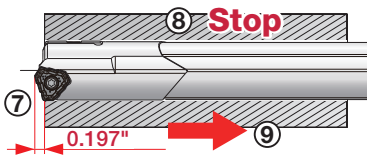

⑦ For a through hole

Continue drilling until the drill head passes through the workpiece by $0.197''$

⑧ Stop the rotation and coolant

⑨ Return the drill

How to use a TRLG type DeepTri-Drill on a horizontal machining center or boring machine

When using the TRLG drill on a conventional machining center or horizontal boring machine where there are no drilling-bush supports available, a pilot hole needs to be further deepened with a MCTR drill to better support the long Gundrill. A long Gundrill such as the TRLG type drill tends to "whip" when the pilot hole is too short to support the Gundrill.



① Drill a pilot hole

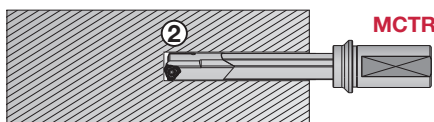

② Expand the pilot hole deeper using a MCTR drill

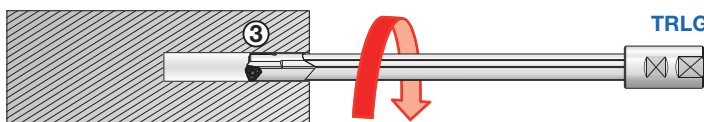

③ Drill with a TRLG drill at a reduced rotation and feed. Use the following parameters:

No. of revolution: $n = 50 - 100 \text{ rpm}$

Feed speed: $V_f = 4 - 12 \text{ ipm}$

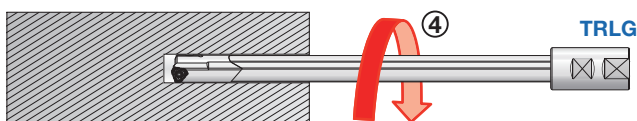

④ When DeepTri-Drill reaches all the way to the end of the pilot hole, increase drill rotation to full machining speed.

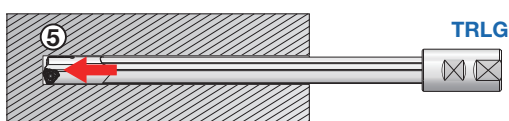

⑤ Start feeding to complete the drilling

(Caution)

Always use Step ② to prevent the Gundrill from whipping, which may lead to drill breakage and a possible superfluous injury.

User's Guide - Technical Reference

Drilling Tools

Nomenclature for gun reamer

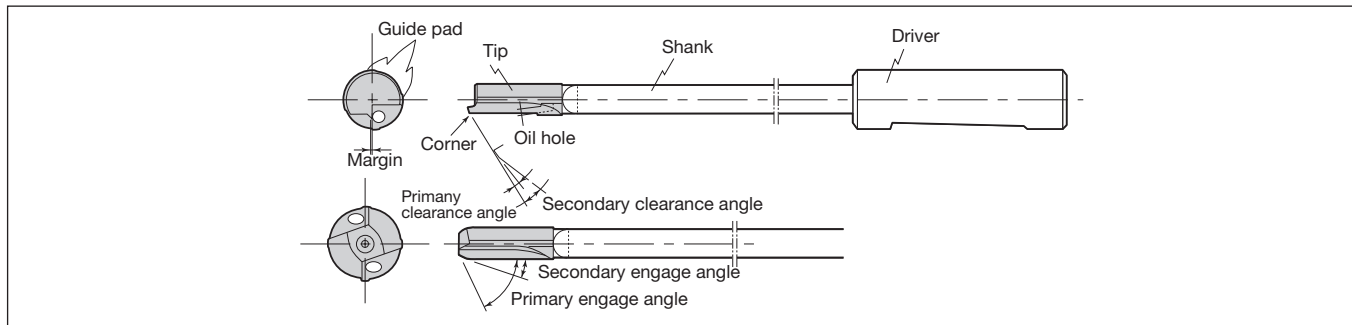

Troubleshooting in gun reaming

Trouble		Possible cause	Countermeasure	
Breaking of reamer	Increased burnishing torque due to excessively small stock allowance	● Chamfer angle small	● Enlarge chamfer angle and increase stock allowance	
		● Excessive wear in peripheral cutting edge.	● Reduce cutting speed to prevent peripheral wear of edge ● Increase lubricity of cutting fluid	
	Sticking	● Faulty filtering of cutting fluid ● Incorrect selection of cutting fluid ● Insufficient cutting fluid pressure	● Improve filtering accuracy ● Change to fluid with higher lubricity ● Increase fluid pressure	
	Mechanical trouble		● Repair electrical system ● Improve clamping method of workpiece	
Faulty machining accuracy	Unacceptable surface roughness	Excessive feed rate per tooth	● Reduce fluid pressure ● Increase number of teeth	
		Improper tool specifications	● Excessive chamfer angle ● Excessive back taper ● Peripheral run out excessive	● Reduce chamfer angle ● Reduce back taper ● Improve run out accuracy
	Too large and inconsistent over-sized	Faulty regrinding	● Cutting edge run out is large ● Residual damage of preceding process	● Improve run out accuracy ● Remove residual damage completely
		Improper cutting fluid	● Excessive fluid pressure ● Improper selection of cutting fluid	● Reduce fluid pressure ● Increase activity and lubricity of the fluid
	Faulty machine accuracy		● Correct spindle run out and bushing clearance and alignment	
	Faulty clamping of workpiece	● Clamping position wrong ● Clamping force inadequate	● Improper clamping position ● Increase clamping force	
	Defective out-of-roundness	Faulty machine accuracy	● Excessive bushing clearance ● Faulty spindle run out and alignment	● Correct bushing clearance ● Correct spindle run out and alignment
		Improper tool specifications	● Outer run out of reamer large ● Insufficient reamer rigidity	● Correct peripheral run out ● Increase reamer rigidity
		Faulty clamping position of workpiece		● Change clamping position
		Unevenness in wall thickness of workpiece		● Reduce reamer guide width (margin width)
Insufficient oversize allowance	Chamfer angle small		● Increase chamfer angle	
	Excessive wear in peripheral cutting edge	● Too high cutting speed ● Faulty lubricity of cutting fluid	● Decrease cutting speed ● Increase lubricating capacity	
	Faulty regrinding (residual damage)		● Increase regrinding stock amount	

Grade
Insert
Toolholder
Ext. Toolholder
Int. Toolholder
Threading
Grooving
Miniature Tool
Milling Cutter
Endmill
Drilling Tool
Tooling System
User's Guide
Index



User's Guide - Technical Reference

International Tolerance (IT Grade)

IT grades show a tolerance allowable for difference of the diameters of a hole and a shaft. As the number added after IT increases, the tolerance becomes rough. Depending on the basic size, the tolerance value in each grade varies.

In the catalog, IT grades are shown as a guide of dimensional dispersion in the diameters of holes machined with the drill. For information, H8 tolerance for a $\varnothing 8.0$ hole is 0 to + 0.022 mm, the width of the value is the same as that of IT 8.

In the Table shown below, tolerance areas attainable with typical drilling tools are distinguished by using different colors. Solid drills are generally used for machining holes of IT 9 to 12. For machining a hole of better than IT 8, finishing process such as reaming is required. For a hole better than IT 5, high-precision finishing is required. Above description is based on machining of general steel. In practice, the IT grade attained with the tool varies widely depending on the hardness and the composition of the work material.

IT (International Tolerance) Grades

Basic size (mm)		International tolerance grade																	
		IT1	IT2	IT3	IT4	IT5	IT6	IT7	IT8	IT9	IT10	IT11	IT12	IT13	IT14	IT15	IT16	IT17	IT18
>	≤							(μm)						(mm)					
-	3	0.8	1.2	2	3	4	6	10	14	25	40	60	0.1	0.14	0.25	0.4	0.6	1	1.4
3	6	1	1.5	2.5	4	5	8	12	18	30	48	75	0.12	0.18	0.3	0.48	0.75	1.2	1.8
6	10	1	1.5	2.5	4	6	9	15	22	36	58	90	0.15	0.22	0.36	0.58	0.9	1.5	2.2
10	18	1.2	2	3	5	8	11	18	27	43	70	110	0.18	0.27	0.43	0.7	1.1	1.8	2.7
18	30	1.5	2.5	4	6	9	13	21	33	52	84	130	0.21	0.33	0.52	0.84	1.3	2.1	3.3
30	50	1.5	2.5	4	7	11	16	25	39	62	100	160	0.25	0.39	0.62	1	1.6	2.5	3.9
50	80	2	3	5	8	13	19	30	46	74	120	190	0.3	0.46	0.74	1.2	1.9	3	4.6
80	120	2.5	4	6	10	15	22	35	54	87	140	220	0.35	0.54	0.87	1.4	2.2	3.5	5.4
120	180	3.5	5	8	12	18	25	40	63	100	160	250	0.4	0.63	1	1.6	2.5	4	6.3
180	250	4.5	7	10	14	20	29	46	72	115	185	290	0.46	0.72	1.15	1.85	2.9	4.6	7.2
250	315	6	8	12	16	23	32	52	81	130	210	320	0.52	0.81	1.3	2.1	3.2	5.2	8.1
315	400	7	9	13	18	25	36	57	89	140	230	360	0.57	0.89	1.4	2.3	3.6	5.7	8.9
400	500	8	10	15	20	27	40	63	97	155	250	400	0.63	0.97	1.55	2.5	4	6.3	9.7
500	630	9	11	16	22	32	44	70	110	175	280	440	0.7	1.1	1.75	2.8	4.4	7	11
630	800	10	13	18	25	36	50	80	125	200	320	500	0.8	1.25	2	3.2	5	8	12.5
800	1000	11	15	21	28	40	56	90	140	230	360	560	0.9	1.4	2.3	3.6	5.6	9	14
1000	1250	13	18	24	33	47	66	105	165	260	420	660	1.05	1.65	2.6	4.2	6.6	10.5	16.5
1250	1600	15	21	29	39	55	73	125	195	310	500	780	1.25	1.95	3.1	5	7.8	12.5	19.5
1600	2000	18	25	35	46	65	92	150	230	370	600	920	1.5	2.3	3.7	6	9.2	15	23
2000	2500	22	30	41	55	78	110	175	280	440	700	1100	1.75	2.8	4.4	7	11	17.5	28
2500	3150	26	36	50	68	96	135	210	330	540	860	1350	2.1	3.3	5.4	8.6	13.5	21	33

Tolerance area requiring finishing process such as with a reamer.

Tolerance area attainable with a solid drill.

Tolerance area attainable with an indexable drill.

User's Guide - Technical Reference

Deviations of Shafts to be Used in Commonly Used Fits

Deviations of Shafts to be Used in Commonly Used Fits (JIS B0401 extract)

Basic size step (mm)		Tolerance zone class of shaft (μm)															
>	≤	e9	f6	f7	f8	g5	g6	h5	h6	h7	h8	h9	js5	js6	js7	k5	k6
-	3	-14 -39	-6 -12	-6 -16	-6 -20	-2 -6	-2 -8	0 -4	0 -6	0 -10	0 -14	0 -25	±2	±3	±5	+4 0	+6 0
3	6	-20 -50	-10 -18	-10 -22	-10 -28	-4 -9	-4 -12	0 -5	0 -8	0 -12	0 -18	0 -30	±2.5	±4	±6	+6 +1	+9 +1
6	10	-25 -61	-13 -22	-13 -28	-13 -35	-5 -11	-5 -14	0 -6	0 -9	0 -15	0 -22	0 -36	±3	±4.5	±7	+7 +1	+10 +1
10	14	-32 -75	-16 -27	-16 -34	-16 -43	-6 -14	-6 -17	0 -8	0 -11	0 -18	0 -27	0 -43	±4	±5.5	±9	+9 +1	+12 +1
14	18																
18	24	-40 -92	-20 -33	-20 -41	-20 -53	-7 -16	-7 -20	0 -9	0 -13	0 -21	0 -33	0 -52	±4.5	±6.5	±10	+11 +2	+15 +2
24	30																
30	40	-50 -112	-25 -41	-25 -50	-25 -64	-9 -20	-9 -25	0 -11	0 -16	0 -25	0 -39	0 -62	±5.5	±8	±12	+13 +2	+18 +2
40	50																
50	65	-60 -134	-30 -49	-30 -60	-30 -76	-10 -23	-10 -29	0 -13	0 -19	0 -30	0 -46	0 -74	±6.5	±9.5	±15	+15 +2	+21 +2
65	80																
80	100	-72 -159	-36 -58	-36 -71	-36 -90	-12 -27	-12 -34	0 -15	0 -22	0 -35	0 -54	0 -87	±7.5	±11	±17	+18 +3	+25 +3
100	120																

In every step given in the table, the value on the upper side shows the upper deviation and the value on the lower side, the lower deviation.

Deviations of Holes to be Used in Commonly Used Fits. (JIS B0401 extract)

Basic size step (mm)		Tolerance zone class of hole (μm)																
>	≤	E7	E8	E9	F6	F7	F8	G6	G7	H6	H7	H8	H9	H10	JS6	JS7	K6	K7
-	3	+24 +14	+28 +14	+39 +14	+12 +6	+16 +6	+20 +6	+8 +2	+12 +2	+6 0	+10 0	+14 0	+25 0	+40 0	±3	±5	0 -6	0 -10
3	6	+32 +20	+38 +20	+50 +20	+18 +10	+22 +10	+28 +10	+12 +4	+16 +4	+8 0	+12 0	+18 0	+30 0	+48 0	±4	±6	+2 -6	+3 -9
6	10	+40 +25	+47 +25	+61 +25	+22 +13	+28 +13	+35 +13	+14 +5	+20 +5	+9 0	+15 0	+22 0	+36 0	+58 0	±4.5	±7	+2 -7	+5 -10
10	14	+50 +32	+59 +32	+75 +32	+27 +16	+34 +16	+43 +16	+17 +6	+24 +6	+11 0	+18 0	+27 0	+43 0	+70 0	±5.5	±9	+2 -9	+6 -12
14	18																	
18	24	+61 +40	+73 +40	+92 +40	+33 +20	+41 +20	+53 +20	+20 +7	+28 +7	+13 0	+21 0	+33 0	+52 0	+84 0	±6.5	±10	+2 -11	+6 -15
24	30																	
30	40	+75 +50	+89 +50	+112 +50	+41 +25	+50 +25	+64 +25	+25 +9	+34 +9	+16 0	+25 0	+39 0	+62 0	+100 0	±8	±12	+3 -13	+7 -18
40	50																	
50	65	+90 +60	+106 +60	+134 +60	+49 +30	+60 +30	+76 +30	+29 +10	+40 +10	+19 0	+30 0	+46 0	+74 0	+120 0	±9.5	±15	+4 -15	+9 -21
65	80																	
80	100	+107 +72	+126 +72	+159 +72	+58 +36	+71 +36	+90 +36	+34 +12	+47 +12	+22 0	+35 0	+54 0	+87 0	+140 0	±11	±17	+4 -18	+10 -25
100	120																	

In every step given in the table, the value on the upper side shows the upper deviation and the value on the lower side, the lower deviation.



User's Guide - Technical Reference

Symbols of Metals

● Carbon steel and alloy steel for structural use

Type	Japan	International	Other countries				
	JIS		ISO	U.S.A. AISI SAE	Great Britain BS BS/EN	Germany DIN DIN/EN	France NF NF/EN
Carbon steel	S10C	C10	1010	C10 C10E C10R	C10E C10R	C10E C10R	-
	S15C	C15E4 C15M2	1015	C15 C15E C15R	C15E C15R	C15E C15R	-
	S20C	-	1020	C22, C22E C22R	C22 C22E C22R	C22 C22E C22R	-
	S25C	C25 C25E4 C25M2	1025	C25 C25E C25R	C25 C25E C25R	C25 C25E C25R	-
	S30C	C30 C30E4 C30M2	1030	C30 C30E C30R	C30 C30E C30R	C30 C30E C30R	30Г
	S35C	C35 C35E4 C35M2	1035	C35 C35E C35R	C35 C35E C35R	C35 C35E C35R	35Г
	S40C	C40 C40E4 C40M2	1039 1040	C40 C40E C40R	C40 C40E C40R	C40 C40E C40R	40Г
	S43C	-	1042 1043	080A42	-	-	40Г
	S45C	C45 C45E4 C45M2	1045 1046	C45 C45E C45R	C45 C45E C45R	C45 C45E C45R	45Г
	S48C	-	-	-	-	-	45Г
	S50C	C50 C50E4 C50M2	1049	C50 C50E C50R	C50 C50E C50R	C50 C50E C50R	50Г
	S53C	-	1050 1053	-	-	-	50Г
	S55C	C55 C55E4 C55M2	1055	C55 C55E C55R	C55 C55E C55R	C55 C55E C55R	-
	S58C	C60 C60E4 C60M2	1059 1060	C60 C60E C60R	C60 C60E C60R	C60 C60E C60R	60Г

Type	Japan	International	Other countries					
	JIS		ISO	U.S.A. AISI SAE	Great Britain BS BS/EN	Germany DIN DIN/EN	France NF NF/EN	Russia ГОСТ
Nickel chromium steel	SNC236	-	-	-	-	-	40XH	
	SNC415(H)	-	-	-	-	-	-	
	SNC631(H)	-	-	-	-	-	30XH3A	
	SNC815(H)	15NiCr13	-	15NiCr13	15NiCr13	15NiCr13	-	
	SNC836	-	-	-	-	-	-	
Alloy steel	Nickel chromium molybdenum steel	SNCM220	20NiCrMo2 20NiCrMoS2	8615 8617(H) 8620(H) 8622(H)	20NiCrMo2-2 20NiCrMoS2-2	20NiCrMo2-2 20NiCrMoS2-2	20NiCrMo2-2 20NiCrMoS2-2	-
		SNCM240	41CrNiMo2 41CrNiMoS2	8637 8640	-	-	-	-
	SNCM415	-	-	-	-	-	-	
	SNCM420(H)	-	4320(H)	-	-	-	20XH2M(20XHM)	
	SNCM431	-	-	-	-	-	-	
	SNCM439	-	4340	-	-	-	-	
	SNCM447	-	-	-	-	-	-	
	SNCM616	-	-	-	-	-	-	
	SNCM625	-	-	-	-	-	-	
	SNCM630	-	-	-	-	-	-	
SNCM815	-	-	-	-	-	-		

Note: The above chart is based on published data and not authorized by each manufacturer.

User's Guide - Technical Reference

Symbols of Metals

● Alloy steel

Type	Japan	International	Other countries					
	JIS		ISO	U.S.A. AISI SAE	Great Britain BS BS/EN	Germany DIN DIN/EN	France NF NF/EN	Russia ГОСТ
Alloy steel	Chromium steel	SCr415(H)	-	-	17Cr3 17CrS3	17Cr3 17CrS3	17Cr3 17CrS3	15X 15XA
		SCr420(H)	20Cr4(H) 20CrS4	5120(H)	-	-	-	20X
		SCr430(H)	34Cr4 34CrS4	5130(H) 5132(H)	34Cr4 34CrS4	34Cr4 34CrS4	34Cr4 34CrS4	30X
		SCr435(H)	34Cr4 34CrS4 37Cr4 37CrS4	5132	37Cr4 37CrS4	37Cr4 37CrS4	37Cr4 37CrS4	35X
		SCr440(H)	37Cr4 37CrS4 41Cr4 41CrS4	5140(H)	530M40 41Cr4 41CrS4	41Cr4 41CrS4	41Cr4 41CrS4	40X
		SCr445(H)	-	-	-	-	-	45X
	Chromium molybdenum steel	SCM415(H)	-	-	-	-	-	-
		SCM418(H)	18CrMo4 18CrMoS4	-	18CrMo4 18CrMoS4	18CrMo4 18CrMoS4	18CrMo4 18CrMoS4	20XM
		SCM420(H)	-	-	708M20(708H20)	-	-	20XM
		SCM430	-	4130	-	-	-	30XM 30XMA
		SCM432	-	-	-	-	-	-
		SCM435(H)	34CrMo4 34CrMoS4	4137(H)	34CrMo4 34CrMoS4	34CrMo4 34CrMoS4	34CrMo4 34CrMoS4	35XM
		SCM440(H)	42CrMo4 42CrMoS4	4140(H) 4142(H)	42CrMo4 42CrMoS4	42CrMo4 42CrMoS4	42CrMo4 42CrMoS4	-
	SCM445(H)	-	4145(H) 4147(H)	-	-	-	-	
	Manganese steel and manganese chromium steel	SMn420(H)	22Mn6(H)	1522(H)	-	-	-	-
SMn433(H)		-	1534	-	-	-	30I2 35I2	
SMn438(H)		36Mn6(H)	1541(H)	-	-	-	35I2 40I2	
SMn443(H)		42Mn6(H)	1541(H)	-	-	-	40I2 45I2	
SMnC420(H)		-	-	-	-	-	-	
SMnC443(H)	-	-	-	-	-	-		
Aluminum chromium molybdenum steel	SACM645	41CrAlMo74	-	-	-	-	-	

● Stainless steel

Type	Japan	International	Other countries						
	JIS		ISO	U.S.A. UNS	AISI SAE	Great Britain BS BS/EN	Germany DIN DIN/EN	France NF NF/EN	Russia ГОСТ
Stainless steel	Austenitic	SUS201	X12CrMnNiN17-7-5	S20100	201	-	-	Z12CMN17-07Az	-
		SUS202	X12CrMnNiN18-9-5	S20200	202	284S16	-	-	12X17I9AH4
		SUS301	X10CrNi18-8	S30100	301	301S21	X12CrNi17-7	Z11CN17-08	07X16H6
		SUS301L	X2CrNiN18-7	-	-	-	X2CrNiN18-7	-	-
		SUS301J1	-	-	-	-	X12CrNi17-7	-	-
		SUS302	-	S30200	302	302S25	-	Z12CN18-09	12X18H9
		SUS302B	X12CrNiSi18-9-3	S30215	302B	-	-	-	-
		SUS303	X10CrNiS18-9	S30300	303	303S21	X10CrNiS18-9	Z8CNF18-09	-
		SUS303Se	-	S30323	303Se	303S41	-	-	12X18H10E
		SUS303Cu	-	-	-	-	-	-	-
		SUS304	X5CrNi18-9	S30400	304	304S31	X5CrNi18-10	Z7CN18-09	08X18H10
		SUS304L	X2CrNi18-9	S30403	304L	304S11	X2CrNi19-11	Z3CN19-11	03X18H11
		SUS304N1	X5CrNiN18-8	S30451	304N	-	-	Z6CN19-09Az	-
		SUS304N2	-	S30452	-	-	-	-	-
		SUS304LN	X2CrNiN18-9	S30453	304LN	-	X2CrNiN18-10	Z3CN18-10Az	-
		SUS304J1	-	-	-	-	-	-	-
		SUS304J2	-	-	-	-	-	-	-
SUS304J3	-	-	S30431	S30431	-	-	-		
SUS305	X6CrNi18-12	S30500	305	305S19	X5CrNi18-12	Z8CN18-12	06X18H11		

Note: The above chart is based on published data and not authorized by each manufacturer.



User's Guide - Technical Reference

Symbols of Metals

● Stainless steel

Type	Japan	International	Other countries							
			U.S.A.		Great Britain	Germany	France	Russia		
			JIS	ISO	UNS	AISI SAE	BS BS/EN	DIN DIN/EN	NF NF/EN	ГОСТ
Stainless steel	Austenitic	SUS305J1								
		SUS309S			S30908	309S			Z10CN24-13	
		SUS310S	X6CrNi25-21		S31008	310S	310S31		Z8CN25-20	10X23H18
		SUS315J1								
		SUS315J2								
		SUS316	X5CrNiMo17-12-2 X3CrNiMo17-12-3		S31600	316	316S31	X5CrNiMo17-12-2 X5CrNiMo17-13-3	Z7CND17-12-02 Z6CND18-12-03	
		SUS316F								
		SUS316L	X2CrNiMo17-12-2 X2CrNiMo17-12-3 X2CrNiMo18-14-3		S31603	316L	316S11	X2CrNiMo17-13-2 X2CrNiMo17-14-3	Z3CND17-12-02 Z3CND17-12-03	03X17H14M3
		SUS316N			S31651	316N				
		SUS316LN	X2CrNiMoN17-11-2 X2CrNiMoN17-12-3		S31653	316LN		X2CrNiMoN17-12-2 X2CrNiMoN17-13-3	Z3CND17-11Az Z3CND17-12Az	
		SUS316Ti	X6CrNiMoTi17-12-2		S31635			X6CrNiMoTi17-12-2	Z6CNDT17-12	08X17H13M2T
		SUS316J1								
		SUS316J1L								
		SUS317			S31700	317	317S16			
		SUS317L	X2CrNiMo19-14-4		S31703	317L	317S12	X2CrNiMo18-16-4	Z3CND19-15-04	
		SUS317LN	X2CrNiMoN18-12-4		S31753				Z3CND19-14Az	
		SUS317J1								
		SUS317J2								
		SUS317J3L								
		SUS836L			N08367					
		SUS890L	X1CrNiMoCu25-20-5		N08904	N08904	904S14		Z2NCU25-20	
		SUS321	X6CrNiTi18-10		S32100	321	321S31	X6CrNiTi18-10	Z6CNT18-10	08X18H10T
		SUS347	X6CrNiNb18-10		S34700	347	347S31	X6CrNiNb18-10	Z6CNNb18-10	08X18H12B
		SUS384	X3NiCr18-16		S38400	384			Z6CN18-16	
		SUSXM7	X3CrNiCu18-9-4		S30430	304Cu	394S17		Z2CNU18-10	
		SUSXM15J1			S38100				Z15CNS20-12	
		Austenitic Ferritic	SUS329J1		S32900	329				
			SUS329J3L	X2CrNiMoN22-5-3	S31803	31803			Z3CNDU22-05Az	08X21H6M2T
	SUS329J4L		X2CrNiMoCuN25-6-3	S32250	32250			Z3CNDU25-07Az		
	Ferritic	SUS405	X6CrAl13	S40500	405	405S17	X6CrAl13	Z8CA12		
		SUS410L						Z3C14		
		SUS429		S42900	429					
		SUS430	X6Cr17	S43000	430	430S17	X6Cr17	Z8C17	12X17	
		SUS430F	X7CrS17	S43020	430F		X7CrS18	Z8CF17		
		SUS430LX	X3CrTi17 X3CrNb17	S43035			X6CrTi17	Z4CT17		
		SUS430J1L	X2CrTi17				X6CrNb17	Z4CNb17		
		SUS434	X6CrMo17-1	S43400	434	434S17	X6CrMo17-1	Z8CD17-01		
		SUS436L	X1CrMoTi16-1	S43600	436					
		SUS436J1L								
		SUS444	X2CrMoTi18-2	S44400	444			Z3CDT18-02		
		SUS445J1								
		SUS445J2								
		SUS447J1			S44700					
		SUSXM27			S44627				Z1CD26-01	
	Martensitic	SUS403		S40300	403					
		SUS410	X12Cr13	S41000	410	410S21	X10Cr13	Z13C13		
		SUS410S	X6Cr13	S41008	410S	403S17	X6Cr13	Z8C12	08X13	
		SUS410F2								
SUS410J1				S41025						
SUS416		X12CrS13	S41600	416	416S21		Z11CF13			
SUS420J1		X20Cr13	S42000	420	420S29	X20Cr13	Z20C13	20X13		
SUS420J2		X30Cr13	S42000	420	420S37	X30Cr13	Z33C13	30X13		
SUS420F		X29CrS13	S42020	420F			Z30CF13			
SUS420F2										
SUS429J1										
SUS431		X19CrNi16-2	S43100	431	431S29	X20CrNi17-2	Z15CN16-02	20X17H2		
SUS440A		X70CrMo15	S44002	440A			Z70C15			
SUS440B			S44003	440B						
SUS440C		X105CrMo17	S44004	440C			Z100CD17	95X18		
SUS440F		S44020	S44020							
Precipitation hardening type	SUS630	X5CrNiCuNb16-4	S17400	S17400			Z6CNU17-04			
	SUS631	X7CrNiAl17-7	S17700	S17700		X7CrNiAl17-7	Z9CNA17-07	09X17H7IO		
	SUS631J1									

Note: The above chart is based on published data and not authorized by each manufacturer.

User's Guide - Technical Reference

Symbols of Metals

● Heat resistant steel

Type	Japan	International	Other countries							
			U.S.A.		Great Britain	Germany	France	Russia		
			JIS	ISO	UNS	AISI SAE	BS BS/EN	DIN DIN/EN	NF NF/EN	ГОСТ
Heat resistant steel	Austenitic	SUH31				331S42		Z35CNWS14-14	45X14H14B2M	
		SUH35			S63008		349S52		Z52CMN21-09Az	
		SUH36					349S54	X53CrMnNi21-9	Z55CMN21-09Az	55X20Г9 AH4
		SUH37			S63017		381S34			
		SUH38								
		SUH309			S30900	309	309S24		Z15CN24-13	
		SUH310			S31000	310	310S24	CrNi2520	Z15CN25-20	20X25H20C2
		SUH330			N08330	N08330			Z12NCS35-16	
	SUH660			S66286				Z6NCTV25-20		
	SUH661			R30155						
	Ferritic	SUH21						CrAl1205		
		SUH409	X6CrTi12		S40900	409	409S19	X6CrTi12	Z6CT12	
		SUH409L	X2CrTi12						Z3CT12	
		SUH446			S44600	446			Z12C25	15X28
	Martensitic	SUH1			S65007		401S45	X45CrSi9-3	Z45CS9	
		SUH3							Z40CSD10	40X10C2M
SUH4						443S65		Z80CSN20-02		
SUH11									40X9C2	
SUH600									20X12BHMБФP	
SUH616				S42200						

● Tool steel

Type	Japan	International	U.S.A.	Type	Japan	International	U.S.A.	
	JIS	ISO	AISI ASTM		JIS	ISO	AISI ASTM	
Carbon tool steel	SK140	-	-	Alloy tool steel	SKS5	-	-	
	SK120	C120U	W1-11 1/2		SKS51	-	L6	
	SK105	C105U	W1-10		SKS7	-	-	
	SK95	-	W1-9		SKS81	-	-	
	SK90	C90U	-		SKS8	-	-	
	SK85	-	W1-8		SKS4	-	-	
	SK80	C80U	-		SKS41	-	-	
	SK75	-	-		SKS43	105V	W2-9 1/2	
	SK70	C70U	-		SKS44	-	W2-8 1/2	
	SK65	-	-		SKS3	-	-	
	SK60	-	-		SKS31	-	-	
	High speed steel	SKH2	HS18-0-1		T1	SKS93	-	-
		SKH3	-		T4	SKS94	-	-
SKH4		-	T5	SKS95	-	-		
SKH10		-	T15	SKD1	X210Cr12	D3		
SKH40		HS6-5-3-8	-	SKD2	X210CrW12	-		
SKH50		HS1-8-1	-	SKD10	X153CrMoV12	-		
SKH51		HS6-5-2	M2	SKD11	-	D2		
SKH52		HS6-6-2	M3-1	SKD12	X100CrMoV5	A2		
SKH53		HS6-5-3	M3-2	SKD4	-	-		
SKH54		HS6-5-4	M4	SKD5	X30WCrV9-3	H21		
SKH55		HS6-5-2-5	-	SKD6	-	H11		
SKH56		-	M36	SKD61	X40CrMoV5-1	H13		
SKH57		HS10-4-3-10	-	SKD62	X35CrWMoV5	H12		
SKH58	HS2-9-2	M7	SKD7	32CrMoV12-28	H10			
SKH59	HS2-9-1-8	M42	SKD8	38CrCoW18-17-17	H19			
Alloy tool steel	SKS11	-	F2	SKT3	-	-		
	SKS2	-	-	SKT4	55NiCrMoV7	-		
	SKS21	-	-	SKT6	45NiCrMo16	-		

● Special use steel

Type	Japan	International	U.S.A.	Type	Japan	International	U.S.A.
	JIS	ISO	AISI ASTM		JIS	ISO	AISI ASTM
Free cutting carbon steels	SUM11	-	1110	Free cutting carbon steels	SUM32	-	-
	SUM12	-	1109		SUM41	-	1137
	SUM21	9S20	1212		SUM42	-	1141
	SUM22	11SMn28	1213		SUM43	44SMn28	1144
	SUM22L	11SMnPb28	-	High carbon chromium	SUJ1	-	-
	SUM23	-	1215		SUJ2	B1	52100
	SUM23L	-	-		SUJ3	B2	ASTM A 485
	SUM24L	11SMnPb28	12L14				Grade 1
	SUM25	12SMn35	-		SUJ4	-	-
	SUM31	-	1117		SUJ5	-	-
	SUM31L	-	-				

Note: The above chart is based on published data and not authorized by each manufacturer.



User's Guide - Technical Reference

Symbols of Metals

● Casting or forging steel

Type	Japan	International	Other countries						
			JIS	ISO	U.S.A.	Great Britain	Germany	France	Russia
					AISI ASTM	BS BS/EN	DIN DIN/EN	NF NF/EN	ГОСТ
Casting steel	Carbon steel casting	SC	200-400, 230-450, 270-480	U-	A1, A2	GS-	GE230, GE280, GE320	-	
	Steel casting for welded structure	SCW	200-400W, 230-450W, 270-480W, 340-550W	WCA, WCB, WCC	A4	-	GE230, GE280	-	
	Heat resisting steel casting	SCH	GX40CrSi24, GX40CrNiSi22-10, GX40NiCrSi38-19	Grade HC, HD, HF	309C30, 310C45, 330C12	-	GX40NiCrNb45-35, GX50NiCrCoW35-25-15-5	-	
	Steel casting for high temperature and high pressure service	SCPH	-	Grade WC1, WC6, WC9	A1, A2, B1, B2, B3, B4, B5, B7	G20Mo5, G17CrMo5-5, G17CrMo5-10	G17CrMo9-10, GX15CrMo5, GP240GH, GP280GH	-	
	Steel casting for low temperature and high pressure service	SCPL	-	Grade LCB, LC1, LC2, LC3	AL1, BL2	-	FB-M, FC1-M, FC2-M, FC3-M	-	
Casting iron	Grey iron casting	FC	100,150,200,250, 300,350	No.20,25,30,35, 40,45,50	EN-GJL-	EN-GJL-	EN-GJL-	-	
	Spheroidal graphite iron casting	FCD	700-2, 600-3, 500-7, 450-10, 400-15, 400-18, 350-22	60-40-18, 65-45-12, 8-55-06, 100-70-03, 120-90-02	EN-GJS-	EN-GJS-	EN-GJS-	B4	
	Austempered spheroidal graphite iron casting	FCAD	-	-	EN-GJS-	EN-GJS-	EN-GJS-	-	
	Austenitic iron casting	FCA-FCDA-	L-, S-	Type 1, 2, Type D-2, D-3A Class 1, 2	F1, F2, S2W, S5S	GGL-, GGG-	L-, S-	-	
Forging steel	Carbon steel forging for general use	SF	-	Class A, B, C, D, E, F	C22, C25, C30, C35, C40, C45, C50, C55, C60	P285, P355	P245, P280, P305	-	
	Chromium molybdenum steel forgings for general use	SFCM	-	Class E, F, G, I Grade 3A, 4 Class G, J, K, L, M	-	-	-	-	
	Nickel Chromium molybdenum steel forgings for general use	SFNCM	-	Class G, H, I, J Class 3A, 4, 5, 6 Class K, L, M	-	-	-	-	

● Non-ferrous alloy

Type	Japan	International	Other countries				
			JIS	ISO	U.S.A.	Great Britain	Germany
					ASTM SAE	BS BS/EN	DIN DIN/EN
Copper alloy casting	CAC101	-	-	-	-		
	CAC102	-	-	-	Cu-C(CC040AgradeC)		
	CAC103	-	-	-	Cu-C(CC040AgradeA,B)		
Brass casting	CAC201	-	-	-	CuZn15As-C(CC760S)		
	CAC202	-	C85400	-	CuZn33Pb2-C(CC750S)		
	CAC203	-	C85700	-	CuZn39Pb1-C(CC754S)		
High strength brass casting	CAC301	-	C86500	-	CuZn35Mn2Al1Fe-C(CC765S)		
	CAC302	-	C86400	-	CuZn34Mn3Al2Fe1-C(CC764S)		
	CAC303	-	C86200	-	CuZn25Al5Mn4Fe3-C(CC762S)		
	CAC304	-	C86300	-	CuZn25Al5Mn4Fe3-C(CC762S)		
Bronze casting	CAC401	-	C84400	-	CuSn3Zn8Pb5-C(CC490K)		
	CAC402	-	C90300	-	-		
	CAC403	-	C90500	-	-		
	CAC406	-	C83600	-	CuSn5Zn5Pb5-C(CC490K)		
	CAC407	-	C92200	-	-		
Phosphor bronze casting	CAC502A	-	-	-	-		
	CAC502B	-	C90700	-	CuSn10-C(CC480K)		
	CAC503A	-	C90800	-	CuSn12-C(CC483K)		
	CAC503B	-	-	-	-		
Aluminum bronze casting	CAC701	-	C95200	-	CuAl10Fe2-C(CC331G)		
	CAC702	-	C95400	-	CuAl10Ni3Fe2-C(CC332G)		
	CAC703	-	C95410	-	-		
	CAC704	-	C95800	-	CuAl10Fe5Ni5-C(CC333G)		
Silicon bronze castings	CAC801	-	-	-	-		
	CAC802	-	C87500	-	-		
	CAC803	-	C87400	-	CuZn16Si4-C(CC761S)		

Note: The above chart is based on published data and not authorized by each manufacturer.

User's Guide - Technical Reference

Symbols of Metals

● Non-ferrous alloy

Type	Japan	International	Other countries				
	JIS	ISO	U.S.A.	Great Britain	Germany	France	
			ASTM SAE	BS BS/EN	DIN DIN/EN	NF NF/EN	
Aluminum alloy	Aluminum alloy ingots for casting	AC1B	Al-Cu4MgTi	204.0		EN AC-2100	
		AC2A	-	-		-	
		AC2B	-	319.0			
		AC3A	-	-			EN AC-44100
		AC4A	-	-			-
		AC4B	Al-Si8Cu3	333.0			EN AC-46200
		AC4C	Al-Si7Mg(Fe)	356.0			EN AC-42000
		AC4CH	Al-Si7Mg0.3	A356.0			EN AC-42100
		AC4D	-	355.0			EN AC-45300
		AC5A	Al-Cu4Ni2Mg2	242.0			-
		AC7A	-	514.0			-
		AC8A	Al-Si12CuNiMg	-			EN AC-48000
		AC8B	-	-			-
	AC8C	-	332.0			-	
	AC9A	-	-			-	
	AC9B	-	-			-	
	Aluminum alloy die casting	ADC1	-	A413.0			-
		ADC3	-	A360.0			-
		ADC5	-	518.0			-
		ADC6	-	-			-
ADC10		-	-			-	
ADC10Z		-	A380.0			-	
ADC12		-	-			-	
ADC12Z		-	383.0			-	
ADC14	-	B390.0			-		
Magnesium alloy	Magnesium alloy casting	MC5	-	AM100A		-	
		MC6	-	ZK51A		-	
		MC7	-	ZK61A		-	
		MC8	MgRE3Zn2Zr	EZ33A		EN MC65120	
		MC9	MgAg3RE2Zr	QE22A		EN MC65210	
		MC10	MgZn4RE1Zr	ZE41A		EN MC35110	
	Magnesium alloy die casting	MD1A	-	AZ91A		G-A9Z1Y4	
		MDC1B	-	AZ91B		-	
		MDC1D	MgAl9Zn1(A)	AZ91D		EN MC21120	
		MDC2B	MgAl6Mn	AM60B		EN MC21320	
Type	Japan	International	Other countries				
	JIS	ISO	U.S.A.	Great Britain	Germany	France	
			ASTM AA	BS BS/EN	DIN DIN/EN	NF NF/EN	
Aluminum alloy	Aluminum alloy extruded shapes	A5052S	-	5052		EN AW-5052	
		A5454S	-	5454		EN AW-5454	
		A5083S	AlMg4.5Mn0.7	5083		EN AW-5083	
		A5086S	-	5086		EN AW-5086	
		A6061S	AlMg1SiCu	6061		EN AW-6061	
		A6063S	AlMg0.7Si	6063		EN AW-6063	
		A7003S	-	-		EN AW-7003	
		A7N01S	-	-		-	
		A7075S	AlZn5.5MgCu	7075		EN AW-7075	

Note: The above chart is based on published data and not authorized by each manufacturer.

Grade
Insert
Toolholder
Ext. Toolholder
Int. Toolholder
Threading
Grooving
Tool
Miniature Tool
Milling Cutter
Endmill
Drilling Tool
Tooling System
User's Guide
Index



User's Guide - Technical Reference

Approximate Conversion Table of Hardness

● Approximate conversion value for Brinell hardness. *1

(The source: JIS HB Ferrous Materials and Metallurgy I -2005)

HB		HV	Rockwell *3				HS	Approx. tensile strength (MPa) *2	HB		HV	Rockwell *3				HS	Approx. tensile strength (MPa) *2
Brinell, 10mm ball, Load 3000kg			HRA	HRB	HRC	HRD			Brinell, 10mm ball, Load 3000kg			HRA	HRB	HRC	HRD		
Standard ball	Tungsten carbide ball								Standard ball	Tungsten carbide ball							
-	-	940	85.6	-	68.0	76.9	97	-	429	429	455	73.4	-	45.7	59.7	61	1510
-	-	920	85.3	-	67.5	76.5	96	-	415	415	440	72.8	-	44.5	58.8	59	1460
-	-	900	85.0	-	67.0	76.1	95	-	401	401	425	72.0	-	43.1	57.8	58	1390
-	(767)	880	84.7	-	66.4	75.7	93	-	388	388	410	71.4	-	41.8	56.8	56	1330
-	(757)	860	84.4	-	65.9	75.3	92	-	375	375	396	70.6	-	40.4	55.7	54	1270
-	(745)	840	84.1	-	65.3	74.8	91	-	363	363	383	70.0	-	39.1	54.6	52	1220
-	(733)	820	83.8	-	64.7	74.3	90	-	352	352	372	69.3	(110.0)	37.9	53.8	51	1180
-	(722)	800	83.4	-	64.0	73.8	88	-	341	341	360	68.7	(109.0)	36.6	52.8	50	1130
-	(712)	-	-	-	-	-	-	-	331	331	350	68.1	(108.5)	35.5	51.9	48	1095
-	(710)	780	83.0	-	63.3	73.3	87	-	321	321	339	67.5	(108.0)	34.3	51.0	47	1060
-	(698)	760	82.6	-	62.5	72.6	86	-	-	-	-	-	-	-	-	-	-
-	(684)	740	82.2	-	61.8	72.1	-	-	311	311	328	66.9	(107.5)	33.1	50.0	46	1025
-	(682)	737	82.2	-	61.7	72.0	84	-	302	302	319	66.3	(107.0)	32.1	49.3	45	1005
-	(670)	720	81.8	-	61.0	71.5	83	-	293	293	309	65.7	(106.0)	30.9	48.3	43	970
-	(656)	700	81.3	-	60.1	70.8	-	-	285	285	301	65.3	(105.5)	29.9	47.6	-	950
-	(653)	697	81.2	-	60.0	70.7	81	-	277	277	292	64.6	(104.5)	28.8	46.7	41	925
-	(647)	690	81.1	-	59.7	70.5	-	-	269	269	284	64.1	(104.0)	27.6	45.9	40	895
-	(638)	680	80.8	-	59.2	70.1	80	-	262	262	276	63.6	(103.0)	26.6	45.0	39	875
-	630	670	80.6	-	58.8	69.8	-	-	255	255	269	63.0	(102.0)	25.4	44.2	38	850
-	627	667	80.5	-	58.7	69.7	79	-	248	248	261	62.5	(101.0)	24.2	43.2	37	825
-	-	677	80.7	-	59.1	70.0	-	-	241	241	253	61.8	100.0	22.8	42.0	36	800
-	601	640	79.8	-	57.3	68.7	77	-	235	235	247	61.4	99.0	21.7	41.4	35	785
-	-	640	79.8	-	57.3	68.7	-	-	229	229	241	60.8	98.2	20.5	40.5	34	765
-	-	640	79.8	-	57.3	68.7	-	-	223	223	234	-	97.3	(18.8)	-	-	-
-	578	615	79.1	-	56.0	67.7	75	-	217	217	228	-	96.4	(17.5)	-	33	725
-	-	607	78.8	-	55.6	67.4	-	-	212	212	222	-	95.5	(16.0)	-	-	705
-	555	591	78.4	-	54.7	66.7	73	2055	207	207	218	-	94.6	(15.2)	-	32	690
-	-	579	78.0	-	54.0	66.1	-	2015	201	201	212	-	93.8	(13.8)	-	31	675
-	534	569	77.8	-	53.5	65.8	71	1985	197	197	207	-	92.8	(12.7)	-	30	655
-	-	553	77.1	-	52.5	65.0	-	1915	192	192	202	-	91.9	(11.5)	-	29	640
-	514	547	76.9	-	52.1	64.7	70	1890	187	187	196	-	90.7	(10.0)	-	-	620
(495)	-	539	76.7	-	51.6	64.3	-	1855	183	183	192	-	90.0	(9.0)	-	28	615
-	495	528	76.3	-	51.0	63.8	68	1820	179	179	188	-	89.0	(8.0)	-	27	600
(477)	-	516	75.9	-	50.3	63.2	-	1780	174	174	182	-	87.8	(6.4)	-	-	585
-	477	508	75.6	-	49.6	62.7	-	1740	170	170	178	-	86.8	(5.4)	-	26	570
(461)	-	495	75.1	-	48.8	61.9	-	1680	167	167	175	-	86.0	(4.4)	-	-	560
-	461	491	74.9	-	48.5	61.7	-	1670	163	163	171	-	85.0	(3.3)	-	25	545
-	-	474	74.3	-	47.2	61.0	-	1595	156	156	163	-	82.9	(0.9)	-	-	525
-	444	472	74.2	-	47.1	60.8	-	1585	149	149	156	-	80.8	-	-	23	505
-	444	472	74.2	-	47.1	60.8	63	1585	143	143	150	-	78.7	-	-	22	490
-	-	474	74.3	-	47.2	61.0	-	1595	137	137	143	-	76.4	-	-	21	460
-	-	491	74.9	-	48.5	61.7	-	1670	131	131	137	-	74.0	-	-	-	450
-	-	491	74.9	-	48.5	61.7	65	1670	126	126	132	-	72.0	-	-	20	435
-	-	474	74.3	-	47.2	61.0	-	1595	121	121	127	-	69.8	-	-	19	415
-	-	472	74.2	-	47.1	60.8	-	1585	116	116	122	-	67.6	-	-	18	400
-	-	472	74.2	-	47.1	60.8	63	1585	111	111	117	-	65.7	-	-	15	385

Note :

*1: This table is based on AMS Metals Handbook, the 8th Edition, Volume 1, and includes some information added to "Approx. tensile strength (MPa)," such as the values calculated in metric; and Brinell hardness that exceeds recommended values.

*2: 1 MPa = 1 N/mm²

*3: Figures in () are not commonly used. It's just reference.

User's Guide - Technical Reference

Surface Roughness

(According to JIS B 0601, 2001 and its explanation.)

Type	Symbol	How to determine	Example (Fig.)
Arithmetic mean roughness	Ra	<p>Ra means the value obtained by the following formula and expressed in micrometer (μm) when sampling only the reference length from the roughness curve in the direction of mean line, taking X-axis in the direction of mean line and Y-axis in the direction of longitudinal magnification of this sampled part and the roughness curve is expressed by $y = f(x)$:</p> $Ra = \frac{1}{\ell} \int_0^{\ell} f(x) dx$ <p>where, ℓ : reference length</p>	
Maximum height	Rz	<p>Rz shall be that only the reference length is sampled from the roughness curve in the direction of mean line, the distance between the top of profile peak line and the bottom of profile valley line on this sampled portion is measured in the longitudinal magnification direction of roughness curve and the obtained value is expressed in micrometer (μm).</p> $Rz = Rp + Rv$	
Ten point mean roughness	Rz_{JIS}	<p>Rz_{JIS} shall be that only the reference length is sampled from the roughness curve in the direction of its mean line, the sum of the average value of absolute values of the heights of five highest profile peaks (Zp) and the depths of five deepest profile valleys (Zv) measured in the vertical magnification direction from the mean line of this sampled portion and this sum is expressed in micrometer (μm)</p> $Rz_{JIS} = \frac{ Zp1 + Zp2 + Zp3 + Zp4 + Zp5 + Zv1 + Zv2 + Zv3 + Zv4 + Zv5 }{5}$	<p>where, $Zp1, Zp2, Zp3, Zp4, Zp5$: altitudes of the heights of five highest profile peaks of the sampled portion corresponding to the reference length ℓ</p> <p>where, $Zv1, Zv2, Zv3, Zv4, Zv5$: altitudes of the depths of five deepest profile valleys of the sampled portion corresponding to the reference length ℓ</p>

Grade
Insert
Toolholder
Ext. Toolholder
Int. Toolholder
Threading
Grooving
Miniature Tool
Endmill
Drilling Tool
Tooling System
Index



Alphanumeric --- Index



Alphanumeric Index

Designation	Product name	Page
1/4HEX	Wrench / Driver	L026
1/8-28	Screw	L008
1/8HEX	Wrench / Driver	L026
104...	Master shanks to ANSI B5.50	K150
10ER/L...	Positive insert for back turning	B166, G066
11ER□□ISO	ISO metric threading insert	E016
11ERA55	55° angle threading insert	E014
11ERA60	60° angle threading insert	E010
11IR/L□□ISO	ISO metric threading insert	E016
11IR/LA60	60° angle threading insert	E010
11IR□□ISO-B	ISO metric threading insert	E017
11IR□□ISO-M	ISO metric threading insert	E017
11IR□□PT	BSPT threading insert	E021
11IR□□UN	Unified threading insert	E018
11IR□□W	Whitworth threading insert	E020
11IR10MJ	MJ threading insert	E025
11IRA55	55° angle threading insert	E014
11IRA60-B	60° angle threading insert	E010
11IRA60-M	60° angle threading insert	E010
144...	Master shank holders DIN 69893	K151
154...	Master shanks to ISO 26623-1	K149
15GR/L...	Internal grooving insert	F161
164...	SwissBore extension adapter	K152
16D.RINGSEMC	Driving ring	K134
16ER/L□□ISO	ISO metric threading insert	E016
16ER/L□□W	Whitworth threading insert	E020
16ER/L□60	60° angle threading insert	E010
16ER□□ACME	29° Trapezoidal threading insert	E026
16ER□□ISO-B	ISO metric threading insert	E017
16ER□□ISO-M	ISO metric threading insert	E017
16ER□□NPT	NPT threading insert	E022
16ER□□NPT-B	NPT threading insert	E022
16ER□□NPT-M	NPT threading insert	E022
16ER□□NPTF	NPTF threading insert	E023
16ER□□PT	BSPT threading insert	E021
16ER□□PT-B	BSPT threading insert	E021
16ER□□PT-M	BSPT threading insert	E021
16ER□□RAPI	API Round threading insert	E027
16ER□□RD-CB	API Round threading insert	E027
16ER□□TR	30° Trapezoidal threading insert	E024
16ER□□UN	Unified threading insert	E018
16ER□□UN-B	Unified threading insert	E019
16ER□□UN-M	Unified threading insert	E019
16ER□□UNJ	UNJ threading insert	E025
16ER□□W-B	Whitworth threading insert	E020
16ER□□W-M	Whitworth threading insert	E020
16ER□RD-B	Round threading insert	E024
16ER□STACME	29° Trapezoidal threading insert	E026
16ER□TPI29	29° Trapezoidal threading insert	E026
16ER□W	Whitworth threading insert	E020
16ERA55	55° angle threading insert	E014
16ERA60-B	60° angle threading insert	E010
16ERA60-M	60° angle threading insert	E010
16ERAG55	55° angle threading insert	E014
16ERAG55-B	55° angle threading insert	E014
16ERAG60	60° angle threading insert	E010
16ERAG60-B	60° angle threading insert	E010
16ERAG60-M	60° angle threading insert	E010
16ERG55	55° angle threading insert	E014
16ERG55-B	55° angle threading insert	E014
16ERG60-B	60° angle threading insert	E010
16ERG60-M	60° angle threading insert	E010
16IR/L□□ISO	ISO metric threading insert	E016
16IR/LA60	60° angle threading insert	E010
16IR/LG60	60° angle threading insert	E010
16IR□□ACME	29° Trapezoidal threading insert	E026
16IR□□ISO-B	ISO metric threading insert	E017
16IR□□ISO-M	ISO metric threading insert	E017
16IR□□NPT	NPT threading insert	E022
16IR□□NPT-B	NPT threading insert	E022
16IR□□NPT-M	NPT threading insert	E022
16IR□□NPTF	NPTF threading insert	E023
16IR□□PT	BSPT threading insert	E021
16IR□□PT-B	BSPT threading insert	E021

Designation	Product name	Page
16IR□□PT-M	BSPT threading insert	E021
16IR□□RAPI	API Round threading insert	E027
16IR□□RD-CB	API Round threading insert	E027
16IR□□TR	30° Trapezoidal threading insert	E024
16IR□□UN	Unified threading insert	E018
16IR□□UN-B	Unified threading insert	E019
16IR□□UN-M	Unified threading insert	E019
16IR□□W	Whitworth threading insert	E020
16IR□□W-B	Whitworth threading insert	E020
16IR□□W-M	Whitworth threading insert	E020
16IR□STACME	29° Trapezoidal threading insert	E026
16IR□TPI29	29° Trapezoidal threading insert	E026
16IR□W	Whitworth threading insert	E020
16IR6RD-B	Round threading insert	E024
16IRA55	55° angle threading insert	E014
16IRA60-B	60° thread angle threading insert	E010
16IRA60-M	60° thread angle threading insert	E010
16IRAG55	55° angle threading insert	E014
16IRAG55-B	55° angle threading insert	E014
16IRAG60	60° thread angle threading insert	E010
16IRAG60-B	60° thread angle threading insert	E010
16IRAG60-M	60° thread angle threading insert	E010
16IRG55	55° angle threading insert	E014
16IRG55-B	55° angle threading insert	E014
16IRG60-B	60° angle threading insert	E010
16IRG60-M	60° angle threading insert	E010
184...	SwissBore reduction adapter	K153
1QP-CCGW...	CBN insert, mini, positive	B183
1QP-CCMT...	PCD insert, 80° rhombic Positive	B196
1QP-CNMM...	PCD insert, 80° rhombic Negative	B194
1QP-EPGW...	Mini positive CBN insert	B186
1QP-SECW12X4ZETR-B	TFE insert	H083
1QP-SECW12X4ZETR-W	TFE insert	H083
1QP-TFMT...	PCD insert, 60° Triangular Positive	B196
1QP-TNMM...	PCD insert, 80° rhombic Negative	B194
2□D.RINGSEMC	Driving ring	K134
206.064.025.045	SwissBore digital fine boring head	K144
22ER/LN60	60° angle threading insert	E010
22ER□□ISO	ISO metric threading insert	E017
22ER□□ISO-B	ISO metric threading insert	E017
22ER□□TR	30° Trapezoidal threading insert	E024
22ER□□ACME	29° Trapezoidal threading insert	E026
22ER□TPI29	29° Trapezoidal threading insert	E026
22ER□UN	Unified threading insert	E018
22ER□W	Whitworth threading insert	E020
22ER5BAPI	API Buttress threading insert	E029
22ERN55	55° angle threading insert	E014
22ERN60-B	60° angle threading insert	E010
22IR/LN60	60° angle threading insert	E010
22IR□□ISO	ISO metric threading insert	E017
22IR□□TR	30° Trapezoidal threading insert	E024
22IR□□ACME	29° Trapezoidal threading insert	E026
22IR□TPI29	29° Trapezoidal threading insert	E026
22IR□UN	Unified threading insert	E018
22IR□W	Whitworth threading insert	E020
22IR5BAPI	API Buttress threading insert	E029
22IR8RAPI-2T	API Round threading insert	E027
22IRN55	55° angle threading insert	E014
22IRN60-B	60° angle threading insert	E010
254...	TungCap boring bar	K047, K145
256...	TungCap boring bar	K048, K145
27ER60ISO	ISO metric threading insert	E017
27ER60TR	30° Trapezoidal threading insert	E024
27ERZ60	60° angle threading insert	E010
27IR60ISO	ISO metric threading insert	E017
27IRZ60	60° angle threading insert	E010
2QP-CCGT□□-HP	CBN insert, G-class	B182
2QP-CCGT□□WL-HP	CBN insert, G-class	B182
2QP-CCGW...	CBN insert, G-class	B182
2QP-CCGW□□-H	CBN insert, G-class	B182
2QP-CCGW□□-L	CBN insert, G-class	B182
2QP-CCGW□□-LC	CBN insert, G-class	B182
2QP-CCGW□□-LF	CBN insert, G-class	B182
2QP-CCGW□□-WL	CBN insert, G-class	B182

Grade
Insert
Toolholder
Ext. Toolholder
Int. Toolholder
Threading
Grooving
Tool
Miniature Tool
Milling Cutter
Endmill
Drilling Tool
Tooling System
User's Guide
Index



Alphanumeric Index

Designation	Product name	Page
2QP-CCMW...	CBN insert, M-class	B183
2QP-CNGA...	CBN insert	B172
2QP-CNGA□□-H	CBN insert	B172
2QP-CNGA□□-L	CBN insert	B172
2QP-CNGA□□-LC	CBN insert	B172
2QP-CNGA□□-LF	CBN insert	B172
2QP-CNGA□□F	CBN insert	B172
2QP-CNGA□□WL	CBN insert	B172
2QP-CNGM□□-HF	CBN insert	B173
2QP-CNGM□□-HM	CBN insert	B173
2QP-CNGM□□-HP	CBN insert	B173
2QP-CNGM□□WL-HP	CBN insert	B173
2QP-CNMA□□W	CBN insert	B172
2QP-CPGW...	CBN insert, G-class	B183
2QP-DCGT□□-HP	CBN insert, G-class	B184
2QP-DCGW...	CBN insert, G-class	B184
2QP-DCGW□□-H	CBN insert, G-class	B184
2QP-DCGW□□-L	CBN insert, G-class	B184
2QP-DCGW□□-LC	CBN insert, G-class	B184
2QP-DCGW□□-LF	CBN insert, G-class	B184
2QP-DCGW□□F	CBN insert, G-class	B185
2QP-DCGW11T...	CBN insert, G-class	B184
2QP-DCMW...	CBN insert, M-class	B185
2QP-DNGA...	CBN insert	B174
2QP-DNGA□□-H	CBN insert	B174
2QP-DNGA□□-L	CBN insert	B174
2QP-DNGA□□-LC	CBN insert	B174
2QP-DNGA□□-LF	CBN insert	B174
2QP-DNGA□□WJ	CBN insert	B174
2QP-DNGM□□-H	CBN insert	B175
2QP-DNGM□□-HF	CBN insert	B175
2QP-DNGM□□-HM	CBN insert	B175
2QP-DNGM□□-HP	CBN insert	B175
2QP-GNGA...	CBN insert	B176
2QP-GNGA□□-H	CBN insert	B176
2QP-GNGA□□-L	CBN insert	B176
2QP-GNGA□□-LC	CBN insert	B176
2QP-GNGA□□-LF	CBN insert	B176
2QP-GNGG□□-HP	CBN insert	B176
2QP-SECW12X412ZETR	TFE insert	H083
2QP-SNGA...	CBN insert	B177
2QP-SNGA□□-H	CBN insert	B177
2QP-SNGA□□-L	CBN insert	B177
2QP-SNGA□□-LF	CBN insert	B177
2QP-SNGN...	CBN insert	B177
2QP-SPGN...	CBN insert, G-class	B186
2QP-SPGW...	CBN insert, G-class	B186
2QP-SPMN...	CBN insert, M-class	B186
2QP-VBGT□□-HP	CBN insert, G-class	B192
2QP-VBGW...	CBN insert, G-class	B191
2QP-VBGW□□-H	CBN insert, G-class	B191
2QP-VBGW□□-L	CBN insert, G-class	B191
2QP-VBGW□□-LC	CBN insert, G-class	B191
2QP-VBGW□□-LF	CBN insert, G-class	B191
2QP-VBMW...	CBN insert, M-class	B191
2QP-VCGW...	CBN insert, G-class	B192
2QP-VCGW□□-H	CBN insert, G-class	B192
2QP-VCMW...	CBN insert, M-class	B192
2QP-VNGA...	CBN insert	B180
2QP-VNGA□□-H	CBN insert	B180
2QP-VNGA□□-L	CBN insert	B180
2QP-VNGA□□-LC	CBN insert	B180
2QP-VNGA□□-LF	CBN insert	B180
2QP-VNGM□□-HF	CBN insert	B180
2QP-VNGM□□-HM	CBN insert	B180
2QP-VNGM□□-HP	CBN insert	B180
3/32HEX	Wrench / Driver	L026
305...	SwissBore digital fine boring head	K146
30S□□□□R/L	My-T Series face grooving and turning blade	F194 - F197
314...	SwissBore insert holder, 90° corner	K049, K147, K148
32D.RINGSEMC	Driving ring	K134
3QP-TCGW...	CBN insert, G-class	B189
3QP-TNGA...	CBN insert	B178

Designation	Product name	Page
3QP-TNGA□□-H	CBN insert	B178
3QP-TNGA□□-L	CBN insert	B178
3QP-TNGA□□-LC	CBN insert	B178
3QP-TNGA□□-LF	CBN insert	B178
3QP-TNGA□□F	CBN insert	B178
3QP-TNGA□□WG	CBN insert	B178
3QP-TNGM□□-HF	CBN insert	B178
3QP-TNGM□□-HM	CBN insert	B178
3QP-TNGM□□-HP	CBN insert	B178
3QP-TPGN...	CBN insert, G-class	B187
3QP-TPGT...	CBN insert, G-class	B189
3QP-TPGW...	CBN insert, G-class	B188
3QP-TPGW□□-H	CBN insert, G-class	B188
3QP-TPGW□□-L	CBN insert, G-class	B188
3QP-TPGW□□-LC	CBN insert, G-class	B188
3QP-TPGW□□-LF	CBN insert, G-class	B188
3QP-TPGW□□F	CBN insert, G-class	B188
3QP-TPMN...	CBN insert, M-class	B187
3QP-TPMW...	CBN insert, M-class	B189
3QP-WNGA...	CBN insert	B181
3QP-WNGA□□-H	CBN insert	B181
3QP-WNGA□□-L	CBN insert	B181
3QP-WNGA□□-LF	CBN insert	B181
3QP-WNGA□□WL	CBN insert	B181
40D.RINGSEMC	Driving ring	K134
40D□□□□R/L	My-T Series face grooving and turning blade	F194 - F197
40S□□□□R/L	My-T Series face grooving and turning blade	F194 - F197
4QP-CNGA...	CBN insert	B173
4QP-CNMA□□W	CBN insert	B173
4QP-DNGA...	CBN insert	B175
4QP-SNGA...	CBN insert	B177
4QP-VNGA...	CBN insert	B180
4QS-CNGA...	CBN insert	B173
4QS-CNGA□□-H	CBN insert	B173
4QS-CNGG□□-HM	CBN insert	B173
4QS-DNGA...	CBN insert	B175
4QS-DNGA□□-H	CBN insert	B175
4QS-DNGG□□-HM	CBN insert	B175
4QS-VNGA...	CBN insert	B180
4QS-VNGA□□-H	CBN insert	B180
4QS-VNGG□□-HM	CBN insert	B180
5/32HEX	Wrench / Driver	L026
50D.RINGSEMC	Driving ring	K134
50D□□□□R/L	My-T Series face grooving and turning blade	F194 - F197
50S□□□□R/L	My-T Series face grooving and turning blade	F194 - F197
6GMR...	Internal grooving insert	F160
6GR/L...	Internal grooving insert	F161
6IR□□ISO	ISO metric threading insert	E016
6IR18NPT	NPT threading insert	E022
6IR19PT	BSPT threading insert	E021
6IR19W	Whitworth threading insert	E020
6IRA55	55° angle threading insert	E014
6IRA60	60° angle threading insert	E010
6QP-TNGA...	CBN insert	B179
6QP-WNGA...	CBN insert	B181
6QS-TNGA...	CBN insert	B179
6QS-TNGA□□-H	CBN insert	B179
6QS-TNGG□□-HM	CBN insert	B179
6QS-WNGA...	CBN insert	B181
6QS-WNGA□□-H	CBN insert	B181
7GMR...	Internal grooving insert	F160
7GR/L...	Internal grooving insert	F161
8GMR...	Internal grooving insert	F160
8GR/L...	Internal grooving insert	F161
9GMR...	Internal grooving insert	F160
9GR/L...	Internal grooving insert	F161

A

A□□-ACLNR/L33-...	ISOEco-Turn boring bar, steel shank	D028
A□□-ACLNR/L4-...	TurningA boring bar, steel shank	D031
A□□-ADUNR/L33-...	ISO-EcoTurn boring bar, steel shank	D062
A□□-ADUNR/L4-...	TurningA boring bar, steel shank	D065
A□□-ASKNR/L4-...	TurningA boring bar, steel shank	D048
A□□-ATFNR/L3-...	TurningA boring bar, steel shank	D055

Alphanumeric Index

Designation	Product name	Page
A□□-AVUNR/L3-...	TurningA boring bar, steel shank	D082
A□□-AWLNR/L□-...	TurningA boring bar, steel shank	D039
A□□-AWLNR/L33-...	ISO-EcoTurn boring bar, steel shank	D036
A□□-FLER/L□	TungT-Clamp internal grooving and threading toolholder	E050, F143
A□□-FLER/LT3	TungT-Clamp internal grooving and threading toolholder	F143
A□□-PVUNR/L□.□□-...	ISO-EcoTurn boring bar, steel shank	D080
A□□-SCLCR/L□-...	StreamJet-Bar boring bar, steel shank	D022, D023
A□□-SCLPR/L□-...	StreamJet-Bar boring bar, steel shank	D025, D026
A□□-SDQCR/L□-...	StreamJet-Bar boring bar, steel shank	D085
A□□-SDUCR/L...	StreamJet-Bar boring bar, steel shank	D058
A□□-SDXXR/L□-...	MiniForce-Turn boring bar, steel shank	D042
A□□-SDZCR/L□-...	StreamJet-Bar boring bar, steel shank	D094
A□□-SDZXR/L□-...	MiniForce-Turn boring bar, steel shank	D093
A□□-SEXPR/L□□-...	StreamJet-Bar boring bar, steel shank	D040
A□□-STUPR/L...	StreamJet-Bar boring bar, steel shank	D066, D067
A□□-SVJBR/L□-...	StreamJet-Bar boring bar, steel shank	D043
A□□-SVJCR/L□-...	StreamJet-Bar boring bar, steel shank	D044
A□□-SVQBR/L□-...	StreamJet-Bar boring bar, steel shank	D088
A□□-SVQCR/L□-...	StreamJet-Bar boring bar, steel shank	D090
A□□-SVUBR/L□-...	StreamJet-Bar boring bar, steel shank	D072
A□□-SVUCR/L□-...	StreamJet-Bar boring bar, steel shank	D076
A□□-SVZBR/L□-...	StreamJet-Bar boring bar, steel shank	D098
A□□-SVZCR/L□-...	StreamJet-Bar boring bar, steel shank	D099
A□□-SWLXR/L□-...	MiniForce-Turn boring bar, steel shank	D034
A□□-SYQBR/L□-...	Y-Pro Series boring bar, steel shank	D092
A□□-SYUBR/L□-...	Y-Pro Series boring bar, steel shank	D084
A□□□-CGTR/L□□□	My-T Series internal grooving toolholder	F136
A□□□-PCLNR/L□□-...	StreamJet-Bar boring bar, steel shank	D029
A□□□-PCLNR/L0904-...	ISOEco-Turn boring bar, steel shank	D028
A□□□-PDUNR/L...	StreamJet-Bar boring bar, steel shank	D063
A□□□-PDZNR/L15-...	StreamJet-Bar boring bar, steel shank	D095
A□□□-PSKNR/L12-...	StreamJet-Bar boring bar, steel shank	D047
A□□□-PTFNR/L1104-...	ISO-EcoTurn boring bar, steel shank	D052
A□□□-PTFNR/L16-...	StreamJet-Bar boring bar, steel shank	D053
A□□□-PTUNR/L□□-...	StreamJet-Bar boring bar, steel shank	D070
A□□□-PTUNR/L1104-...	ISO-EcoTurn boring bar, steel shank	D069
A□□□-PVUNR/L16-...	StreamJet-Bar boring bar, steel shank	D081
A□□□-PWLNR/L□□-...	StreamJet-Bar boring bar, steel shank	D037
A□□□-PWLNR/L0604-...	ISO-EcoTurn boring bar, steel shank	D035
A□□□-SDQPR/L07-...	StreamJet-Bar boring bar, special alloy steel	D087
A□□□-SDUPR/L07-...	StreamJet-Bar boring bar, special alloy steel	D059
A□□□-SEZPR/L03-...	StreamJet-Bar boring bar, steel shank	D097
A□□□-SNGR...	Internal grooving toolholder	F158
A□□□-SSKPR□□-...	StreamJet-Bar boring bar, steel shank	D045
A□□□-STFCR/L1103-...	StreamJet-Bar boring bar, steel shank	D049
A□□□-STFPR/L...	StreamJet-Bar boring bar, steel shank	D050
A□□□-SWUBR/L03-...	StreamJet-Bar boring bar, steel shank	D083
A16-1	Shim	L013
A16-1DT	Shim	L013
A20Q-PDUNR/L1104-D250	ISO-EcoTurn boring bar, steel shank	D062
A32S-PTUNR/L16	Boring bar, steel shank	D071
ACKNR/L□□□...	TurningA external toolholder	C116
ACLNR/L□□□...	ISO-EcoTurn / TurningA external toolholder	C018, C020
ACP...	Clamp	L016
ACRNR/L□□□...	TurningA external toolholder	C100
ACS...	Screw	L008
ADJC□ER32	TungCap ER collet chuck holder with center alignment	K036
ADJCAT□□D2.756ER32	ER collet chuck holder with center alignment	K090
ADJHSKA□□D70ER32	ER collet chuck holder with center alignment	K075
ADJNR/L...	ISO-EcoTurn/TurningA toolholder	C040, C046
ADJST□□D70ER32	ER collet chuck holder with center alignment	K099
ADPNN...	TurningA external toolholder	C076
ADQNR/L...	ISO-EcoTurn/TurningA toolholder	C125, C126
AE16-...	Shim	L013
AE16-□DT	Shim	L013
AH110	PVD coated grade	A003
AH120	PVD coated grade	A003
AH130	PVD coated grade	A003
AH140	PVD coated grade	A003
AH170	PVD coated grade	A003
AH180	PVD coated grade	A003
AH3035	PVD coated grade	A004
AH3135	PVD coated grade	A004
AH3225	PVD coated grade	A004

Designation	Product name	Page
AH330	PVD coated grade	A003
AH4035	PVD coated grade	A004
AH6030	PVD coated grade	A004
AH630	PVD coated grade	A003
AH645	PVD coated grade	A003
AH7025	PVD coated grade	A003
AH710	PVD coated grade	A003
AH725	PVD coated grade	A003
AH730	PVD coated grade	A003
AH740	PVD coated grade	A003
AH750	PVD coated grade	A003
AH8005	PVD coated grade	A003
AH8015	PVD coated grade	A003
AH9030	PVD coated grade	A004
AH905	PVD coated grade	A003
AH9130	PVD coated grade	A004
AJC08	Wrench / Driver	L027
AJM...	Screw	L005, L029
AJM5	Fine adjusting screw	L005, L029
AN16-...	Shim	L013
AN16-□DT	Shim	L013
AOGT□□□□□PDFR-AJ	TungRec insert	H117, H127
AOMT□□□□□PDP-MJ	TungRec insert	H117, H127
AOMT030204-N-□□DT	DrillMeister insert for special chamfering tool	J023
AOMT060204-C45	DrillMeister insert for special chamfering tool	J023
AOMT070208PDPH-HJ	TungRec insert	H117
AP...	Shim	L024
ARGNR/L...	TurningA external toolholder	C084
ASBNR/L...	TurningA external toolholder	C098
ASC...	Shim	L011
ASD...	Shim	L011
ASDNN...	TurningA external toolholder	C108
ASG□□N...	TungMini-Slit side cutter	H151
ASGT11T□□□PDFR-AJ	TungRec insert	H123
ASKNR/L...	TurningA external toolholder	C115
ASM...	Screw	L005, L029
ASMT11T□□□PDPH-MJ	TungRec insert	H123
ASMT11T304PDPH-MS	TungRec insert	H123
ASN□□R□□□M...	TecTangential-Slot axial drive slot mill	H159
ASR420	Shim	L012
ASS...	Shim	L010
ASSNR/L...	TurningA external toolholder	C112
AST...	Shim	L009
ASV...	Shim	L012
ASV□□N...	TungThin-Slit axial drive slot mill	H155
ASW□□N...	TungUniversal-Slot axial drive slot mill	H157
ASW□□22	Shim	L012
AT9530	PVD coated cermet grade	A005
ATFNR/L...	TurningA external toolholder	C122
ATGNR/L...	TurningA external toolholder	C091
ATJNR/L...	TurningA external toolholder	C055
ATQNR/L...	TurningA external toolholder	C130
AVGT060□□□PBER-MJ	TungForce-Rec insert	H114
AVGT060□□□PBER-AJ	TungForce-Rec insert	H114
AVJNR/L...	ISO-EcoTurn/TurningA external toolholder	C057, C062
AVQNR/L...	ISO-EcoTurn/TurningA external toolholder	C131, C132
AVVNN...	ISO-EcoTurn/TurningA external toolholder	C072, C073
AWLNR/L...	ISO-EcoTurn/TurningA external toolholder	C031, C037
B		
B-CER/L□□□16	External threading toolholder for Swiss lathes	E033, F087, G106
B-SER□□□16	External threading toolholder for Swiss lathes	E033, G106
B11 R/L-5	Breaker piece	L021
BBB...	BBB2000 CBN ball nose endmill	H188
BC-SER12K16	External threading toolholder for Swiss lathes	E035, G107
BHM...	Screw	L004
BLC□□-...	Sleeve for boring bar	D104
BLD IP□□/M7	Wrench / Driver	L026
BLD IP□□/S7	Wrench / Driver	L026
BLD T10/S7	Wrench / Driver	L026
BLM□□-...	Sleeve for boring bar	D102, D103
BLS16-...	Sleeve for boring bar	D103
BP-...	Pin	L020

Grade
Insert
Toolholder
Ext. Toolholder
Int. Toolholder
Threading
Grooving
Tool
Miniature Tool
Milling Cutter
Endmill
Drilling Tool
System
User's Guide
Index

Alphanumeric Index

Designation	Product name	Page
BP-5-A	Spring	L022
BSP-1	Spring	L022
BT□□M	Wrench / Driver	L026
BT□□S	Wrench / Driver	L026
BT4-FBHO-DE-1690	TungCap digital boring head	K047
BTU-...	Brazed drill head for STS	J146, J147
BX310	CBN grade	A006
BX330	CBN grade	A006
BX360	CBN grade	A006
BX380	CBN grade	A006
BX470	CBN grade	A006
BX480	CBN grade	A006
BX530	CBN grade	A006
BX815	CBN grade	A006
BX850	CBN grade	A006
BX870	CBN grade	A006
BX910	CBN grade	A006
BX930	CBN grade	A006
BXA10	CBN grade	A006
BXA20	CBN grade	A006
BXC50	CBN grade	A006
BXC90 (BX90S)	CBN grade	A006
BXM10	CBN grade	A006
BXM20	CBN grade	A006
C		
C□-C□RE-□□□	TungCap reduction adapter	K045
C□-DTIR-□□□□□-D...	TungCap manual clamping unit	K051
C□-DFOFR/L...	TungCap manual clamping unit	K051
C□-DTOS□□□□R/L	TungCap manual clamping unit	K051
C□-TB-□□□	TungCap test bar	K045
C□□□-CTFPR/L...	Boring bar, carbide shank	D051
C□44-A	Shim	L011
C□ABB□□-...	TungCap adapter for boring bar	K031
C□ACLNN□□□□□-12	TungCap external/facing toolholder	K009
C□ACLNN□□□□□-12N	TungCap external/facing toolholder	K009
C□ACLNR/L□□□□□-0904N	TungCap external/facing toolholder	K008
C□ACLNR/L□□□□□-12N	TungCap external/facing toolholder	K008
C□ADE-□□R/L	TungCap adapter for external square shank	K029
C□ADES-20	TungCap adapter for external square shank	K030
C□ADI...	TungCap adapter for boring bar	K032
C□ADJNR/L□□□□□-1104N	TungCap external/profiling toolholder	K012
C□ADJNR/L□□□□□-15N	TungCap external/profiling toolholder	K012
C□ADNN□□□□□-15	TungCap external/profiling toolholder	K016
C□ADNN□□□□□-15N	TungCap external/profiling toolholder	K016
C□ADUNR□□□□□-15	TungCap internal/double-clamp toolholder	K019
C□ASHA...	TungCap adapter for external square shank	K029
C□ASHR/L...	TungCap adapter for external square shank	K029
C□ASHR/L20-45	TungCap adapter for external square shank with 45° slanted	K030
C□AVJNR/L□□□□□-1204N	TungCap external/profiling toolholder	K015
C□AVJNR/L□□□□□-16N	TungCap external/profiling toolholder	K015
C□AWLNR/L□□□□□-08N	TungCap external/facing toolholder	K011
C□CER/L□□□□□-16ER	TungCap external threading toolholder	E034, K021
C□CER/L□□□□□-16ERN	TungCap external threading toolholder	E034, K021
C□CHFVN□□□□□-CHP	TungCut TungCap adapter for high pressure coolant	F019, F041, F052, K025
C□CHFVR/L□□□□□N	TungCut adapter for blade	F022, F176, K022
C□CHSN□□□□□-CHP	TungCut adapter for blade	F019, F041, F052, K025
C□CHSR/L□□□□□N	TungCut adapter for blade	F022, F176, K022
C□EM□□X...	TungCap Side lock holder for endmill	K033
C□EM□□X□□E	TungCap Side lock holder for endmill	K034
C□EPA□□M□□□□□L...	TungCap Tung-Tri square shoulder mill	H102, K028
C□ER□□X...	TungCap collet chuck holder	K035
C□ER□□X□□□M	TungCap ER Mini collet chuck holder	K036
C□EX...	TungCap Extension adapter	K044
C□MAXIN□□X...	TungCap power chuck holder	K040
C□ODP□□X...	TungCap modular system	K039
C□PCLNR/L□□□□□-0904-CHP	TungCap external/facing toolholder with high pressure coolant nozzle	C023, K009
C□PCLNR/L□□□□□-12-CHP	TungCap external/facing toolholder with high pressure coolant nozzle	C023, K009
C□PCLNR/L□□□□□-12N	TungCap external/facing toolholder	K008
C□PCLNR□□□□□-0904	TungCap internal/facing toolholder	K018

Designation	Product name	Page
C□PCLNR□□□□□-12	TungCap internal/facing toolholder	K018
C□PDJNR/L□□□□□-1104-CHP	TungCap external/profiling toolholder with high pressure coolant nozzle	C048, K013
C□PDJNR/L□□□□□-1104-CHP	TungCap external/profiling toolholder with high pressure coolant nozzle	C048, K013
C□PDJNR/L□□□□□-15-CHP	TungCap external/profiling toolholder with high pressure coolant nozzle	C048, K013
C□PDJNR/L□□□□□-15-CHP	TungCap external/profiling toolholder with high pressure coolant nozzle	C048, K013
C□PDJNR/L□□□□□-16N	TungCap external/profiling toolholder	K012
C□PVJNR/L□□□□□-1204-CHP	TungCap external/profiling toolholder with high pressure coolant nozzle	C064
C□PVJNR/L□□□□□-16-CHP	TungCap external/profiling toolholder with high pressure coolant nozzle	C064, K015
C□PWLNR/L□□□□□-0604-CHP	TungCap external/facing toolholder with high pressure coolant nozzle	C038, K011
C□PWLNR/L□□□□□-0604-CHP	TungCap external/facing toolholder with high pressure coolant nozzle	C038, K011
C□PWLNR/L□□□□□-08-CHP	TungCap external/facing toolholder with high pressure coolant nozzle	C038, K011
C□PWLNR/L□□□□□-08-CHP	TungCap external/facing toolholder with high pressure coolant nozzle	C038, K011
C□SCA□□-□□	TungCap slot milling holder	K043
C□SCLCR□□□□□-09	TungCap internal/facing toolholder	K017
C□SDXXR□□□□□-07	TungCap internal/facing toolholder	K020
C□SEM□□□□□	TungCap shell mill holder	K038
C□SRKIN□□X□□	TungCap Thermal shrinking holder	K042
C□SVJCR/L□□□□□-11N	TungCap external/profiling toolholder	K016
C□SVJCR/L□□□□□-16	TungCap external/profiling toolholder	K016
C□SVJCR/L□□□□□-16N	TungCap external/profiling toolholder	K016
C□SVQBR/L□□□□□-11	TungCap internal/facing toolholder	K021
C□SVQBR/L□□□□□-16	TungCap internal/facing toolholder	K021
C□SVVCN□□□□□-16	TungCap external/profiling toolholder	K017
C□SVVCN□□□□□-16N	TungCap external/profiling toolholder	K017
C□TDX□□□□□L□□□-3	TungCap TungDrill-Twisted drill	J078, K027
C□TLA15M□□□□R□□□...	TungCap Tung-Tri square shoulder mill	H102, K028
C0.□□□X□□□□□H	Screw	L006
C11R/L-5	Clamp	L017
C4ADUNR□□□□□-15	TungCap internal/double-clamp toolholder	K019
C4ATJNR/L27050-16N	TungCap external toolholder	K014
C4AWLNR/L27050-0604N	TungCap external/facing toolholder	K011
C4PDUNR/L17080-11	TungCap internal toolholder	K019
C4PTJNR/L27050-1104N	TungCap external toolholder	K014
C4PWLNR/L27050-0604-CHP	TungCap lever-lock external/facing toolholder with high pressure coolant nozzle	K011
C4SWLXR11070-04	TungCap internal toolholder	K019
C5PCLNR/L35060-12	TungCap external/facing toolholder	K008
C6ACMNN□□□□-0904N	TungCap external/facing toolholder	K010
C6ACMNN□□□□-12N	TungCap external/facing toolholder	K010
C6PCLNL17100-12-CHP	TungTurn-Jet / TungCap internal toolholder with high pressure coolant nozzle	D031
C6PCLNL17100-12-CHP	TungCap internal/facing toolholder with high pressure coolant nozzle	K018
C6PCMNN00130-12-CHP	TungCap lever-lock external/facing toolholder with high pressure coolant nozzle	C140, K010
C6PDMNL00130-1104-CHP	TungCap external/profiling toolholder with high pressure coolant nozzle	C141, K013
C6PDUNL17100-1104-CHP	TungCap internal/profiling toolholder with high pressure coolant nozzle	K020, D065
C6TBK-32R/L	TungCap adapter for parting blade	K032
C8FM60X60	TungCap face mill holder	K039
CA...	Coolant supply attachment	L022
CABM□□M...	TungFlex extension	K104
CAER/L-□T...	TungCut external grooving and turning blade	F020, K023
CAER/L-□T□□-CHP	TungCut external grooving and parting blade for high pressure coolant	F016, K026
CAFR/L-□T□□-...	TungCut face grooving and turning blade	F174, K024
CAP-CM...	Screw	L006
CAT□□CF...	TungFit quick change style modular tooling system	K092
CAT□□DCJ□X...	Jacobs taper holder	K089
CAT□□EM□□X...	Screw locking endmill holders	K083, K084
CAT□□ER□□SHORT	TungShort collet chucks with CAT shank	K080
CAT□□ER□□SHORTM	TungShort collet chucks with CAT shank	K080
CAT□□ER□□X...	ER collet chucks with CAT shank	K079
CAT□□ER32CLICK...	TungClick quick change tooling system	K093
CAT□□HYDRO...	TungHydro hydraulic endmill chuck holders	K082
CAT□□MAXIN...	TungMax endmill chuck holders	K081
CAT□□MT□X...	Morse taper holder	K089
CAT□□ODPM...	TungFlex modular tooling system	K093
CAT□□SEM...	Shell mill holder	K087
CAT□□SEM□X□□□□C	Shell mill holder	K088
CAT□□SRK□□□X...	TungShrink thermal shrinking holder	K086
CAT□□SRKIN...	TungShrink thermal shrinking holder	K085
CAT□□DCJ□X...	Jacobs taper holder	K089
CAT50FM2-1/2X2.875	Face mill holder	K088
CAT50TUNGMAX3/4X4.13BIN	TungMax endmill chuck holders	K081
CBC-4□N	Breaker piece	L021
CBD-4□N	Breaker piece	L021
CBD-4□R/L	Breaker piece	L021
CBR-4□N	Breaker piece	L021
CBS-...	Breaker piece	L021

Alphanumeric Index

Designation	Product name	Page
CBS-4□N	Breaker piece	L021
CBT...	Breaker piece	L021
CCBS□□-32-U	My-T Series tool block for CCH blade	F225, F229
CCGT □□□ AL	80° rhombic, positive, ISO insert	B115
CCGT □□□ F-01	80° rhombic, positive, ISO insert	B111
CCGT □□□ F-JS	80° rhombic, positive, ISO insert	B116
CCGT □□□ FN-JS	80° rhombic, positive, ISO insert	B116
CCGT □□□ FR/L-J10	80° rhombic, positive, ISO insert	B117
CCGT □□□ FR/L-W08	80° rhombic, positive, ISO insert	B114
CCGT □□□ JS	80° rhombic, positive, ISO insert	B116
CCGT □□□ N-JS	80° rhombic, positive, ISO insert	B116
CCGT □□□ R/L	80° rhombic, positive, ISO insert	B115
CCGT □□□ R/L-W08	80° rhombic, positive, ISO insert	B113
CCGT □□□ R/L-W15	80° rhombic, positive, ISO insert	B114
CCGT □□□ R/L-W20	80° rhombic, positive, ISO insert	B114
CCGT □□□-01	80° rhombic, positive, ISO insert	B111
CCGT...	80° rhombic, positive, ISO insert	B115
CCGW...	80° rhombic, positive, ISO insert	B115
CCGW□□-DIA	PCD insert, positive with rake	B197
CCH□□-...	My-T Seires external grooving and parting blade	F229
CH32-W□□	My-T Series external grooving and parting blade	F225
CCLNR/L□□□...	DimpleFX external toolholder	C024
CCMT □□□ CM	80° rhombic, positive, ISO insert	B114
CCMT □□□ PF	80° rhombic, positive, ISO insert	B111
CCMT □□□ PM	80° rhombic, positive, ISO insert	B114
CCMT □□□ PS	80° rhombic, positive, ISO insert	B112
CCMT □□□ PSF	80° rhombic, positive, ISO insert	B111
CCMT □□□ PSS	80° rhombic, positive, ISO insert	B112
CCMT □□□ SW	80° rhombic, positive, ISO insert	B112
CCMT □□□ TM	80° rhombic, positive, ISO insert	B112
CCMT □□□ TSF	80° rhombic, positive, ISO insert	B112
CCMT □□□-23	80° rhombic, positive, ISO insert	B113
CCMT □□□-24	80° rhombic, positive, ISO insert	B113
CCMT□□-DIA	PCD insert, positive with rake	B196
CCMW...	80° rhombic, positive, ISO insert	B115
CCP4-A	Clamp	L017
CCR/L...	Clamp	L016
CDNNN□□□...	DimpleFX external toolholder	C070
CDPER□□M...	TungFlex ER collet chuck holder	K105
CDPM□□SRK□X□□	TungFlex thermal shrinking holder (for carbide shank)	K105
CDW6	Washer	L025
CER/L□□□DT	External threading toolholder	E034, F087
CER□□□□□□□T	External threading toolholder	E034, F087
CFG-□DR/L	Clamp	L017
CFG-□SR/L	Clamp	L017
CGD□□□	My-T Series grooving insert	F115
CGER/L□□□□-□T...	TungCut external deep grooving and parting toolholder	F016, G121
CGEUR/L□□□□-□T...	TungCut 45° external undercutting toolholder	F236
CGIUR/L□□-□T□□-□D□□	TungCut 45° internal undercutting toolholder	F118
CGIUR/L□□-□T□□-□D□□-15A	TungCut toolholder for aluminum wheel profiling	F118
CGP□□-□D	TungCut external deep grooving and parting blade	F209
CGP□□-□S	TungCut external deep grooving and parting blade	F209
CGP32-□D-CHP	TungCut external deep grooving and parting blade	F209
CGP32-8S-CL	TungCut external deep grooving and parting blade	F209
CGSSR/L□□□□-□□	My-T Series monoblock toolholder for external grooving and parting	F062
CGSSR/L□□□□-□□D	My-T Series monoblock toolholder for external deep grooving and parting	F062
CGWSR/L□□□	My-T Series shank for blade	F063, F198
CGWSR/L□□□-□□GR/L	My-T Series blade set for external grooving and parting	F060
CGWSR/L□□□□-CGDR/L...	My-T Series external grooving and parting toolholder	F114
CGWSR/L□□□□-FLR/L□GP	My-T Series external grooving toolholder	F111
CGWSR/L□□□□-FLR/L5TP	My-T Series face grooving and turning	F208
CGWSR/L□□□□-W□□	My-T Series monoblock toolholder for external grooving and parting	F058
CGWSR/L□□□□-W□□-L	My-T Series monoblock toolholder for external deep grooving and parting	F058
CGWSR/L□□□□-W□□GR/L	My-T Series blade set for external grooving and parting	F059
CGWSR/L□□□□-W□□GR/L-L	My-T Series blade set for external grooving and parting	F059
CGWSR□□□□-8	My-T Series external grooving and parting toolholder	F114
CGWSRL□□□	My-T Series toolholder for blade	F064, F198
CGWTR/L□□□	My-T Series toolholder for blade	F064, F199
CGWTR/L□□□-□□GL/R	My-T Series blade set for external grooving and parting	F061
CGWTR/L0040-FL/L/R3NP	Internal grooving and turning toolholder	F166
CGXR/L□□□□	Internal grooving toolholder	F162
CGXR/L16SC	Internal grooving toolholder	F162
CH44-A	Shim	L012

Designation	Product name	Page
CHFVR/L□□-CHP	TungCut shank for blade for high pressure coolant	F018, F040, F051
CHFVR/L□□-U	TungCut shank for blade	F021, F175
CHHM...	Screw	L005
CHP-HOSE-□□□□-...	TungTurn-Jet connecting hose	C142, F240
CHSNR□□□...	DimpleFX external toolholder	C111
CHSR/L□□-CHP	TungCut shank for blade for high pressure coolant	F017, F040, F051
CHSR/L□□-U	TungCut shank for blade	F020, F175
CLVOR...	External threading toolholder for chaser	E042
CM□X□□□X...	Screw	L005
CM□X□□□X□□-A	Screw	L005
CM4X0.7X20-M0-A	Screw	L005
CNGA-□□R-3E	API Round chaser insert	E028
CNGA-5B75-3E	API Round chaser insert	E030
CNGA...	80° rhombic, negative, ISO insert	B065
CNGA□□-DIA	PCD insert, negative	B195
CNGA□□-QBN	CBN insert, single-corner type	B173
CNGD...	80° rhombic, negative, ISO insert	B066
CNGG □□ R/L-C	80° rhombic, negative, ISO insert	B056
CNGG □□-01	80° rhombic, negative, ISO insert	B056
CNGG □□□ R/L-P	80° rhombic, negative, ISO insert	B062
CNGN...	80° rhombic, negative, ISO insert	B066
CNGR/L□□□15	Internal grooving toolholder	F159
CNMA □□□ W	80° rhombic, negative, ISO insert	B065
CNMA □□□E	80° rhombic, negative, ISO insert	B065
CNMA...	80° rhombic, negative, ISO insert	B065
CNMG □□□ AFW	80° rhombic, negative, ISO insert	B056
CNMG □□□ AM	80° rhombic, negative, ISO insert	B059
CNMG □□□ AS	80° rhombic, negative, ISO insert	B058
CNMG □□□ ASW	80° rhombic, negative, ISO insert	B058
CNMG □□□ CB	80° rhombic, negative, ISO insert	B058
CNMG □□□ CF	80° rhombic, negative, ISO insert	B057
CNMG □□□ CH	80° rhombic, negative, ISO insert	B064
CNMG □□□ CM	80° rhombic, negative, ISO insert	B062
CNMG □□□ DM	80° rhombic, negative, ISO insert	B060
CNMG □□□ FW	80° rhombic, negative, ISO insert	B056
CNMG □□□ HMM	80° rhombic, negative, ISO insert	B062
CNMG □□□ HRF	80° rhombic, negative, ISO insert	B058
CNMG □□□ HRM	80° rhombic, negative, ISO insert	B062
CNMG □□□ NM	80° rhombic, negative, ISO insert	B059
CNMG □□□ NS	80° rhombic, negative, ISO insert	B058
CNMG □□□ R/L-S	80° rhombic, negative, ISO insert	B063
CNMG □□□ SA	80° rhombic, negative, ISO insert	B062
CNMG □□□ SF	80° rhombic, negative, ISO insert	B057
CNMG □□□ SH	80° rhombic, negative, ISO insert	B064
CNMG □□□ SM	80° rhombic, negative, ISO insert	B062
CNMG □□□ SS	80° rhombic, negative, ISO insert	B059
CNMG □□□ SW	80° rhombic, negative, ISO insert	B058
CNMG □□□ TA	80° rhombic, negative, ISO insert	B060
CNMG □□□ TF	80° rhombic, negative, ISO insert	B056
CNMG □□□ TH	80° rhombic, negative, ISO insert	B063
CNMG □□□ THS	80° rhombic, negative, ISO insert	B063
CNMG □□□ TM	80° rhombic, negative, ISO insert	B059
CNMG □□□ TQ	80° rhombic, negative, ISO insert	B060
CNMG □□□ TS	80° rhombic, negative, ISO insert	B058
CNMG □□□ TSF	80° rhombic, negative, ISO insert	B056
CNMG □□□ ZF	80° rhombic, negative, ISO insert	B057
CNMG □□□ ZM	80° rhombic, negative, ISO insert	B060
CNMG □□□-11	80° rhombic, negative, ISO insert	B057
CNMG □□□-17	80° rhombic, negative, ISO insert	B057
CNMG □□□-27	80° rhombic, negative, ISO insert	B061
CNMG □□□-28	80° rhombic, negative, ISO insert	B061
CNMG □□□-33	80° rhombic, negative, ISO insert	B061
CNMG □□□-37	80° rhombic, negative, ISO insert	B061
CNMG □□□-38	80° rhombic, negative, ISO insert	B061
CNMG □□□E FW	80° rhombic, negative, ISO insert	B056
CNMG □□□E SM	80° rhombic, negative, ISO insert	B062
CNMG □□□E SS	80° rhombic, negative, ISO insert	B059
CNMG □□□E SW	80° rhombic, negative, ISO insert	B058
CNMG □□□E TM	80° rhombic, negative, ISO insert	B059
CNMG □□□E TSF	80° rhombic, negative, ISO insert	B056
CNMG □□□E ZF	80° rhombic, negative, ISO insert	B057
CNMG □□□E ZM	80° rhombic, negative, ISO insert	B060

Grade
Insert
Toolholder
Ext. Toolholder
Int. Toolholder
Threading
Grooving
Miniature Tool
Milling Cutter
Endmill
Drilling Tool
Tooling System
User's Guide
Index



Alphanumeric Index

Designation	Product name	Page
CNMG...	80° rhombic, negative, ISO insert	B060
CNMM □□□ TRS	80° rhombic, negative, ISO insert	B064
CNMM □□□ TU	80° rhombic, negative, ISO insert	B064
CNMM □□□ TUS	80° rhombic, negative, ISO insert	B064
CNMM □□□-57	80° rhombic, negative, ISO insert	B063
CNMM □□□-65	80° rhombic, negative, ISO insert	B064
CNMM□□-DIA	PCD insert, 80° rhombic, negative	B194
CNMN...	80° rhombic, negative, ISO insert	B066
CNR/L...	Internal grooving and threading toolholder	E038
CNZ125	Coolant parts	L023
COOLINGTUBEHSKA□□	Cooling tube for HSK	K134
CP...	Clamp	L016, L017
CP81A	Clamp	L016
CP81B	Clamp	L016
CPGA□□-DIA	PCD insert, 80° rhombic, positive	B197
CPGA□□-QBN	CBN insert, single-corner type	B183
CPGT □□□ R/L-W15	80° rhombic, positive, ISO insert	B119
CPGT □□□ R/L-W20	80° rhombic, positive, ISO insert	B119
CPK5R/L	Clamp	L017
CPMT □□□ CM	80° rhombic, positive, ISO insert	B120
CPMT □□□ PF	80° rhombic, positive, ISO insert	B118
CPMT □□□ PM	80° rhombic, positive, ISO insert	B120
CPMT □□□ PS	80° rhombic, positive, ISO insert	B118
CPMT □□□ PSF	80° rhombic, positive, ISO insert	B118
CPMT □□□ PSS	80° rhombic, positive, ISO insert	B118
CPMT □□□ TM	80° rhombic, positive, ISO insert	B118
CPMT □□□ TSF	80° rhombic, positive, ISO insert	B118
CPMT □□□-24	80° rhombic, positive, ISO insert	B119
CPMT...	80° rhombic, positive, ISO insert	B120
CPMW...	80° rhombic, positive, ISO insert	B120
CPW5	Washer	L025
CQ-1	Clamp	L017
CR-□□R-3E	Chaser insert, API Round	E028
CR-□□R-3I	Chaser insert, API Round	E028
CR-11.5NPT-4E	Chaser insert, NPT	E023
CR-11.5NPT-4I	Chaser insert, NPT	E023
CR-5B75-3E #□	Chaser insert, API Buttress	E031
CR-5B75-3I	Chaser insert, API Buttress	E030
CR-5B75-4E	Chaser insert, API Buttress	E030
CR-8NPT-4E	Chaser insert, NPT	E023
CR-8NPT-4I	Chaser insert, NPT	E023
CR-8R-3E #□	Chaser insert, API Round	E029
CRW...	Wrench / Driver	L025
CS44-A	Shim	L010
CSG-□L	Clamp set	L018
CSG-□S	Clamp set	L018
CSG-5T	Clamp set	L018
CSHB-...	Screw	L004
CSHB-□-A	Screw	L004
CSHM-3-8	Screw	L004
CSK54R/L	Shim	L012
CSL-4	Clamp set	L018
CSP-2L033	Screw	L002
CSP...	Clamp set	L018
CSPA-...	Screw	L002
CSPB-...	Screw	L003
CSPD-...	Screw	L004
CSSNR/L□□□...	DimpleFX external toolholder	C114
CST-...	Screw	L004
CSTA-...	Screw	L002
CSTA-NO...	Screw	L002
CSTB-...	Screw	L002, L004
CSTB-4.5L110P	Screw	L004
CSTC-2	Screw	L004
CSTC-4L□□□DR/L	Screw	L003
CSTD-3T	Screw	L004
CSTF-2L055-S	Screw	L004
CSTR-4L100	Screw	L004
CSW-...	Clamp set	L018
CSW-0T	Clamp set	L018
CSX20	Clamp set	L018
CSY-...	Clamp set	L018
CTBF□□-...	TungCut tool block for CGP blade	F210
CTBU□□-...	TungCut tool block for CGP/EGP blade	F210

- 1 - 9
- A - C
- D - F
- G - I
- J - L
- M - O
- P - R
- S - U
- V - X
- Y - Z

Designation	Product name	Page
CTBU□□-□□□-□-CHP	EasyMulti-Cut tool block with high pressure coolant nozzle	F169
CTBU16-32-U-CHP	TungCut tool block for high pressure coolant	F211
CTC-□R/L	Clamp	L016
CTD□	Grooving insert	F113
CTEFR/L□□-□T04	TungCut external face grooving toolholder	F013, F173
CTER/L□□-□T...	TungCut external grooving and parting toolholder	F010, F011
CTER/L□□-□T□□-CHP	TungCut external grooving toolholder for high pressure coolant	F012
CTER/L□□□□-□T□□-15A	TungCut toolholder for aluminum wheel profiling	F236
CTFR/L2525-□T□□-...	TungCut face grooving and turning toolholder	F171
CTFVR/L2525-□T□□-...	TungCut toolholder for face grooving and turning, perpendicular	F172
CTIFR/L□□-□T05-D...	TungCut face grooving toolholder	F177
CTIR/L□□-□T□□-D□□	TungCut internal grooving toolholder	F116, F117
CTS-M6	Screw	L006
CTWR/L□□□□-...	External grooving and parting toolholder	F113
CU-CW-CHP	Coolant unit	L023
CU-D-CHP	Coolant unit	L023
CU-V-CHP	Coolant unit	L023
CV34-A	Shim	L012
CVVNN□□□...	DimpleFX external toolholder	C074
CX710	Ceramic grade	A005

D

D.□□□-L□.□□-...	BoreMeister anti-vibration bar	D021, D033, D057, D061, D075, D079
D□□-D□□-□□R	Indexable threading cutter	H214
DCET □□□ MFN-JSP	55° rhombic, positive, ISO insert	B126
DCET □□□ MFR/L-JPP	55° rhombic, positive, ISO insert	B125
DCET □□□ MFR/L-JRP	55° rhombic, positive, ISO insert	B126
DCGT □□□ AL	55° rhombic, positive, ISO insert	B124
DCGT □□□ F-01	55° rhombic, positive, ISO insert	B121
DCGT □□□ FN-JS	55° rhombic, positive, ISO insert	B125
DCGT □□□ FR/L-J10	55° rhombic, positive, ISO insert	B126
DCGT □□□ N-JS	55° rhombic, positive, ISO insert	B125
DCGT □□□ R-J10	55° rhombic, positive, ISO insert	B126
DCGT □□□ R/L	55° rhombic, positive, ISO insert	B124
DCGT □□□ R/L-W10	55° rhombic, positive, ISO insert	B123
DCGT □□□ R/L-W15	55° rhombic, positive, ISO insert	B123
DCGT □□□-01	55° rhombic, positive, ISO insert	B121
DCGT...	55° rhombic, positive, ISO insert	B124
DCGW...	55° rhombic, positive, ISO insert	B124
DG□□□-DIA	PCD insert, 55° rhombic, positive	B197
DCLNR/L□□□...	D-type external toolholder	C025
DCMT □□□ CM	55° rhombic, positive, ISO insert	B123
DCMT □□□ PF	55° rhombic, positive, ISO insert	B121
DCMT □□□ PM	55° rhombic, positive, ISO insert	B123
DCMT □□□ PS	55° rhombic, positive, ISO insert	B122
DCMT □□□ PSF	55° rhombic, positive, ISO insert	B121
DCMT □□□ PSS	55° rhombic, positive, ISO insert	B122
DCMT □□□ TM	55° rhombic, positive, ISO insert	B122
DCMT □□□ TSF	55° rhombic, positive, ISO insert	B122
DCMT □□□-23	55° rhombic, positive, ISO insert	B122
DCMT □□□-24	55° rhombic, positive, ISO insert	B122
DCMT□□-DIA	PCD insert, 55° rhombic, positive	B196
DCMW...	55° rhombic, positive, ISO insert	B124
DCMW□□□□04TN	EBP insert	H184
DCPM-...	Clamp	L016
DDJNR/L□□□...	D-type external toolholder	C049
DDQNR/L□□□...	D-type external toolholder	C128
DGE□□□-...	TungCut grooving insert	F027, G128
DGG□□□-...	TungCut grooving insert	F027, F127, F184, F214, G128
DGIM2-020	TungCut grooving insert	F122
DGIS2-020	TungCut grooving insert	F122
DGL□-...	TungCut grooving insert	F026, F127, F185, F215, G129
DGM□-...	TungCut grooving insert	F023, F123, F181, F211, G125
DGS□-...	TungCut grooving insert	F025, F125, F183, F213, G124

Alphanumeric Index

Designation	Product name	Page
DLCL...	Lever	L019
DLCS...	Screw	L008
DMC...	DrillMeister head for high precision machining	J028, J029
DMP...	DrillMeister general purpose head	J024 - J027
DMXU□□□□VM	Soliddrill L/D=3 (VM type)	J058
DMXU□□□□VS	Soliddrill L/D=2 (VS type)	J057
DNGA...	55° rhombic, negative, ISO insert	B075
DNGA□□-DIA	PCD insert, 55° rhombic, negative	B195
DNGA□□-QBN	PCD insert, 55° rhombic, negative	B175
DNGD...	55° rhombic, negative, ISO insert	B075
DNGG □□□ R/L	55° rhombic, negative, ISO insert	B072
DNGG □□□ R/L-P	55° rhombic, negative, ISO insert	B073
DNGG □□□-01	55° rhombic, negative, ISO insert	B067
DNGN...	55° rhombic, negative, ISO insert	B075
DNMA □□□E	55° rhombic, negative, ISO insert	B074
DNMA...	55° rhombic, negative, ISO insert	B074
DNMG □□□ AM	55° rhombic, negative, ISO insert	B070
DNMG □□□ AS	55° rhombic, negative, ISO insert	B069
DNMG □□□ CB	55° rhombic, negative, ISO insert	B069
DNMG □□□ CF	55° rhombic, negative, ISO insert	B068
DNMG □□□ CH	55° rhombic, negative, ISO insert	B074
DNMG □□□ CM	55° rhombic, negative, ISO insert	B072
DNMG □□□ DM	55° rhombic, negative, ISO insert	B071
DNMG □□□ FW	55° rhombic, negative, ISO insert	B067
DNMG □□□ HMM	55° rhombic, negative, ISO insert	B073
DNMG □□□ HRF	55° rhombic, negative, ISO insert	B068
DNMG □□□ HRM	55° rhombic, negative, ISO insert	B073
DNMG □□□ L/R-S	55° rhombic, negative, ISO insert	B073
DNMG □□□ NM	55° rhombic, negative, ISO insert	B070
DNMG □□□ NS	55° rhombic, negative, ISO insert	B069
DNMG □□□ SA	55° rhombic, negative, ISO insert	B073
DNMG □□□ SF	55° rhombic, negative, ISO insert	B068
DNMG □□□ SH	55° rhombic, negative, ISO insert	B074
DNMG □□□ SM	55° rhombic, negative, ISO insert	B072
DNMG □□□ SS	55° rhombic, negative, ISO insert	B070
DNMG □□□ SW	55° rhombic, negative, ISO insert	B069
DNMG □□□ TF	55° rhombic, negative, ISO insert	B067
DNMG □□□ TH	55° rhombic, negative, ISO insert	B074
DNMG □□□ THS	55° rhombic, negative, ISO insert	B074
DNMG □□□ TM	55° rhombic, negative, ISO insert	B070
DNMG □□□ TQ	55° rhombic, negative, ISO insert	B071
DNMG □□□ TS	55° rhombic, negative, ISO insert	B069
DNMG □□□ ZF	55° rhombic, negative, ISO insert	B068
DNMG □□□ ZM	55° rhombic, negative, ISO insert	B071
DNMG □□□-11	55° rhombic, negative, ISO insert	B068
DNMG □□□-17	55° rhombic, negative, ISO insert	B068
DNMG □□□-27	55° rhombic, negative, ISO insert	B071
DNMG □□□-28	55° rhombic, negative, ISO insert	B072
DNMG □□□-33	55° rhombic, negative, ISO insert	B072
DNMG □□□-37	55° rhombic, negative, ISO insert	B072
DNMG □□□-38	55° rhombic, negative, ISO insert	B072
DNMG □□□-TSF	55° rhombic, negative, ISO insert	B067
DNMG □□□E FW	55° rhombic, negative, ISO insert	B067
DNMG □□□E SM	55° rhombic, negative, ISO insert	B072
DNMG □□□E SS	55° rhombic, negative, ISO insert	B070
DNMG □□□E SW	55° rhombic, negative, ISO insert	B069
DNMG □□□E TF	55° rhombic, negative, ISO insert	B067
DNMG □□□E TM	55° rhombic, negative, ISO insert	B070
DNMG □□□E ZF	55° rhombic, negative, ISO insert	B068
DNMG □□□E ZM	55° rhombic, negative, ISO insert	B071
DNMG □□□E-TSF	55° rhombic, negative, ISO insert	B067
DNMG...	55° rhombic, negative, ISO insert	B071
DNMM □□□-57	55° rhombic, negative, ISO insert	B074
DNMM□□-DIA	PCD insert, 55° rhombic, negative	B194
DNMX...	55° rhombic, negative, ISO insert	B075
DPD09...	DPD09 face mill	H085
DPIS...	Piston	L023
DPMT □□□ PS	55° rhombic, positive, ISO insert	B127
DRGNR/L□□□...	D-type external toolholder	C086
DS-...	Screw	L006
DS1100	PVD coated grade	A004
DS1200	PVD coated grade	A004
DSBNR/L□□□...	D-type external toolholder	C099
DSDNN□□□...	D-type external toolholder	C109

Designation	Product name	Page
DSE□□□□F02	GigaPowerDrill solid drill without coolant hole L/D=2	J051
DSE□□□□F03	GigaPowerDrill solid drill without coolant hole L/D=3	J052
DSKNR/L□□□...	D-type external toolholder	C118
DSM-CP140	GigaMiniDrill centering drill	J056
DSM-CP90	GigaMiniDrill centering drill	J056
DSM□□□□G□□	GigaMiniDrill small diameter solid drill	J054 - J056
DSSNR/L□□□...	D-type external toolholder	C115
DSW□□□-□□□-□□DE3	SolidDrill without coolant hole L/D=3	J039
DSW□□□-□□□-□□DE5	SolidDrill without coolant hole L/D=5	J040
DSW□□□-□□□-□□DI5	SolidDrill with coolant hole L/D=5	J041
DSW□□□-□□□-□□DI8	SolidDrill with coolant hole L/D=8	J042
DSX□□□□F03	GigaJetDrill solid drill with coolant hole L/D=3	J047
DSX□□□□F05	GigaJetDrill solid drill with coolant hole L/D=5	J048
DSX□□□□F08	GigaJetDrill solid drill with coolant hole L/D=8	J049
DSXU□□□□F03	GigaJetDrill solid drill with coolant hole L/D=3	J046
DSXU□□□□F05	GigaJetDrill solid drill with coolant hole L/D=5	J046
DTA□□□-...	TungCut grooving insert	F031, F129, F187, F219, F237
DTE□-...	TungCut grooving insert	F029, F121, F180, F216
DTE□□□-...	TungCut grooving insert	F028, F121, F179, F216
DTF□-040-R/L	TungCut grooving insert	F178
DTFNR/L□□□...	D-type external toolholder	C124
DTGNR/L□□□...	D-type external toolholder	C094
DTI□-040	TungCut grooving insert	F119
DTI□□□-...	TungCut grooving insert	F119
DTIU□□□-...	TungCut grooving insert	F031, F129, F186, F218, F237
DTM□-...	TungCut grooving insert	F028, F120, F179, F215
DTR□-...	TungCut grooving insert	F030, F128, F186, F218
DTR□□□-...	TungCut grooving insert	F030, F128, F185, F217
DTS□-...	Screw	L008
DTX□-...	TungCut grooving insert	F029, F120, F178, F217
DWLNRL□□□□...	TungTurn external / facing toolholder	C039
DX110	PCD (T-DIA) grade	A007
DX120	PCD (T-DIA) grade	A007
DX140	PCD (T-DIA) grade	A007
DX160	PCD (T-DIA) grade	A007
DX180	PCD (T-DIA) grade	A007
DXGU □□□ R/L SS	MiniForce-Turn insert, 55° rhombic, positive, double-sided	B128
DXGU □□□ R/L TS	MiniForce-Turn insert, 55° rhombic, positive, double-sided	B128
DXGU □□□MFR/L JS	MiniForce-Turn insert, 55° rhombic, positive, double-sided	B127
DXGU □□□MFR/L JSS	MiniForce-Turn insert, 55° rhombic, positive, double-sided	B128
DXGU □□□MFR/L JTS	MiniForce-Turn insert, 55° rhombic, positive, double-sided	B128
DXGU □□□MFR/LE JRP	MiniForce-Turn insert, 55° rhombic, positive, double-sided	B127
DXGU □□□MR/L JSS	MiniForce-Turn insert, 55° rhombic, positive, double-sided	B128
DXGU □□□MR/L JTS	MiniForce-Turn insert, 55° rhombic, positive, double-sided	B128

E

E□□-SCLCR/L□-...	StreamJet-Bar boring bar, carbide shank	D022, D023
E□□-SCLPR/L□-...	StreamJet-Bar boring bar, carbide shank	D025, D026
E□□-SDUCR/L...	StreamJet-Bar boring bar, carbide shank	D058
E□□-SDXXR/L□-...	MiniForce-Turn boring bar, carbide shank	D042
E□□-SEXPR/L□□-...	StreamJet-Bar boring bar, carbide shank	D040
E□□-STFCR/L□-...	StreamJet-Bar boring bar, carbide shank	D049
E□□-STFPR/L...	StreamJet-Bar boring bar, carbide shank	D050
E□□-STUPR/L...	StreamJet-Bar boring bar, carbide shank	D066, D067
E□□-SWLXR/L□-...	MiniForce-Turn boring bar, carbide shank	D034
E□□-SYQBR/L□-...	Y-Pro Series boring bar, carbide shank	D092
E□□-SYUBR/L□-...	Y-Pro Series boring bar, carbide shank	D084
E□□□-SDQCR/L□□-...	StreamJet-Bar boring bar, carbide shank	D085
E□□□-SDQPR/L07-...	StreamJet-Bar boring bar, carbide shank	D087
E□□□-SDUPR/L07-...	StreamJet-Bar boring bar, carbide shank	D059
E□□□-SDZCR/L□□-...	StreamJet-Bar boring bar, carbide shank	D094
E□□□-SDZXR/L07-...	MiniForce-Turn boring bar, carbide shank	D093
E□□□-SEZPR/L03-...	StreamJet-Bar boring bar, carbide shank	D097
E□□□-SNGR...	Internal grooving toolholder	F158

Grade
Insert
Toolholder
Ext. Toolholder
Int. Toolholder
Threading
Grooving
Miniature Tool
Milling Cutter
Endmill
Drilling Tool
Tooling System
User's Guide
Index



Alphanumeric Index

Designation	Product name	Page
E□□□-SVQBR/L□□-...	StreamJet-Bar boring bar, carbide shank	D088
E□□□-SVQCR/L□□-...	StreamJet-Bar boring bar, carbide shank	D090
E□□□-SVUBR/L□□-...	StreamJet-Bar boring bar, carbide shank	D072
E□□□-SVUCR/L□□-...	StreamJet-Bar boring bar, carbide shank	D076
E□□□-SWUBR/L03-...	StreamJet-Bar boring bar, carbide shank	D083
EA-...	Coolant supply attachment	L022
EASD05M□□□C...	TungQuad chamfering cutter	H221
EAW13R□□□M...	TungMill face endmill, shank type	H075
EBD□□□...	EBD radius ball nose endmill	H186
EBFU□□□S...	BallFinishNose endmill, shank type	H166
EBFU□□□T...	BallFinishNose endmill, shank type	H166
EBP□□□...	EBP radius ball nose endmill	H184
EBRU□□□SW...	BallRoughNose endmill, shank type	H164
ECC31...	Chamfering cutter	H218
ECP44...	Chamfering cutter	H220
ECW-456EF	Wrench / Driver	L027
ECW-456I	Wrench / Driver	L027
EDPD09063R	EDPD09 endmill, shank type	H085
EEN09R□□□U...	DoPent endmill, shank type	H070
EFE12200RU	TFE endmill, shank type	H081
EFPR/L-□-...	EasyMulti-Cut face grooving blade	F168
EGM4-030	EasyMulti-Cut grooving insert	F170
ELD05R□□□U...	TungQuad roughing endmill, shank type	H130
ELS□...	Shim	L011
ELS11R□□□U...	TungRec roughing endmill, shank type	H122
ELSD317BR/L	Shim	L012
ELSS...	Shim	L010
ELST...	Shim	L009
ELST□□□BR/L	Shim	L009
EM10	Cemented carbide grade	A007
EPA06R□□□U...	Tung-Tri endmill, shank type	H097
EPA10R□□□U...	Tung-Tri endmill, shank type	H099
EPA15R□□□U...	Tung-Tri endmill, shank type	H103
EPAV06U□□□C...	TungForce-Rec endmill, shank type	H111
EPD05R□□□U...	TungQuad endmill, shank type	H129
EPGT □□□ F-JS	75° rhombic, positive, ISO insert	B130
EPGT □□□ FL-J08	75° rhombic, positive, ISO insert	B130
EPGT □□□ FR/L-W08	75° rhombic, positive, ISO insert	B129
EPGT □□□ JS	75° rhombic, positive, ISO insert	B130
EPGT □□□ L-J08	75° rhombic, positive, ISO insert	B130
EPGT □□□ R/L-W08	75° rhombic, positive, ISO insert	B129
EPGW□□□-DIA	PCD insert, 75° rhombic, positive	B197
EPM11R□□□U...	TecMill endmill, shank type	H141
EPO07R□□□U...	TungRec endmill, shank type	H116
EPO11R□□□M...	TungRec endmill, shank type	H121
EPO18R□□□U...	TungRec endmill, shank type	H126
EPQ11R□□□U...	DoRec endmill, shank type	H137
EPS11□□□R...	TungRec endmill, shank type	H120
EPTC16U□□□W...	TungTri-Shred endmill, shank type	H109
EPTN□□□U□□□C...	DoForce-Tri endmill, shank type	H095
EPV16R□□□U...	Tung-AluMill endmill, shank type	H143
EPW13R□□□M...	TungMill endmill, shank type	H133
EPYD06...	TungSpeed-Mill endmill, shank type	H079
ER□□CF4-□	TungFit ER collet chuck adapter	K106
ER□□SEAL□□-□□	ER spring collet	K111
ER□□SEAL□□-□□JET2	ER spring collet	K112
ER□□SPR□□-□AA	ER spring collet	K110
ER□□SPR□□-□□	ER spring collet	K109
ER□□SRK□□X...	TungShrink ER collet type	K123
ER□□SRK□□X□□JET2	TungShrink ER collet type	K124
ER11SPR□□-□AA	SpinJet ER11 collet	K141
ER11SRK□□X□□	SpinJet thermal shrinking ER collet	K140
ER32ODPM□□X□□	TungFlex collet for ER collet chuck	K122
ERC□□R□□□U...	RoundSplit endmill, shank type	H178
ERP□□R□□□U...	FixRMill endmill, shank type	H172
ETFR/L□□-□T□□-...	EasyMulti-Cut face grooving and turning toolholder	F167
ETFR□□-□T□□-□□□□-CHP	EasyMulti-Cut face grooving toolholder for high pressure coolant	F167
ETLN...	Indexable threading cutter	H212
ETTL...	Indexable threading cutter	H210, H211
ETU-□□□	Brazed drill head with external 4-start thread for DTS	J148
ETX□-...	EasyMulti-Cut grooving and turning insert	F170
EVX...	Endmill with central cutting edge, shank type	H216
EWD□□□□RU	EWD05/07/10 endmill, shank type	H182
EXCF4-□	TungFit extension adapter	K106

1 - 9
A - C
D - F
G - I
J - L
M - O
P - R
S - U
V - X
Y - Z

Designation	Product name	Page
EXLN...	DoTwist-Ball endmill, shank type	H037
EXLS02...	TungForce-Feed endmill, shank type	H022
EXN03...	DoFeed endmill, shank type	H026, H027
EXN06...	DoFeed endmill, shank type	H032
EXP□□□□R...	MillFeed endmill, shank type	H052
EXSW09U□□□C...	MillFeedFeed, shank type	H046
EXTRACTOR SC COLLETS	SC collet extracting hook	K042, K131
EZ...	Coolant Nozzle	L023
EZ□□□□	TungDrill-Twisted / TungSix-Drill eccentric sleeve	J084
F		
F	Cemented carbide grade	A007
FBH□□□□□R-□□-P	DeepTri-Drill / FineBeam peripheral insert	J116, J136
FBM□□□□□L-□□-C	DeepTri-Drill / FineBeam central insert	J115, J135
FBM□□□□□R-□□-I	DeepTri-Drill / FineBeam intermediate insert	J116, J135
FCL...	Lever	L019
FCS...	Screw	L006
FDCU□□□□L	Solid drill for cast iron and aluminum alloy, L/D=8	J060, J061
FDCU□□□□S	Solid drill for cast iron and aluminum alloy, L/D=5	J060
FDS-...	Screw	L006
FDS-8SST	Insert clamp	L028
FDS-8ST	Screw	L006
FDS-8ST-18	Screw / Insert clamp	L006, L028
FLASR/L-...	TungT-Clamp external grooving and threading toolholder	E049, F076
FLER/L-...	TungT-Clamp external grooving and threading toolholder	F077
FLER/LT-...	TungT-Clamp external grooving and threading toolholder	F078
FLEX□□R/L	My-T Series grooving insert	F112, F166, F208
FLG-□□□R/L	TungT-Clamp grooving insert	F081, F147
FLG-□□□R/L-CB	TungT-Clamp grooving insert	F079, F080, F145, F146
FLGD-□□□R/L	TungT-Clamp grooving insert	F084, F150
FLGD-□□□R/L-CB	TungT-Clamp grooving insert	F084, F150
FLGP-□□□R/L	TungT-Clamp grooving insert	F082, F148
FLGT-□□□R/L	TungT-Clamp grooving insert	F085, F151
FLR-□□□R/L	TungT-Clamp grooving insert	F083, F149
FLR-□□□R/L-CB	TungT-Clamp grooving insert	F082, F148
FLRD-□□□R/L	TungT-Clamp grooving insert	F085, F151
FLRP-□□□R/L	TungT-Clamp grooving insert	F083, F149
FLRT-□□□R/L	TungT-Clamp grooving insert	F086, F152
FLSR/L-...	TungT-Clamp external grooving and threading toolholder	E049, F076
FLSR/LT-...	TungT-Clamp external grooving and threading toolholder	F077
FLT-3R/L-CB	60° angle threading insert	E012, F086, F152
FLT-3R/L-HCB	60° angle threading insert	E012, F086, F152
FLT-3R/LC-HCB	60° angle threading insert	E012, F086, F152
FNBM-□□D-xx.xx	FineBeam indexable drill head with external 4-start thread for DTS	J134
FNBM-□□N-xx.xx	FineBeam indexable drill head with internal single-start thread for STS	J133
FNBM-□□S-xx.xx	FineBeam indexable drill head with external 4-start thread for STS	J132
FNTR-□□D-xx.xx	Tri-Fine indexable drill head with external 4-start thread for DTS	J129
FNTR-□□N-□□.□□	Tri-Fine indexable drill head with internal single-start thread for STS	J128
FNTR-□□S-□□.□□	Tri-Fine indexable drill head with external 4-start thread for STS	J128
FPGN/□□-□□T...	TungHeavyGroove external wide profile grooving toolholder	F089, G103
FPGR□□-□□T...	TungHeavyGroove external wide profile grooving toolholder	F089
FSHM10-...	Screw	L006
FSHM8-...	Screw	L006
FSSA1102	Shim	L010
FSSP1102	Shim	L010
FW-□□□R/L	Insert clamp	L028
FW-305	Adjusting wedge	L029
FW304R/L-D	Insert clamp	L028
FW325R/L-D	Adjusting wedge	L029
FX105	Ceramic grade	A005
FX510	Ceramic grade	A005
G		
G.□□□-L□□-□□-...	BoreMeister anti-vibration bar, carbide shank	D021, D033, D057, D061, D075, D079
G16EL/IR...	Shim	L013
G16ER/IL...	Shim	L013
G1F	Cemented carbide grade	A007

Alphanumeric Index

Designation	Product name	Page
G2	Cemented carbide grade	A007
GBR/L32...	External grooving insert	F095, F155
GBR/L43...	External grooving insert	F096, F156
GBR/L43□□□R	External grooving insert	F097, F157
GE□□	My-T Series grooving insert	F069, F137, F200, F230
GE□□-AL	My-T Series grooving insert	F072, F139, F202, F232
GE□□R/L	My-T Series grooving insert	F071, F230
GF□□	My-T Series grooving insert	F070, F138, F201, F231
GFIMT□ER□□	Collet chuck	K102
GFIST□□ER□□	Collet chuck	K102
GH1-DA2.BG0.077	TungCap / SwissBore digital display unit	K049, K144
GH110	PVD coated grade	A004
GH130	PVD coated grade	A004
GH330	PVD coated grade	A004
GH730	PVD coated grade	A004
GIR/L□□□□-02	Internal grooving insert	F163
GLR/L...	External grooving insert	F099
GN□□	My-T Series grooving insert	F071, F139, F202, F231
GOR/L...	External grooving insert	F098
GP...	Guide pad	J117, J131, J137, J141
GR□□	My-T Series grooving insert	F070, F138, F201
GT□□	My-T Series grooving insert	F069, F137, F200, F232
GT720	PVD coated cermet grade	A005
GT9530	PVD coated cermet grade	A005
GTGN-16...	Grooving insert	F088, F154
GTICAT□□ER□□	Tapping holder	K092
GTIER□□ST□□X...	TungGTI tapping holder	K098
GX-□□□□R/LEU	External wide grooving toolholder	F100
GX-□□□□R/LIU	Internal grooving toolholder	F164
GX-2525R/LF	My-T Series face grooving toolholder	F206
GX□□-1DT	Shim	L014
GXE16-...	Shim	L014
GXE16-□DT	Shim	L014
GXE22-□DT	Shim	L014
GXN16-...	Shim	L014
GXN16-□DT	Shim	L014
GXN22-□DT	Shim	L014
GYROST□□ER...	TungGyro collet holder for lathes	K100
H		
H-TB	Wrench / Driver	L026
H-TB2W	Wrench / Driver	L027
H-TBS	Wrench / Driver	L026
HA6-FBHO-DE-1695	TungCap digital boring head	K047
HBFM□□M...	BallFinishNose cutter head	H167
HBRM□□M...	BallRoughNose cutter head	H164
HFWX04M□□□M...	DoMiniMill modular head	H171
HNGD...	Hexagonal, negative, ISO insert	B110
HPA06R□□□MM...	Tung-Tri cutter head	H098
HPA10R□□□MM...	Tung-Tri cutter head	H100
HPAV06M□□□M...	TungForce-Rec cutter head	H112
HPAV06M□□□S...	TungForce-Rec cutter head	H113
HPO07R□□□MM...	TungRec cutter head	H117
HPO11R□□□MM...	TungReccutter head	H122
HRP□□R□□□MM...	FixRMill cutter head	H173
HS□□-FLER3W	TungT-Clamp internal grooving and threading head	E050, F144
HS□□-LNFR-53	Head exchangeable internal threading head	E039
HS□□-LNFR-54API	Head exchangeable internal threading head	E040
HS□□-MTHOR-□	Head exchangeable internal threading head	E041
HSK□□A-C□-...	TungCap basic holder for HSK	K044
HSKA□□B16MN□□□□	Blank	K078
HSKA□□CF4-S	TungFit quick change holder	K076
HSKA□□EM□□X□□	Side lock holder (weldon)	K062
HSKA□□EM□□X□□E	Side lock holder (whistle notch)	K063
HSKA□□ER□□SHORT	ER collet chuck holder	K059
HSKA□□ER□□X...	ER collet chuck holder	K057
HSKA□□ER□□X□□□M	ERMini collet chuck holder	K056

Designation	Product name	Page
HSKA□□HYDRO□□X...	TungHydro hydraulic endmill holder	K060, K061
HSKA□□MAXIN□□X...	TungMax endmill holder	K059
HSKA□□MT□□X...	Morse taper holder	K075
HSKA□□ODP□□X...	Modular system	K077
HSKA□□SEM□□X...	Shell mill holder	K072
HSKA□□SEMC□□X...	Combination holder for slot mill and shell mill	K074
HSKA□□SRK□□X...	TungShrink Thermal shrinking holder	K070
HSKA□□SRKIN□□X...	TungShrink Thermal shrinking holder	K064, K065
HSKA100FM2-1/2X2.875	Face mill holder	K074
HSKA63ER□□X□□□BIN	ER collet chuck holder	K058
HSKA63ER32CLICK-IN	Quick change holder	K076
HSKA63MAXIN□□X□□□BIN	TungMax endmill holder	K059
HSKE□□ER□□X...	ER collet chuck holder	K055
HSKE□□ODP□□X...	Modular system	K077
HSKE□□SEM□□X...	Shell mill holder	K071
HSKE□□SRK□□X...	TungShrink Thermal shrinking holder	K068, K069
HSKFM□□ER□□X...	ER collet chuck holder	K058
HSKFM□□SEM□□X...	Shell mill holder	K073
HSKFM□□SRKIN□□X...	TungShrink Thermal shrinking holder	K066
HSRNR/L...	External toolholder. H-type	C101
HW2.0/5RED	Wrench / Driver	L025
HWD07R□□□MM...	Cutter head	H182
HXLN...	DoTwist-Ball cutter head	H038
HXL02M□□□M...	TungForce-Feed cutter head	H022
HXN03R□□□MM...	DoFeed cutter head	H028
I		
IND SHRINK IN UNIT USA	Induction heating unit for shrink tool chucking	K125
IND SHRINK START UNIT USA	Induction heating unit for shrink tool chucking	K125
INDER11TOOLADAPTER	Thermal shrinking collet	K140
IP-□□D	Wrench / Driver	L026
IP-20T	Wrench / Driver	L026
IP-6DB	Wrench / Driver	L026
IP-6F	Wrench / Driver	L025
IT□□	DTS inner tube	J154
J		
J10ER/L...	J10E insert (edge preparation)	B165, G065
J10ER/L□□□□F	J10E insert (shrap edge)	B165, G065
J740	PVD coated grade	A004
J9530	PVD coated cermet grade	A005
JBBR...	TinyMiniTurn solid carbide bar	G072
JBBS...	TinyMiniTurn sleeve for external coolant supply	G076
JBBS□□□...C	TinyMiniTurn sleeve for internal coolant supply	G076
JBBSA□□□...C	TinyMiniTurn solid carbide bar	G077
JBCR...	TinyMiniTurn solid carbide bar	G071
JBFR/L...	TinyMiniTurn solid carbide bar	G074
JBGR/L...	TinyMiniTurn solid carbide bar	G073
JBIR...	TinyMiniTurn solid carbide bar	E052, G072
JBPR...	TinyMiniTurn solid carbide bar	G071
JBRR...	TinyMiniTurn solid carbide bar	G075
JBSR...	TinyMiniTurn solid carbide bar	G074
JBTR/L...	TinyMiniTurn solid carbide bar	G070
JBUR...	TinyMiniTurn solid carbide bar	G071
JCCN200F...	J-Series grooving insert	F105
JCCR/L200F...	J-Series grooving insert	F105
JCCWSR/L...	J-Series external deep grooving and parting tolholder	F105
JCGN200F	J-Series grooving insert	F106
JCGN200FR/L	J-Series grooving insert	F106
JCGSSR/L...	My-T Series external grooving and parting toolholder	F063
JCGWSR/L□□□□K2	J-Series grooving and parting toolholder	F106
JCP-...	Clamp	L017
JCP-3N	Clamp	L017
JCTER/L□□-□T...	TungCut external grooving and parting toolholder	F014, G120
JCTER/L□□X2T□□-CHP	TungCut external grooving and parting toolholder for high pressure coolant	F015, G121
JDS-...	Screw	L007
JM10	PVD coated grade	A004
JPDJ2XR/L...	MiniForce-Turn external/profiling toolholder	C044, G032
JPVJ2XR/L...	MiniForce-Turn external/profiling toolholder	C060, G040
JPWL2XR/L...	MiniForce-Turn external/facing toolholder	C035, G024
JS□□□-SDUXL07	MiniForce-Turn external/profiling toolholder	C137, G035
JS□□□-SEL16	TungThread External threading toolholder for Swiss lathes	E033, G106
JS□□□-STCL18	TetraMini-Cut external grooving and threading toolholder	E044, F039, G081

Grade
Insert
Toolholder
Ext. Toolholder
Int. Toolholder
Threading
Grooving
Miniature Tool
Cutter
Endmill
Drilling Tool
System
Index

Alphanumeric Index

Designation	Product name	Page
JS□□□-SVUXL09	MiniForce-Turn external/profiling toolholder	C138, G043
JS□□□-SXXL09	DuoJust-Cut threading toolholder	E048, G115
JS□□□H-SEXPR...	Boring bar, steel shank	D041
JS□□□K-SDUCL...	J-Series external toolholder	G039
JS□□□K-TBL3	J-Series external toolholder	G061
JS□□□K-TGL3	J-Series external grooving toolholder	F107, G096
JS□□□K-TTL3	J-Series external toolholder	E051, G109
JSCGCR/L□□□□...	J-Series external toolholder	G053
JSCL2CR/L...	J-Series external toolholder	C026, G027
JSCL2CR/L...	J-Series external toolholder	G027
JSCL2CR□□□□X...-CHP	TungTurn-Jet toolholder with high pressure coolant nozzle	G028
JSCL2CR□□□□X-CHP	TungTurn-Jet toolholder with high pressure coolant nozzle	G028
JSCLCR/L...	J-Series external toolholder	C026, G029
JSCLCR□□□□□09-F15	J-Series stepped head toolholder	G029
JSDFCR/L...	J-Series external toolholder	G055
JSDJ2CR/L...	J-Series external toolholder	G036
JSDJ2CR/L□□□□-CHP	TungTurn-Jet toolholder with high pressure coolant nozzle	C050, G037
JSDJ2XR/L...	MiniForce-Turn external toolholder	C042, G031
JSDJ2XR/L□□□□□-CHP	TungTurn-Jet toolholder with high pressure coolant nozzle	C043, G033
JSDJCR/L...	J-Series external toolholder	G038
JSDJCR□□□□-F...	J-Series stepped head toolholder	C052, G038
JSDJXR/L...	MiniForce-Turn external toolholder	C042
JSDJXR□□□□-F...	MiniForce-Turn stepped head toolholder	C045, G034
JSDN3CR...	J-Series external toolholder	G048
JSDNCN...	J-Series external toolholder	G047
JSE2R□□□□□16-CHP	TungTurn-Jet threading toolholder for high pressure coolant	E032, G105
JSEGR/L...	J-Series external toolholder	G064
JSTACR/L...	J-Series external toolholder	C080, G051
JSTBR/L□□□□...	J-Series external toolholder	G061
JSTGR/L...	J-Series external grooving toolholder	F107, G096
JSTTR/L...	Screw-on external threading toolholder, for Swiss lathes	E051, G109
JSVABR/L...	J-Series external toolholder	G052
JSVGR/L...	J-Series external grooving toolholder	F103, G101
JSVJ2BR/L...	J-Series external toolholder	C066
JSVJ2BR/L□□□□-CHP	TungTurn-Jet external toolholder for high pressure coolant	C067, G045
JSVJ2XR/L...	MiniForce-Turn external toolholder	C059, G040
JSVJ2XR/L□□□□□-CHP	MiniForce-Turn external toolholder for high pressure coolant	C060, G041
JSVJBR/L...	J-Series external toolholder	G046
JSVJBR□□□□□11-F15	J-Series stepped head toolholder	G046
JSVJXR/L...	MiniForce-Turn external toolholder	C059
JSVJXR□□□□-F...	MiniForce-Turn external toolholder	C061, G042
JSVL2PR/L...	J-Series external toolholder	G030
JSVNBN...	J-Series external toolholder	G049
JSV2PR/L...	J-Series external toolholder	G050
JSWL2XR/L...	MiniForce-Turn external toolholder	C033, G023
JSWL2XR/L□□□□-CHP	TungTurn-Jet external toolholder for high pressure coolant	C034, G025
JSWL2XR/L□□□□-CHP	TungTurn-Jet external toolholder for high pressure coolant	C034, G025
JSWL2XR□□□□X-CHP	TungTurn-Jet external toolholder for high pressure coolant	C034, G025
JSWL2XR□□□□X-CHP	TungTurn-Jet external toolholder for high pressure coolant	C034, G025
JSWLXR/L...	MiniForce-Turn external toolholder	C034, C036
JSWLXR□□□□-F...	MiniForce-Turn stepped-head toolholder	G026
JSXBR□□□□K...	J-Series external toolholder	E052, G067, G108
JSXGR/L□□□□K8	J-Series toolholder for front/back turning, external grooving	F104, G056, G100
JSXGR/L□□□□K8-C	J-Series toolholder for front/back turning, external grooving	F104, G056, G100
JSXXR/L...	DuoJust-Cut parting toolholder	E045, G111
JSXXR/L□□□□-S	DuoJust-Cut parting toolholder for subspindle	E045, G111
JSXXR/L□□□□-F-CHP	DuoJust-Cut / TungTurn-Jet parting toolholder for high pressure coolant	E046, G112
JSXXR/L□□□□-F-S-CHP	DuoJust-Cut / TungTurn-Jet parting toolholder for high pressure coolant for subspindle	E047, G113
JSXXR/L□□□□X-CHP	DuoJust-Cut / TungTurn-Jet parting toolholder for high pressure coolant	E046, G112
JSXXR/L□□□□X-S-CHP	DuoJust-Cut / TungTurn-Jet parting toolholder for high pressure coolant for subspindle	E047, G113
JTBR/L...	JTB insert (edge preparation)	B165, G062
JTBR/L□□□□F	JTB insert (shrap edge)	B165, G062
JTCL2CR/L...	J-Series toolholder	C027, G028
JTDJ2CR/L...	J-Series toolholder	C051, G036
JTGR/L□□□□F...	J-Series JTG grooving insert (sharp edge)	F108, F109, G097, G098
JTGR□□□□	J-Series JTG grooving insert (honed edge)	F109, G098
JTTACR/L...	J-Series toolholder	C080, G051
JTTANR/L...	J-Series toolholder	C079, G060
JTTLNR/L...	J-Series toolholder	C030, G058
JTTR/L30□□□F	Threading insert, 60° thread angle (sharp edge)	E012, G110

Designation	Product name	Page
JTTR/L3005F-55	Threading insert, 55° thread angle (sharp edge)	E015, G110
JVGR/L□□□□F	J-Series external grooving insert with hand	F103, G101
JXBR/L...	JXB insert (edge preparation)	B164, G068
JXBR/L□□□□F	JXB insert (shrap edge)	B164, G067
JXFR□□□□F	Positive insert for front turning	B163
JXGR/L□□□□FA...	J-Series grooving insert	F104, G100
JXGR/L8200FN...	J-Series grooving insert	F104, G100
JXPG□□□□R/L□□□□F...	DuoJust-Cut insert	G116
JXRR□□□□F	Positive insert for reverse turning	B164
JXT□□R6000F	60° angle threading insert	E013, G108
JXTG12FR/L-□□□□-...	DuoJust-Cut insert	G117
JXTG12FR/L-60□□□□-0□□	60° angle threading insert	E011

K

KEYV-...	Wrench / Driver	L027
KEYV-S...	Wrench / Driver	L027
KEYV-T...	Wrench / Driver	L025
KEYV-W20	Wrench / Driver	L027
KGDT-...	Wrench / Driver	L027
KHS-TID10-19.99	DrillMeister head clamping key	J030
KITCAT40HYDRO□□□X...	TungHydro hydraulic chuck kit	K119
KITDIN2080□□□□ER...	ER collet type taper shank & collet (kit)	K115
KITDIN6987140HYDRO□□□X...	TungHydro hydraulic chuck kit	K119
KITGTIER□□□ST□□□X...	Tapping attachment kit	K098
KITGYRO□□□□D69880ER...	TungGyro	K101
KITGYROST□□□ER...	TungGyro	K100
KITHSKA63HYDRO□□□X...	TungHydro hydraulic chuck kit	K119
KITMT□□□□ER□□	ER collet type taper shank & collet (kit)	K116
KITR-81□□ER□□	ER collet type taper shank & collet (kit)	K115
KITST□□X□□□□□ER...	ER collet straight shank kit	K116
KITST□□X□□□□□ER□□M	ER collet straight shank kit	K116
KITST□□X□□□□□ER□□MF	ER collet straight shank kit	K116
KNMX□□□□L/R-S1	Negative insert, parallelogram	B110
KS-...	Wrench / Driver	L026
KS05F	Cemented carbide grade	A007
KS15F	Cemented carbide grade	A007
KS20	Cemented carbide grade	A007
KUDTS□□□E-xx.xx	Unidex indexable drill head with external 4-start thread for DTS	J140
KUSTS□□□-xx.xx	Unidex indexable drill head with internal single-start thread for STS	J138
KUSTS□□□E-xx.xx	Unidex indexable drill head with external 4-start thread for STS	J138

L

L535B□□□EXT-FC	API Buttress threading insert	E029
L535B□□□INT-FC	API Buttress threading insert	E029
LCL...	Lever	L019
LCS...	Screw	L007
LD□□□□R/L	Locator	L028
LDS54□□□□FT-CB #□	Threading insert	E031
LE□□□□R/L	Locator	L028
LF□□□□R/L	Locator	L028
LHM12x1.75x30-C	Screw	L006
LMEU□□□□□□ZHEN-MJ	TecTangential-Slot insert	H160
LMMU□□□□□□PNER-MJ	TecMill insert	H141
LN□□□□R/L	Locator	L028
LN25...	ETLN insert	H212
LNGU0303ZER-MH	DoFeed 03insert	H029
LNGU06X5ZER-MH	DoFeed 06insert	H033
LNGU06X5ZER-W	DoFeed 06insert	H033
LNMU0303ZER-MJ	DoFeed 03insert	H029
LNMU0303ZER-ML	DoFeed 03insert	H029
LNMU0303ZER-MS	DoFeed 03insert	H029
LNMU06X5ZER-MJ	DoFeed 06insert	H033
LNMU06X5ZER-ML	DoFeed 06insert	H033
LNMU06X5ZER-MS	DoFeed 06insert	H033
LNMX□□□□□□□R/L...	TurnTec insert	C083, C097, C120, D101
LNMX□□□□□□□R-MJ	DoTwist-Ball insert	H038
LNMX□□□□□□□R-MJ	DoTwist-Ball insert	H038
LNMX□□□□□□□ZER-HL	DoTwist-Ball insert	H038
LOGT060204R-NDJ	DeepTri-Drill insert	J114
LP□□□□R/L	Locator	L028
LPMT03X206R-D4	Drilling insert	J092
LPMT05X204-D4	Drilling insert	J092
LPP16R	Locator	L028
LPTC16U□□□□□B...	TungTri-Shred roughing cutter	H108

Alphanumeric Index

Designation	Product name	Page
LQMU□□□□□□□□ER-MJ	DoRec insert	H137
LR□□□□R/L	Locator	L028
LS-8	Screw	L008
LSC...	Shim	L011
LSD...	Shim	L011
LSMT0202R2-MM	TungForce-Feed insert	H023
LSMT0202ZER-HM	TungForce-Feed insert	H023
LSP...	Spring for shim	L022
LSR...	Shim	L013
LSS...	Shim	L010
LST...	Shim	L009
LSV212	Shim	L012
LSW...	Shim	L012
LSZ42BR/L	Shim	L012
LV□□□□R/L	Locator	L028
LW□□□□R/L	Locator	L028
LX11	Ceramic grade	A005
LX21	Ceramic grade	A005

M

M-1000	Lubricant	L026
M□x...	Screw	L007
M□□CLAMPSCREWSEM...	Clamp screw for shell mill holder	K132
MBU-□□□□	Brazed drill head with external single-start thread for STS	J144
MCL-...	Clamp	L016
MCPM-...	Clamp	L016
MCS□□□-...	Screw	L006
MCTR□□.□□X□□□.□□-10	DeepTri-Drill for lathes and machining centers L/D=10	J097
MCTR□□.□□X□□□.□□-15	DeepTri-Drill for lathes and machining centers L/D=15	J098
MCTR□□.□□X□□□.□□-25	DeepTri-Drill for lathes and machining centers L/D=25	J100
MCTR□□.□□XF□□□.□□-10	DeepTri-Drill for lathes and machining centers L/D=10	J103
MCTR□□.□□XF□□□.□□-15	DeepTri-Drill for lathes and machining centers L/D=15	J104
MCTR□□.□□XF□□□.□□-25	DeepTri-Drill for lathes and machining centers L/D=25	J105
MCTR□□.□□XM□□-20	DeepTri-Drill for lathes and machining centers L/D=20	J099
MCTR□□.□□10XFM40-8	DeepTri-Drill for lathes and machining centers L/D=8	J102
MCTR□□.□□X□□□.□□-25	DeepTri-Drill for lathes and machining centers, cross hole, L/D=25	J101
MD10	Cemented carbide grade	A007
MD20	Cemented carbide grade	A007
MLP...	Pin	L020
MSC-...	Shim	L011
MSD-...	Shim	L011
MSP-...	Screw	L004
MSR-...	Shim	L013
MSS-4□2	Shim	L010
MST-...	Shim	L009
MSV-322	Shim	L012
MSW-...	Shim	L012
MT□ER□□X...	ER collet chuck holder	K099
MTEC□□□□□□□□.□ISO	ISO solid carbide threading endmill	H191
MTEC□□□□□□□□BSPT	BSPT solid carbide threading endmill	H202
MTEC□□□□□□□□NPT	NPT solid carbide threading endmill	H202
MTEC□□□□□□□□UN	Unified solid carbide threading endmill	H197
MTEC□□□□□□□□W	Whitworth solid carbide threading endmill	H201
MTECB□□□□□□□□.□ISO	ISO solid carbide threading endmill, with coolant hole	H192
MTECB□□□□□□□□NPT	NPT solid carbide threading endmill, with coolant hole	H202
MTECB□□□□□□□□UN	Unified solid carbide threading endmill, with coolant hole	H198
MTECB□□□□□□□□W	Whitworth solid carbide threading endmill, with coolant hole	H201
MTECD□□□□□□□□.□ISO	ISO solid carbide thread mill for boring, threading, chamfering	H196
MTECE□□□□□□□□.□ISO	ISO solid carbide external threading endmill	H196
MTECE□□□□□□□□UN	Unified solid carbide external threading endmill	H200
MTECQ□□□□□□□□.□ISO	ISO solid carbide deep threading endmill, with coolant hole, with coolant hole	H193
MTECS□□□□□□□□.□ISO	ISO small diameter solid carbide threading endmill, short edge type	H194
MTECS□□□□□□□□.□MJ	MJ small diameter solid carbide threading endmill, short edge type, with coolant hole	H203
MTECS□□□□□□□□UN	Unified solid carbide threading endmill, short edge type	H199
MTECS□□□□□□□□UNJ	UNJ small diameter solid carbide threading endmill, short edge type, with coolant hole	H203
MTECS□□□□□□□□W	Whitworth solid carbide thread mill for threading, short edge type	H202
MTECS06047C1920UN-L	Unified small diameter solid carbide threading endmill, short edge type	H199
MTECSH□□□□□□□□.□ISO	ISO small diameter solid carbide threading endmill, short edge type, left hand	H195
MTECSH□□□□□□□□UN	Unified solid carbide thread mill for machining, short edge type, left hand	H200
MTEGZ□□□□□□□□.□ISO	ISO solid carbide threading endmill, with coolant hole	H193
MTEGZ□□□□□□□□UN	Unified solid carbide threading endmill, with coolant hole	H198
MTEGZ□□□□□□□□NPTF	NPTF solid carbide threading endmill, with coolant hole	H203
MTEGZ□□□□□□□□W	Whitworth solid carbide threading endmill, with coolant hole	H201
MTVNR...	External threading toolholder	E038, E039

Designation	Product name	Page
MTVOR...	External threading toolholder	E040
MULTICLAMP□□□□□□/□	Multi-clamp fixture for HSK shank	K135
MULTICLAMP□□□□	TungCap multi-clamp fixture	K045
N		
N308	Cermet grade	A005
NAS-...	Shim	L010
NAT-...	Shim	L009
NCS-3...	Breaker piece	L021
NCT-...	Breaker piece	L021
NDS-...	Screw	L006
NF-84A	Clamp	L017
NPMX...	Unidex insert	J142
NS520	Cermet grade	A005
NS740	Cermet grade	A005
NS9530	Cermet grade	A005
NUTER...	UM/Mini nut for ER collet chuck	K128
NUTER□□SHORT	Nut for ER collet chuck	K129
NUTER□□TOP	Nut for ER collet chuck	K128
NUTER□□TOPBIN	Balanceable nut for ER collet chuck	K129
NUTER11GHS	SpinJet Nut for Spinjet collet	K141
NXE□□-...	Shim	L015
NXN□□-...	Shim	L015

O

ON□□U0507ANEN-MJ	DoTriple-Mill insert	H061
ON□□U0705AN□N-ML	DoOcto insert	H065
ON□□U0705ANPN-MJ	DoOcto insert	H065
ONGU0507ANEN-W	DoTriple-Mill insert	H061
ONHU0705ANPR-W	DoOcto insert	H065
OR14X2.5NN	TungTurn-Jet O-ring	L023
OR6.4X0.9N	TungTurn-Jet O-ring	L023
OT□□	DTS outer tube	J154
OWMT0807AAER-ML	DoOcto insert	H065
OWMT0807ZNER-HJ	DoOcto insert	H065

P

P-...	Wrench / Driver	L026
P-□F	Wrench / Driver	L025
P-2.5T	Wrench / Driver	L025
PAS-...	Shim	L010
PAT-...	Shim	L009
PCBNR/L2525	P-type external toolholder	C096
PCFNR/L...	P-type external toolholder	C119
PCL2NR...	P-type external toolholder	G057
PCLNR/L...	ISO-EcoTurn / P-type external toolholder	C019, C022, G057
PCLNR/L□□□-CHP	TungTurn-Jet external toolholder for high pressure coolant	C021
PCLNR/L□□□□-CHP	TungTurn-Jet external toolholder for high pressure coolant	C018
PDJNR/L...	ISO-EcoTurn / P-type external toolholder	C041, C047, G059
PDJNR/L□□□-CHP	TungTurn-Jet external toolholder for high pressure coolant	C040, C046
PDPNN...	P-type external toolholder	C077
PDQNR/L...	P-type external toolholder	C127
PN□□U0905GNE□-MJ	DoPent insert	H070
PNCU0905GNEN-ML	DoPent insert	H070
PNCU0905GNEN-W	DoPent insert	H070
PNCU0905GNFR-AJ	DoPent insert	H070
PNZ5	Coolant pipe and nozzle	L023
POMG□□□□□-MNV	TurnTenFeed insert	C103
PPXOR/L...	TurnTenFeed external toolholder	C102
PRDCN...	P-type external toolholder	C105
PRESETER-JET□□X...	Preset screw for ER collet	K037, K131
PRESETMAXIN□□X...	Preset screw for power chuck holder	K042, K132
PRESETMAXIN□□X□□	Preset Screw	K132
PRESETSCCAP□□X...	Preset screw for straight collet	K041, K118
PRESETSCREWHYDROM...	Preset screw for hydraulic chuck	K121
PRESETSCREW□□X□□B	Preset screw with coolant hole for EME/SRKIN	K133
PRGCR/L...	P-type external toolholder	C087
PRGNR/L...	P-type external toolholder	C085
PSBNR/L...	P-type external toolholder	C099
PSC□□-FBHO-DE-16...	SwissBore digital boring head	K047
PSC□□-FBHS-DE-...	SwissBore fine boring head for digital display	K048
PSCAT□□□□ANSI□	Pull stud	K127

Grade
Insert
Toolholder
Ext. Toolholder
Int. Toolholder
Threading
Grooving
Tool
Miniature Tool
Cutter
Milling
Endmill
Drilling Tool
System
User's Guide
Index



Alphanumeric Index

Designation	Product name	Page
PSCAT□□□□MAS□	Pull stud	K127
PSDNN...	P-type external toolholder	C108
PSGB...	TungHeavyGroove wide profile grooving insert	F091, G104
PSGM...	TungHeavyGroove wide grooving insert	F091
PSKNR/L...	P-type external toolholder	C117
PSP-...	Spring for shim	L022
PSP-16	Spring for shim	L022
PSP301	Spring for shim	L022
PSSNR/L...	P-type external toolholder	C113
PSTR/L...	Shim	L024
PT1/4GN	Screw	L008
PTFNR/L...	ISO-EcoTurn / P-type external toolholder	C121, C123
PTGNR/L...	ISO-EcoTurn / P-type external toolholder	C090, C093
PTGNR/L□□□-CHP	TungTurn-Jet external toolholder for high pressure coolant	C092
PTJNR/L...	ISO-EcoTurn external toolholder	C054
PTL2NR/L...	J-Series external toolholder	C029, G058
PVJNR/L...	ISO-EcoTurn / P-type external toolholder	C058
PVJNR/L□□□-CHP	TungTurn-Jet external toolholder for high pressure coolant	C058, C063
PVQNR/L...	ISO-EcoTurn external toolholder	C131
PVQNR/L□□□-CHP	TungTurn-Jet external toolholder for high pressure coolant	C133
PVVNN...	ISO-EcoTurn external toolholder	C072
PWLNR/L...	ISO-EcoTurn external toolholder	C032
PWLNR/L□□□-CHP	TungTurn-Jet external toolholder for high pressure coolant	C031, C038
Q		
Q-CCMW...	CBN insert, 80° rhombic, positive	B183
Q-DCMW...	CBN insert, 55° rhombic, positive	B185
Q-SPGN...	CBN insert, square, positive	B186
Q-TPGN...	CBN insert, triangular, positive	B187
Q-TPMW...	CBN insert, triangular, positive	B190
R		
R-8ER□□X...	ER collet chuck holder	K094
R□□□-46	TungMini-Slit flange set for side cutter	H153
R1.25-55	TungMini-Slit flange set for side cutter	H153
RCGT□□□□M0-AL	Round, positive, ISO insert	B131
RCGX...	Round, positive, ISO insert	B133
RCMM□□□□M0-61	Round, positive, ISO insert	B132
RCMT□□□□EN-MJ	RoundSplit insert	H179
RCMT□□□□EN-NMJ	RoundSplit insert	H179
RCMT□□□□FN-NAJ	RoundSplit insert	H179
RCMT□□□□M0-61	Round, positive, ISO insert	B132
RCMT□□□□M0-6RM	FixR-Turn insert / Round, positive, ISO insert	B131, C089, C107
RCMT□□□□M0-6RS	FixR-Turn insert / Round, positive, ISO insert	B131, C089, C107
RCMT□□□□M0-CM	Round, positive, ISO insert	B131
RCMT□□□□M0-RS	Round, positive, ISO insert	B131
RDMW□□□□M0	Insert for radius cutter	H183
RNGA 43	ISO insert, round, negative	B076
RNGN 45...	ISO insert, round, negative	B076
RNGN...	CeramicSpeed-Mill insert	H073
RNMG □□-61	ISO insert, round, negative	B076
RNMU1307ZNER-MJ	DoTriple-Mill insert	H061
RPMT□□□□EN-MJ	FixRMill insert	H173
RPMT□□□□EN-ML	FixRMill insert	H173
RSFTC10...	Adjusting wedge	L029
RSFTS-050M	Screw	L006
RSFTS6...	Cover	L029
RSRGR5M40	Screw	L006
RT-...	Screw	L005
RT□□	Round, positive, ISO insert	B132
S		
S-412	Screw	L007
S-570-□□-□□	Shank for internal grooving and threading head	E039, E040, E041, E050, F144
S-CNGN...	Solid CBN insert, 80° rhombic, negative	B173
S-CU-CHP	Coolant unit	L023
S-RNGN...	Solid CBN insert, round, negative	B176
S-SNGN...	Solid CBN insert, square, negative	B177
S-TNGN...	Solid CBN insert, triangular, negative	B179
S□□-CNR3DT	Internal grooving and threading toolholder	F153

Designation	Product name	Page
S□□-DDUNR/L□□T-H	BoreMeister boring head	D060
S□□-SCLCR/L...	BoreMeister exchangeable boring head	D020
S□□-SDUCR/L...	BoreMeister exchangeable boring head	D056
S□□-SVLCR/L16T-H	BoreMeister exchangeable boring head	D032
S□□-SVUCR/L11-H	BoreMeister exchangeable boring head	D074
S□□-TLANR/L□□-...	TurnTec boring bar, steel shank	D100
S□□□-55	TungMini-Slit drive shank for side cutter	H153
S□□□-CSKPR/L...	Boring bar, steel shank	D046
S□□□-CTFPR/L...	Boring bar, steel shank	D051
S□□□-PCLNR/L...	Boring bar, steel shank	D030
S□□□-PDUNR/L...	Boring bar, steel shank	D064
S□□□-PDZNR/L15	Boring bar, steel shank	D096
S□□□-PSKNR12	Boring bar, steel shank	D048
S□□□-PTFNR/L16	Boring bar, steel shank	D054
S□□□-PTUNR/L...	Boring bar, steel shank	D071
S□□□-PWLNR/L06	Boring bar, steel shank	D038
S□□□-SGTR/L...	Internal grooving toolholder	F155
S□□10	Shim seat	L024
S08...	Shim seat	L024
S10...	Shim seat	L024
S40-DVUNR/L16T-H	BoreMeister boring head	D078
SATZ-M...	Coolant Nozzle	L023
SC□□SEAL...	SC straight collet	K040, K118
SC□□SHYDRO...	Sealed collet for hydraulic chuck	K120
SC□□SPR...	SC straight collet	K041, K117
SC□□T□A/B	TungCap sleeve for C-ABB adapter	K031
SC1-1/2T□□□□A/B	Sleeve for C-ABB adapter	K126
SCA□□□-02	Collar for slot mill	K043
SCLCR/L...	S-type external toolholder	C028
SCMT □□□ CM	Square, positive, ISO insert	B135
SCMT □□□ PM	Square, positive, ISO insert	B135
SCMT □□□ PS	Square, positive, ISO insert	B135
SCMT □□□-23	Square, positive, ISO insert	B135
SCMT □□□-24	Square, positive, ISO insert	B135
SCMT□□□□08-23	EBD insert	H186
SCREW□-□□SEM□	Standard center bolt	K132
SD□N53Z□N...	TMD5400RI insert	H091
SD□R1203AETN-MJ	TMD4400RI-U insert	H088
SD□R42ZSR-MJ	TMD4400RI-U insert	H088
SD0□-...	Screw	L006
SDCN42Z...	TMD4400RI-U insert	H088
SDCN42ZFN-DIA	TMD4400RI-U insert	H088
SDEN42Z...	TMD4400RI-U insert	H088
SDHT050204FN-AJ	TungQuad insert	H130, H221
SDJCR/L...	S-type external toolholder	C053
SDKN42Z...	TMD4400RI-U insert	H088
SDKR42ZPN-MS	TMD4400RI-U insert	H088
SDKR53ZSR-MJ	TMD5400RI insert	H091
SDMT050204PN-MJ	TungQuad insert	H130, H221
SDNCN...	S-type external toolholder	C071
SDQCR/L...	S-type external toolholder	C129
SEGT12X4ZEFR-AJ	TFE insert	H083
SEGW12X4ZE□R	TFE insert	H083
SEGW12X4ZEFR-BD	TFE insert	H083
SEGW12X4ZEFR-D	TFE insert	H083
SEGW12X4ZEFR-WD	TFE insert	H083
SEM22CF4C	TungFit shell mill adapter	K106
SET T-15/5	Wrench / Driver	L025
SETER□□SEAL...	Set of collets for internal coolant supply	K113
SETER□□SEAL□EM	Set of collets for external coolant supply (for endmill)	K114
SETER□□SEAL□EMJET2	Set of collets for external coolant supply	K115
SETER□□SEAL□JET2	Set of collets for external coolant supply (for endmill)	K114
SETER□□SPR□□	Set of ER spring collets	K113
SETER□□SPR□□AA	Set of AA ER spring collets	K113
SETER□□SPR□EM	Set of ER spring collets	K114
SETER32SRK□6USA	Set of ER collets with thermal shrink chuck	K126
SETSC□□SEAL□	Straight collet with coolant hole	K122
SETSC□□SPR□	Straight collet	K122
SGM□-...	TungCut grooving insert	F024, F124, F182, F212, G126
SGN□□□-...	TungCut grooving insert	B193, F032, F130, F187, F219, G129

Alphanumeric Index

Designation	Product name	Page
SGS□-...	TungCut grooving insert	F026, F126, F184, F214, G127
SGSR/L151	Shim	L015
SGTR/L□□□□-...	External grooving toolholder	F098
SH725	PVD coated grade	A004
SH730	PVD coated grade	A004
SHCM4-...	Screw	L006
SHIMSET-GP...	Shim	J118
SHM□□x□.□x□□-C	Screw	L007
SHM16x2x35-C	Screw	L007
SHM8x1.25x35-C	Screw	L007
SHRINKIN UNIT V2 USA	SHRINKIN Induction heating unit for shrink tool chucking	K125
SI-CLHOR...	Internal threading toolholder for chaser	E042
SIR/L...	Internal threading toolholder	E037
SL-PI-2	Pin	L020
SLJ□□□□L□□□□NA	Brazed gundrill	J122
SLLV-...	Lever	L019
SM-00	Shim seat	L024
SM□□-L...	TungFlex modular shank	H167
SM□□-L□□□/□.□□-CF4	TungFlex-TungFit conversion adapter	K103
SM□□-L□□□C□□	TungFlex modular system	K103
SM2.5...	Screw	L004
SM3...	Screw	L004
SM40-143-H0	Screw	L003
SMP□□□	DrillForce-Meister drill head	J034, J035
SMP□□□-□□□-GH	DrillForce-Meister regrinding holder	J036
SN□U1307ANEN-MJ	DoTriple-Mill insert	H061
SN□U1706ANPR-MJ	DoOcto insert	H065
SN□U1706ANTR-ML	DoOcto insert	H065
SNGA...	Square, negative, ISO insert	B084
SNGA□□-DIA	PCD insert, square, negative	B195
SNGA□□-QBN	CBN insert, square, negative	B177
SNGD...	Square, negative, ISO insert	B085
SNGG □□□ R/L-B	Square, negative, ISO insert	B077
SNGG □□□ R/L-C	Square, negative, ISO insert	B077
SNGG □□□ R/L-D	Square, negative, ISO insert	B077
SNGG □□□ R/L-P	Square, negative, ISO insert	B081
SNGG □□□-01	Square, negative, ISO insert	B077
SNGN...	Square, negative, ISO insert	B085
SNGN□□-DIA	PCD insert, traingular, negative	B195
SNGR/L...	Internal grooving toolholder	F159
SNGU1307ANEN-MH	DoTriple-Mill insert	H061
SNGU1307ANEN-W	DoTriple-Mill insert	H061
SNGX...	Square, negative, ISO insert	B085
SNHU1706ANFN-W	DoOcto insert	H065
SNMA...	Square, negative, ISO insert	B084
SNMG □□□ AS	Square, negative, ISO insert	B078
SNMG □□□ CF	Square, negative, ISO insert	B078
SNMG □□□ CH	Square, negative, ISO insert	B084
SNMG □□□ CM	Square, negative, ISO insert	B081
SNMG □□□ DM	Square, negative, ISO insert	B080
SNMG □□□ HMM	Square, negative, ISO insert	B082
SNMG □□□ HRF	Square, negative, ISO insert	B078
SNMG □□□ HRM	Square, negative, ISO insert	B082
SNMG □□□ L/R-S	Square, negative, ISO insert	B082
SNMG □□□ NS	Square, negative, ISO insert	B079
SNMG □□□ SA	Square, negative, ISO insert	B082
SNMG □□□ SF	Square, negative, ISO insert	B078
SNMG □□□ SH	Square, negative, ISO insert	B084
SNMG □□□ SM	Square, negative, ISO insert	B081
SNMG □□□ SS	Square, negative, ISO insert	B079
SNMG □□□ TA	Square, negative, ISO insert	B079
SNMG □□□ TF	Square, negative, ISO insert	B077
SNMG □□□ TH	Square, negative, ISO insert	B082
SNMG □□□ THS	Square, negative, ISO insert	B082
SNMG □□□ TM	Square, negative, ISO insert	B079
SNMG □□□ TS	Square, negative, ISO insert	B078
SNMG □□□ TSF	Square, negative, ISO insert	B077
SNMG □□□ ZM	Square, negative, ISO insert	B079
SNMG □□□-11	Square, negative, ISO insert	B078
SNMG □□□-17	Square, negative, ISO insert	B078
SNMG □□□-27	Square, negative, ISO insert	B080
SNMG □□□-33	Square, negative, ISO insert	B080

Designation	Product name	Page
SNMG □□□-37	Square, negative, ISO insert	B080
SNMG...	Square, negative, ISO insert	B080
SNMM □□□ TRS	Square, negative, ISO insert	B083
SNMM □□□ TU	Square, negative, ISO insert	B083
SNMM □□□ TUS	Square, negative, ISO insert	B083
SNMM □□□-57	Square, negative, ISO insert	B083
SNMM □□□-65	Square, negative, ISO insert	B083
SNMN...	Square, negative, ISO insert	B085
SNMU1206□□EN-MM	DoQuadMill insert	H067
SNMU120608HNEN-MM	DoQuadMill insert	H067
SNR/L...	Internal threading toolholder	E036
SNR/L000□K06SC-...	Internal threading toolholder	E035
SNR000□H06-...	Internal threading toolholder	E035
SP-...	Pin	L020
SP-16-L14	Spring for shim	L022
SP-2.5	Spring for shim	L022
SP913	Spring for shim	L022
SPGA...	Square, positive, ISO insert	B137
SPGM □□□ L	Square, positive, ISO insert	B137
SPGN...	Square, positive, ISO insert	B138
SPGN□□□-□□□-...	TungHeavyGroove external wide profile grooving toolholder	F090, G103
SPGN□□-DIA	PCD insert, square, positive	B197
SPGN□□-QBN	CBN insert, square, positive	B186
SPGR □□□ L	Square, positive, ISO insert	B138
SPGT □□□ L-W20	Square, positive, ISO insert	B136
SPGT □□□ R/L-W15	Square, positive, ISO insert	B136
SPGW...	Square, positive, ISO insert	B137
SPM□□□□ER-CG	TCB insert	H226
SPMA422...	ECP insert	H220
SPMM□□□ERD	TCB insert	H226, J092
SPMN...	Square, positive, ISO insert	B138
SPMP□□□-CG	TCB insert	H226
SPMP□□□ERD	TCB insert	H226, J092
SPMP831DS	TCB insert	H226, J092
SPMR □□□ CM	Square, positive, ISO insert	B138
SPMR □□□-23	Square, positive, ISO insert	B138
SPMT □□□ CM	Square, positive, ISO insert	B137
SPMT □□□ PS	Square, positive, ISO insert	B136
SPMT □□□-23	Square, positive, ISO insert	B136
SPMT □□□-24	Square, positive, ISO insert	B136
SPMT□□□ERD	Drilling insert	J092
SPMW...	Square, positive, ISO insert	B137
SQMU1206ZSR-MJ	DoFeed-Quad insert	H043
SR 114-018-L3.40	Screw	L003
SR 5/16-32UNEF 3/8-24UNF	Screw	L006
SR PS 118-0273	Screw	L006
SR-10400611	Screw	L008
SR-10503833-S	Screw	L003
SR14-5...	Screw	L003
SR14-591	Screw	L003
SR16-212-01397	Screw	L004
SR16-212-01397L	Screw	L004
SR34-5...	Screw	L003
SR76-9...	Screw	L003
SRACR/L□□□...	S-type external toolholder	C078
SRDCN□□□-6F	FixR-Turn external toolholder	C107
SRDCN□□□□...	S-type external toolholder	C106
SRGCR/L□□□-6F	FixR-Turn external toolholder	C089
SRGCR/L□□□□...	S-type external toolholder	C088
SRM□□X...	Clamp screw for endmill holder	K133
SRM3	Clamp screw for TungTurn-Jet	L024
SRM4X4 TL360	Coolant screw for TungTurn-Jet	L024
SRM5X0.8IP20X+ACROLYTE	Screw	L004
SRM6X16DIN912-12.9	Screw	L006
SRW11	Nut	L023
SS100	Screw	L007
SSC...	Shim	L011
SSD□N...	S-type external toolholder	C110, G054
SSD32	Shim	L012
SSG□□R...	TungMini-Slit side cutter	H151
SSHM□-...	Screw	L007
SSH2.5-3	Screw	L007
SSM□□N	TungMini-Slit insert	H152
SSR32	Shim	L013

Alphanumeric Index

Designation	Product name	Page
SSS□□N	TungMini-Slit insert	H152
SSS32	Shim	L010
SST32	Shim	L009
SSV...	Shim	L012
ST...	Drill tube for STS, internal thread type	J150
ST□□X□□□ER□□	ER collet chuck holder	K095
ST□□X□□□ER□□M	ERMini collet chuck holder	K094
ST□□X□□□ER□□MF	ERMini collet chuck holder	K096
ST□□X□□□OSRK...	TungShrink Thermal shrinking holder	K097
ST□□X□□□ER□□MFD	ER collet chuck holder, double end type	K096
ST□□X□□□ER□□S	ER collet chuck holder, internal coolant supply	K097
ST16X50ER1MF	ERMini collet chuck holder	K094
STACR/L□□□...	S-type external toolholder	C081
STCAR/L18-CHP	TetraMini-Cut external grooving blade for high pressure coolant	F039
STCAR/L27-CHP	TetraForce-Cut external grooving blade for high pressure coolant	F050
STCR/L□□-18	TetraMini-Cut external grooving and threading toolholder	E043, F037, G080
STCR/L□□-18-CHP	TetraMini-Cut external threading toolholder for high pressure coolant	E044, F038, G081
STCR/L□□-27	TetraForce-Cut external grooving toolholder	F049, G090
STCR/L□□-27-CHP	TetraForce-Cut grooving toolholder for high pressure coolant	F049, F050, G091
STCR/L□□□18-CHP	TetraMini-Cut external grooving and threading toolholder for high pressure coolant	E043, F037, G080
STCR/L□□X18-CHP	TetraMini-Cut external grooving and threading toolholder	F037
STGCR/L...	S type external toolholder	C095
STN62R/L	Shim	L015
STVOR...	External threading toolholder	E041
SVHCR/L...	S-type external toolholder	C135
SVJBR/L...	S-type external toolholder	C065
SVJCR/L...	S-type external toolholder	C068
SVQCR/L...	S-type external toolholder	C134
SVVCN...	S-type external toolholder	C075
SW...	Shim seat	L024
SW□□□-32	TungMini-Slit drive shank for side cutter	H153
SW□T1304PDPR-MJ	TungMill insert	H134
SW□T13T3AFPR-MJ	TungMill insert	H076
SW1.25-46	TungMini-Slit drive shank for side cutter	H153
SW32-25.4-46-J	TungMini-Slit drive shank for side cutter	H153
SW32-40	TungMini-Slit drive shank for side cutter	H153
SW99	Pin	L020
SWG1304PDFR-AJ	TungMill insert	H134
SWG13T3AFFR-AJ	TungMill insert	H076
SWMT0904□ER-MM	MillQuad-Feed insert	H047
SWMT1304PDER-ML	TungMill insert	H134
SWMT1304PDPR-MS	TungMill insert	H134
SWMT13T3AFER-ML	TungMill insert	H076
SWMT13T3AFPR-HJ	TungMill insert	H076
SWMT13T3AFPR-MS	TungMill insert	H076
SWMT1506□ER-MM	MillQuad-Feed insert	H047
SWMT1506ZER-MT	MillQuad-Feed insert	H047
SWMW13T3AFTR	TungMill insert	H076
SYHBR/L□□□...	Y-Pro external toolholder	C136
SYIBN□□□...	Y-Pro external toolholder	C139
SYJBR/L□□□...	Y-Pro external toolholder	C069
SYQBR/L□□□...	Y-Pro external toolholder	C136

T

T-□□□	Wrench / Driver	L026
T-□□□□/5	Wrench / Driver	L025
T-□□TORX	Wrench / Driver	L025
T-□D	Wrench / Driver	L026
T-□F	Wrench / Driver	L025
T-15L	Wrench / Driver	L025
T□-R□□	Insert for threading cutter	H214
T□□□-PCLNR...	Tsuppari-Ichiban internal toolholder	D030
T□□□-PDUNR15C	Tsuppari-Ichiban internal toolholder	D064
T□□□-PTUNR...	Tsuppari-Ichiban internal toolholder	D070
T□□□-SCLCR/L...	Tsuppari-Ichiban internal toolholder	D024
T□□□-SCLPR/L...	Tsuppari-Ichiban internal toolholder	D027
T□□□-SDQCR/L...	Tsuppari-Ichiban internal toolholder	D086
T□□□-STUPR/L...	Tsuppari-Ichiban internal toolholder	D068
T1115	CVD coated grade	A002
T1215	CVD coated grade	A002

Designation	Product name	Page
T20R-SVQBR11C	Tsuppari-Ichiban internal toolholder	D089
T20R-SVUBR11C	Tsuppari-Ichiban internal toolholder	D073
T25S-SVQCR16C	Tsuppari-Ichiban internal toolholder	D091
T25S-SVUCR16C	Tsuppari-Ichiban internal toolholder	D077
T2QP-CNGA...	CBN insert, 80°rhombic,negative	B172
T3130	CVD coated grade	A002
T313V	CVD coated grade	A002
T3225	CVD coated grade	A002
T3QP-TNGA...	CBN insert, traingular, negative	B178
T5105	CVD coated grade	A002
T5115	CVD coated grade	A002
T5125	CVD coated grade	A002
T515	CVD coated grade	A002
T6120	CVD coated grade	A002
T6130	CVD coated grade	A002
T9105	CVD coated grade	A002
T9115	CVD coated grade	A002
T9125	CVD coated grade	A002
T9135	CVD coated grade	A002
T9205	CVD coated grade	A002
T9215	CVD coated grade	A002
T9225	CVD coated grade	A002
T9235	CVD coated grade	A002
TAN07R□□□U...	DoOcto face mill	H063, H064
TASN13U□□□B...	DoTriple-Mill face mill	H060
TAW13R□□□U...	TungMill face mill	H074
TBGN□□□□-QBN	CBN insert, traingular, positive	B187
TC-...	Clamp	L016
TCB...	Boring cutter, monoblock type	H223
TCB□□□□-□□□F32	Boring cutter, cartridge type	H224
TCG18R/L...	TetraMini-Cut insert (edge preparation)	F042, F043, G084, G085
TCGT □□□ AL	Traingular, positive, ISO insert	B141
TCGT □□□ F-01	Traingular, positive, ISO insert	B139
TCGT □□□ FN-JS	Traingular, positive, ISO insert	B142
TCGT □□□ FR/L-J08	Traingular, positive, ISO insert	B142
TCGT □□□ FR/L-J10	Traingular, positive, ISO insert	B143
TCGT □□□ L-W15	Traingular, positive, ISO insert	B140
TCGT □□□ N-JS	Traingular, positive, ISO insert	B142
TCGT □□□ R	Traingular, positive, ISO insert	B142
TCGT □□□ R/L-J10	Traingular, positive, ISO insert	B143
TCGT □□□ SS	Traingular, positive, ISO insert	B141
TCGT □□□-01	Traingular, positive, ISO insert	B139
TCGT160608PDER-MJ	TungTri-Shred insert	H109
TCM27-□□□-...	TetraForce-Cut grooving insert	F055, F056, G094, G095
TCMT □□□ CM	Traingular, positive, ISO insert	B141
TCMT □□□ PM	Traingular, positive, ISO insert	B141
TCMT □□□ PS	Traingular, positive, ISO insert	B140
TCMT □□□ PSF	Traingular, positive, ISO insert	B139
TCMT □□□ PSS	Traingular, positive, ISO insert	B139
TCMT □□□ TM	Traingular, positive, ISO insert	B140
TCMT □□□ TSF	Traingular, positive, ISO insert	B140
TCMT □□□-23	Traingular, positive, ISO insert	B140
TCMT □□□-24	Traingular, positive, ISO insert	B140
TCMT□□-DIA	PCD insert, traingular, positive	B196
TCMT160620PDER-NMJ	TungTri-Shred insert	H109
TCNR□□□□□□DT	Internal grooving and threading toolholder	E038
TCP18R/L...	TetraMini-Cut grooving insert	F045, G086
TCP18R/L□□□F...	TetraMini-Cut whistling insert	F046, F047, G087
TCS18R...	TetraMini-Cut grooving insert	F044, G083
TCS27-□□□-...	TetraForce-Cut grooving insert	F053, F054, G092, G093
TCS27-□□□-□□R/L	TetraForce-Cut grooving insert	F054, G093
TCT18FR-60A-...	TetraMini-Cut threading insert	E011, G088
TCT18R/L-60N-...	TetraMini-Cut threading insert	E011, G088
TDBU□□□□-□□□□-2.5	TungDrill-Big drill body	J085, J088
TDSCA□□-□□	TungDrill-Big cartridge set, adjustable tool diameter	J085
TDSU-0750FS-02	TungSix-Drill flat, L/D=2	J065
TDSU-0750FS-03	TungSix-Drill flat, L/D=3	J066
TDSU-0750FS-04	TungSix-Drill flat, L/D=4	J067
TDSU□□□-02	TungSix-Drill Whistle notch, L/D=2	J065
TDSU□□□-03	TungSix-Drill Whistle notch, L/D=3	J066

Alphanumeric Index

Designation	Product name	Page
TDSU□□□F-2	TungSix-Drill flat, L/D=2	J065
TDSU□□□F-3	TungSix-Drill flat, L/D=3	J066
TDSU□□□F-4	TungSix-Drill flat, L/D=4	J067
TDXCA□□-□□	TungDrill-Bigcartridge set, adjustable tool diameter	J088
TDXCF□□□L□□	TungDrill-Twisted / TungSix-Drill chamfering tool	J072, J082
TDXU-□□□□FS-02	TungDrill-Twisted flat, L/D = 2	J074
TDXU-□□□□FS-03	TungDrill-Twisted flat, L/D = 3	J075
TDXU-□□□□FS-04	TungDrill-Twisted flat, L/D = 4	J076
TDXU-□□□□FS-05	TungDrill-Twisted flat, L/D = 5	J077
TE□N43Z□R	TSE4000RIAUI insert	H147
TECN43ZFR-DIA	TSE4000RIAUI insert	H147
TEKR2204PEPR-MS	TSE4000RIAUI insert	H147
TEN09R□□□U...	DoPent face mill	H069
TESTBARHYDRO□□	Torque test bar for hydraulic chuck	K121
TF-...	Clamp	L016
TFE12□□□RU	TFE face mill	H081
TFE12R□□□M...	TFE face mill	H082
TFMRN...	CeramicSpeed-Mill face mill	H072
TGTSR/L...	External grooving toolholder	F093
TGTTTR/L...	Perpendicular toolholder for external grooving	F094
TH03	Cemented carbide grade	A007
TH10	Cemented carbide grade	A007
THSN12U□□□□B...	DoQuadMill face mill	H067
TID□□□F□□-1.5	DrillMeister head exchangeable drill, helical flute, L/D=1.5	J011
TID□□□F□□-3	DrillMeister head exchangeable drill, helical flute, L/D=3	J013
TID□□□F□□-5	DrillMeister head exchangeable drill, helical flute, L/D=5	J015
TID□□□F□□-8	DrillMeister head exchangeable drill, helical flute, L/D=8	J017
TID□□□R□□-12	DrillMeister head exchangeable drill, helical flute, L/D=12	J019
TIDC□□□C□□-3	DrillMeister head exchangeable drill, straight flute L/D=3	J020
TIDC□□□C□□-5	DrillMeister head exchangeable drill, straight flute L/D=5	J021
TIDCF□□□-W...	DrillMeister chamfering holder	J022
TIDU□□□□R□□□□-12	DrillMeister head exchangeable drill, helical flute, L/D=12	J018
TIDU□□□F□□□□-1.5	DrillMeister head exchangeable drill, helical flute, L/D=1.5	J010
TIDU□□□F□□□□-3	DrillMeister head exchangeable drill, helical flute, L/D=3	J012
TIDU□□□F□□□□-5	DrillMeister head exchangeable drill, helical flute, L/D=5	J014
TIDU□□□F□□□□-8	DrillMeister head exchangeable drill, helical flute, L/D=8	J016
TISU□□□□F□□□□-3	DrillForce-Meister head exchangeable drill L/D=3	J032
TISU□□□□F□□□□-5	DrillForce-Meister head exchangeable drill L/D=5	J033
TJSGJETBT...	SpinJet high speed spindle	K139
TJSGJETC...	SpinJet high speed spindle	K137
TJSGJETCAT40	SpinJet high speed spindle	K138
TJSGJETER32	SpinJet high speed spindle	K136
TJSGJETHSKA63	SpinJet high speed spindle	K136
TJSGJETST20	SpinJet high speed spindle	K137
TJSSHAFTLOCKKEYGJET	SpinJet shaft lock key	K141
TJSTSDDISPLAY...	SpinJet wireless RPM display	K138
TL25D...	Thread milling insert	H210
TL25SEIR...	Thread milling insert	H211
TLA10R□□□L213U...	Tung-Tri roughing cutter	H099
TLA15R□□□□L□□□□S	Tung-Tri roughing cutter, subunit	H101
TLA15R□□□□L□□□□U...	Tung-Tri roughing cutter, main unit	H101
TLANR/L...	TurnTec external toolholder	C082
TLBNR/L...	TurnTec external toolholder	C097
TLFNR/L...	TurnTec external toolholder	C120
TLM11R□□□□U...	TecMill roughing cutter	H140
TLS11R200U0075A04	TungRec roughing cutter	H120
TMBA-0.□□□□H	Screw	L008
TMBA-M...	Screw	L008
TMD44□□RI-U	TMD4400RI-U face mill	H087
TMD54□□RI-U	TMD5400RI face mill	H090
TN□U□□□□□□PER-MJ	DoForce-Tri insert	H096
TNGA...	Traingular, negative, ISO insert	B095
TNGA□□-DIA	PCD insert, traingular, negative	B195
TNGA□□-QBN	CBN insert, traingular, negative	B179
TNGG □□□ F-01	Traingular, negative, ISO insert	B086
TNGG □□□ FR/L-P	Traingular, negative, ISO insert	B093
TNGG □□□ FR/L-W	Traingular, negative, ISO insert	B087
TNGG □□□ R/L-A	Traingular, negative, ISO insert	B086
TNGG □□□ R/L-C	Traingular, negative, ISO insert	B086
TNGG □□□ R/L-D	Traingular, negative, ISO insert	B086
TNGG □□□ R/L-P	Traingular, negative, ISO insert	B093
TNGG □□□ R/L-W	Traingular, negative, ISO insert	B087
TNGG □□□-01	Traingular, negative, ISO insert	B086
TNGN...	Traingular, negative, ISO insert	B096

Designation	Product name	Page
TNMA...	Traingular, negative, ISO insert	B095
TNMA43□□RDEXT	API Round threading insert	E028
TNMA43□□RDINT	API Round threading insert	E028
TNMA43NT□□PEXT-PT	29° Trapezoidal threading insert	E026
TNMA43NT□□PSTUBE-PT	29° Trapezoidal threading insert	E027
TNMA545B□□EXT-FC	API Buttress threading insert	E030
TNMA545B□□INT-FC	API Buttress threading insert	E030
TNMA54NT□□PEXT-PT	29° Trapezoidal threading insert	E026
TNMA54NT□□PSTUBE-PT	29° Trapezoidal threading insert	E027
TNMC43□□RDEXT	API Round threading insert	E028
TNMC43□□RDINT	API Round threading insert	E028
TNMC43NT□□PEXT-PT	29° Trapezoidal threading insert	E026
TNMC43NT□□PSTUBE-PT	29° Trapezoidal threading insert	E027
TNMC545B□□EXT-FC	API Buttress threading insert	E030
TNMC545B□□INT-FC	API Buttress threading insert	E030
TNMC54NT□□PEXT-PT	29° Trapezoidal threading insert	E026
TNMC54NT□□PSTUBE-PT	29° Trapezoidal threading insert	E027
TNMG □□□ AM	Traingular, negative, ISO insert	B090
TNMG □□□ AS	Traingular, negative, ISO insert	B089
TNMG □□□ CB	Traingular, negative, ISO insert	B089
TNMG □□□ CF	Traingular, negative, ISO insert	B088
TNMG □□□ CH	Traingular, negative, ISO insert	B094
TNMG □□□ CM	Traingular, negative, ISO insert	B092
TNMG □□□ DM	Traingular, negative, ISO insert	B091
TNMG □□□ FW	Traingular, negative, ISO insert	B087
TNMG □□□ HMM	Traingular, negative, ISO insert	B093
TNMG □□□ HRF	Traingular, negative, ISO insert	B088
TNMG □□□ HRM	Traingular, negative, ISO insert	B093
TNMG □□□ NM	Traingular, negative, ISO insert	B090
TNMG □□□ NS	Traingular, negative, ISO insert	B089
TNMG □□□ R/L-S	Traingular, negative, ISO insert	B094
TNMG □□□ SA	Traingular, negative, ISO insert	B093
TNMG □□□ SF	Traingular, negative, ISO insert	B088
TNMG □□□ SM	Traingular, negative, ISO insert	B092
TNMG □□□ SS	Traingular, negative, ISO insert	B090
TNMG □□□ SW	Traingular, negative, ISO insert	B089
TNMG □□□ TA	Traingular, negative, ISO insert	B090
TNMG □□□ TF	Traingular, negative, ISO insert	B086
TNMG □□□ TH	Traingular, negative, ISO insert	B094
TNMG □□□ THS	Traingular, negative, ISO insert	B094
TNMG □□□ TM	Traingular, negative, ISO insert	B090
TNMG □□□ TQ	Traingular, negative, ISO insert	B090
TNMG □□□ TS	Traingular, negative, ISO insert	B089
TNMG □□□ TSF	Traingular, negative, ISO insert	B087
TNMG □□□ ZF	Traingular, negative, ISO insert	B088
TNMG □□□ ZM	Traingular, negative, ISO insert	B091
TNMG □□□-11	Traingular, negative, ISO insert	B088
TNMG □□□-17	Traingular, negative, ISO insert	B088
TNMG □□□-27	Traingular, negative, ISO insert	B091
TNMG □□□-28	Traingular, negative, ISO insert	B092
TNMG □□□-32	Traingular, negative, ISO insert	B092
TNMG □□□-33	Traingular, negative, ISO insert	B092
TNMG □□□-37	Traingular, negative, ISO insert	B092
TNMG □□□-38	Traingular, negative, ISO insert	B092
TNMG □□□E FW	Traingular, negative, ISO insert	B087
TNMG □□□E SM	Traingular, negative, ISO insert	B092
TNMG □□□E SS	Traingular, negative, ISO insert	B090
TNMG □□□E SW	Traingular, negative, ISO insert	B089
TNMG □□□E TM	Traingular, negative, ISO insert	B090
TNMG □□□E TSF	Traingular, negative, ISO insert	B087
TNMG...	Traingular, negative, ISO insert	B091
TNMM □□□-57	Traingular, negative, ISO insert	B094
TNMM□□-DIA	PCD insert, traingular, negative	B194
TNMMU120708PER-NMJ	DoForce-Tri insert	H096
TNMMU1207R16PER-MJ	DoForce-Tri insert	H096
TOGT□□□□□□PDFR-AJ	Tung-Tri insert	H104
TOHT□□□□□□R-NDJ	DeepTri-Drill / Tri-Fine insert	J115, J129
TOHT□□□□□□R-NDL	DeepTri-Drill / Tri-Fine insert	J114, J130
TOMT□□□□□□PDER-MJ	Tung-Tri insert	H104
TOMT150608PDER-NMJ	Tung-Tri insert	H104
TOOLCLAMP...	Tool clamp fixture	K135
TP-...	Wrench / Driver	L026
TP-3A	Wrench / Driver	L026
TP□N43Z...	TSP4000RIA-U insert	H148

Grade
Insert
Toolholder
Ext. Toolholder
Int. Toolholder
Threading
Grooving
Miniature Tool
Milling Cutter
Endmill
Drilling Tool
Drilling System
User's Guide
Index



Alphanumeric Index

Designation	Product name	Page
TPA06R□□□U...	Tung-Tri face mill	H097
TPA10R□□□U...	Tung-Tri face mill	H098
TPA15R□□□U...	Tung-Tri face mill	H100
TPD05R□□□U...	TungQuad face mill	H129
TPGA...	Traiangular, positive, ISO insert	B150
TPGA□□-DIA	PCD insert, triiangular, positive	B198
TPGA□□-QBN	CBN insert, triiangular, positive	B190
TPGH □□□ L-H11	Traiangular, positive, ISO insert	B148
TPGH □□□ L-W10	Traiangular, positive, ISO insert	B147
TPGH □□□ L-W13	Traiangular, positive, ISO insert	B147
TPGM □□□ L-2	Traiangular, positive, ISO insert	B149
TPGM □□□ R/L	Traiangular, positive, ISO insert	B149
TPGN...	Traiangular, positive, ISO insert	B152
TPGN□□-DIA	PCD insert, triiangular, positive	B198
TPGN□□-QBN	CBN insert, triiangular, positive	B187
TPGR □□□ R/L	Traiangular, positive, ISO insert	B152
TPGT □□□ F-JS	Traiangular, positive, ISO insert	B150
TPGT □□□ FR/L-W08	Traiangular, positive, ISO insert	B146
TPGT □□□ JS	Traiangular, positive, ISO insert	B150
TPGT □□□ R/L-W08	Traiangular, positive, ISO insert	B146
TPGT □□□ R/L-W15	Traiangular, positive, ISO insert	B147
TPGT □□□ SS	Traiangular, positive, ISO insert	B148
TPGT □□□-01	Traiangular, positive, ISO insert	B144
TPGW...	Traiangular, positive, ISO insert	B150
TPGW□□-DIA	PCD insert, triiangular, positive	B198
TPGW□□-QBN	CBN insert, triiangular, positive	B190
TPKR43ZSR-MJ	TSP4000RIA-U insert	H148
TPM□□□ZERD	Drilling insert	J092
TPM□□R□□□U...	TecMill face mill	H140
TPMN...	Traiangular, positive, ISO insert	B152
TPMP83ZDS	Drilling insert	J092
TPMR □□□ CM	Traiangular, positive, ISO insert	B151
TPMR □□□ PS	Traiangular, positive, ISO insert	B151
TPMR □□□-23	Traiangular, positive, ISO insert	B151
TPMR □□□-24	Traiangular, positive, ISO insert	B151
TPMR2204PDSR-MJ	TSP4000RIA-U insert	H148
TPMT □□□ CM	Traiangular, positive, ISO insert	B148
TPMT □□□ PF	Traiangular, positive, ISO insert	B144
TPMT □□□ PM	Traiangular, positive, ISO insert	B148
TPMT □□□ PS	Traiangular, positive, ISO insert	B145
TPMT □□□ PSF	Traiangular, positive, ISO insert	B144
TPMT □□□ PSS	Traiangular, positive, ISO insert	B144
TPMT □□□ TM	Traiangular, positive, ISO insert	B146
TPMT □□□ TSF	Traiangular, positive, ISO insert	B145
TPMT □□□-23	Traiangular, positive, ISO insert	B146
TPMT □□□-24	Traiangular, positive, ISO insert	B146
TPMW...	Traiangular, positive, ISO insert	B149
TPMX...	Unidex insert	J142
TPO07R□□□U...	TungRec face mill	H116
TPO11R□□□M...	TungRec face mill	H119
TPO18R□□□U...	TungRec face mill	H126
TPQ□□R□□□U...	DoRec face mill	H136
TPS11□□□RBU	TungRec face mill	H119
TPTC16U□□□□B...	TungTri-Shred face mill	H108
TPTN□□U□□□□B...	DoForce-Tri face mill	H094
TPV16R□□□U...	Tung-AluMill face mill	H143
TPW13R□□□U...	TungMill face mill	H132
TPYD06...	TungSpeed-Mill face mill	H079
TRC□□R□□□U...	RoundSplit face mill	H177
TRLG□□.□□X□□□□-...	DeepTri-Drill for gundrill machines	J108, J109
TRLG□□.□□X□□□□-F...	DeepTri-Drill for gundrill machines	J111
TRLGCH□□.□□X□□□□-...	DeepTri-Drill for gundrill machines, cross hole	J110
TRP□□R□□□U...	FixRMill face mill	H172
TS200	Ceramic grade	A005
TS25...	Screw	L003
TS30...	Screw	L003
TS300	Ceramic grade	A005
TS35085I/HG	Screw	L003
TS40...	Screw	L003
TS45120I	Screw	L003
TS50...	Screw	L003
TS60...	Screw	L003
TS70F250A	Screw	L003
TS80F...	Screw	L003

Designation	Product name	Page
TSE40...	TSE4000RIA shoulder mill	H146
TSL□□R/L	Shim	L015
TSL□□R/LI	Shim	L015
TSN□□R□□□M...	TecTangential-Slot radial drive slot mill	H159
TSNR...	Internal threading toolholder	E036
TSP40...	TSP4000RIA-U shoulder mill	H148
TSW□□R...	TungUniversal-Slot radial drive slot mill	H157
TT-2525R/LE	External threading toolholder	E053
TT-2525RI	Internal threading toolholder	E053
TTR/L42M-005	60° angle threading insert	E013
TTR/L42W-005	55° angle threading insert	E015
TUNGBORE-CAT□□EM...	Drill holder with BT shank	K091
TVKX□□□□□□TN-MJ	TungThin-Slit insert	H156
TXLN...	DoTwist-Ball face mill	H036
TXN03...	DoFeed face mill	H026
TXN06...	DoFeed face mill	H032
TXP□□□□□R...	MillFeed face mill	H051
TXQ12R□□□U...	DoFeed-Quad face mill	H043
TXSW09U□□□□B...	MillQuad-Feed face mill	H046
TXSW15U□□□□B...	MillQuad-Feed face mill	H047
TZ120	Ceramic grade	A005
U		
UB...	Drill tube for STS, external thread type	J152
UM	Cemented carbide grade	A007
UMBB□□□□	Drill tube for STS with MBU	J150
UTE-□□□□	Brazed drill head with external 2-start or 4-start thread for STS	J145
UX30	Cemented carbide grade	A007
V		
VA...	Washer	L025
VAD□□□L□□□S08-S-M...	TungMeister adapter for TungFlex connection	I035, K104
VBB□□□L□□-BG-U02S...	TungMeister head	I019
VBB□□□L□□-BM-U02S...	TungMeister head	I019
VBB□□□L□□-SG-U02S...	TungMeister head	I020
VBD□□□L□□-BG-U02S...	TungMeister head	I019
VBD□□□L□□-BG-U04S...	TungMeister head	I020
VBD100L86-BG-U04S15	TungMeister head	I020
VBE□□□L□□-BG-U04S...	TungMeister head	I020
VBE□□□L□□-BGU02S...	TungMeister head	I020
VBGT □□□ FN-JS	35° rhombic, positive, ISO insert	B154
VBGT □□□ FR/L-J10	35° rhombic, positive, ISO insert	B154
VBGT □□□ N-JS	35° rhombic, positive, ISO insert	B154
VBGT □□□ R/L-J10	35° rhombic, positive, ISO insert	B154
VBMT □□□ CM	35° rhombic, positive, ISO insert	B154
VBMT □□□ PF	35° rhombic, positive, ISO insert	B153
VBMT □□□ PS	35° rhombic, positive, ISO insert	B153
VBMT □□□ PSF	35° rhombic, positive, ISO insert	B152
VBMT □□□ PSS	35° rhombic, positive, ISO insert	B153
VBMT □□□ TM	35° rhombic, positive, ISO insert	B153
VBMT □□□ TSF	35° rhombic, positive, ISO insert	B153
VBMT □□□-24	35° rhombic, positive, ISO insert	B154
VC004762110035F	Screw	L006
VC00TANG16040F	Screw	L006
VC00TEDI...	Screw	L006
VCA□□□L□□□A45...	TungMeister head	I026
VCA0375L16A45-U04S06	TungMeister head	I026
VCGT □□□ AL	35° rhombic, positive, ISO insert	B156
VCGW□□-DIA	PCD insert, 35° rhombic, positive	B198
VCMT □□□ CM	35° rhombic, positive, ISO insert	B156
VCMT □□□ PF	35° rhombic, positive, ISO insert	B155
VCMT □□□ PS	35° rhombic, positive, ISO insert	B155
VCMT □□□ PSF	35° rhombic, positive, ISO insert	B155
VCMT □□□ PSS	35° rhombic, positive, ISO insert	B155
VCMT □□□ TM	35° rhombic, positive, ISO insert	B155
VCMT □□□ TSF	35° rhombic, positive, ISO insert	B155
VCMT □□□-24	35° rhombic, positive, ISO insert	B156
VCMT...	35° rhombic, positive, ISO insert	B156
VCMT□□-DIA	PCD insert, 35° rhombic, positive	B196
VCP□□□L□□□A□□-02S...	TungMeister head	I022
VCR□□□L□□□R□□-02S...	TungMeister head	I026
VCW118L05.0A45-02S06	TungMeister head	I026
VDP□□□L□□□A30-02S...	TungMeister head	I022
VED□□□L□□R□□□-U06S...	TungMeister head	I014

Alphanumeric Index

Designation	Product name	Page
VED□□□□□□□□□□-U08S...	TungMeister head	I015
VED□□□□□□□□□□-U10S...	TungMeister head	I015
VEE□□□□□□□□□□-03S...	TungMeister head	I011
VEE□□□□□□□□□□CU04S...	TungMeister head	I013
VEE□□□□□□□□□□RU04S...	TungMeister head	I012
VEE□□□□□□□□□□RU05S...	TungMeister head	I012
VEE□□□□□□□□□□RU06S...	TungMeister head	I012
VEE□□□□□□□□□□-U06S...	TungMeister head	I014
VEE□□□□□□□□□□U04S...	TungMeister head	I012
VEE□□□□□□□□□□-U04S...	TungMeister head	I011
VEE□□□□□□□□□□A02S...	TungMeister head	I013
VEE□□□□□□□□□□AU03S...	TungMeister head	I014
VEE□□□□□□□□□□R000-U03S...	TungMeister head	I010
VEE062L47C008-U08S10	TungMeister head	I015
VEE075L62C008-U10S12	TungMeister head	I015
VEH□□□□□□□□□□I04S...	TungMeister head	I010
VER□□□□□□□□□□S□□-S	TungMeister adapter for ER collet connection	I036
VFX□□□□□□□□□□H04S...	TungMeister head	I018
VFX□□□□□□□□□□-U02S...	TungMeister head	I018
VGC□□□□□□□□□□-U02S...	TungMeister head	I024
VMT□□□□□□□□□□IS□□-...	TungMeister head	H204
VMT□□□□□□□□□□UN□□-...	TungMeister head	H204
VMT□□□□□□□□□□W□□-...	TungMeister head	H205
VNGA...	35° rhombic, negative, ISO insert	B100
VNGD...	35° rhombic, negative, ISO insert	B101
VNGG □□□ R-P	35° rhombic, negative, ISO insert	B096
VNGG □□□-01	35° rhombic, negative, ISO insert	B096
VNMA...	35° rhombic, negative, ISO insert	B100
VNMG □□□ CF	35° rhombic, negative, ISO insert	B098
VNMG □□□ CM	35° rhombic, negative, ISO insert	B100
VNMG □□□ DM	35° rhombic, negative, ISO insert	B099
VNMG □□□ HMM	35° rhombic, negative, ISO insert	B100
VNMG □□□ HRF	35° rhombic, negative, ISO insert	B098
VNMG □□□ HRM	35° rhombic, negative, ISO insert	B100
VNMG □□□ SF	35° rhombic, negative, ISO insert	B097
VNMG □□□ SM	35° rhombic, negative, ISO insert	B100
VNMG □□□ SS	35° rhombic, negative, ISO insert	B098
VNMG □□□ TF	35° rhombic, negative, ISO insert	B096
VNMG □□□ TM	35° rhombic, negative, ISO insert	B098
VNMG □□□ TQ	35° rhombic, negative, ISO insert	B098
VNMG □□□ TS	35° rhombic, negative, ISO insert	B098
VNMG □□□ TSF	35° rhombic, negative, ISO insert	B097
VNMG □□□ ZF	35° rhombic, negative, ISO insert	B097
VNMG □□□ ZM	35° rhombic, negative, ISO insert	B098
VNMG □□□-11	35° rhombic, negative, ISO insert	B097
VNMG □□□-28	35° rhombic, negative, ISO insert	B099
VNMG □□□-33	35° rhombic, negative, ISO insert	B099
VNMG □□□E SM	35° rhombic, negative, ISO insert	B100
VNMG □□□E SS	35° rhombic, negative, ISO insert	B098
VNMG □□□E TM	35° rhombic, negative, ISO insert	B098
VNMG □□□E TSF	35° rhombic, negative, ISO insert	B097
VNMG...	35° rhombic, negative, ISO insert	B099
VNMM□□□-DIA	PCD insert, 35° rhombic, negative	B194
VPET □□□ MFR-JSP	35° rhombic, positive, ISO insert	B158
VPET □□□ MFR/L-JPP	35° rhombic, positive, ISO insert	B157
VPET □□□ MFR/L-JRP	35° rhombic, positive, ISO insert	B157
VRB□□□□□□□□□□-U02S...	TungMeister head	I015
VRD□□□□□□□□□□-U06S...	TungMeister head	I016
VSC□□□□□□□□□□S□□-...	TungMeister shank	I035
VSS□□□□□□□□□□S□□U□	TungMeister shank	I033
VSS□□□□□□□□□□W□□US	TungMeister shank	I033
VSS100L1000S15UC	TungMeister shank	I033
VSSD□□□□□□□□□□-W-A	TungMeister shank	I032
VSSD□□□□□□□□□□-S	TungMeister shank	I033
VST□□□□□□□□□□A45-□S...	TungMeister head	I029
VST□□□□□□□□□□S□□US	TungMeister shank	I035
VST□□□□□□□□□□-3S06	TungMeister head	I028
VST□□□□□□□□□□-4S08	TungMeister head	I029
VST□□□□□□□□□□-6S10	TungMeister head	I029
VSTD□□□□□□□□□□S□□-S	TungMeister shank	I035
VTB□□□□□□□□□□C006-U06S05	TungMeister head	I030
VTB□□□□□□□□□□R016-U06S...	TungMeister head	I030
VTR□□□□□□□□□□IS□□-...	TungMeister head	H205
VTR220L24W14-4S08	TungMeister head	H205

Designation	Product name	Page
VTS□□□□□□□□□□S□□UC	TungMeister shank	I034
VTS□□□□□□□□□□S□□U□	TungMeister shank	I034
VTSD□□□□□□□□□□S□□-W-A	TungMeister shank	I034
VX0400□□□A	Screw	L003
VXGU □□□MFR/L-JS	MiniForce-Turn insert, 35° rhombic, positive	B158
VXGU □□□MFR/LE-JRP	MiniForce-Turn insert, 35° rhombic, positive	B158

W		
WBG T □□□ FR/L-JS	80° hexagonal, positive, ISO insert	B160
WBG T □□□ FR/L-W08	80° hexagonal, positive, ISO insert	B159
WBG T □□□ L-W11	80° hexagonal, positive, ISO insert	B160
WBG T □□□ R/L-JS	80° hexagonal, positive, ISO insert	B160
WBG T □□□ R/L-W08	80° hexagonal, positive, ISO insert	B159
WCMT□□□□□□□□-D□	Drilling insert	J092
WCMT□□□□□□□□-D4	EVX insert	H217
WCS3	Screw	L008
WDCN42ZFR-DIA	TMD4400RI-U insert	H088
WF□□□R/L	Insert clamp	L028
WGE□□	My-T Series Grooving insert	F065, F226
WGE□□R/L	My-T Series Grooving insert	F065, F227
WGR□□	My-T Series Grooving insert	F066
WGT□□	My-T Series Grooving insert	F066, F226
WN645R/L	Insert clamp	L028
WNGA...	80° hexagonal, negative, ISO insert	B109
WNGG □□□-01	80° hexagonal, negative, ISO insert	B101
WNGU□□□□□□□□TN-MJ	TungUniversal-Slot insert	H158
WNMA □□□E	80° hexagonal, negative, ISO insert	B109
WNMA...	80° hexagonal, negative, ISO insert	B109
WNMG □□□ AFW	80° hexagonal, negative, ISO insert	B102
WNMG □□□ AM	80° hexagonal, negative, ISO insert	B105
WNMG □□□ AS	80° hexagonal, negative, ISO insert	B104
WNMG □□□ ASW	80° hexagonal, negative, ISO insert	B104
WNMG □□□ CB	80° hexagonal, negative, ISO insert	B104
WNMG □□□ CF	80° hexagonal, negative, ISO insert	B103
WNMG □□□ CH	80° hexagonal, negative, ISO insert	B108
WNMG □□□ CM	80° hexagonal, negative, ISO insert	B107
WNMG □□□ DM	80° hexagonal, negative, ISO insert	B106
WNMG □□□ FW	80° hexagonal, negative, ISO insert	B102
WNMG □□□ HMM	80° hexagonal, negative, ISO insert	B107
WNMG □□□ HRF	80° hexagonal, negative, ISO insert	B103
WNMG □□□ HRM	80° hexagonal, negative, ISO insert	B107
WNMG □□□ NM	80° hexagonal, negative, ISO insert	B105
WNMG □□□ NS	80° hexagonal, negative, ISO insert	B104
WNMG □□□ SA	80° hexagonal, negative, ISO insert	B108
WNMG □□□ SF	80° hexagonal, negative, ISO insert	B103
WNMG □□□ SH	80° hexagonal, negative, ISO insert	B108
WNMG □□□ SM	80° hexagonal, negative, ISO insert	B107
WNMG □□□ SS	80° hexagonal, negative, ISO insert	B104
WNMG □□□ SW	80° hexagonal, negative, ISO insert	B104
WNMG □□□ TA	80° hexagonal, negative, ISO insert	B105
WNMG □□□ TF	80° hexagonal, negative, ISO insert	B101
WNMG □□□ TH	80° hexagonal, negative, ISO insert	B108
WNMG □□□ THS	80° hexagonal, negative, ISO insert	B108
WNMG □□□ TM	80° hexagonal, negative, ISO insert	B105
WNMG □□□ TQ	80° hexagonal, negative, ISO insert	B105
WNMG □□□ TS	80° hexagonal, negative, ISO insert	B103
WNMG □□□ TSF	80° hexagonal, negative, ISO insert	B102
WNMG □□□ ZF	80° hexagonal, negative, ISO insert	B102
WNMG □□□ ZM	80° hexagonal, negative, ISO insert	B106
WNMG □□□-11	80° hexagonal, negative, ISO insert	B102
WNMG □□□-17	80° hexagonal, negative, ISO insert	B102
WNMG □□□-27	80° hexagonal, negative, ISO insert	B106
WNMG □□□-33	80° hexagonal, negative, ISO insert	B106
WNMG □□□-37	80° hexagonal, negative, ISO insert	B106
WNMG □□□E FW	80° hexagonal, negative, ISO insert	B102
WNMG □□□E NM	80° hexagonal, negative, ISO insert	B105
WNMG □□□E SM	80° hexagonal, negative, ISO insert	B107
WNMG □□□E SS	80° hexagonal, negative, ISO insert	B104
WNMG □□□E SW	80° hexagonal, negative, ISO insert	B104
WNMG □□□E TM	80° hexagonal, negative, ISO insert	B105
WNMG □□□E TSF	80° hexagonal, negative, ISO insert	B102
WNMG □□□E ZF	80° hexagonal, negative, ISO insert	B102
WNMG □□□E ZM	80° hexagonal, negative, ISO insert	B106
WNMG...	80° hexagonal, negative, ISO insert	B106



Alphanumeric Index

Designation	Product name	Page
WP193TR/L	Insert clamp	L028
WP440R/L	Insert clamp	L028
WPMT□□□□□□□□Z□R-MH	MillFeed insert	H053
WPMT□□□□□□□□ZPR-DML	MillFeed insert	H053
WPMT□□□□□□□□ZPR-ML	MillFeed insert	H053
WPMT090725ZPR/L-ML	TurnFeed insert	B159, C104
WPMW□□□□□□□□Z□R	MillFeed insert	H053
WR602R/LW	Insert clamp	L028
WR603R/L	Insert clamp	L028
WRENCHCOOLTUBEHSK...	Wrench for HSK cooling tube	K135
WRENCHER...	Wrench for ER nut	K130
WRENCHER□□	Wrench for ER collet chuck	K037
WRENCHM□SEMC□□	Wrench for cutter arbor	K038, K134
WRENCHMAXIN□□HOOK	Wrench for power chuck holder	K041, K130
WT402R/L	Insert clamp	L028
WTJNR/L□□□□...	W-type external toolholder	C056
WWCW13T3AF□R-WS	TungMill insert	H076
WWCW13T3AFFR-WD	TungMill insert	H076
WWWU□□□□□□□□R-DJ	TungSix-Drill insert	J068, J086
WWWU□□□□□□□□R-DS	TungSix-Drill insert	J068, J086
WXGU □□□ R/L SS	MiniForce-Turn insert, 80° trigon, positive, double-sided	B162
WXGU □□□ R/L TS	MiniForce-Turn insert, 80° trigon, positive, double-sided	B162
WXGU □□□ R/L TSW	MiniForce-Turn insert, 80° trigon, positive, double-sided	B162
WXGU □□□MFR/L JS	MiniForce-Turn insert, 80° trigon, positive, double-sided	B161
WXGU □□□MFR/L JSS	MiniForce-Turn insert, 80° trigon, positive, double-sided	B162
WXGU □□□MFR/L JTS	MiniForce-Turn insert, 80° trigon, positive, double-sided	B161
WXGU □□□MR/L JSS	MiniForce-Turn insert, 80° trigon, positive, double-sided	B162
WXGU □□□MR/L JTS	MiniForce-Turn insert, 80° trigon, positive, double-sided	B161
WXHU0403□□R-MJ	DoMiniMill insert	H171
X		
X407	Cermet grade	A005
XCET310404ER	ECC insert	H218
XGR/L□□□□□-02	Grooving insert	F101, F164
XGR/L□□□□□S-QBN	CBN insert for grooving	B193, F102
XHG□090300-□□A	DrillMeister chamfering insert	J023
XHGX090700R-45A	Insert for TDxcf chamfering tool	J073, J083
XNR/L□□□□□-...	Face grooving insert	F206
XPMT□□□□□R-DG	TungDrill-Twisterd, TungDrillBig insert	J080, J090
XPMT□□□□□R-DJ	TungDrill-Twisterd, TungDrillBig insert	J079, J089
XPMT□□□□□R-DS	TungDrill-Twisterd, TungDrillBig insert	J079, J089
XPMT□□□□□R-DW	TungDrill-Twisterd, TungDrillBig insert	J080, J089
XVCT16□□□□□R-AJ	Tung-AluMill insert	H144
XWXPR/L□□□□□09	TurnFeed external toolholder	C104
XXMU□□□□□□PR-MJ	EVX insert	H217
Y		
YDEN0603PD□R-D	TungSpeed-Mill insert	H080
YDEN0603PDFR-BD	TungSpeed-Mill insert	H080
YDEN0603PDFR-WD	TungSpeed-Mill insert	H080
YDEN0905PDFR-BD	DPD09 / EDPD09 insert	H086
YDEN0905PDFR-D	DPD09 / EDPD09 insert	H086
YDEN0905PDFR-WD	DPD09 / EDPD09 insert	H086
YH170	PVD coated grade	A004
YH180	PVD coated grade	A004
YNMG □□□ ZF	25° rhombic, negative insert	B109
YNMG □□□ ZM	25° rhombic, negative insert	B109
YWMT□□-ZF	25° rhombic, positive insert	B163
YWMT□□-ZM	25° rhombic, positive insert	B163
Z		
ZDMT□□□□□-MJ	EBD insert	H186
ZFBM□□□□□R□□-MJ	BallFinishNose insert	H168
ZFBU□□□□□R□□-MJ	BallFinishNose insert	H168
ZFRM□□□□□R□□-MJ	BallFinishNose insert	H169
ZFRU□□□□□R□□-MJ	BallFinishNose insert	H169
ZPET□□□□□-MJ	EBP insert	H184
ZRBM□□□□□-MM	BallRoughNose insert	H165
ZRBU□□□□□-MM	BallRoughNose insert	H165
ZSA□□□02	Shim	L011

- 1 - 9
- A - C
- D - F
- G - I
- J - L
- M - O
- P - R
- S - U
- V - X
- Y - Z

Worldwide Network



**Head Office & Production
Facilities in Japan**

Tungaloy Corporation Head Office

11-1 Yoshima Kogyodanchi
Iwaki-city, Fukushima 970-1144 Japan
Phone: +81-246-36-8501
Fax: +81-246-36-8542
www.tungaloy.com

Iwaki Plant

Products: Cutting Tools

Nagoya Plant

Products: Cutting Tools

Kyushu Plant

Products: PCBN
PCD Tools
Deep Hole Drills

Nirasaki Plant

Products: Cutting Tools
Friction Materials (TungFric)
Wear Resistant Tools
Civil Engineering Tools



Sales Channels

Tungaloy America, Inc.

3726 N Ventura Drive
Arlington Heights,
IL 60004, U.S.A.
Phone: +1-888-554-8394
Fax: +1-888-554-8392
www.tungaloy.com/us

Tungaloy Canada

432 Elgin St. Unit 3, Brantford
Ontario N3S 7P7, Canada
Phone: +1-519-758-5779
Fax: +1-519-758-5791
www.tungaloy.com/ca

Tungaloy de Mexico S.A.

C Los Arellano 113,
Parque Industrial Siglo XXI
Aguascalientes, AGS,
Mexico 20290
Phone: +52-449-929-5410
Fax: +52-449-929-5411
www.tungaloy.com/mx

Tungaloy do Brasil Ltda.

Avd. Independencia N4158
Residencial Flora
13280-000 Vinhedo,
São Paulo, Brazil
Phone: +55-19-38262757
Fax: +55-19-38262757
www.tungaloy.com/br

Tungaloy Germany GmbH

An der Alten Ziegelei 1
D-40789 Monheim, Germany
Phone: +49-2173-90420-0
Fax: +49-2173-90420-19
www.tungaloy.com/de

Tungaloy France S.A.S.

ZA Courtaboeuf - Le Rio
1 rue de la Terre de feu
F-91952 Courtaboeuf Cedex, France
Phone: +33-1-6486-4300
Fax: +33-1-6907-7817
www.tungaloy.com/fr

Tungaloy Italia S.r.l.

Via E. Andolfato 10
I-20126 Milano, Italy
Phone: +39-02-252012-1
Fax: +39-02-252012-65
www.tungaloy.com/it

Tungaloy Czech s.r.o

Turanka 115
CZ-627 00 Brno, Czech Republic
Phone: +420-532 123 391
Fax: +420-532 123 392
www.tungaloy.com/cz

Tungaloy Ibérica S.L.

C/Miquel Servet, 43B, Nau 7
Pol. Ind. Bufalvent
ES-08243 Manresa (BCN), Spain
Phone: +34 93 113 1360
Fax: +34 93 876 2798
www.tungaloy.com/es

Tungaloy Scandinavia AB

Bultgatan 38, 442 40
Kungälv, Sweden
Phone: +46-462119200
Fax: +46-462119207
www.tungaloy.com/se

Tungaloy Rus, LLC

Andropova avenue, h.18/7,
11 floor, office 3, 115432,
Moscow, Russia
Phone: +7-499-683-01-80
Fax: +7-499-683-01-81
www.tungaloy.com/ru

Tungaloy Polska Sp. z o.o.

Ul. Irysowa 1, 55-040 Bielany
Wroclawskie, Poland
Phone: +48 607 907 237
www.tungaloy.com/pl

Tungaloy U.K. Ltd

Gallan Park, Watling Street,
Cannock, WS110XG, UK
Phone: +44 121 4000 231
Fax: +44 121 270 9694
www.tungaloy.com/uk



Tungaloy Hungay Kft

Erzsébet királyné útja 125
H-1142 Budapest, Hungary
Phone: +36 1 781-6846
Fax: +36 1 781-6866
www.tungaloy.com/hu

Tungaloy Turkey

Serifali Mah.bayraktar Bulvari Kule
Sk. No:26 34775 Umraniye Istanbul,
TURKEY
Phone: +90 216 540 04 67
Fax: +90 216 540 04 87
www.tungaloy.com/tr

Tungaloy Benelux b.v.

Tjalk 70
NL-2411 NZ Bodegraven, Netherlands
Phone: +31 172 630 420
Fax: +31 172 630 429
www.tungaloy.com/nl

Tungaloy Croatia

Ulica bana Josipa Jelačića 87,
10430, Samobor, Croatia
Phone: +385 1 3326 604
Fax: +385 1 3327 683
www.tungaloy.com/hr

Tungaloy Cutting Tool (Shanghai) Co.,Ltd.

Rm No 401 No.88 Zhabei
Jiangchang No.3 Rd
Shanghai 200436, China
Phone: +86-21-3632-1880
Fax: +86-21-3621-1918
www.tungaloy.com/cn

Tungaloy Cutting Tools (Thailand) Co.,Ltd.

Interlink tower 4th Fl.
1858/5-7 Bangna-Trad Road
km.5 Bangna, Bangna, Bangkok
10260 Thailand
Phone: +66-2-751-5711
Fax: +66-2-751-5715
www.tungaloy.com/th

Tungaloy Cutting Tools (Taiwan) Co.,Ltd.

9F. No.293, Zhongyang Rd,
Xinzhuang Dist, New Taipei City,
24251 Taiwan
Phone: +886-2-8521-9986
Fax: +886-2-8521-8935
www.tungaloy.com/tw

Tungaloy Singapore (Pte.), Ltd.

62 Ubi Road 1,
#06-11 Oxley BizHub 2
Singapore 408734
Phone: +65-6391-1833
Fax: +65-6299-4557
www.tungaloy.com/sg

Tungaloy Vietnam

LE04.38, Lexington Residence
67 Mai Chi Tho St., Dist. 2,
Ho Chi Minh City, Vietnam
Phone: +84-2837406660
www.tungaloy.com/sg

Tungaloy India Pvt. Ltd.

Indiabulls Finance Centre,
Unit # 902-A, 9th Floor,
Tower 1, Senapati Bapat Marg,
Elphinstone Road (West),
Mumbai -400013, India
Phone: +91-22-6124-8804
Fax: +91-22-6124-8899
www.tungaloy.com/in

Tungaloy Korea Co., Ltd

#1312, Byucksan Digital Valley 5-cha
Beotkkot-ro 244, Geumcheon-gu
153-788 Seoul, Korea
Phone: +82-2-2621-6161
Fax: +82-2-6393-8952
www.tungaloy.com/kr

Tungaloy Malaysia Sdn Bhd

50 K-2, Kelana Mall, Jalan
SS6/14 Kelana Jaya, 47301
Petaling Jaya, Selangor Darul Ehsan
Malaysia
Phone: +603-7805-3222
Fax: +603-7804-8563
www.tungaloy.com/my

Tungaloy Australia Pty Ltd

Unit 68 1470 Ferntree Gully Road
Knoxfield 3180 Victoria, Australia
Phone: +61-3-9755-8147
Fax: +61-3-9755-6070
www.tungaloy.com/au

PT. Tungaloy Indonesia

Kompleks Grand Wisata Block AA-10
No.3-5 Cibitung
Bekasi 17510, Indonesia
Phone: +62-21-8261-5808
Fax: +62-21-8261-5809
www.tungaloy.com/id

Official Distributor in South Africa - Star Tooling CC

P.O. Box 11316
Selcourt 1567
Springs, South Africa
Phone: +27 011 818-2259
Fax: +27 011 818-2250
www.startooling.co.za





Tungaloy Corporation (Head office)

11-1 Yoshima-Kogyodanchi
Iwaki-city, Fukushima, 970-1144 Japan
Phone: +81-246-36-8501 Fax: +81-246-36-8542
www.tungaloy.com

Tungaloy America, Inc.

3726 N Ventura Drive, Arlington Heights, IL 60004, U.S.A.
Phone: +1-888-554-8394 Fax: +1-888-554-8392
www.tungaloy.com/us

Tungaloy Canada

432 Elgin St. Unit 3, Brantford, Ontario N3S 7P7, Canada
Phone: +1-519-758-5779 Fax: +1-519-758-5791
www.tungaloy.com/ca

Tungaloy de Mexico S.A.

C Los Arellano 113, Parque Industrial Siglo XXI
Aguascalientes, AGS, Mexico 20290
Phone: +52-449-929-5410 Fax: +52-449-929-5411
www.tungaloy.com/mx

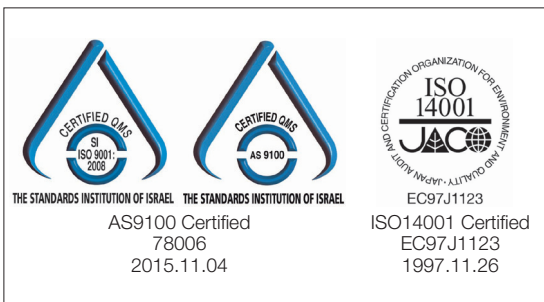

DISTRIBUTED BY: